



HCT CO., LTD.

74, Seoicheon-ro 578 beon-gil, Majang-myeon, Icheon-si, Gyeonggi-do, Korea 467-811

TEL: +82 31 645 6300 FAX: +82 31 645 6401 www.hct.co.kr

HAC RF Emission TEST REPORT

Pantech Co., Ltd.
Pantech Building, I-2, DMC,
Sangam-dong, Mapo-gu, Seoul, Korea
(ZIP : 121-792)

Date of Issue: Aug. 05, 2013
Test Report No.: HCTA1307FM01
Test Site: HCT CO., LTD.

FCC ID: JYCP2050

APPLICANT: Pantech Co., Ltd.

Application Type : Certification
EUT Type : GSM/WCDMA Phone with Bluetooth
Tx Frequency : 824.20 - 848.80 MHz (GSM850)
: 1 850.20 -1 909.80 MHz (GSM1900)
: 826.4 - 846.6 MHz (WCDMA850)
: 1 852.4 - 1 907.6 MHz (WCDMA1900)
Trade Name/Model(s) : Pantech /P2050
FCC Classification : Licensed Portable Transmitter Held to Ear (PCE)
FCC Rule Part(s) : §20.19
HAC Standard : ANSI C63.19-2011

Hearing Aid Near-Field Category: M4

This wireless portable device has been shown to be hearing-aid compatible under the above rated category, specified in ANSI/IEEE Std. C63.19-2011 and had been tested in accordance with the specified measurement procedures. Hearing-Aid Compatibility is based on the assumption that all production units will be designed electrically identical to the device tested in this report.

I attest to the accuracy of data. All measurements reported herein were performed by me or were made under my supervision and are correct to the best of my knowledge and belief. I assume full responsibility for the completeness of these measurements and vouch for the qualifications of all persons taking them.

HCT Co., Ltd. Certifies that no party to this application has been denied FCC benefits pursuant to section 5301 of the Anti- Drug Abuse Act of 1998, 21 U.S. C. 862.

Report prepared by

: Young-Soo Jang

Test Engineer of SAR Part

Approved by

: Jae-Sang So

Manager of SAR Part

Version

Rev	DATE	DESCRIPTION
	Jul. 03, 2013	First Approval Report
1	Jul. 23, 2013	Page 4 was revised
2	Aug. 05, 2013	Page 12 was revised

Table of Contents

1. APPLICANT / EUT DESCRIPTION	3
2. HAC MEASUREMENT SET- UP	5
3. SYSTEM SPECIFICATIONS	6
4. EUT ARRANGEMENT	8
5. SYSTEM VALIDATION	9
6. Modulation interference factor	11
7. RF Conducted Power Measurements	13
8. TEST PROCEDURE	14
9. ANSI/IEEE C63.19 PERFORMANCE CATEGORIES	16
10. MEASUREMENT UNCERTAINTIES	17
11. HAC TEST DATA SUMMARY	18
12. HAC TEST EQUIPMENT LIST	20
13. CONCLUSION	21
Appendix A_HAC TEST PLOTS	
Appendix B_TEST SET-UP PHOTO	
Appendix C_DIPOLE VALIDATION PLOTS	
Appendix D_PROBE CALIBRATION DATA	
Appendix E_DIPOLE CALIBRATION DATA	

HAC MEASUREMENT REPORT

1. APPLICANT / EUT DESCRIPTION

1.1 Applicant

- Company Name: Pantech Co., Ltd.
- Attention: Pantech Building, I-2, DMC,
Sangam-dong, Mapo-gu, Seoul, Korea (ZIP : 121-792)
- Tel. / Fax : +82-2-2030-1363 / +82-2-2030-2519

1.2 EUT Description

- EUT Type: GSM/WCDMA Phone with Bluetooth
- Trade Name: Pantech
- Model(s): P2050
- FCC ID: JYCP2050
- Serial Number(s): #1
- Tx Frequency: 824.20 - 848.80 MHz (GSM850), 1 850.20 - 1 909.80 MHz (GSM1900)
826.4 - 846.6 MHz (WCDMA850), 1 852.4 - 1 907.6 MHz (WCDMA1900)
- FCC Classification: Licensed Portable Transmitter Held to Ear (PCE)
- FCC Rule Part(s): § 20.19(b); §6.3(v), §7.3(v)
- Modulation(s): GSM850, GSM1900, WCDMA850, WCDMA1900
- Antenna Type: Integral Antenna
- Date(s) of Tests: Jun. 26, 2013
- Place of Tests: HCT CO., LTD.
Icheon, Kyong ki-Do, KOREA
- Report Serial No.: HCTA1307FM01
- Max E-Field Emission: GSM1900 810ch, 1909.8 MHz = 29.91 dBV/m (M4)

Air-Interface	Band (MHz)	Type	HAC Tested	Simultaneous Transmissions Note: Not to be tested	concurrent HAC Tested or not Tested	Reduced Power 20.19(C)(1)	Voice over Digital Transport OTT Capability	WiFi Low Power
GSM	850	VO	Yes	Yes: BT	Not tested ¹	N/A	N/A	N/A
	1900							
	GPRS	DT	N/A	Yes: BT	N/A	N/A	Yes	N/A
WCDMA	850	VO	Yes	Yes: BT	Not tested ¹	N/A	N/A	N/A
	1900	VO						
	HSPA	DT	N/A	Yes: BT	N/A	N/A	Yes	N/A
BT	2450	DT	NO	Yes: GSM or WCDMA	N/A	N/A	N/A	N/A

Type Transport

VO=Voice Only

DT= Digital Data-Not intended for CMRS Service

1. Non-concurrent mode was found to be the Worst Case mode

2. HAC MEASUREMENT SET-UP

These measurements are performed using the DASY5 automated dosimetric assessment system. It is made by Schmid & Partner Engineering AG (SPEAG) in Zurich, Switzerland. It consists of high precision robotics system (Staubli), robot controller, Pentium IV computer, near-field probe, probe alignment sensor. The robot is a six-axis industrial robot performing precise movements.

A cell controller system contains the power supply, robot controller, teach pendant (Joystick), and remote control, is used to drive the robot motors. The PC consists of the HP Pentium IV 3.0 GHz computer with Windows XP system and HAC Measurement Software DASY5, A/D interface card, monitor, mouse, and keyboard. The Staubli Robot is connected to the cell controller to allow software manipulation of the robot. A data acquisition electronic (DAE) circuit performs the signal amplification, signal multiplexing, AD-conversion, offset measurements, mechanical surface detection, collision detection, etc. is connected to the Electro-optical coupler (EOC). The EOC performs the conversion from the optical into digital electric signal of the DAE and transfers data to the PC plug-in card.

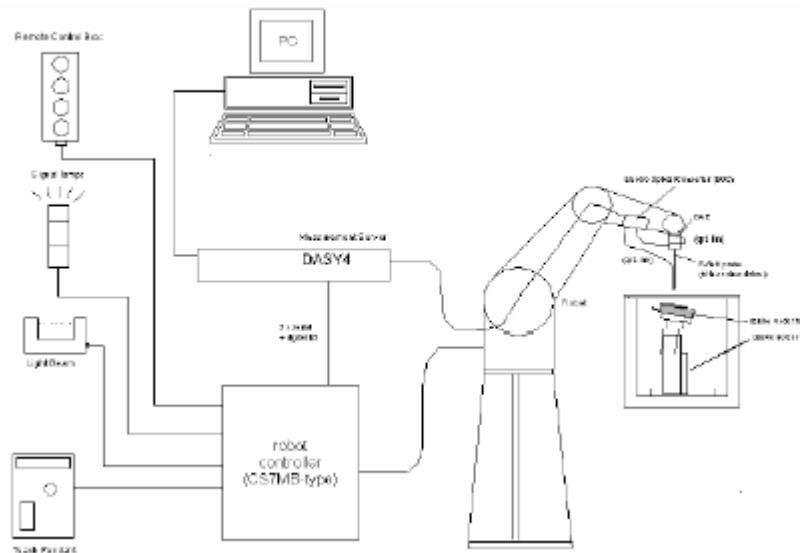



Figure 1. HAC Test Measurement Set-up

The DAE4 consists of a highly sensitive electrometer-grade preamplifier with auto-zeroing, a channel and gain-switching multiplexer, a fast 16 bit AD-converter and a command decoder and control logic unit. Transmission to the PC-card is accomplished through an optical downlink for data and status information and an optical uplink for commands and clock lines. The mechanical probe mounting device includes two different sensor systems for frontal and sidewise probe contacts. They are also used for mechanical surface detection and probe collision detection. The robot uses its own controller with a built in VME-bus computer.

3. SYSTEM SPECIFICATIONS

3.1 Probe

3.1.1 E-Field Probe Description

Construction	One dipole parallel, two dipoles normal to probe axis Built-in shielding against static charges	 <p>[E-Field Probe]</p>
Calibration	In air from 100 MHz to 3.0 GHz (absolute accuracy $\pm 6.0\%$, $k = 2$)	
Frequency	100 MHz to > 6 GHz; Linearity: ± 0.2 dB (100 MHz to 3 GHz)	
Directivity	± 0.2 dB in air (rotation around probe axis) ± 0.4 dB in air (rotation normal to probe axis)	
Dynamic Range	2 V/m to > 1000 V/m (M3 or better device readings fall well below diode compression point)	
Linearity	± 0.2 dB	
Dimensions	Overall length: 330 mm (Tip: 16 mm) Tip diameter: 8 mm (Body: 12 mm) Distance from probe tip to dipole centers: 2.5 mm	

3.2 Phantom & Device Holder

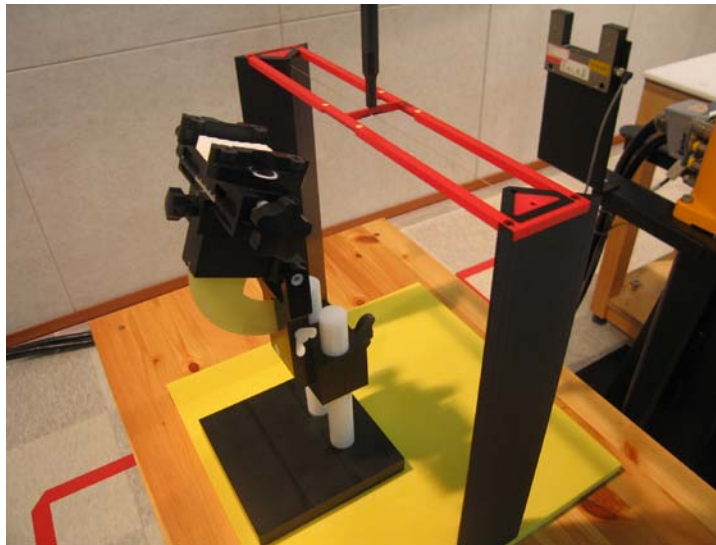

Figure 2. HAC Phantom & Device Holder

The Test Arch phantom should be positioned horizontally on a stable surface. Reference markings on the Phantom allow the complete setup of all predefined phantom positions and measurement grids by manually teaching three points in the robot.

The devices can be easily, accurately, and repeatably positioned according to the FCC specifications.

3.3 Robotic System Specifications

Specifications	
POSITIONER:	Stäubli Unimation Corp. Robot Model: RX90LB
Repeatability:	0.02 mm
No. of axis:	6
Data Acquisition Electronic (DAE) System	
Cell Controller	
Processor:	Core i7
Clock Speed:	3.0 GHz
Operating System:	Windows 7
Data Card:	DASY5 PC-Board
Data Converter	
Features:	Signal Amplifier, multiplexer, A/D converter, and control logic
Software:	DASY5 software
Connecting Lines:	Optical downlink for data and status info. Optical uplink for commands and clock
PC Interface Card	
Function:	24 bit (64 MHz) DSP for real time processing Link to DAE 16 bit A/D converter for surface detection system serial link to robot direct emergency stop output for robot

4. EUT ARRANGEMENT

4.1 WD RF Emission Measurements Reference and Plane

Figure 3. Illustrate the references and reference plane that shall be used in the WD emissions measurement.

- The grid is 5 cm by 5 cm area that is divided into 9 evenly sized blocks or sub-grids.
- The grid is centered on the audio frequency output transducer of the WD (speaker or T-coil).
- The grid is in a reference plane, which is defined as the planar area that contains the highest point in the area of the phone that normally rests against the user's ear. It is parallel to the centerline of the receiver area of the phone and is defined by the points of the receiver-end of the WD handset, which, in normal handset use, rest against the ear.
- The measurement plane is parallel to, and 1.5 cm in front of, the reference plane.



Figure 3. WD reference and plane for RF emission measurements

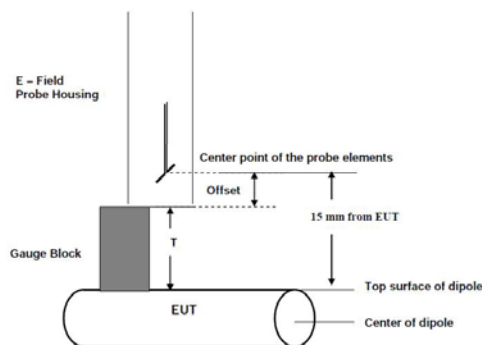

Figure 4. Gauge Block with E-Field Probe

5. SYSTEM VALIDATION

The test setup was validated when configured and verified periodically thereafter to ensure proper function. The procedure is a validation procedure using dipole antennas for which the field levels were computed by FDTD modeling.

5.1 Validation Procedure

Place a dipole antenna meeting the requirements given in ANSI-C63.19 in the position normally occupied by the WD. The dipole antenna serves as a known source for an electrical and magnetic output. Position the E-field probe so that:

- the probes and their cables are parallel to the coaxial feed of the dipole antenna
- the probe cables and the coaxial feed of the dipole antenna approach the measurement area from opposite directions; and
- the probes are 15 mm from the surface of the dipole elements.

Scan the length of the dipole with E-field probe and record the maximum values for each. Compare the readings to expected values.

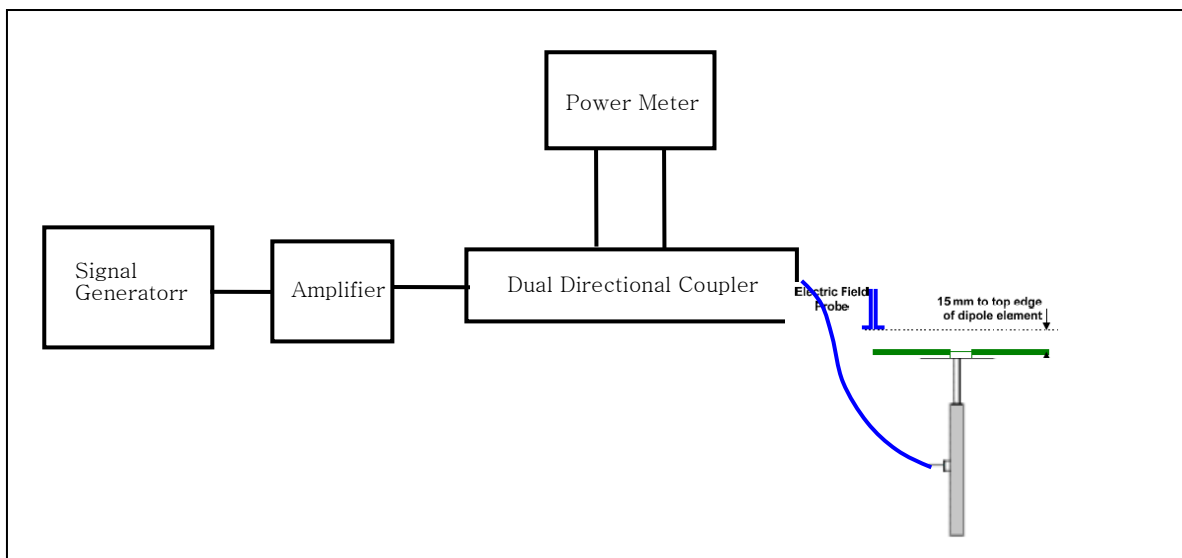

Figure 6. Dipole Validation SET-UP

5.2 Validation Result

5.2.1 E-Field Scan

Mode	Freq. [MHz]	Input Power [dBm]	Measured Value [V/m]	Target Value [V/m] SPEAG	Deviation [%]
CW	835	20	105.86	105.75	+ 0.10
CW	1 880	20	91.41	91.25	+ 0.18

Notes:

- 1) Deviation (%) = 100 * (Measured value minus Target value) divided by Target value.
ANSI-C63.19 requires values to be within 25 % of their targets. 12 % is deviation and 13 % is measurement uncertainty.
- 2) The maximum E-field was evaluated and compared to the target values provided by SPEAG in the calibration certificate of specific dipoles.
- 3) Please refer to the attachment for detailed measurement data and plot.

6. Modulation interference factor

For any specific fixed and repeatable modulated signal, a modulation interference factor (MIF, expressed in dB) may be developed that relates its interference potential to its steady-state rms signal level or average power level. This factor is a function only of the audio-frequency amplitude modulation characteristics of the signal and is the same for field-strength and conducted power measurements. It is important to emphasize that the MIF is valid only for a specific repeatable audio-frequency amplitude modulation characteristic. Any change in modulation characteristic requires determination and application of a new MIF.

6.1 Modulation Interference Factor

6.1.1 E-Field

Mode	Freq. [MHz]	Channel	MIF
GSM850	835	128	3.630
		190	3.630
		251	3.630
GSM1900	1 880	512	3.630
		661	3.630
		810	3.630

Mode	Freq. [MHz]	Channel	MIF
WCDMA850	835	4132	- 27.23
		4183	- 27.23
		4233	- 27.23
WCDMA1900	1 880	9262	- 27.23
		9400	- 27.23
		9538	- 27.23

Note : MIF values are provided by the manufacturer(SPEAG).

We used the MIF file with UID number(10021-CAA, 10011-CAA).

6.2.1. Analysis of RF Air interface Technologies

1. An analysis was performed, following the guidance of 4.3 and 4.4 of the ANSI standard, of the RF air interface technologies being evaluated. The factors that will affect the RF interference Potential were evaluated, and the worst case operating modes were identified and used in the evaluation. A WD's interference potential is a function both of the WD's average near-field field strength and of the signal's audio-frequency amplitude modulation characteristics. Per 4.4, RF air interface technologies that have low power have been found to produce sufficiently low RF interference potential, so it is possible to exempt them from the product testing specified in Clause 5 of the ANSI standard. An RF air interface technology of a device is exempt from testing When its average antenna input power plus its MIF is $\leq 17\text{dBm}$ for all of its operating modes.

The worst case MIF plus the worst case average antenna input power for all modes are investigated below to determine the testing requirements for this device.

6.2.2. Analysis of RF Air interface Technologies

Air Interface	Maximum Average Power (dBm)	Worst Case MIF (dB)	Total (Power + MIF, dB)	C63.19 Testing Required
GSM	33.26	3.630	36.89	Yes
UMTS-RMC	23.32	- 27.23	- 3.91	No
UMTS-AMR	23.56	- 27.23	- 3.67	No

Table 1. Max. Power + MIF calculations for Low Power Exemptions

6.2.3. Low-Power Exemption Conclusions

Per ANSI C63.19-2011, RF Emissions testing for this device is required only for GSM voice modes. All other applicable air interfaces are exempt.

7. RF Conducted Power Measurements

Sample pre-testing of the various modes were performed at the worst case probe location as part of subset testing justification. See below for measured conducted power for applicable device modes:

7.1 Handset Measured Conducted Powers

Band	Channel	GSM	GPRS(GMSK) Data – CS1		EDGE(8PSK) Data – MCS7	
		Voice (dBm)	GPRS 1 TX Slot (dBm)	GPRS 2 TX Slot (dBm)	EDGE 1 TX Slot (dBm)	EDGE 2 TX Slot (dBm)
GSM 850	128	33.21	33.22	33.20	26.99	26.98
	190	33.26	33.26	33.23	27.03	27.01
	251	32.99	33.00	32.96	27.01	27.00
GSM 1900	512	30.50	30.52	30.49	26.03	26.01
	661	30.55	30.56	30.53	26.07	26.06
	810	30.50	30.52	30.49	26.13	26.09

Table 2. Maximum average GSM Conducted output powers (**Burst-Average**)

3GPP Release Version	Mode	3GPP 34.121 Subtest	Cellular Band [dBm]			MPR Target
			UL 4132 DL 4357	UL 4183 DL 4408	UL 4233 DL 4458	
99	WCDMA	12.2 kbps RMC	23.32	23.28	23.25	-
99	WCDMA	12.2 kbps AMR	23.31	23.28	23.21	-
3GPP Release Version	Mode	3GPP 34.121 Subtest	PCS Band [dBm]			MPR Target
			UL 9262 DL 9662	UL 9400 DL 9800	UL 9538 DL 9938	
99	WCDMA	12.2 kbps RMC	23.54	23.56	23.25	-
99	WCDMA	12.2 kbps AMR	23.54	23.56	23.13	-

Table 3. Maximum average WCDMA Conducted output powers

8. TEST PROCEDURE

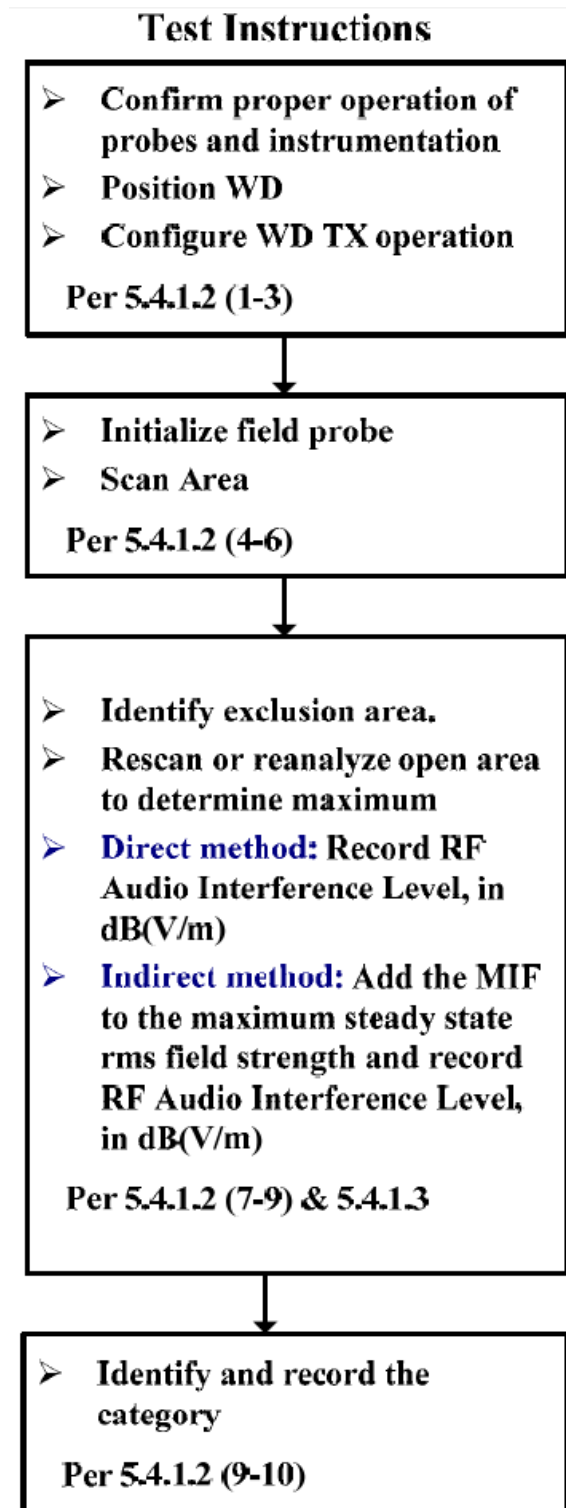

Figure 9. WD near-field emission automated test flowchart

The evaluation was performed with the following procedure:

1. Confirm proper operation of the field probe, probe measurement system and other instrumentation and the positioning system.
2. Position the WD in its intended test position. The measurement should be performed at a distance 1.5 cm from the probe elements so the gauge block can simplify this positioning.
3. Configure the WD normal operation for maximum rated RF output power, at the desired channel and other operating parameters, as intended for the test.
4. The center sub-grid shall be centered on the center of the WD output (acoustic or T-Coil output), as appropriate.
5. A Surface calibration was performed before each setup change to ensure repeatable spacing and proper maintenance of the measurement plane using the HAC Phantom.
6. Locate the field probe at reference location and measure the field strength.
7. Scan the entire 5 cm by 5 cm region at 5 mm increments and record the reading at each measurement point.
8. Identify the maximum field reading within the non-excluded sub-grids identified in Step 7.
9. Move the probe to the location of maximum scan measurement and then 360° rotating the probe to align it for the maximum reading at that position.
10. Locate the field probe at the reference location and measure the field strength for drift evaluation. If conducted power deviations of more than 5 % occurred, the tests were repeated.
11. Convert the maximum field strength reading identified in Step 8 to V/m or A/m, as appropriate. For probes which require a probe modulation factor, this conversion shall be done using the appropriate probe modulation.
12. Repeat Step 1 through Step 11 for both the E field measurements.

9. ANSI/IEEE C63.19 PERFORMANCE CATEGORIES

The EUT must meet the following M3 or M4 category:

Category	Telephone RF Parameters
Near Field Category	E-Field Emissions CW dB [V/m]
Frequency < 960 MHz	
M1	50 to 55
M2	45 to 50
M3	40 to 45
M4	< 40
Frequency > 960 MHz	
M1	40 to 45
M2	35 to 40
M3	30 to 35
M4	< 30

Table 4. Telephone near-field categories in linear units

10. MEASUREMENT UNCERTAINTIES

10.1 E-Field

HAC (E-Field) Uncertainty Budget [According to ANSI C63.19]										Note/ Comment
Error Description	Uncertainty [%]	Probability Distribution	Divisor	ci [E]	Standard Uncertainty [E]	Stand Uncert*2	(Stand Uncert*2) X (ci*2)	Vi & Veff		
Measurement system										
1	Probe Calibration	5.1 %	Normal	1.00	1	5.1 %	26.01	26.01	∞	
2	Axial Isotropy	4.7 %	Rectangular	1.73	1	2.7 %	7.36	7.36	∞	
3	Sensor Displacement	16.5 %	Rectangular	1.73	1	9.5 %	90.75	90.75	∞	
4	Boundary effect	2.4 %	Rectangular	1.73	1	1.4 %	1.92	1.92	∞	
5	Linearity	4.7 %	Rectangular	1.73	1	2.7 %	7.36	7.36	∞	
6	Scaling to peak Envelope Power	2.0 %	Rectangular	1.73	1	1.2 %	1.33	1.33	∞	
7	System Detection limits	1.0 %	Rectangular	1.73	1	0.6 %	0.33	0.33	∞	
8	Readout Electronics	0.3 %	Normal	1.00	1	0.3 %	0.09	0.09	∞	
9	Response time	0.8 %	Rectangular	1.73	1	0.5 %	0.21	0.21	∞	
10	Integration time	2.6 %	Rectangular	1.73	1	1.5 %	2.25	2.25	∞	
11	RF Ambient Conditions	3.0 %	Rectangular	1.73	1	1.7 %	3.00	3.00	∞	
12	RF Reflections	1.2 %	Rectangular	1.73	1	0.7 %	0.50	0.50	∞	
13	Probe positioner	1.2 %	Rectangular	1.73	1	0.7 %	0.48	0.48	∞	
14	Probe positioning	4.7 %	Rectangular	1.73	1	2.7 %	7.36	7.36	∞	
15	Extrap. And Interpolation	1.0 %	Rectangular	1.73	1	0.6 %	0.33	0.33	∞	
Test Sample Related										
16	Device Positioning Vertical	4.7 %	Rectangular	1.73	1	2.7 %	7.36	7.36	∞	
17	Device Positioning Lateral	1.0 %	Rectangular	1.73	1	0.6 %	0.33	0.33	∞	
18	Device Holder and Phantom	2.4 %	Rectangular	1.73	1	1.4 %	1.92	1.92	∞	
19	Test Sample	0.4 %	Normal	1.00	1	0.4 %	0.16	0.16	g	0.17 dB
20	Power drift	3.0 %	Rectangular	1.73	1	1.7 %	3.00	3.00	∞	
PMF Calculations										
21	Power Sensor	1.0 %	Rectangular	1.73	1	0.6 %	0.32	0.32	∞	
22	Dual Directional Coupler	1.0 %	Rectangular	1.73	1	0.6 %	0.32	0.32	∞	
Phantom and Setup Related										
23	Phantom Thickness	2.4 %	Rectangular	1.73	1	1.4 %	1.92	1.92	∞	
Combined standard Uncertainty [%]						12.8 %		164.64		0.523 dB
Expanded standard Uncertainty [k = 2 , Confidence 95 %]						25.7 %				0.993 dB

Table 5. Uncertainties (E-Field)

Notes:

1. Worst-Case uncertainty budget for HAC free field assessment according to ANSI-C 63.19[1].The budget is valid for the frequency range 800 MHz-3 GHz and represents a worst-Case analysis. For specific test sand configurations, the uncertainty could be considerably smaller. Some of the parameters are dependent on the user situations and need adjustment according to the actual laboratory conditions.

2. * Uncertainty specifications from Schmidt & Partner Engineering AG (not site specific)

11. HAC TEST DATA SUMMARY

11. 1 E-Field Measurement Results (GSM850 / GSM1900)

 Ambient TEMPERATURE (°C): 21.5

 S/N: #1

Mode	Ch.	Back light	Battery	Antenna	Conducted Power [dBm]	Time Avg. Field [V/m]	Peak Field [dBV/m]	FCC Limit [dBV/m]	FCC MARGIN [dB]	MIF	RESULT	Exclusion Block
GSM850	128	off	Standard	Intenna	33.21	62.78	39.59	45	-5.41	3.630	M4	none
GSM850	190	off	Standard	Intenna	33.26	58.88	39.03	45	-5.97	3.630	M4	none
GSM850	251	off	Standard	Intenna	32.99	47.25	37.12	45	-7.88	3.630	M4	none
GSM1900	512	off	Standard	Intenna	30.50	18.12	28.79	35	-6.21	3.630	M4	none
GSM1900	661	off	Standard	Intenna	30.55	20.07	29.68	35	-5.32	3.630	M4	none
GSM1900	810	off	Standard	Intenna	30.50	20.61	29.91	35	-5.09	3.630	M4	none

NOTES:

- All modes of operation were investigated and the worst-case are reported.
- Battery Type Standard Extended Fixed
- Power Measured Conducted EIRP ERP
- Test Signal Call Mode Manual Test cord Base Station Simulator
- SAR Measurement System SPEAG

11.2 Worst-case Configuration Evaluation

Ambient TEMPERATURE (°C): 21.5

S/N: #1

Peak Reading 360° Probe Rotation at Azimuth axis

Mode	Ch.	Back light	Battery	Antenna	Conducted Power [dBm]	Time Avg. Field [V/m]	Peak Field [dBV/m]	FCC Limit [dBV/m]	FCC MARGIN [dB]	MIF	RESULT	Exclusion Block
GSM1900	810	off	Standard	Intenna	30.50	20.63	29.92	35	-5.08	3.630	M4	none

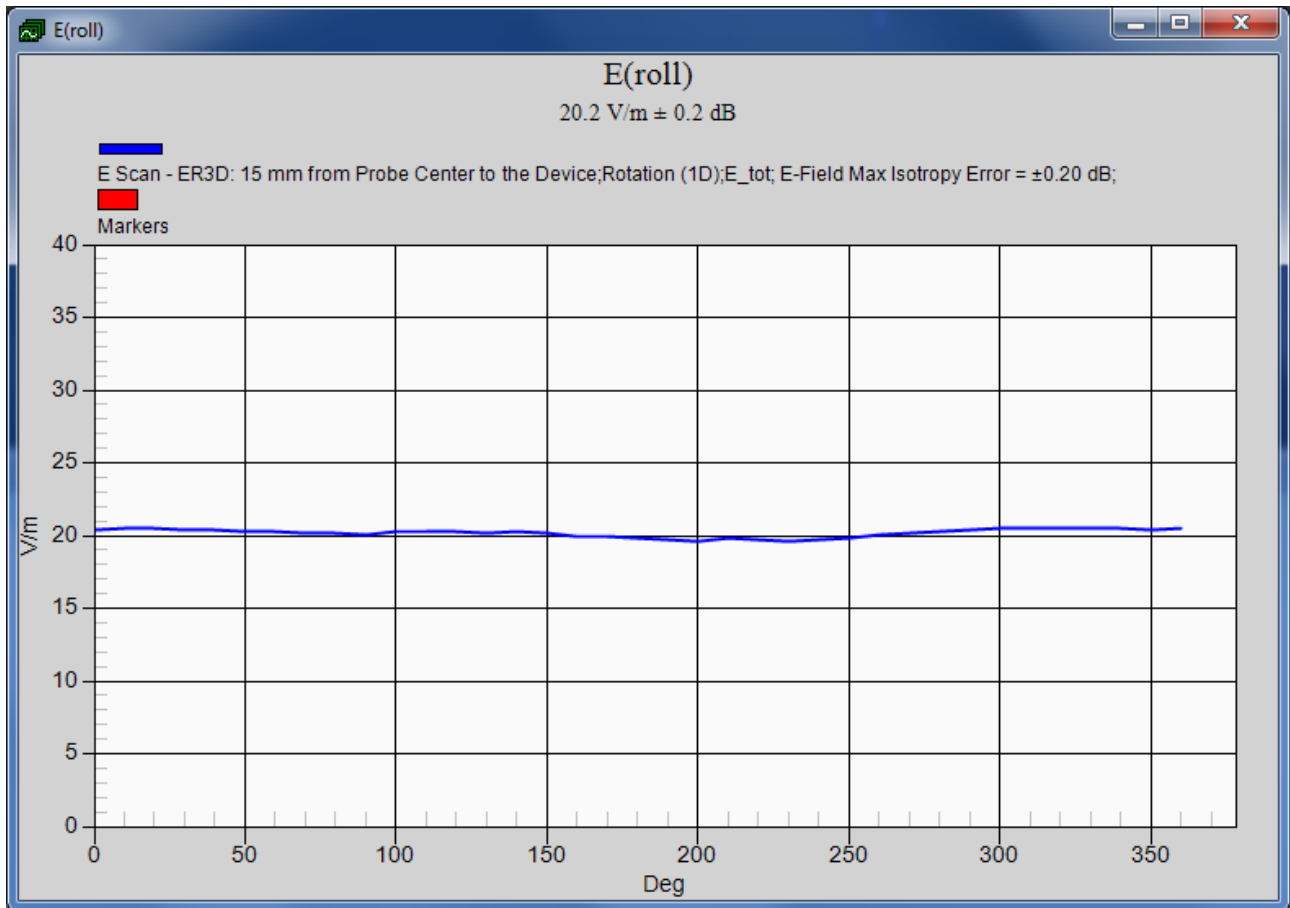

Worst-Case Probe Rotation about Azimuth axis

12. HAC TEST EQUIPMENT LIST

Manufacturer	Type / Model	S/N	Calib. Date	Calib. Interval	Calib. Due
Staubli	Robot TX90 XLspeag	F11/5K3RA1/A/01	N/A	N/A	N/A
Staubli	Robot Controller	F11/5K3RA1/C/01	N/A	N/A	N/A
Staubli	Teach Pendant (Joystick)	S-1203 0309	N/A	N/A	N/A
HP	Pavilion t000_puffer	KRJ51201TV	N/A	N/A	N/A
SPEAG	SPEAG HAC Phantom	-	N/A	N/A	N/A
SPEAG	Light Alignment Sensor	265	N/A	N/A	N/A
SPEAG	DAE4	869	Sep. 18, 2012	Annual	Sep. 18, 2013
SPEAG	E-Field Probe	2343	Mar. 15, 2013	Annual	Mar. 15, 2014
SPEAG	Validation Dipole CD835V2	1024	Mar. 15, 2013	Annual	Mar. 15, 2014
SPEAG	Validation Dipole CD1880V2	1019	Mar. 15, 2013	Annual	Mar. 15, 2014
Agilent	Power Meter(F) E4419B	MY41291386	Nov. 02, 2012	Annual	Nov. 02, 2013
Agilent	Power Sensor(G) 8481	MY41090870	Nov. 02, 2012	Annual	Nov. 02, 2013
HP	Signal Generator 8664A	3744A02069	Nov. 02, 2012	Annual	Nov. 02, 2013
Agilent	Base Station CMU200	110740	Jul. 23, 2012	Annual	Jul. 23, 2013
Agilent	Base Station E5515C	GB44400269	Feb. 14, 2013	Annual	Feb. 14, 2014

NOTE:

The probe was calibrated by SPEAG, by the waveguide technique procedure. Dipole Validation measurement is performed by HCT Lab. before each test.

13. CONCLUSION

The HAC measurement indicates that the EUT complies with the HAC limits of the ANSI-C63.19-2011.

These measurements are taken to simulate the RF effects exposure under worst-case conditions. Precise Laboratory measures were taken to assure repeatability of the tests.