

# HCT CO., LTD.



SAN 136-1, AMI-RI, BUBAL-EUP, ICHEON-SI, KYOUNGKI-DO, 467-701, KOREA  
TEL: +82 31 639 8565 FAX: +82 31 639 8525 [www.hct.co.kr](http://www.hct.co.kr)

## HAC RF Emission TEST REPORT

### Pantech Co., Ltd.

Pantech Building, I-2, DMC,  
Sangam-dong, Mapo-gu, Seoul, Korea  
(ZIP : 121-792)

Date of Issue: Mar. 4, 2011

Test Report No.: HCTA1103FM02

Test Site: HCT CO., LTD.

### FCC ID: JYCP2030

### APPLICANT: Pantech Co., Ltd.

Application Type:	Certification
EUT Type:	Quad-band GSM/WCDMA Phone with BT
Tx Frequency:	824.20 - 848.80 MHz (GSM850) 1 850.20 -1 909.80 MHz (GSM1900) 826.4 - 846.6 MHz (WCDMA850) 1 852.4 - 1 907.6 MHz (WCDMA1900)
Maximum Conducted	2.0 W GSM850 (33 dBm), 1 W GSM1900 (30 dBm)
Power (HAC):	0.200 W WCDMA850 (23.0 dBm), 0.200 W WCDMA1900 (23.0 dBm)
Trade Name/Model(s):	PANTECH / P2030
FCC Classification:	Licensed Portable Transmitter Held to Ear (PCE)
FCC Rule Part(s):	§20.19
HAC Standard:	ANSI C63.19-2007

### Hearing Aid Near-Field Category: M4

This wireless portable device has been shown to be hearing-aid compatible under the above rated category, specified in ANSI/IEEE Std. C63.19-2007 and had been tested in accordance with the specified measurement procedures. Hearing-Aid Compatibility is based on the assumption that all production units will be designed electrically identical to the device tested in this report.

I attest to the accuracy of data. All measurements reported herein were performed by me or were made under my supervision and are correct to the best of my knowledge and belief. I assume full responsibility for the completeness of these measurements and vouch for the qualifications of all persons taking them.

HCT Co., Ltd. Certifies that no party to this application has been denied FCC benefits pursuant to section 5301 of the Anti- Drug Abuse Act of 1998, 21 U.S. C. 862.

Report prepared by  
: Young-Soo Jang  
Test Engineer of SAR Part

Approved by  
: Jae-Sang So  
Manager of SAR Part

## Table of Contents

---

1. APPLICANT / EUT DESCRIPTION .....	3
2. HAC MEASUREMENT SET- UP .....	4
3. SYSTEM SPECIFICATIONS .....	5
4. EUT ARRANGEMENT .....	7
5. SYSTEM VALIDATION .....	8
6. PROBE MODULATION FACTOR .....	10
7. FCC 3G MEASUREMENTS – MAY / JUNE 2006 .....	15
8. TEST PROCEDURE .....	17
9. ANSI/IEEE C63.19 PERFORMANCE CATEGORIES .....	19
10. MEASUREMENT UNCERTAINTIES .....	20
11. HAC TEST DATA SUMMARY .....	22
12. HAC TEST EQUIPMENT LIST .....	27
13. CONCLUSION .....	28

Appendix A\_HAC TEST PLOTS

Appendix B\_TEST SET-UP PHOTO

Appendix C\_DIPOLE VALIDATION PLOTS

Appendix D\_PROBE CALIBRATION DATA

Appendix E\_DIPOLE CALIBRATION DATA

# HAC MEASUREMENT REPORT

## 1. APPLICANT / EUT DESCRIPTION

### 1.1 Applicant

• Company Name:	Pantech Co., Ltd.
• Attention:	Pantech Building, I-2, DMC, Sangam-dong, Mapo-gu, Seoul, Korea (ZIP : 121-792)
• Tel. / Fax :	+82-2-2030-1363 / +82-2-2030-2519

### 1.2 EUT Description

• EUT Type:	Quad-band GSM/WCDMA Phone with BT
• Trade Name:	Pantech
• Model(s):	P 2030
• FCC ID:	JYCP2030
• Serial Number(s):	#1
• Tx Frequency:	824.20 - 848.80 MHz (GSM850), 1 850.20 -1 909.80 MHz (GSM1900) 826.4 - 846.6 MHz (WCDMA850), 852.4 - 1 907.6 MHz (WCDMA1900)
• FCC Classification:	Licensed Portable Transmitter Held to Ear (PCE)
• FCC Rule Part(s):	§ 20.19(b); §6.3(v), §7.3(v)
• Modulation(s):	GSM850, GSM1900, WCDMA850, WCDMA1900
• Antenna Type:	Intenna
• Date(s) of Tests:	Feb.25, 2011
• Place of Tests:	HCT CO., LTD. Icheon, Kyoung ki-Do, KOREA
• Report Serial No.:	HCTA1103FM02
• Max E-Field Emission:	GSM1900 661ch, 1 880.0 MHz = 32.8 dBV/m (M4) WCDMA1900 9538ch, 1 907.6 MHz = 23.6 dBV/m (M4)
• Max H-Field Emission:	GSM1900 810ch, 1909.8 MHz = -18.0 dBA/m (M4) WCDMA1900 9538ch, 1 907.6 MHz = -25.5 dBA/m (M4)

Air-Interface	Band (MHz)	Type	C63.19-2007	Simultaneous Transmissions Note: Not to be tested	Reduced Power 20.19(C)(1)	Voice Over Digital Transport(Data)
GSM	850	VO	Yes	Yes: BT	No	NA
	1900					NA
	GPRS/EDGE	DT	NA	NA	NA	Yes
WCDMA	850	VO	Yes	YES: BT	No	NA
	1900	VO				NA
	HSDPA	DT	NA	NA	NA	Yes
BT	2400	DT	NA	Yes: GSM, WCDMA	NA	NA

VO Voice CMRS/PSTN Service Only  
V/D Voice CMRS /PSTN and Data Service  
DT Digital Transport

\* HAC Rating was not based on concurrent voice and data modes,  
Non current mode was found to represent worst case rating.  
for both M and T rating

## 2. HAC MEASUREMENT SET-UP

These measurements are performed using the DASY4 automated dosimetric assessment system. It is made by Schmid & Partner Engineering AG (SPEAG) in Zurich, Switzerland. It consists of high precision robotics system (Staubli), robot controller, Pentium IV computer, near-field probe, probe alignment sensor. The robot is a six-axis industrial robot performing precise movements.

A cell controller system contains the power supply, robot controller, teach pendant (Joystick), and remote control, is used to drive the robot motors. The PC consists of the HP Pentium IV 3.0 GHz computer with Windows XP system and HAC Measurement Software DASY4, A/D interface card, monitor, mouse, and keyboard. The Staubli Robot is connected to the cell controller to allow software manipulation of the robot. A data acquisition electronic (DAE) circuit performs the signal amplification, signal multiplexing, AD-conversion, offset measurements, mechanical surface detection, collision detection, etc. is connected to the Electro-optical coupler (EOC). The EOC performs the conversion from the optical into digital electric signal of the DAE and transfers data to the PC plug-in card.

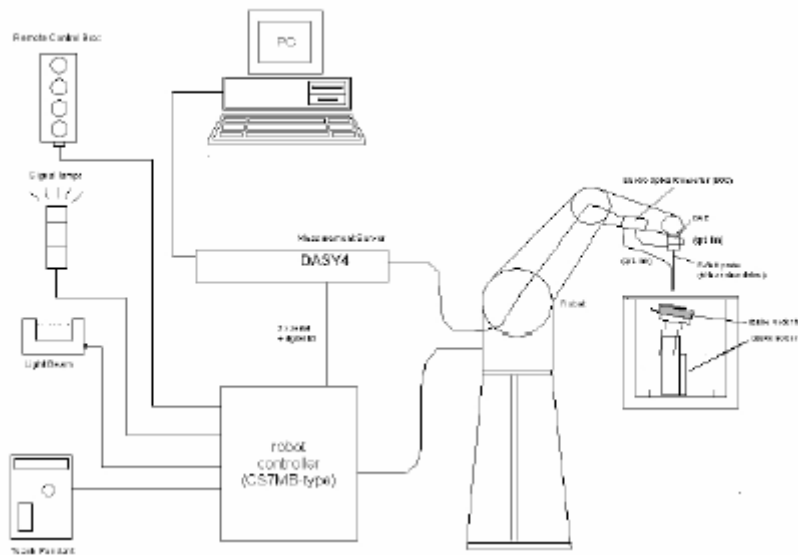



Figure 1. HAC Test Measurement Set-up

The DAE4 consists of a highly sensitive electrometer-grade preamplifier with auto-zeroing, a channel and gain-switching multiplexer, a fast 16 bit AD-converter and a command decoder and control logic unit. Transmission to the PC-card is accomplished through an optical downlink for data and status information and an optical uplink for commands and clock lines. The mechanical probe mounting device includes two different sensor systems for frontal and sidewise probe contacts. They are also used for mechanical surface detection and probe collision detection. The robot uses its own controller with a built in VME-bus computer.

### 3. SYSTEM SPECIFICATIONS

#### 3.1 Probe

##### 3.1.1 E-Field Probe Description

Construction	One dipole parallel, two dipoles normal to probe axis Built-in shielding against static charges	 <p>[ E-Field Probe ]</p>
Calibration	In air from 100 MHz to 3.0 GHz (absolute accuracy $\pm 6.0\%$ , $k = 2$ )	
Frequency	100 MHz to > 6 GHz; Linearity: $\pm 0.2$ dB (100 MHz to 3 GHz)	
Directivity	$\pm 0.2$ dB in air (rotation around probe axis) $\pm 0.4$ dB in air (rotation normal to probe axis)	
Dynamic Range	2 V/m to > 1000 V/m (M3 or better device readings fall well below diode compression point)	
Linearity	$\pm 0.2$ dB	
Dimensions	Overall length: 330 mm (Tip: 16 mm) Tip diameter: 8 mm (Body: 12 mm) Distance from probe tip to dipole centers: 2.5 mm	

##### 3.1.2 H-Field Probe Description

Construction	Three concentric loop sensors with 3.8 mm loop diameters resistively loaded detector diodes for linear response Built-in shielding against static charges PEEK enclosure material (resistant to organic solvents, e.g., glycoether)	 <p>[ H-Field Probe ]</p>
Frequency	200 MHz to > 3 GHz (absolute accuracy $\pm 6.0\%$ , $k = 2$ ); Output linearized	
Directivity	$\pm 0.25$ dB (spherical isotropy error)	
Dynamic Range	10 mA/m to 2 A/m at 1 GHz	
E-Field Interference	< 10 % at 3 GHz (for plane wave)	
Dimensions	Overall length: 330 mm (Tip: 40 mm) Tip diameter: 6 mm (Body: 12 mm) Distance from probe tip to dipole centers: 3 mm The closest part of the sensor element is 1.9 mm closer to the tip	

### 3.2 Phantom & Device Holder



Figure 2. HAC Phantom & Device Holder

The Test Arch phantom should be positioned horizontally on a stable surface. Reference markings on the Phantom allow the complete setup of all predefined phantom positions and measurement grids by manually teaching three points in the robot.

The devices can be easily, accurately, and repeatable positioned according to the FCC specifications.

### 3.3 Robotic System Specifications

<b>Specifications</b>	
<b>POSITIONER:</b>	Stäubli Unimation Corp. Robot Model: RX90LB
<b>Repeatability:</b>	0.02 mm
<b>No. of axis:</b>	6
<b>Data Acquisition Electronic (DAE) System</b>	
<b>Cell Controller</b>	
<b>Processor:</b>	Pentium IV
<b>Clock Speed:</b>	3.0 GHz
<b>Operating System:</b>	Windows XP
<b>Data Card:</b>	DASY4 PC-Board
<b>Data Converter</b>	
<b>Features:</b>	Signal Amplifier, multiplexer, A/D converter, and control logic
<b>Software:</b>	DASY4 software
<b>Connecting Lines:</b>	Optical downlink for data and status info. Optical uplink for commands and clock
<b>PC Interface Card</b>	
<b>Function:</b>	24 bit (64 MHz) DSP for real time processing Link to DAE 16 bit A/D converter for surface detection system serial link to robot direct emergency stop output for robot

## 4. EUT ARRANGEMENT

### 4.1 WD RF Emission Measurements Reference and Plane

Figure 3. Illustrate the references and reference plane that shall be used in the WD emissions measurement.

- The grid is 5 cm by 5 cm area that is divided into 9 evenly sized blocks or sub-grids.
- The grid is centered on the audio frequency output transducer of the WD (speaker or T-coil).
- The grid is in a reference plane, which is defined as the planar area that contains the highest point in the area of the phone that normally rests against the user's ear. It is parallel to the centerline of the receiver area of the phone and is defined by the points of the receiver-end of the WD handset, which, in normal handset use, rest against the ear.
- The measurement plane is parallel to, and 1.5 cm in front of, the reference plane.



Figure 3. WD reference and plane for RF emission measurements

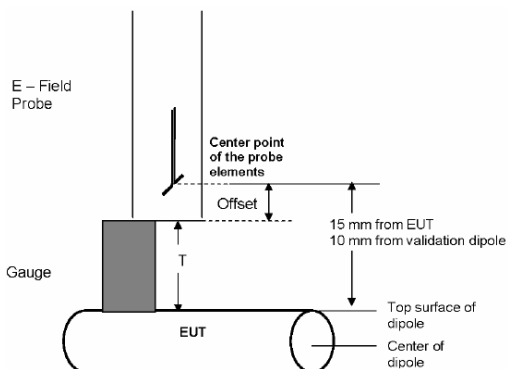

Figure 4. Gauge Block with E-Field Probe

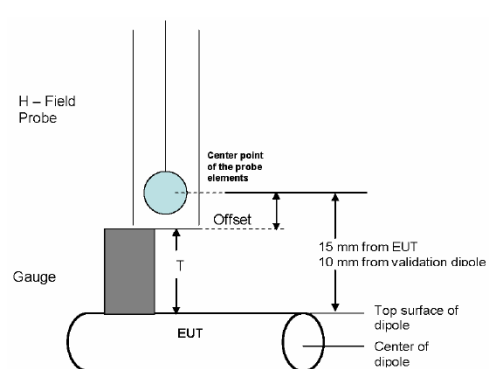

Figure 5. Gauge Block with H-Field Probe

## 5. SYSTEM VALIDATION

The test setup was validated when configured and verified periodically thereafter to ensure proper function. The procedure is a validation procedure using dipole antennas for which the field levels were computed by FDTD modeling.

### 5.1 Validation Procedure

Place a dipole antenna meeting the requirements given in ANSI-C63.19 in the position normally occupied by the WD. The dipole antenna serves as a known source for an electrical and magnetic output. Position the E-field and H-field probes so that:

- the probes and their cables are parallel to the coaxial feed of the dipole antenna
- the probe cables and the coaxial feed of the dipole antenna approach the measurement area from opposite directions; and
- the probes are 10 mm from the surface of the dipole elements.

Scan the length of the dipole with both E-field and H-field probes and record the maximum values for each. Compare the readings to expected values.

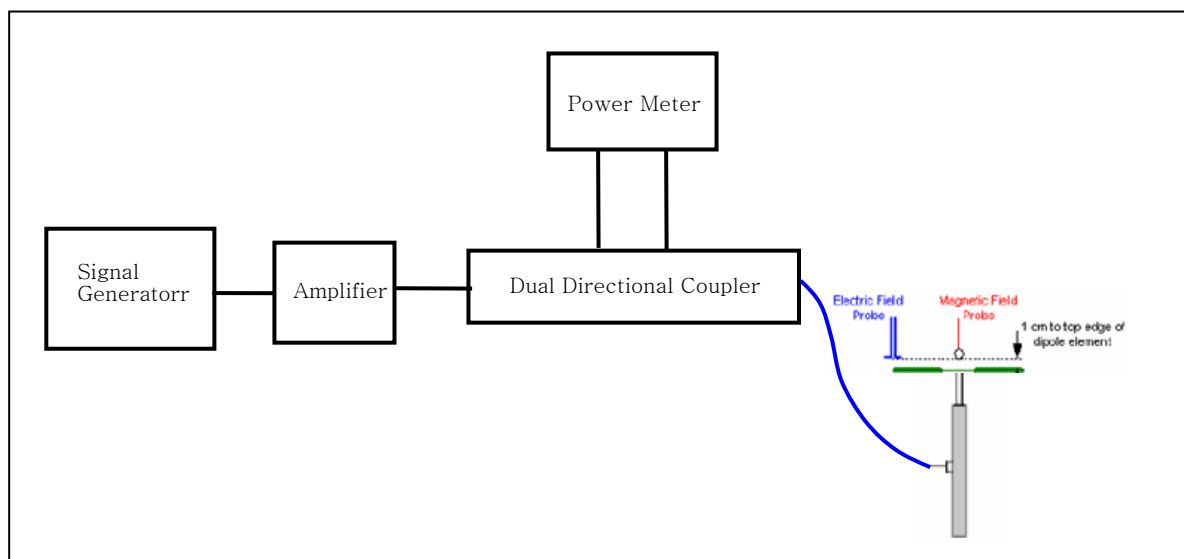

Figure 6. Dipole Validation SET-UP



## 5.2 Validation Result

### 5.2.1 E-Field Scan

Mode	Freq. [MHz]	Input Power [dBm]	Measured Value [V/m]	Target Value [V/m] SPEAG	Deviation [%]	Limit [%]
CW	835	20	163.1	161.3	+ 1.12	± 25
CW	1 880	20	139.95	139.5	+ 0.32	± 25

### 5.2.2 H-Field Scan

Mode	Freq. [MHz]	Input Power [dBm]	Measured Value [A/m]	Target Value [A/m] SPEAG	Deviation [%]	Limit [%]
CW	835	20	0.451	0.464	- 2.80	± 25
CW	1 880	20	0.471	0.472	- 0.21	± 25

**Notes:**

- 1) Deviation (%) = 100 \* (Measured value minus Target value) divided by Target value.  
ANSI-C63.19 requires values to be within 25 % of their targets. 12 % is deviation and 13 % is measurement uncertainty.
- 2) The maximum E-field or H-field were evaluated and compared to the target values provided by SPEAG in the calibration certificate of specific dipoles.
- 3) Please refer to the attachment for detailed measurement data and plot.

## 6. Probe Modulation Factor

A calibration was made of the modulation response of the probe and its instrumentation chain. This calibration was performed with the field probe, attached to its instrumentation. The response of the probe system to a CW field at the frequency of interest is compared to its response to a modulated signal with equal peak amplitude to that of a CW signal. The field level of the test signals are ensured to be more than 10 dB above the ambient level and the noise floor of the instrumentation being used. The ratio of the CW reading to that taken with a modulated reading was applied to the DUT measurements.

All voice modes for this device have been investigated in this section of the report. According to the FCC 3G Measurement Procedures, May 2006 for RF Emissions, variations in peak field and power readings.

### This was done using the following procedure:

1. The probe was illuminated with a CW signal at the intended measurement frequency and wireless device power.
2. The probe was positioned at the field maxima over the dipole antenna (determined after an area scan over the dipole) illuminated with the CW signal.
3. The reading of the probe measurement system of the CW signal at the maximum point was recorded.
4. Using a Spectrum Analyzer, the modulated signal adjusted with the same peak level of the CW signal was determined.
5. The probe measurement system reading was recorded with the modulated signal. The appropriate system crest factors for the modulation type were configured in the software to the system measurements.
6. The ratio of the CW reading to modulated signal reading is the probe modulation factor (PMF) for the modulation and field probe combination. This was repeated for 80 % AM.
7. Steps 1-6 were repeated at all frequency bands and for both E and H field probes.

The modulation factors obtained were applied to readings taken of the actual wireless device, in order to obtain an accurate peak field reading using the formula:

$$\text{Peak} = 20 \cdot \log (\text{Raw} \cdot \text{PMF})$$

This method correlates well with the modulation using the DUT in the alternative substitution method.

See below for correlation of signal:

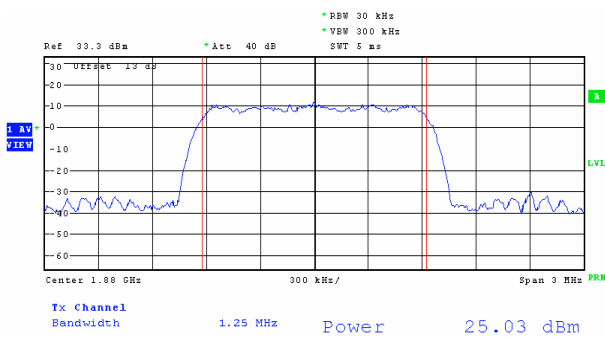

Figure. 7

Signal Generator Modulated Signal

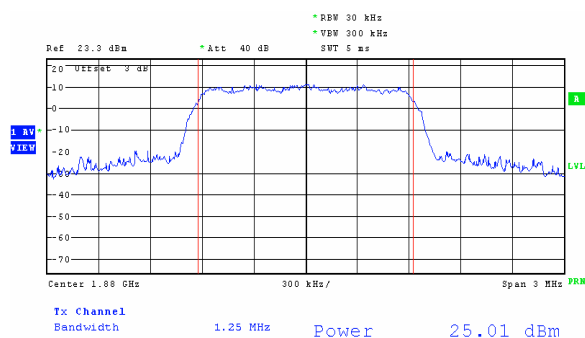

Figure. 8

Wireless Device Modulated Signal

## 6.2 Modulation Factor

### 6.2.1 E-Field (GSM)

Mode	Freq. [MHz]	Input Power [dB]	E-Field measured value [V/m]	Probe Modulation Factor
CW	835	33	745	-
80 % AM		33	531.4	1.402
GSM		33	274.7	2.712
CW	1 880	30	419	-
80 % AM		30	369.7	1.133
GSM		30	160.5	2.611

### 6.2.2 H-Field (GSM)

Mode	Freq. [MHz]	Input Power [dB]	E-Field measured value [A/m]	Probe Modulation Factor
CW	835	33	2.154	-
80 % AM		33	1.72	1.252
GSM		33	1.015	2.122
CW	1 880	30	1.47	-
80 % AM		30	1.287	1.142
GSM		30	0.648	2.269

Notes:

- 1) Modulation Factor = CW / WD\_GSM

### 6.2.3 E-Field (WCDMA)

Mode	Freq. [MHz]	Input Power [dB]	E-Field measured value [V/m]	Probe Modulation Factor
CW	835	23	236.8	-
80 % AM		23	156.9	1.509
WCDMA		23	303.2	0.781
CW	1 880	23	205.9	-
80 % AM		23	128.7	1.600
WCDMA		23	246.8	0.834

### 6.2.4 H-Field (WCDMA)

Mode	Freq. [MHz]	Input Power [dB]	E-Field measured value [A/m]	Probe Modulation Factor
CW	835	23	0.721	-
80 % AM		23	0.486	1.484
WCDMA		23	0.857	0.841
CW	1 880	23	0.692	-
80 % AM		23	0.487	1.421
WCDMA		23	0.829	0.835

Notes:

Modulation Factor =CW / WD\_WCDMA

## 6.2.5 PMF Peak Power Measurement Plots

### ■ Probe Modulation Factor (CW)

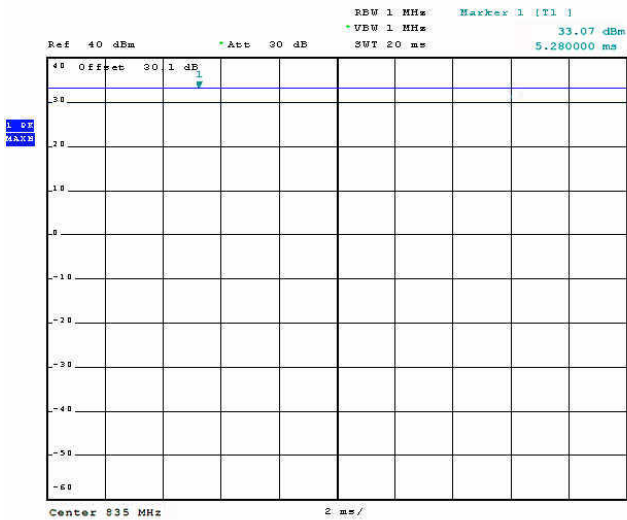

### ■ Probe Modulation Factor (AM 80 %)

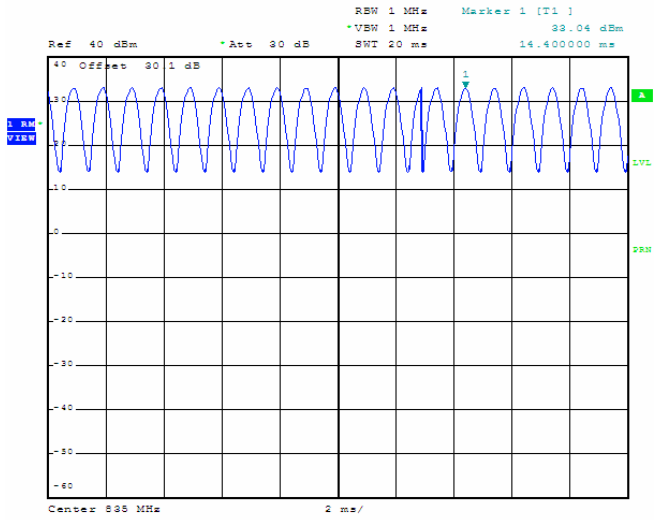

### ■ Probe Modulation Factor (GSM)

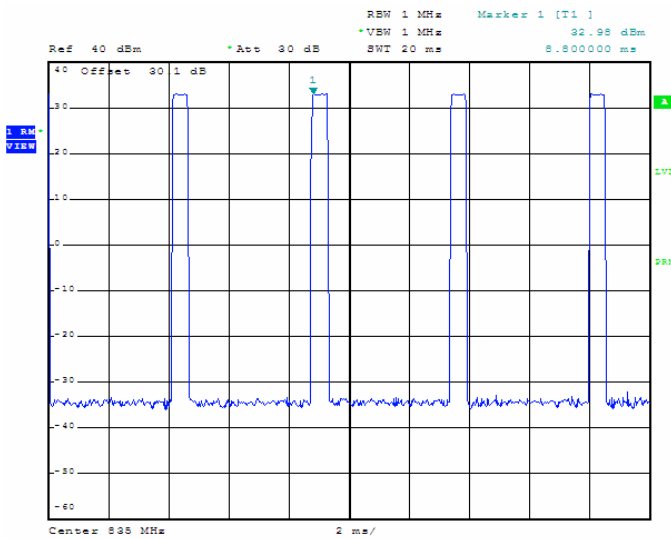

### Spectrum Analyzer Settings

- Input Power: 33.0 dBm, 30.0 dBm
- RBW: 1 MHz
- Video Bandwidth: 1 MHz
- Span: Zero
- Sweep Time: 20 ms
- Detection: Peak detection (RMS)

■ **Probe Modulation Factor (CW)**

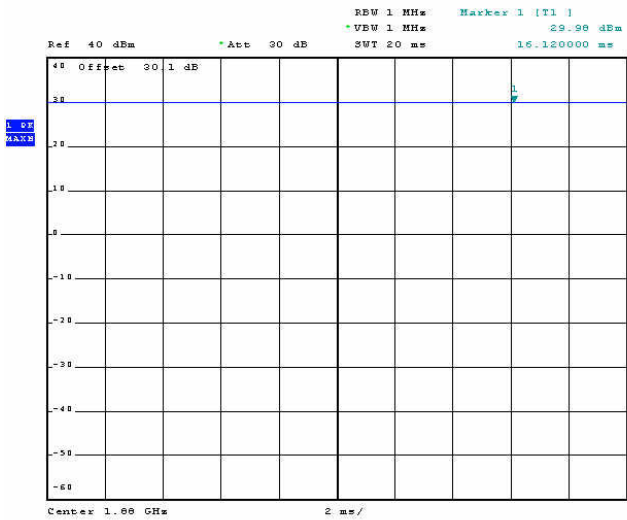

■ **Probe Modulation Factor (AM 80 %)**

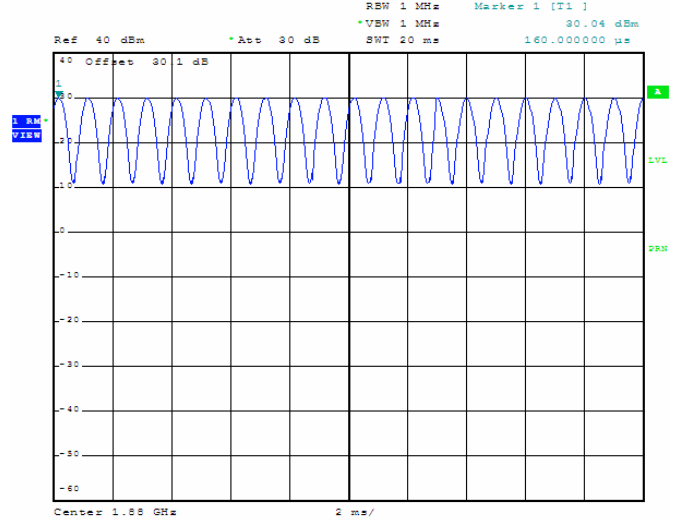

■ **Probe Modulation Factor (GSM)**

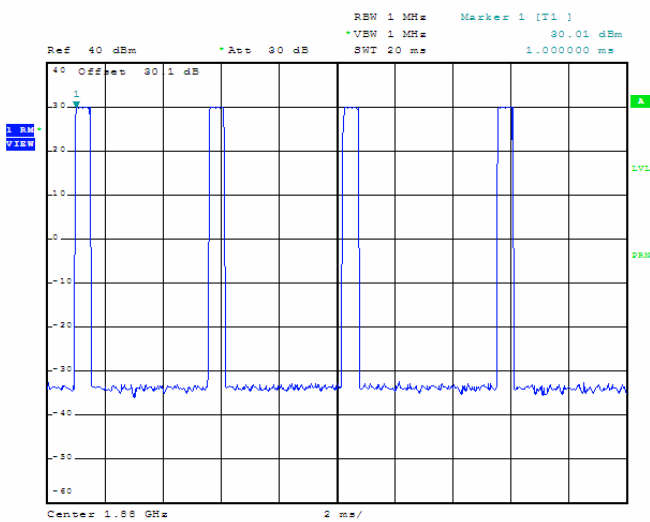

**Spectrum Analyzer Settings**

- Input Power: 33.0 dBm, 30.0 dBm
- RBW: 1 MHz
- Video Bandwidth: 1 MHz
- Span: Zero
- Sweep Time: 20 ms
- Detection: Peak detection (RMS)

## 7. FCC 3G MEASUREMENTS – MAY / JUNE 2006

Power measurements were performed using a base station simulator under digital average power.

### 7.1 Procedures Used to Establish RF Signal for HAC Testing

The handset was placed into a simulated call using a base station simulator in a shielded chamber.

Such test signals offer a consistent means for testing HAC and are recommended for evaluating HAC.

Measurements were taken with a fully charged battery. In order to verify that the device was tested and maintained at full power, this was configured with the base station simulator. The HAC measurement software calculates a reference point at the start and end of the test to check for power drifts. If conducted power deviations of more than 5 % occurred, the tests were repeated.

### 7.1 HAC Measurement Conditions for UMTS

#### Output Power Verification

Maximum output power is verified on the High, Middle and Low channel according to the general description in section 5.2 of 3GPP TS 34.121, using the appropriate RMC or AMR with TPC(transmit power control) set to all "1s".

#### HAC Measurements

HAC is measured using the 12.2 kbps RMC with TPC bits configured to all "1s". HAC in AMR configurations is not required when the maximum average output of each RF channel for 12.2 kbps AMR is less than 1/4 dB higher than that measured in 12.2 kbps RMC. Otherwise, HAC is measured on the maximum output channel in AMR with a 3.4kbps SRB (signaling radio bearer) using the configuration that results in the highest HAC for that RF channel in 12.2 RMC.

**Average Output Power Measurement for FCC ID: JYCP2030**

Band	Channel	Voice	GPRS Data		EDGE Data	
		GSM (dBm)	GPRS 1 TX Slot (dBm)	GPRS 2 TX Slot (dBm)	EDGE 1 TX Slot (dBm)	EDGE 2 TX Slot (dBm)
GSM 850	128	32.59	32.59	32.56	27.23	27.23
	190	32.60	32.60	32.58	27.24	27.24
	251	32.60	32.60	32.59	27.24	27.24
GSM 1900	512	29.61	29.61	29.59	26.24	26.24
	661	29.62	29.62	29.61	26.26	26.26
	810	29.60	29.60	29.59	26.21	26.21

Table 1. GSM Conducted output powers

3GPP Release Version	Mode	3GPP 34.121	Cellular Band [dBm]			PCS Band [dBm]			MPR
		Subtest	UL 4132 (826.4)	UL 4183 (836.6)	UL 4233 (846.6)	UL 9262 (1852.4)	UL 9400 (1880.0)	UL 9538 (1907.6)	
99	WCDMA	12.2kbps(RMC)	22.84	22.83	22.77	22.74	22.75	22.80	-
5	HSDPA	Subtest1	22.54	22.53	22.49	22.55	22.44	22.62	0
5		Subtest2	22.87	22.80	22.71	22.88	22.68	22.84	0
5		Subtest3	21.90	21.82	21.80	21.82	21.77	21.87	0.5
5		Subtest4	21.02	20.93	20.87	20.83	20.66	20.66	0.5

Table 2. WCDMA Conducted output powers



## 8. TEST PROCEDURE

### Test Instructions

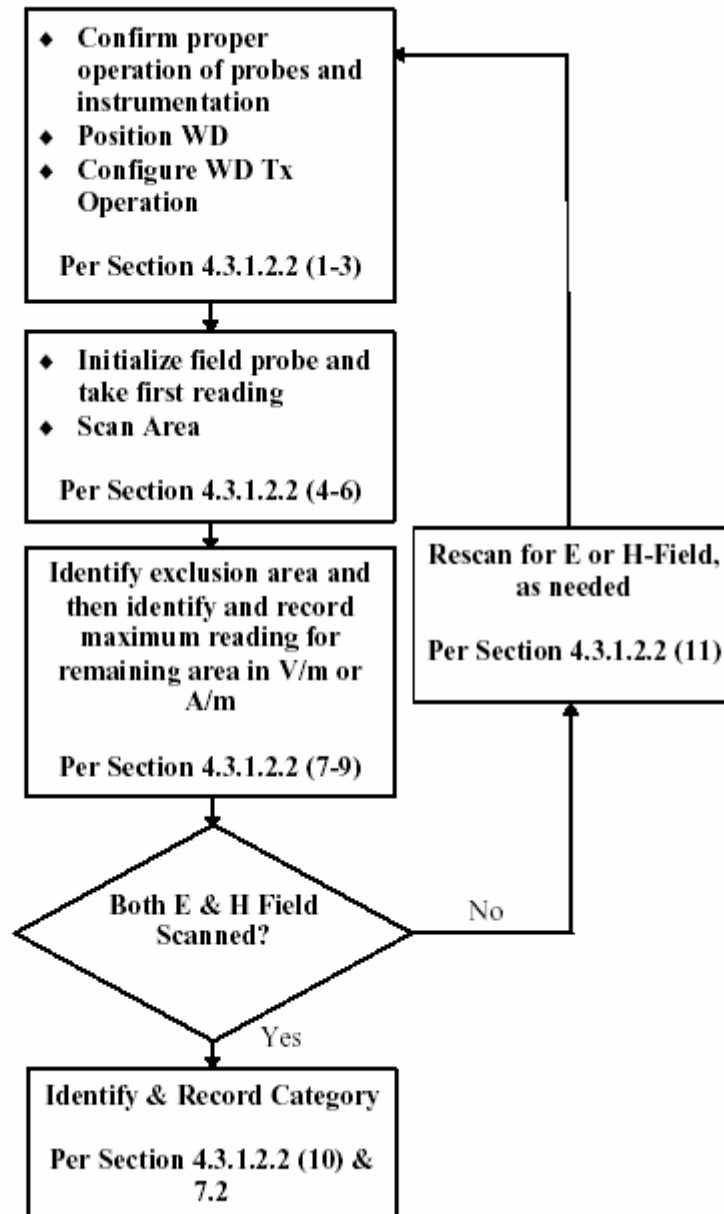

Figure 9. WD near-field emission automated test flowchart

**The evaluation was performed with the following procedure:**

1. Confirm proper operation of the field probe, probe measurement system and other instrumentation and the positioning system.
2. Position the WD in its intended test position. The measurement should be performed at a distance 1.5 cm from the probe elements so the gauge block can simplify this positioning.
3. Configure the WD normal operation for maximum rated RF output power, at the desired channel and other operating parameters, as intended for the test.
4. The center sub-grid shall be centered on the center of the WD output (acoustic or T-Coil output), as appropriate.
5. A Surface calibration was performed before each setup change to ensure repeatable spacing and proper maintenance of the measurement plane using the HAC Phantom.
6. Locate the field probe at reference location and measure the field strength.
7. Scan the entire 5 cm by 5 cm region at 5 mm increments and record the reading at each measurement point.
8. Identify the maximum field reading within the non-excluded sub-grids identified in Step 7.
9. Move the probe to the location of maximum scan measurement and then 360° rotating the probe to align it for the maximum reading at that position.
10. Locate the field probe at the reference location and measure the field strength for drift evaluation. If conducted power deviations of more than 5 % occurred, the tests were repeated.
11. Convert the maximum field strength reading identified in Step 8 to V/m or A/m, as appropriate. For probes which require a probe modulation factor, this conversion shall be done using the appropriate probe modulation.
12. Repeat Step 1 through Step 11 for both the E and H field measurements.

## 9. ANSI/IEEE C63.19 PERFORMANCE CATEGORIES

The EUT must meet the following M3 or M4 category:

Category	Telephone RF Parameters		
Near Field	AWF [dB]	E-Field Emissions dB [V/m]	H-Field Emissions dB [A/m]
Frequency < 960 MHz			
M1	0	56 to 61	+ 5.6 to + 10.6
	-5	53.5 to 58.5	+ 3.1 to + 8.1
M2	0	51 to 56	+ 0.6 to + 5.6
	-5	48.5 to 53.5	- 1.9 to + 3.1
M3	0	46 to 51	- 4.4 to + 0.6
	-5	43.5 to 48.5	- 6.9 to - 1.9
M4	0	< 46	< - 4.4
	-5	< 43.5	< - 6.9
Frequency > 960 MHz			
M1	0	46 to 51	- 4.4 to 0.6
	-5	43.5 to 48.5	- 6.9 to -1.9
M2	0	41 to 46	- 9.4 to - 4.4
	-5	38.5 to 43.5	-11.9 to - 6.9
M3	0	36 to 41	- 14.4 to - 9.4
	-5	33.5 to 38.5	- 16.9 to -11.9
M4	0	< 36	< - 14.4
	-5	< 33.5	< - 16.9

**Table 1. Telephone near-field categories in linear units**

## 10. MEASUREMENT UNCERTAINTIES

### 10.1 E-Field

HAC (E-Field) Uncertainty Budget [According to ANSI C63.19]										Note/ Comment
Error Description	Uncertainty [%]	Probability Distribution	Divisor	ci [E]	Standard Uncertainty [E]	Stand Uncert*2	(Stand Uncert*2) X (ci*2)	Vi & Veff		
<b>Measurement system</b>										
1	Probe Calibration	5.1 %	Normal	1.00	1	5.1 %	26.01	26.01	∞	
2	Axial Isotropy	4.7 %	Rectangular	1.73	1	2.7 %	7.36	7.36	∞	
3	Sensor Displacement	16.5 %	Rectangular	1.73	1	9.5 %	90.75	90.75	∞	
4	Boundary effect	2.4 %	Rectangular	1.73	1	1.4 %	1.92	1.92	∞	
5	Linearity	4.7 %	Rectangular	1.73	1	2.7 %	7.36	7.36	∞	
6	Scaling to peak Envelope Power	2.0 %	Rectangular	1.73	1	1.2 %	1.33	1.33	∞	
7	System Detection limits	1.0 %	Rectangular	1.73	1	0.6 %	0.33	0.33	∞	
8	Readout Electronics	0.3 %	Normal	1.00	1	0.3 %	0.09	0.09	∞	
9	Response time	0.8 %	Rectangular	1.73	1	0.5 %	0.21	0.21	∞	
10	Integration time	2.6 %	Rectangular	1.73	1	1.5 %	2.25	2.25	∞	
11	RF Ambient Conditions	3.0 %	Rectangular	1.73	1	1.7 %	3.00	3.00	∞	
12	RF Reflections	1.2 %	Rectangular	1.73	1	0.7 %	0.50	0.50	∞	
13	Probe positioner	1.2 %	Rectangular	1.73	1	0.7 %	0.48	0.48	∞	
14	Probe positioning	4.7 %	Rectangular	1.73	1	2.7 %	7.36	7.36	∞	
15	Extrap. And Interpolation	1.0 %	Rectangular	1.73	1	0.6 %	0.33	0.33	∞	
<b>Test Sample Related</b>										
16	Device Positioning Vertical	4.7 %	Rectangular	1.73	1	2.7 %	7.36	7.36	∞	
17	Device Positioning Lateral	1.0 %	Rectangular	1.73	1	0.6 %	0.33	0.33	∞	
18	Device Holder and Phantom	2.4 %	Rectangular	1.73	1	1.4 %	1.92	1.92	∞	
19	Test Sample	0.4 %	Normal	1.00	1	0.4 %	0.16	0.16	9	0.17 dB
20	Power drift	3.0 %	Rectangular	1.73	1	1.7 %	3.00	3.00	∞	
<b>PMF Calculations</b>										
21	Power Sensor	1.0 %	Rectangular	1.73	1	0.6 %	0.32	0.32	∞	
22	Dual Directional Coupler	1.0 %	Rectangular	1.73	1	0.6 %	0.32	0.32	∞	
<b>Phantom and Setup Related</b>										
23	Phantom Thickness	2.4 %	Rectangular	1.73	1	1.4 %	1.92	1.92	∞	
Combined standard Uncertainty [%]						12.8 %		164.64		0.523 dB
Expanded standard Uncertainty [k = 2 , Confidence 95 %]						25.7 %				0.993 dB

**Table 2. Uncertainties (E-Field)**

Notes:

1. Worst-Case uncertainty budget for HAC free field assessment according to ANSI-C 63.19[1]. The budget is valid for the frequency range 800 MHz-3 GHz and represents a worst-Case analysis. For specific test sand configurations, the uncertainty could be considerably smaller. Some of the parameters are dependent on the user situations and need adjustment according to the actual laboratory conditions.
2. \* Uncertainty specifications from Schmidt & Partner Engineering AG (not site specific)

## 10.2 H-Field

HAC (H-Field) Uncertainty Budget [According to ANSI C63.19]										Note/ Comment
Error Description	Uncertainty [%]	Probability Distribution	Divisor	ci [H]	Standard Uncertainty [H]	Stand Uncert*2	(Stand Uncert*2) X (ci^2)	Vi & Veff		
<b>Measurement system</b>										
1	Probe Calibration	5.1 %	Normal	1.00	1	5.1 %	26.01	26.01	∞	
2	Axial Isotropy	4.7 %	Rectangular	1.73	1	2.7 %	7.36	7.36	∞	
3	Sensor Displacement	16.5 %	Rectangular	1.73	0.145	1.4 %	1.91	0.04	∞	
4	Boundary effect	2.4 %	Rectangular	1.73	1	1.4 %	1.92	1.92	∞	
5	Linearity	4.7 %	Rectangular	1.73	1	2.7 %	7.36	7.36	∞	
6	Scaling to peak Envelope Power	2.0 %	Rectangular	1.73	1	1.2 %	1.33	1.33	∞	
7	System Detection limits	1.0 %	Rectangular	1.73	1	0.6 %	0.33	0.33	∞	
8	Readout Electronics	0.3 %	Normal	1.00	1	0.3 %	0.09	0.09	∞	
9	Response time	0.8 %	Rectangular	1.73	1	0.5 %	0.21	0.21	∞	
10	Integration time	2.6 %	Rectangular	1.73	1	1.5 %	2.25	2.25	∞	
11	RF Ambient Conditions	3.0 %	Rectangular	1.73	1	1.7 %	3.00	3.00	∞	
12	RF Reflections	1.1 %	Rectangular	1.00	1	1.1 %	1.14	1.14	∞	
13	Probe positioner	1.2 %	Rectangular	1.73	0.67	0.5 %	0.22	0.10	∞	
14	Probe positioning	4.7 %	Rectangular	1.73	0.67	1.8 %	3.31	1.48	∞	
15	Extrap. And Interpolation	1.0 %	Rectangular	1.73	1	0.6 %	0.33	0.33	∞	
<b>Test Sample Related</b>										
16	Device Positioning Vertical	4.7 %	Rectangular	1.73	0.67	1.8 %	3.31	7.32	∞	
17	Device Positioning Lateral	1.0 %	Rectangular	1.73	1	0.6 %	0.33	0.33	∞	
18	Device Holder and Phantom	2.4 %	Rectangular	1.73	1	1.4 %	1.92	1.92	∞	
19	Test Sample	0.3 %	Normal	1.00	1	0.3 %	0.08	0.08	9	0.013 dB
20	Power drift	3.0 %	Rectangular	1.73	1	1.7 %	3.00	3.00	∞	
<b>PMF Calculations</b>										
21	Power Sensor	1.0 %	Rectangular	1.73	1	0.6 %	0.32	0.10	∞	
22	Dual Directional Coupler	1.0 %	Rectangular	1.73	1	0.6 %	0.32	0.32	∞	
<b>Phantom and Setup Related</b>										
23	Phantom Thickness	2.4 %	Rectangular	1.73	0.67	0.9 %	0.86	0.39	∞	
Combined standard Uncertainty [%]						8.2 %		66.44		0.342 dB
Expanded standard Uncertainty [k = 2 , Confidence 95 %]						16.3 %				0.6558 dB

**Table 2. Uncertainties (H-Field)**

**Notes:**

1. Worst-Case uncertainty budget for HAC free field assessment according to ANSI-C 63.19[1]. The budget is valid for the frequency range 800 MHz-3 GHz and represents a worst-Case analysis. For specific test sand configurations, the uncertainty could be considerably smaller. Some of the parameters are dependent on the user situations and need adjustment according to the actual laboratory conditions.

2. \* Uncertainty specifications from Schmidt & Partner Engineering AG (not site specific)

## 11. HAC TEST DATA SUMMARY

**Ambient TEMPERATURE (°C):** 21.3
**S/N:** #1

### 11.1 E-Field Measurement Results (GSM850 / GSM1900 DATA)

Mode	Ch.	Back light	Battery	Antenna	Conducted Power [dBm]	Time Avg. Field [V/m]	Peak Field [dBV/m]	FCC Limit [dBV/m]	FCC MARGIN [dB]	RESULT	Exclusion Block
GSM850	128	off	Standard	Intenna	32.59	19.0	34.2	48.5	-14.25	<b>M4</b>	none
GSM850	190	off	Standard	Intenna	32.60	27.2	37.4	48.5	-11.14	<b>M4</b>	none
GSM850	251	off	Standard	Intenna	32.60	28.3	37.7	48.5	-10.80	<b>M4</b>	none
GSM1900	512	off	Standard	Intenna	29.61	16.0	32.4	38.5	-6.09	<b>M4</b>	none
GSM1900	661	off	Standard	Intenna	29.62	16.7	32.8	38.5	-5.73	<b>M4</b>	none
GSM1900	810	off	Standard	Intenna	29.60	15.6	32.2	38.5	-6.28	<b>M4</b>	none

**NOTES:**

- All modes of operation were investigated and the worst-case are reported.
- Battery Type  Standard  Extended  Fixed
- Power Measured  Conducted  EIRP  ERP
- Test Signal Call Mode  Manual Test cord  Base Station Simulator
- SAR Measurement System  SPEAG

## 11.2 H-Field Measurement Results (GSM850 / GSM1900 DATA)

Ambient TEMPERATURE (°C): 21.3

S/N: #1

Mode	Ch.	Back light	Battery	Antenna	Conducted Power [dBm]	Time Avg. Field [A/m]	Peak Field [dBA/m]	FCC Limit [dBA/m]	FCC MARGIN [dB]	RESULT	Exclusion Block
GSM850	128	off	Standard	Intenna	32.59	0.040	-21.4	-1.9	-19.51	M4	none
GSM850	190	off	Standard	Intenna	32.60	0.056	-18.6	-1.9	-16.65	M4	none
GSM850	251	off	Standard	Intenna	32.60	0.049	-19.7	-1.9	-17.76	M4	none
GSM1900	512	off	Standard	Intenna	29.61	0.051	-18.7	-11.9	-6.81	M4	none
GSM1900	661	off	Standard	Intenna	29.62	0.055	-18.1	-11.9	-6.19	M4	none
GSM1900	810	off	Standard	Intenna	29.60	0.055	-18.0	-11.9	-6.14	M4	none

NOTES:

- All modes of operation were investigated and the worst-case are reported.
- Battery Type  Standard  Extended  Fixed
- Power Measured  Conducted  EIRP  ERP
- Test Signal Call Mode  Manual Test cord  Base Station Simulator
- SAR Measurement System  SPEAG

### 11.3 E-Field Measurement Results (WCDMA850 /WCDMA1900 DATA)

Ambient TEMPERATURE (°C): 21.3

S/N: #1

Mode	Ch.	Back light	Battery	Antenna	Conducted Power [dBm]	Time Avg. Field [V/m]	Peak Field [dBV/m]	FCC Limit [dBV/m]	FCC MARGIN [dB]	RESULT	Exclusion Block
WCDMA850	4132	off	Standard	Intenna	22.84	15.9	21.9	51	-29.14	<b>M4</b>	none
WCDMA850	4183	off	Standard	Intenna	22.83	18.2	23.0	51	-27.96	<b>M4</b>	none
WCDMA850	4233	off	Standard	Intenna	22.77	20.5	24.1	51	-26.91	<b>M4</b>	none
WCDMA1900	9262	off	Standard	Intenna	22.74	18.0	23.5	41	-17.47	<b>M4</b>	none
WCDMA1900	9400	off	Standard	Intenna	22.75	18.0	23.5	41	-17.48	<b>M4</b>	none
WCDMA1900	9538	off	Standard	Intenna	22.80	18.2	23.6	41	-17.36	<b>M4</b>	none

**NOTES:**

1. All modes of operation were investigated and the worst-case are reported.
2. Battery Type                     Standard    Extended    Fixed
3. Power Measured                 Conducted    EIRP         ERP
4. Test Signal Call Mode         Manual Test cord    Base Station Simulator
5. SAR Measurement System  SPEAG



## 11.4 H-Field Measurement Results (WCDMA850 /WCDMA1900 DATA)

**Ambient TEMPERATURE (°C):** 21.3
**S/N:** #1

Mode	Ch.	Back light	Battery	Antenna	Conducted Power [dBm]	Time Avg. Field [A/m]	Peak Field [dBA/m]	FCC Limit [dBA/m]	FCC MARGIN [dB]	RESULT	Exclusion Block
WCDMA850	4132	off	Standard	Intenna	22.84	0.031	-31.6	0.6	-32.17	<b>M4</b>	none
WCDMA850	4183	off	Standard	Intenna	22.83	0.040	-29.6	0.6	-30.16	<b>M4</b>	none
WCDMA850	4233	off	Standard	Intenna	22.77	0.040	-29.4	0.6	-30.01	<b>M4</b>	none
WCDMA1900	9262	off	Standard	Intenna	22.74	0.055	-26.7	-9.4	-17.30	<b>M4</b>	none
WCDMA1900	9400	off	Standard	Intenna	22.75	0.059	-26.1	-9.4	-16.73	<b>M4</b>	none
WCDMA1900	9538	off	Standard	Intenna	22.80	0.064	-25.5	-9.4	-16.09	<b>M4</b>	none

**NOTES:**

- All modes of operation were investigated and the worst-case are reported.
- Battery Type  Standard  Extended  Fixed
- Power Measured  Conducted  EIRP  ERP
- Test Signal Call Mode  Manual Test cord  Base Station Simulator
- SAR Measurement System  SPEAG

## 11.5 Worst-case Configuration Evaluation

Ambient TEMPERATURE (°C): 21.3

S/N: #1

### Peak Reading 360° Probe Rotation at Azimuth axis

Mode	Chan nel	Backlight	RC/SO	Antenna	Conducted Power (dBm)	Time Avg. Field (V/m)	Peak Field (dBV/m)	FCC Limit (dBV/m)	FCC MARGIN (dB)	Exclusion Block	RESULT
GSM1900	661	off	Standard	Intenna	29.62	16.7	32.8	38.5	-5.73	none	<b>M4</b>

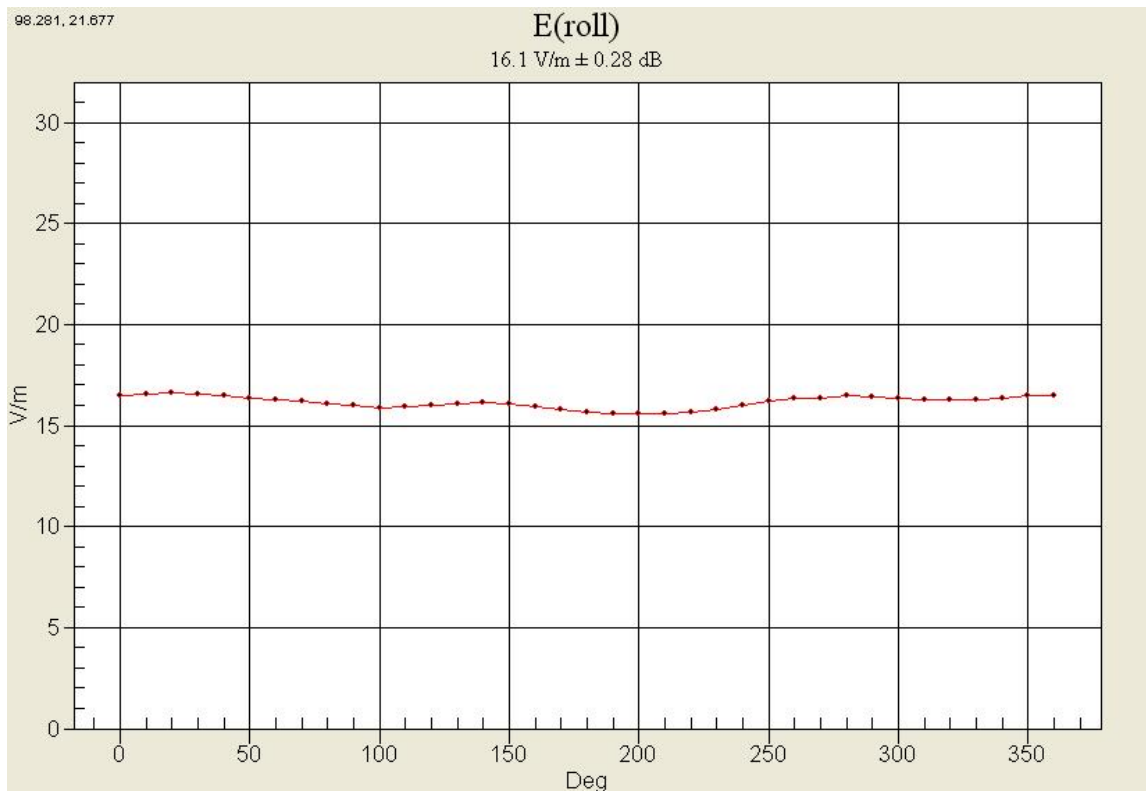

**Worst-Case Probe Rotation about Azimuth axis**

## 12. HAC TEST EQUIPMENT LIST

Manufacturer	Type / Model	S/N	Calib. Date	Calib. Interval	Calib. Due
Staubli	Robot RX90L	F01/ 5K09A1/A/01	N/A	N/A	N/A
Staubli	Robot ControllerCS7MB	F99/5A82A1/C/01	N/A	N/A	N/A
Staubli	Teach Pendant (Joystick)	D221340.01	N/A	N/A	N/A
HP	Pavilion t000_puffer	KRJ51201TV	N/A	N/A	N/A
SPEAG	SPEAG HAC Phantom	-	N/A	N/A	N/A
SPEAG	Light Alignment Sensor	265	N/A	N/A	N/A
SPEAG	DAE3	446	05/21/10	Annual	05/21/11
SPEAG	E-Field Probe	2343	05/20/10	Annual	05/20/11
SPEAG	H-Field Probe	6101	05/27/10	Annual	05/27/11
SPEAG	Validation Dipole CD835V2	1024	02/16/10	Biennial	02/16/12
SPEAG	Validation Dipole CD1880V2	1019	02/17/10	Biennial	02/17/12
Agilent	Power Meter(F) E4419B	MY41291386	11/05/10	Annual	11/05/11
Agilent	Power Sensor(G) 8481	MY41090870	11/05/10	Annual	11/05/11
HP	Signal Generator E4438C	MY42082646	11/11/10	Annual	11/11/11
EM POWER	Power Amp BBS3Q7ELU	1009D/C0028	11/05/10	Annual	11/05/11
HP	Dual Directional Coupler 778D	16072	11/05/10	Annual	11/05/11
R&S	Base Station CMU200	110740	07/26/10	Annual	07/26/11
Agilent	Base Station E5515C	GB44400269	02/10/11	Annual	02/10/12
R&S	Spectrum Analyzer FSP30	839117/011	03/25/10	Annual	03/25/11

**NOTE:**

The probe was calibrated by SPEAG, by the waveguide technique procedure. Dipole Validation measurement is performed by HCT Lab. before each test.

## **13. CONCLUSION**

---

The HAC measurement indicates that the EUT complies with the HAC limits of the ANSI-C63.19-2007.

These measurements are taken to simulate the RF effects exposure under worst-case conditions. Precise Laboratory measures were taken to assure repeatability of the tests.