



**EUROFINS PRODUCT SERVICE GMBH**

# **SAR**

# **TEST - REPORT**

**SAR Compliance Test Report**

**Mobile terminal GSM 850/1800/1900  
C180**

**Test report no.:**  
**G5M209010001-S-8**



Eurofins Product Service GmbH  
Storkower Str. 38c, 15526 Reichenwalde,  
Germany

Phone +49-33631-888 0  
Fax +49-33631-888 660

## TABLE OF CONTENTS

<b>1</b>	<b>General information</b>	<b>2</b>
1.1	Notes	2
1.2	Testing laboratory	3
1.3	Details of approval holder	3
1.4	Manufacturer	4
1.5	Application details	4
1.6	Test item	4
1.7	Test results	5
1.8	Test standards	5
<b>2</b>	<b>Technical test</b>	<b>6</b>
2.1	Summary of test results	6
2.2	Test environment	7
2.3	Test equipment utilized	7
2.4	Definitions	8
2.5	Measurement system description	9
2.6	Test system specification	14
2.7	Measurement procedure	15
2.8	Reference points	16
2.9	Test positions	18
2.10	Measurement uncertainty	22
<b>3</b>	<b>Tissue and system verification</b>	<b>23</b>
3.1	Tissue verification	23
3.2	System verification	24
<b>4</b>	<b>Test Results</b>	<b>25</b>
<b>5</b>	<b>References</b>	<b>29</b>
<b>6</b>	<b>Annex</b>	<b>30</b>

# 1 General Information

## 1.1 Notes

The purpose of conformity testing is to increase the probability of adherence to the essential requirements or conformity specifications, as appropriate.

The complexity of the technical specifications, however, means that full and thorough testing is impractical for both technical and economic reasons.

Furthermore, there is no guarantee that a test sample which has passed all the relevant tests conforms to a specification.

The existence of the tests nevertheless provides the confidence that the test sample possesses the qualities as maintained and that its performance generally conforms to representative cases of communications equipment.

The test results of this test report relate exclusively to the item tested as specified in 1.5.

The test report may only be reproduced or published in full.

Reproduction or publication of extracts from the report requires the prior written approval of the EUROFINS PRODUCT SERVICE GMBH.

I attest to the accuracy of data. All measurements reported herein were performed by me or were made under my supervision and are correct to the best of my knowledge and belief. I assume full responsibility for the completeness of these measurements and vouch for the qualification of all persons taking them.

### Operator:

09.02.2009		B. Pudell	
Date	Eurofins -Lab.	Name	Signature

### Technical responsibility for area of testing:

09.02.2009		T. Jahn	
Date	Eurofins	Name	Signature

---

Test Report No.: G5M209010001-S-8

Eurofins Product Service GmbH  
Storkower Str. 38c, D-15526 Reichenwalde, Germany

## 1.2 Testing laboratory

### 1.2.1 Location

EUROFINS PRODUCT SERVICE GMBH  
Storkower Straße 38c  
D-15526 Reichenwalde b. Berlin  
Germany  
Telephone : +49 33631 888 00  
Fax : +49 33631 888 660

### 1.2.2 Details of accreditation status

**DAR ACCREDITED TESTING LABORATORY**  
DAR-REGISTRATION NUMBER: DAT-P-268/08

**RECOGNIZED NOTIFIED BODY EMC**  
REGISTRATION NUMBER: BNetzA-bS EMV-07/61

**RECOGNIZED NOTIFIED BODY R&TTE**  
REGISTRATION NUMBER: BNetzA-bS-02/51-53

**FCC FILED TEST LABORATORY**  
REG.-NO. 96970

**A2LA ACCREDITED TESTING LABORATORY**  
CERTIFICATE NO. 1983.01

**BLUETOOTH QUALIFICATION TEST FACILITY (BQTF)**  
ACCREDITED BY BLUETOOTH QUALIFICATION REVIEW BOARD

**INDUSTRY CANADA FILED TEST LABORATORY**  
REG. NO. IC 3470

**Statement:** The tests documented within this report are carried out in accordance with the scope of accreditation of test laboratory Eurofins Product Service GmbH.

## 1.3 Details of approval holder

Name	: Pantech Co., Ltd.
Street	: Pantech Bldg, I-2 DMC, Sangam-dong
Town	: 121-270 Mapo-gu, Seoul
Country	: Korea
Telephone	: +82-2-2030-2100
Fax	: +82-2-2030-2517
Contact	: Mr. Gwang Cheol Park
E-Mail	: gpark@pantech.com

---

Test Report No.: G5M209010001-S-8

---

Eurofins Product Service GmbH  
Storkower Str. 38c, D-15526 Reichenwalde, Germany

#### 1.4 Manufacturer: (if applicable)

Name :  
 Street :  
 Town :  
 Country :

#### 1.5 Application details

Date of receipt of application : 20.01.2009  
 Date of receipt of test item : 20.01.2009  
 Date of test : 27.01.2009 - 29.01.2009

#### 1.6 Test item

FCC ID : JYCC180  
 Description of test item : Mobile terminal GSM 850/1800/1900  
 Type identification : C180  
 Serial number : without; Identical prototype  
 Device category : PCE ( Licensed Portable Transmitter held to ear)

#### Technical data

##### GSM / PCS / GPRS

	<u>GSM 850 / GPRS</u>	<u>PCS 1900 / / GPRS</u>
Frequency range	824.2 - 848.8 MHz	1850.2 - 1909.9 MHz
TX Frequency range	869.2 - 893.8 MHz	1930.2 - 1989.8 MHz
RX Frequency range	31,39 dBm (1,38 W)	28,25 dBm (0,67 W)
Max. Cond GSM output power	31,04 dBm (1,27 W)	28,05 dBm (0,64 W)
Max. Cond GPRS output power		

Power supply : 3.8 V DC rechargeable battery

Antenna Tx : integral

Antenna RX : integral

Additional information : Tx and Rx. antenna are the same.  
 This test sample was tested according FCC OET Bulletin 65, Supplement C, Edition 01-01 on the used Frequency band..

## 1.7 Test Results

Max. SAR Measurement GSM (Head)	: 1.13 W/kg (averaged over 1 gram)
Max. SAR Measurement GSM (Body)	: 0,865 W/kg (averaged over 1 gram)
Max. SAR Measurement PCS (Head)	: 0.811 W/kg (averaged over 1 gram)
Max. SAR Measurement PCS (Body)	: 0.436 W/kg (averaged over 1 gram)
Max. SAR Measurement GPRS 850 (Body)	: 1.30 W/kg (averaged over 1 gram)
Max. SAR Measurement GPRS 1900 (Body)	: 0.780 W/kg (averaged over 1 gram)

This EUT has been shown to be capable of compliance for localized specific absorption rate (SAR) for uncontrolled environment/general population exposure limits specified in ANSI/IEEE Std. C95.1-1992 and had been tested in accordance with the measurement procedures specified in FCC/OET Bulletin 65 Supplement C (2001) and IEEE Std. 1528-2003, December 2003.

## 1.8 Test standards

Standards	: - IEEE Std. 1528-2003, December 2003
FCC Rule Part(s)	: - FCC OET Bulletin 65, Supplement C, Edition 01-01

## 2 Technical test

### 2.1 Summary of test results

#### Applicable Configuration

Handset (Head)	X
Handset (Body)	X
Headset (Head)	
Body Worn Equipment	

EUT complies with the RF radiation exposure limits of the FCC as shown by the SAR measurement results. These measurements are taken to simulate the RF effects exposure under worst-case conditions. The EUT complies with the requirements in respect to all parameters subject to the test. The test results and statements relate only to the item(s) tested.

Please note that the absorption and distribution of electromagnetic energy in the body are very complex phenomena that depend on the mass, shape, and size of the body, the orientation of the body with respect to the field vectors, and the electrical properties of both the body and the environment. Other variables that may play a substantial role in possible biological effects are those that characterize the environment (e.g. ambient temperature, air velocity, relative humidity, and body insulation) and those that characterize the individual (e.g. age, gender, activity level, debilitation, or disease). Because innumerable factors may interact to determine the specific biological outcome of an exposure to electromagnetic fields, any protection guide shall consider maximal amplification of biological effects as a result of field-body interactions, environmental conditions, and physiological variables. [1]

In case of multiple hotspots the secondary hotspots within 2 dB of the maximum SAR value will be recorded and displayed in the measurement plots. The secondary hotspots with a peak SAR value below 0.5 W/kg will not be measured by the system, due to the high margin to the limits.

### 2.2 Test environment

Room temperature	: 22.1 - 22.6 °C
Liquid temperature	: 22.0 - 22.3 °C
Relative humidity content	: 20 ... 75 %
Air pressure	: 86 ... 103 kPa
Details of power supply	: 3.8 V DC

## 2.3 Test equipment utilized

No.	Measurement device:	Type:	Manufacturer:
ETS 0449	Stäubli Robot	RX90B L	Stäubli
ETS 0450	Stäubli Robot Controller	CS/MBs&p	Stäubli
ETS 0451	DASY 4 Measurement Server		Schmid & Partner
ETS 0452	Control Pendant		Stäubli
ETS 0453	Compaq Computer	Pentium IV, 2 GHz,	Schmid & Partner
ETS 0454	Dabu Acquisition Electronics	DAE3V1	Schmid & Partner
ETS 0455	Dummy Probe		Schmid & Partner
ETS 0456	Dosimetric E-Field Probe	ET3DV6	Schmid & Partner
ETS 0457	Dosimetric E-Field Probe	ET3DV6	Schmid & Partner
ETS 0458	Dosimetric H-Field Probe	H3DV6	Schmid & Partner
ETS 0479	System Validation Kit	D300V3	Schmid & Partner
ETS 0480	System Validation Kit	D450V3	Schmid & Partner
ETS 0459	System Validation Kit	D900V2	Schmid & Partner
ETS 0460	System Validation Kit	D1800V2	Schmid & Partner
ETS 0461	System Validation Kit	D1900V2	Schmid & Partner
ETS 0462	System Validation Kit	D2450V2	Schmid & Partner
ETS 0463	Probe Alignment Unit	LBV2	Schmid & Partner
ETS 0464	SAM Twin phantom	V 4.0	Schmid & Partner
ETS 0513	Flat phantom	V 4.4	Schmid & Partner
ETS 0467	Oval flat phantom	ELI 4	Schmid & Partner
ETS 0465	Mounting Device	V 3.1	Schmid & Partner
ETS 0224a	Millivoltmeter	URV 5	Rohde & Schwarz
ETS 0219	Power sensor	NRV-Z2	Rohde & Schwarz
ETS 0268	RF signal generator	SMP 02	Rohde & Schwarz
ETS 0322	Insertion unit	URV5-Z4	Rohde & Schwarz
ETS 0466	Directional Coupler	HP 87300B	HP
ETS 0231	Radio Communication Tester	CMD65	Rohde & Schwarz
ETS 0484	Universal Radio Communication Tester	CMU 200	Rohde & Schwarz
ETS 0468	Network Analyzer 300 kHz to 3 GHz	8753C	Agilent
ETS 0469	Dielectric Probe Kit	85070C	Agilent



## 2.4 Definitions

### 2.4.1 SAR

The specific absorption rate (SAR) is defined as the time derivative of the incremental energy ( $dW$ ) absorbed by (dissipated in) an incremental mass ( $dm$ ) contained in a volume element ( $dV$ ) of a given density ( $\rho$ ), expressed in watts per kilogram (W/kg).

$$\text{SAR} = \frac{d}{dt} \left( \frac{dW}{dm} \right) = \frac{d}{dt} \left( \frac{dW}{\rho_t dV} \right) = \frac{\sigma}{\rho_t} |E_t|^2$$

where:

$$\frac{dW}{dt} = \int_v E \cdot J dV = \int_v \sigma E^2 dV$$

### 2.4.2 Uncontrolled Exposure

The general population/uncontrolled exposure limits are applicable to situations in which the general public may be exposed or in which persons who are exposed as a consequence of their employment may not be made fully aware of the potential for exposure or cannot exercise control over their exposure. Members of the general public would come under this category when exposure is not employment-related; for example, in the case of a wireless transmitter that exposes persons in its vicinity. Warning labels placed on low-power consumer devices such as cellular telephones are not considered sufficient to allow the device to be considered under the occupational/controlled category, and the general population/uncontrolled exposure limits apply to these devices. [2].

### 2.4.3 Controlled Exposure

In general, occupational/controlled exposure limits are applicable to situations in which persons are exposed as a consequence of their employment, who have been made fully aware of the potential for exposure and can exercise control over their exposure. This exposure category is also applicable when the exposure is of a transient nature due to incidental passage through a location where the exposure levels may be higher than the general population/uncontrolled limits, but the exposed person is fully aware of the potential for exposure and can exercise control over his or her exposure by leaving the area or by some other appropriate means. Awareness of the potential for RF exposure in a workplace or similar environment can be provided through specific training as part of a RF safety program. If appropriate, warning signs and labels can also be used to establish such awareness by providing prominent information on the risk of potential exposure and instructions on the risk of potential exposure and instructions on methods to minimize such exposure risks. [2].

## 2.5 Measurement System Description

### 2.5.1 System Setup

Measurements are performed using the DASY4 automated dosimetric assessment system (figure 1) made by Schmid & Partner Engineering AG (SPEAG) in Zurich, Switzerland.



Figure 1

The DASY4 system for performing compliance tests consists of the following items:

- A standard high precision 6-axis robot (Stäubli RX family) with controller, teach pendant and software. An arm extension for accommodating the data acquisition electronics (DAE).
- A dosimetric probe, i.e., an isotropic E-field probe optimized and calibrated for usage in tissue simulating liquid. The probe is equipped with an optical surface detector system.
- A data acquisition electronics (DAE) which performs the signal amplification, signal multiplexing, AD-conversion, offset measurements, mechanical surface detection, collision detection, etc. The unit is battery powered with standard or rechargeable batteries. The signal is optically transmitted to the EOC.
- An unit to operate the optical surface detector which is connected to the EOC.
- The Electro-optical converter (EOC) performs the conversion from the optical into a digital electric signal of the DAE. The EOC is connected to the measurement server.
- The functions of the measurement server is to perform the time critical task such as signal filtering, surveillance of the robot operation, fast movement interrupts.
- A probe alignment unit which improves the (absolute) accuracy of the probe positioning.
- A computer operating Windows 2000 or Windows NT.
- DASY4 software.
- Remote control with teach pendant and additional circuitry for robot safety such as warning lamps, etc.
- The SAM twin phantom enabling testing left-hand and right-hand usage.
- The device holder for handheld mobile phones.
- Tissue simulating liquid mixed according to the given recipes (see Application Notes).
- System validation dipoles allowing to validate the proper functioning of the system.

## 2.5.2 Phantom Description



(Figure 2.1)

The SAM twin phantom V4.0 (figure 2.1) is a fiberglass shell phantom with 2 mm shell thickness. It has three measurement areas:

- Left hand
- Right hand
- Flat phantom



(Figure 2.2)

The Oval flat phantom (ELI 4) (figure 2.3) is a fiberglass shell phantom with 2 mm thickness.

The phantom is integrated in a wooden table.

The bottom plate of the table contains three pair of bolts for locking the device holder. The device holder positions are adjusted to the standard measurement positions in the three sections. Only one device holder is necessary if two phantoms are used (e.g., for different liquids).

A cover is provided to tap the phantom during off-periods to prevent water evaporation and changes in the liquid parameters. Free space scans of devices on the cover are possible.

On the phantom top, three reference markers are provided to identify the phantom positions with respect to the robot.

### 2.5.3 Tissue Simulating Liquids

The parameters of the tissue simulating liquid strongly influence the SAR. The parameters for the different frequencies are defined in the corresponding compliance standards (e.g., EN 50361, IEEE P1528-2003).

Tissue dielectric properties

Frequency (MHz)	Head		Body	
	Relative Dielectric Constant ( $\epsilon_r$ )	Conductivity ( $\sigma$ ) (S/m)	Relative Dielectric Constant ( $\epsilon_r$ )	Conductivity ( $\sigma$ ) (S/m)
300	45.3	0.87	58.2	0.92
450	43.5	0.87	56.7	0.94
835	41.5	0.90	55.2	0.97
900	41.5	0.97	55.0	1.05
1450	40.5	1.20	54.0	1.30
1800	40.0	1.40	53.3	1.52
1900	40.0	1.40	53.3	1.52
2000	40.0	1.40	53.3	1.52
2450	39.2	1.80	52.7	1.95
3000	38.5	2.40	52.0	2.73

## 2.5.4 Device Holder

The DASY device holder (figure 3.1 and 3.2) is designed to cope with different positions given in the standard. It has two scales for the device rotation (with respect to the body axis) and the device inclination (with respect to the line between the ear openings). The rotation centers for both scales is the ear opening. Thus the device needs no repositioning when changing the angles.



Figure 3.1



Figure 3.2

The DASY device holder has been made out of low-loss POM material having the following dielectric parameters: relative permittivity  $\epsilon = 3$  and loss tangent  $\delta = 0.02$ . The amount of dielectric material has been reduced in the closest vicinity of the device, since measurements have suggested that the influence of the clamp on the test results could thus be lowered.

### 2.5.5 Probes

The SAR measurements were conducted with the dosimetric probe ET3DV6 (figure 4), designed in the classical triangular configuration and optimized for dosimetric evaluation. [3] The probe is constructed using the thick film technique; with printed resistive lines on ceramic substrates. The probe is equipped with an optical multifiber line ending at the front of the probe tip. It is connected to the EOC box on the robot arm and provides an automatic detection of the phantom surface. Half of the fibers are connected to a pulsed infrared transmitter, the other half to a synchronized receiver. As the probe approaches the surface, the reflection from the surface produces a coupling from the transmitting to the receiving fibers. This reflection increases first during the approach, reaches maximum and then decreases. If the probe is flatly touching the surface, the coupling is zero. The distance of the coupling maximum to the surface is independent of the surface reflectivity and largely independent of the surface to probe angle. The DASY4 software reads the reflection during a software approach and looks for the maximum using a 2<sup>nd</sup> order fitting. The approach is stopped at reaching the maximum.



Figure 4

### Probe Specifications

Calibration:	In air from 10 MHz to 2.5 GHz In brain and muscle simulating tissue at Frequencies of 835 MHz, 900 MHz, 1800 MHz, 1900 MHz and 2450 MHz Calibration certificates please find attached.
Frequency:	10 MHz to > 3 GHz; Linearity: $\pm 0.2$ dB (30 MHz to 3 GHz)
Directivity:	$\pm 0.2$ dB in HSL (rotation around probe axis) $\pm 0.4$ dB in HSL (rotation normal probe axis)
Dynamic Range:	5 $\mu$ W/g to > 100 mW/g;
Linearity:	$\pm 0.2$ dB
Dimensions:	Overall length: 330 mm Tip length: 16 mm Body diameter: 12 mm Tip diameter: 6.8 mm Distance from probe tip to dipole centers: 2.7 mm
Application:	General dosimetry up to 3 GHz Compliance tests of mobile phones Fast automatic scanning in arbitrary phantoms

## 2.6 Test System Specification

### Positioner

Robot:	Stäubli Animation Corp. Robot Model: RX90B L
Repeatability:	0.02 mm
No. of axis:	6

### Data Acquisition Electronic (DAE) System

#### Cell Controller

Processor:	Pentium IV
Clock Speed:	2.0 GHz
Operating System:	Windows 2000
Data Card:	DASY4 PC-Board
Data Converter	
Features:	Signal Amplifier, multiplexer, A/D converter, & control logic
Software:	DASY4 software
Connecting Lines:	Optical downlink for data and status info. Optical uplink for commands and clock

### PC Interface Card

Function:	24 bit (64 MHz) DSP for real time processing Link to DAE3 16 bit A/D converter for surface detection system serial link to robot direct emergency stop output for robot
-----------	---

### E-Field Probes

Model:	ET3DV6 SN1711
Construction:	Triangular core fiber optic detection system
Frequency:	10 MHz to 6 GHz
Linearity:	$\pm 0.2$ dB (30MHz to 3 GHz)

### Phantom

Phantom 1:	Oval flat phantom (ELI 4)
Shell Material:	Fiberglass
Thickness:	$2.0 \pm 0.2$ mm
Phantom 2:	SAM Twin Phantom (V4.0)
Shell Material:	Fiberglass
Thickness:	$2.0 \pm 0.2$ mm

## 2.7 Measurement Procedure

The evaluation was performed using the following procedure:

1. The SAR measurement was taken at a selected spatial reference point to monitor power variations during testing. This fixed location point was measured and used as a reference value.
2. The SAR distribution at the exposed side of the head was measured at a distance of 3.9 mm from the inner surface of the shell. The area covered the entire dimension of the head and the horizontal grid spacing was 10 mm x 10 mm.
3. Based on the area scan data, the area of the maximum absorption was determined by spline interpolation. Around this point, a volume of 30 mm x 30 mm x 30 mm (fine resolution volume scan, zoom scan) was assessed by measuring 5 x 5 x 5 points. On this basis of this data set, the spatial peak SAR value was evaluated with the following procedure:
  - a. The data at the surface was extrapolated, since the center of the dipoles is 2.7 mm away from the tip of the probe and the distance between the surface and the lowest measuring point is 1.2 mm. The extrapolation was based on a least square algorithm [4]. A polynomial of the fourth order was calculated through the points in z-axes. This polynomial was then used to evaluate the points between the surface and the probe tip.
  - b. The maximum interpolated value was searched with a straight-forward algorithm. Around this maximum the SAR values averaged over the spatial volumes (1 g or 10 g) were computed using the 3D-Spline interpolation algorithm. The 3D-spline is composed of three one-dimensional splines with the "Not a knot" condition (in x, y, and z directions) [4] [5]. The volume was integrated with the trapezoidal algorithm. One thousand points (10 x 10 x 10) were interpolated to calculate the average.
  - c. All neighboring volumes were evaluated until no neighboring volume with a higher average value was found.
4. The SAR reference value, at the same location as procedure # 1, was re-measured. If the value changed by more than 5 %, the evaluation is repeated.



## 2.8 Reference Points

### 2.8.1 Ear Reference Points

Figure 5.1 shows the front, back and side vies of SAM. The point "M" is the reference point for the center of mouth, "LE" is the left ear reference point (ERP), and "RE" is the right ERP. The ERPs are 15 mm posterior to the entrance to ear canal (EEC) along the B-M line (Back-Mouth), as shown in Figure 5.2. The plane passing through the two ear reference points and M is defined as the Reference Plane. The line N-F (Neck-Front) perpendicular to the reference plane and passing through the RE (or LE) is called the Reference Pivoting Line (see Figure 5.3). Line B-M is perpendicular to the N-F line. Both N-F and B-M lines should be marked on the external phantom shell to facilitate handset positioning. Posterior to the N-F line, the thickness of the N-F line, the ear is truncated as illustrated in Figure 5.2. The ear truncation is introduced to avoid the handset from touching the ear lobe, which can cause unstable handset positioning at the cheek. [6]



Figure 5.1

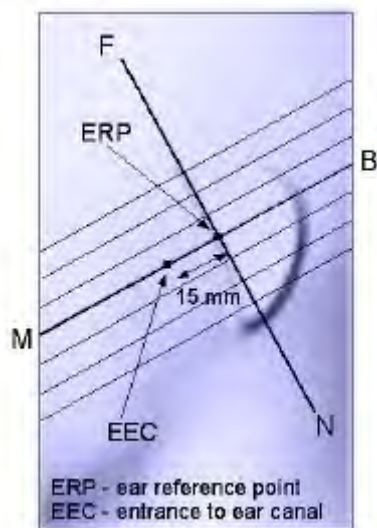

Figure 5.2

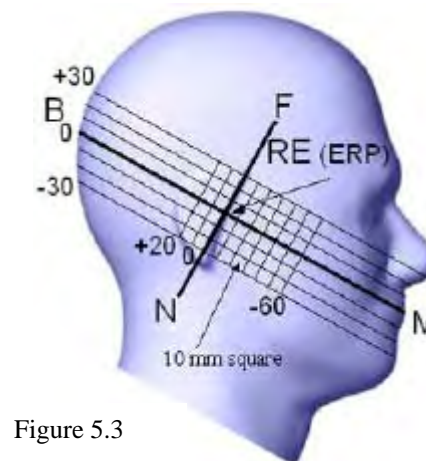

Figure 5.3

## 2.8.2 Handset Reference Points

Two imaginary lines on the handset were defined: the vertical centerline and the horizontal line. The vertical centerline passes through two points on the front side of the handset: the midpoint of the width  $w_t$  of the handset at the level of the acoustic output (point A on Figures 6.1 and 6.2), and the midpoint of the width  $w_b$  of the bottom of the handset (point B). The horizontal line is perpendicular to the vertical centerline and passes through the center of the acoustic output (see Figure 6.1). The two lines intersect at point A. For many handsets, point A coincides with the center of the acoustic output. However, the acoustic output may be located elsewhere on the horizontal line. The vertical centerline is not necessarily parallel to the front face of the handset (see Figure 6.2), especially for clamshell handsets, handsets with flip pieces, and other irregularly-shaped handsets. [6]

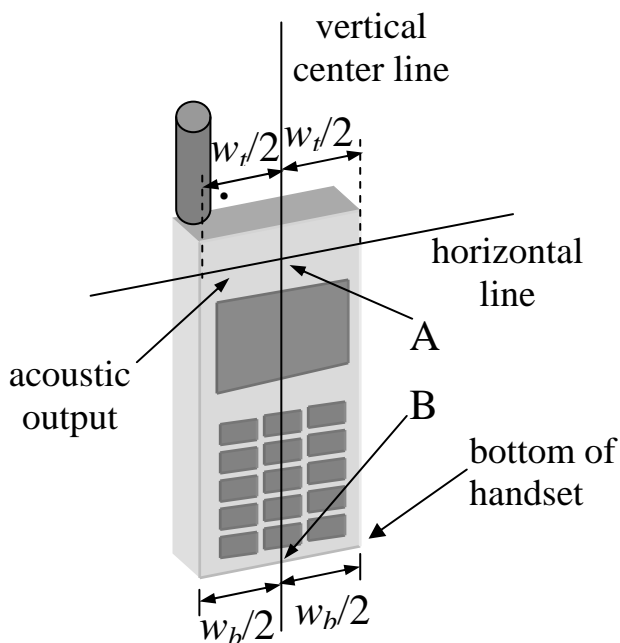

Figure 6.1

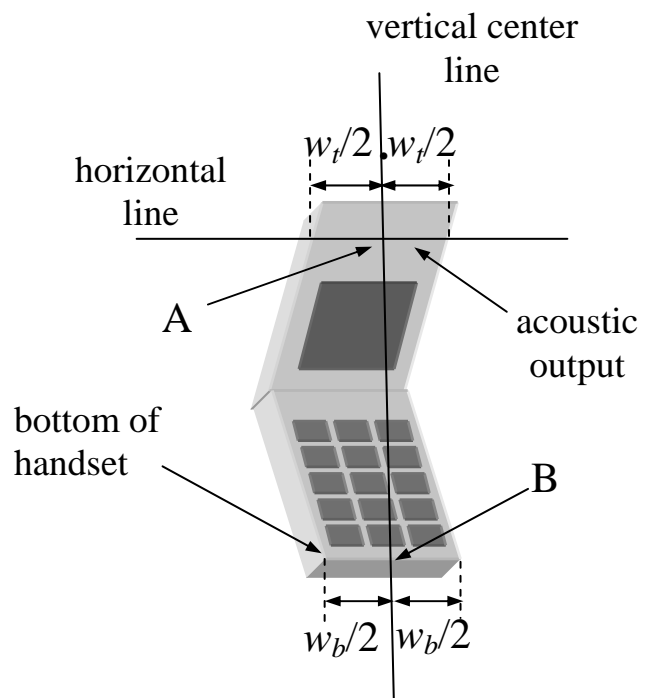

Figure 6.2

## 2.9 Test Positions

### 2.9.1 "Cheek" / "Touch" Position

The EUT was positioned close to the surface of the phantom such that point A is on the (virtual) extension of the line passing through points RE and LE on the phantom (see Figure 7), such that the plane defined by the vertical center line and the horizontal line of the handset is approximately parallel to the sagittal plane of the phantom.

The EUT was translated towards the phantom along the line passing through RE and LE until the handset touches the pinna.

While maintaining the handset in this plane, the EUT was rotated it around the LE-RE line until the vertical centerline was in the plane normal to MB-NF including the line MB (called the reference plane).

The EUT was rotated around the vertical centerline until the handset (horizontal line) was symmetrical with respect to the line NF.

While maintaining the vertical centerline in the reference plane, keeping point A on the line passing through RE and LE and maintaining the handset contact with the pinna, the EUT was rotated about the line NF until any point on the handset was in contact with a phantom point below the pinna (cheek). [6] See Figure 7.

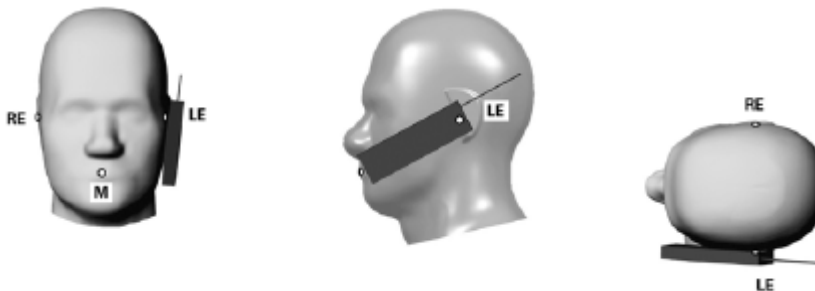

Figure 7

## 2.9.2 "Tilted" Position

The EUT was in "cheek position".

While maintaining the orientation of the handset move the handset away from the pinna along the line passing through RE and LE in order to enable a rotation of the handset by 15 degrees.

The EUT was rotated around the horizontal line by 15 degrees.

While maintaining the orientation of the handset, the EUT was moved towards the phantom on a line passing through RE and LE until any part of the handset touched the ear. The tilted position is obtained when the contact is on the pinna. If the contact was at any location other than the pinna (e.g., the antenna with the back of the phantom head), the angle of the handset would be reduced. In this case, the tilted position is obtained if any part of the handset was in contact with the pinna as well as a second part of the handset was in contact with the phantom (e.g., the antenna with the back of the head). [6] See Figure 8.

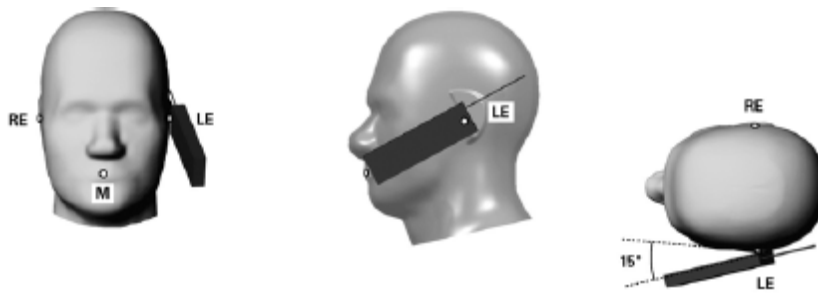

Figure 8

### 2.9.3 Belt Clip/Holster Configuration

Test configurations for body-worn operated EUTs are carried out while the belt-clip and/or holster is attached to the EUT and placed against a flat phantom in a regular configuration (see Figure 9). An EUT with a headset output is tested with a headset connected to the device.

Body dielectric parameters are used.

There are two categories for accessories for body-worn operation configurations:

1. accessories not containing metallic components
2. accessories containing metallic components.

When the EUT is equipped with accessories not containing metallic components the tests are done with the accessory that dictates the closest spacing to the body. For accessories containing metallic parts a test with each one is implemented. If the multiple accessories share an identical metallic component (e.g. the same metallic belt-clip used with different holsters with no other metallic components) only the accessory that has the closest spacing to the body is tested.

In case that a EUT authorized to be body-worn is not supplied or has no options to be operated with any accessories, a test configuration where a separation distance between the back of the device and the flat phantom is used. All test position spacings are documented.

Transmitters operating in front of a person's face (e.g. push-to-talk configurations) are tested for SAR compliance with the front of the device positioned to face the flat platform. SAR Compliance tests for shoulder, waist or chest-worn transmitters are carried out with the accessories including headsets and microphones attached to the device and placed against a flat phantom in a regular configuration.

The SAR measurements are performed to investigate the worst-case positioning. This is documented and used to perform Body SAR testing. [2].



Figure 9

## 2.9.4 Headset Configuration

Headsets which have their radiating structure in close proximity to the head are measured according to the following conditions.

- Head tissue liquid is used.
- The EUT is positioned on the surface of the head of phantom according the picture below. Right and left position is tested according to the normal use (see figure 10).
- Additional metallic parts like clips or others are subject of testing, too.



Figure 10

Headsets which have their radiating structure in close proximity to the body are tested as body worn equipment.

## 2.10 Measurement uncertainty

The uncertainty budget has been determined for the DASY4 system performance check according to IEEE Std. 1528-2003 December 2003.

Error Description	Tol. (± %)	Prob. dist.	Div.	$(c)^{j1}$ (1 g)	Std. unc. (1 g) (± %)	$(v)^{j2}$
<b>Measurement System</b>						
Probe Calibration	4.8	N	1	1	4.8	$\infty$
Axial Isotropy	4.7	R	$\sqrt{3}$	0.7	1.9	$\infty$
Hemispherical Isotropy	9.6	R	$\sqrt{3}$	0.7	3.9	$\infty$
Boundary Effects	1.0	R	$\sqrt{3}$	1	0.6	$\infty$
Linearity	4.7	R	$\sqrt{3}$	1	2.7	$\infty$
System Detection Limit	1.0	R	$\sqrt{3}$	1	0.6	$\infty$
Readout Electronics	1.0	N	1	1	1.0	$\infty$
Response Time	0.8	R	$\sqrt{3}$	1	0.5	$\infty$
Integration Time	2.6	R	$\sqrt{3}$	1	1.5	$\infty$
RF Ambient Conditions	3.0	R	$\sqrt{3}$	1	1.7	$\infty$
Probe Positioner	0.4	R	$\sqrt{3}$	1	0.2	$\infty$
Probe Positioning	2.9	R	$\sqrt{3}$	1	1.7	$\infty$
Algorithms for Max. SAR Eval.	1.0	R	$\sqrt{3}$	1	0.6	$\infty$
<b>Test Sample Related</b>						
Device Positioning	2.9	N	1	1	2.9	145
Device Holder	3.6	N	1	1	3.6	5
Power Drift	5.0	R	$\sqrt{3}$	1	2.9	$\infty$
<b>Phantom and Setup</b>						
Phantom Uncertainty	4.0	R	$\sqrt{3}$	1	2.3	$\infty$
Liquid Conductivity (target)	5.0	R.	$\sqrt{3}$	0.64	1.8	$\infty$
Liquid Conductivity (meas.)	2.6	N	1	0.64	1.7	$\infty$
Liquid Permittivity (target)	5.0	R	$\sqrt{3}$	0.6	1.7	$\infty$
Liquid Permittivity (meas.)	3.8	N	1	0.6	2.3	$\infty$
<b>Combined Standard Uncertainty</b>					<b>10.4</b>	<b>330</b>
<b>Expanded Uncertainty <math>k_p = 2</math></b>						
<b>Coverage Factor for 95 %</b>					<b>20.8</b>	

The budget is valid for the frequency range 300 MHz - 3 GHz and represent a worst case analysis. For specific tests and configurations, the uncertainty could be considerable smaller.

### 3 Tissue and System Verification

#### 3.1 Tissue Verification

Dielectric parameters of the simulating liquids were verified using a Dielectric Probe Kit Agilent 85070D to a tolerance of  $\pm 5\%$ .

Room Temperature: 22.1 - 22.6 ° C

	Measured Tissue Parameters			
	900 MHz Head		1900 MHz Head	
	Target	Measured	Target	Measured
Date:		27.01.2009		27.01.2009
Liquid Temperature: ° C		22,1		22,0
Dielectric Constant: $\epsilon$	41,5	40,5	40,0	39,9
Conductivity: $\sigma$	0,97	0.944	1,40	1,42

Room Temperature: 22.1 - 22.6 ° C

	Measured Tissue Parameters			
	900 MHz Muscle		1900 MHz Muscle	
	Target	Measured	Target	Measured
Date:		28.01.2009		29.01.2009
Liquid Temperature: ° C		22,1		22,1
Dielectric Constant: $\epsilon$	55,0	54,1	53,3	51,9
Conductivity: $\sigma$	1,05	1,01	1,52	1,58



### 3.2 System Verification

Prior to the assessment, the system was verified by using a 1900 MHz validation dipole. Power level of 250 mW was supplied to the dipole antenna placed under the flat section of SAM Phantom. This system validation is valid for a frequency range of  $1900 \pm 100$  MHz.

The system was verified to a tolerance of  $\pm 10$  %.

**Liquid Temperature:** 22.0 - 22.3 °C  
**Room Temperature:** 22.1 - 22.6 °C  
**Liquid Depth:** >15.5 cm

System Dipole Validation Target & Measurement					
Date	System Validation Kit:	Liquid	Targeted SAR 1 g (mW/g)	Measured SAR 1 g (mW/g)	Deviation (%)
05.06.2008	D900V2 SN164	900 MHz Head	10,2	10,96	7,45
06.06.2008	D1900V2 SN5d025	1900 MHz Head	40,4	43,6	7,92
05.06.2008	D900V2 SN164	900 MHz Muscle	11,2	11,08	-1,07
09.06.2008	D1900V2 SN5d025	1900 MHz Muscle	45,6	45,60	0,00

Comment: Please find attached the measurement plots.

## 4 Test Results

### Procedures Used To Establish Test Signal

The EUT was placed into simulated call mode (e.g. AMPS, Cellular CDMA & PCS CDMA modes) using manufacturers test codes. Such test signals offer a consistent means for testing SAR and are recommended for evaluating SAR [2]. The actual transmission is activated through a base station simulator or similar when test modes are not available or inappropriate for testing the EUT.

The EUT is rechargeable battery operated. The battery used for the SAR measurements was completely charged. The device was tested at full power verified by implementing conducted output power measurements. For confirming of the output power it was tested before and after each SAR measurement. The test was repeated if a conducted power deviation of more than 5 % occurred.

**Frequency band:** GSM 850  
**Mixture Type:** 900 MHz Head  
**Date:** 27.01.2009  
**Liquid Temperature:** 22.0 - 22.3 °C **Room Temperature:** 22.1 - 22.6 °C

Frequency			Power Drift dBm	Antenna Pos.	Phantom Section	Test Position 0 mm	SAR (W/kg)
MHz	Channel	Modulation					
824,2	128	GSM	-0.182	Integral	Left Ear	Cheek	0.596
836,4	189	GSM	-0.160	Integral	Left Ear	Cheek	<b>1.13</b>
836,4	189	GSM	-0.130	Integral	Left Ear	Tilt	0.739
848,8	251	GSM	-0.131	Integral	Left Ear	Cheek	1.09
836,4	189	GSM	-0.090	Integral	Right Ear	Cheek	0.460
836,4	189	GSM	-0.011	Integral	Right Ear	Tilt	0.818

**Mixture Type:** 900 MHz Muscle  
**Date:** 28.01.2009  
**Liquid Temperature:** 22.0 - 22.3 °C **Room Temperature:** 22.1 - 22.6 °C

Frequency			Power Drift dBm	Antenna Pos.	Phantom Section	Test Position 0 mm	SAR (W/kg)
MHz	Channel	Modulation					
836,4	189	GSM	-0.174	Integral	Flat	Back	<b>0.865</b>
836,4	189	GSM	-0.069	Integral	Flat	Front	0.693

**Frequency band:** PCS 1900  
**Mixture Type:** 1900 MHz Head  
**Date:** 27.01.2009  
**Liquid Temperature:** 22.0 - 22.3 °C **Room Temperature:** 22.1 - 22.6 °C

Frequency			Power Drift dBm	Antenna Pos.	Phantom Section	Test Position 0 mm	SAR (W/kg)
MHz	Channel	Modulation					
1850,2	512	GSM	0.097	Integral	Left Ear	Cheek	<b>0.811</b>
1880,0	661	GSM	-0.127	Integral	Left ear	Cheek	0.625
1880,0	661	GSM	0.130	Integral	Left ear	Tilted	0.456
1909,8	810	GSM	-0.140	Integral	Left Ear	Cheek	0.544
1880,0	661	GSM	-0.001	Integral	Right Ear	Cheek	0.431
1880,0	661	GSM	-0.026	Integral	Right Ear	Tilted	0.345

Note: Upper and lower frequencies were measured at the worst position.

**Mixture Type:** 1900 MHz Muscle  
**Date:** 29.01.2009  
**Liquid Temperature:** 22.0 - 22.3 °C **Room Temperature:** 22.1 - 22.6 °C

Frequency			Power Drift dBm	Antenna Pos.	Phantom Section	Test Position 10 mm	SAR (W/kg)
MHz	Channel	Modulation					
1880,0	661	GSM	-0.196	Integral	Flat	Back	0.208
1880,0	661	GSM	-0.115	Integral	Flat	Front	<b>0.436</b>

**Frequency band:** GPRS 850  
**Mixture Type:** 900 MHz Muscle  
**Date:** 28.01.2009

Frequency			Power Drift dBm	Antenna Pos.	Phantom Section	Test Position 15 mm	SAR (W/kg)
MHz	Channel	Modulation					
824,2	128	GPRS	0.000	Integral	Flat	Back	0.817
836,4	189	GPRS	-0.147	Integral	Flat	Front	<b>1.30</b>
836,4	189	GPRS	-0.011	Integral	Flat	Back	1.13
848,8	251	GPRS	0.132	Integral	Flat	Back	1.17

**Frequency band:** GPRS 1900  
**Mixture Type:** 1900 MHz Muscle  
**Date:** 29.01.2009

Frequency			Power Drift dBm	Antenna Pos.	Phantom Section	Test Position 15 mm	SAR (W/kg)
MHz	Channel	Modulation					
1850,2	512	GPRS	-0.178	Integral	Flat	Back	0.759
1880,0	661	GPRS	-0.162	Integral	Flat	Front	0.699
1880,0	661	GPRS	0.127	Integral	Flat	Back	<b>0.780</b>
1909,8	810	GPRS	0.050	Integral	Flat	Back	0.701

Limits:

Exposure Limits	SAR (W/kg)					
	Uncontrolled Exposure/General Population Environment			Controlled Exposure/Occupational Environment		
Region	Australia	US	EU	Australia	US	EU
Spatial Average SAR (averaged over the whole body)	0.08	0.08	0.08	0.40	0.40	0.40
Spatial Peak SAR (averaged over any 1 g of tissue)	2.00	1.60	2.00	10.0	8.00	10.0
Spatial Peak SAR (Hands, Feet, Ankles, Wrist) (averaged over any 10 g of tissue)	4.00	4.00	4.00	20.0	20.0	20.0

Notes:

1. Test data represent the worst case SAR value and test procedure used are according to OET Bulletin 65, Supplement C (01-01).
2. All modes of operation were investigated.

## 5 References

- [1] ANSI/IEEE C95.3 - 1991, *IEEE Recommended Practice for the Measurement of Potentially Hazardous Electromagnetic fields, 300 kHz to 100 GHz*, New York: IEEE, Aug. 1992
- [2] Federal Communications Commission, OET Bulletin 65 (Edition 97-01), Supplement C (Edition 01-01), *Evaluating Compliance with FCC Guidelines for Human Exposure to Radiofrequency Electromagnetic Fields*, July 2001.
- [3] T. Schmid, O. Egger, N. Kuster, *Automated E-field scanning system for dosimetric assessments*, IEEE Transaction on Microwave Theory and Techniques, vol. 44, Jan. 1996, pp. 105-113.
- [4] W. Gander, *Computer mathematics*, Birkhaeuser, Basel, 1992.
- [5] W.H. Press, S.A. Teukolsky, W.T. Vetterling, and B.P. Flannery, *Numerical Recipes in C, The Art of Scientific Computing*, Second edition, Cambridge University Press, 1992.
- [6] IEEE Standards Coordinating Committee 34 – IEEE Std. 1528-2003, December 2003 *Recommended Practice for Determining the Peak Spatial-Average Absorption Rate (SAR in the Human Body Due to Wireless Communications Devices: Experimental Techniques*.
- [7] *DASY4 Dosimetric Assessment System Manual*; Draft; September 6, 2002; Schmid & Partner Engineering AG

## 6 Annex

1.	Annex A	Calibration Certificate	D1900V2 SN5d025 D900V2 SN164 ET3DV6 SN1711 DAE3V1-522	9 pages 9 pages 9 pages 5 pages
2.	Annex B	Measurement Plots		30 pages
3.	Annex C	Pictures		15 pages

## Annex A

### Calibration Certificate

Note:

The calibration cycle for SAR field probes and related equipment is determined to one year. According to Eurofins's internal quality management instruction based on EN 17025 the calibration cycle for other test equipment is determined to 2 years. Additionally, Eurofins has prolonged the calibration interval for SPEAG System Validation Dipoles by two additional years. These QM procedures are acknowledged by the accreditation bodies mentioned on page 3 of this report during several accreditation audits.





Accredited by the Swiss Federal Office of Metrology and Accreditation  
The Swiss Accreditation Service is one of the signatories to the EA  
Multilateral Agreement for the recognition of calibration certificates

Accreditation No.: **SCS 108**

Client **ETS Dr. Genz**

Certificate No: **D900V2-164\_Jul06**

## CALIBRATION CERTIFICATE

Object **D900V2 - SN: 164**

Calibration procedure(s) **QA CAL-05.v6  
Calibration procedure for dipole validation kits**

Calibration date: **July 28, 2006**

Condition of the calibrated item **In Tolerance**

This calibration certificate documents the traceability to national standards, which realize the physical units of measurements (SI).  
The measurements and the uncertainties with confidence probability are given on the following pages and are part of the certificate.

All calibrations have been conducted in the closed laboratory facility: environment temperature (22 ± 3)°C and humidity < 70%.

Calibration Equipment used (M&TE critical for calibration)

Primary Standards	ID #	Cal Date (Calibrated by, Certificate No.)	Scheduled Calibration
Power meter EPM-442A	GB37480704	04-Oct-05 (METAS, No. 251-00516)	Oct-06
Power sensor HP 8481A	US37292783	04-Oct-05 (METAS, No. 251-00516)	Oct-06
Reference 20 dB Attenuator	SN: 5086 (20g)	11-Aug-05 (METAS, No 251-00498)	Aug-06
Reference 10 dB Attenuator	SN: 5047.2 (10r)	11-Aug-05 (METAS, No 251-00498)	Aug-06
Reference Probe ET3DV6 (HF)	SN 1507	28-Oct-05 (SPEAG, No. ET3-1507_Oct05)	Oct-06
DAE4	SN 601	15-Dec-05 (SPEAG, No. DAE4-601_Dec05)	Dec-06
Secondary Standards	ID #	Check Date (in house)	Scheduled Check
Power sensor HP 8481A	MY41092317	18-Oct-02 (SPEAG, in house check Oct-05)	In house check: Oct-07
RF generator Agilent E4421B	MY41000675	11-May-05 (SPEAG, in house check Nov-05)	In house check: Nov-07
Network Analyzer HP 8753E	US37390585 S4206	18-Oct-01 (SPEAG, in house check Nov-05)	In house check: Nov-06

Calibrated by: **Claudio Leubler** (Name) **Laboratory Technician** (Function)  (Signature)

Approved by: **Fin Bornholt** (Name) **Technical Director** (Function)  (Signature)

Issued: August 3, 2006

This calibration certificate shall not be reproduced except in full without written approval of the laboratory.



Accredited by the Swiss Federal Office of Metrology and Accreditation  
The Swiss Accreditation Service is one of the signatories to the EA  
Multilateral Agreement for the recognition of calibration certificates

Accreditation No.: **SCS 108**

**Glossary:**

TSL	tissue simulating liquid
ConvF	sensitivity in TSL / NORM x,y,z
N/A	not applicable or not measured

**Calibration is Performed According to the Following Standards:**

- a) IEEE Std 1528-2003, "IEEE Recommended Practice for Determining the Peak Spatial-Averaged Specific Absorption Rate (SAR) in the Human Head from Wireless Communications Devices: Measurement Techniques", December 2003
- b) CENELEC EN 50361, "Basic standard for the measurement of Specific Absorption Rate related to human exposure to electromagnetic fields from mobile phones (300 MHz - 3 GHz), July 2001
- c) Federal Communications Commission Office of Engineering & Technology (FCC OET), "Evaluating Compliance with FCC Guidelines for Human Exposure to Radiofrequency Electromagnetic Fields; Additional Information for Evaluating Compliance of Mobile and Portable Devices with FCC Limits for Human Exposure to Radiofrequency Emissions", Supplement C (Edition 01-01) to Bulletin 65

**Additional Documentation:**

- d) DASY4 System Handbook

**Methods Applied and Interpretation of Parameters:**

- *Measurement Conditions:* Further details are available from the Validation Report at the end of the certificate. All figures stated in the certificate are valid at the frequency indicated.
- *Antenna Parameters with TSL:* The dipole is mounted with the spacer to position its feed point exactly below the center marking of the flat phantom section, with the arms oriented parallel to the body axis.
- *Feed Point Impedance and Return Loss:* These parameters are measured with the dipole positioned under the liquid filled phantom. The impedance stated is transformed from the measurement at the SMA connector to the feed point. The Return Loss ensures low reflected power. No uncertainty required.
- *Electrical Delay:* One-way delay between the SMA connector and the antenna feed point. No uncertainty required.
- *SAR measured:* SAR measured at the stated antenna input power.
- *SAR normalized:* SAR as measured, normalized to an input power of 1 W at the antenna connector.
- *SAR for nominal TSL parameters:* The measured TSL parameters are used to calculate the nominal SAR result.

## Measurement Conditions

DASY system configuration, as far as not given on page 1.

<b>DASY Version</b>	DASY4	V4.7
<b>Extrapolation</b>	Advanced Extrapolation	
<b>Phantom</b>	Modular Flat Phantom V4.9	
<b>Distance Dipole Center - TSL</b>	15 mm	with Spacer
<b>Zoom Scan Resolution</b>	dx, dy, dz = 5 mm	
<b>Frequency</b>	900 MHz $\pm$ 1 MHz	

## Head TSL parameters

The following parameters and calculations were applied.

	Temperature	Permittivity	Conductivity
<b>Nominal Head TSL parameters</b>	22.0 °C	41.5	0.97 mho/m
<b>Measured Head TSL parameters</b>	(22.0 $\pm$ 0.2) °C	39.9 $\pm$ 6 %	0.95 mho/m $\pm$ 6 %
<b>Head TSL temperature during test</b>	(23.2 $\pm$ 0.2) °C	---	----

## SAR result with Head TSL

<b>SAR averaged over 1 cm<sup>3</sup> (1 g) of Head TSL</b>	Condition	
SAR measured	250 mW input power	2.75 mW / g
SAR normalized	normalized to 1W	11.0 mW / g
SAR for nominal Head TSL parameters <sup>1</sup>	normalized to 1W	<b>10.9 mW / g <math>\pm</math> 17.0 % (k=2)</b>

<b>SAR averaged over 10 cm<sup>3</sup> (10 g) of Head TSL</b>	condition	
SAR measured	250 mW input power	1.76 mW / g
SAR normalized	normalized to 1W	7.04 mW / g
SAR for nominal Head TSL parameters <sup>1</sup>	normalized to 1W	<b>6.96 mW / g <math>\pm</math> 16.5 % (k=2)</b>

<sup>1</sup> Correction to nominal TSL parameters according to d), chapter "SAR Sensitivities"

## Body TSL parameters

The following parameters and calculations were applied.

	Temperature	Permittivity	Conductivity
Nominal Body TSL parameters	22.0 °C	55.0	1.05 mho/m
Measured Body TSL parameters	(22.0 ± 0.2) °C	54.2 ± 6 %	1.06 mho/m ± 6 %
Body TSL temperature during test	(23.5 ± 0.2) °C	---	---

## SAR result with Body TSL

SAR averaged over 1 cm <sup>3</sup> (1 g) of Body TSL	condition	
SAR measured	250 mW input power	2.71 mW / g
SAR normalized	normalized to 1W	10.8 mW / g
SAR for nominal Body TSL parameters <sup>2</sup>	normalized to 1W	10.7 mW / g ± 17.0 % (k=2)

SAR averaged over 10 cm <sup>3</sup> (10 g) of Body TSL	condition	
SAR measured	250 mW input power	1.76 mW / g
SAR normalized	normalized to 1W	7.04 mW / g
SAR for nominal Body TSL parameters <sup>2</sup>	normalized to 1W	6.96 mW / g ± 16.5 % (k=2)

---

<sup>2</sup> Correction to nominal TSL parameters according to d), chapter "SAR Sensitivities"

## Appendix

### Antenna Parameters with Head TSL

Impedance, transformed to feed point	49.1 $\Omega$ - 6.9 j $\Omega$
Return Loss	- 23.0 dB

### Antenna Parameters with Body TSL

Impedance, transformed to feed point	44.9 $\Omega$ - 9.2 j $\Omega$
Return Loss	- 19.1 dB

### General Antenna Parameters and Design

Electrical Delay (one direction)	1.407 ns
----------------------------------	----------

After long term use with 100W radiated power, only a slight warming of the dipole near the feedpoint can be measured.

The dipole is made of standard semirigid coaxial cable. The center conductor of the feeding line is directly connected to the second arm of the dipole. The antenna is therefore short-circuited for DC-signals.

No excessive force must be applied to the dipole arms, because they might bend or the soldered connections near the feedpoint may be damaged.

### Additional EUT Data

Manufactured by	SPEAG
Manufactured on	May 16, 2002

# DASY4 Validation Report for Head TSL

Date/Time: 28.07.2006 11:17:39

Test Laboratory: SPEAG, Zurich, Switzerland

**DUT: Dipole 900 MHz; Type: D900V2; Serial: D900V2 - SN:164**

Communication System: CW; Frequency: 900 MHz; Duty Cycle: 1:1

Medium: HSL 900 MHz;

Medium parameters used:  $f = 900 \text{ MHz}$ ;  $\sigma = 0.953 \text{ mho/m}$ ;  $\epsilon_r = 40.3$ ;  $\rho = 1000 \text{ kg/m}^3$

Phantom section: Flat Section

Measurement Standard: DASY4 (High Precision Assessment)

## DASY4 Configuration:

- Probe: ET3DV6 - SN1507 (HF); ConvF(5.8, 5.8, 5.8); Calibrated: 28.10.2005
- Sensor-Surface: 4mm (Mechanical Surface Detection)
- Electronics: DAE4 Sn601; Calibrated: 15.12.2005
- Phantom: Flat Phantom 4.9L; Type: QD000P49AA; ;
- Measurement SW: DASY4, V4.7 Build 44; Postprocessing SW: SEMCAD, V1.8 Build 171

**Pin = 250 mW; d = 10 mm/Zoom Scan (7x7x7)/Cube 0: Measurement grid: dx=5mm, dy=5mm, dz=5mm**

Reference Value = 57.7 V/m; Power Drift = 0.026 dB

Peak SAR (extrapolated) = 4.16 W/kg

**SAR(1 g) = 2.75 mW/g; SAR(10 g) = 1.76 mW/g**

Maximum value of SAR (measured) = 2.98 mW/g

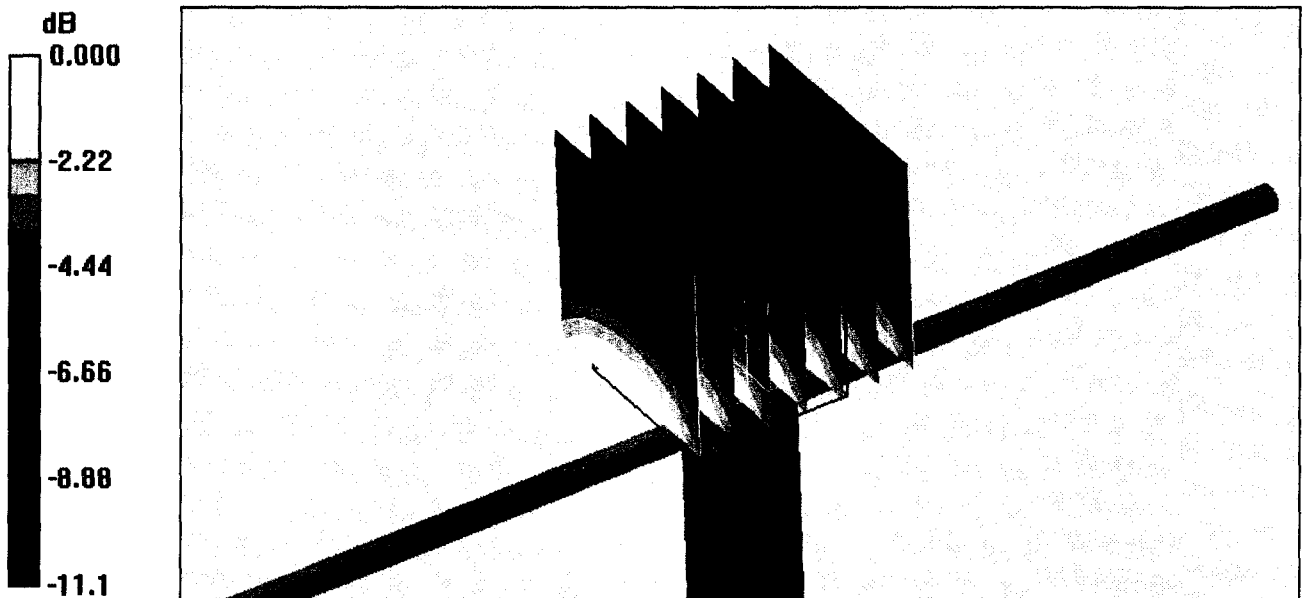

0 dB = 2.98mW/g

# Impedance Measurement Plot for Head TSL

28 Jul 2006 10:21:03

CH1 S11 1 U FS 1: 49.080  $\Omega$  -6.9375  $\Omega$  25.490 pF 900.000 000 MHz

\*  
De1  
Cor

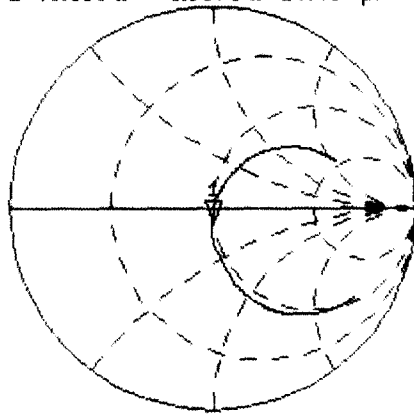

Avg  
16

CH2 S11 LOG 5 dB/REF -20 dB 1: -23.035 dB 900.000 000 MHz

Cor

Avg  
16

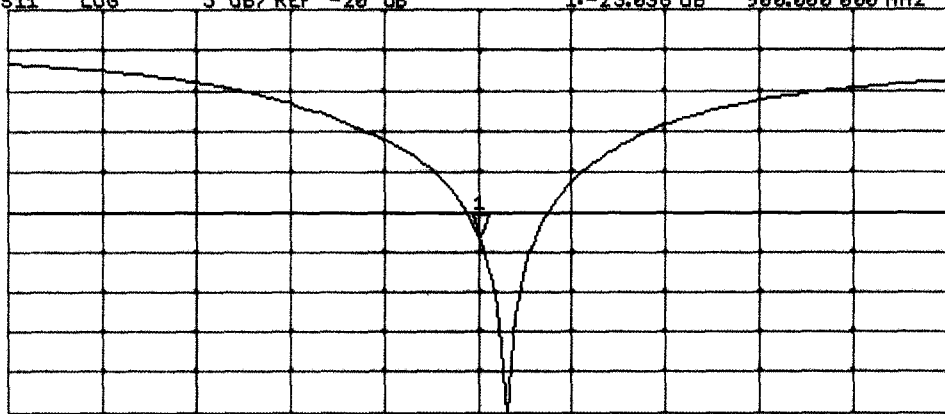

CENTER 900.000 000 MHz

SPAN 400.000 000 MHz

## DASY4 Validation Report for Body TSL

Date/Time: 28.07.2006 13:09:12

Test Laboratory: SPEAG, Zurich, Switzerland

**DUT: Dipole 900 MHz; Type: D900V2; Serial: D900V2 - SN:164**

Communication System: CW-900; Frequency: 900 MHz; Duty Cycle: 1:1

Medium: MSL 900;

Medium parameters used:  $f = 900$  MHz;  $\sigma = 1.05$  mho/m;  $\epsilon_r = 53.2$ ;  $\rho = 1000$  kg/m<sup>3</sup>

Phantom section: Flat Section

Measurement Standard: DASY4 (High Precision Assessment)

### DASY4 Configuration:

- Probe: ET3DV6 - SN1507 (HF); ConvF(5.76, 5.76, 5.76); Calibrated: 28.10.2005
- Sensor-Surface: 4mm (Mechanical Surface Detection)
- Electronics: DAE4 Sn601; Calibrated: 15.12.2005
- Phantom: Flat Phantom 4.9L; Type: QD000P49AA; ;
- Measurement SW: DASY4, V4.7 Build 44; Postprocessing SW: SEMCAD, V1.8 Build 171

**Pin = 250 mW; d = 15 mm/Zoom Scan (7x7x7)/Cube 0:**

Measurement grid: dx=5mm, dy=5mm, dz=5mm

Reference Value = 55.2 V/m; Power Drift = -0.020 dB

Peak SAR (extrapolated) = 3.97 W/kg

**SAR(1 g) = 2.71 mW/g; SAR(10 g) = 1.76 mW/g**

Maximum value of SAR (measured) = 2.95 mW/g

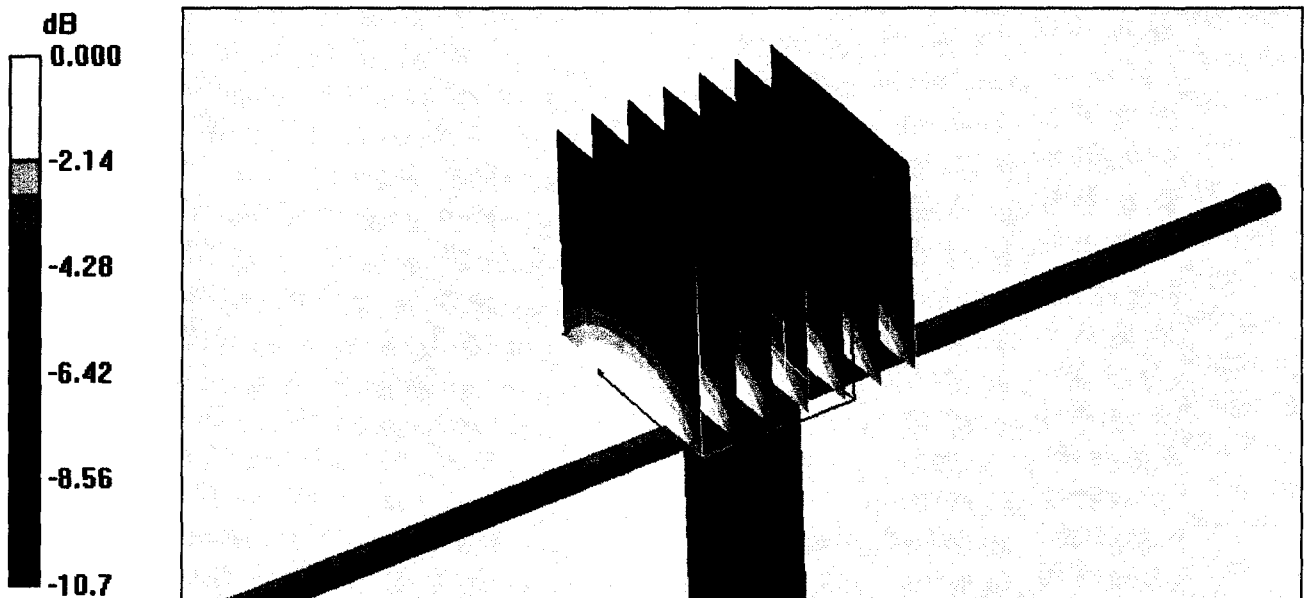

0 dB = 2.95mW/g



# Impedance Measurement Plot for Body TSL

28 Jul 2006 12:14:34

CH1 S11 1 U FS 1: 44.904  $\Omega$  -9.2090  $\Omega$  19.203 pF 900.000 000 MHz

\*  
Del  
Cor

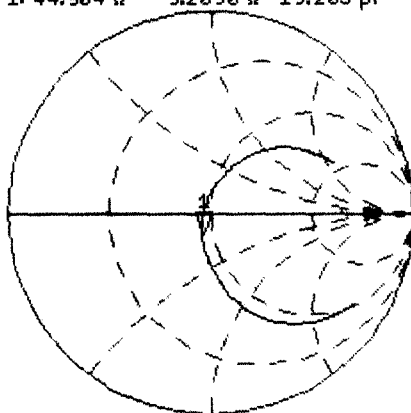

Avg  
16

↑

CH2 S11 LOG 5 dB/REF -20 dB 1: -19.142 dB 900.000 000 MHz

Cor

Avg  
16

↑

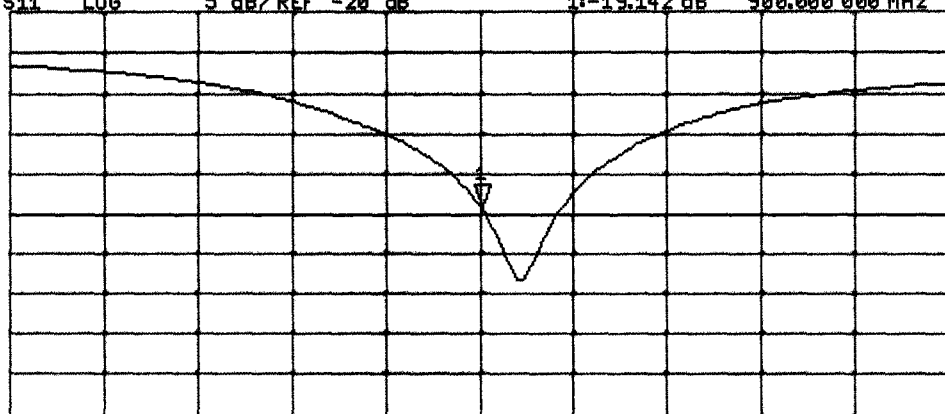

CENTER 900.000 000 MHz

SPAN 400.000 000 MHz



Accredited by the Swiss Federal Office of Metrology and Accreditation  
The Swiss Accreditation Service is one of the signatories to the EA  
Multilateral Agreement for the recognition of calibration certificates

Accreditation No.: **SCS 108**

Client **Dr. Goss**

Certificate No: **D1900V2-5d025\_Sep06**

**CALIBRATION CERTIFICATE**

Object **D1900V2 - SN: 5d025**

Calibration procedure(s) **QA CAL-05-v6  
Calibration procedure for dipole validation kits**

Calibration date: **September 26, 2006**

Condition of the calibrated item **In Tolerance**

This calibration certificate documents the traceability to national standards, which realize the physical units of measurements (SI).  
The measurements and the uncertainties with confidence probability are given on the following pages and are part of the certificate.

All calibrations have been conducted in the closed laboratory facility: environment temperature (22 ± 3)°C and humidity < 70%.

Calibration Equipment used (M&TE critical for calibration)

Primary Standards	ID #	Cal Date (Calibrated by, Certificate No.)	Scheduled Calibration
Power meter EPM-442A	GB37480704	04-Oct-05 (METAS, No. 251-00516)	Oct-06
Power sensor HP 8481A	US37292783	04-Oct-05 (METAS, No. 251-00516)	Oct-06
Reference 20 dB Attenuator	SN: 5086 (20g)	10-Aug-06 (METAS, No 217-00591)	Aug-07
Reference 10 dB Attenuator	SN: 5047.2 (10r)	10-Aug-06 (METAS, No 217-00591)	Aug-07
Reference Probe ET3DV6	SN: 1507	28-Oct-05 (SPEAG, No. ET3-1507_Oct05)	Oct-06
Reference Probe ES3DV3	SN: 3025	28-Oct-05 (SPEAG, No. ES3-3025_Oct05)	Oct-06
DAE4	SN: 601	15-Dec-05 (SPEAG, No. DAE4-601_Dec05)	Dec-06
Secondary Standards	ID #	Check Date (in house)	Scheduled Check
Power sensor HP 8481A	MY41092317	18-Oct-02 (SPEAG, in house check Oct-05)	In house check: Oct-07
RF generator Agilent E4421B	MY41000675	11-May-05 (SPEAG, in house check Nov-05)	In house check: Nov-07
Network Analyzer HP 8753E	US37390585 S4206	18-Oct-01 (SPEAG, in house check Nov-05)	In house check: Nov-06

Calibrated by: **Name: Marcel Fahr, Function: Laboratory Technician, Signature: [Signature]**

Approved by: **Name: Kata Pokovic, Function: Technical Manager, Signature: [Signature]**

Issued: September 27, 2006

This calibration certificate shall not be reproduced except in full without written approval of the laboratory.



Accredited by the Swiss Federal Office of Metrology and Accreditation  
The Swiss Accreditation Service is one of the signatories to the EA  
Multilateral Agreement for the recognition of calibration certificates

Accreditation No.: **SCS 108**

### Glossary:

TSL	tissue simulating liquid
ConvF	sensitivity in TSL / NORM x,y,z
N/A	not applicable or not measured

### Calibration is Performed According to the Following Standards:

- IEEE Std 1528-2003, "IEEE Recommended Practice for Determining the Peak Spatial-Averaged Specific Absorption Rate (SAR) in the Human Head from Wireless Communications Devices: Measurement Techniques", December 2003
- CENELEC EN 50361, "Basic standard for the measurement of Specific Absorption Rate related to human exposure to electromagnetic fields from mobile phones (300 MHz - 3 GHz), July 2001
- Federal Communications Commission Office of Engineering & Technology (FCC OET), "Evaluating Compliance with FCC Guidelines for Human Exposure to Radiofrequency Electromagnetic Fields; Additional Information for Evaluating Compliance of Mobile and Portable Devices with FCC Limits for Human Exposure to Radiofrequency Emissions", Supplement C (Edition 01-01) to Bulletin 65

### Additional Documentation:

- DASY4 System Handbook

### Methods Applied and Interpretation of Parameters:

- Measurement Conditions:** Further details are available from the Validation Report at the end of the certificate. All figures stated in the certificate are valid at the frequency indicated.
- Antenna Parameters with TSL:** The dipole is mounted with the spacer to position its feed point exactly below the center marking of the flat phantom section, with the arms oriented parallel to the body axis.
- Feed Point Impedance and Return Loss:** These parameters are measured with the dipole positioned under the liquid filled phantom. The impedance stated is transformed from the measurement at the SMA connector to the feed point. The Return Loss ensures low reflected power. No uncertainty required.
- Electrical Delay:** One-way delay between the SMA connector and the antenna feed point. No uncertainty required.
- SAR measured:** SAR measured at the stated antenna input power.
- SAR normalized:** SAR as measured, normalized to an input power of 1 W at the antenna connector.
- SAR for nominal TSL parameters:** The measured TSL parameters are used to calculate the nominal SAR result.

## Measurement Conditions

DASY system configuration, as far as not given on page 1.

<b>DASY Version</b>	DASY4	V4.7
<b>Extrapolation</b>	Advanced Extrapolation	
<b>Phantom</b>	Modular Flat Phantom V5.0	
<b>Distance Dipole Center - TSL</b>	10 mm	with Spacer
<b>Zoom Scan Resolution</b>	dx, dy, dz = 5 mm	
<b>Frequency</b>	1900 MHz ± 1 MHz	

## Head TSL parameters

The following parameters and calculations were applied.

	Temperature	Permittivity	Conductivity
<b>Nominal Head TSL parameters</b>	22.0 °C	40.0	1.40 mho/m
<b>Measured Head TSL parameters</b>	(22.0 ± 0.2) °C	38.6 ± 6 %	1.41 mho/m ± 6 %
<b>Head TSL temperature during test</b>	(21.6 ± 0.2) °C	---	---

## SAR result with Head TSL

<b>SAR averaged over 1 cm<sup>3</sup> (1 g) of Head TSL</b>	condition	
SAR measured	250 mW input power	9.65 mW / g
SAR normalized	normalized to 1W	38.6 mW / g
SAR for nominal Head TSL parameters <sup>1</sup>	normalized to 1W	<b>37.7 mW / g ± 17.0 % (k=2)</b>

<b>SAR averaged over 10 cm<sup>3</sup> (10 g) of Head TSL</b>	Condition	
SAR measured	250 mW input power	5.11 mW / g
SAR normalized	normalized to 1W	20.4 mW / g
SAR for nominal Head TSL parameters <sup>1</sup>	normalized to 1W	<b>20.1 mW / g ± 16.5 % (k=2)</b>

<sup>1</sup> Correction to nominal TSL parameters according to d), chapter "SAR Sensitivities"

## Body TSL parameters

The following parameters and calculations were applied.

	Temperature	Permittivity	Conductivity
<b>Nominal Body TSL parameters</b>	22.0 °C	53.3	1.52 mho/m
<b>Measured Body TSL parameters</b>	(22.0 ± 0.2) °C	52.7 ± 6 %	1.56 mho/m ± 6 %
<b>Body TSL temperature during test</b>	(22.4 ± 0.2) °C	---	---

## SAR result with Body TSL

<b>SAR averaged over 1 cm<sup>3</sup> (1 g) of Body TSL</b>	Condition	
SAR measured	250 mW input power	10.2 mW / g
SAR normalized	normalized to 1W	40.8 mW / g
SAR for nominal Body TSL parameters <sup>2</sup>	normalized to 1W	<b>39.9 mW / g ± 17.0 % (k=2)</b>

<b>SAR averaged over 10 cm<sup>3</sup> (10 g) of Body TSL</b>	condition	
SAR measured	250 mW input power	5.40 mW / g
SAR normalized	normalized to 1W	21.6 mW / g
SAR for nominal Body TSL parameters <sup>2</sup>	normalized to 1W	<b>21.3 mW / g ± 16.5 % (k=2)</b>

<sup>2</sup> Correction to nominal TSL parameters according to d), chapter "SAR Sensitivities"

## Appendix

### Antenna Parameters with Head TSL

Impedance, transformed to feed point	$53.8 \Omega + 4.5 j\Omega$
Return Loss	- 24.9 dB

### Antenna Parameters with Body TSL

Impedance, transformed to feed point	$47.3 \Omega + 3.9 j\Omega$
Return Loss	- 26.3 dB

### General Antenna Parameters and Design

Electrical Delay (one direction)	1.198 ns
----------------------------------	----------

After long term use with 100W radiated power, only a slight warming of the dipole near the feedpoint can be measured.

The dipole is made of standard semirigid coaxial cable. The center conductor of the feeding line is directly connected to the second arm of the dipole. The antenna is therefore short-circuited for DC-signals.

No excessive force must be applied to the dipole arms, because they might bend or the soldered connections near the feedpoint may be damaged.

### Additional EUT Data

Manufactured by	SPEAG
Manufactured on	July 29, 2002

## DASY4 Validation Report for Head TSL

Date/Time: 26.09.2006 13:01:39

Test Laboratory: SPEAG, Zurich, Switzerland

**DUT: Dipole 1900 MHz; Type: D1900V2; Serial: D1900V2 - SN:5d025**

Communication System: CW; Frequency: 1900 MHz; Duty Cycle: 1:1

Medium: HSL U10 BB;

Medium parameters used:  $f = 1900$  MHz;  $\sigma = 1.41$  mho/m;  $\epsilon_r = 38.6$ ;  $\rho = 1000$  kg/m<sup>3</sup>

Phantom section: Flat Section

Measurement Standard: DASY4 (High Precision Assessment)

DASY4 Configuration:

- Probe: ET3DV6 - SN1507 (HF); ConvF(4.74, 4.74, 4.74); Calibrated: 28.10.2005
- Sensor-Surface: 4mm (Mechanical Surface Detection)
- Electronics: DAE4 Sn601; Calibrated: 15.12.2005
- Phantom: Flat Phantom 5.0 (front); Type: QD000P50AA; ;
- Measurement SW: DASY4, V4.7 Build 44; Postprocessing SW: SEMCAD, V1.8 Build 171

**Pin = 250 mW; d = 10 mm/Zoom Scan (7x7x7)/Cube 0:**

Measurement grid: dx=5mm, dy=5mm, dz=5mm

Reference Value = 93.1 V/m; Power Drift = 0.007 dB

Peak SAR (extrapolated) = 16.4 W/kg

**SAR(1 g) = 9.65 mW/g; SAR(10 g) = 5.11 mW/g**

Maximum value of SAR (measured) = 10.8 mW/g

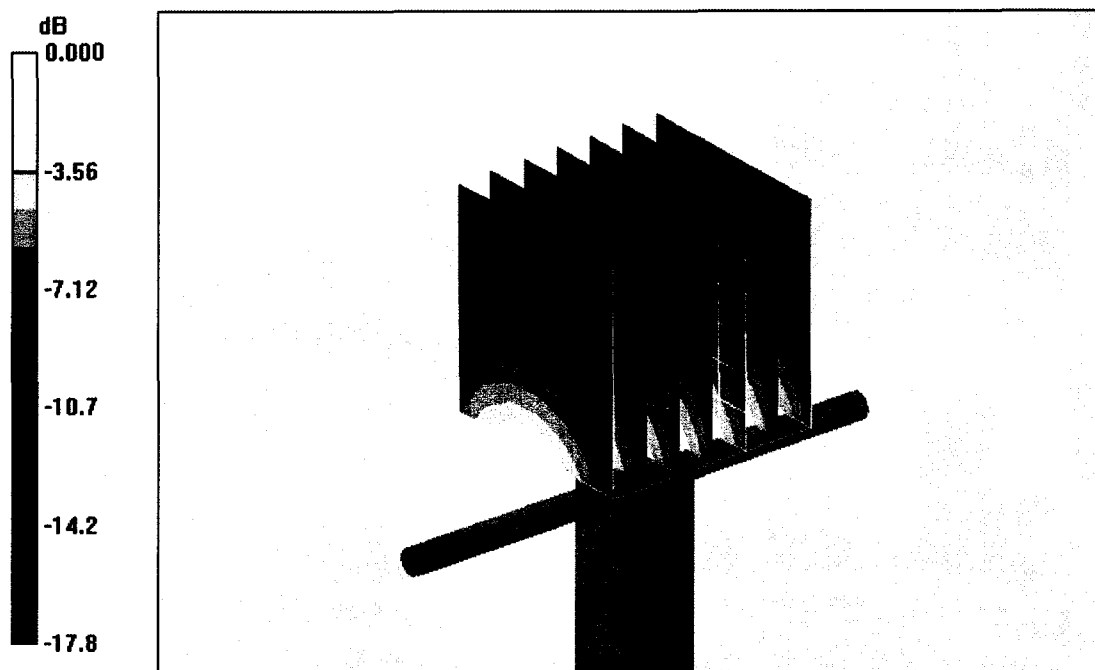

0 dB = 10.8mW/g

# Impedance Measurement Plot for Head TSL

26 Sep 2006 10:54:38

CH1 S11 1 U FS 2: 53.809  $\Omega$  4.5234  $\Omega$  378.91 pF 1 900.000 000 MHz

\*  
Del  
Cor

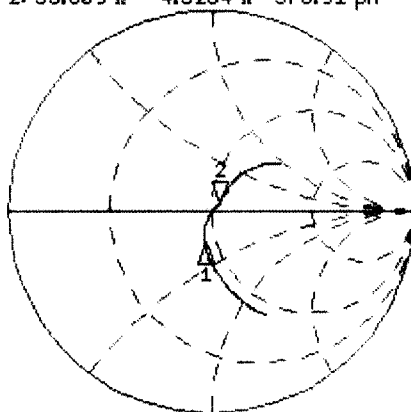

CH1 Markers  
1: 44.619  $\Omega$   
-14.439  $\Omega$   
1.80000 GHz

Avg  
16  
↑

CH2 S11 LOG 7 dB/REF -20 dB 2: -24.895 dB 1 900.000 000 MHz

Cor  
Avg  
16  
↑

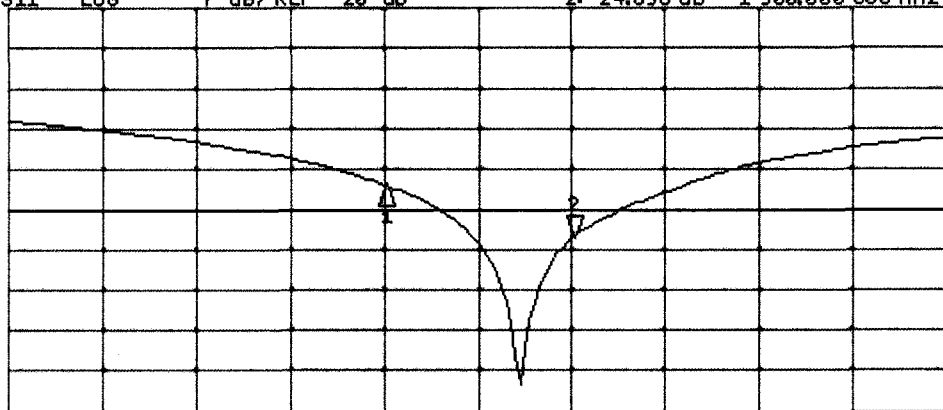

CH2 Markers  
1: -15.863 dB  
1.80000 GHz

START 1 500.000 000 MHz

STOP 2 100.000 000 MHz



## DASY4 Validation Report for Body TSL

Date/Time: 20.09.2006 11:37:46

Test Laboratory: SPEAG, Zurich, Switzerland

**DUT: Dipole 1900 MHz; Type: D1900V2; Serial: D1900V2 - SN:5d025**

Communication System: CW; Frequency: 1900 MHz; Duty Cycle: 1:1

Medium: MSL U10;

Medium parameters used:  $f = 1900$  MHz;  $\sigma = 1.56$  mho/m;  $\epsilon_r = 52.7$ ;  $\rho = 1000$  kg/m<sup>3</sup>

Phantom section: Flat Section

Measurement Standard: DASY4 (High Precision Assessment)

### DASY4 Configuration:

- Probe: ES3DV2 - SN3025 (HF); ConvF(4.38, 4.38, 4.38); Calibrated: 28.10.2005
- Sensor-Surface: 4mm (Mechanical Surface Detection)
- Electronics: DAE4 Sn601; Calibrated: 15.12.2005
- Phantom: Flat Phantom 5.0 (front); Type: QD000P50AA; ;
- Measurement SW: DASY4, V4.7 Build 44; Postprocessing SW: SEMCAD, V1.8 Build 171

**Pin = 250 mW; d = 10 mm/Zoom Scan (7x7x7)/Cube 0:**

Measurement grid: dx=5mm, dy=5mm, dz=5mm

Reference Value = 86.5 V/m; Power Drift = 0.034 dB

Peak SAR (extrapolated) = 16.8 W/kg

**SAR(1 g) = 10.2 mW/g; SAR(10 g) = 5.4 mW/g**

Maximum value of SAR (measured) = 11.3 mW/g

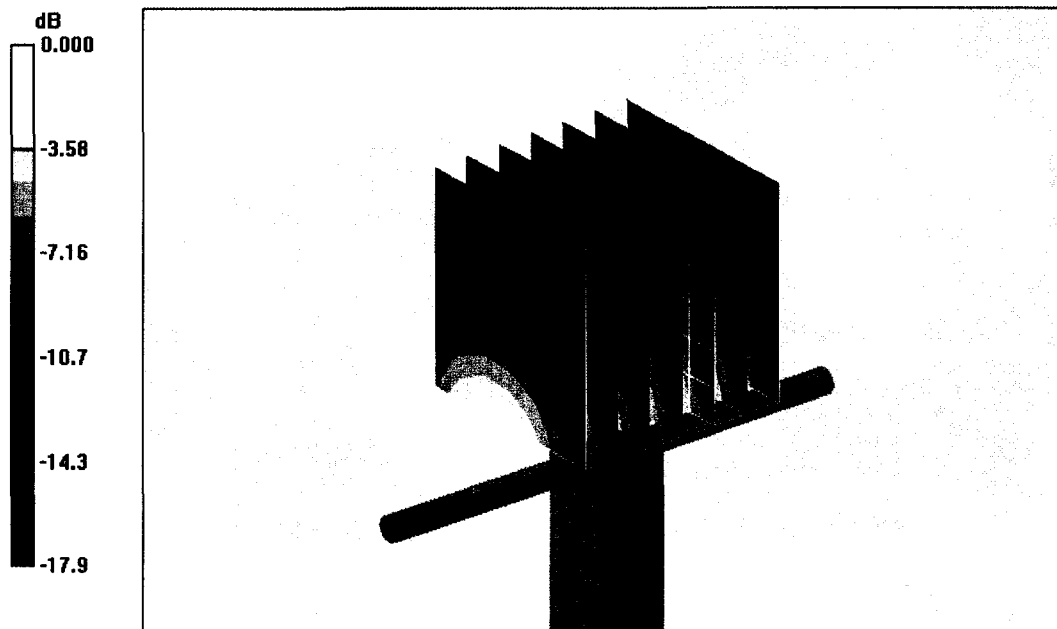

0 dB = 11.3mW/g

# Impedance Measurement Plot for Body TSL

20 Sep 2006 10:07:25

CH1 S11 1 U FS 1: 47.287  $\Omega$  3.8848  $\Omega$  325.41  $\mu$ H 1 900.000 000 MHz

\*  
Del  
Cor  
Avg  
16

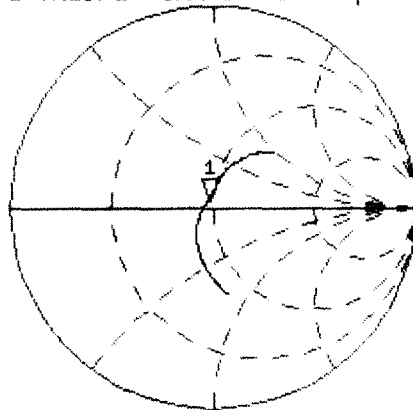

CH2 S11 LOG 3 dB/REF -20 dB 1:-26.259 dB 1 900.000 000 MHz

Cor  
Avg  
16

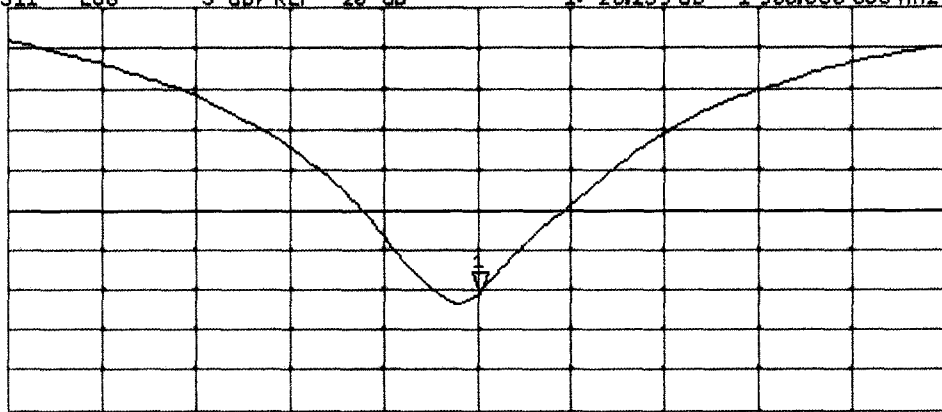

CENTER 1 900.000 000 MHz

SPAN 400.000 000 MHz



Accredited by the Swiss Accreditation Service (SAS)  
The Swiss Accreditation Service is one of the signatories to the EA  
Multilateral Agreement for the recognition of calibration certificates

Accreditation No.: **SCS 108**

Client **Eurofins**

Certificate No: **ET3-1711\_Sep08**

**CALIBRATION CERTIFICATE**

Object **ET3DV6 - SN:1711**

Calibration procedure(s) **QA-CAL-01-v6, QA-CAL-12-v5 and QA-CAL-23-v3  
Calibration procedure for dosimetric E-field probes**

Calibration date: **September 17, 2008**

Condition of the calibrated item **In Tolerance**

This calibration certificate documents the traceability to national standards, which realize the physical units of measurements (SI).  
The measurements and the uncertainties with confidence probability are given on the following pages and are part of the certificate.

All calibrations have been conducted in the closed laboratory facility: environment temperature (22 ± 3)°C and humidity < 70%.

Calibration Equipment used (M&TE critical for calibration)

Primary Standards	ID #	Cal Date (Certificate No.)	Scheduled Calibration
Power meter E4419B	GB41293874	1-Apr-08 (No. 217-00788)	Apr-09
Power sensor E4412A	MY41495277	1-Apr-08 (No. 217-00788)	Apr-09
Power sensor E4412A	MY41498087	1-Apr-08 (No. 217-00788)	Apr-09
Reference 3 dB Attenuator	SN: S5054 (3c)	1-Jul-08 (No. 217-00865)	Jul-09
Reference 20 dB Attenuator	SN: S5086 (20b)	31-Mar-08 (No. 217-00787)	Apr-09
Reference 30 dB Attenuator	SN: S5129 (30b)	1-Jul-08 (No. 217-00866)	Jul-09
Reference Probe ES3DV2	SN: 3013	2-Jan-08 (No. ES3-3013_Jan08)	Jan-09
DAE4	SN: 660	9-Sep-08 (No. DAE4-660_Sep08)	Sep-09
Secondary Standards	ID #	Check Date (in house)	Scheduled Check
RF generator HP 8648C	US3642U01700	4-Aug-99 (in house check Oct-07)	In house check: Oct-09
Network Analyzer HP 8753E	US37390585	18-Oct-01 (in house check Oct-07)	In house check: Oct-08

Calibrated by:	Name	Function	Signature
	Katja Pokovic	Technical Manager	
Approved by:	Name	Function	Signature
	Niels Kuster	Quality Manager	

Issued: September 17, 2008

This calibration certificate shall not be reproduced except in full without written approval of the laboratory.



Accredited by the Swiss Accreditation Service (SAS)  
The Swiss Accreditation Service is one of the signatories to the EA  
Multilateral Agreement for the recognition of calibration certificates

Accreditation No.: **SCS 108**

### Glossary:

TSL	tissue simulating liquid
NORM <sub>x,y,z</sub>	sensitivity in free space
ConvF	sensitivity in TSL / NORM <sub>x,y,z</sub>
DCP	diode compression point
Polarization $\varphi$	$\varphi$ rotation around probe axis
Polarization $\vartheta$	$\vartheta$ rotation around an axis that is in the plane normal to probe axis (at measurement center), i.e., $\vartheta = 0$ is normal to probe axis

### Calibration is Performed According to the Following Standards:

- IEEE Std 1528-2003, "IEEE Recommended Practice for Determining the Peak Spatial-Averaged Specific Absorption Rate (SAR) in the Human Head from Wireless Communications Devices: Measurement Techniques", December 2003
- IEC 62209-1, "Procedure to measure the Specific Absorption Rate (SAR) for hand-held devices used in close proximity to the ear (frequency range of 300 MHz to 3 GHz)", February 2005

### Methods Applied and Interpretation of Parameters:

- NORM<sub>x,y,z</sub>**: Assessed for E-field polarization  $\vartheta = 0$  ( $f \leq 900$  MHz in TEM-cell;  $f > 1800$  MHz: R22 waveguide). NORM<sub>x,y,z</sub> are only intermediate values, i.e., the uncertainties of NORM<sub>x,y,z</sub> does not effect the E<sup>2</sup>-field uncertainty inside TSL (see below *ConvF*).
- NORM(f)<sub>x,y,z</sub> = NORM<sub>x,y,z</sub> \* frequency\_response** (see Frequency Response Chart). This linearization is implemented in DASY4 software versions later than 4.2. The uncertainty of the frequency response is included in the stated uncertainty of *ConvF*.
- DCP<sub>x,y,z</sub>**: DCP are numerical linearization parameters assessed based on the data of power sweep (no uncertainty required). DCP does not depend on frequency nor media.
- ConvF and Boundary Effect Parameters**: Assessed in flat phantom using E-field (or Temperature Transfer Standard for  $f \leq 800$  MHz) and inside waveguide using analytical field distributions based on power measurements for  $f > 800$  MHz. The same setups are used for assessment of the parameters applied for boundary compensation (alpha, depth) of which typical uncertainty values are given. These parameters are used in DASY4 software to improve probe accuracy close to the boundary. The sensitivity in TSL corresponds to NORM<sub>x,y,z</sub> \* ConvF whereby the uncertainty corresponds to that given for ConvF. A frequency dependent ConvF is used in DASY version 4.4 and higher which allows extending the validity from  $\pm 50$  MHz to  $\pm 100$  MHz.
- Spherical isotropy (3D deviation from isotropy)**: in a field of low gradients realized using a flat phantom exposed by a patch antenna.
- Sensor Offset**: The sensor offset corresponds to the offset of virtual measurement center from the probe tip (on probe axis). No tolerance required.

# Probe ET3DV6

## SN:1711

Manufactured:	August 7, 2002
Last calibrated:	September 19, 2007
Recalibrated:	September 17, 2008

Calibrated for DASY Systems

(Note: non-compatible with DASY2 system!)

**DASY - Parameters of Probe: ET3DV6 SN:1711****Sensitivity in Free Space<sup>A</sup>****Diode Compression<sup>B</sup>**

NormX	1.92 ± 10.1%	$\mu\text{V}/(\text{V}/\text{m})^2$	DCP X	90 mV
NormY	1.86 ± 10.1%	$\mu\text{V}/(\text{V}/\text{m})^2$	DCP Y	93 mV
NormZ	2.04 ± 10.1%	$\mu\text{V}/(\text{V}/\text{m})^2$	DCP Z	92 mV

**Sensitivity in Tissue Simulating Liquid (Conversion Factors)**

Please see Page 8.

**Boundary Effect**

**TSL                      900 MHz      Typical SAR gradient: 5 % per mm**

Sensor Center to Phantom Surface Distance		<b>3.7 mm</b>	<b>4.7 mm</b>
SAR <sub>be</sub> [%]	Without Correction Algorithm	9.8	5.8
SAR <sub>be</sub> [%]	With Correction Algorithm	0.9	0.2

**TSL                      1810 MHz      Typical SAR gradient: 10 % per mm**

Sensor Center to Phantom Surface Distance		<b>3.7 mm</b>	<b>4.7 mm</b>
SAR <sub>be</sub> [%]	Without Correction Algorithm	10.4	6.5
SAR <sub>be</sub> [%]	With Correction Algorithm	0.8	0.4

**Sensor Offset**

Probe Tip to Sensor Center                      **2.7 mm**

**The reported uncertainty of measurement is stated as the standard uncertainty of measurement multiplied by the coverage factor k=2, which for a normal distribution corresponds to a coverage probability of approximately 95%.**

<sup>A</sup> The uncertainties of NormX,Y,Z do not affect the E<sup>2</sup>-field uncertainty inside TSL (see Page 8).

<sup>B</sup> Numerical linearization parameter: uncertainty not required.

# Frequency Response of E-Field

(TEM-Cell: ifi110 EXX, Waveguide: R22)

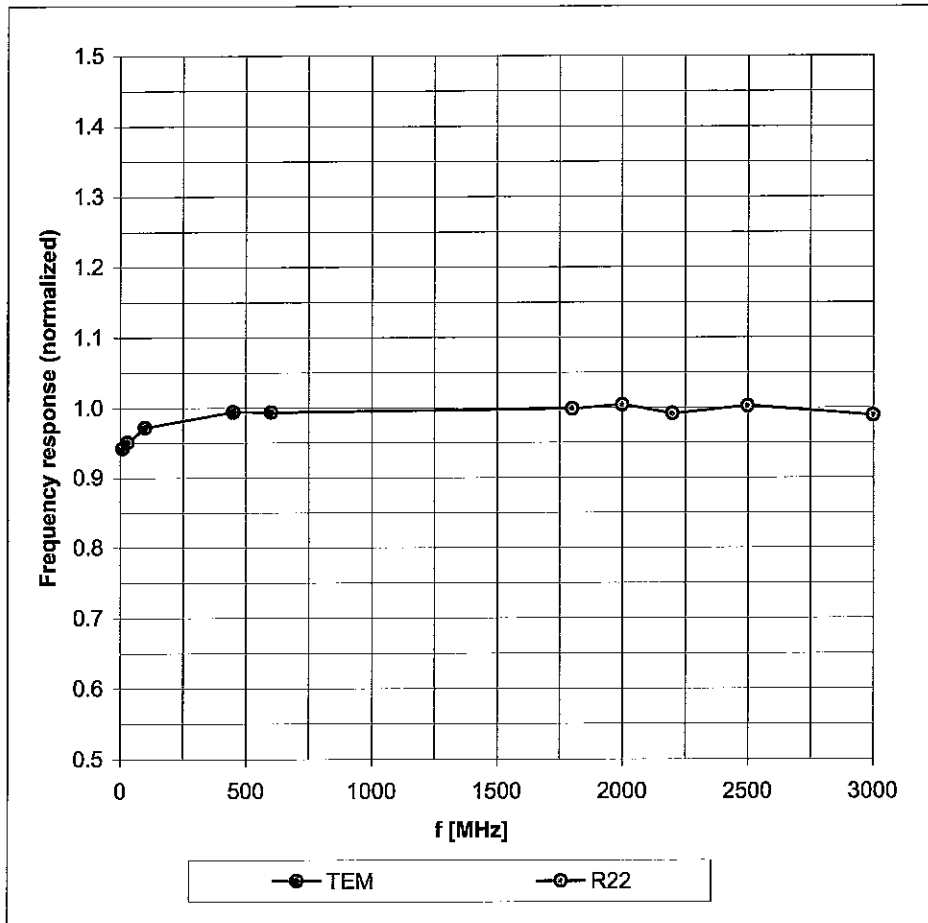

Uncertainty of Frequency Response of E-field:  $\pm 6.3\%$  (k=2)

### Receiving Pattern ( $\phi$ ), $\theta = 0^\circ$

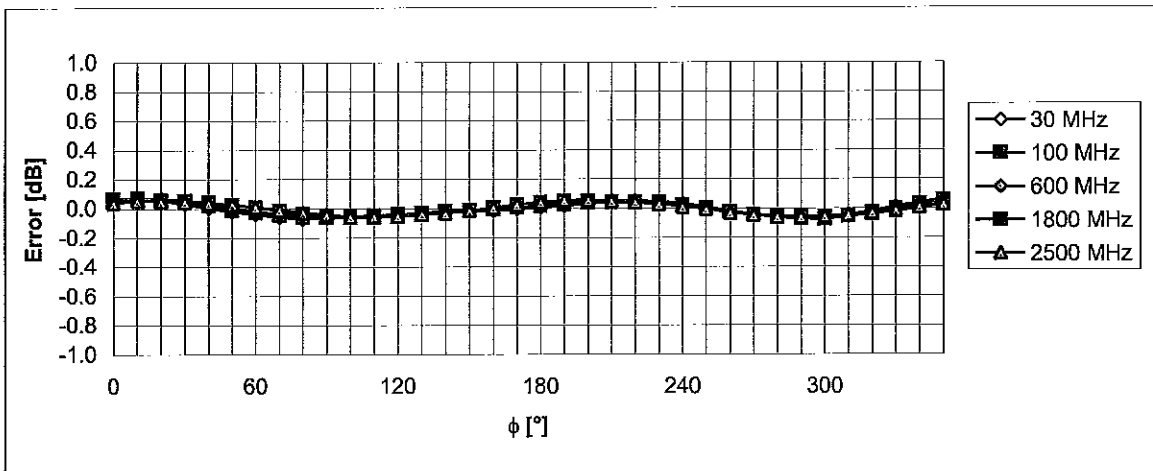
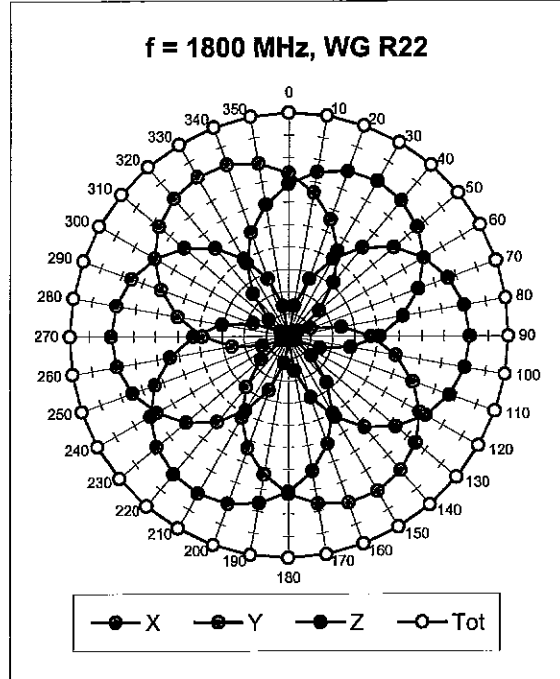
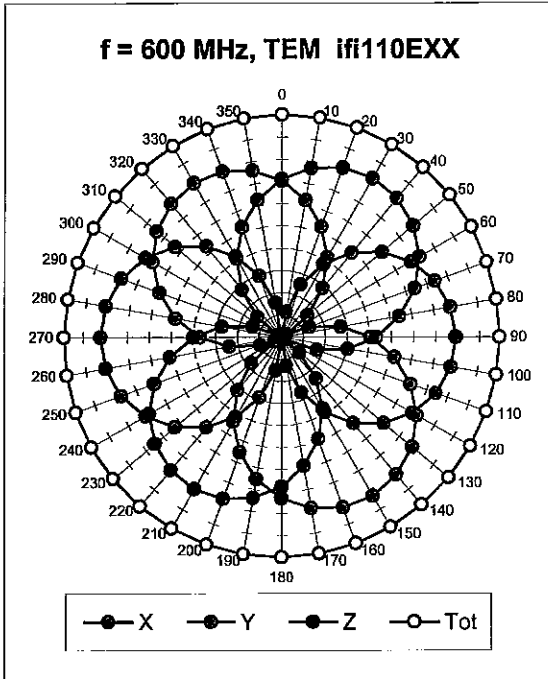

Uncertainty of Axial Isotropy Assessment:  $\pm 0.5\%$  ( $k=2$ )



### Dynamic Range $f(\text{SAR}_{\text{head}})$ (Waveguide R22, $f = 1800 \text{ MHz}$ )

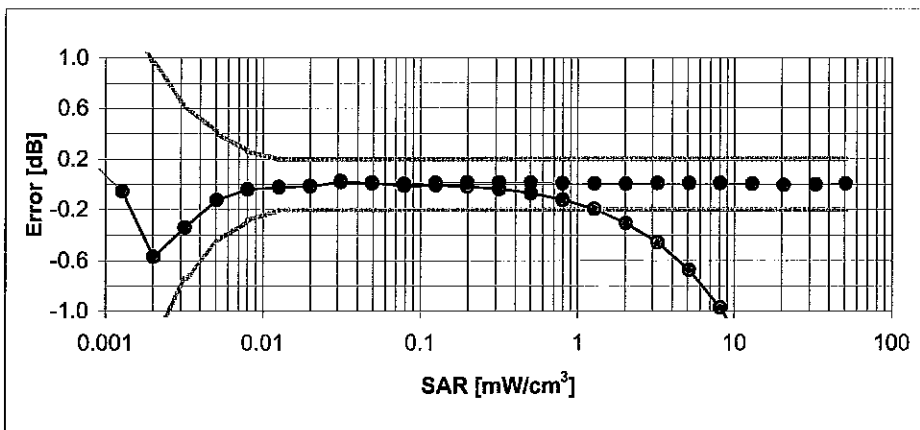
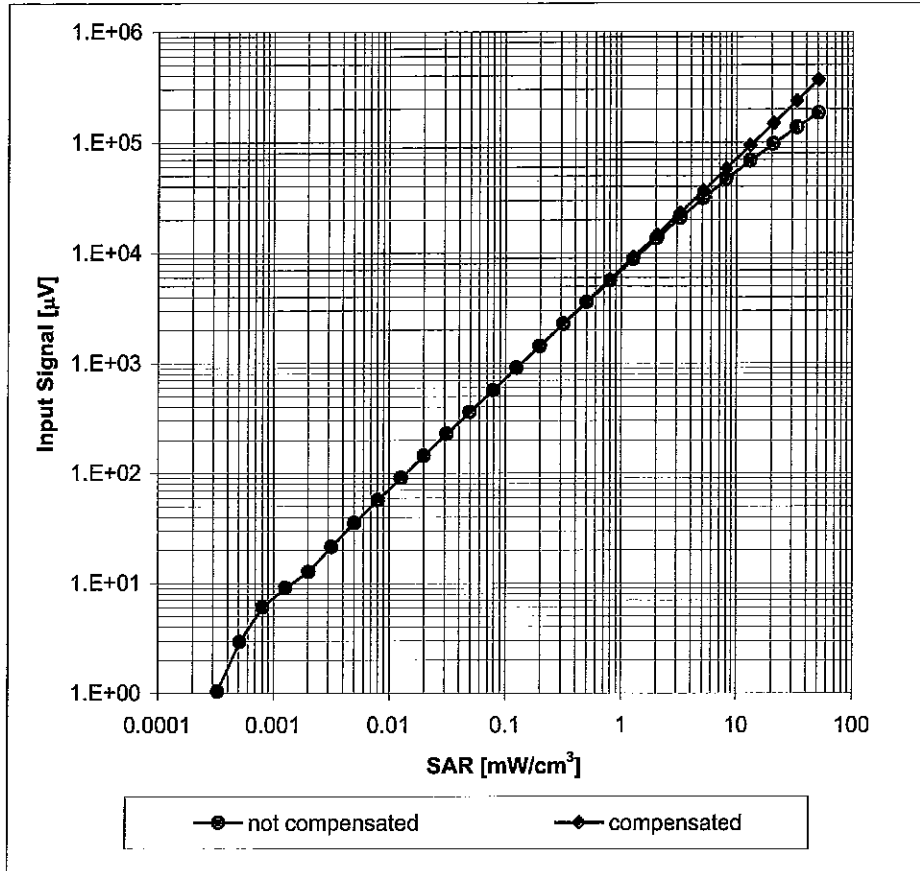

Uncertainty of Linearity Assessment:  $\pm 0.6\%$  ( $k=2$ )

## Conversion Factor Assessment

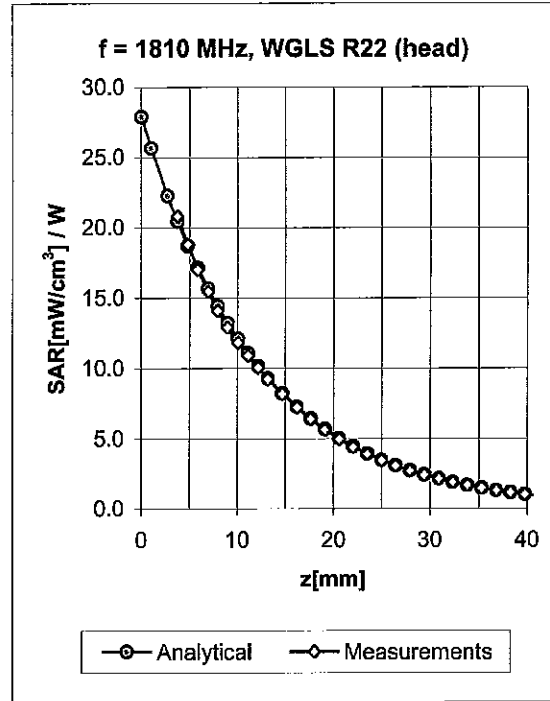
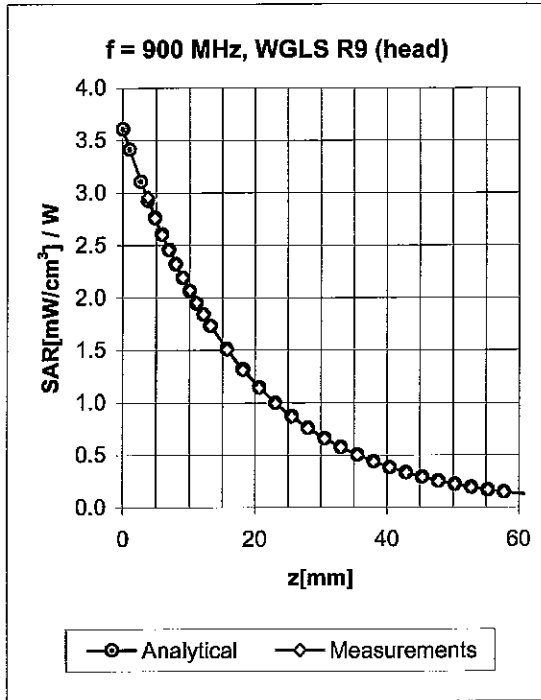

f [MHz]	Validity [MHz] <sup>c</sup>	TSL	Permittivity	Conductivity	Alpha	Depth	ConvF Uncertainty
450	± 50 / ± 100	Head	43.5 ± 5%	0.87 ± 5%	0.34	1.75	7.42 ± 13.3% (k=2)
900	± 50 / ± 100	Head	41.5 ± 5%	0.97 ± 5%	0.30	2.88	6.17 ± 11.0% (k=2)
1810	± 50 / ± 100	Head	40.0 ± 5%	1.40 ± 5%	0.67	1.95	5.17 ± 11.0% (k=2)
1950	± 50 / ± 100	Head	40.0 ± 5%	1.40 ± 5%	0.79	1.69	4.96 ± 11.0% (k=2)
2450	± 50 / ± 100	Head	39.2 ± 5%	1.80 ± 5%	0.85	1.50	4.55 ± 11.0% (k=2)
450	± 50 / ± 100	Body	56.7 ± 5%	0.94 ± 5%	0.28	1.82	7.91 ± 13.3% (k=2)
900	± 50 / ± 100	Body	55.0 ± 5%	1.05 ± 5%	0.38	2.65	6.01 ± 11.0% (k=2)
1810	± 50 / ± 100	Body	53.3 ± 5%	1.52 ± 5%	0.70	2.03	4.57 ± 11.0% (k=2)
1950	± 50 / ± 100	Body	53.3 ± 5%	1.52 ± 5%	0.76	1.82	4.51 ± 11.0% (k=2)
2450	± 50 / ± 100	Body	52.7 ± 5%	1.95 ± 5%	0.85	1.55	3.81 ± 11.0% (k=2)

<sup>c</sup> The validity of ± 100 MHz only applies for DASY v4.4 and higher (see Page 2). The uncertainty is the RSS of the ConvF uncertainty at calibration frequency and the uncertainty for the indicated frequency band.

## Deviation from Isotropy in HSL

Error ( $\phi, \vartheta$ ),  $f = 900$  MHz

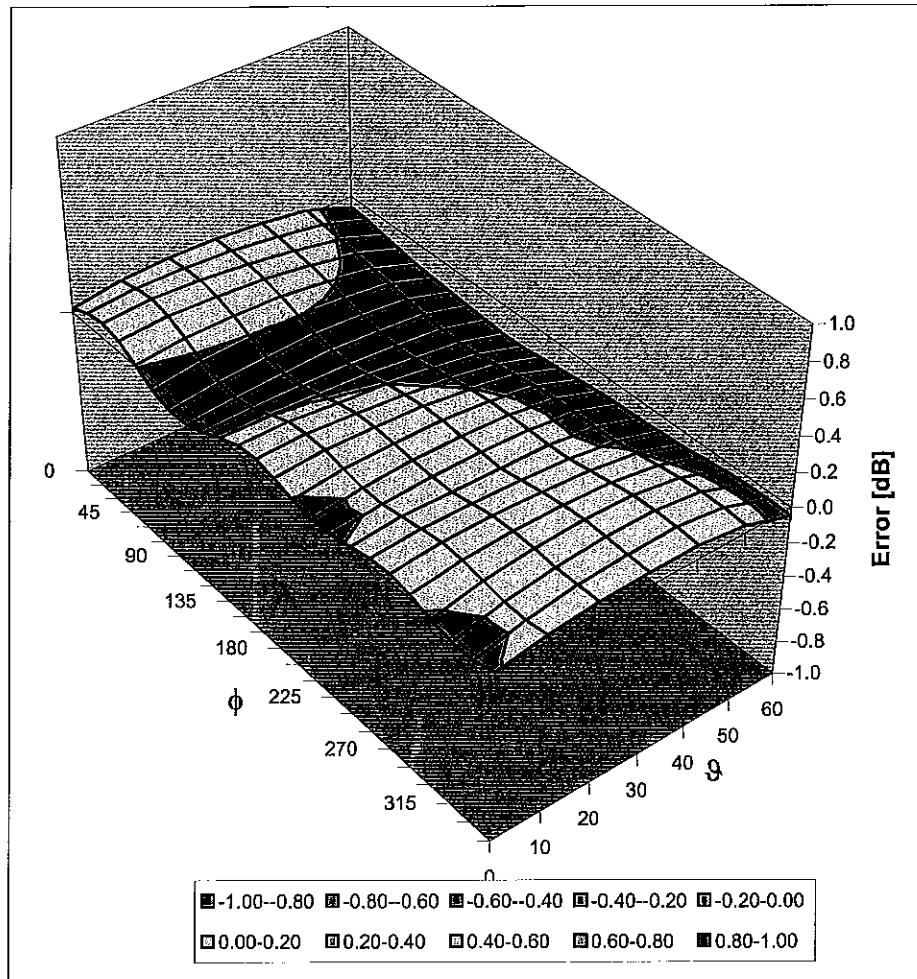

Uncertainty of Spherical Isotropy Assessment:  $\pm 2.6\%$  ( $k=2$ )



Accredited by the Swiss Accreditation Service (SAS)  
The Swiss Accreditation Service is one of the signatories to the EA  
Multilateral Agreement for the recognition of calibration certificates

Accreditation No.: **SCS 108**

Client **Eurofins**

Certificate No: **DAE3-522\_Sep08**

## CALIBRATION CERTIFICATE

Object **DAE3 - SD 000 D03 AA - SN: 522**

Calibration procedure(s) **QA-CAL-06 v12  
Calibration procedure for the data acquisition electronics (DAE)**

Calibration date: **September 16, 2008**

Condition of the calibrated item **In Tolerance**

This calibration certificate documents the traceability to national standards, which realize the physical units of measurements (SI).  
The measurements and the uncertainties with confidence probability are given on the following pages and are part of the certificate.

All calibrations have been conducted in the closed laboratory facility: environment temperature (22 ± 3)°C and humidity < 70%.

Calibration Equipment used (M&TE critical for calibration)

Primary Standards	ID #	Cal Date (Certificate No.)	Scheduled Calibration
Fluke Process Calibrator Type 702	SN: 6295803	04-Oct-07 (No: 6467)	Oct-08
Keithley Multimeter Type 2001	SN: 0810278	03-Oct-07 (No: 6465)	Oct-08
Secondary Standards	ID #	Check Date (in house)	Scheduled Check
Calibrator Box V1.1	SE UMS 006 AB 1004	06-Jun-08 (in house check)	In house check: Jun-09

Calibrated by:	Name <b>Andrea Guntli</b>	Function <b>Technician</b>	Signature 
Approved by:	Name <b>Fin Bomholt</b>	Function <b>R&amp;D Director</b>	Signature 

Issued: September 16, 2008

This calibration certificate shall not be reproduced except in full without written approval of the laboratory.



Accredited by the Swiss Accreditation Service (SAS)  
The Swiss Accreditation Service is one of the signatories to the EA  
Multilateral Agreement for the recognition of calibration certificates

Accreditation No.: **SCS 108**

## Glossary

DAE data acquisition electronics  
Connector angle information used in DASY system to align probe sensor X to the robot coordinate system.

## Methods Applied and Interpretation of Parameters

- *DC Voltage Measurement:* Calibration Factor assessed for use in DASY system by comparison with a calibrated instrument traceable to national standards. The figure given corresponds to the full scale range of the voltmeter in the respective range.
- *Connector angle:* The angle of the connector is assessed measuring the angle mechanically by a tool inserted. Uncertainty is not required.
- The following parameters as documented in the Appendix contain technical information as a result from the performance test and require no uncertainty.
  - *DC Voltage Measurement Linearity:* Verification of the Linearity at +10% and -10% of the nominal calibration voltage. Influence of offset voltage is included in this measurement.
  - *Common mode sensitivity:* Influence of a positive or negative common mode voltage on the differential measurement.
  - *Channel separation:* Influence of a voltage on the neighbor channels not subject to an input voltage.
  - *AD Converter Values with inputs shorted:* Values on the internal AD converter corresponding to zero input voltage
  - *Input Offset Measurement:* Output voltage and statistical results over a large number of zero voltage measurements.
  - *Input Offset Current:* Typical value for information; Maximum channel input offset current, not considering the input resistance.
  - *Input resistance:* DAE input resistance at the connector, during internal auto-zeroing and during measurement.
  - *Low Battery Alarm Voltage:* Typical value for information. Below this voltage, a battery alarm signal is generated.
  - *Power consumption:* Typical value for information. Supply currents in various operating modes.

## DC Voltage Measurement

A/D - Converter Resolution nominal

High Range: 1LSB = 6.1 $\mu$ V, full range = -100...+300 mV

Low Range: 1LSB = 61nV, full range = -1.....+3mV

DASY measurement parameters: Auto Zero Time: 3 sec; Measuring time: 3 sec

Calibration Factors	X	Y	Z
High Range	404.296 $\pm$ 0.1% (k=2)	403.979 $\pm$ 0.1% (k=2)	404.799 $\pm$ 0.1% (k=2)
Low Range	3.96483 $\pm$ 0.7% (k=2)	3.94724 $\pm$ 0.7% (k=2)	3.95304 $\pm$ 0.7% (k=2)

## Connector Angle

Connector Angle to be used in DASY system	59 $^{\circ}$ $\pm$ 1 $^{\circ}$
---	----------------------------------

## Appendix

### 1. DC Voltage Linearity

High Range	Input ( $\mu\text{V}$ )	Reading ( $\mu\text{V}$ )	Error (%)
Channel X + Input	200000	200000.1	0.00
Channel X + Input	20000	20004.65	0.02
Channel X - Input	20000	-19997.96	-0.01
Channel Y + Input	200000	200000.2	0.00
Channel Y + Input	20000	20002.06	0.01
Channel Y - Input	20000	-20002.21	0.01
Channel Z + Input	200000	199999.5	0.00
Channel Z + Input	20000	20000.45	0.00
Channel Z - Input	20000	-20000.24	0.00

Low Range	Input ( $\mu\text{V}$ )	Reading ( $\mu\text{V}$ )	Error (%)
Channel X + Input	2000	2000	0.00
Channel X + Input	200	199.52	-0.24
Channel X - Input	200	-199.25	-0.38
Channel Y + Input	2000	2000	0.00
Channel Y + Input	200	199.61	-0.19
Channel Y - Input	200	-199.68	-0.16
Channel Z + Input	2000	2000.1	0.00
Channel Z + Input	200	198.97	-0.51
Channel Z - Input	200	-200.89	0.44

### 2. Common mode sensitivity

DASY measurement parameters: Auto Zero Time: 3 sec; Measuring time: 3 sec

	Common mode Input Voltage (mV)	High Range Average Reading ( $\mu\text{V}$ )	Low Range Average Reading ( $\mu\text{V}$ )
Channel X	200	-4.55	-4.98
	- 200	5.39	5.72
Channel Y	200	-1.09	-1.66
	- 200	-0.37	-0.36
Channel Z	200	16.19	16.11
	- 200	-17.75	-17.97

### 3. Channel separation

DASY measurement parameters: Auto Zero Time: 3 sec; Measuring time: 3 sec

	Input Voltage (mV)	Channel X ( $\mu\text{V}$ )	Channel Y ( $\mu\text{V}$ )	Channel Z ( $\mu\text{V}$ )
Channel X	200	-	3.70	0.32
Channel Y	200	0.80	-	3.59
Channel Z	200	-3.13	-0.50	-

#### 4. AD-Converter Values with inputs shorted

DASY measurement parameters: Auto Zero Time: 3 sec; Measuring time: 3 sec

	High Range (LSB)	Low Range (LSB)
Channel X	15722	15373
Channel Y	15735	14486
Channel Z	16044	16908

#### 5. Input Offset Measurement

DASY measurement parameters: Auto Zero Time: 3 sec; Measuring time: 3 sec

Input 10M $\Omega$

	Average ( $\mu$ V)	min. Offset ( $\mu$ V)	max. Offset ( $\mu$ V)	Std. Deviation ( $\mu$ V)
Channel X	0.98	-0.32	2.54	0.62
Channel Y	-1.57	-3.53	-0.17	0.62
Channel Z	-0.13	-1.30	1.18	0.51

#### 6. Input Offset Current

Nominal Input circuitry offset current on all channels: <25fA

#### 7. Input Resistance

	Zeroing (MOhm)	Measuring (MOhm)
Channel X	0.2000	198.1
Channel Y	0.2001	199.4
Channel Z	0.2001	196.4

#### 8. Low Battery Alarm Voltage (verified during pre test)

Typical values	Alarm Level (VDC)
Supply (+ Vcc)	+7.9
Supply (- Vcc)	-7.6

#### 9. Power Consumption (verified during pre test)

Typical values	Switched off (mA)	Stand by (mA)	Transmitting (mA)
Supply (+ Vcc)	+0.0	+6	+14
Supply (- Vcc)	-0.01	-8	-9



## **Annex B**

### **Measurement Plots**

Test Laboratory: Eurofins Product Service GmbH

## Dipol Valid.900(h)\_250mW 27.01.2009

**DUT: Dipole 900 MHz; Type: D900V2; Serial: 164**

Communication System: CW; Frequency: 900 MHz; Duty Cycle: 1:1

Medium: Head 900 MHz Medium parameters used:  $f = 900$  MHz;  $\sigma = 0.944$  mho/m;  $\epsilon_r = 40.5$ ;  $\rho = 1000$  kg/m<sup>3</sup>

Phantom section: Flat Section

DASY4 Configuration:

- Probe: ET3DV6 - SN1711; ConvF(6.17, 6.17, 6.17); Calibrated: 9/17/2008
- Sensor-Surface: 4mm (Mechanical And Optical Surface Detection)
- Electronics: DAE3 Sn522; Calibrated: 9/16/2008
- Phantom: SAM 12; Type: TP-1217; Serial: QD000P40CA
- Measurement SW: DASY4, V4.7 Build 71; Postprocessing SW: SEMCAD, V1.8 Build 184

**Dipol 900 (250mW)/Area Scan (61x81x1):** Measurement grid: dx=10mm, dy=10mm  
Maximum value of SAR (interpolated) = 2.97 mW/g

**Dipol 900 (250mW)/Zoom Scan (7x7x7)/Cube 0:** Measurement grid: dx=5mm, dy=5mm, dz=5mm

Reference Value = 58.6 V/m; Power Drift = -0.028 dB

Peak SAR (extrapolated) = 4.01 W/kg

**SAR(1 g) = 2.74 mW/g; SAR(10 g) = 1.78 mW/g**

Maximum value of SAR (measured) = 2.98 mW/g

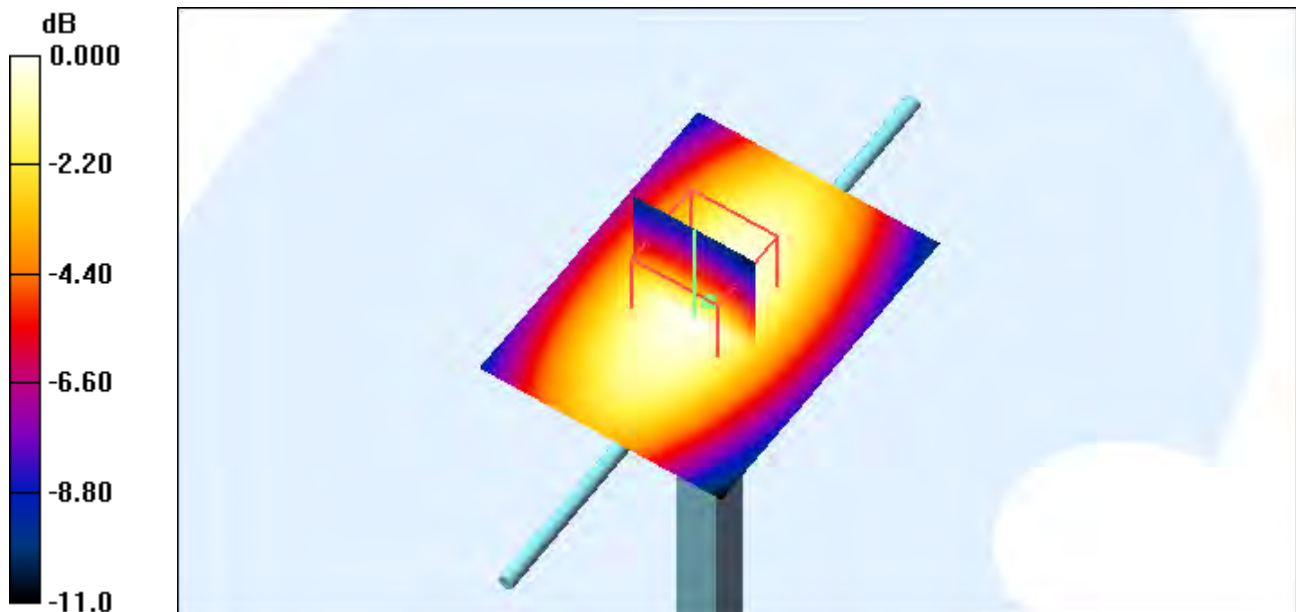

0 dB = 2.98mW/g

Test Laboratory: Eurofins Product Service GmbH

## Dipol Valid.1900(h)\_250mW 27.01.2009

**DUT: Dipole 1900 MHz; Type: D1900V2; Serial: 5d025**

Communication System: CW; Frequency: 1900 MHz; Duty Cycle: 1:1

Medium: Head 1900 MHz Medium parameters used:  $f = 1900$  MHz;  $\sigma = 1.42$  mho/m;  $\epsilon_r = 39.9$ ;  $\rho = 1000$  kg/m<sup>3</sup>

Phantom section: Flat Section

DASY4 Configuration:

- Probe: ET3DV6 - SN1711; ConvF(5.17, 5.17, 5.17); Calibrated: 9/17/2008
- Sensor-Surface: 4mm (Mechanical And Optical Surface Detection)
- Electronics: DAE3 Sn522; Calibrated: 9/16/2008
- Phantom: SAM 12; Type: TP-1217; Serial: QD000P40CA
- Measurement SW: DASY4, V4.7 Build 55; Postprocessing SW: SEMCAD, V1.8 Build 184

**Dipol 1900 (250mW)/Area Scan (61x81x1):** Measurement grid: dx=10mm, dy=10mm  
Maximum value of SAR (interpolated) = 12.6 mW/g

**Dipol 1900 (250mW)/Zoom Scan (7x7x7)/Cube 0:** Measurement grid: dx=5mm, dy=5mm, dz=5mm

Reference Value = 96.8 V/m; Power Drift = -0.005 dB

Peak SAR (extrapolated) = 19.9 W/kg

**SAR(1 g) = 10.9 mW/g; SAR(10 g) = 5.63 mW/g**

Maximum value of SAR (measured) = 12.2 mW/g

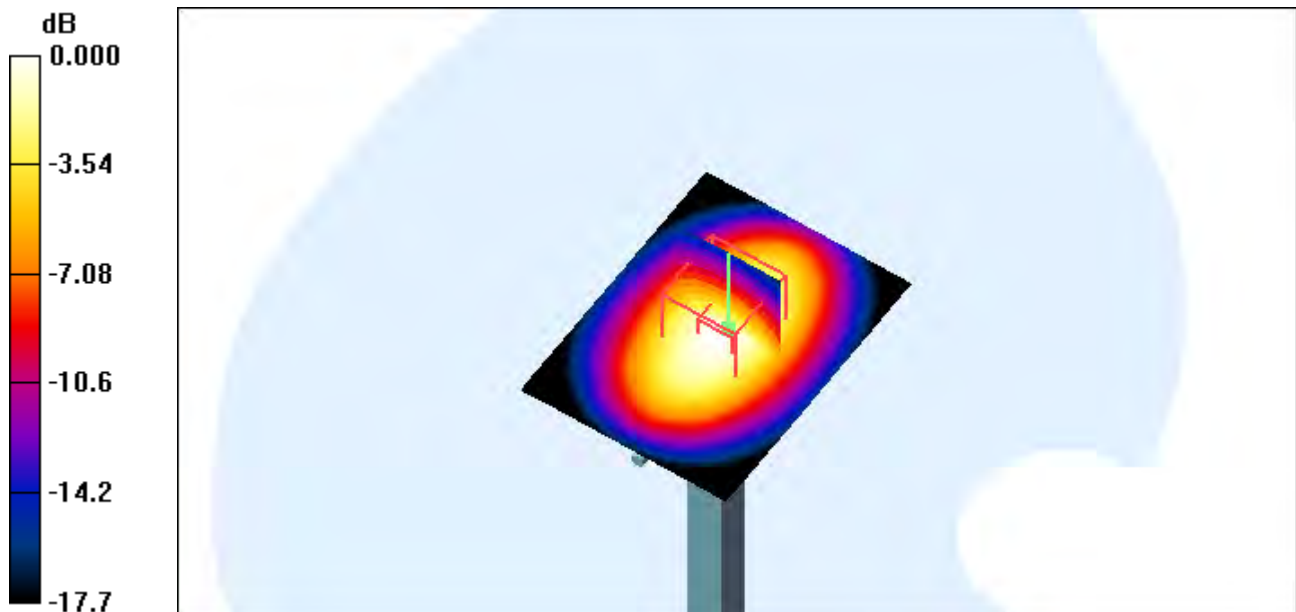

0 dB = 12.2mW/g

Test Laboratory: Eurofins Product Service GmbH

## Dipol Valid.900(m)\_250mW 28.01.2009

**DUT: Dipole 900 MHz; Type: D900V2; Serial: 164**

Communication System: CW; Frequency: 900 MHz; Duty Cycle: 1:1

Medium: Muscle 900 MHz Medium parameters used:  $f = 900$  MHz;  $\sigma = 1.01$  mho/m;  $\epsilon_r = 54.1$ ;  $\rho = 1000$  kg/m<sup>3</sup>

Phantom section: Flat Section

DASY4 Configuration:

- Probe: ET3DV6 - SN1711; ConvF(6.01, 6.01, 6.01); Calibrated: 9/17/2008
- Sensor-Surface: 4mm (Mechanical And Optical Surface Detection)
- Electronics: DAE3 Sn522; Calibrated: 9/16/2008
- Phantom: SAM 12; Type: TP-1217; Serial: QD000P40CA
- Measurement SW: DASY4, V4.7 Build 71; Postprocessing SW: SEMCAD, V1.8 Build 184

**Dipol 900 (250mW)/Area Scan (61x81x1):** Measurement grid: dx=10mm, dy=10mm  
Maximum value of SAR (interpolated) = 3.02 mW/g

**Dipol 900 (250mW)/Zoom Scan (7x7x7)/Cube 0:** Measurement grid: dx=5mm, dy=5mm, dz=5mm

Reference Value = 56.7 V/m; Power Drift = 0.021 dB

Peak SAR (extrapolated) = 3.97 W/kg

**SAR(1 g) = 2.77 mW/g; SAR(10 g) = 1.81 mW/g**

Maximum value of SAR (measured) = 3.01 mW/g

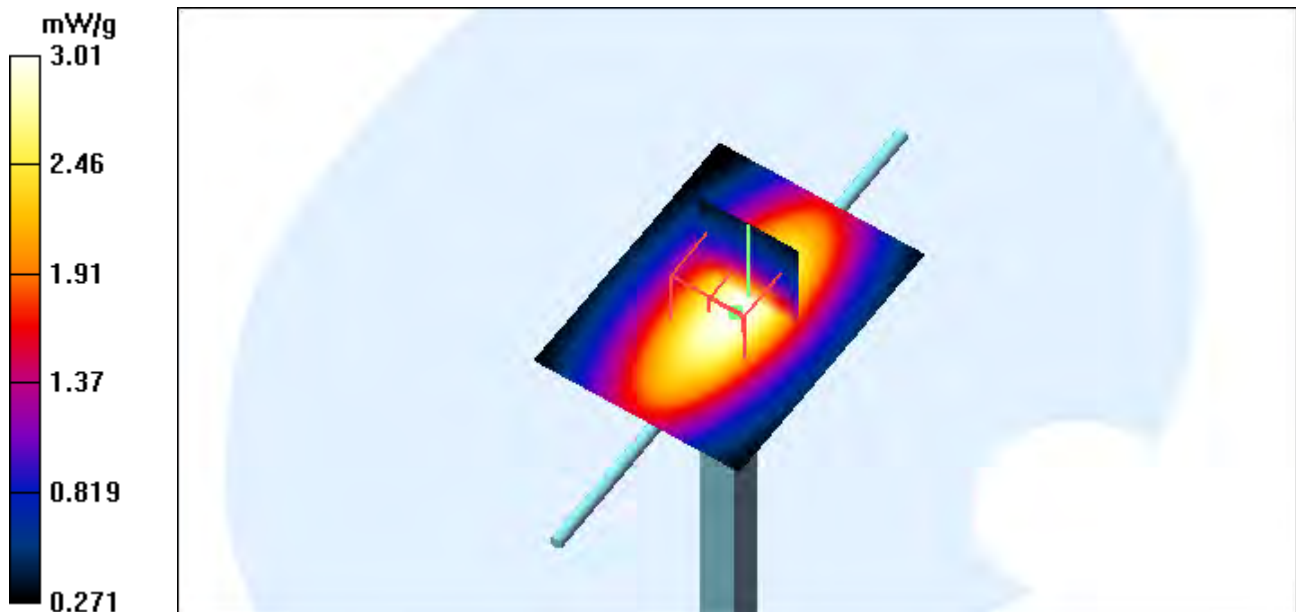

Test Laboratory: Eurofins Product Service GmbH

## Dipol Valid.1900(m)\_250mW 29.01.2009

**DUT: Dipole 1900 MHz; Type: D1900V2; Serial: 5d025**

Communication System: CW; Frequency: 1900 MHz; Duty Cycle: 1:1

Medium: Muscle 1900 MHz Medium parameters used:  $f = 1900$  MHz;  $\sigma = 1.58$  mho/m;  $\epsilon_r = 51.9$ ;  $\rho = 1000$  kg/m<sup>3</sup>

Phantom section: Flat Section

DASY4 Configuration:

- Probe: ET3DV6 - SN1711; ConvF(4.57, 4.57, 4.57); Calibrated: 9/17/2008
- Sensor-Surface: 4mm (Mechanical And Optical Surface Detection)
- Electronics: DAE3 Sn522; Calibrated: 9/16/2008
- Phantom: SAM 12; Type: TP-1217; Serial: QD000P40CA
- Measurement SW: DASY4, V4.7 Build 71; Postprocessing SW: SEMCAD, V1.8 Build 184

**Dipol 1900 (250mW)/Area Scan (61x81x1):** Measurement grid: dx=10mm, dy=10mm  
Maximum value of SAR (interpolated) = 13.1 mW/g

**Dipol 1900 (250mW)/Zoom Scan (7x7x7)/Cube 0:** Measurement grid: dx=5mm, dy=5mm, dz=5mm

Reference Value = 95.1 V/m; Power Drift = -0.018 dB

Peak SAR (extrapolated) = 20.7 W/kg

**SAR(1 g) = 11.4 mW/g; SAR(10 g) = 5.93 mW/g**

Maximum value of SAR (measured) = 12.8 mW/g

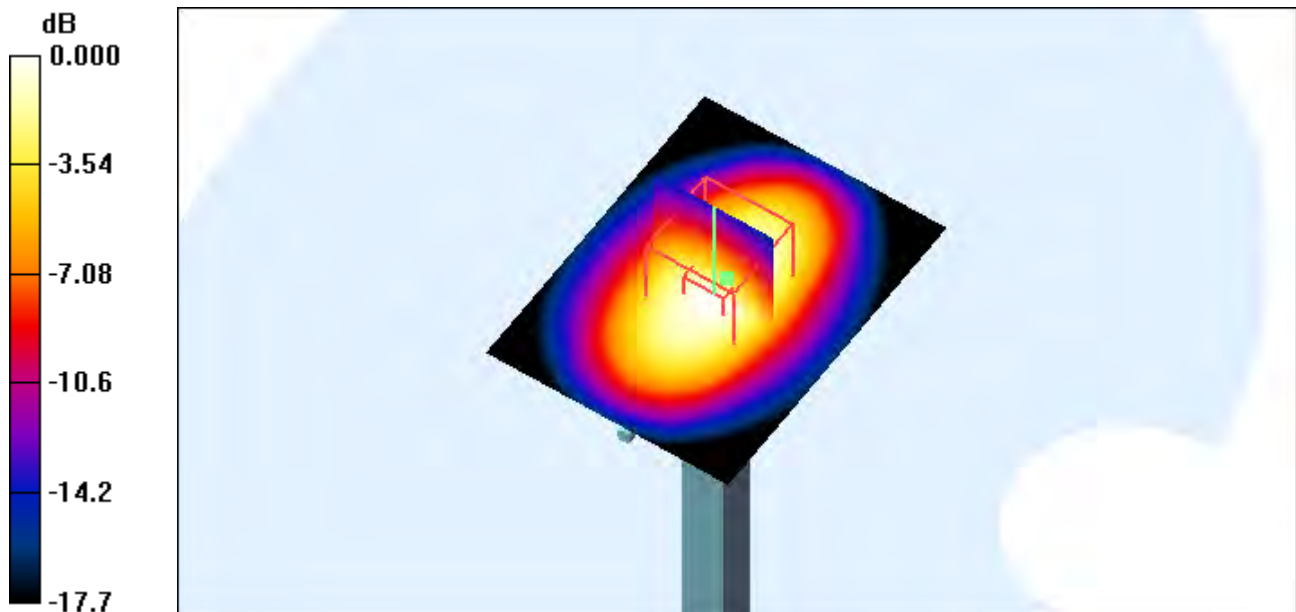

0 dB = 12.8mW/g

Test Laboratory: Eurofins Product Service GmbH

## GSM\_850\_ch128\_left\_cheek

**DUT: C180; Type: GSM phone; Serial: # 1**

Communication System: GSM 850; Frequency: 824.2 MHz; Duty Cycle: 1:8.3

Medium: Head 900 MHz Medium parameters used (interpolated):  $f = 824.2$  MHz;  $\sigma = 0.874$  mho/m;

$\epsilon_r = 41.3$ ;  $\rho = 1000$  kg/m<sup>3</sup>

Phantom section: Left Section

DASY4 Configuration:

- Probe: ET3DV6 - SN1711; ConvF(6.17, 6.17, 6.17); Calibrated: 9/17/2008
- Sensor-Surface: 4mm (Mechanical And Optical Surface Detection)
- Electronics: DAE3 Sn522; Calibrated: 9/16/2008
- Phantom: SAM 12; Type: TP-1217; Serial: QD000P40CA
- Measurement SW: DASY4, V4.7 Build 71; Postprocessing SW: SEMCAD, V1.8 Build 184

**C180/Area Scan (61x121x1):** Measurement grid: dx=10mm, dy=10mm

Maximum value of SAR (interpolated) = 0.639 mW/g

**C180/Zoom Scan (7x7x7)/Cube 0:** Measurement grid: dx=5mm, dy=5mm, dz=5mm

Reference Value = 25.1 V/m; Power Drift = -0.182 dB

Peak SAR (extrapolated) = 0.823 W/kg

**SAR(1 g) = 0.596 mW/g; SAR(10 g) = 0.410 mW/g**

Maximum value of SAR (measured) = 0.647 mW/g

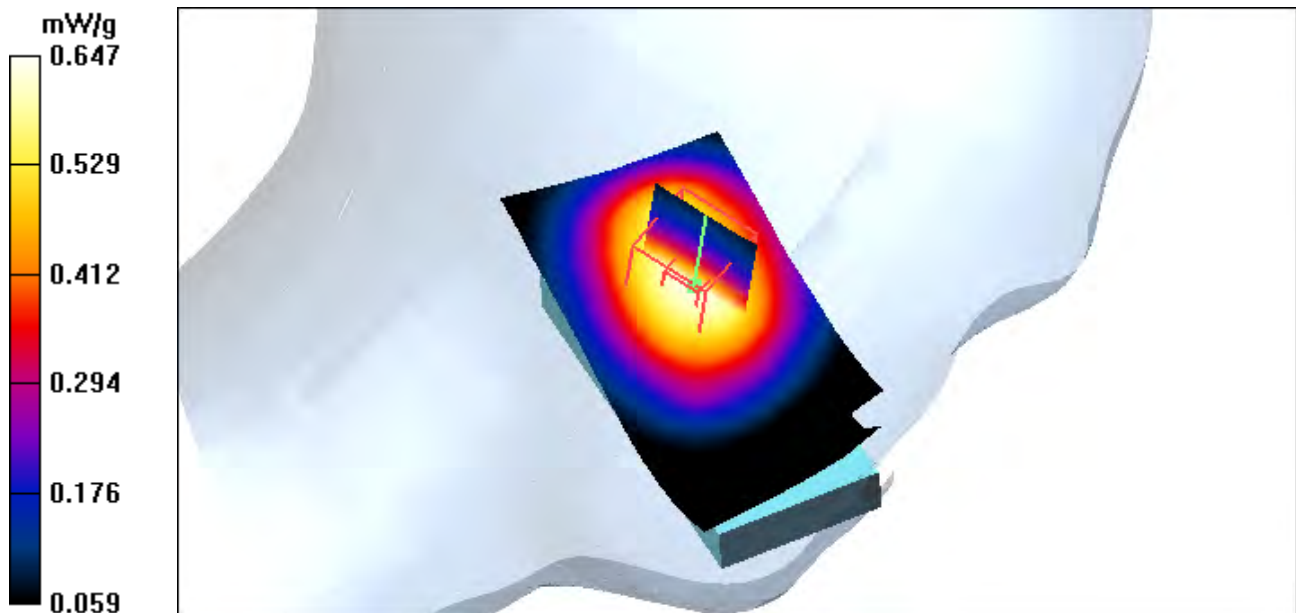

Test Laboratory: Eurofins Product Service GmbH

## GSM\_850\_ch189\_left\_cheek

**DUT: C180; Type: GSM phone; Serial: # 1**

Communication System: GSM 850; Frequency: 836.4 MHz; Duty Cycle: 1:8.3

Medium: Head 900 MHz Medium parameters used:  $f = 836.512$  MHz;  $\sigma = 0.89$  mho/m;  $\epsilon_r = 41.1$ ;  $\rho = 1000$  kg/m<sup>3</sup>

Phantom section: Left Section

DASY4 Configuration:

- Probe: ET3DV6 - SN1711; ConvF(6.17, 6.17, 6.17); Calibrated: 9/17/2008
- Sensor-Surface: 4mm (Mechanical And Optical Surface Detection)
- Electronics: DAE3 Sn522; Calibrated: 9/16/2008
- Phantom: SAM 12; Type: TP-1217; Serial: QD000P40CA
- Measurement SW: DASY4, V4.7 Build 71; Postprocessing SW: SEMCAD, V1.8 Build 184

**C180/Area Scan (61x121x1):** Measurement grid: dx=10mm, dy=10mm

Maximum value of SAR (interpolated) = 1.21 mW/g

**C180/Zoom Scan (7x7x7)/Cube 0:** Measurement grid: dx=5mm, dy=5mm, dz=5mm

Reference Value = 33.2 V/m; Power Drift = -0.160 dB

Peak SAR (extrapolated) = 1.58 W/kg

**SAR(1 g) = 1.13 mW/g; SAR(10 g) = 0.762 mW/g**

Maximum value of SAR (measured) = 1.22 mW/g

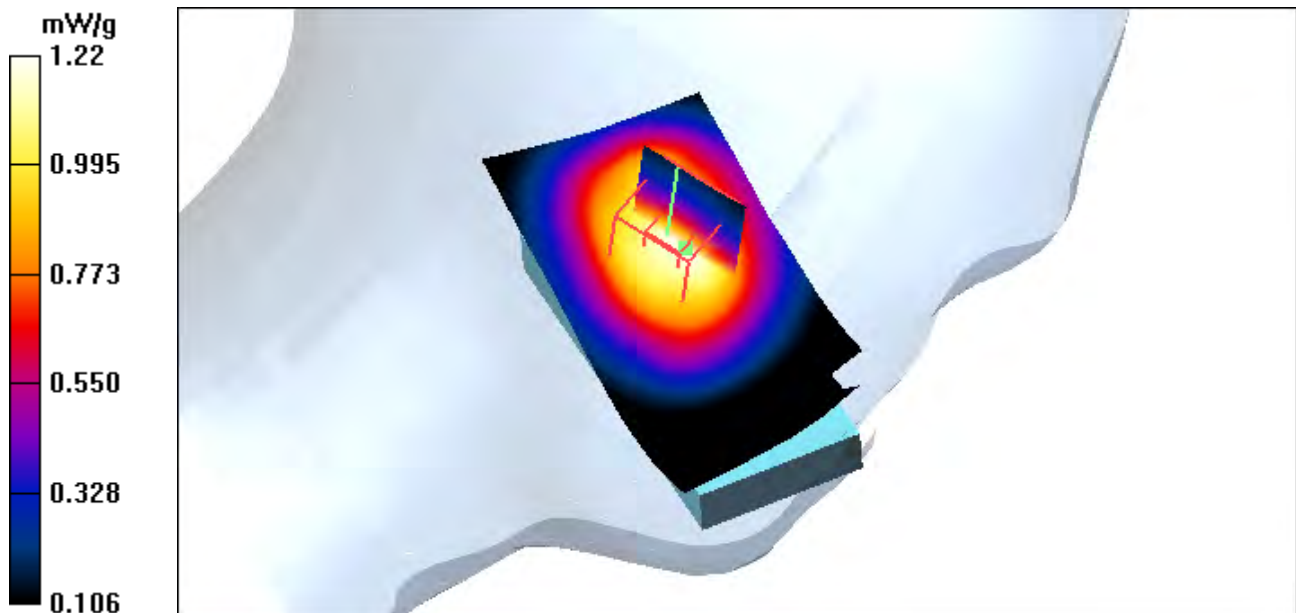

Test Laboratory: Eurofins Product Service GmbH

## GSM\_850\_ch189\_left\_tilted

**DUT: C180; Type: GSM phone; Serial: # 1**

Communication System: GSM 850; Frequency: 836.4 MHz; Duty Cycle: 1:8.3

Medium: Head 900 MHz Medium parameters used:  $f = 836.512$  MHz;  $\sigma = 0.89$  mho/m;  $\epsilon_r = 41.1$ ;  $\rho = 1000$  kg/m<sup>3</sup>

Phantom section: Left Section

DASY4 Configuration:

- Probe: ET3DV6 - SN1711; ConvF(6.17, 6.17, 6.17); Calibrated: 9/17/2008
- Sensor-Surface: 4mm (Mechanical And Optical Surface Detection)
- Electronics: DAE3 Sn522; Calibrated: 9/16/2008
- Phantom: SAM 12; Type: TP-1217; Serial: QD000P40CA
- Measurement SW: DASY4, V4.7 Build 71; Postprocessing SW: SEMCAD, V1.8 Build 184

**C180/Area Scan (61x121x1):** Measurement grid: dx=10mm, dy=10mm

Maximum value of SAR (interpolated) = 0.800 mW/g

**C180/Zoom Scan (7x7x7)/Cube 0:** Measurement grid: dx=5mm, dy=5mm, dz=5mm

Reference Value = 29.6 V/m; Power Drift = -0.330 dB

Peak SAR (extrapolated) = 1.22 W/kg

**SAR(1 g) = 0.768 mW/g; SAR(10 g) = 0.508 mW/g**

Maximum value of SAR (measured) = 0.840 mW/g

**C180/Zoom Scan (7x7x7)/Cube 1:** Measurement grid: dx=5mm, dy=5mm, dz=5mm

Reference Value = 29.6 V/m; Power Drift = -0.130 dB

Peak SAR (extrapolated) = 1.15 W/kg

**SAR(1 g) = 0.739 mW/g; SAR(10 g) = 0.475 mW/g**

Maximum value of SAR (measured) = 0.789 mW/g

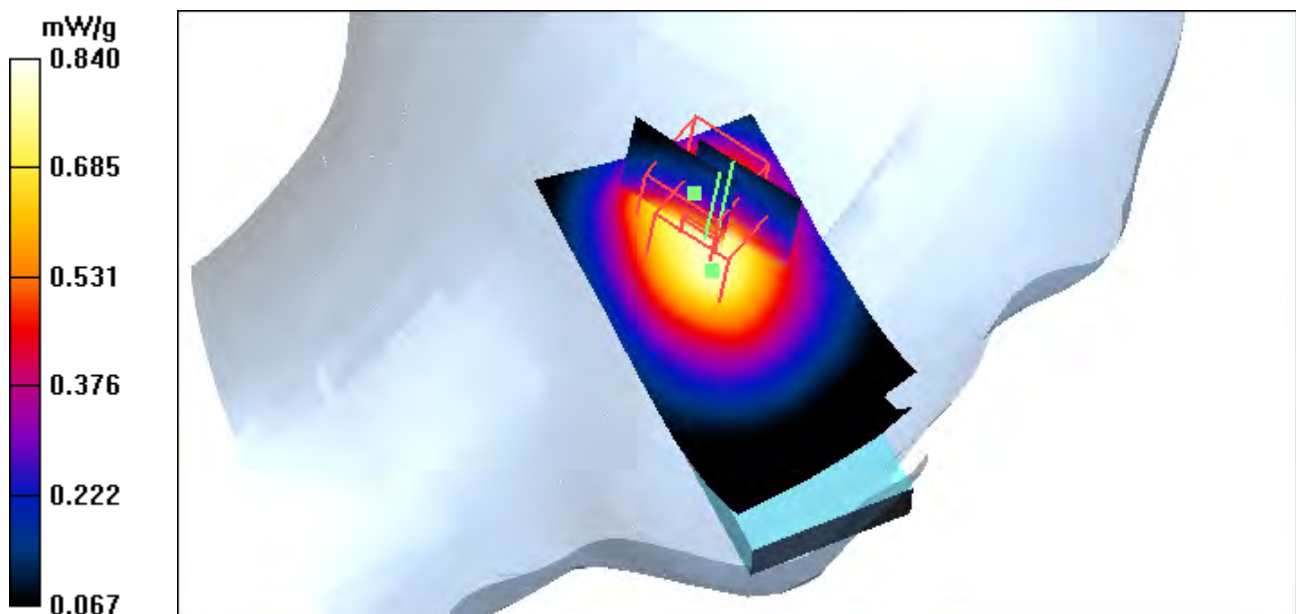



Test Laboratory: Eurofins Product Service GmbH

## GSM\_850\_ch251\_left\_cheek

**DUT: C180; Type: GSM phone; Serial: # 1**

Communication System: GSM 850; Frequency: 848.8 MHz; Duty Cycle: 1:8.3

Medium: Head 900 MHz Medium parameters used (interpolated):  $f = 848.8$  MHz;  $\sigma = 0.904$  mho/m;

$\epsilon_r = 40.9$ ;  $\rho = 1000$  kg/m<sup>3</sup>

Phantom section: Left Section

DASY4 Configuration:

- Probe: ET3DV6 - SN1711; ConvF(6.17, 6.17, 6.17); Calibrated: 9/17/2008
- Sensor-Surface: 4mm (Mechanical And Optical Surface Detection)
- Electronics: DAE3 Sn522; Calibrated: 9/16/2008
- Phantom: SAM 12; Type: TP-1217; Serial: QD000P40CA
- Measurement SW: DASY4, V4.7 Build 71; Postprocessing SW: SEMCAD, V1.8 Build 184

**C180/Area Scan (61x121x1):** Measurement grid: dx=10mm, dy=10mm

Maximum value of SAR (interpolated) = 1.18 mW/g

**C180/Zoom Scan (7x7x7)/Cube 0:** Measurement grid: dx=5mm, dy=5mm, dz=5mm

Reference Value = 32.2 V/m; Power Drift = -0.131 dB

Peak SAR (extrapolated) = 1.57 W/kg

**SAR(1 g) = 1.09 mW/g; SAR(10 g) = 0.747 mW/g**

Maximum value of SAR (measured) = 1.18 mW/g

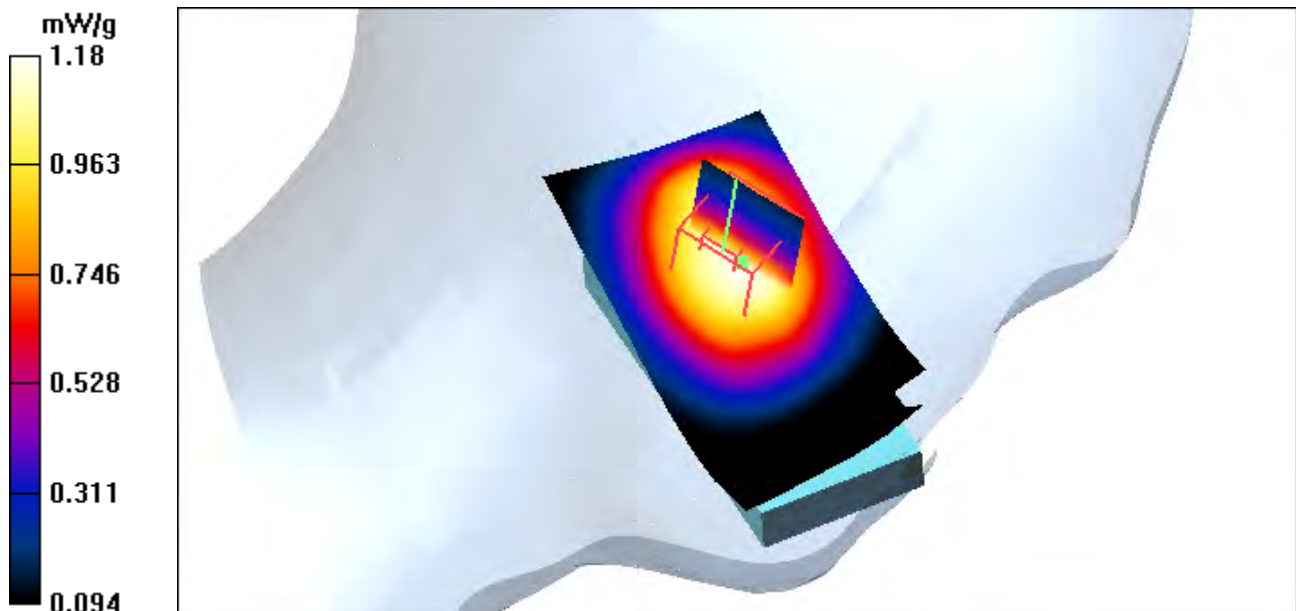

Test Laboratory: Eurofins Product Service GmbH

## GSM\_850\_ch189\_right\_cheek

**DUT: C180; Type: GSM phone; Serial: # 1**

Communication System: GSM 850; Frequency: 836.4 MHz; Duty Cycle: 1:8.3

Medium: Head 900 MHz Medium parameters used:  $f = 836.512$  MHz;  $\sigma = 0.89$  mho/m;  $\epsilon_r = 41.1$ ;  $\rho = 1000$  kg/m<sup>3</sup>

Phantom section: Right Section

DASY4 Configuration:

- Probe: ET3DV6 - SN1711; ConvF(6.17, 6.17, 6.17); Calibrated: 9/17/2008
- Sensor-Surface: 4mm (Mechanical And Optical Surface Detection)
- Electronics: DAE3 Sn522; Calibrated: 9/16/2008
- Phantom: SAM 12; Type: TP-1217; Serial: QD000P40CA
- Measurement SW: DASY4, V4.7 Build 71; Postprocessing SW: SEMCAD, V1.8 Build 184

**C180/Area Scan (61x121x1):** Measurement grid: dx=10mm, dy=10mm

Maximum value of SAR (interpolated) = 0.955 mW/g

**C180/Zoom Scan (7x7x7)/Cube 0:** Measurement grid: dx=5mm, dy=5mm, dz=5mm

Reference Value = 28.6 V/m; Power Drift = -0.011 dB

Peak SAR (extrapolated) = 1.13 W/kg

**SAR(1 g) = 0.818 mW/g; SAR(10 g) = 0.566 mW/g**

Maximum value of SAR (measured) = 0.900 mW/g

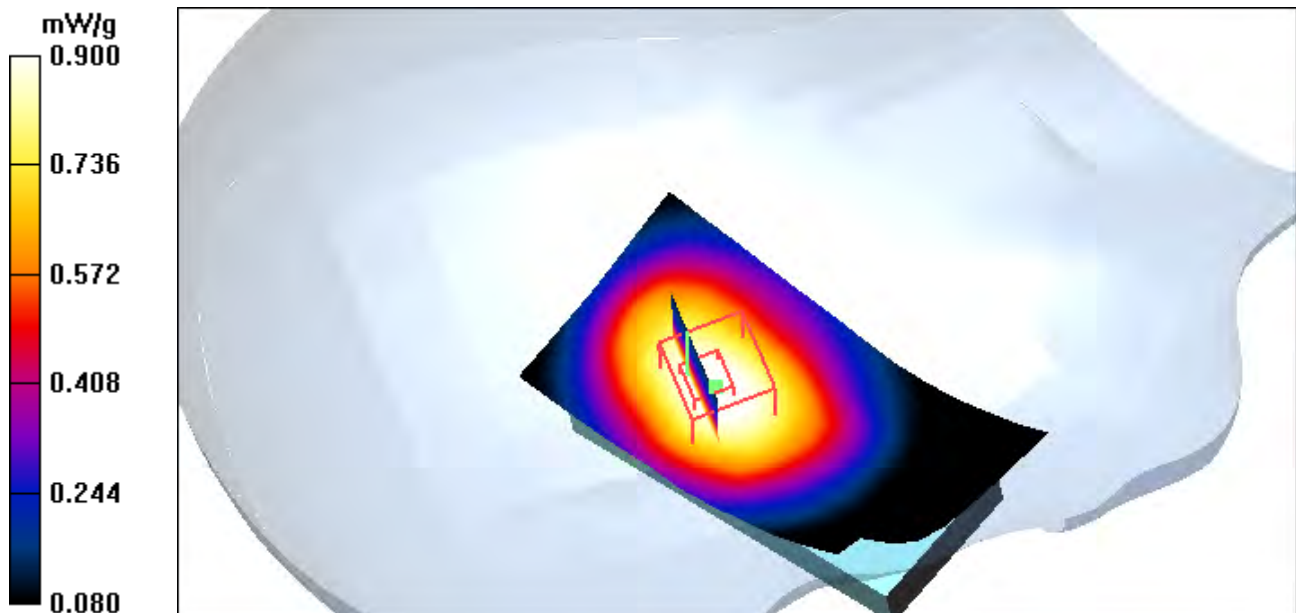

Test Laboratory: Eurofins Product Service GmbH

## GSM\_850\_ch189\_right\_tilted

**DUT: C180; Type: GSM phone; Serial: # 1**

Communication System: GSM 850; Frequency: 836.4 MHz; Duty Cycle: 1:8.3

Medium: Head 900 MHz Medium parameters used:  $f = 836.512$  MHz;  $\sigma = 0.89$  mho/m;  $\epsilon_r = 41.1$ ;  $\rho = 1000$  kg/m<sup>3</sup>

Phantom section: Right Section

DASY4 Configuration:

- Probe: ET3DV6 - SN1711; ConvF(6.17, 6.17, 6.17); Calibrated: 9/17/2008
- Sensor-Surface: 4mm (Mechanical And Optical Surface Detection)
- Electronics: DAE3 Sn522; Calibrated: 9/16/2008
- Phantom: SAM 12; Type: TP-1217; Serial: QD000P40CA
- Measurement SW: DASY4, V4.7 Build 71; Postprocessing SW: SEMCAD, V1.8 Build 184

**C180/Area Scan (61x121x1):** Measurement grid: dx=10mm, dy=10mm

Maximum value of SAR (interpolated) = 0.493 mW/g

**C180/Zoom Scan (7x7x7)/Cube 0:** Measurement grid: dx=5mm, dy=5mm, dz=5mm

Reference Value = 24.1 V/m; Power Drift = -0.090 dB

Peak SAR (extrapolated) = 0.653 W/kg

**SAR(1 g) = 0.460 mW/g; SAR(10 g) = 0.298 mW/g**

Maximum value of SAR (measured) = 0.492 mW/g

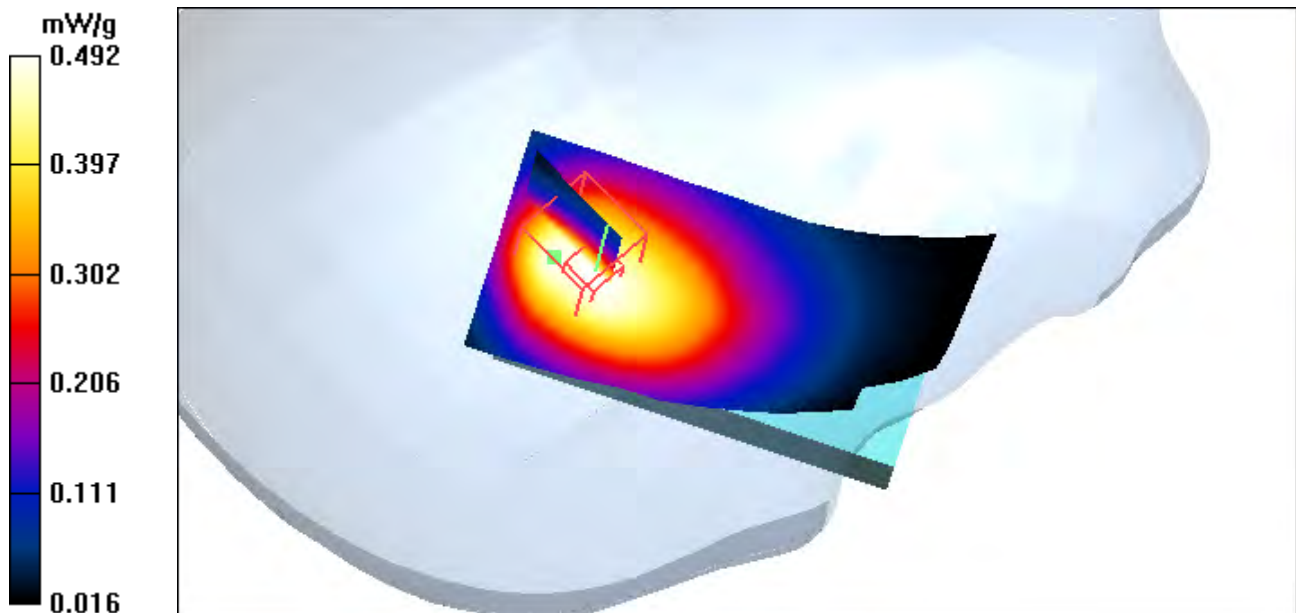

Test Laboratory: Eurofins Product Service GmbH

### GSM\_850\_ch189\_flat\_front\_0mm

**DUT: C180; Type: GSM phone; Serial: # 1**

Communication System: GSM 850; Frequency: 836.4 MHz; Duty Cycle: 1:8.3

Medium: Muscle 900 MHz Medium parameters used:  $f = 836.4$  MHz;  $\sigma = 0.936$  mho/m;  $\epsilon_r = 54.8$ ;  $\rho = 1000$  kg/m<sup>3</sup>

Phantom section: Flat Section

DASY4 Configuration:

- Probe: ET3DV6 - SN1711; ConvF(6.01, 6.01, 6.01); Calibrated: 9/17/2008
- Sensor-Surface: 4mm (Mechanical And Optical Surface Detection)
- Electronics: DAE3 Sn522; Calibrated: 9/16/2008
- Phantom: SAM 12; Type: TP-1217; Serial: QD000P40CA
- Measurement SW: DASY4, V4.7 Build 71; Postprocessing SW: SEMCAD, V1.8 Build 184

**C180/Area Scan (61x121x1):** Measurement grid: dx=10mm, dy=10mm

Maximum value of SAR (interpolated) = 0.956 mW/g

**C180/Zoom Scan (7x7x7)/Cube 0:** Measurement grid: dx=5mm, dy=5mm, dz=5mm

Reference Value = 31.5 V/m; Power Drift = -0.174 dB

Peak SAR (extrapolated) = 1.41 W/kg

**SAR(1 g) = 0.865 mW/g; SAR(10 g) = 0.601 mW/g**

Maximum value of SAR (measured) = 0.921 mW/g

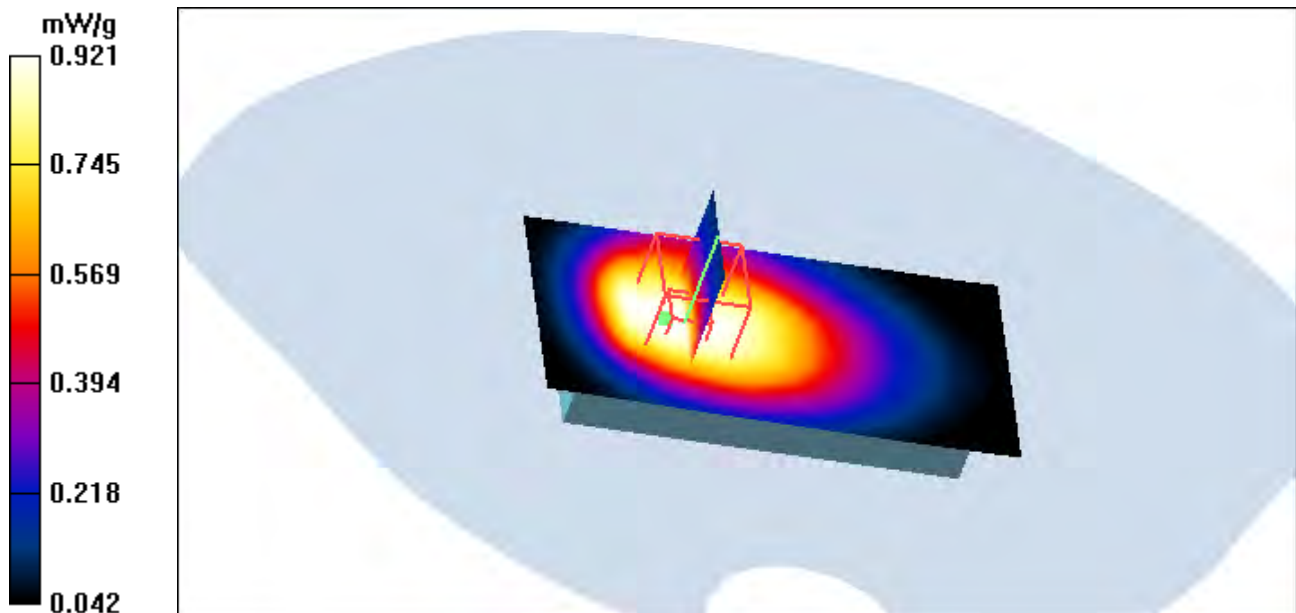

Test Laboratory: Eurofins Product Service GmbH

## GSM\_850\_ch189\_flat\_back\_0mm

**DUT: C180; Type: GSM phone; Serial: # 1**

Communication System: GSM 850; Frequency: 836.4 MHz; Duty Cycle: 1:8.3

Medium: Muscle 900 MHz Medium parameters used:  $f = 836.4$  MHz;  $\sigma = 0.936$  mho/m;  $\epsilon_r = 54.8$ ;  $\rho = 1000$  kg/m<sup>3</sup>

Phantom section: Flat Section

DASY4 Configuration:

- Probe: ET3DV6 - SN1711; ConvF(6.01, 6.01, 6.01); Calibrated: 9/17/2008
- Sensor-Surface: 4mm (Mechanical And Optical Surface Detection)
- Electronics: DAE3 Sn522; Calibrated: 9/16/2008
- Phantom: SAM 12; Type: TP-1217; Serial: QD000P40CA
- Measurement SW: DASY4, V4.7 Build 71; Postprocessing SW: SEMCAD, V1.8 Build 184

**C180/Area Scan (61x121x1):** Measurement grid: dx=10mm, dy=10mm

Maximum value of SAR (interpolated) = 1.13 mW/g

**C180/Zoom Scan (7x7x7)/Cube 0:** Measurement grid: dx=5mm, dy=5mm, dz=5mm

Reference Value = 22.3 V/m; Power Drift = -0.069 dB

Peak SAR (extrapolated) = 3.58 W/kg

**SAR(1 g) = 0.815 mW/g; SAR(10 g) = 0.405 mW/g**

Maximum value of SAR (measured) = 0.880 mW/g

**C180/Zoom Scan (7x7x7)/Cube 1:** Measurement grid: dx=5mm, dy=5mm, dz=5mm

Reference Value = 22.3 V/m; Power Drift = -0.069 dB

Peak SAR (extrapolated) = 1.61 W/kg

**SAR(1 g) = 0.693 mW/g; SAR(10 g) = 0.399 mW/g**

Maximum value of SAR (measured) = 0.805 mW/g

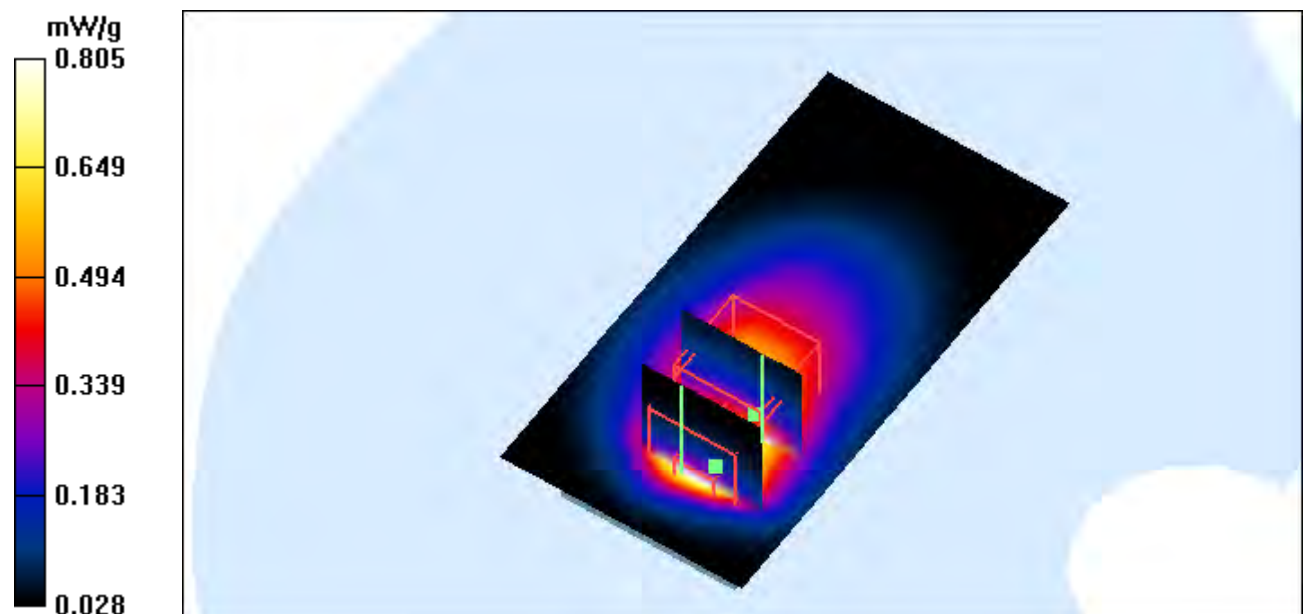

Test Laboratory: Eurofins Product Service GmbH

## GSM\_1900\_ch512\_left\_cheek

**DUT: C180; Type: GSM phone; Serial: # 1**

Communication System: GSM 1900; Frequency: 1850.2 MHz; Duty Cycle: 1:8.3

Medium: Head 1900 MHz Medium parameters used:  $f = 1850.2$  MHz;  $\sigma = 1.37$  mho/m;  $\epsilon_r = 39.9$ ;  $\rho = 1000$  kg/m<sup>3</sup>

Phantom section: Left Section

DASY4 Configuration:

- Probe: ET3DV6 - SN1711; ConvF(5.17, 5.17, 5.17); Calibrated: 9/17/2008
- Sensor-Surface: 4mm (Mechanical And Optical Surface Detection)
- Electronics: DAE3 Sn522; Calibrated: 9/16/2008
- Phantom: SAM 12; Type: TP-1217; Serial: QD000P40CA
- Measurement SW: DASY4, V4.7 Build 71; Postprocessing SW: SEMCAD, V1.8 Build 184

**C180/Area Scan (61x121x1):** Measurement grid: dx=10mm, dy=10mm

Maximum value of SAR (interpolated) = 0.930 mW/g

**C180/Zoom Scan (7x7x7)/Cube 0:** Measurement grid: dx=5mm, dy=5mm, dz=5mm

Reference Value = 17.5 V/m; Power Drift = 0.097 dB

Peak SAR (extrapolated) = 1.60 W/kg

**SAR(1 g) = 0.811 mW/g; SAR(10 g) = 0.406 mW/g**

Maximum value of SAR (measured) = 0.926 mW/g

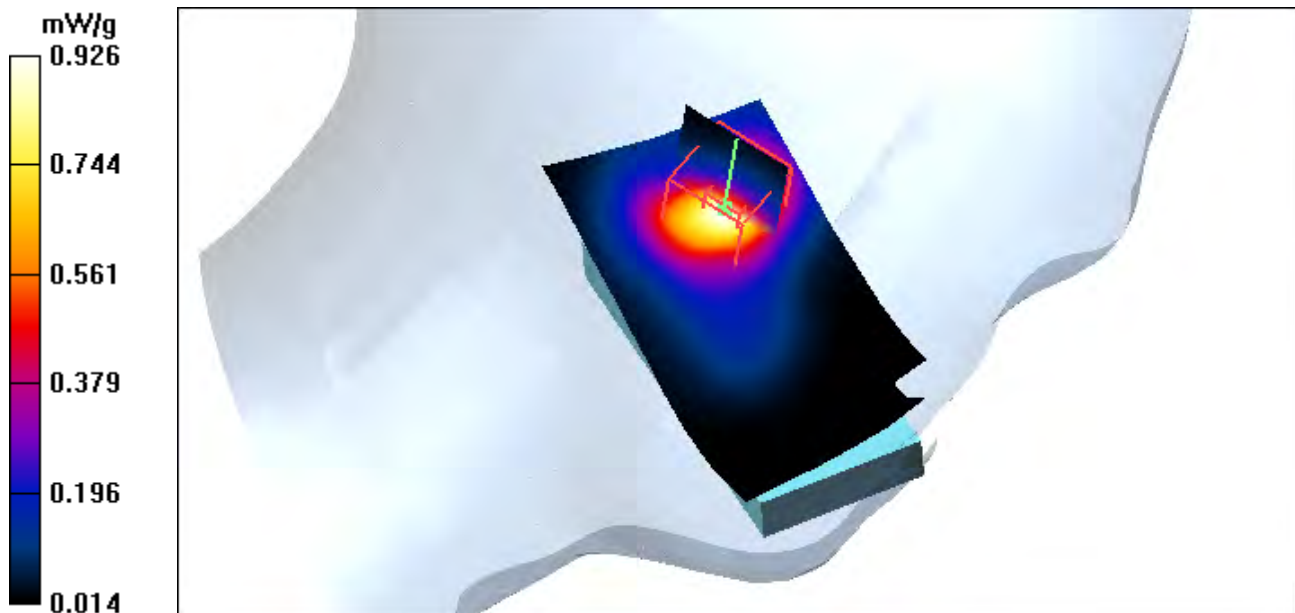

Test Laboratory: Eurofins Product Service GmbH

## GSM\_1900\_ch661\_left\_cheek

**DUT: C180; Type: GSM phone; Serial: # 1**

Communication System: GSM 1900; Frequency: 1880 MHz; Duty Cycle: 1:8.3

Medium: Head 1900 MHz Medium parameters used:  $f = 1880$  MHz;  $\sigma = 1.4$  mho/m;  $\epsilon_r = 39.9$ ;  $\rho = 1000$  kg/m<sup>3</sup>

Phantom section: Left Section

DASY4 Configuration:

- Probe: ET3DV6 - SN1711; ConvF(5.17, 5.17, 5.17); Calibrated: 9/17/2008
- Sensor-Surface: 4mm (Mechanical And Optical Surface Detection)
- Electronics: DAE3 Sn522; Calibrated: 9/16/2008
- Phantom: SAM 12; Type: TP-1217; Serial: QD000P40CA
- Measurement SW: DASY4, V4.7 Build 71; Postprocessing SW: SEMCAD, V1.8 Build 184

**C180/Area Scan (61x121x1):** Measurement grid: dx=10mm, dy=10mm

Maximum value of SAR (interpolated) = 0.713 mW/g

**C180/Zoom Scan (7x7x7)/Cube 0:** Measurement grid: dx=5mm, dy=5mm, dz=5mm

Reference Value = 13.6 V/m; Power Drift = -0.127 dB

Peak SAR (extrapolated) = 1.27 W/kg

**SAR(1 g) = 0.625 mW/g; SAR(10 g) = 0.312 mW/g**

Maximum value of SAR (measured) = 0.685 mW/g

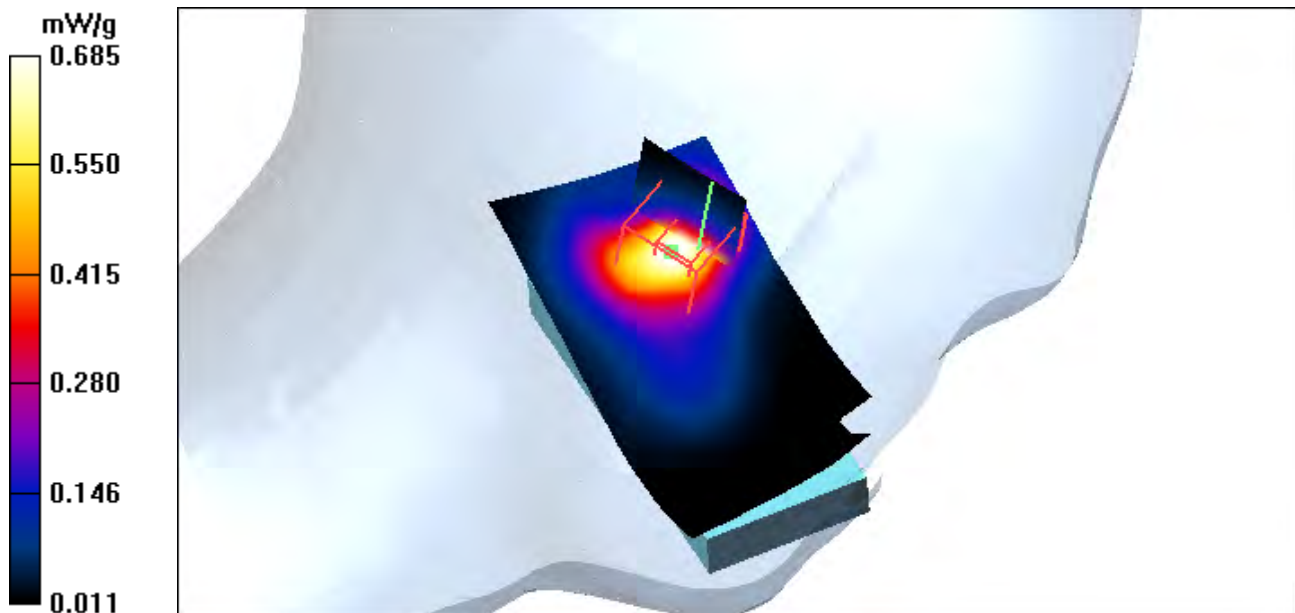

Test Laboratory: Eurofins Product Service GmbH

## GSM\_1900\_ch661\_left\_tilted

**DUT: C180; Type: GSM phone; Serial: # 1**

Communication System: GSM 1900; Frequency: 1880 MHz; Duty Cycle: 1:8.3

Medium: Head 1900 MHz Medium parameters used:  $f = 1880$  MHz;  $\sigma = 1.4$  mho/m;  $\epsilon_r = 39.9$ ;  $\rho = 1000$  kg/m<sup>3</sup>

Phantom section: Left Section

DASY4 Configuration:

- Probe: ET3DV6 - SN1711; ConvF(5.17, 5.17, 5.17); Calibrated: 9/17/2008
- Sensor-Surface: 4mm (Mechanical And Optical Surface Detection)
- Electronics: DAE3 Sn522; Calibrated: 9/16/2008
- Phantom: SAM 12; Type: TP-1217; Serial: QD000P40CA
- Measurement SW: DASY4, V4.7 Build 71; Postprocessing SW: SEMCAD, V1.8 Build 184

**C180/Area Scan (61x121x1):** Measurement grid: dx=10mm, dy=10mm

Maximum value of SAR (interpolated) = 0.518 mW/g

**C180/Zoom Scan (7x7x7)/Cube 0:** Measurement grid: dx=5mm, dy=5mm, dz=5mm

Reference Value = 11.6 V/m; Power Drift = 0.130 dB

Peak SAR (extrapolated) = 0.897 W/kg

**SAR(1 g) = 0.456 mW/g; SAR(10 g) = 0.231 mW/g**

Maximum value of SAR (measured) = 0.513 mW/g

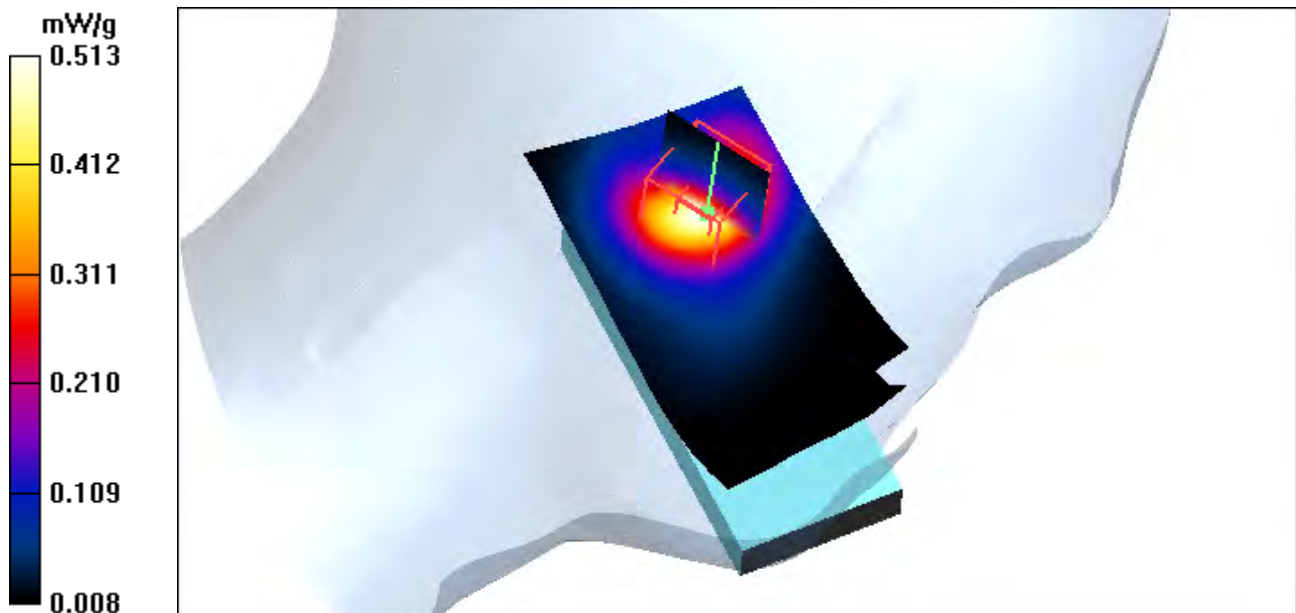



Test Laboratory: Eurofins Product Service GmbH

## GSM\_1900\_ch810\_left\_cheek

**DUT: C180; Type: GSM phone; Serial: # 1**

Communication System: GSM 1900; Frequency: 1909.8 MHz; Duty Cycle: 1:8.3

Medium: Head 1900 MHz Medium parameters used:  $f = 1909.8$  MHz;  $\sigma = 1.43$  mho/m;  $\epsilon_r = 39.8$ ;  $\rho = 1000$  kg/m<sup>3</sup>

Phantom section: Left Section

DASY4 Configuration:

- Probe: ET3DV6 - SN1711; ConvF(5.17, 5.17, 5.17); Calibrated: 9/17/2008
- Sensor-Surface: 4mm (Mechanical And Optical Surface Detection)
- Electronics: DAE3 Sn522; Calibrated: 9/16/2008
- Phantom: SAM 12; Type: TP-1217; Serial: QD000P40CA
- Measurement SW: DASY4, V4.7 Build 71; Postprocessing SW: SEMCAD, V1.8 Build 184

**C180/Area Scan (61x121x1):** Measurement grid: dx=10mm, dy=10mm

Maximum value of SAR (interpolated) = 0.617 mW/g

**C180/Zoom Scan (7x7x7)/Cube 0:** Measurement grid: dx=5mm, dy=5mm, dz=5mm

Reference Value = 14.0 V/m; Power Drift = -0.140 dB

Peak SAR (extrapolated) = 1.11 W/kg

**SAR(1 g) = 0.544 mW/g; SAR(10 g) = 0.273 mW/g**

Maximum value of SAR (measured) = 0.607 mW/g

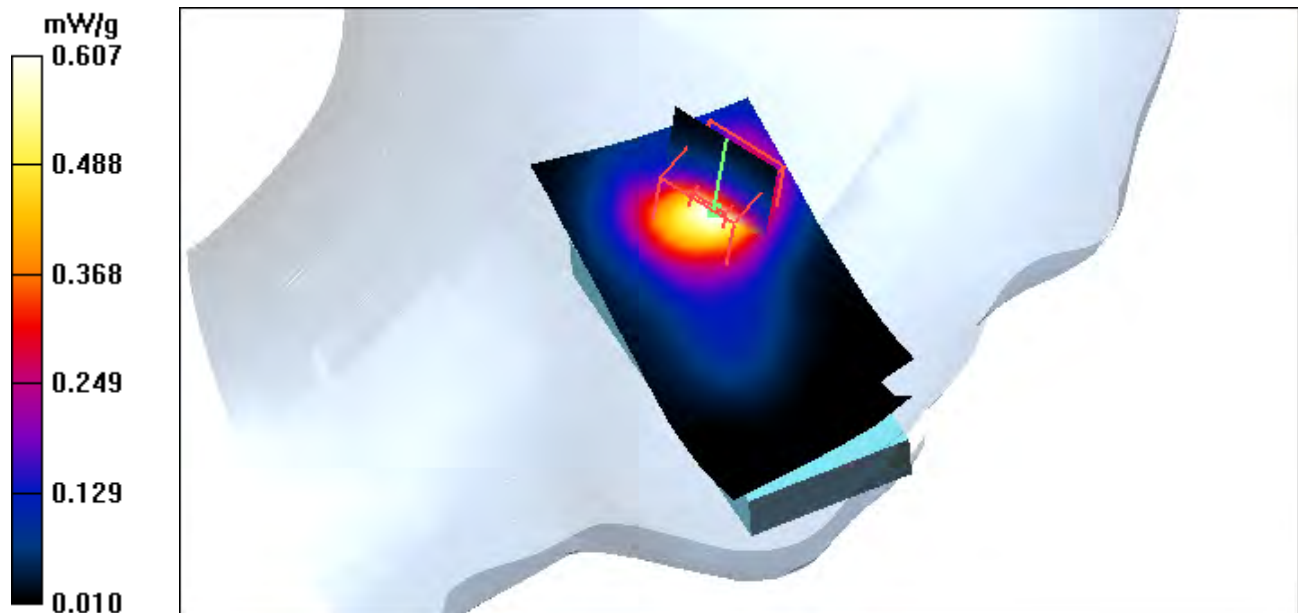

Test Laboratory: Eurofins Product Service GmbH

## GSM\_1900\_ch661\_right\_cheek

**DUT: C180; Type: GSM phone; Serial: # 1**

Communication System: GSM 1900; Frequency: 1880 MHz; Duty Cycle: 1:8.3

Medium: Head 1900 MHz Medium parameters used:  $f = 1880$  MHz;  $\sigma = 1.4$  mho/m;  $\epsilon_r = 39.9$ ;  $\rho = 1000$  kg/m<sup>3</sup>

Phantom section: Right Section

DASY4 Configuration:

- Probe: ET3DV6 - SN1711; ConvF(5.17, 5.17, 5.17); Calibrated: 9/17/2008
- Sensor-Surface: 4mm (Mechanical And Optical Surface Detection)
- Electronics: DAE3 Sn522; Calibrated: 9/16/2008
- Phantom: SAM 12; Type: TP-1217; Serial: QD000P40CA
- Measurement SW: DASY4, V4.7 Build 71; Postprocessing SW: SEMCAD, V1.8 Build 184

**C180/Area Scan (61x121x1):** Measurement grid: dx=10mm, dy=10mm

Maximum value of SAR (interpolated) = 0.487 mW/g

**C180/Zoom Scan (7x7x7)/Cube 0:** Measurement grid: dx=5mm, dy=5mm, dz=5mm

Reference Value = 12.2 V/m; Power Drift = -0.001 dB

Peak SAR (extrapolated) = 0.757 W/kg

**SAR(1 g) = 0.431 mW/g; SAR(10 g) = 0.245 mW/g**

Maximum value of SAR (measured) = 0.480 mW/g

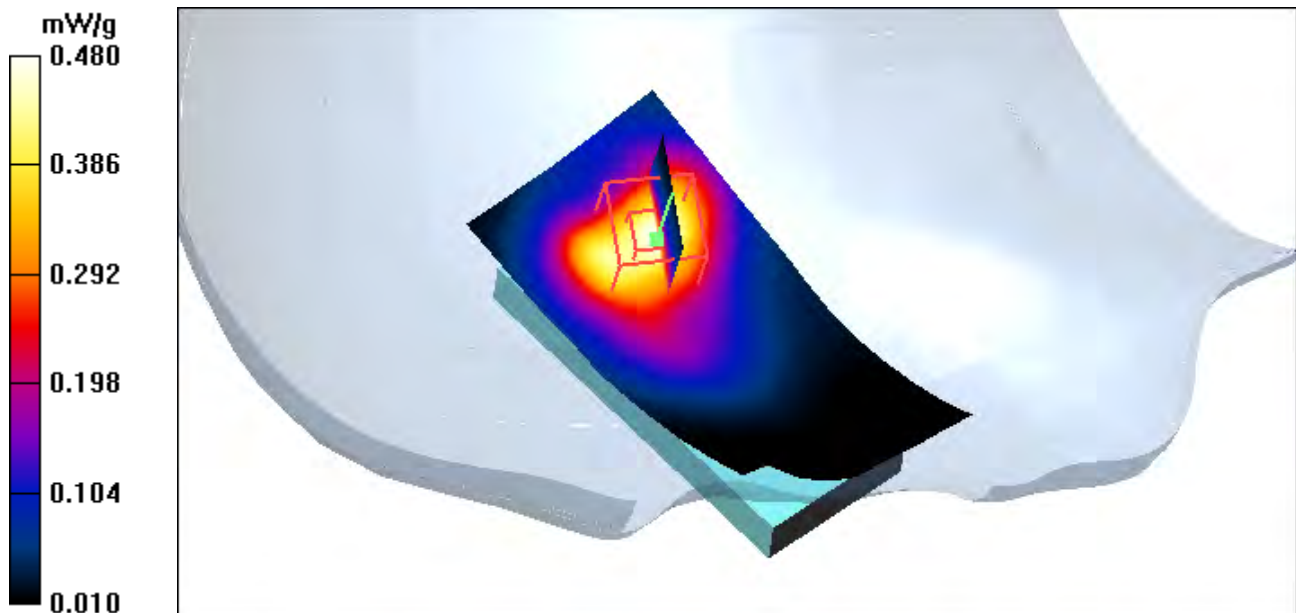

Test Laboratory: Eurofins Product Service GmbH

## GSM\_1900\_ch661\_right\_tilted

**DUT: C180; Type: GSM phone; Serial: # 1**

Communication System: GSM 1900; Frequency: 1880 MHz; Duty Cycle: 1:8.3

Medium: Head 1900 MHz Medium parameters used:  $f = 1880$  MHz;  $\sigma = 1.4$  mho/m;  $\epsilon_r = 39.9$ ;  $\rho = 1000$  kg/m<sup>3</sup>

Phantom section: Right Section

DASY4 Configuration:

- Probe: ET3DV6 - SN1711; ConvF(5.17, 5.17, 5.17); Calibrated: 9/17/2008
- Sensor-Surface: 4mm (Mechanical And Optical Surface Detection)
- Electronics: DAE3 Sn522; Calibrated: 9/16/2008
- Phantom: SAM 12; Type: TP-1217; Serial: QD000P40CA
- Measurement SW: DASY4, V4.7 Build 71; Postprocessing SW: SEMCAD, V1.8 Build 184

**C180/Area Scan (61x121x1):** Measurement grid: dx=10mm, dy=10mm

Maximum value of SAR (interpolated) = 0.381 mW/g

**C180/Zoom Scan (7x7x7)/Cube 0:** Measurement grid: dx=5mm, dy=5mm, dz=5mm

Reference Value = 12.6 V/m; Power Drift = -0.026 dB

Peak SAR (extrapolated) = 0.641 W/kg

**SAR(1 g) = 0.345 mW/g; SAR(10 g) = 0.188 mW/g**

Maximum value of SAR (measured) = 0.378 mW/g

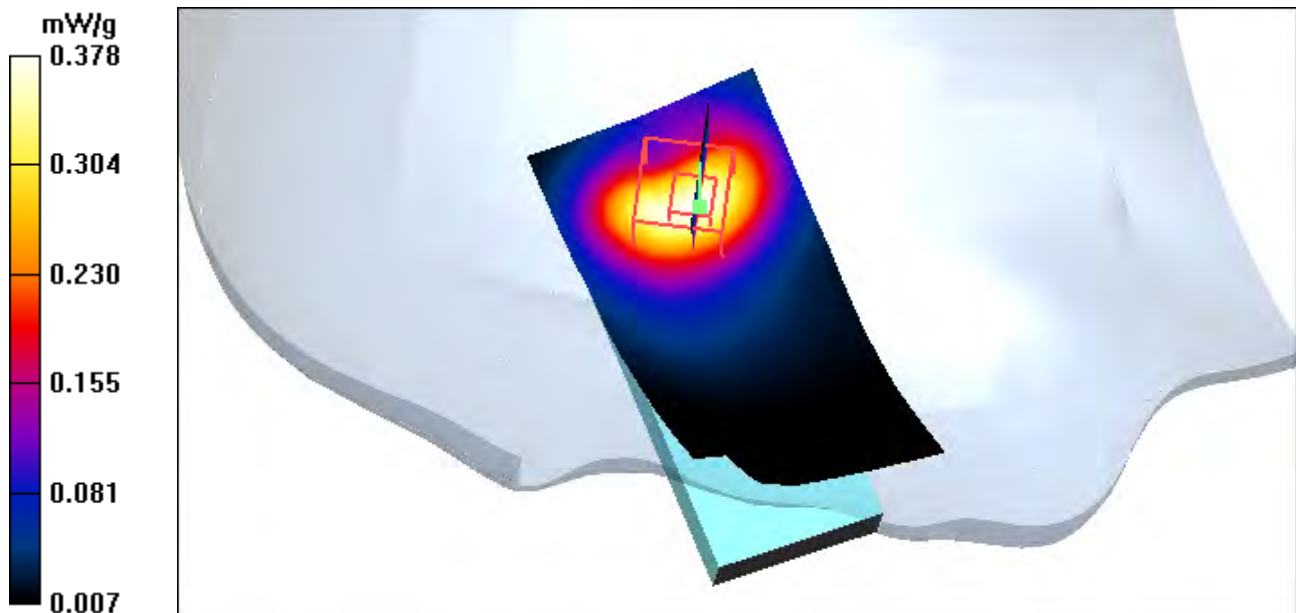

Test Laboratory: Eurofins Product Service GmbH

## GSM\_1900\_ch661\_flat\_front\_10mm

**DUT: C180; Type: GSM phone; Serial: # 1**

Communication System: GSM 1900; Frequency: 1880 MHz; Duty Cycle: 1:8.3

Medium: Muscle 1900 MHz Medium parameters used:  $f = 1880$  MHz;  $\sigma = 1.55$  mho/m;  $\epsilon_r = 51.9$ ;  $\rho = 1000$  kg/m<sup>3</sup>

Phantom section: Flat Section

DASY4 Configuration:

- Probe: ET3DV6 - SN1711; ConvF(4.57, 4.57, 4.57); Calibrated: 9/17/2008
- Sensor-Surface: 4mm (Mechanical And Optical Surface Detection)
- Electronics: DAE3 Sn522; Calibrated: 9/16/2008
- Phantom: SAM 12; Type: TP-1217; Serial: QD000P40CA
- Measurement SW: DASY4, V4.7 Build 71; Postprocessing SW: SEMCAD, V1.8 Build 184

**C180/Area Scan (61x121x1):** Measurement grid: dx=10mm, dy=10mm

Maximum value of SAR (interpolated) = 0.245 mW/g

**C180/Zoom Scan (7x7x7)/Cube 0:** Measurement grid: dx=5mm, dy=5mm, dz=5mm

Reference Value = 7.04 V/m; Power Drift = -0.196 dB

Peak SAR (extrapolated) = 0.374 W/kg

**SAR(1 g) = 0.208 mW/g; SAR(10 g) = 0.117 mW/g**

Maximum value of SAR (measured) = 0.228 mW/g

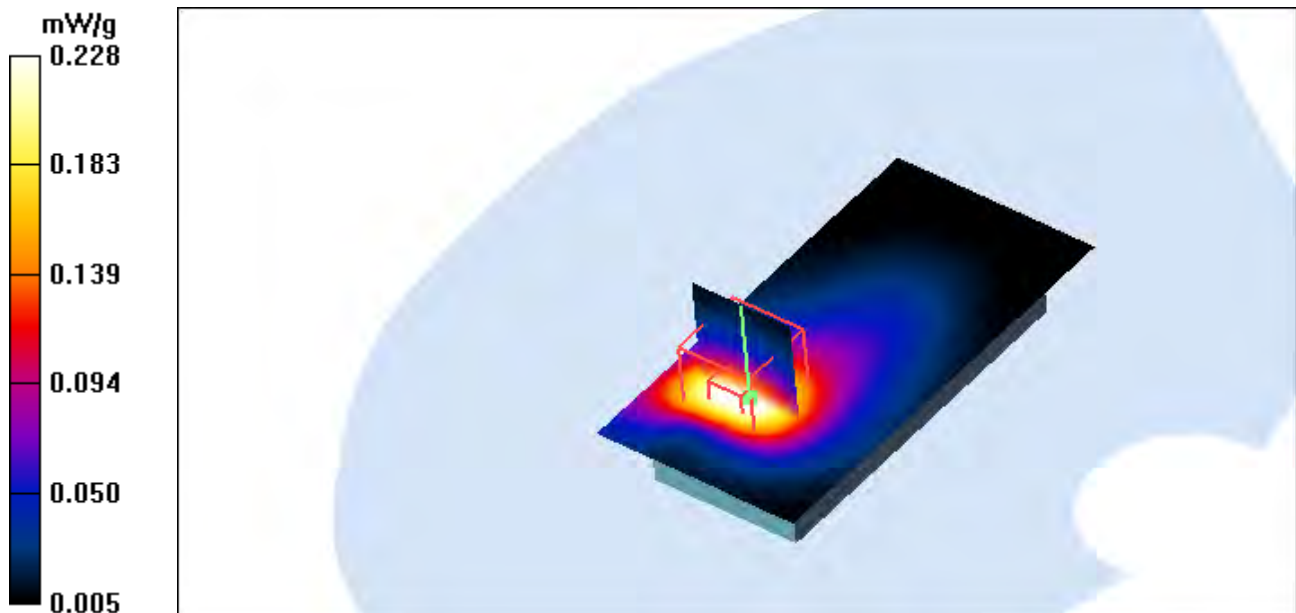

Test Laboratory: Eurofins Product Service GmbH

## GSM\_1900\_ch661\_flat\_back\_10mm

**DUT: C180; Type: GSM phone; Serial: # 1**

Communication System: GSM 1900; Frequency: 1880 MHz; Duty Cycle: 1:8.3

Medium: Muscle 1900 MHz Medium parameters used:  $f = 1880 \text{ MHz}$ ;  $\sigma = 1.55 \text{ mho/m}$ ;  $\epsilon_r = 51.9$ ;  $\rho = 1000 \text{ kg/m}^3$

Phantom section: Flat Section

DASY4 Configuration:

- Probe: ET3DV6 - SN1711; ConvF(4.57, 4.57, 4.57); Calibrated: 9/17/2008
- Sensor-Surface: 4mm (Mechanical And Optical Surface Detection)
- Electronics: DAE3 Sn522; Calibrated: 9/16/2008
- Phantom: SAM 12; Type: TP-1217; Serial: QD000P40CA
- Measurement SW: DASY4, V4.7 Build 71; Postprocessing SW: SEMCAD, V1.8 Build 184

**C180/Area Scan (61x121x1):** Measurement grid:  $dx=10\text{mm}$ ,  $dy=10\text{mm}$

Maximum value of SAR (interpolated) = 0.481 mW/g

**C180/Zoom Scan (7x7x7)/Cube 0:** Measurement grid:  $dx=5\text{mm}$ ,  $dy=5\text{mm}$ ,  $dz=5\text{mm}$

Reference Value = 11.7 V/m; Power Drift = -0.115 dB

Peak SAR (extrapolated) = 0.931 W/kg

**SAR(1 g) = 0.436 mW/g; SAR(10 g) = 0.230 mW/g**

Maximum value of SAR (measured) = 0.491 mW/g

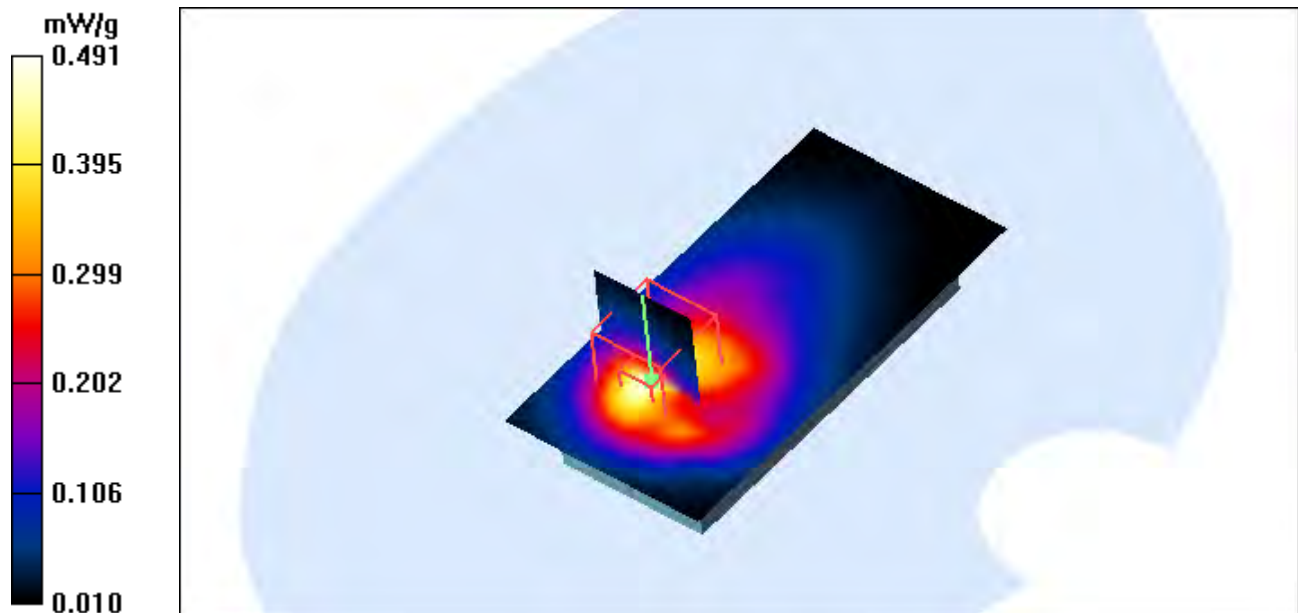

Test Laboratory: Eurofins Product Service GmbH

## GPRS\_850\_ch128\_flat\_back\_15mm

**DUT: C180; Type: GSM phone; Serial: # 1**

Communication System: GSM 850; Frequency: 824.2 MHz; Duty Cycle: 1:2

Medium: Muscle 900 MHz Medium parameters used:  $f = 824.2$  MHz;  $\sigma = 0.927$  mho/m;  $\epsilon_r = 54.9$ ;  $\rho = 1000$  kg/m<sup>3</sup>

Phantom section: Flat Section

DASY4 Configuration:

- Probe: ET3DV6 - SN1711; ConvF(6.01, 6.01, 6.01); Calibrated: 9/17/2008
- Sensor-Surface: 4mm (Mechanical And Optical Surface Detection)
- Electronics: DAE3 Sn522; Calibrated: 9/16/2008
- Phantom: SAM 12; Type: TP-1217; Serial: QD000P40CA
- Measurement SW: DASY4, V4.7 Build 71; Postprocessing SW: SEMCAD, V1.8 Build 184

**C180/Area Scan (61x121x1):** Measurement grid: dx=10mm, dy=10mm

Maximum value of SAR (interpolated) = 0.890 mW/g

**C180/Zoom Scan (7x7x7)/Cube 0:** Measurement grid: dx=5mm, dy=5mm, dz=5mm

Reference Value = 28.7 V/m; Power Drift = 0.000 dB

Peak SAR (extrapolated) = 1.07 W/kg

**SAR(1 g) = 0.817 mW/g; SAR(10 g) = 0.573 mW/g**

Maximum value of SAR (measured) = 0.878 mW/g

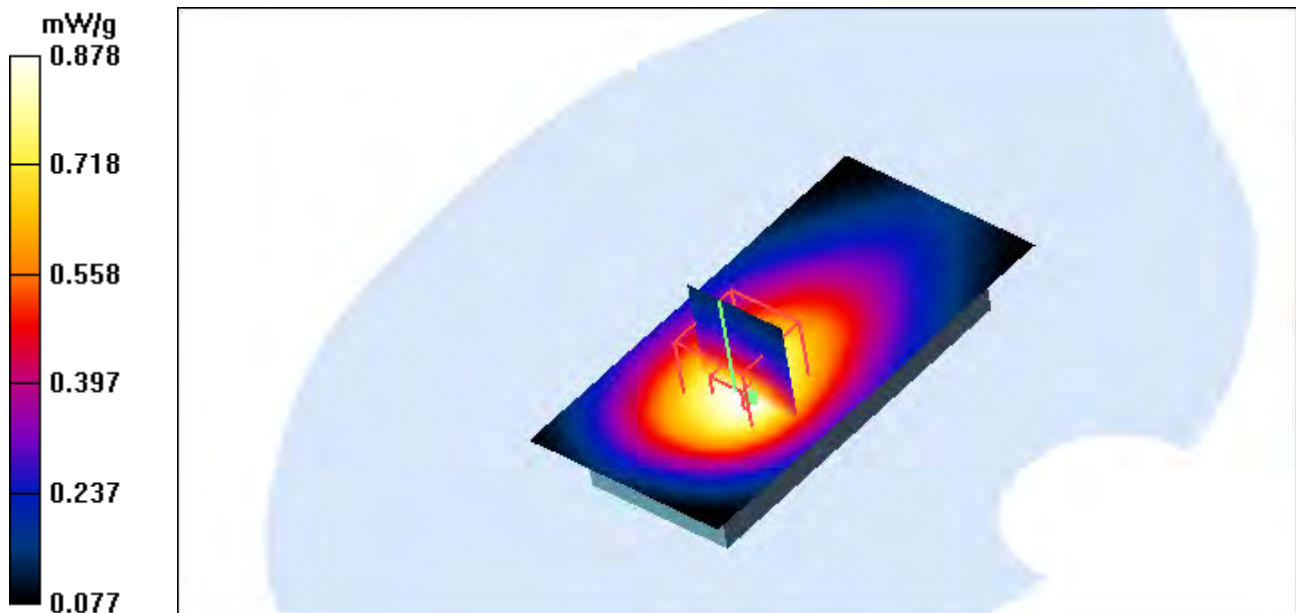

Test Laboratory: Eurofins Product Service GmbH

## GPRS\_850\_ch189\_flat\_front\_10mm

**DUT: C180; Type: GSM phone; Serial: # 1**

Communication System: GSM 850; Frequency: 836.4 MHz; Duty Cycle: 1:2

Medium: Muscle 900 MHz Medium parameters used:  $f = 836.4$  MHz;  $\sigma = 0.936$  mho/m;  $\epsilon_r = 54.8$ ;  $\rho = 1000$  kg/m<sup>3</sup>

Phantom section: Flat Section

DASY4 Configuration:

- Probe: ET3DV6 - SN1711; ConvF(6.01, 6.01, 6.01); Calibrated: 9/17/2008
- Sensor-Surface: 4mm (Mechanical And Optical Surface Detection)
- Electronics: DAE3 Sn522; Calibrated: 9/16/2008
- Phantom: SAM 12; Type: TP-1217; Serial: QD000P40CA
- Measurement SW: DASY4, V4.7 Build 71; Postprocessing SW: SEMCAD, V1.8 Build 184

**C180/Area Scan (61x121x1):** Measurement grid: dx=10mm, dy=10mm

Maximum value of SAR (interpolated) = 1.42 mW/g

**C180/Zoom Scan (7x7x7)/Cube 0:** Measurement grid: dx=5mm, dy=5mm, dz=5mm

Reference Value = 35.1 V/m; Power Drift = -0.147 dB

Peak SAR (extrapolated) = 1.69 W/kg

**SAR(1 g) = 1.3 mW/g; SAR(10 g) = 0.916 mW/g**

Maximum value of SAR (measured) = 1.39 mW/g

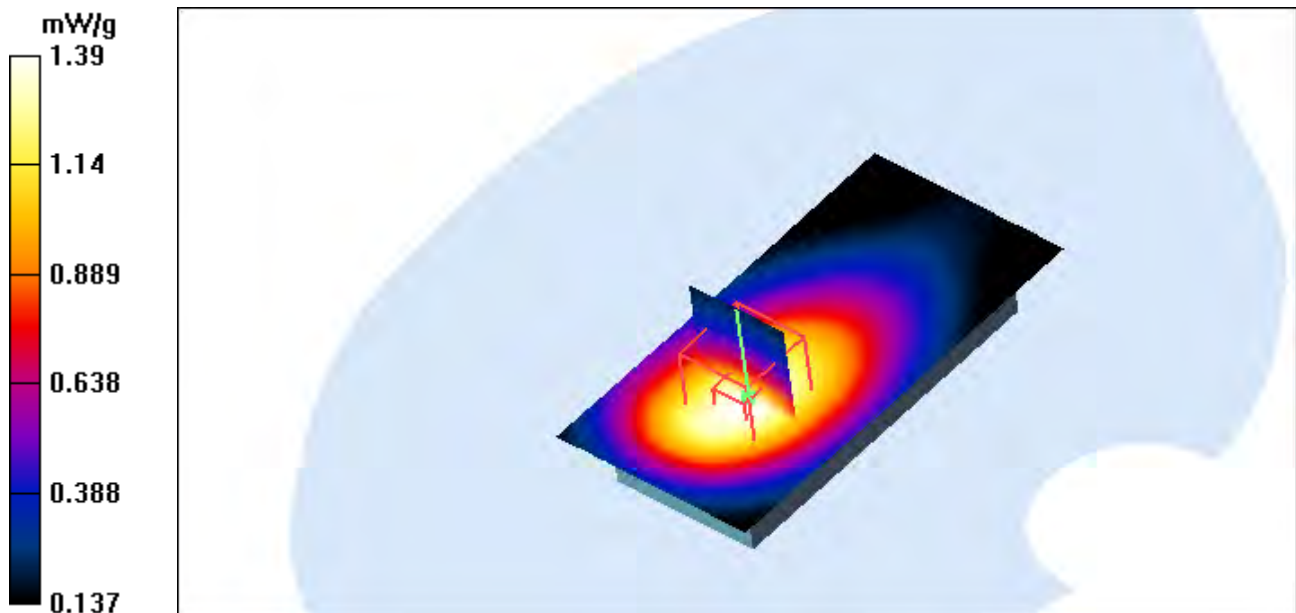

Test Laboratory: Eurofins Product Service GmbH

## GPRS\_850\_ch189\_flat\_back\_15mm

**DUT: C180; Type: GSM phone; Serial: # 1**

Communication System: GSM 850; Frequency: 836.4 MHz; Duty Cycle: 1:2

Medium: Muscle 900 MHz Medium parameters used:  $f = 836.4$  MHz;  $\sigma = 0.936$  mho/m;  $\epsilon_r = 54.8$ ;  $\rho = 1000$  kg/m<sup>3</sup>

Phantom section: Flat Section

DASY4 Configuration:

- Probe: ET3DV6 - SN1711; ConvF(6.01, 6.01, 6.01); Calibrated: 9/17/2008
- Sensor-Surface: 4mm (Mechanical And Optical Surface Detection)
- Electronics: DAE3 Sn522; Calibrated: 9/16/2008
- Phantom: SAM 12; Type: TP-1217; Serial: QD000P40CA
- Measurement SW: DASY4, V4.7 Build 71; Postprocessing SW: SEMCAD, V1.8 Build 184

**C180/Area Scan (61x121x1):** Measurement grid: dx=10mm, dy=10mm

Maximum value of SAR (interpolated) = 1.21 mW/g

**C180/Zoom Scan (7x7x7)/Cube 0:** Measurement grid: dx=5mm, dy=5mm, dz=5mm

Reference Value = 31.5 V/m; Power Drift = -0.011 dB

Peak SAR (extrapolated) = 1.51 W/kg

**SAR(1 g) = 1.13 mW/g; SAR(10 g) = 0.783 mW/g**

Maximum value of SAR (measured) = 1.21 mW/g

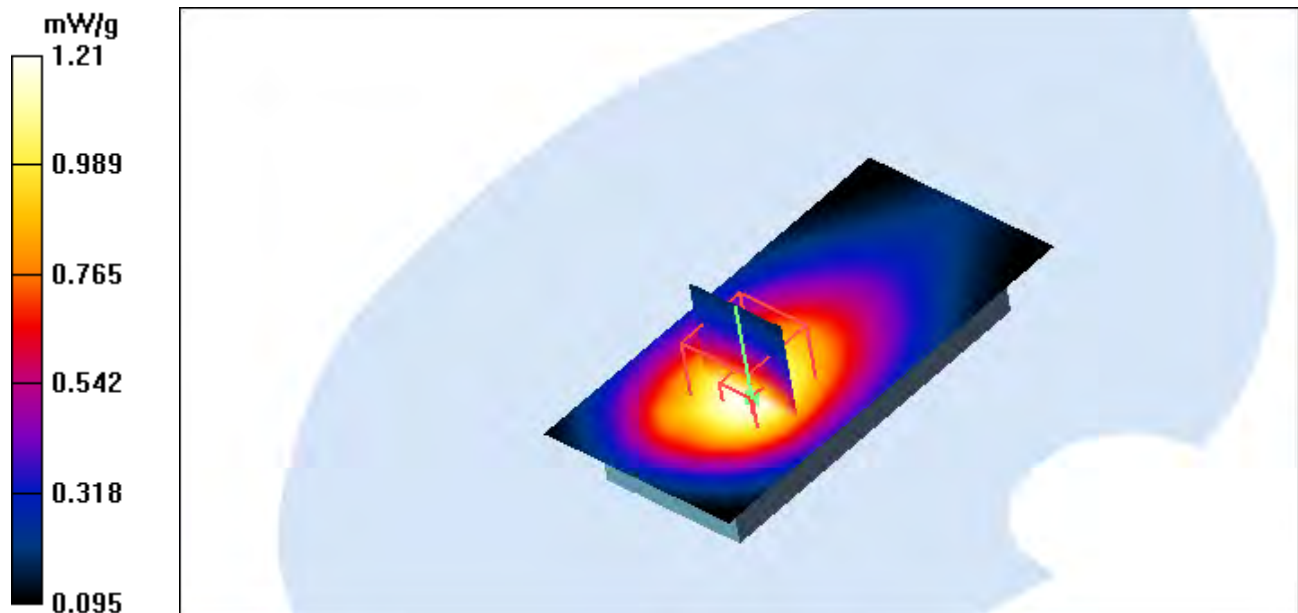



Test Laboratory: Eurofins Product Service GmbH

## GPRS\_850\_ch251\_flat\_back\_15mm

**DUT: C180; Type: GSM phone; Serial: # 1**

Communication System: GSM 850; Frequency: 848.8 MHz; Duty Cycle: 1:2

Medium: Muscle 900 MHz Medium parameters used:  $f = 848.8$  MHz;  $\sigma = 0.944$  mho/m;  $\epsilon_r = 54.7$ ;  $\rho = 1000$  kg/m<sup>3</sup>

Phantom section: Flat Section

DASY4 Configuration:

- Probe: ET3DV6 - SN1711; ConvF(6.01, 6.01, 6.01); Calibrated: 9/17/2008
- Sensor-Surface: 4mm (Mechanical And Optical Surface Detection)
- Electronics: DAE3 Sn522; Calibrated: 9/16/2008
- Phantom: SAM 12; Type: TP-1217; Serial: QD000P40CA
- Measurement SW: DASY4, V4.7 Build 71; Postprocessing SW: SEMCAD, V1.8 Build 184

**C180/Area Scan (61x121x1):** Measurement grid: dx=10mm, dy=10mm

Maximum value of SAR (interpolated) = 1.31 mW/g

**C180/Zoom Scan (7x7x7)/Cube 0:** Measurement grid: dx=5mm, dy=5mm, dz=5mm

Reference Value = 32.7 V/m; Power Drift = 0.132 dB

Peak SAR (extrapolated) = 1.63 W/kg

**SAR(1 g) = 1.17 mW/g; SAR(10 g) = 0.813 mW/g**

Maximum value of SAR (measured) = 1.27 mW/g

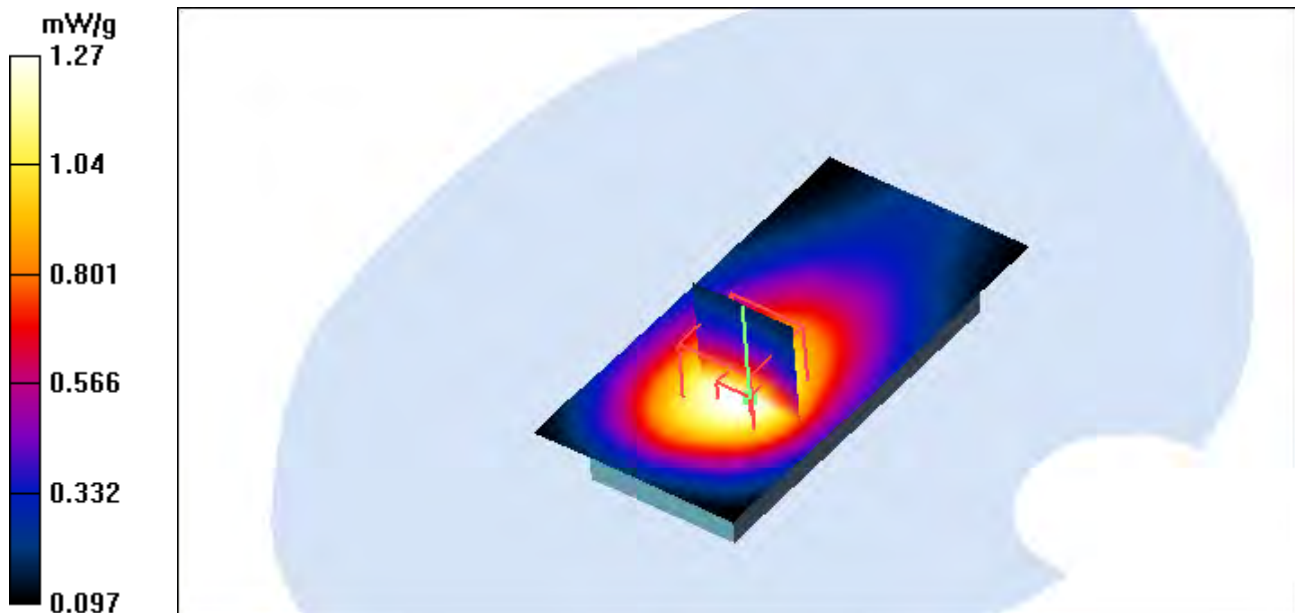

Test Laboratory: Eurofins Product Service GmbH

## GPRS\_1900\_ch512\_flat\_back\_15mm

**DUT: C180; Type: GSM phone; Serial: # 1**

Communication System: GSM 1900; Frequency: 1850.2 MHz; Duty Cycle: 1:2

Medium: Muscle 1900 MHz Medium parameters used:  $f = 1850.2 \text{ MHz}$ ;  $\sigma = 1.51 \text{ mho/m}$ ;  $\epsilon_r = 52$ ;  $\rho = 1000 \text{ kg/m}^3$

Phantom section: Flat Section

DASY4 Configuration:

- Probe: ET3DV6 - SN1711; ConvF(4.57, 4.57, 4.57); Calibrated: 9/17/2008
- Sensor-Surface: 4mm (Mechanical And Optical Surface Detection)
- Electronics: DAE3 Sn522; Calibrated: 9/16/2008
- Phantom: SAM 12; Type: TP-1217; Serial: QD000P40CA
- Measurement SW: DASY4, V4.7 Build 71; Postprocessing SW: SEMCAD, V1.8 Build 184

**C180/Area Scan (61x121x1):** Measurement grid:  $dx=10\text{mm}$ ,  $dy=10\text{mm}$

Maximum value of SAR (interpolated) = 0.998 mW/g

**C180/Zoom Scan (7x7x7)/Cube 0:** Measurement grid:  $dx=5\text{mm}$ ,  $dy=5\text{mm}$ ,  $dz=5\text{mm}$

Reference Value = 21.0 V/m; Power Drift = -0.178 dB

Peak SAR (extrapolated) = 1.54 W/kg

**SAR(1 g) = 0.759 mW/g; SAR(10 g) = 0.429 mW/g**

Maximum value of SAR (measured) = 0.884 mW/g

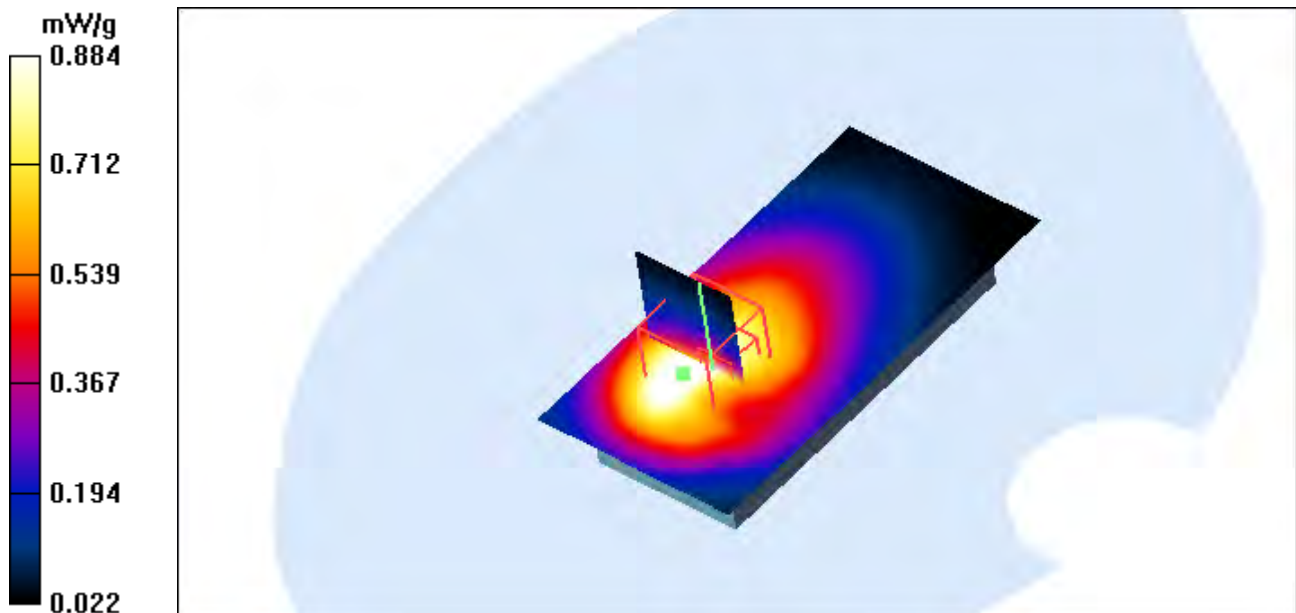

Test Laboratory: Eurofins Product Service GmbH

## GPRS\_1900\_ch661\_flat\_front\_10mm

**DUT: C180; Type: GSM phone; Serial: # 1**

Communication System: GSM 1900; Frequency: 1880 MHz; Duty Cycle: 1:2

Medium: Muscle 1900 MHz Medium parameters used:  $f = 1880$  MHz;  $\sigma = 1.55$  mho/m;  $\epsilon_r = 51.9$ ;  $\rho = 1000$  kg/m<sup>3</sup>

Phantom section: Flat Section

DASY4 Configuration:

- Probe: ET3DV6 - SN1711; ConvF(4.57, 4.57, 4.57); Calibrated: 9/17/2008
- Sensor-Surface: 4mm (Mechanical And Optical Surface Detection)
- Electronics: DAE3 Sn522; Calibrated: 9/16/2008
- Phantom: SAM 12; Type: TP-1217; Serial: QD000P40CA
- Measurement SW: DASY4, V4.7 Build 71; Postprocessing SW: SEMCAD, V1.8 Build 184

**C180/Area Scan (61x121x1):** Measurement grid: dx=10mm, dy=10mm

Maximum value of SAR (interpolated) = 0.813 mW/g

**C180/Zoom Scan (7x7x7)/Cube 0:** Measurement grid: dx=5mm, dy=5mm, dz=5mm

Reference Value = 13.2 V/m; Power Drift = -0.162 dB

Peak SAR (extrapolated) = 1.22 W/kg

**SAR(1 g) = 0.699 mW/g; SAR(10 g) = 0.393 mW/g**

Maximum value of SAR (measured) = 0.776 mW/g

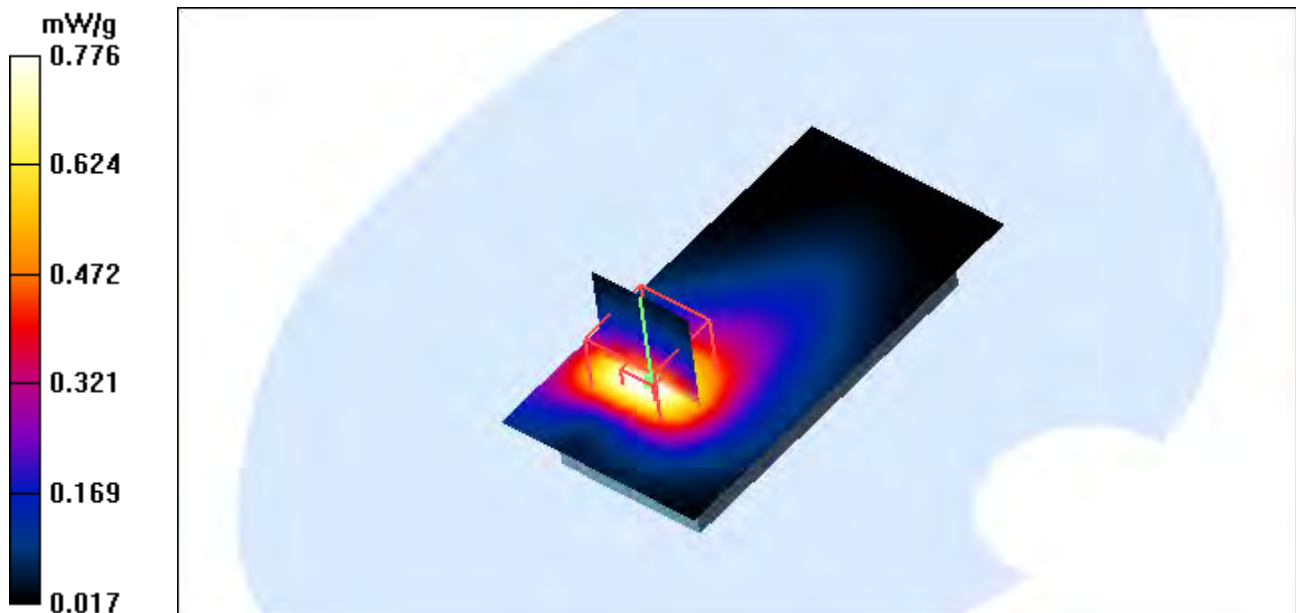

Test Laboratory: Eurofins Product Service GmbH

## GPRS\_1900\_ch661\_flat\_back\_15mm

**DUT: C180; Type: GSM phone; Serial: # 1**

Communication System: GSM 1900; Frequency: 1880 MHz; Duty Cycle: 1:2

Medium: Muscle 1900 MHz Medium parameters used:  $f = 1880$  MHz;  $\sigma = 1.55$  mho/m;  $\epsilon_r = 51.9$ ;  $\rho = 1000$  kg/m<sup>3</sup>

Phantom section: Flat Section

DASY4 Configuration:

- Probe: ET3DV6 - SN1711; ConvF(4.57, 4.57, 4.57); Calibrated: 9/17/2008
- Sensor-Surface: 4mm (Mechanical And Optical Surface Detection)
- Electronics: DAE3 Sn522; Calibrated: 9/16/2008
- Phantom: SAM 12; Type: TP-1217; Serial: QD000P40CA
- Measurement SW: DASY4, V4.7 Build 71; Postprocessing SW: SEMCAD, V1.8 Build 184

**C180/Area Scan (61x121x1):** Measurement grid: dx=10mm, dy=10mm

Maximum value of SAR (interpolated) = 0.869 mW/g

**C180/Zoom Scan (7x7x7)/Cube 0:** Measurement grid: dx=5mm, dy=5mm, dz=5mm

Reference Value = 17.4 V/m; Power Drift = 0.127 dB

Peak SAR (extrapolated) = 1.51 W/kg

**SAR(1 g) = 0.780 mW/g; SAR(10 g) = 0.442 mW/g**

Maximum value of SAR (measured) = 0.846 mW/g

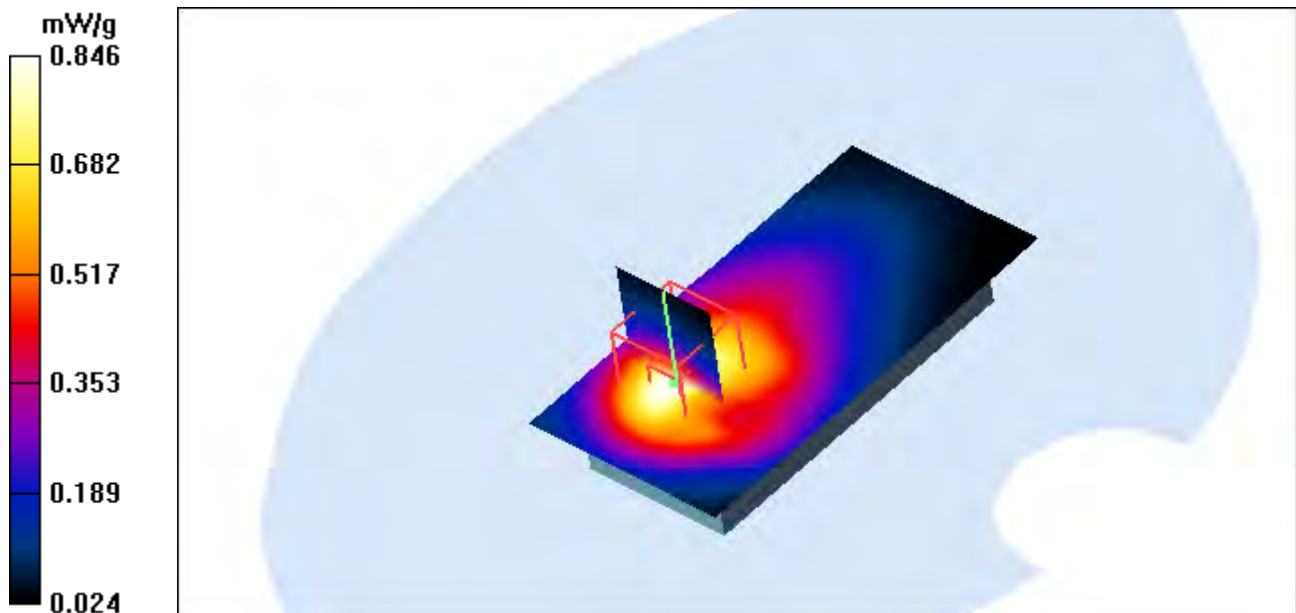

Test Laboratory: Eurofins Product Service GmbH

## GPRS\_1900\_ch810\_flat\_back\_15mm

**DUT: C180; Type: GSM phone; Serial: # 1**

Communication System: GSM 1900; Frequency: 1909.8 MHz; Duty Cycle: 1:2

Medium: Muscle 1900 MHz Medium parameters used:  $f = 1909.8$  MHz;  $\sigma = 1.59$  mho/m;  $\epsilon_r = 51.9$ ;

$\rho = 1000$  kg/m<sup>3</sup>

Phantom section: Flat Section

DASY4 Configuration:

- Probe: ET3DV6 - SN1711; ConvF(4.57, 4.57, 4.57); Calibrated: 9/17/2008
- Sensor-Surface: 4mm (Mechanical And Optical Surface Detection)
- Electronics: DAE3 Sn522; Calibrated: 9/16/2008
- Phantom: SAM 12; Type: TP-1217; Serial: QD000P40CA
- Measurement SW: DASY4, V4.7 Build 71; Postprocessing SW: SEMCAD, V1.8 Build 184

**C180/Area Scan (61x121x1):** Measurement grid: dx=10mm, dy=10mm

Maximum value of SAR (interpolated) = 0.764 mW/g

**C180/Zoom Scan (7x7x7)/Cube 0:** Measurement grid: dx=5mm, dy=5mm, dz=5mm

Reference Value = 16.2 V/m; Power Drift = 0.050 dB

Peak SAR (extrapolated) = 1.33 W/kg

**SAR(1 g) = 0.701 mW/g; SAR(10 g) = 0.398 mW/g**

Maximum value of SAR (measured) = 0.759 mW/g

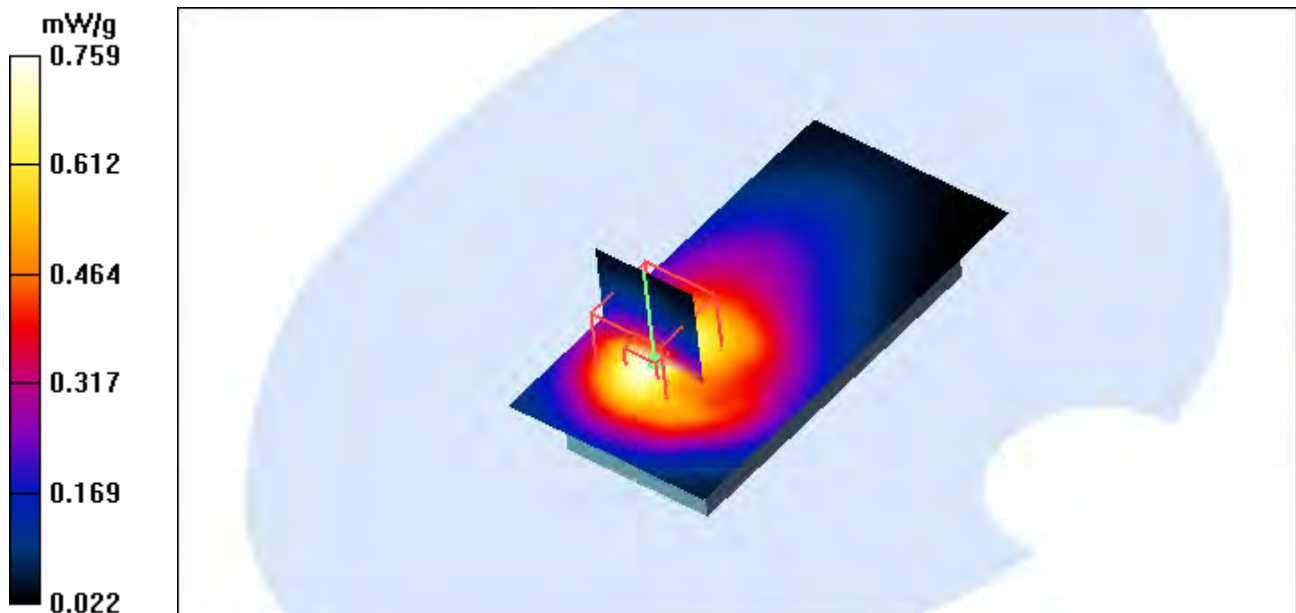

Test Laboratory: Eurofins Product Service GmbH

## Z-axis scan

**DUT: C180; Type: GSM phone; Serial: # 1**

Communication System: GSM 850; Frequency: 848.8 MHz; Duty Cycle: 1:2

Medium: Muscle 900 MHz Medium parameters used:  $f = 848.8$  MHz;  $\sigma = 0.944$  mho/m;  $\epsilon_r = 54.7$ ;  $\rho = 1000$  kg/m<sup>3</sup>

Phantom section: Flat Section

DASY4 Configuration:

- Probe: ET3DV6 - SN1711; ConvF(6.01, 6.01, 6.01); Calibrated: 9/17/2008
- Sensor-Surface: 4mm (Mechanical And Optical Surface Detection)
- Electronics: DAE3 Sn522; Calibrated: 9/16/2008
- Phantom: SAM 12; Type: TP-1217; Serial: QD000P40CA
- Measurement SW: DASY4, V4.7 Build 71; Postprocessing SW: SEMCAD, V1.8 Build 184

**C180/Area Scan (61x121x1):** Measurement grid: dx=10mm, dy=10mm

Maximum value of SAR (interpolated) = 1.31 mW/g

**C180/Zoom Scan (7x7x7)/Cube 0:** Measurement grid: dx=5mm, dy=5mm, dz=5mm

Reference Value = 32.7 V/m; Power Drift = 0.132 dB

Peak SAR (extrapolated) = 1.63 W/kg

**SAR(1 g) = 1.17 mW/g; SAR(10 g) = 0.813 mW/g**

Maximum value of SAR (measured) = 1.27 mW/g

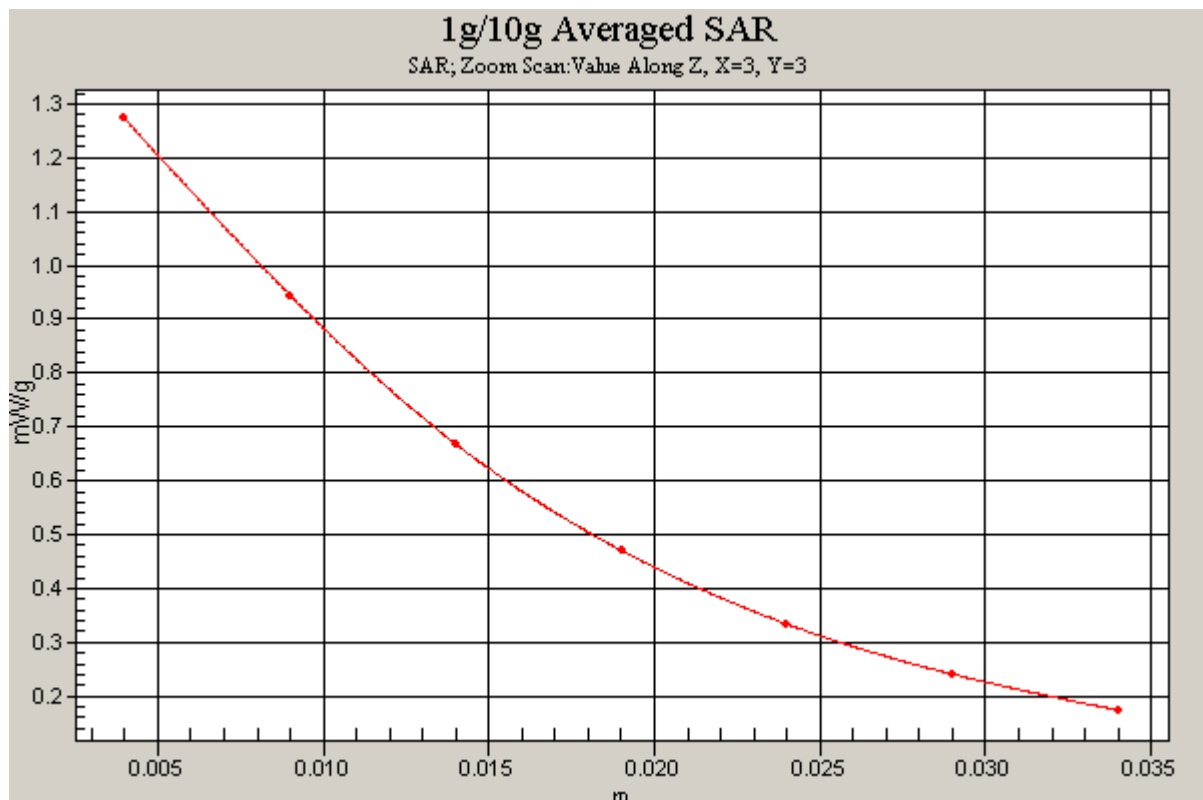

Test Laboratory: Eurofins Product Service GmbH

## GPRS\_850\_ch251\_flat\_back\_15mm - Z-axis scan

**DUT: C180; Type: GSM phone; Serial: # 1**

Communication System: GSM 850; Frequency: 848.8 MHz; Duty Cycle: 1:2

Medium: Muscle 900 MHz Medium parameters used:  $f = 848.8$  MHz;  $\sigma = 0.944$  mho/m;  $\epsilon_r = 54.7$ ;  $\rho = 1000$  kg/m<sup>3</sup>

Phantom section: Flat Section

DASY4 Configuration:

- Probe: ET3DV6 - SN1711; ConvF(6.01, 6.01, 6.01); Calibrated: 9/17/2008
- Sensor-Surface: 0mm (Fix Surface)
- Electronics: DAE3 Sn522; Calibrated: 9/16/2008
- Phantom: SAM 12; Type: TP-1217; Serial: QD000P40CA
- Measurement SW: DASY4, V4.7 Build 71; Postprocessing SW: SEMCAD, V1.8 Build 184

**C180/Z Scan (1x1x16):** Measurement grid: dx=20mm, dy=20mm, dz=20mm

Maximum value of SAR (interpolated) = 0.663 mW/g

