

FCC SAR Test Report

Equipment : InstaShow Button
Brand Name : BenQ
Model No. : WDC10T
FCC ID : JVPWDC10T
Standard : FCC 47 CFR Part 2 (2.1093)
ANSI/IEEE C95.1-1992
IEEE 1528-2013
Applicant : BenQ Corporation
16 Jihu Road, Neihu, Taipei 114,
Taiwan

The product sample received on May 05, 2016 and completely tested on May 06, 2016. We, SPORTON INTERNATIONAL INC., would like to declare that the tested sample has been evaluated in accordance with the procedures and shown the compliance with the applicable technical standards.

The test results in this report apply exclusively to the tested model / sample. Without written approval of SPORTON INTERNATIONAL INC., the test report shall not be reproduced except in full.

Reviewed by:

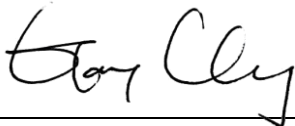

Gary Chang / Manager





Table of Contents

1	STATEMENT OF COMPLIANCE	5
1.1	Guidance Standard	5
1.2	Testing Location Information	5
2	EQUIPMENT UNDER TEST (EUT)	6
2.1	General Information.....	6
3	RF EXPOSURE LIMITS	7
3.1	Uncontrolled Environment	7
3.2	Controlled Environment	7
4	SPECIFIC ABSORPTION RATE (SAR)	8
4.1	Introduction.....	8
4.2	SAR Definition	8
5	SYSTEM DESCRIPTION AND SETUP	9
6	MEASUREMENT PROCEDURES	10
6.1	Spatial Peak SAR Evaluation	10
6.2	Power Reference Measurement.....	11
6.3	Area Scan.....	11
6.4	Zoom Scan	12
6.5	Volume Scan Procedures.....	12
6.6	Power Drift Monitoring.....	12
7	TEST EQUIPMENT LIST	13
8	SYSTEM VERIFICATION	14
8.1	Tissue Verification	14
8.2	System Performance Check Results	15
9	ANTENNA LOCATION	16
10	CONDUCTED RF OUTPUT POWER (UNIT: DBM)	17
11	SAR TEST RESULTS	18
12	REPEATED SAR MEASUREMENT	19
13	UNCERTAINTY ASSESSMENT	20
14	REFERENCES	23



APPENDIX A. Plots of System Performance Check

APPENDIX B. Plots of SAR Measurement

APPENDIX C. DASY Calibration Certificate

APPENDIX D. Test setup Photos



1 Statement of Compliance

The maximum results of Specific Absorption Rate (SAR) found during testing as follows.

Exposure Position	Frequency Band	Reported 1g SAR (W/kg)	Equipment Class	Highest Reported 1g SAR (W/kg)
Body	WLAN 5.2 GHz Band	1.18	NII	1.18
	WLAN 5.8 GHz Band	0.86		

This device is in compliance with Specific Absorption Rate (SAR) for general population/uncontrolled exposure limits (1.6 W/kg) specified in FCC 47 CFR part 2 (2.1093) and ANSI/IEEE C95.1-1992, and had been tested in accordance with the measurement methods and procedures specified in IEEE 1528-2013 and FCC KDB publications.

1.1 Guidance Standard

The Specific Absorption Rate (SAR) testing specification, method, and procedure for this device is in accordance with the following standards:

- FCC 47 CFR Part 2 (2.1093)
- ANSI/IEEE C95.1-1992
- IEEE 1528-2013
- FCC KDB 865664 D01 SAR Measurement 100 MHz to 6 GHz v01r04
- FCC KDB 865664 D02 RF Exposure Reporting v01r02
- FCC KDB 447498 D01 General RF Exposure Guidance v06
- FCC KDB 248227 D01 802.11 Wi-Fi SAR v02r02

1.2 Testing Location Information

Testing Location	
Wen	ADD : No. 13-1, Ln. 19, Wen 33rd St., Kwei-Shan Hsiag, Tao Yuan Hsien, Taiwan, R.O.C. TEL : 886-3-3180792



2 Equipment Under Test (EUT)

2.1 General Information

Product Feature & Specification	
Equipment Name	InstaShow Button
Brand Name	BenQ
Model Name	WDC10T
FCC ID	JVPWDC10T
Frequency Range	5180 ~ 5240 MHz 5745 ~ 5825 MHz
Antenna	SMD Chip antenna with 5.71 dBi gain
EUT Stage	Identical Prototype



3 RF Exposure Limits

3.1 Uncontrolled Environment

Uncontrolled Environments are defined as locations where there is the exposure of individuals who have no knowledge or control of their exposure. The general population/uncontrolled exposure limits are applicable to situations in which the general public may be exposed or in which persons who are exposed as a consequence of their employment may not be made fully aware of the potential for exposure or cannot exercise control over their exposure. Members of the general public would come under this category when exposure is not employment-related; for example, in the case of a wireless transmitter that exposes persons in its vicinity.

3.2 Controlled Environment

Controlled Environments are defined as locations where there is exposure that may be incurred by persons who are aware of the potential for exposure, (i.e. as a result of employment or occupation). In general, occupational/controlled exposure limits are applicable to situations in which persons are exposed as a consequence of their employment, who have been made fully aware of the potential for exposure and can exercise control over their exposure. The exposure category is also applicable when the exposure is of a transient nature due to incidental passage through a location where the exposure levels may be higher than the general population/uncontrolled limits, but the exposed person is fully aware of the potential for exposure and can exercise control over his or her exposure by leaving the area or by some other appropriate means.

Limits for Occupational/Controlled Exposure (W/kg)

Whole-Body	Partial-Body	Hands, Wrists, Feet and Ankles
0.4	8	20

Limits for General Population/Uncontrolled Exposure (W/kg)

Whole-Body	Partial-Body	Hands, Wrists, Feet and Ankles
0.08	1.6	4.0

1. Whole-Body SAR is averaged over the entire body, partial-body SAR is averaged over any 1gram of tissue defined as a tissue volume in the shape of a cube. SAR for hands, wrists, feet and ankles is averaged over any 10 grams of tissue defined as a tissue volume in the shape of a cube.

4 Specific Absorption Rate (SAR)

4.1 Introduction

SAR is related to the rate at which energy is absorbed per unit mass in an object exposed to a radio field. The SAR distribution in a biological body is complicated and is usually carried out by experimental techniques or numerical modeling. The standard recommends limits for two tiers of groups, occupational/controlled and general population/uncontrolled, based on a person's awareness and ability to exercise control over his or her exposure. In general, occupational/controlled exposure limits are higher than the limits for general population/uncontrolled.

4.2 SAR Definition

The SAR definition is the time derivative (rate) of the incremental energy (dW) absorbed by (dissipated in) an incremental mass (dm) contained in a volume element (dv) of a given density (ρ). The equation description is as below:

$$\text{SAR} = \frac{d}{dt} \left(\frac{dW}{dm} \right) = \frac{d}{dt} \left(\frac{dW}{\rho dv} \right)$$

SAR is expressed in units of Watts per kilogram (W/kg)

$$\text{SAR} = \frac{\sigma |E|^2}{\rho}$$

Where: σ is the conductivity of the tissue, ρ is the mass density of the tissue and E is the RMS electrical field strength.

5 System Description and Setup

The DASY system used for performing compliance tests consists of the following items:

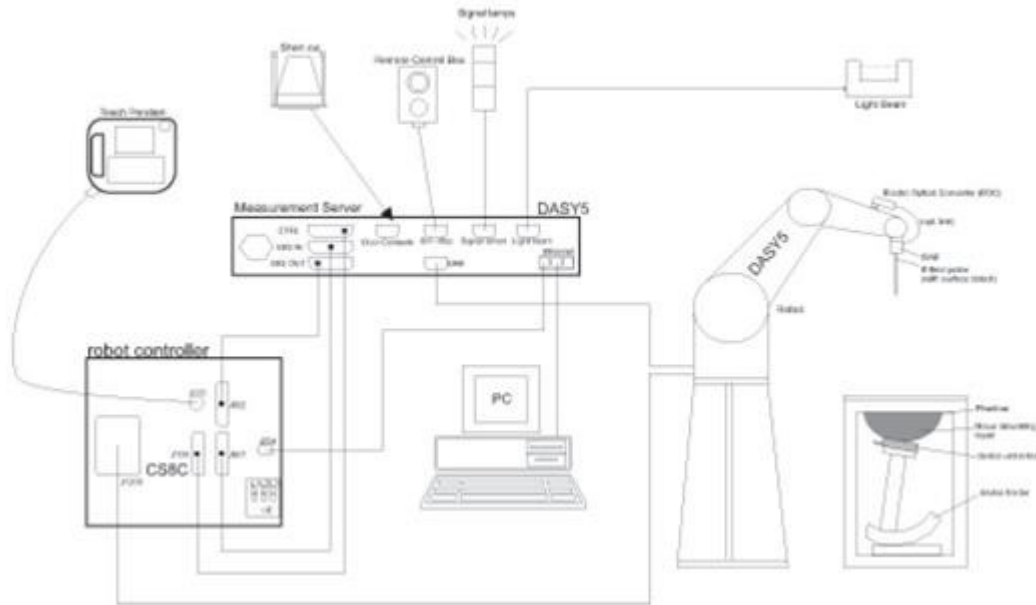

- A standard high precision 6-axis robot with controller, teach pendant and software. An arm extension for accommodating the data acquisition electronics (DAE).
- An isotropic Field probe optimized and calibrated for the targeted measurement.
- A data acquisition electronics (DAE) which performs the signal amplification, signal multiplexing, AD-conversion, offset measurements, mechanical surface detection, collision detection, etc. The unit is battery powered with standard or rechargeable batteries. The signal is optically transmitted to the EOC.
- The Electro-optical converter (EOC) performs the conversion from optical to electrical signals for the digital communication to the DAE. To use optical surface detection, a special version of the EOC is required. The EOC signal is transmitted to the measurement server.
- The function of the measurement server is to perform the time critical tasks such as signal filtering, control of the robot operation and fast movement interrupts.
- The Light Beam used is for probe alignment. This improves the (absolute) accuracy of the probe positioning.
- A computer running WinXP or Win7 and the DASY5 software.
- Remote control and teach pendant as well as additional circuitry for robot safety such as warning lamps, etc.
- The phantom, the device holder and other accessories according to the targeted measurement.

6 Measurement Procedures

The measurement procedures are as follows:

<Conducted power measurement>

- (a) For WWAN power measurement, use base station simulator to configure EUT WWAN transmission in conducted connection with RF cable, at maximum power in each supported wireless interface and frequency band.
- (b) Read the WWAN RF power level from the base station simulator.
- (c) For WLAN/BT power measurement, use engineering software to configure EUT WLAN/BT continuously transmission, at maximum RF power in each supported wireless interface and frequency band
- (d) Connect EUT RF port through RF cable to the power meter, and measure WLAN/BT output power

<SAR measurement>

- (a) Use base station simulator to configure EUT WWAN transmission in radiated connection, and engineering software to configure EUT WLAN/BT continuously transmission, at maximum RF power, in the highest power channel.
- (b) Place the EUT in the positions as Appendix D demonstrates.
- (c) Set scan area, grid size and other setting on the DASY software.
- (d) Measure SAR results for the highest power channel on each testing position.
- (e) Find out the largest SAR result on these testing positions of each band
- (f) Measure SAR results for other channels in worst SAR testing position if the reported SAR of highest power channel is larger than 0.8 W/kg

According to the test standard, the recommended procedure for assessing the peak spatial-average SAR value consists of the following steps:

- (a) Power reference measurement
- (b) Area scan
- (c) Zoom scan
- (d) Power drift measurement

6.1 Spatial Peak SAR Evaluation

The procedure for spatial peak SAR evaluation has been implemented according to the test standard. It can be conducted for 1g and 10g, as well as for user-specific masses. The DASY software includes all numerical procedures necessary to evaluate the spatial peak SAR value.

The base for the evaluation is a "cube" measurement. The measured volume must include the 1g and 10g cubes with the highest averaged SAR values. For that purpose, the center of the measured volume is aligned to the interpolated peak SAR value of a previously performed area scan.

The entire evaluation of the spatial peak values is performed within the post-processing engine (SEMCAD). The system always gives the maximum values for the 1g and 10g cubes. The algorithm to find the cube with highest averaged SAR is divided into the following stages:

- (a) Extraction of the measured data (grid and values) from the Zoom Scan
- (g) Calculation of the SAR value at every measurement point based on all stored data (A/D values and measurement parameters)
- (b) Generation of a high-resolution mesh within the measured volume
- (c) Interpolation of all measured values from the measurement grid to the high-resolution grid
- (d) Extrapolation of the entire 3-D field distribution to the phantom surface over the distance from sensor to surface
- (e) Calculation of the averaged SAR within masses of 1g and 10g

6.2 Power Reference Measurement

The Power Reference Measurement and Power Drift Measurements are for monitoring the power drift of the device under test in the batch process. The minimum distance of probe sensors to surface determines the closest measurement point to phantom surface. This distance cannot be smaller than the distance of sensor calibration points to probe tip as defined in the probe properties.

6.3 Area Scan

The area scan is used as a fast scan in two dimensions to find the area of high field values, before doing a fine measurement around the hot spot. The sophisticated interpolation routines implemented in DASY software can find the maximum found in the scanned area, within a range of the global maximum. The range (in dB) is specified in the standards for compliance testing. For example, a 2 dB range is required in IEEE standard 1528 and IEC 62209 standards, whereby 3 dB is a requirement when compliance is assessed in accordance with the ARIB standard (Japan), if only one zoom scan follows the area scan, then only the absolute maximum will be taken as reference. For cases where multiple maximums are detected, the number of zoom scans has to be increased accordingly.

Area scan parameters extracted from FCC KDB 865664 D01 v01r04 SAR measurement 100 MHz to 6 GHz .

	≤ 3 GHz	> 3 GHz
Maximum distance from closest measurement point (geometric center of probe sensors) to phantom surface	5 ± 1 mm	$\frac{1}{2} \cdot \delta \cdot \ln(2) \pm 0.5$ mm
Maximum probe angle from probe axis to phantom surface normal at the measurement location	30° ± 1°	20° ± 1°
Maximum area scan spatial resolution: Δx_{Area} , Δy_{Area}	≤ 2 GHz: ≤ 15 mm 2 – 3 GHz: ≤ 12 mm	3 – 4 GHz: ≤ 12 mm 4 – 6 GHz: ≤ 10 mm
	When the x or y dimension of the test device, in the measurement plane orientation, is smaller than the above, the measurement resolution must be ≤ the corresponding x or y dimension of the test device with at least one measurement point on the test device.	

6.4 Zoom Scan

Zoom scans are used to assess the peak spatial SAR values within a cubic averaging volume containing 1 gram and 10 gram of simulated tissue. The zoom scan measures points (refer to table below) within a cube whose base faces are centered on the maxima found in a preceding area scan job within the same procedure. When the measurement is done, the zoom scan evaluates the averaged SAR for 1 gram and 10 gram and displays these values next to the job's label.

Zoom scan parameters extracted from FCC KDB 865664 D01 v01r04 SAR measurement 100 MHz to 6 GHz.

		≤ 3 GHz	> 3 GHz	
Maximum zoom scan spatial resolution: Δx_{Zoom} , Δy_{Zoom}		≤ 2 GHz: ≤ 8 mm 2 – 3 GHz: ≤ 5 mm *	3 – 4 GHz: ≤ 5 mm* 4 – 6 GHz: ≤ 4 mm*	
Maximum zoom scan spatial resolution, normal to phantom surface	uniform grid: $\Delta z_{Zoom}(n)$	≤ 5 mm	3 – 4 GHz: ≤ 4 mm 4 – 5 GHz: ≤ 3 mm 5 – 6 GHz: ≤ 2 mm	
	graded grid	$\Delta z_{Zoom}(1)$: between 1 st two points closest to phantom surface	≤ 4 mm	3 – 4 GHz: ≤ 3 mm 4 – 5 GHz: ≤ 2.5 mm 5 – 6 GHz: ≤ 2 mm
		$\Delta z_{Zoom}(n>1)$: between subsequent points	$\leq 1.5 \cdot \Delta z_{Zoom}(n-1)$	
Minimum zoom scan volume	x, y, z	≥ 30 mm	3 – 4 GHz: ≥ 28 mm 4 – 5 GHz: ≥ 25 mm 5 – 6 GHz: ≥ 22 mm	
<p>Note: δ is the penetration depth of a plane-wave at normal incidence to the tissue medium; see draft standard IEEE P1528-2011 for details.</p> <p>* When zoom scan is required and the <i>reported</i> SAR from the <i>area scan based 1-g SAR estimation</i> procedures of KDB 447498 is ≤ 1.4 W/kg, ≤ 8 mm, ≤ 7 mm and ≤ 5 mm zoom scan resolution may be applied, respectively, for 2 GHz to 3 GHz, 3 GHz to 4 GHz and 4 GHz to 6 GHz.</p>				

6.5 Volume Scan Procedures

The volume scan is used to assess overlapping SAR distributions for antennas transmitting in different frequency bands. It is equivalent to an oversized zoom scan used in standalone measurements. The measurement volume will be used to enclose all the simultaneous transmitting antennas. For antennas transmitting simultaneously in different frequency bands, the volume scan is measured separately in each frequency band. In order to sum correctly to compute the 1g aggregate SAR, the EUT remain in the same test position for all measurements and all volume scan use the same spatial resolution and grid spacing. When all volume scan were completed, the software, SEMCAD postprocessor can combine and subsequently superpose these measurement data to calculating the multiband SAR.

6.6 Power Drift Monitoring

All SAR testing is under the EUT install full charged battery and transmit maximum output power. In DASY measurement software, the power reference measurement and power drift measurement procedures are used for monitoring the power drift of EUT during SAR test. Both these procedures measure the field at a specified reference position before and after the SAR testing. The software will calculate the field difference in dB. If the power drifts more than 5%, the SAR will be retested.



7 Test Equipment List

Manufacturer	Name of Equipment	Type/Model	Serial Number	Calibration	
				Last Cal.	Due Date
SPEAG	Data Acquisition Electronics	DAE4	1424	2016/2/16	2017/2/15
SPEAG	Dosimetric E-Field Probe	EX3DV4	3976	2016/2/22	2017/2/21
SPEAG	5000MHz System Validation Kit	D5GHzV2	1171	2016/2/17	2017/2/16
SPEAG	Device Holder	N/A	N/A	NCR	NCR
Mini-Circuits	Power Amplifier	ZVE-8G+	605601404	NCR	NCR
Agilent	ENA Series Network Analyzer	E5071C	MY46419201	2016/1/21	2017/1/20
Agilent	EXA Signal Analyzer	N9010A	MY54200432	2015/8/12	2016/8/11
R&S	Signal Generator	SMB100A	175727	2015/10/5	2016/10/4
SPEAG	Dielectric Probe Kit	SM DAK 040CA	1146	NCR	NCR
Anritsu	Power Meter	ML2495A	1124009	2016/2/22	2017/2/21
Anritsu	Power sensor	MA2411B	1027452	2016/2/22	2017/2/21
Anritsu	Power Meter	ML2495A	0949003	2016/2/4	2017/2/3
Anritsu	Power sensor	MA2411B	0917017	2016/2/4	2017/2/3
SPEAG	Flat Phantom ELI5.0	QD OVA 002 AA	1238	NCR	NCR
Wisewind	Themometer	HTC1	HTC1	2015/12/24	2016/12/23
Wisewind	Themometer	YF-160A	130504609	2015/12/24	2016/12/23

General Note:

1. The calibration certificate of DASY can be referred to appendix C of this report.
2. The Insertion Loss calibration of Dual Directional Coupler and Attenuator were characterized via the network analyzer and compensated during system check.
3. In system check we need to monitor the level on the power meter, and adjust the power amplifier level to have precise power level to the dipole; the measured SAR will be normalized to 1W input power according to the ratio of 1W to the input power to the dipole. For system check, the calibration of the power amplifier is deemed not critically required for correct measurement; the power meter is critical and we do have calibration for it
4. Attenuator 1 insertion loss is calibrated by the network Analyzer, which the calibration is valid, before system check.
5. NCR: No calibration request.



8 System Verification

8.1 Tissue Verification

The following tissue formulations are provided for reference only as some of the parameters have not been thoroughly verified. The composition of ingredients may be modified accordingly to achieve the desired target tissue parameters required for routine SAR evaluation.

Simulating Liquid for 5GHz, Manufactured by SPEAG

Ingredients	(% by weight)
Water	64~78%
Mineral oil	11~18%
Emulsifiers	9~15%
Additives and Salt	2~3%

<Tissue Dielectric Parameter Check Results>

Frequency (MHz)	Liquid Temp. (°C)	Conductivity (σ)	Permittivity (ϵ_r)	Conductivity Target (σ)	Permittivity Target (ϵ_r)	Delta (σ) (%)	Delta (ϵ_r) (%)	Limit (%)	Date
5200	22.6	5.356	48.714	5.3	49	1.06	-0.58	±5	2016/5/6
5800	22.6	6.162	47.581	6	48.2	2.70	-1.28	±5	2016/5/6

8.2 System Performance Check Results

Comparing to the original SAR value provided by SPEAG, the verification data should be within its specification of 10 %. Below table shows the target SAR and measured SAR after normalized to 1W input power. The table below indicates the system performance check can meet the variation criterion and the plots can be referred to Appendix A of this report.

Date	Frequency (MHz)	Tissue Type	Input Power (mW)	Dipole S/N	Probe S/N	DAE S/N	Measured SAR (W/kg)	Targeted SAR (W/kg)	Normalized SAR (W/kg)	Deviation (%)
2016/5/6	5200	Body	100	1171	3976	1424	7.32	73.6	73.20	-0.543
2016/5/6	5800	Body	100	1171	3976	1424	7.92	75.6	79.20	4.762

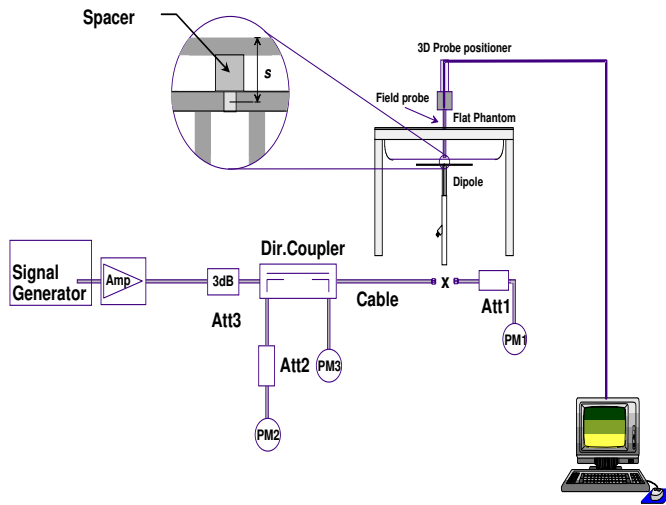

System Performance Check Setup



Setup Photo

9 Antenna Location

6 positons are tested as below

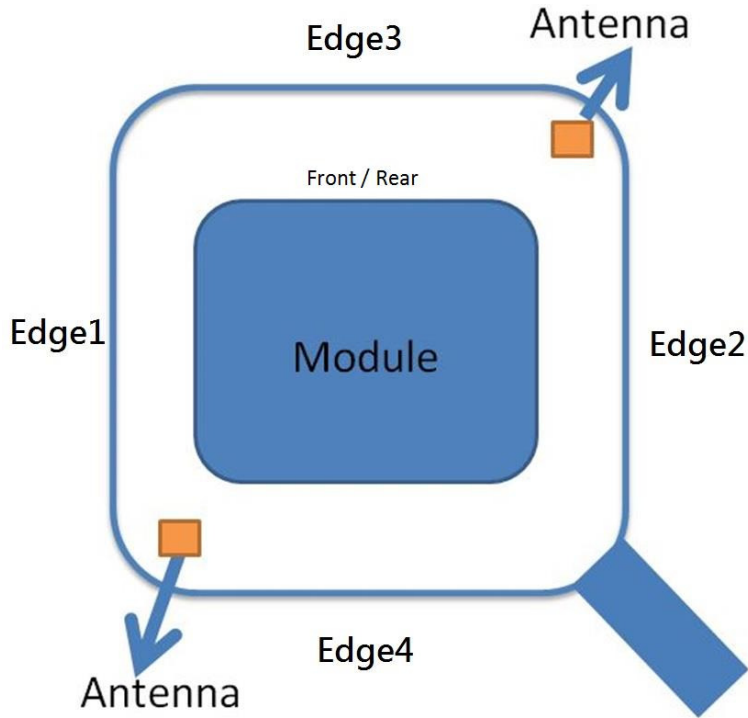



10 Conducted RF Output Power (Unit: dBm)

General Note:

1. SAR test reduction is determined according to 802.11 transmission mode configurations and certain exposure conditions with multiple test positions. In the 2.4 GHz band, separate SAR procedures are applied to DSSS and OFDM configurations to simplify DSSS test requirements. For OFDM, in both 2.4 and 5 GHz bands, an initial test configuration must be determined for each standalone and aggregated frequency band, according to the transmission mode configuration with the highest maximum output power specified for production units to perform SAR measurements. If the same highest maximum output power applies to different combinations of channel bandwidths, modulations and data rates, additional procedures are applied to determine which test configurations require SAR measurement
2. For OFDM transmission configurations in the 2.4 GHz and 5 GHz bands, When the same maximum power is specified for multiple transmission modes in a frequency band, the largest channel bandwidth, lowest order modulation, lowest data rate and lowest order 802.11a/g/n/ac mode is used for SAR measurement, on the highest measured output power channel for each frequency band.
3. DSSS and OFDM configurations are considered separately according to the required SAR procedures. SAR is measured in the initial test position using the 802.11 transmission mode configuration required by the DSSS procedure or initial test configuration and subsequent test configuration(s) according to the OFDM procedures.18 The initial test position procedure is described in the following:
 - a. When the reported SAR of the initial test position is ≤ 0.4 W/kg, further SAR measurement is not required for the other test positions in that exposure configuration and 802.11 transmission mode combinations within the frequency band or aggregated band.
 - b. When the reported SAR of the test position is > 0.4 W/kg, SAR is repeated for the 802.11 transmission mode configuration tested in the initial test position to measure the subsequent next closet/smallest test separation distance and maximum coupling test position on the highest maximum output power channel, until the report SAR is ≤ 0.8 W/kg or all required test position are tested
 - c. For all positions/configurations, when the reported SAR is > 0.8 W/kg, SAR is measured for these test positions/configurations on the subsequent next highest measured output power channel(s) until the reported SAR is ≤ 1.2 W/kg or all required channels are tested.
4. Duty cycle of test signal is as below table

Mode	Data rate	Duty cycle (%)	Duty factor
VHT40	MCS0	100.00%	1

5.2GHz

Average Power (dBm)									
Mode	Channel	Frequency (MHz)	Data rates	Conducted Power(dBm)			Scaling factor	Tune Up Limit (dBm)	Power Setting
				Chain 0	Chain 1	Total			
VHT40	38	5190	MCS 0	14.32	14.03	17.19	1.075	17.50	24/17
	46	5230	MCS 0	14.21	14.05	17.14	1.086	17.50	24/17

5.8GHz

Average Power (dBm)									
Mode	Channel	Frequency (MHz)	Data rates	Conducted Power(dBm)			Scaling factor	Tune Up Limit (dBm)	Power Setting
				Chain 0	Chain 1	Total			
VHT40	151	5755	MCS 0	14.03	14.12	17.09	1.100	17.50	30/20
	159	5795	MCS 0	14.05	14.09	17.08	1.101	17.50	30/20



11 SAR Test Results

Plot No.	Mode	Test Position	Gap (cm)	Ch.	Freq. (MHz)	Conducted Power (dBm)	Tune-Up Limit (dBm)	Tune-up Scaling Factor	Duty factor	Power Drift (dB)	Measured 1g SAR (W/kg)	Reported 1g SAR (W/kg)
1	802.11ac VHT40	Front Face	0	38	5190	17.19	17.5	1.07	1	-0.05	1.1	1.18
2	802.11ac VHT40	Rear Face	0	38	5190	17.19	17.5	1.07	1	0.09	0.239	0.26
3	802.11ac VHT40	Edge1	0	38	5190	17.19	17.5	1.07	1	-0.04	0.473	0.51
4	802.11ac VHT40	Edge2	0	38	5190	17.19	17.5	1.07	1	0.07	0.304	0.33
5	802.11ac VHT40	Edge3	0	38	5190	17.19	17.5	1.07	1	-0.03	0.558	0.60
6	802.11ac VHT40	Edge4	0	38	5190	17.19	17.5	1.07	1	-0.06	0.33	0.35
7	802.11ac VHT40	Front Face	0	46	5230	17.14	17.5	1.09	1	0.05	1.03	1.12
16	802.11ac VHT40	Front Face	0	151	5755	17.09	17.5	1.10	1	-0.02	0.778	0.86
11	802.11ac VHT40	Rear Face	0	151	5755	17.09	17.5	1.10	1	-0.02	0.235	0.26
12	802.11ac VHT40	Edge1	0	151	5755	17.09	17.5	1.10	1	-0.09	0.283	0.31
13	802.11ac VHT40	Edge2	0	151	5755	17.09	17.5	1.10	1	0.08	0.296	0.33
14	802.11ac VHT40	Edge3	0	151	5755	17.09	17.5	1.10	1	0.05	0.208	0.23
15	802.11ac VHT40	Edge4	0	151	5755	17.09	17.5	1.10	1	-0.05	0.17	0.19
19	802.11ac VHT40	Front Face	0	159	5795	17.08	17.5	1.10	1	0.02	0.65	0.72

Test Engineer : Tom

General Note:

1. Per KDB 447498 D01v06, the reported SAR is the measured SAR value adjusted for maximum tune-up tolerance.
 - a. Tune-up scaling Factor = tune-up limit power (mW) / EUT RF power (mW), where tune-up limit is the maximum rated power among all production units.
 - b. For SAR testing of WLAN signal with non-100% duty cycle, the measured SAR is scaled-up by the duty cycle scaling factor which is equal to "1/(duty cycle)"
 - c. For WLAN: Reported SAR(W/kg)= Measured SAR(W/kg)*Tune-up Scaling Factor*duty factor
2. Per KDB 447498 D01v06, for each exposure position, testing of other required channels within the operating mode of a frequency band is not required when the *reported* 1-g or 10-g SAR for the mid-band or highest output power channel is:
 - ≤ 0.8 W/kg or 2.0 W/kg, for 1-g or 10-g respectively, when the transmission band is ≤ 100 MHz
 - ≤ 0.6 W/kg or 1.5 W/kg, for 1-g or 10-g respectively, when the transmission band is between 100 MHz and 200 MHz
 - ≤ 0.4 W/kg or 1.0 W/kg, for 1-g or 10-g respectively, when the transmission band is ≥ 200 MHz
3. When the WLAN transmission was verified using a spectrum analyzer.



12 Repeated SAR Measurement

Plot No.	Mode	Test Position	Gap (cm)	Ch.	Freq. (MHz)	Conducted Power (dBm)	Tune-Up Limit (dBm)	Tune-up Scaling Factor	Duty factor	Power Drift (dB)	Measured 1g SAR (W/kg)	Reported 1g SAR (W/kg)
8	802.11ac VHT40	Front Face	0	38	5190	17.19	17.5	1.07	1	0.02	1.04	1.11

Note: Original measured SAR / Repeated Measured SAR = 1.18 / 1.11 = 1.06

Plot No.	Mode	Test Position	Gap (cm)	Ch.	Freq. (MHz)	Conducted Power (dBm)	Tune-Up Limit (dBm)	Tune-up Scaling Factor	Duty factor	Power Drift (dB)	Measured 1g SAR (W/kg)	Reported 1g SAR (W/kg)
20	802.11ac VHT40	Front Face	0	151	5755	17.09	17.5	1.10	1	0.03	0.742	0.82

Note: Original measured SAR / Repeated Measured SAR = 0.86 / 0.82 = 1.05

Test Engineer : Tom

13 Uncertainty Assessment

The component of uncertainty may generally be categorized according to the methods used to evaluate them. The evaluation of uncertainty by the statistical analysis of a series of observations is termed a Type A evaluation of uncertainty. The evaluation of uncertainty by means other than the statistical analysis of a series of observation is termed a Type B evaluation of uncertainty. Each component of uncertainty, however evaluated, is represented by an estimated standard deviation, termed standard uncertainty, which is determined by the positive square root of the estimated variance.

A Type A evaluation of standard uncertainty may be based on any valid statistical method for treating data. This includes calculating the standard deviation of the mean of a series of independent observations; using the method of least squares to fit a curve to the data in order to estimate the parameter of the curve and their standard deviations; or carrying out an analysis of variance in order to identify and quantify random effects in certain kinds of measurement.

A type B evaluation of standard uncertainty is typically based on scientific judgment using all of the relevant information available. These may include previous measurement data, experience, and knowledge of the behavior and properties of relevant materials and instruments, manufacture’s specification, data provided in calibration reports and uncertainties assigned to reference data taken from handbooks. Broadly speaking, the uncertainty is either obtained from an outdoor source or obtained from an assumed distribution, such as the normal distribution, rectangular or triangular distributions indicated in Table 14.1

Uncertainty Distributions	Normal	Rectangular	Triangular	U-Shape
Multi-plying Factor ^(a)	1/ κ ^(b)	1/ $\sqrt{3}$	1/ $\sqrt{6}$	1/ $\sqrt{2}$

(a) standard uncertainty is determined as the product of the multiplying factor and the estimated range of variations in the measured quantity

(b) κ is the coverage factor

Standard Uncertainty for Assumed Distribution

The combined standard uncertainty of the measurement result represents the estimated standard deviation of the result. It is obtained by combining the individual standard uncertainties of both Type A and Type B evaluation using the usual “root-sum-squares” (RSS) methods of combining standard deviations by taking the positive square root of the estimated variances.

Expanded uncertainty is a measure of uncertainty that defines an interval about the measurement result within which the measured value is confidently believed to lie. It is obtained by multiplying the combined standard uncertainty by a coverage factor. Typically, the coverage factor ranges from 2 to 3. Using a coverage factor allows the true value of a measured quantity to be specified with a defined probability within the specified uncertainty range. For purpose of this document, a coverage factor two is used, which corresponds to confidence interval of about 95 %. The DASY uncertainty Budget is shown in the following tables.



Error Description	Uncertainty Value (±%)	Probability Distribution	Divisor	Ci (1g)	Standard Uncertainty (±%) (1g)
Measurement System					
Probe Calibration	6.0	Normal	1.0	1.0	6.0
Axial Isotropy	4.7	Rectangular	$\sqrt{3}$	0.7	1.9
Hemispherical Isotropy	9.6	Rectangular	$\sqrt{3}$	0.7	3.9
Boundary effects	1.0	Rectangular	$\sqrt{3}$	1.0	0.6
Linearity	4.7	Rectangular	$\sqrt{3}$	1.0	2.7
System Detection Limits	1.0	Rectangular	$\sqrt{3}$	1.0	0.6
Modulation Response	2.4	Rectangular	$\sqrt{3}$	1.0	1.4
Readout Electronics	0.3	Normal	1.0	1.0	0.3
Response Time	0.8	Rectangular	$\sqrt{3}$	1.0	0.5
Integration Time	2.6	Rectangular	$\sqrt{3}$	1.0	1.5
RF Ambient Noise	3.0	Rectangular	$\sqrt{3}$	1.0	1.7
RF Ambient Reflections	3.0	Rectangular	$\sqrt{3}$	1.0	1.7
Probe Positioner	0.4	Rectangular	$\sqrt{3}$	1.0	0.2
Probe Positioning	2.9	Rectangular	$\sqrt{3}$	1.0	1.7
Max. SAR Eval.	2.0	Rectangular	$\sqrt{3}$	1.0	1.2
Dipole Related					
Device Positioning	2.9	Normal	1.0	1.0	2.9
Device Holder	3.6	Normal	1.0	1.0	3.6
Power Drift	5.0	Rectangular	$\sqrt{3}$	1.0	2.9
Power Scaling	0.0	Rectangular	$\sqrt{3}$	1.0	0.0
Phantom and Tissue parameters					
Phantom Uncertainty	6.1	Rectangular	$\sqrt{3}$	1.0	3.5
SAR correction	1.9	Normal	1.0	1.0	1.9
Liquid Conductivity (measurement)	2.0	Normal	1.0	0.8	1.6
Liquid Permittivity (measurement)	2.1	Normal	1.0	0.3	0.5
Temp. unc. - Conduct	3.4	Rectangular	$\sqrt{3}$	0.8	1.5
Temp. unc. - Permittivity	0.4	Rectangular	$\sqrt{3}$	0.2	0.1
Combined Standard Uncertainty					11.2
Coverage Factor for 95 %					Kp=2
Expanded Uncertainty					22.4

Uncertainty Budget for frequency range 30 MHz to 3 GHz



Error Description	Uncertainty Value (±%)	Probability Distribution	Divisor	Ci (1g)	Standard Uncertainty (±%) (1g)
Measurement System					
Probe Calibration	6.6	Normal	1.0	1.0	6.6
Axial Isotropy	4.7	Rectangular	√3	0.7	1.9
Hemispherical Isotropy	9.6	Rectangular	√3	0.7	3.9
Boundary effects	2.0	Rectangular	√3	1.0	1.2
Linearity	4.7	Rectangular	√3	1.0	2.7
System Detection Limits	1.0	Rectangular	√3	1.0	0.6
Modulation Response	2.4	Rectangular	√3	1.0	1.4
Readout Electronics	0.3	Normal	1.0	1.0	0.3
Response Time	0.8	Rectangular	√3	1.0	0.5
Integration Time	2.6	Rectangular	√3	1.0	1.5
RF Ambient Noise	3.0	Rectangular	√3	1.0	1.7
RF Ambient Reflections	3.0	Rectangular	√3	1.0	1.7
Probe Positioner	0.8	Rectangular	√3	1.0	0.5
Probe Positioning	6.7	Rectangular	√3	1.0	3.9
Max. SAR Eval.	4.0	Rectangular	√3	1.0	2.3
Dipole Related					
Device Positioning	2.9	Normal	1.0	1.0	2.9
Device Holder	3.6	Normal	1.0	1.0	3.6
Power Drift	5.0	Rectangular	√3	1.0	2.9
Power Scaling	0.0	Rectangular	√3	1.0	0.0
Phantom and Tissue parameters					
Phantom Uncertainty	6.6	Rectangular	√3	1.0	3.8
SAR correction	1.9	Normal	1.0	1.0	1.9
Liquid Conductivity (measurement)	2.0	Normal	1.0	0.8	1.6
Liquid Permittivity (measurement)	2.1	Normal	1.0	0.3	0.5
Temp. unc. - Conduct	3.4	Rectangular	√3	0.8	1.5
Temp. unc. - Permittivity	0.4	Rectangular	√3	0.2	0.1
Combined Standard Uncertainty					12.3
Coverage Factor for 95 %					Kp=2
Expanded Uncertainty					24.7

Uncertainty Budget for frequency range 3 GHz to 6 GHz



14 References

- [1] FCC 47CFR Part 2 , "FREQUENCY ALLOCATIONS AND RADIO TREATY MATTERS; GENERAL RULES AND REGULATIONS"
- [2] IEEE Std. C95.1-1992, "IEEE Standard for Safety Levels with Respect to Human Exposure to Radio Frequency Electromagnetic Fields, 3 kHz to 300 GHz"
- [3] IEEE Std. 1528-2013, "IEEE Recommended Practice for Determining the Peak Spatial-Average Specific Absorption Rate (SAR) in the Human Head From Wireless Communications Devices: Measurement Techniques"
- [4] SPEAG DASY System Handbook
- [5] 447498 D01 General RF Exposure Guidance v06, "Mobile and Portable Devices RF Exposure Procedures and Equipment Authorization Policies"
- [6] 865664 D01 SAR Measurement 100 MHz to 6 GHz v01r04, "SAR Measurement Requirements for 100 MHz to 6 GHz"
- [7] 865664 D02 RF Exposure Reporting v01r02, "RF Exposure Compliance Reporting and Documentation Considerations"
- [8] 248227 D01 802.11 Wi-Fi SAR v02r02, "SAR Guidance for IEEE 802.11 (Wi-Fi) Transmitters"



APPENDIX A. Plots of System Performance Check

System Check_B5200_160506

DUT: Dipole D5GHzV2_SN: 1171

Communication System: CW; Frequency: 5200 MHz; Duty Cycle: 1:1

Medium: B5G_160506 Medium parameters used: $f = 5200$ MHz; $\sigma = 5.356$ S/m; $\epsilon_r = 48.714$; $\rho = 1000$ kg/m³

Ambient Temperature : 23.5 °C; Liquid Temperature : 22.6 °C

DASY5 Configuration:

- Probe: EX3DV4 - SN3976; ConvF(4.4, 4.4, 4.4); Calibrated: 2016/2/22;
- Sensor-Surface: 2mm (Mechanical Surface Detection)
- Electronics: DAE4 Sn1424; Calibrated: 2016/2/16
- Phantom: ELI v5.0; Type: QDOVA002AA; Serial: TP:1238
- Measurement SW: DASY52, Version 52.8 (8); SEMCAD X Version 14.6.10 (7331)

Pin=100mW/Area Scan (91x91x1): Interpolated grid: dx=1.000 mm, dy=1.000 mm
Maximum value of SAR (interpolated) = 14.3 W/kg

Pin=100mW/Zoom Scan (7x7x12)/Cube 0: Measurement grid: dx=4mm, dy=4mm, dz=2mm
Reference Value = 56.63 V/m; Power Drift = 0.02 dB
Peak SAR (extrapolated) = 29.7 W/kg
SAR(1 g) = 7.32 W/kg; SAR(10 g) = 2.09 W/kg
Maximum value of SAR (measured) = 15.3 W/kg

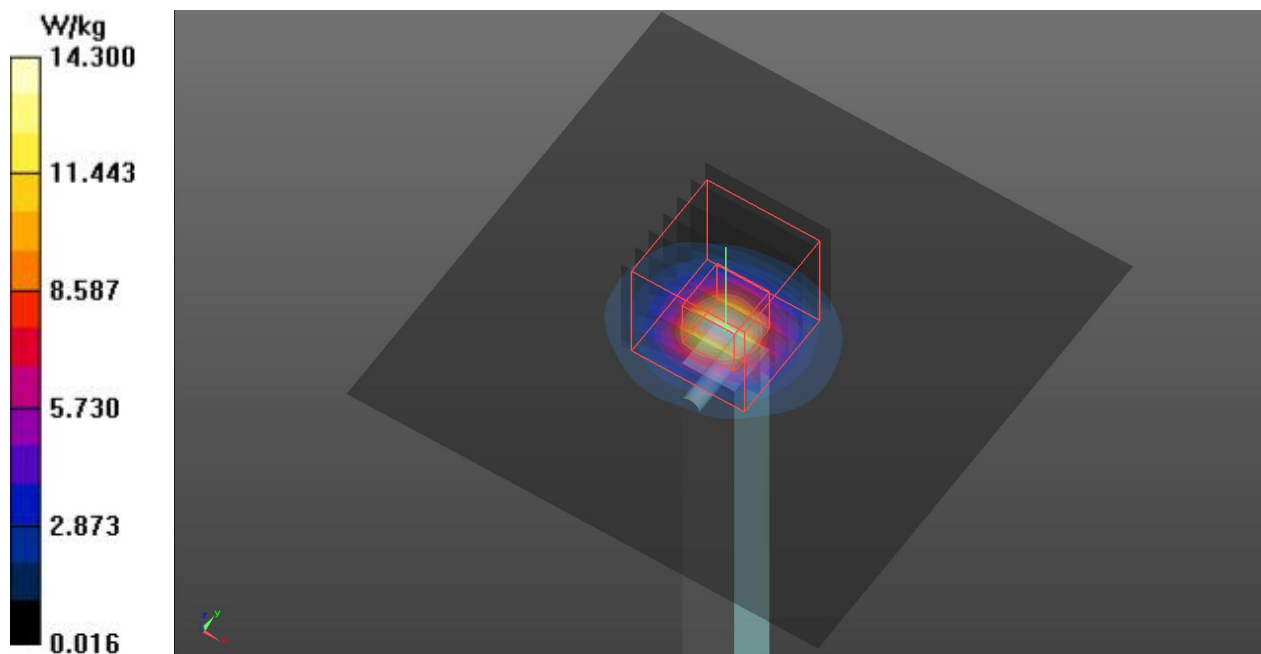

System Check_B5800_160506

DUT: Dipole D5GHzV2_ SN: 1171

Communication System: CW; Frequency: 5800 MHz; Duty Cycle: 1:1

Medium: B5G_160506 Medium parameters used: $f = 5800$ MHz; $\sigma = 6.162$ S/m; $\epsilon_r = 47.581$; $\rho = 1000$ kg/m³

Ambient Temperature : 23.5 °C; Liquid Temperature : 22.6 °C

DASY5 Configuration:

- Probe: EX3DV4 - SN3976; ConvF(3.96, 3.96, 3.96); Calibrated: 2016/2/22;
- Sensor-Surface: 2mm (Mechanical Surface Detection)
- Electronics: DAE4 Sn1424; Calibrated: 2016/2/16
- Phantom: ELI v5.0; Type: QDOVA002AA; Serial: TP:1238
- Measurement SW: DASY52, Version 52.8 (8); SEMCAD X Version 14.6.10 (7331)

Pin=100mW/Area Scan (91x91x1): Interpolated grid: dx=1.000 mm, dy=1.000 mm

Maximum value of SAR (interpolated) = 15.8 W/kg

Pin=100mW/Zoom Scan (7x7x12)/Cube 0: Measurement grid: dx=4mm, dy=4mm, dz=2mm

Reference Value = 57.90 V/m; Power Drift = 0.09 dB

Peak SAR (extrapolated) = 33.8 W/kg

SAR(1 g) = 7.92 W/kg; SAR(10 g) = 2.23 W/kg

Maximum value of SAR (measured) = 17.0 W/kg

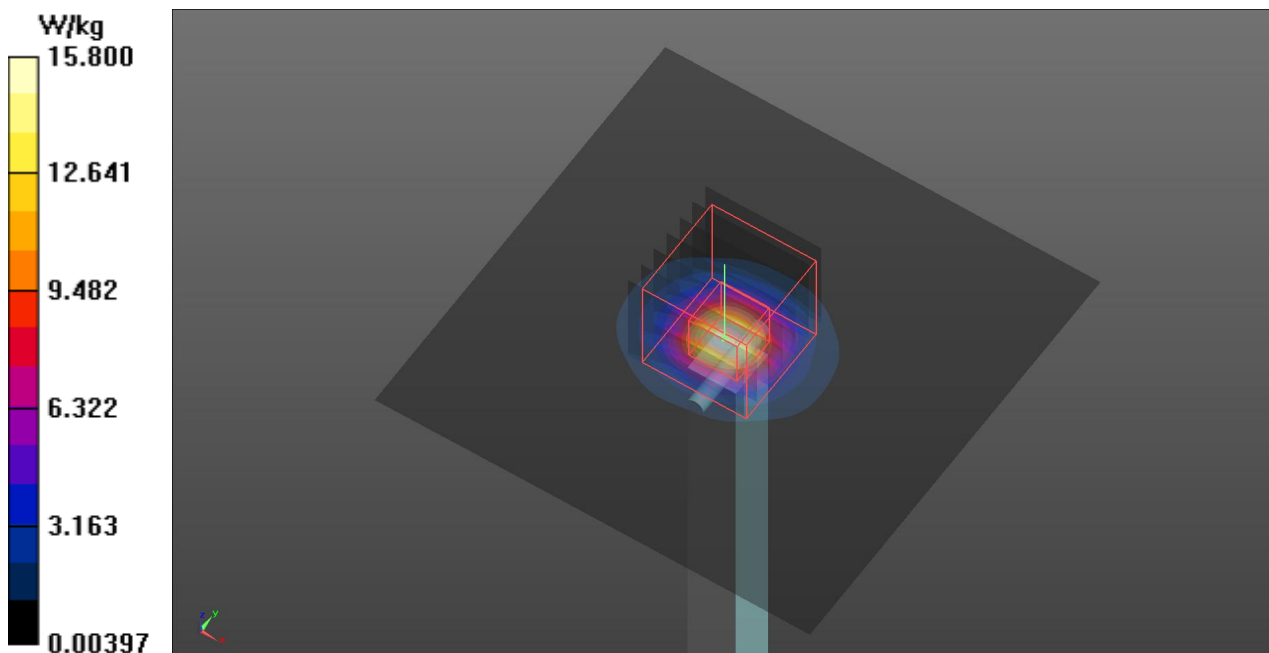



APPENDIX B. Plots of SAR Measurement

P01 802.11ac_VHT40_Front Face _0cm_Ch38

DUT: 640601-01

Communication System: WLAN_5G; Frequency: 5190 MHz; Duty Cycle: 1:1

Medium: B5G_160506 Medium parameters used: $f = 5190$ MHz; $\sigma = 5.344$ S/m; $\epsilon_r = 48.753$; $\rho = 1000$ kg/m³

Ambient Temperature : 23.5 °C; Liquid Temperature : 22.6 °C

DASY5 Configuration:

- Probe: EX3DV4 - SN3976; ConvF(4.4, 4.4, 4.4); Calibrated: 2016/2/22;
- Sensor-Surface: 2mm (Mechanical Surface Detection)
- Electronics: DAE4 Sn1424; Calibrated: 2016/2/16
- Phantom: ELI v5.0; Type: QDOVA002AA; Serial: TP:1238
- Measurement SW: DASY52, Version 52.8 (8); SEMCAD X Version 14.6.10 (7331)

Ch38/Area Scan (101x101x1): Interpolated grid: dx=1.000 mm, dy=1.000 mm

Maximum value of SAR (interpolated) = 2.01 W/kg

Ch38/Zoom Scan (6x6x12)/Cube 0: Measurement grid: dx=5mm, dy=5mm, dz=2mm

Reference Value = 8.554 V/m; Power Drift = -0.05 dB

Peak SAR (extrapolated) = 4.84 W/kg

SAR(1 g) = 1.1 W/kg; SAR(10 g) = 0.304 W/kg

Maximum value of SAR (measured) = 2.20 W/kg

Ch38/Zoom Scan (6x6x12)/Cube 1: Measurement grid: dx=5mm, dy=5mm, dz=2mm

Reference Value = 8.554 V/m; Power Drift = -0.05 dB

Peak SAR (extrapolated) = 3.31 W/kg

SAR(1 g) = 0.834 W/kg; SAR(10 g) = 0.343 W/kg

Maximum value of SAR (measured) = 1.63 W/kg

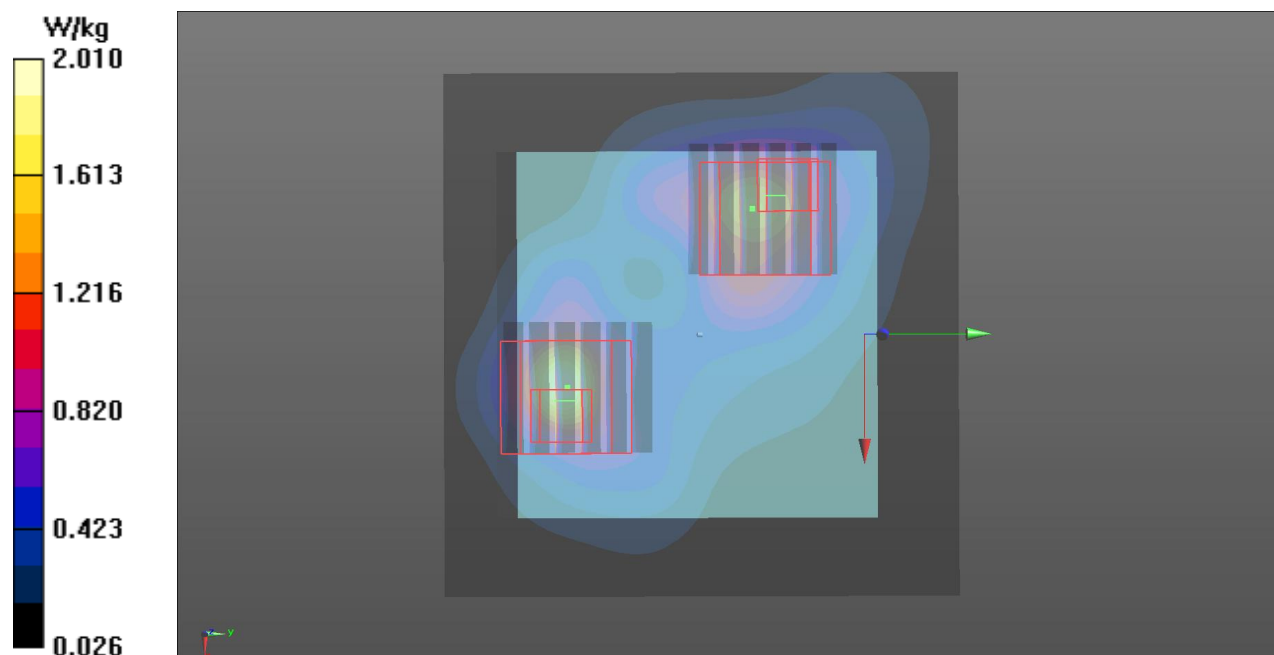

P16 802.11ac_VHT40_Front Face_0cm_Ch151

DUT: 640601-01

Communication System: WLAN_5G; Frequency: 5755 MHz; Duty Cycle: 1:1

Medium: B5G_160506 Medium parameters used: $f = 5755$ MHz; $\sigma = 6.126$ S/m; $\epsilon_r = 47.809$; $\rho = 1000$ kg/m³

Ambient Temperature : 23.5 °C; Liquid Temperature : 22.6 °C

DASY5 Configuration:

- Probe: EX3DV4 - SN3976; ConvF(3.96, 3.96, 3.96); Calibrated: 2016/2/22;
- Sensor-Surface: 2mm (Mechanical Surface Detection)
- Electronics: DAE4 Sn1424; Calibrated: 2016/2/16
- Phantom: ELI v5.0; Type: QDOVA002AA; Serial: TP:1238
- Measurement SW: DASY52, Version 52.8 (8); SEMCAD X Version 14.6.10 (7331)

Ch151/Area Scan (101x101x1): Interpolated grid: dx=1.000 mm, dy=1.000 mm

Maximum value of SAR (interpolated) = 1.31 W/kg

Ch151/Zoom Scan (6x6x12)/Cube 0: Measurement grid: dx=5mm, dy=5mm, dz=2mm

Reference Value = 6.401 V/m; Power Drift = -0.02 dB

Peak SAR (extrapolated) = 3.40 W/kg

SAR(1 g) = 0.778 W/kg; SAR(10 g) = 0.266 W/kg

Maximum value of SAR (measured) = 1.56 W/kg

Ch151/Zoom Scan (6x6x12)/Cube 1: Measurement grid: dx=5mm, dy=5mm, dz=2mm

Reference Value = 6.401 V/m; Power Drift = -0.02 dB

Peak SAR (extrapolated) = 2.80 W/kg

SAR(1 g) = 0.604 W/kg; SAR(10 g) = 0.191 W/kg

Maximum value of SAR (measured) = 1.11 W/kg

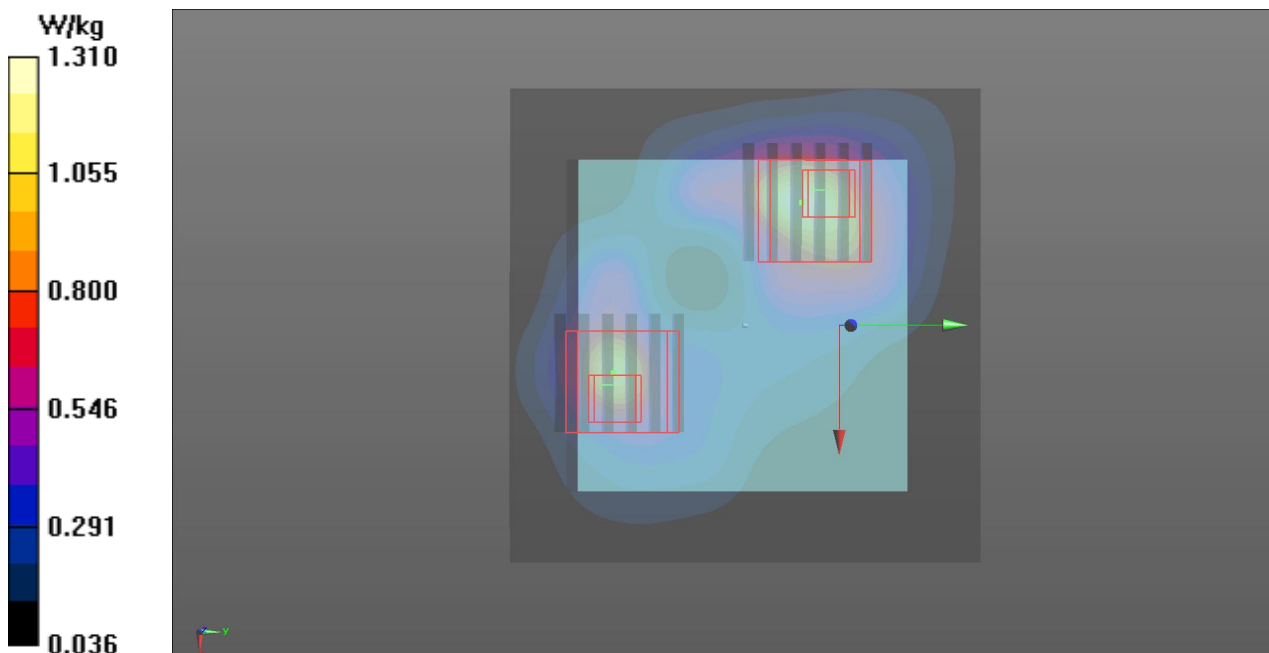



APPENDIX C. DASY Calibration Certificate



Accredited by the Swiss Accreditation Service (SAS)
The Swiss Accreditation Service is one of the signatories to the EA
Multilateral Agreement for the recognition of calibration certificates

Accreditation No.: **SCS 0108**

Client **Sporton-ICC (Auden)**

Certificate No: **D5GHzV2-1171_Feb16**

CALIBRATION CERTIFICATE

Object **D5GHzV2 - SN: 1171**

Calibration procedure(s) **QA CAL-22.v2
Calibration procedure for dipole validation kits between 3-6 GHz**

Calibration date: **February 17, 2016**

This calibration certificate documents the traceability to national standards, which realize the physical units of measurements (SI).
The measurements and the uncertainties with confidence probability are given on the following pages and are part of the certificate.

All calibrations have been conducted in the closed laboratory facility: environment temperature (22 ± 3)°C and humidity < 70%.

Calibration Equipment used (M&TE critical for calibration)

Primary Standards	ID #	Cal Date (Certificate No.)	Scheduled Calibration
Power meter EPM-442A	GB37480704	07-Oct-15 (No. 217-02222)	Oct-16
Power sensor HP 8481A	US37292783	07-Oct-15 (No. 217-02222)	Oct-16
Power sensor HP 8481A	MY41092317	07-Oct-15 (No. 217-02223)	Oct-16
Reference 20 dB Attenuator	SN: 5058 (20k)	01-Apr-15 (No. 217-02131)	Mar-16
Type-N mismatch combination	SN: 5047.2 / 06327	01-Apr-15 (No. 217-02134)	Mar-16
Reference Probe EX3DV4	SN: 3503	31-Dec-15 (No. EX3-3503_Dec15)	Dec-16
DAE4	SN: 601	30-Dec-15 (No. DAE4-601_Dec15)	Dec-16
Secondary Standards	ID #	Check Date (in house)	Scheduled Check
RF generator R&S SMT-06	100972	15-Jun-15 (in house check Jun-15)	In house check: Jun-18
Network Analyzer HP 8753E	US37390585 S4206	18-Oct-01 (in house check Oct-15)	In house check: Oct-16

	Name	Function	Signature
Calibrated by:	Jeton Kastrati	Laboratory Technician	
Approved by:	Katja Pokovic	Technical Manager	

Issued: February 19, 2016

This calibration certificate shall not be reproduced except in full without written approval of the laboratory.



Accredited by the Swiss Accreditation Service (SAS)

The Swiss Accreditation Service is one of the signatories to the EA
Multilateral Agreement for the recognition of calibration certificates

Accreditation No.: **SCS 0108**

Glossary:

TSL	tissue simulating liquid
ConvF	sensitivity in TSL / NORM x,y,z
N/A	not applicable or not measured

Calibration is Performed According to the Following Standards:

- IEEE Std 1528-2013, "IEEE Recommended Practice for Determining the Peak Spatial-Averaged Specific Absorption Rate (SAR) in the Human Head from Wireless Communications Devices: Measurement Techniques", June 2013
- IEC 62209-2, "Procedure to determine the Specific Absorption Rate (SAR) for wireless communication devices used in close proximity to the human body (frequency range of 30 MHz to 6 GHz)", March 2010
- KDB 865664, "SAR Measurement Requirements for 100 MHz to 6 GHz"

Additional Documentation:

- DASY4/5 System Handbook

Methods Applied and Interpretation of Parameters:

- Measurement Conditions:** Further details are available from the Validation Report at the end of the certificate. All figures stated in the certificate are valid at the frequency indicated.
- Antenna Parameters with TSL:** The dipole is mounted with the spacer to position its feed point exactly below the center marking of the flat phantom section, with the arms oriented parallel to the body axis.
- Feed Point Impedance and Return Loss:** These parameters are measured with the dipole positioned under the liquid filled phantom. The impedance stated is transformed from the measurement at the SMA connector to the feed point. The Return Loss ensures low reflected power. No uncertainty required.
- Electrical Delay:** One-way delay between the SMA connector and the antenna feed point. No uncertainty required.
- SAR measured:** SAR measured at the stated antenna input power.
- SAR normalized:** SAR as measured, normalized to an input power of 1 W at the antenna connector.
- SAR for nominal TSL parameters:** The measured TSL parameters are used to calculate the nominal SAR result.

The reported uncertainty of measurement is stated as the standard uncertainty of measurement multiplied by the coverage factor $k=2$, which for a normal distribution corresponds to a coverage probability of approximately 95%.

Measurement Conditions

DASY system configuration, as far as not given on page 1.

DASY Version	DASY5	V52.8.8
Extrapolation	Advanced Extrapolation	
Phantom	Modular Flat Phantom V5.0	
Distance Dipole Center - TSL	10 mm	with Spacer
Zoom Scan Resolution	dx, dy = 4.0 mm, dz = 1.4 mm	Graded Ratio = 1.4 (Z direction)
Frequency	5200 MHz ± 1 MHz 5300 MHz ± 1 MHz 5500 MHz ± 1 MHz 5600 MHz ± 1 MHz 5800 MHz ± 1 MHz	

Head TSL parameters at 5200 MHz

The following parameters and calculations were applied.

	Temperature	Permittivity	Conductivity
Nominal Head TSL parameters	22.0 °C	36.0	4.66 mho/m
Measured Head TSL parameters	(22.0 ± 0.2) °C	34.9 ± 6 %	4.52 mho/m ± 6 %
Head TSL temperature change during test	< 0.5 °C	----	----

SAR result with Head TSL at 5200 MHz

SAR averaged over 1 cm ³ (1 g) of Head TSL	Condition	
SAR measured	100 mW input power	7.42 W/kg
SAR for nominal Head TSL parameters	normalized to 1W	73.7 W/kg ± 19.9 % (k=2)

SAR averaged over 10 cm ³ (10 g) of Head TSL	condition	
SAR measured	100 mW input power	2.16 W/kg
SAR for nominal Head TSL parameters	normalized to 1W	21.4 W/kg ± 19.5 % (k=2)

Head TSL parameters at 5300 MHz

The following parameters and calculations were applied.

	Temperature	Permittivity	Conductivity
Nominal Head TSL parameters	22.0 °C	35.9	4.76 mho/m
Measured Head TSL parameters	(22.0 ± 0.2) °C	34.8 ± 6 %	4.61 mho/m ± 6 %
Head TSL temperature change during test	< 0.5 °C	----	----

SAR result with Head TSL at 5300 MHz

SAR averaged over 1 cm ³ (1 g) of Head TSL	Condition	
SAR measured	100 mW input power	7.91 W/kg
SAR for nominal Head TSL parameters	normalized to 1W	78.5 W / kg ± 19.9 % (k=2)

SAR averaged over 10 cm ³ (10 g) of Head TSL	condition	
SAR measured	100 mW input power	2.30 W/kg
SAR for nominal Head TSL parameters	normalized to 1W	22.8 W/kg ± 19.5 % (k=2)

Head TSL parameters at 5500 MHz

The following parameters and calculations were applied.

	Temperature	Permittivity	Conductivity
Nominal Head TSL parameters	22.0 °C	35.6	4.96 mho/m
Measured Head TSL parameters	(22.0 ± 0.2) °C	34.5 ± 6 %	4.81 mho/m ± 6 %
Head TSL temperature change during test	< 0.5 °C	----	----

SAR result with Head TSL at 5500 MHz

SAR averaged over 1 cm ³ (1 g) of Head TSL	Condition	
SAR measured	100 mW input power	7.74 W/kg
SAR for nominal Head TSL parameters	normalized to 1W	76.8 W/kg ± 19.9 % (k=2)

SAR averaged over 10 cm ³ (10 g) of Head TSL	condition	
SAR measured	100 mW input power	2.23 W/kg
SAR for nominal Head TSL parameters	normalized to 1W	22.1 W/kg ± 19.5 % (k=2)

Head TSL parameters at 5600 MHz

The following parameters and calculations were applied.

	Temperature	Permittivity	Conductivity
Nominal Head TSL parameters	22.0 °C	35.5	5.07 mho/m
Measured Head TSL parameters	(22.0 ± 0.2) °C	34.3 ± 6 %	4.91 mho/m ± 6 %
Head TSL temperature change during test	< 0.5 °C	----	----

SAR result with Head TSL at 5600 MHz

SAR averaged over 1 cm ³ (1 g) of Head TSL	Condition	
SAR measured	100 mW input power	8.08 W/kg
SAR for nominal Head TSL parameters	normalized to 1W	80.1 W/kg ± 19.9 % (k=2)

SAR averaged over 10 cm ³ (10 g) of Head TSL	condition	
SAR measured	100 mW input power	2.33 W/kg
SAR for nominal Head TSL parameters	normalized to 1W	23.1 W/kg ± 19.5 % (k=2)

Head TSL parameters at 5800 MHz

The following parameters and calculations were applied.

	Temperature	Permittivity	Conductivity
Nominal Head TSL parameters	22.0 °C	35.3	5.27 mho/m
Measured Head TSL parameters	(22.0 ± 0.2) °C	34.1 ± 6 %	5.12 mho/m ± 6 %
Head TSL temperature change during test	< 0.5 °C	----	----

SAR result with Head TSL at 5800 MHz

SAR averaged over 1 cm ³ (1 g) of Head TSL	Condition	
SAR measured	100 mW input power	7.58 W/kg
SAR for nominal Head TSL parameters	normalized to 1W	75.2 W/kg ± 19.9 % (k=2)

SAR averaged over 10 cm ³ (10 g) of Head TSL	condition	
SAR measured	100 mW input power	2.17 W/kg
SAR for nominal Head TSL parameters	normalized to 1W	21.5 W/kg ± 19.5 % (k=2)

Body TSL parameters at 5200 MHz

The following parameters and calculations were applied.

	Temperature	Permittivity	Conductivity
Nominal Body TSL parameters	22.0 °C	49.0	5.30 mho/m
Measured Body TSL parameters	(22.0 ± 0.2) °C	47.2 ± 6 %	5.40 mho/m ± 6 %
Body TSL temperature change during test	< 0.5 °C	----	----

SAR result with Body TSL at 5200 MHz

SAR averaged over 1 cm ³ (1 g) of Body TSL	Condition	
SAR measured	100 mW input power	7.41 W/kg
SAR for nominal Body TSL parameters	normalized to 1W	73.6 W/kg ± 19.9 % (k=2)

SAR averaged over 10 cm ³ (10 g) of Body TSL	condition	
SAR measured	100 mW input power	2.09 W/kg
SAR for nominal Body TSL parameters	normalized to 1W	20.7 W/kg ± 19.5 % (k=2)

Body TSL parameters at 5300 MHz

The following parameters and calculations were applied.

	Temperature	Permittivity	Conductivity
Nominal Body TSL parameters	22.0 °C	48.9	5.42 mho/m
Measured Body TSL parameters	(22.0 ± 0.2) °C	47.0 ± 6 %	5.53 mho/m ± 6 %
Body TSL temperature change during test	< 0.5 °C	----	----

SAR result with Body TSL at 5300 MHz

SAR averaged over 1 cm ³ (1 g) of Body TSL	Condition	
SAR measured	100 mW input power	7.69 W/kg
SAR for nominal Body TSL parameters	normalized to 1W	76.3 W/kg ± 19.9 % (k=2)

SAR averaged over 10 cm ³ (10 g) of Body TSL	condition	
SAR measured	100 mW input power	2.17 W/kg
SAR for nominal Body TSL parameters	normalized to 1W	21.5 W/kg ± 19.5 % (k=2)

Body TSL parameters at 5500 MHz

The following parameters and calculations were applied.

	Temperature	Permittivity	Conductivity
Nominal Body TSL parameters	22.0 °C	48.6	5.65 mho/m
Measured Body TSL parameters	(22.0 ± 0.2) °C	46.6 ± 6 %	5.80 mho/m ± 6 %
Body TSL temperature change during test	< 0.5 °C	----	----

SAR result with Body TSL at 5500 MHz

SAR averaged over 1 cm ³ (1 g) of Body TSL	Condition	
SAR measured	100 mW input power	7.95 W/kg
SAR for nominal Body TSL parameters	normalized to 1W	78.9 W/kg ± 19.9 % (k=2)

SAR averaged over 10 cm ³ (10 g) of Body TSL	condition	
SAR measured	100 mW input power	2.22 W/kg
SAR for nominal Body TSL parameters	normalized to 1W	22.0 W/kg ± 19.5 % (k=2)

Body TSL parameters at 5600 MHz

The following parameters and calculations were applied.

	Temperature	Permittivity	Conductivity
Nominal Body TSL parameters	22.0 °C	48.5	5.77 mho/m
Measured Body TSL parameters	(22.0 ± 0.2) °C	46.4 ± 6 %	5.94 mho/m ± 6 %
Body TSL temperature change during test	< 0.5 °C	----	----

SAR result with Body TSL at 5600 MHz

SAR averaged over 1 cm ³ (1 g) of Body TSL	Condition	
SAR measured	100 mW input power	8.04 W/kg
SAR for nominal Body TSL parameters	normalized to 1W	79.8 W/kg ± 19.9 % (k=2)

SAR averaged over 10 cm ³ (10 g) of Body TSL	condition	
SAR measured	100 mW input power	2.26 W/kg
SAR for nominal Body TSL parameters	normalized to 1W	22.4 W/kg ± 19.5 % (k=2)

Body TSL parameters at 5800 MHz

The following parameters and calculations were applied.

	Temperature	Permittivity	Conductivity
Nominal Body TSL parameters	22.0 °C	48.2	6.00 mho/m
Measured Body TSL parameters	(22.0 ± 0.2) °C	46.1 ± 6 %	6.22 mho/m ± 6 %
Body TSL temperature change during test	< 0.5 °C	----	----

SAR result with Body TSL at 5800 MHz

SAR averaged over 1 cm ³ (1 g) of Body TSL	Condition	
SAR measured	100 mW input power	7.62 W/kg
SAR for nominal Body TSL parameters	normalized to 1W	75.6 W/kg ± 19.9 % (k=2)

SAR averaged over 10 cm ³ (10 g) of Body TSL	condition	
SAR measured	100 mW input power	2.13 W/kg
SAR for nominal Body TSL parameters	normalized to 1W	21.1 W/kg ± 19.5 % (k=2)

Appendix (Additional assessments outside the scope of SCS 0108)

Antenna Parameters with Head TSL at 5200 MHz

Impedance, transformed to feed point	49.5 Ω - 10.7 j Ω
Return Loss	- 19.4 dB

Antenna Parameters with Head TSL at 5300 MHz

Impedance, transformed to feed point	49.2 Ω - 6.9 j Ω
Return Loss	- 23.1 dB

Antenna Parameters with Head TSL at 5500 MHz

Impedance, transformed to feed point	51.2 Ω - 5.8 j Ω
Return Loss	- 24.7 dB

Antenna Parameters with Head TSL at 5600 MHz

Impedance, transformed to feed point	55.5 Ω - 5.1 j Ω
Return Loss	- 23.0 dB

Antenna Parameters with Head TSL at 5800 MHz

Impedance, transformed to feed point	53.7 Ω - 6.5 j Ω
Return Loss	- 22.9 dB

Antenna Parameters with Body TSL at 5200 MHz

Impedance, transformed to feed point	48.4 Ω - 8.3 j Ω
Return Loss	- 21.4 dB

Antenna Parameters with Body TSL at 5300 MHz

Impedance, transformed to feed point	48.7 Ω - 5.8 j Ω
Return Loss	- 24.4 dB

Antenna Parameters with Body TSL at 5500 MHz

Impedance, transformed to feed point	50.4 Ω - 4.4 j Ω
Return Loss	- 27.2 dB

Antenna Parameters with Body TSL at 5600 MHz

Impedance, transformed to feed point	55.4 Ω - 2.8 j Ω
Return Loss	- 24.8 dB

Antenna Parameters with Body TSL at 5800 MHz

Impedance, transformed to feed point	54.7 Ω - 5.5 j Ω
Return Loss	- 23.2 dB

General Antenna Parameters and Design

Electrical Delay (one direction)	1.206 ns
----------------------------------	----------

After long term use with 100W radiated power, only a slight warming of the dipole near the feedpoint can be measured.

The dipole is made of standard semirigid coaxial cable. The center conductor of the feeding line is directly connected to the second arm of the dipole. The antenna is therefore short-circuited for DC-signals. On some of the dipoles, small end caps are added to the dipole arms in order to improve matching when loaded according to the position as explained in the "Measurement Conditions" paragraph. The SAR data are not affected by this change. The overall dipole length is still according to the Standard.

No excessive force must be applied to the dipole arms, because they might bend or the soldered connections near the feedpoint may be damaged.

Additional EUT Data

Manufactured by	SPEAG
Manufactured on	December 09, 2013

Test Laboratory: SPEAG, Zurich, Switzerland

DUT: Dipole D5GHzV2; Type: D5GHzV2; Serial: D5GHzV2 - SN:1171

Communication System: UID 0 - CW; Frequency: 5200 MHz, Frequency: 5300 MHz, Frequency: 5500 MHz, Frequency: 5600 MHz, Frequency: 5800 MHz

Medium parameters used: $f = 5200$ MHz; $\sigma = 4.52$ S/m; $\epsilon_r = 34.9$; $\rho = 1000$ kg/m³, Medium parameters used: $f = 5300$ MHz; $\sigma = 4.61$ S/m; $\epsilon_r = 34.8$; $\rho = 1000$ kg/m³, Medium parameters used: $f = 5500$ MHz; $\sigma = 4.81$ S/m; $\epsilon_r = 34.5$; $\rho = 1000$ kg/m³, Medium parameters used: $f = 5600$ MHz; $\sigma = 4.91$ S/m; $\epsilon_r = 34.3$; $\rho = 1000$ kg/m³, Medium parameters used: $f = 5800$ MHz; $\sigma = 5.12$ S/m; $\epsilon_r = 34.1$; $\rho = 1000$ kg/m³

Phantom section: Flat Section

Measurement Standard: DASY5 (IEEE/IEC/ANSI C63.19-2011)

DASY52 Configuration:

- Probe: EX3DV4 - SN3503; ConvF(5.59, 5.59, 5.59); Calibrated: 31.12.2015, ConvF(5.25, 5.25, 5.25); Calibrated: 31.12.2015, ConvF(5.18, 5.18, 5.18); Calibrated: 31.12.2015, ConvF(4.99, 4.99, 4.99); Calibrated: 31.12.2015, ConvF(4.95, 4.95, 4.95); Calibrated: 31.12.2015;
- Sensor-Surface: 1.4mm (Mechanical Surface Detection)
- Electronics: DAE4 Sn601; Calibrated: 30.12.2015
- Phantom: Flat Phantom 5.0 (front); Type: QD000P50AA; Serial: 1001
- DASY52 52.8.8(1258); SEMCAD X 14.6.10(7372)

Dipole Calibration for Head Tissue/Pin=100mW, dist=10mm, f=5200 MHz/Zoom Scan, dist=1.4mm (8x8x7)/Cube 0: Measurement grid: dx=4mm, dy=4mm, dz=1.4mm

Reference Value = 70.14 V/m; Power Drift = 0.07 dB

Peak SAR (extrapolated) = 26.9 W/kg

SAR(1 g) = 7.42 W/kg; SAR(10 g) = 2.16 W/kg

Maximum value of SAR (measured) = 17.0 W/kg

Dipole Calibration for Head Tissue/Pin=100mW, dist=10mm, f=5300 MHz/Zoom Scan, dist=1.4mm (8x8x7)/Cube 0: Measurement grid: dx=4mm, dy=4mm, dz=1.4mm

Reference Value = 71.75 V/m; Power Drift = 0.05 dB

Peak SAR (extrapolated) = 29.8 W/kg

SAR(1 g) = 7.91 W/kg; SAR(10 g) = 2.3 W/kg

Maximum value of SAR (measured) = 18.4 W/kg

Dipole Calibration for Head Tissue/Pin=100mW, dist=10mm, f=5500 MHz/Zoom Scan, dist=1.4mm (8x8x7)/Cube 0: Measurement grid: dx=4mm, dy=4mm, dz=1.4mm

Reference Value = 70.33 V/m; Power Drift = 0.00 dB

Peak SAR (extrapolated) = 30.3 W/kg

SAR(1 g) = 7.74 W/kg; SAR(10 g) = 2.23 W/kg

Maximum value of SAR (measured) = 18.2 W/kg

Dipole Calibration for Head Tissue/Pin=100mW, dist=10mm, f=5600 MHz/Zoom Scan, dist=1.4mm (8x8x7)/Cube 0: Measurement grid: dx=4mm, dy=4mm, dz=1.4mm
Reference Value = 71.19 V/m; Power Drift = 0.05 dB
Peak SAR (extrapolated) = 32.0 W/kg
SAR(1 g) = 8.08 W/kg; SAR(10 g) = 2.33 W/kg
Maximum value of SAR (measured) = 19.2 W/kg

Dipole Calibration for Head Tissue/Pin=100mW, dist=10mm, f=5800 MHz/Zoom Scan, dist=1.4mm (8x8x7)/Cube 0: Measurement grid: dx=4mm, dy=4mm, dz=1.4mm
Reference Value = 68.67 V/m; Power Drift = 0.04 dB
Peak SAR (extrapolated) = 31.3 W/kg
SAR(1 g) = 7.58 W/kg; SAR(10 g) = 2.17 W/kg
Maximum value of SAR (measured) = 18.3 W/kg

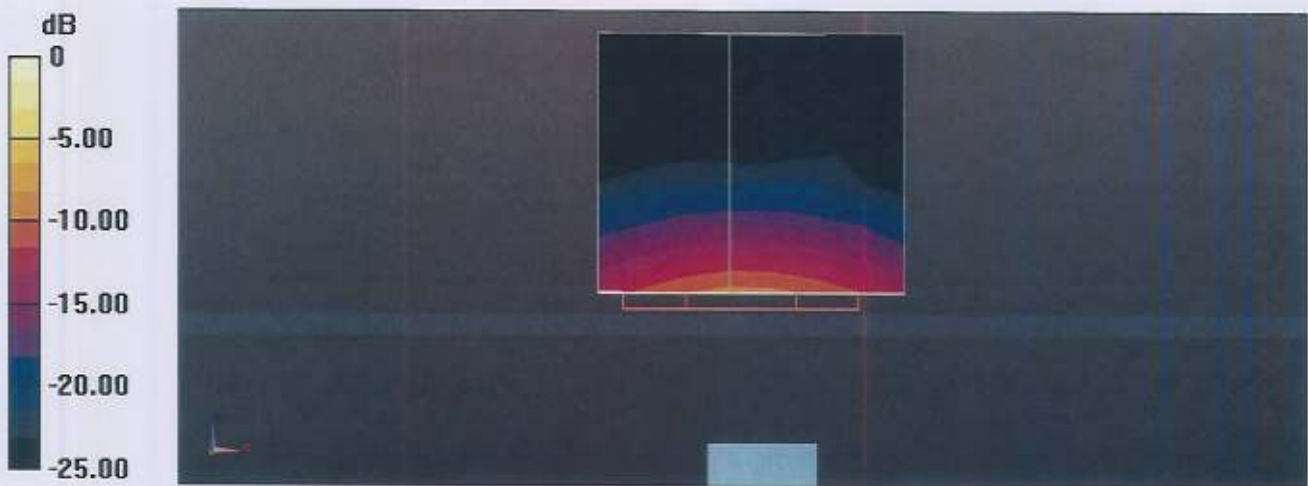

0 dB = 18.3 W/kg = 12.62 dBW/kg

Impedance Measurement Plot for Head TSL

11 Feb 2016 13:42:52

CH1 S11 1 U FS

1: 49.479 Ω -10.693 Ω 2.8622 pF 5 200.000 000 MHz

De1
Cor
Avg
16
H1d

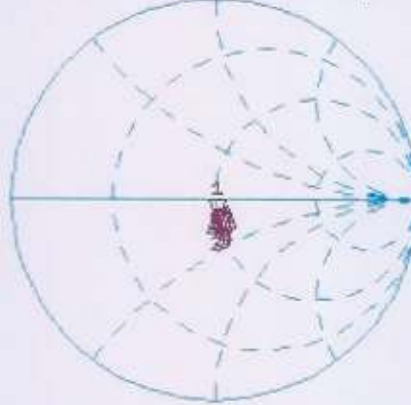

CH1 Markers

2: 49.164 Ω
-6.9023 Ω
5.30000 GHz
3: 51.178 Ω
-5.7891 Ω
5.50000 GHz
4: 55.475 Ω
-5.8781 Ω
5.60000 GHz
5: 53.723 Ω
-6.4551 Ω
5.80000 GHz

CH2 S11 LOG 5 dB/REF -20 dB 1: -19.409 dB 5 200.000 000 MHz

De1
Cor
Avg
16
H1d

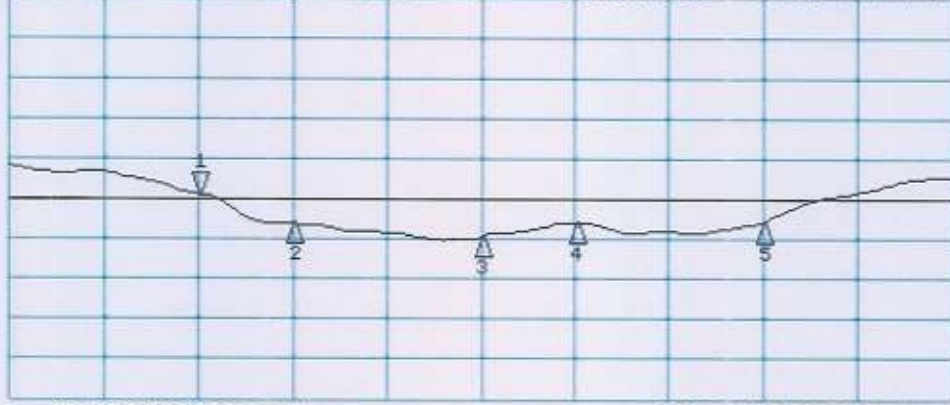

CH2 Markers

2: -23.104 dB
5.30000 GHz
3: -24.691 dB
5.50000 GHz
4: -23.010 dB
5.60000 GHz
5: -22.885 dB
5.80000 GHz

START 5 000.000 000 MHz

STOP 6 000.000 000 MHz

DASY5 Validation Report for Body TSL

Date: 17.02.2016

Test Laboratory: SPEAG, Zurich, Switzerland

DUT: Dipole 5GHz; Type: D5GHzV2; Serial: D5GHzV2 - SN: 1171

Communication System: UID 0 - CW; Frequency: 5200 MHz, Frequency: 5300 MHz, Frequency: 5500 MHz, Frequency: 5600 MHz, Frequency: 5800 MHz

Medium parameters used: $f = 5200$ MHz; $\sigma = 5.4$ S/m; $\epsilon_r = 47.2$; $\rho = 1000$ kg/m³, Medium parameters used: $f = 5300$ MHz; $\sigma = 5.53$ S/m; $\epsilon_r = 47$; $\rho = 1000$ kg/m³, Medium parameters used: $f = 5500$ MHz; $\sigma = 5.8$ S/m; $\epsilon_r = 46.6$; $\rho = 1000$ kg/m³, Medium parameters used: $f = 5600$ MHz; $\sigma = 5.94$ S/m; $\epsilon_r = 46.4$; $\rho = 1000$ kg/m³, Medium parameters used: $f = 5800$ MHz; $\sigma = 6.22$ S/m; $\epsilon_r = 46.1$; $\rho = 1000$ kg/m³

Phantom section: Flat Section

Measurement Standard: DASY5 (IEEE/IEC/ANSI C63.19-2011)

DASY52 Configuration:

- Probe: EX3DV4 - SN3503; ConvF(4.99, 4.99, 4.99); Calibrated: 31.12.2015, ConvF(4.75, 4.75, 4.75); Calibrated: 31.12.2015, ConvF(4.4, 4.4, 4.4); Calibrated: 31.12.2015, ConvF(4.35, 4.35, 4.35); Calibrated: 31.12.2015, ConvF(4.27, 4.27, 4.27); Calibrated: 31.12.2015;
- Sensor-Surface: 1.4mm (Mechanical Surface Detection)
- Electronics: DAE4 Sn601; Calibrated: 30.12.2015
- Phantom: Flat Phantom 5.0 (back); Type: QD000P50AA; Serial: 1002
- DASY52 52.8.8(1258); SEMCAD X 14.6.10(7372)

Dipole Calibration for Body Tissue/Pin=100mW, dist=10mm, f=5200 MHz/Zoom Scan, dist=1.4mm (8x8x7)/Cube 0: Measurement grid: dx=4mm, dy=4mm, dz=1.4mm

Reference Value = 66.49 V/m; Power Drift = -0.03 dB

Peak SAR (extrapolated) = 27.3 W/kg

SAR(1 g) = 7.41 W/kg; SAR(10 g) = 2.09 W/kg

Maximum value of SAR (measured) = 16.7 W/kg

Dipole Calibration for Body Tissue/Pin=100mW, dist=10mm, f=5300 MHz/Zoom Scan, dist=1.4mm (8x8x7)/Cube 0: Measurement grid: dx=4mm, dy=4mm, dz=1.4mm

Reference Value = 67.24 V/m; Power Drift = -0.00 dB

Peak SAR (extrapolated) = 29.1 W/kg

SAR(1 g) = 7.69 W/kg; SAR(10 g) = 2.17 W/kg

Maximum value of SAR (measured) = 17.6 W/kg

Dipole Calibration for Body Tissue/Pin=100mW, dist=10mm, f=5500 MHz/Zoom Scan, dist=1.4mm (8x8x7)/Cube 0: Measurement grid: dx=4mm, dy=4mm, dz=1.4mm

Reference Value = 67.55 V/m; Power Drift = -0.03 dB

Peak SAR (extrapolated) = 32.0 W/kg

SAR(1 g) = 7.95 W/kg; SAR(10 g) = 2.22 W/kg

Maximum value of SAR (measured) = 18.7 W/kg

Dipole Calibration for Body Tissue/Pin=100mW, dist=10mm, f=5600 MHz/Zoom Scan, dist=1.4mm (8x8x7)/Cube 0: Measurement grid: dx=4mm, dy=4mm, dz=1.4mm
Reference Value = 67.31 V/m; Power Drift = -0.00 dB
Peak SAR (extrapolated) = 32.8 W/kg
SAR(1 g) = 8.04 W/kg; SAR(10 g) = 2.26 W/kg
Maximum value of SAR (measured) = 18.9 W/kg

Dipole Calibration for Body Tissue/Pin=100mW, dist=10mm, f=5800 MHz/Zoom Scan, dist=1.4mm (8x8x7)/Cube 0: Measurement grid: dx=4mm, dy=4mm, dz=1.4mm
Reference Value = 65.02 V/m; Power Drift = 0.01 dB
Peak SAR (extrapolated) = 32.8 W/kg
SAR(1 g) = 7.62 W/kg; SAR(10 g) = 2.13 W/kg
Maximum value of SAR (measured) = 18.3 W/kg

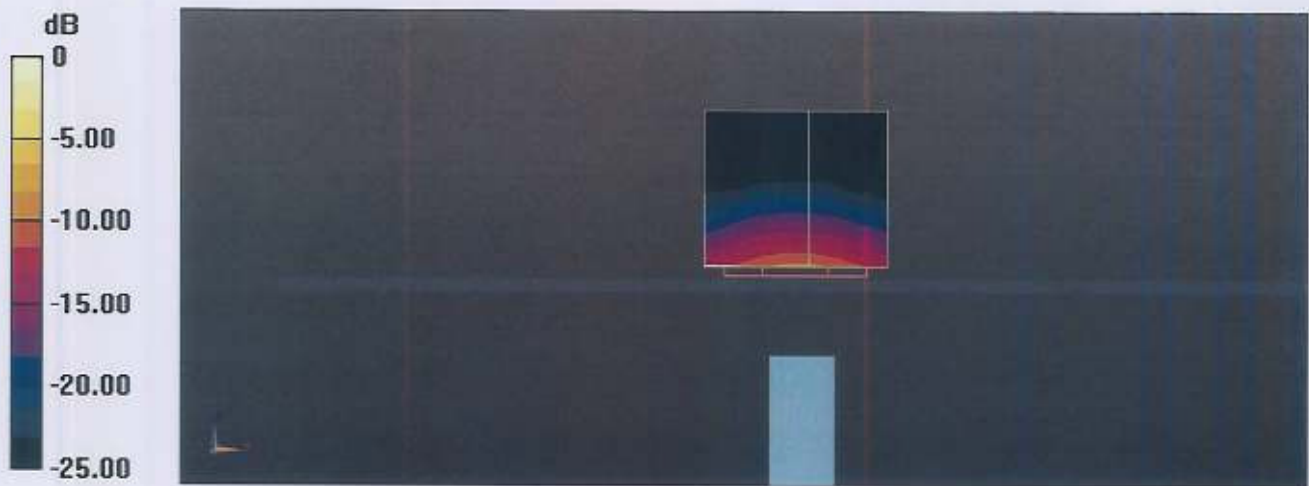

0 dB = 16.7 W/kg = 12.23 dBW/kg

Impedance Measurement Plot for Body TSL

17 Feb 2016 16:40:21

CH1 S11 1 U FS 1: 48.367 Ω -8.2832 Ω 3.6950 pF 5 200.000 000 MHz

Del
Cor
Avg
16
H1d

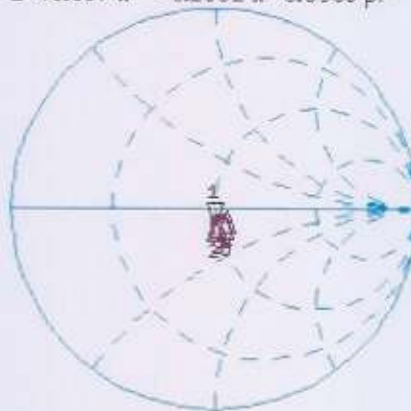

CH1 Markers

- 2: 48.719 Ω
- 5.8457 Ω
- 5.30000 GHz
- 3: 50.416 Ω
- 4.3672 Ω
- 5.50000 GHz
- 4: 55.414 Ω
- 2.7930 Ω
- 5.60000 GHz
- 5: 54.746 Ω
- 5.4961 Ω
- 5.80000 GHz

CH2 S11 LOG 5 dB/REF -20 dB 1: -21.356 dB 5 200.000 000 MHz

Del
Cor
Avg
16
H1d

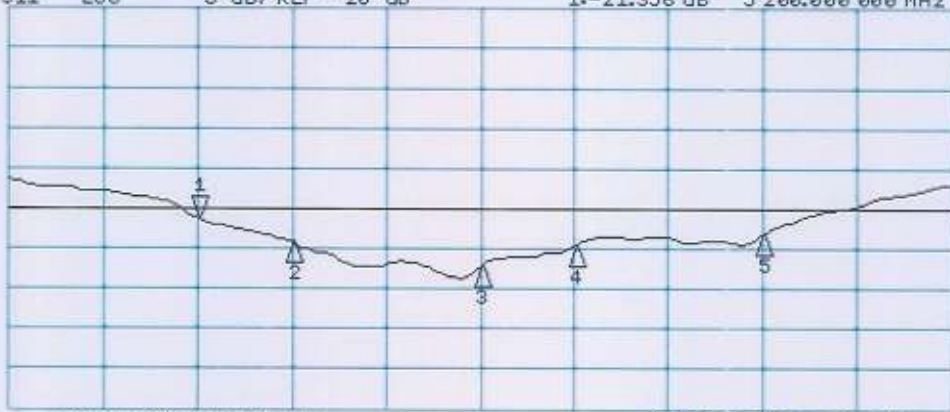

CH2 Markers

- 2: -24.365 dB
- 5.30000 GHz
- 3: -27.203 dB
- 5.50000 GHz
- 4: -24.762 dB
- 5.60000 GHz
- 5: -23.192 dB
- 5.80000 GHz

START 5 000.000 000 MHz

STOP 6 000.000 000 MHz



Accreditation No.: **SCS 0108**

Accredited by the Swiss Accreditation Service (SAS)
The Swiss Accreditation Service is one of the signatories to the EA
Multilateral Agreement for the recognition of calibration certificates

Client **Sporton-ICC (Auden)**

Certificate No: **EX3-3976_Feb16**

CALIBRATION CERTIFICATE

Object **EX3DV4 - SN:3976**

Calibration procedure(s) **QA CAL-01.v9, QA CAL-14.v4, QA CAL-23.v5, QA CAL-25.v6
Calibration procedure for dosimetric E-field probes**

Calibration date: **February 22, 2016**

This calibration certificate documents the traceability to national standards, which realize the physical units of measurements (SI).
The measurements and the uncertainties with confidence probability are given on the following pages and are part of the certificate.

All calibrations have been conducted in the closed laboratory facility: environment temperature (22 ± 3)°C and humidity < 70%.

Calibration Equipment used (M&TE critical for calibration)

Primary Standards	ID	Cal Date (Certificate No.)	Scheduled Calibration
Power meter E4419B	GB41293874	01-Apr-15 (No. 217-02128)	Mar-16
Power sensor E4412A	MY41498087	01-Apr-15 (No. 217-02128)	Mar-16
Reference 3 dB Attenuator	SN: S5054 (3c)	01-Apr-15 (No. 217-02129)	Mar-16
Reference 20 dB Attenuator	SN: S5277 (20x)	01-Apr-15 (No. 217-02132)	Mar-16
Reference 30 dB Attenuator	SN: S5129 (30b)	01-Apr-15 (No. 217-02133)	Mar-16
Reference Probe ES3DV2	SN: 3013	31-Dec-15 (No. ES3-3013_Dec15)	Dec-16
DAE4	SN: 660	23-Dec-15 (No. DAE4-660_Dec15)	Dec-16
Secondary Standards	ID	Check Date (in house)	Scheduled Check
RF generator HP 8648C	US3642U01700	4-Aug-99 (in house check Apr-13)	In house check: Apr-16
Network Analyzer HP 8753E	US37390585	18-Oct-01 (in house check Oct-15)	In house check: Oct-16

	Name	Function	Signature
Calibrated by:	Jeton Kastrati	Laboratory Technician	
Approved by:	Katja Pokovic	Technical Manager	

Issued: February 22, 2016

This calibration certificate shall not be reproduced except in full without written approval of the laboratory.



Accredited by the Swiss Accreditation Service (SAS)

Accreditation No.: **SCS 0108**

The Swiss Accreditation Service is one of the signatories to the EA
Multilateral Agreement for the recognition of calibration certificates

Glossary:

TSL	tissue simulating liquid
NORM _{x,y,z}	sensitivity in free space
ConvF	sensitivity in TSL / NORM _{x,y,z}
DCP	diode compression point
CF	crest factor (1/duty_cycle) of the RF signal
A, B, C, D	modulation dependent linearization parameters
Polarization φ	φ rotation around probe axis
Polarization ϑ	ϑ rotation around an axis that is in the plane normal to probe axis (at measurement center), i.e., $\vartheta = 0$ is normal to probe axis
Connector Angle	information used in DASY system to align probe sensor X to the robot coordinate system

Calibration is Performed According to the Following Standards:

- IEEE Std 1528-2013, "IEEE Recommended Practice for Determining the Peak Spatial-Averaged Specific Absorption Rate (SAR) in the Human Head from Wireless Communications Devices: Measurement Techniques", June 2013
- IEC 62209-1, "Procedure to measure the Specific Absorption Rate (SAR) for hand-held devices used in close proximity to the ear (frequency range of 300 MHz to 3 GHz)", February 2005
- IEC 62209-2, "Procedure to determine the Specific Absorption Rate (SAR) for wireless communication devices used in close proximity to the human body (frequency range of 30 MHz to 6 GHz)", March 2010
- KDB 865664, "SAR Measurement Requirements for 100 MHz to 6 GHz"

Methods Applied and Interpretation of Parameters:

- NORM_{x,y,z}**: Assessed for E-field polarization $\vartheta = 0$ ($f \leq 900$ MHz in TEM-cell; $f > 1800$ MHz: R22 waveguide). NORM_{x,y,z} are only intermediate values, i.e., the uncertainties of NORM_{x,y,z} does not affect the E^2 -field uncertainty inside TSL (see below ConvF).
- NORM(f)_{x,y,z}** = NORM_{x,y,z} * frequency_response (see Frequency Response Chart). This linearization is implemented in DASY4 software versions later than 4.2. The uncertainty of the frequency response is included in the stated uncertainty of ConvF.
- DCP_{x,y,z}**: DCP are numerical linearization parameters assessed based on the data of power sweep with CW signal (no uncertainty required). DCP does not depend on frequency nor media.
- PAR**: PAR is the Peak to Average Ratio that is not calibrated but determined based on the signal characteristics
- A_{x,y,z}; B_{x,y,z}; C_{x,y,z}; D_{x,y,z}; VR_{x,y,z}**: A, B, C, D are numerical linearization parameters assessed based on the data of power sweep for specific modulation signal. The parameters do not depend on frequency nor media. VR is the maximum calibration range expressed in RMS voltage across the diode.
- ConvF and Boundary Effect Parameters**: Assessed in flat phantom using E-field (or Temperature Transfer Standard for $f \leq 800$ MHz) and inside waveguide using analytical field distributions based on power measurements for $f > 800$ MHz. The same setups are used for assessment of the parameters applied for boundary compensation (alpha, depth) of which typical uncertainty values are given. These parameters are used in DASY4 software to improve probe accuracy close to the boundary. The sensitivity in TSL corresponds to NORM_{x,y,z} * ConvF whereby the uncertainty corresponds to that given for ConvF. A frequency dependent ConvF is used in DASY version 4.4 and higher which allows extending the validity from ± 50 MHz to ± 100 MHz.
- Spherical isotropy (3D deviation from isotropy)**: in a field of low gradients realized using a flat phantom exposed by a patch antenna.
- Sensor Offset**: The sensor offset corresponds to the offset of virtual measurement center from the probe tip (on probe axis). No tolerance required.
- Connector Angle**: The angle is assessed using the information gained by determining the NORM_x (no uncertainty required).

Probe EX3DV4

SN:3976

Manufactured: November 5, 2013
Calibrated: February 22, 2016

Calibrated for DASY/EASY Systems
(Note: non-compatible with DASY2 system!)

DASY/EASY - Parameters of Probe: EX3DV4 - SN:3976

Basic Calibration Parameters

	Sensor X	Sensor Y	Sensor Z	Unc (k=2)
Norm ($\mu\text{V}/(\text{V}/\text{m})^2$) ^A	0.49	0.51	0.56	± 10.1 %
DCP (mV) ^B	102.3	101.2	102.3	

Modulation Calibration Parameters

UID	Communication System Name		A dB	B dB/ μV	C	D dB	VR mV	Unc ^E (k=2)
0	CW	X	0.0	0.0	1.0	0.00	192.1	±3.3 %
		Y	0.0	0.0	1.0		217.0	
		Z	0.0	0.0	1.0		197.5	

The reported uncertainty of measurement is stated as the standard uncertainty of measurement multiplied by the coverage factor k=2, which for a normal distribution corresponds to a coverage probability of approximately 95%.

^A The uncertainties of Norm X,Y,Z do not affect the E²-field uncertainty inside TSL (see Pages 5 and 6).

^B Numerical linearization parameter: uncertainty not required.

^E Uncertainty is determined using the max. deviation from linear response applying rectangular distribution and is expressed for the square of the field value.

DASY/EASY - Parameters of Probe: EX3DV4 - SN:3976

Calibration Parameter Determined in Head Tissue Simulating Media

f (MHz) ^C	Relative Permittivity ^F	Conductivity (S/m) ^F	ConvF X	ConvF Y	ConvF Z	Alpha ^G	Depth ^G (mm)	Unc (k=2)
750	41.9	0.89	10.44	10.44	10.44	0.56	0.80	± 12.0 %
835	41.5	0.90	10.21	10.21	10.21	0.51	0.80	± 12.0 %
900	41.5	0.97	9.94	9.94	9.94	0.48	0.83	± 12.0 %
1750	40.1	1.37	8.67	8.67	8.67	0.47	0.80	± 12.0 %
1900	40.0	1.40	8.33	8.33	8.33	0.43	0.85	± 12.0 %
2000	40.0	1.40	8.22	8.22	8.22	0.39	0.80	± 12.0 %
2300	39.5	1.67	7.82	7.82	7.82	0.39	0.80	± 12.0 %
2450	39.2	1.80	7.48	7.48	7.48	0.38	0.84	± 12.0 %
2600	39.0	1.96	7.32	7.32	7.32	0.35	0.96	± 12.0 %
5250	35.9	4.71	5.20	5.20	5.20	0.40	1.80	± 13.1 %
5600	35.5	5.07	4.77	4.77	4.77	0.45	1.80	± 13.1 %
5750	35.4	5.22	4.84	4.84	4.84	0.45	1.80	± 13.1 %

^C Frequency validity above 300 MHz of ± 100 MHz only applies for DASY v4.4 and higher (see Page 2), else it is restricted to ± 50 MHz. The uncertainty is the RSS of the ConvF uncertainty at calibration frequency and the uncertainty for the indicated frequency band. Frequency validity below 300 MHz is ± 10, 25, 40, 50 and 70 MHz for ConvF assessments at 30, 64, 128, 150 and 220 MHz respectively. Above 5 GHz frequency validity can be extended to ± 110 MHz.

^F At frequencies below 3 GHz, the validity of tissue parameters (ϵ and σ) can be relaxed to ± 10% if liquid compensation formula is applied to measured SAR values. At frequencies above 3 GHz, the validity of tissue parameters (ϵ and σ) is restricted to ± 5%. The uncertainty is the RSS of the ConvF uncertainty for indicated target tissue parameters.

^G Alpha/Depth are determined during calibration. SPEAG warrants that the remaining deviation due to the boundary effect after compensation is always less than ± 1% for frequencies below 3 GHz and below ± 2% for frequencies between 3-6 GHz at any distance larger than half the probe tip diameter from the boundary.

DASY/EASY - Parameters of Probe: EX3DV4 - SN:3976

Calibration Parameter Determined in Body Tissue Simulating Media

f (MHz) ^C	Relative Permittivity ^F	Conductivity (S/m) ^F	ConvF X	ConvF Y	ConvF Z	Alpha ^G	Depth ^G (mm)	Unc (k=2)
750	55.5	0.96	10.13	10.13	10.13	0.32	1.08	± 12.0 %
835	55.2	0.97	9.93	9.93	9.93	0.47	0.85	± 12.0 %
900	55.0	1.05	9.92	9.92	9.92	0.46	0.80	± 12.0 %
1750	53.4	1.49	8.34	8.34	8.34	0.41	0.83	± 12.0 %
1900	53.3	1.52	8.06	8.06	8.06	0.41	0.80	± 12.0 %
2000	53.3	1.52	7.99	7.99	7.99	0.27	1.01	± 12.0 %
2300	52.9	1.81	7.60	7.60	7.60	0.41	0.80	± 12.0 %
2450	52.7	1.95	7.45	7.45	7.45	0.32	0.86	± 12.0 %
2600	52.5	2.16	7.20	7.20	7.20	0.28	0.90	± 12.0 %
5250	48.9	5.36	4.40	4.40	4.40	0.50	1.90	± 13.1 %
5600	48.5	5.77	3.78	3.78	3.78	0.55	1.90	± 13.1 %
5750	48.3	5.94	3.96	3.96	3.96	0.60	1.90	± 13.1 %

^C Frequency validity above 300 MHz of ± 100 MHz only applies for DASY v4.4 and higher (see Page 2), else it is restricted to ± 50 MHz. The uncertainty is the RSS of the ConvF uncertainty at calibration frequency and the uncertainty for the indicated frequency band. Frequency validity below 300 MHz is ± 10, 25, 40, 50 and 70 MHz for ConvF assessments at 30, 64, 128, 150 and 220 MHz respectively. Above 5 GHz frequency validity can be extended to ± 110 MHz.

^F At frequencies below 3 GHz, the validity of tissue parameters (ϵ and σ) can be relaxed to ± 10% if liquid compensation formula is applied to measured SAR values. At frequencies above 3 GHz, the validity of tissue parameters (ϵ and σ) is restricted to ± 5%. The uncertainty is the RSS of the ConvF uncertainty for indicated target tissue parameters.

^G Alpha/Depth are determined during calibration. SPEAG warrants that the remaining deviation due to the boundary effect after compensation is always less than ± 1% for frequencies below 3 GHz and below ± 2% for frequencies between 3-6 GHz at any distance larger than half the probe tip diameter from the boundary.

Frequency Response of E-Field (TEM-Cell:ifi110 EXX, Waveguide: R22)

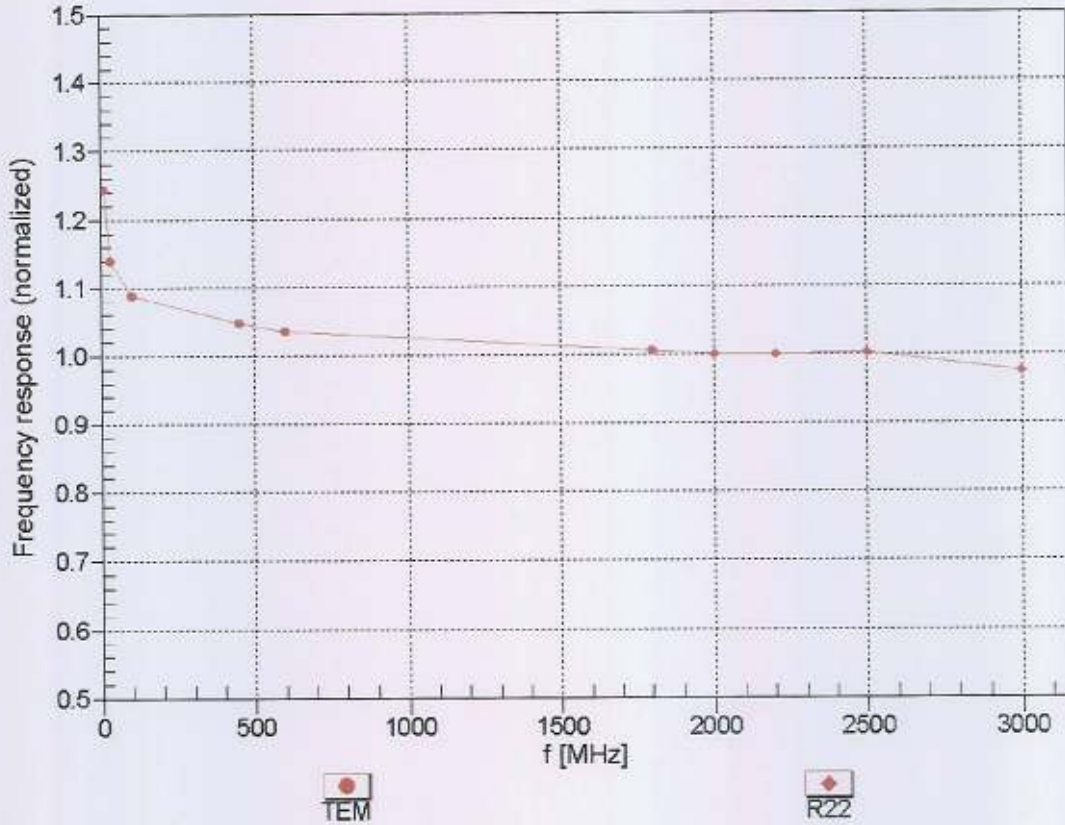

Uncertainty of Frequency Response of E-field: $\pm 6.3\%$ (k=2)

Receiving Pattern (ϕ), $\theta = 0^\circ$

f=600 MHz, TEM

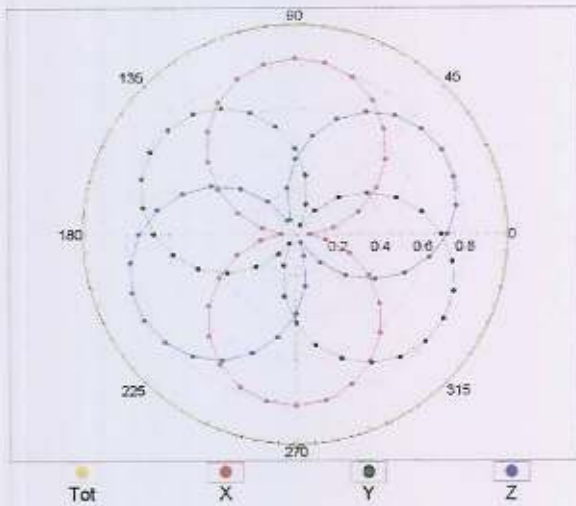

f=1800 MHz, R22

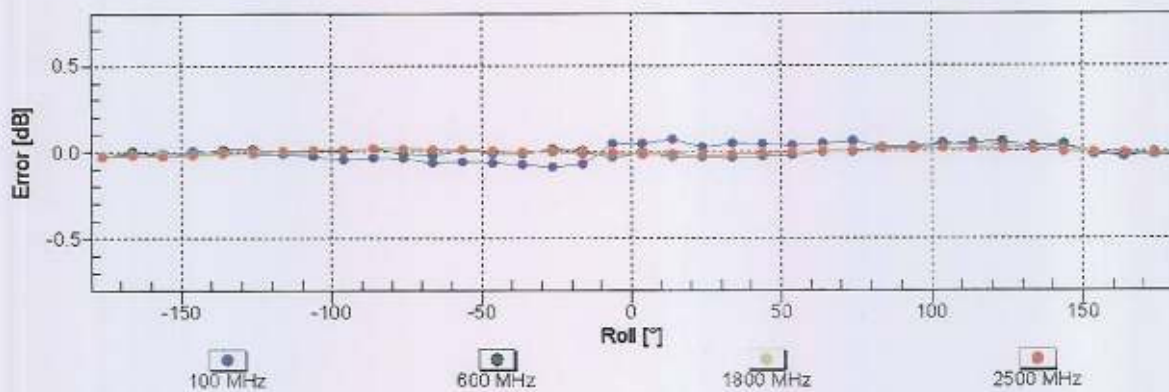
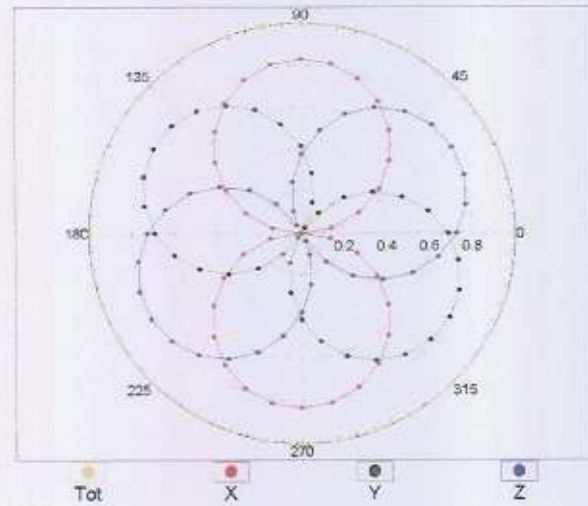

Uncertainty of Axial Isotropy Assessment: $\pm 0.5\%$ (k=2)

Dynamic Range f(SAR_{head}) (TEM cell , f_{eval}= 1900 MHz)

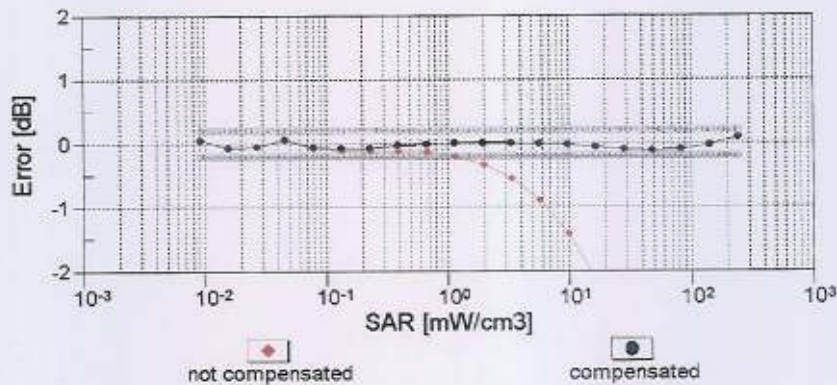
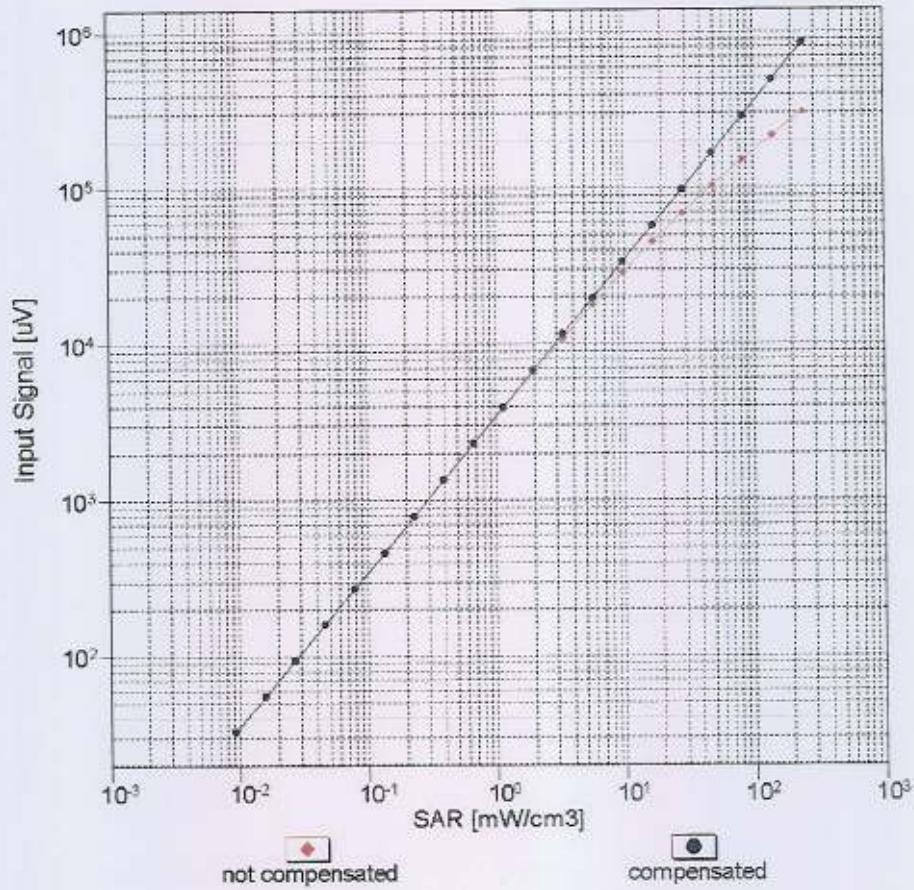

Uncertainty of Linearity Assessment: ± 0.6% (k=2)

Conversion Factor Assessment

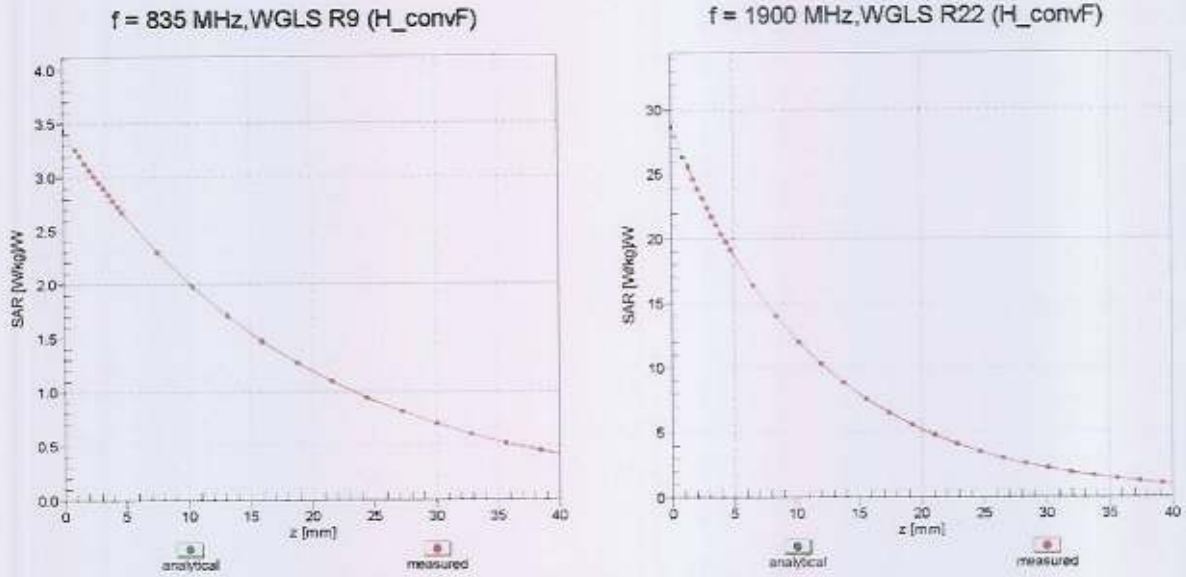

Deviation from Isotropy in Liquid Error (ϕ, θ), f = 900 MHz

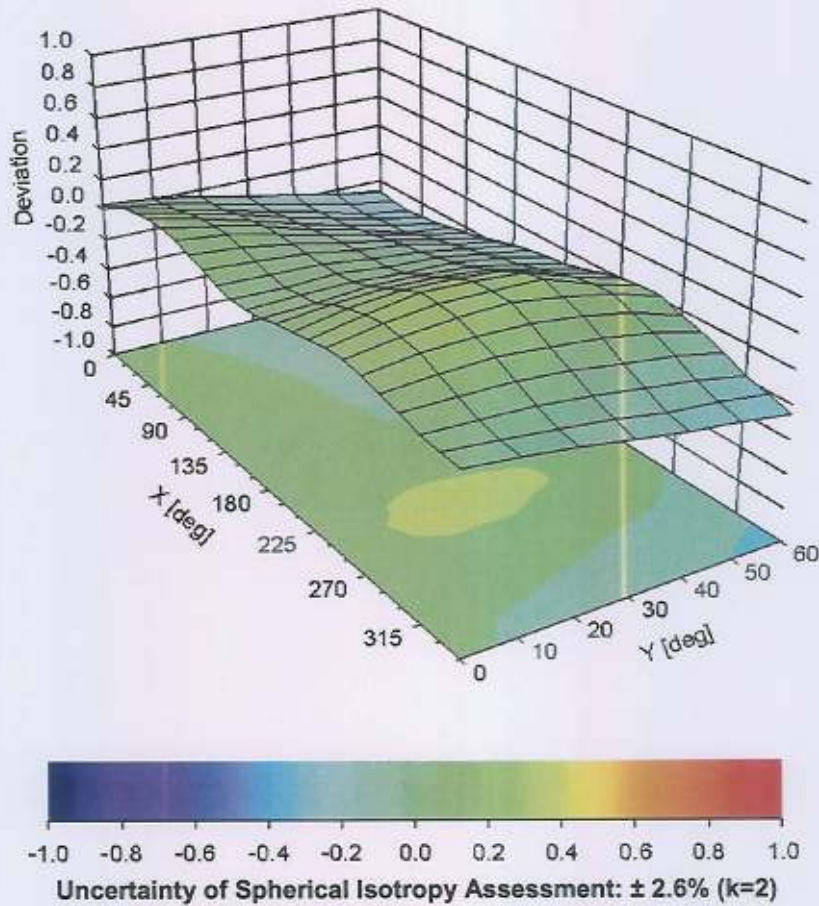

DASY/EASY - Parameters of Probe: EX3DV4 - SN:3976

Other Probe Parameters

Sensor Arrangement	Triangular
Connector Angle (°)	-6.2
Mechanical Surface Detection Mode	enabled
Optical Surface Detection Mode	disabled
Probe Overall Length	337 mm
Probe Body Diameter	10 mm
Tip Length	9 mm
Tip Diameter	2.5 mm
Probe Tip to Sensor X Calibration Point	1 mm
Probe Tip to Sensor Y Calibration Point	1 mm
Probe Tip to Sensor Z Calibration Point	1 mm
Recommended Measurement Distance from Surface	1.4 mm

1424

IMPORTANT NOTICE

USAGE OF THE DAE 4

The DAE unit is a delicate, high precision instrument and requires careful treatment by the user. There are no serviceable parts inside the DAE. Special attention shall be given to the following points:

Battery Exchange: The battery cover of the DAE4 unit is closed using a screw, over tightening the screw may cause the threads inside the DAE to wear out.

Shipping of the DAE: Before shipping the DAE to SPEAG for calibration, remove the batteries and pack the DAE in an antistatic bag. This antistatic bag shall then be packed into a larger box or container which protects the DAE from impacts during transportation. The package shall be marked to indicate that a fragile instrument is inside.

E-Stop Failures: Touch detection may be malfunctioning due to broken magnets in the E-stop. Rough handling of the E-stop may lead to damage of these magnets. Touch and collision errors are often caused by dust and dirt accumulated in the E-stop. To prevent E-stop failure, the customer shall always mount the probe to the DAE carefully and keep the DAE unit in a non-dusty environment if not used for measurements.

Repair: Minor repairs are performed at no extra cost during the annual calibration. However, SPEAG reserves the right to charge for any repair especially if rough unprofessional handling caused the defect.

DASY Configuration Files: Since the exact values of the DAE input resistances, as measured during the calibration procedure of a DAE unit, are not used by the DASY software, a nominal value of 200 MOhm is given in the corresponding configuration file.

Important Note:

Warranty and calibration is void if the DAE unit is disassembled partly or fully by the Customer.

Important Note:

Never attempt to grease or oil the E-stop assembly. Cleaning and readjusting of the E-stop assembly is allowed by certified SPEAG personnel only and is part of the annual calibration procedure.

Important Note:

To prevent damage of the DAE probe connector pins, use great care when installing the probe to the DAE. Carefully connect the probe with the connector notch oriented in the mating position. Avoid any rotational movement of the probe body versus the DAE while turning the locking nut of the connector. The same care shall be used when disconnecting the probe from the DAE.



Accredited by the Swiss Accreditation Service (SAS)
The Swiss Accreditation Service is one of the signatories to the EA
Multilateral Agreement for the recognition of calibration certificates

Accreditation No.: **SCS 0108**

Client **Sporton - ICC (Auden)**

Certificate No: **DAE4-1424_Feb16**

CALIBRATION CERTIFICATE

Object: **DAE4 - SD 000 D04 BM - SN: 1424**

Calibration procedure(s): **QA CAL-06.v29
Calibration procedure for the data acquisition electronics (DAE)**

Calibration date: **February 16, 2016**

This calibration certificate documents the traceability to national standards, which realize the physical units of measurements (SI).
The measurements and the uncertainties with confidence probability are given on the following pages and are part of the certificate.

All calibrations have been conducted in the closed laboratory facility: environment temperature (22 ± 3)°C and humidity < 70%.

Calibration Equipment used (M&TE critical for calibration)

Primary Standards	ID #	Cal Date (Certificate No.)	Scheduled Calibration
Keithley Multimeter Type 2001	SN: 0810278	09-Sep-15 (No:17153)	Sep-16
Secondary Standards	ID #	Check Date (in house)	Scheduled Check
Auto DAE Calibration Unit	SE UWS 053 AA 1001	05-Jan-16 (in house check)	In house check: Jan-17
Calibrator Box V2.1	SE UMS 006 AA 1002	05-Jan-16 (in house check)	In house check: Jan-17

	Name	Function	Signature
Calibrated by:	Eric Hainfeld	Technician	
Approved by:	Fin Bomholt	Deputy Technical Manager	

Issued: February 16, 2016

This calibration certificate shall not be reproduced except in full without written approval of the laboratory.



Accredited by the Swiss Accreditation Service (SAS)

The Swiss Accreditation Service is one of the signatories to the EA
Multilateral Agreement for the recognition of calibration certificates

Glossary

DAE	data acquisition electronics
Connector angle	information used in DASY system to align probe sensor X to the robot coordinate system.

Methods Applied and Interpretation of Parameters

- *DC Voltage Measurement:* Calibration Factor assessed for use in DASY system by comparison with a calibrated instrument traceable to national standards. The figure given corresponds to the full scale range of the voltmeter in the respective range.
- *Connector angle:* The angle of the connector is assessed measuring the angle mechanically by a tool inserted. Uncertainty is not required.
- The following parameters as documented in the Appendix contain technical information as a result from the performance test and require no uncertainty.
 - *DC Voltage Measurement Linearity:* Verification of the Linearity at +10% and -10% of the nominal calibration voltage. Influence of offset voltage is included in this measurement.
 - *Common mode sensitivity:* Influence of a positive or negative common mode voltage on the differential measurement.
 - *Channel separation:* Influence of a voltage on the neighbor channels not subject to an input voltage.
 - *AD Converter Values with inputs shorted:* Values on the internal AD converter corresponding to zero input voltage
 - *Input Offset Measurement:* Output voltage and statistical results over a large number of zero voltage measurements.
 - *Input Offset Current:* Typical value for information; Maximum channel input offset current, not considering the input resistance.
 - *Input resistance:* Typical value for information: DAE input resistance at the connector, during internal auto-zeroing and during measurement.
 - *Low Battery Alarm Voltage:* Typical value for information. Below this voltage, a battery alarm signal is generated.
 - *Power consumption:* Typical value for information. Supply currents in various operating modes.

DC Voltage Measurement

A/D - Converter Resolution nominal

High Range: 1LSB = 6.1 μ V, full range = -100...+300 mV

Low Range: 1LSB = 61nV, full range = -1.....+3mV

DASY measurement parameters: Auto Zero Time: 3 sec; Measuring time: 3 sec

Calibration Factors	X	Y	Z
High Range	403.115 \pm 0.02% (k=2)	403.593 \pm 0.02% (k=2)	403.165 \pm 0.02% (k=2)
Low Range	3.96879 \pm 1.50% (k=2)	3.99597 \pm 1.50% (k=2)	3.98373 \pm 1.50% (k=2)

Connector Angle

Connector Angle to be used in DASY system	358.5 $^{\circ}$ \pm 1 $^{\circ}$
---	-------------------------------------

Appendix (Additional assessments outside the scope of SCS0108)

1. DC Voltage Linearity

High Range	Reading (μV)	Difference (μV)	Error (%)
Channel X + Input	200030.11	-0.54	-0.00
Channel X + Input	20005.39	1.52	0.01
Channel X - Input	-20004.18	1.46	-0.01
Channel Y + Input	200029.89	-0.75	-0.00
Channel Y + Input	20003.08	-0.74	-0.00
Channel Y - Input	-20006.82	-1.12	0.01
Channel Z + Input	200029.36	-1.53	-0.00
Channel Z + Input	20003.05	-0.71	-0.00
Channel Z - Input	-20006.58	-0.86	0.00

Low Range	Reading (μV)	Difference (μV)	Error (%)
Channel X + Input	2000.50	0.09	0.00
Channel X + Input	200.58	0.30	0.15
Channel X - Input	-199.66	-0.22	0.11
Channel Y + Input	2000.78	0.49	0.02
Channel Y + Input	199.77	-0.58	-0.29
Channel Y - Input	-200.27	-0.74	0.37
Channel Z + Input	2000.21	0.02	0.00
Channel Z + Input	199.29	-0.91	-0.46
Channel Z - Input	-201.23	-1.59	0.80

2. Common mode sensitivity

DASY measurement parameters: Auto Zero Time: 3 sec; Measuring time: 3 sec

	Common mode Input Voltage (mV)	High Range Average Reading (μV)	Low Range Average Reading (μV)
Channel X	200	-0.82	-2.06
	- 200	2.72	1.54
Channel Y	200	-13.08	-13.46
	- 200	12.33	11.90
Channel Z	200	-8.84	-8.96
	- 200	6.20	6.09

3. Channel separation

DASY measurement parameters: Auto Zero Time: 3 sec; Measuring time: 3 sec

	Input Voltage (mV)	Channel X (μV)	Channel Y (μV)	Channel Z (μV)
Channel X	200	-	3.30	-3.61
Channel Y	200	8.63	-	3.78
Channel Z	200	9.24	6.81	-

4. AD-Converter Values with inputs shorted

DASY measurement parameters: Auto Zero Time: 3 sec; Measuring time: 3 sec

	High Range (LSB)	Low Range (LSB)
Channel X	15955	15472
Channel Y	15879	15883
Channel Z	15879	14240

5. Input Offset Measurement

DASY measurement parameters: Auto Zero Time: 3 sec; Measuring time: 3 sec

Input 10M Ω

	Average (μ V)	min. Offset (μ V)	max. Offset (μ V)	Std. Deviation (μ V)
Channel X	0.90	-0.12	1.64	0.38
Channel Y	0.29	-0.72	2.16	0.44
Channel Z	-1.12	-2.05	-0.03	0.36

6. Input Offset Current

Nominal Input circuitry offset current on all channels: <25fA

7. Input Resistance (Typical values for information)

	Zeroing (kOhm)	Measuring (MOhm)
Channel X	200	200
Channel Y	200	200
Channel Z	200	200

8. Low Battery Alarm Voltage (Typical values for information)

Typical values	Alarm Level (VDC)
Supply (+ Vcc)	+7.9
Supply (- Vcc)	-7.6

9. Power Consumption (Typical values for information)

Typical values	Switched off (mA)	Stand by (mA)	Transmitting (mA)
Supply (+ Vcc)	+0.01	+6	+14
Supply (- Vcc)	-0.01	-8	-9