

Specification For Approval

Date: 2020 / 11 / 04

File No.: 201104001

Version: 1.0

Customer : H00732

Customer P/N : /

INVAX P/N : AN2450-5025BRS

Description : Antenna

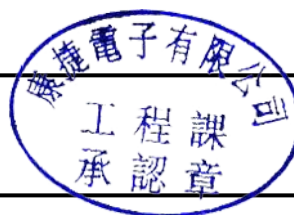

Cortec Checked By:	
Customer Approved By:	



INVAX System Technology Corp.
4F. No. 815.Chung Hsiao East Rd.,Sec.5
Taipei, TAIWAN

TEL:886-2-2788-5218 FAX:886-2-2783-1658
<http://www.invaxsystem.com>



Cortec Technology Inc.
Xian-Xi Industrial, Sha-Tou Administration
Chang-An Town, Dong-Guan City, Guangdong
Province, China

TEL:86-769-85388261 FAX:86-769-85317869
<http://www.cortec.com.cn>

Index:

- 1. Revision History / Page 3**
- 2. Specification / Page 4**
- 3. Characteristics and Reliability Test / Page 5 ~ 6**
- 4. Antenna - S Parameter Test Data / Page 6**
- 5. Antenna - Radiation Pattern Test Data / Page 7**
- 6. Mechanical and Packing Drawing / Page 8 ~ 9**
- 7. Material Description and RoHS Test Report / Page 10 ~ end**

Product Number: AN2450-5025BRS

Product Name: Antenna



1. Revision History

Revision	Date	Change Notification	Description
1.0	2020.11.04	初版	

Product Number: AN2450-5025BRS

Product Name: Antenna



1. Specification

Sample Photo	
	
A. Electrical Characteristics	
Frequency	2400 ~ 2500 MHz 5150 ~ 5850 MHz
V.S.W.R.	≤ 2.0 @ 2400 ~ 2500 MHz ≤ 2.0 @ 5150 ~ 5850 MHz
Peak Gain	3.5 dBi @ 2400 ~ 2500 MHz 5.0 dBi @ 5150 ~ 5850 MHz
Polarization	Linear
Impedance	50 Ohm
B. Material & Mechanical Characteristics	
Material of Radiator	Cu
Material of Plastic	TPEE / ABS
Cable Type	RG-178U-03
Connector Type	SMA Male Reverse
C. Environmental	
Operation Temperature	- 40 °C ~ + 65 °C
Storage Temperature	- 40 °C ~ + 80 °C

2. Characteristics and Reliability Test

Test Items 測試項目	Test Condition and Procedure 測試方法	Requirements 要求	Result 結果
C1 V.S.W.R. 電壓駐波比	Set DUT on Network Analyzer; make individual calibration to test 設置網路分析儀參數進行測試	Directive DUT specification 符合待測物規範	PASS
C3 Antenna Gain 天線增益	Set DUT on Antenna Chamber; make individual calibration to test 設置天線暗室參數進行測試	Directive DUT specification 符合待測物規範	PASS
M1 Vibration 震動	GB / T2423.48-2008 Amplitude: 0.03 inch (1.5mm); Freq: 20 to 80 to 20 Hz 3 directions; 2 hours for each direction 振幅 1.5mm ; 頻率 20~80~20Hz ; 3 個方向各 2H	1. No Visual Damage 2. Frequency Tol. ≤5% 無明顯外觀不良; 頻率偏移 ≤5%	PASS
M2 Random Drop 跌落	GB / T2423.8-1995 Single : Height: 1.0 Meter; 3 directions; 1 time for each direction 單支天線, 高 1m ; 3 個方向各 1 次	1. No parts separated · fracture 2. Frequency Tol. ≤5% 產品無脫落、斷裂; 頻率偏移 ≤5%	PASS
M4 Pull Test 拉力	Holding with individual specification; force applied to axis of terminal .單獨定義產品端子拉力	1. Directive DUT specification 2. Frequency Tol. ≤5% 符合待測物規範; 頻率偏移 ≤5%	PASS
M5 Torque Test 扭力	Holding with individual specification; applied clockwise and counterclockwise to the axis of terminal 單獨定義產品端子之順時針及逆時針扭力	1. Directive DUT specification 2. Frequency Tol. ≤ 5% 符合待測物規範; 頻率偏移 ≤5%	PASS
M6 Dimension 尺寸	Inspection of dimension, color, material, package, surface process. 檢查尺寸, 顏色, 材料, 包裝, 表面處理	Directive DUT specification 符合待測物規範	PASS
E2 Salt Spray 鹽霧	GB / T 2423.17-2008 Temp: 35°C; RH: ≥ 95%; NaCl solution: ≥ 5%; Time: 24H 溫度 35°C ; 濕度 ≥95%; 鹽水濃度 ≥5% ; 測試 24H	1. No Visual Damage 2. Frequency Tol. ≤5% 無明顯外觀不良; 頻率偏移 ≤5%	PASS
E3 Temperature and Humidity Chamber 恒溫恒濕	GB / T 2423.3-2006 Temp: 80°C / 12 H; -40°C / 12H RH: ≥ 90%; Time: 24H 溫度 80°C 測試 12H 轉 -40°C 測試 12H ; 濕度 ≥ 90% ; 時間 24H	After 2 Hours Recovery 1. No Visual Damage 2. Frequency Tol. ≤5% 恢復 2H 后, 無明顯外觀不良; 頻率偏移 ≤5%	PASS
E4 Thermal Shock 冷熱衝擊	GB / T 2423.22 - 2008 - 40°C (30 minutes) to + 80°C (30 minutes) ; Cycles: 24	After 2 Hours Recovery 1. No Visual Damage 2. Frequency Tol. ≤5%	PASS

		- 40°C 測試 30 分轉 80°C 測試 30 分為一個週期; 共 24 週期	恢復 2H 后, 無明顯外觀不良; 頻率偏移 ≤ 5%	
E5	Aging test 老化	GB /T 2423.2 - 2008 Temp: 80°C; Time: 24 hours 溫度 80°C, 測試 24H	After 2 Hours Recovery 1. No Visual Damage 2. Frequency Tol. ≤ 5% 無明顯外觀不良; 頻率偏移 ≤ 5%	PASS
R1	RoHS	With Reference to IEC 62321:2008 with flow chart 參考 IEC 62321 測試流程	Directive RoHS 2015/863/EU 符合 RoHS 2015/863/EU 標準	PASS

3. Antenna - S Parameter Test Data

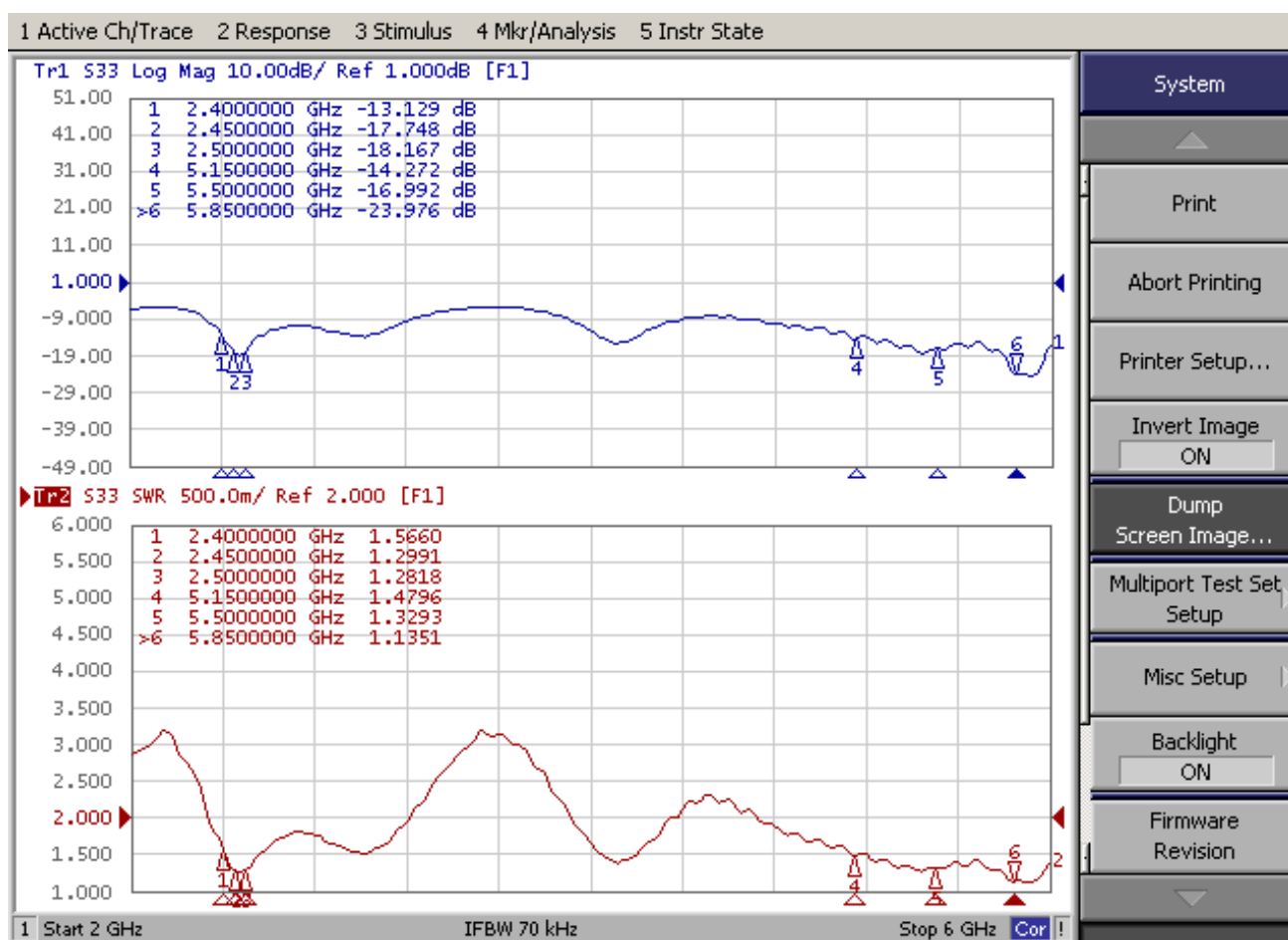

Product Number: AN2450-5025BRS

Product Name: Antenna



4. Antenna - Radiation Pattern Test Data

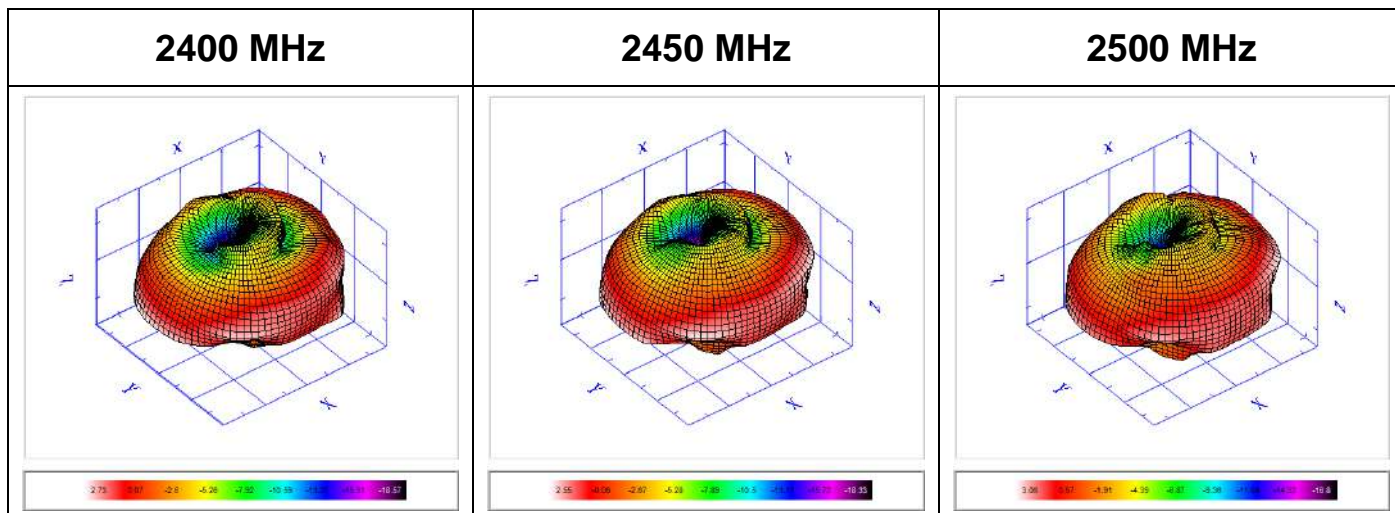

Frequency	2400	2410	2420	2430	2440	2450	2460	2470	2480	2490	2500
E-Total Peak Gain (dBi)	2.73	2.51	2.78	2.75	2.6	2.55	3.09	3.23	3.4	2.83	3.06
Efficiency (%)	66.37	63.72	68.32	69.95	67.36	68.57	69	70.88	74.75	71.37	71.66
Average Gain (dB)	-1.78	-1.96	-1.65	-1.55	-1.72	-1.64	-1.61	-1.49	-1.26	-1.46	-1.45

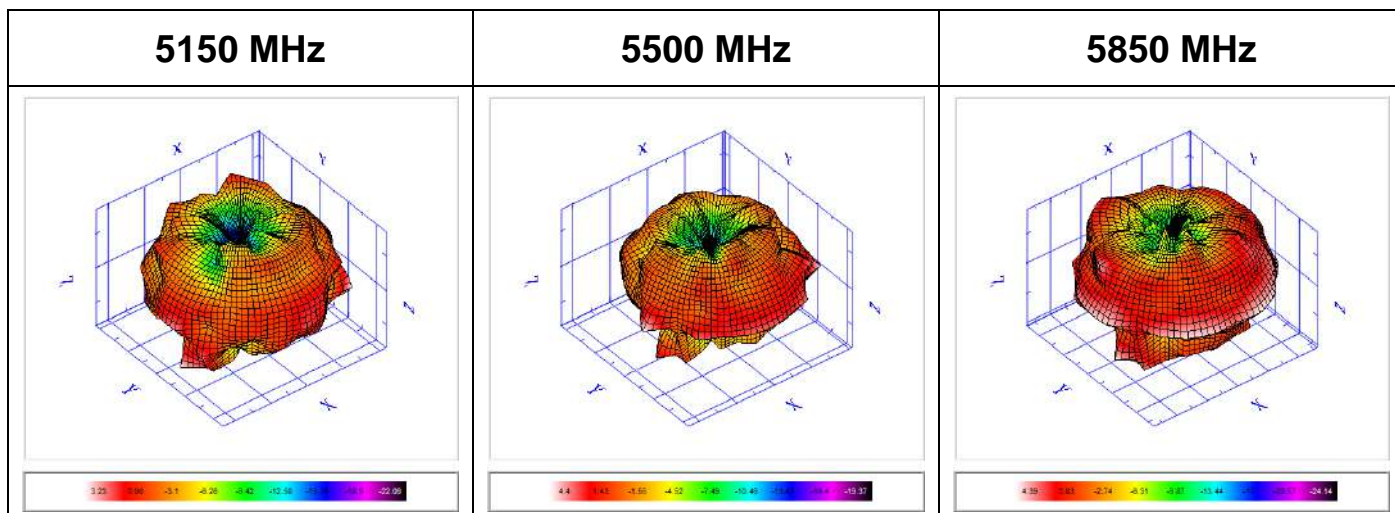

Frequency	5150	5250	5350	5400	5500	5550	5650	5700	5800	5850
E-Total Peak Gain (dBi)	3.23	2.76	2.5	2.21	4.4	3.46	2.68	4.79	4.74	4.39
Efficiency (%)	59.07	61.77	63.19	54.87	66.07	58.11	52.67	63.2	67.53	83.34
Average Gain (dB)	-2.29	-2.09	-1.99	-2.61	-1.8	-2.36	-2.78	-1.99	-1.7	-0.79

RoHS

Compatible

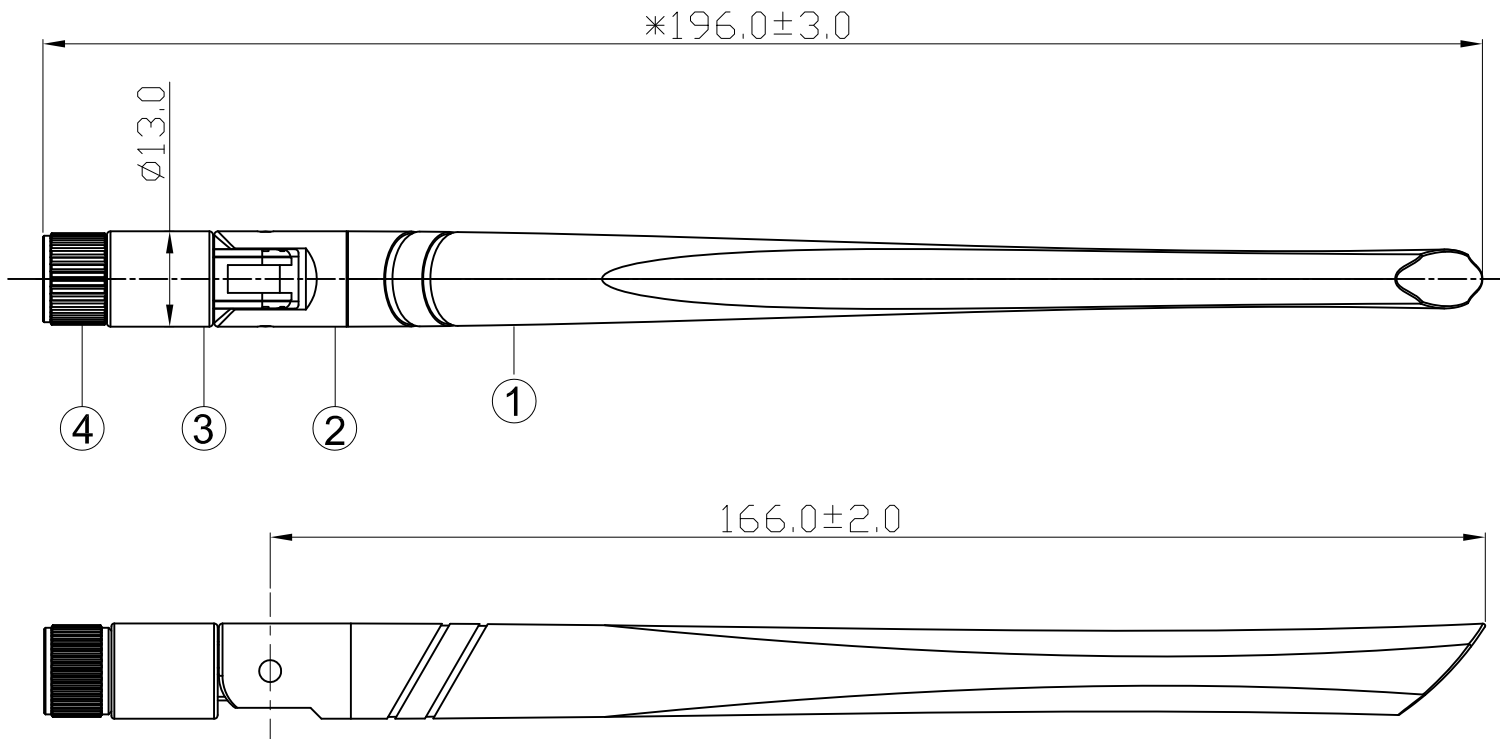
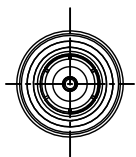

SIGN	DATE	DESCRIPTION	APPROVER
△			
△			
△			

備註:

1. 未注公差參照標準公差,
2. 注*尺寸為重點管控尺寸。
3. 所有材料Pb含量小於1000PPM.

4	SMA309-CPR5A03	SMA公頭母針	POM	黑色	1
3	AN0304-T07B	連接頭	ABS	黑色	1
2	AN9201-07B	連接筒	ABS	黑色	1
1	BODY-AN50-01B	天線塑膠外套	TPEE	黑色	1
No.	Part Number	Description	Material	Finished	Q'ty

Invax System Group.		Cortec Technology Inc.	
Cortec		Http://www.invaxsystem.com E-mail: info@invax.com.tw Tel: 886-2-27885218 Fax: 886-2-27831658	
TITLE: 2.4/5GHz Antenna			
PART NO.: AN2450-5025BRS		CUSTOMER P/N: /	
APP BY	CHK BY	RF BY	DES BY
Grant	Kenny		WS
2020.11.03	2020.11.03		2020.11.03
		Tolerance X.X ±0.5 X.XX ±0.3 X° ±1	
		UNITS: mm SCALE: 1/1 REVISION: A	

Date: 2020.11.03

Part Number : AN2450-5025BRS	Revision : A
Name: 2.4/5GHz Antenna	Customer : All

1.Enter OPP bag ◦

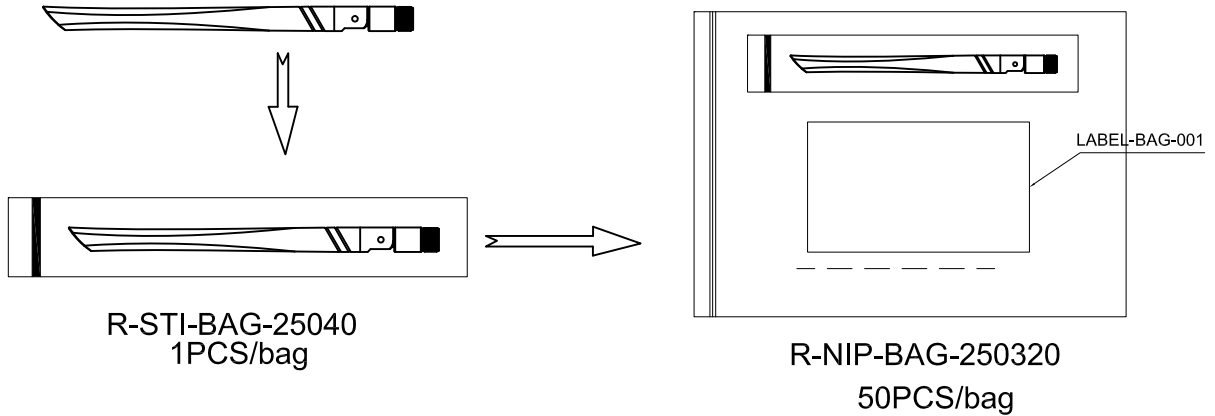

2.PACKING ◦

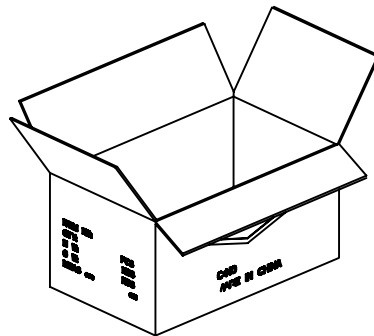

SIZE:29.0x23.0x32.5cm
300PCS/CARTON

3. SEALING ◦

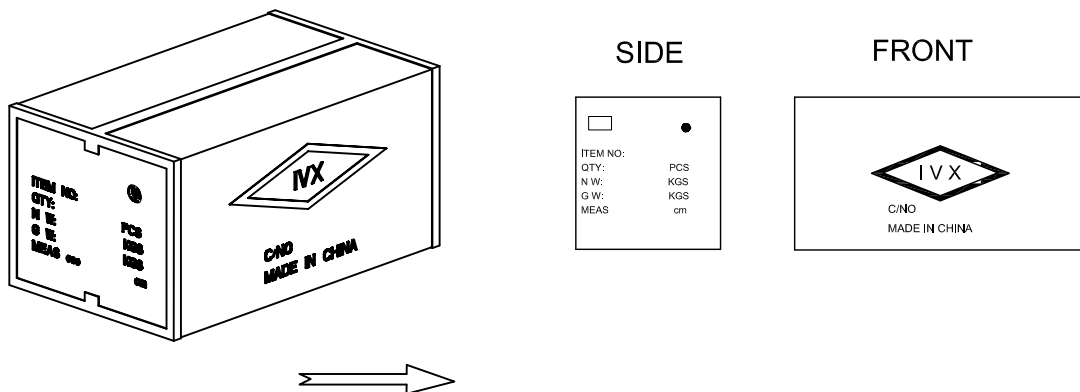

APPROVED BY : Grant CHECKED BY : Kenny DESIGNED BY : WS

請輸入以下報告正確資料及檢查碼以便查核

1. 報告編號
2. 報告日期 (YYYY/MM/DD)
3. 產品名稱 (輸入前 10 個字不含空白)
4. 圖示檢查碼 (依指示畫面)



物料中HSF對象物質含量調查表

康捷電子有限公司	
填表：	時麗
部門：	研發部
職務：	文員

物料名稱：AN2450-5025BRS

序號	物料型號	物料各構成名稱	各構成物料 的材質	測試報告裡RoHS對應物質測試結果										檢測報告編號	測試日期	測試名稱	測試機構 名稱	
				Cd	Pb	Hg	Cr(VI)	PBBs	PBDEs	DBP	BBP	DIBP	DEHP					
1	BODY-AN50-01B	Body1	TPEE	N.D.	N.D.	N.D.	N.D.	N.D.	N.D.	N.D.	N.D.	N.D.	N.D.	CANEC2003075602	2020.03.20	TPEE	SGS	
2	AN9201-07B	Body2	ABS	N.D.	N.D.	N.D.	N.D.	N.D.	N.D.	N.D.	N.D.	N.D.	N.D.	238113368s1 001	2019.12.09	POLYLAC® PA-757	TuvRheinland	
3	AN0304-T07B	Body3	ABS	N.D.	N.D.	N.D.	N.D.	N.D.	N.D.	N.D.	N.D.	N.D.	N.D.	238113368s1 001	2019.12.09	POLYLAC® PA-757	TuvRheinland	
4	/	Body	黑色色母	N.D.	N.D.	N.D.	N.D.	N.D.	N.D.	N.D.	N.D.	N.D.	N.D.	CANEC2002180104	2020.03.10	黑色母粒.	SGS	
5	SMA309-CPR5AN03	SMA Male Reverse	銅	N.D.	30	N.D.	N.D.	N.D.	N.D.	N.D.	N.D.	N.D.	N.D.	CANML2009696204	2020.06.22	无铅环保铜棒	SGS	
6			POM	N.D.	N.D.	N.D.	N.D.	N.D.	N.D.	N.D.	NA	NA	NA	NA	0101/LF-CTSAYAA20-01	2020.01.16	KEPITAL 1	SGS
7	TUBE-682016-01CM	Tube	銅	N.D.	7	N.D.	N.D.	N.D.	N.D.	N.D.	N.D.	N.D.	N.D.	CANEC2017668201	2020.10.16	H65	SGS	
8	R-HSTUBE-070W	白色套管	EVA	N.D.	N.D.	N.D.	N.D.	N.D.	N.D.	N.D.	N.D.	N.D.	N.D.	CANEC2001879301	2020.03.09	HEAT SHRINKABL	SGS	
9	R-GS-SP2001001	EVA	EVA	N.D.	33	N.D.	N.D.	N.D.	N.D.	N.D.	N.D.	N.D.	N.D.	CANEC2001834614	2020.02.28	Environmental protectio	SGS	
10	R-RG-178U-03	線材	FEP	N.D.	N.D.	N.D.	N.D.	N.D.	N.D.	N.D.	N.D.	N.D.	N.D.	NGBML2000312802	2020.01.22	聚全氟乙丙烯樹脂.	SGS	
11			PTFE	N.D.	N.D.	N.D.	N.D.	N.D.	N.D.	N.D.	N.D.	N.D.	N.D.	N.D.	NGBML2000309802	2020.01.22	聚四氟乙稀模压粉	SGS
12			鍍銀銅	N.D.	N.D.	N.D.	N.D.	N.D.	N.D.	N.D.	N.D.	N.D.	N.D.	N.D.	CANEC2002004901	2020.03.05	SC	SGS
13			鍍錫銅	N.D.	N.D.	N.D.	N.D.	N.D.	N.D.	N.D.	N.D.	N.D.	N.D.	N.D.	A2200069617101001C	2020.04.01	鍍錫圓銅線	CTI

根據測試報告如實填寫鉛、鎘、汞、六價鉻、PBBs和PBDEs六項禁用物質的含量

包裝材料中鉛、鎘、汞、六價鉻總含量不超過100ppm，鎘的允許濃度為5ppm

歐盟ROHS指令豁免條款2015/863/EU、鋼中合金元素中的鉛含量達0.35%、鉛含量達0.4%、銅合金中的鉛含量達4%

Test Report

No. CANEC2003075602

Date: 20 Mar 2020

Page 1 of 6

DONGGUAN YUBANG PLASTIC CO., LTD.

NO. B61, PHASE III, PLASTIC RAW MATERIAL MARKET, ZHANGMUTOU TOWN, DONGGUAN CITY

The following sample(s) was/were submitted and identified on behalf of the clients as : TPEE

SGS Job No. : CP20-008870 - GZ

Date of Sample Received : 17 Mar 2020

Testing Period : 17 Mar 2020 - 20 Mar 2020

Test Requested : Selected test(s) as requested by client.

Test Method : Please refer to next page(s).

Test Results : Please refer to next page(s).

Conclusion : Based on the performed tests on submitted sample(s), the results of Lead, Mercury, Cadmium, Hexavalent chromium, Polybrominated biphenyls (PBBs), Polybrominated diphenyl ethers (PBDEs) and Phthalates such as Bis(2-ethylhexyl) phthalate (DEHP) , Butyl benzyl phthalate (BBP), Dibutyl phthalate (DBP) , and Diisobutyl phthalate (DIBP) comply with the limits as set by RoHS Directive (EU) 2015/863 amending Annex II to Directive 2011/65/EU.

Signed for and on behalf of
SGS-CSTC Standards Technical Services Co., Ltd. Guangzhou Branch

Violet, Shi
Approved Signatory



Test Report

No. CANEC2003075602

Date: 20 Mar 2020

Page 2 of 6

Test Results :

Test Part Description :

Specimen No.	SGS Sample ID	Description
SN1	CAN20-030756.002	Beige plastic grains

Remarks :

- (1) 1 mg/kg = 0.0001%
- (2) MDL = Method Detection Limit
- (3) ND = Not Detected (< MDL)
- (4) "-" = Not Regulated

RoHS Directive (EU) 2015/863 amending Annex II to Directive 2011/65/EU

Test Method : With reference to IEC 62321-4:2013+A1:2017, IEC 62321-5:2013, IEC 62321-7-2:2017 , IEC 62321-6:2015 and IEC 62321-8:2017, analyzed by ICP-OES , UV-Vis and GC-MS .

<u>Test Item(s)</u>	<u>Limit</u>	<u>Unit</u>	<u>MDL</u>	<u>002</u>
Cadmium (Cd)	100	mg/kg	2	ND
Lead (Pb)	1,000	mg/kg	2	ND
Mercury (Hg)	1,000	mg/kg	2	ND
Hexavalent Chromium (CrVI)	1,000	mg/kg	8	ND
Sum of PBBs	1,000	mg/kg	-	ND
Monobromobiphenyl	-	mg/kg	5	ND
Dibromobiphenyl	-	mg/kg	5	ND
Tribromobiphenyl	-	mg/kg	5	ND
Tetrabromobiphenyl	-	mg/kg	5	ND
Pentabromobiphenyl	-	mg/kg	5	ND
Hexabromobiphenyl	-	mg/kg	5	ND
Heptabromobiphenyl	-	mg/kg	5	ND
Octabromobiphenyl	-	mg/kg	5	ND
Nonabromobiphenyl	-	mg/kg	5	ND
Decabromobiphenyl	-	mg/kg	5	ND
Sum of PBDEs	1,000	mg/kg	-	ND
Monobromodiphenyl ether	-	mg/kg	5	ND
Dibromodiphenyl ether	-	mg/kg	5	ND
Tribromodiphenyl ether	-	mg/kg	5	ND
Tetrabromodiphenyl ether	-	mg/kg	5	ND
Pentabromodiphenyl ether	-	mg/kg	5	ND



Unless otherwise agreed in writing, this document is issued by the Company subject to its General Conditions of Service printed overleaf, available on request or accessible at <http://www.sgs.com/en/Terms-and-Conditions.aspx> and, for electronic format documents, subject to Terms and Conditions for Electronic Documents at <http://www.sgs.com/en/Terms-and-Conditions/Terms-e-Documents.aspx>. Attention is drawn to the limitation of liability, indemnification and jurisdiction issues defined therein. Any holder of this document is advised that information contained hereon reflects the Company's findings at the time of its intervention only and within the limits of Client's instructions, if any. The Company's sole responsibility is to its Client and this document does not exonerate parties to a transaction from exercising all their rights and obligations under the transaction documents. This document cannot be reproduced except in full, without prior written approval of the Company. Any unauthorized alteration, forgery or falsification of the content or appearance of this document is unlawful and offenders may be prosecuted to the fullest extent of the law. Unless otherwise stated the results shown in this test report refer only to the sample(s) tested.

Attention: To check the authenticity of testing /inspection report & certificate, please contact us at telephone: (86-755) 8307 1443, or email: CN.Doccheck@sgs.com

Test Report

No. CANEC2003075602

Date: 20 Mar 2020

Page 3 of 6

<u>Test Item(s)</u>	<u>Limit</u>	<u>Unit</u>	<u>MDL</u>	<u>002</u>
Hexabromodiphenyl ether	-	mg/kg	5	ND
Heptabromodiphenyl ether	-	mg/kg	5	ND
Octabromodiphenyl ether	-	mg/kg	5	ND
Nonabromodiphenyl ether	-	mg/kg	5	ND
Decabromodiphenyl ether	-	mg/kg	5	ND
Dibutyl phthalate (DBP)	1,000	mg/kg	50	ND
Butyl benzyl phthalate (BBP)	1,000	mg/kg	50	ND
Bis (2-ethylhexyl) phthalate (DEHP)	1,000	mg/kg	50	ND
Diisobutyl Phthalates (DIBP)	1,000	mg/kg	50	ND

Notes :

- (1) The maximum permissible limit is quoted from RoHS Directive (EU) 2015/863.IEC 62321 series is equivalent to EN 62321 series
https://www.cenelec.eu/dyn/www/f?p=104:30:1742232870351101:::FSP_ORG_ID,FSP_LANG_ID:1258637,25
- (2) The restriction of DEHP, BBP, DBP and DIBP shall apply to medical devices, including in vitro medical devices, and monitoring and control instruments, including industrial monitoring and control instruments, from 22 July 2021.
- (3) The restriction of DEHP, BBP, DBP and DIBP shall not apply to toys which are already subject to the restriction of DEHP, BBP, DBP and DIBP through entry 51 of Annex XVII to Regulation (EC) No 1907/2006.



ATTACHMENTS

Pb/Cd/Hg/Cr⁶⁺/PBBs/PBDEs Testing Flow Chart

1) These samples were dissolved totally by pre-conditioning method according to below flow chart. (Cr⁶⁺ and PBBs/PBDEs test method excluded).

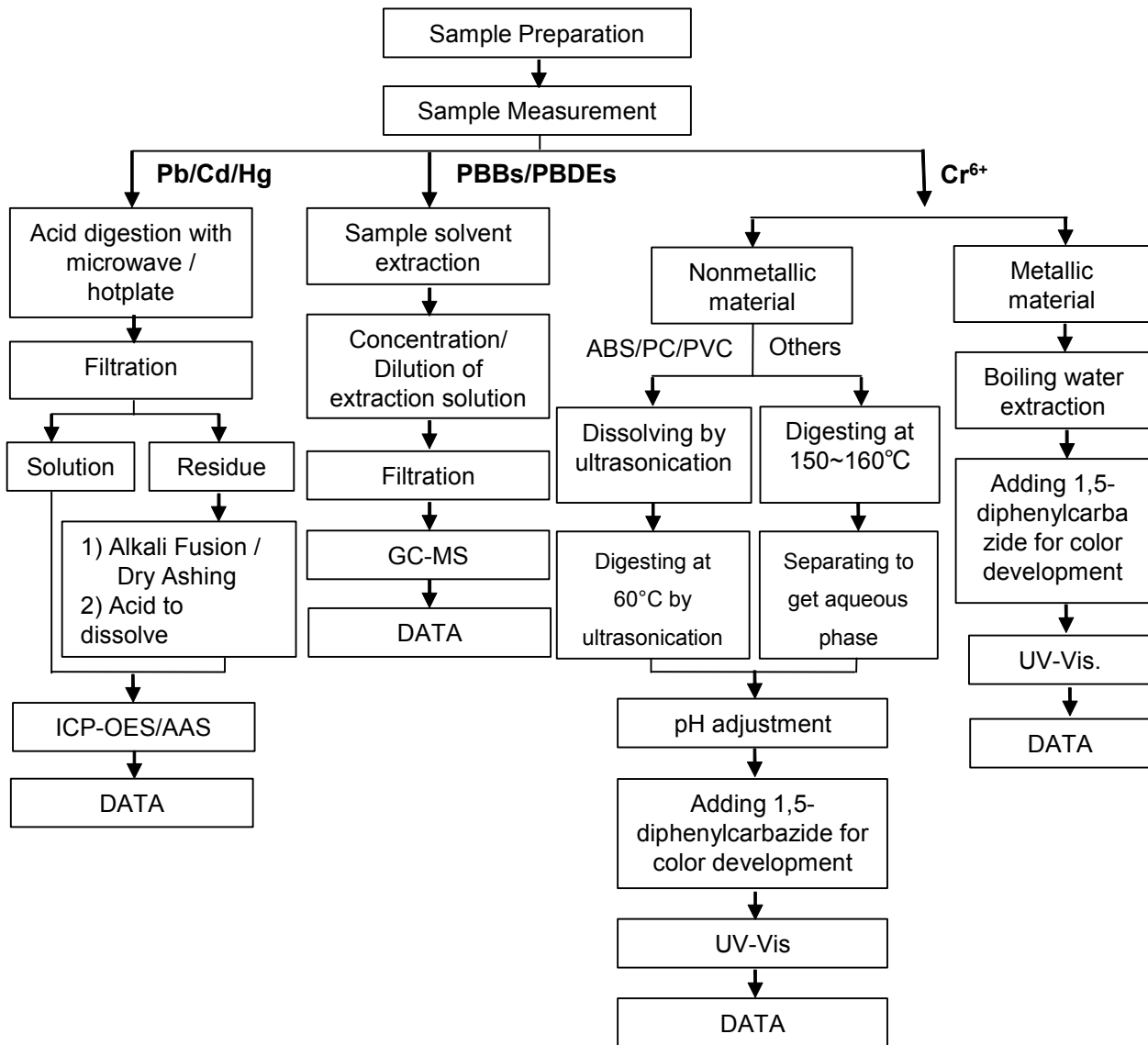

Unless otherwise agreed in writing, this document is issued by the Company subject to its General Conditions of Service printed overleaf, available on request or accessible at <http://www.sgs.com/en/Terms-and-Conditions.aspx> and, for electronic format documents, subject to Terms and Conditions for Electronic Documents at <http://www.sgs.com/en/Terms-and-Conditions/Terms-e-Documents.aspx>. Attention is drawn to the limitation of liability, indemnification and jurisdiction issues defined therein. Any holder of this document is advised that information contained hereon reflects the Company's findings at the time of its intervention only and within the limits of Client's instructions, if any. The Company's sole responsibility is to its Client and this document does not exonerate parties to a transaction from exercising all their rights and obligations under the transaction documents. This document cannot be reproduced except in full, without prior written approval of the Company. Any unauthorized alteration, forgery or falsification of the content or appearance of this document is unlawful and offenders may be prosecuted to the fullest extent of the law. Unless otherwise stated the results shown in this test report refer only to the sample(s) tested.

Attention: To check the authenticity of testing /inspection report & certificate, please contact us at telephone: (86-755) 8307 1443, or email: CN.Doccheck@sgs.com

ATTACHMENTS

Phthalates Testing Flow Chart

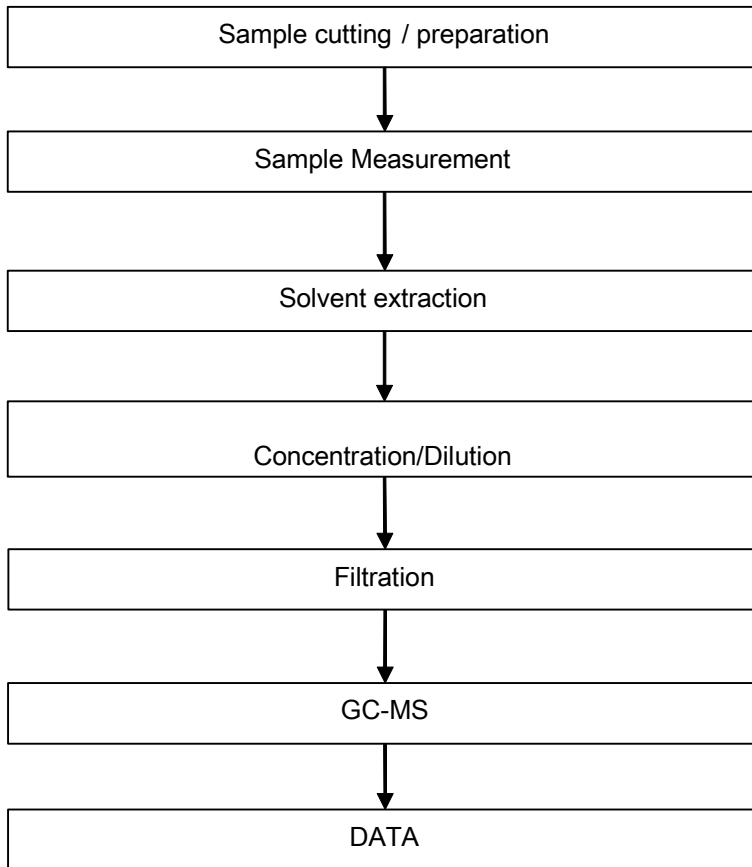

Sample photo:



SGS authenticate the photo on original report only

*** End of Report ***

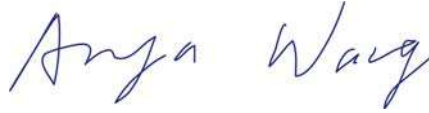

Prüfbericht - Nr.: 238113368s1 001 <i>Test Report No.:</i>		Seite 1 von 6 Page 1 of 6	
Auftraggeber: <i>Client:</i>	Chi Mei Corporation No.59-1, Sanjiazi, Rende Dist., Tainan City 71702, Taiwan, R.O.C.		
Gegenstand der Prüfung: <i>Test Item:</i>	ACRYLONITRILE-BUTADIENE-STYRENE COPOLYMER		
Bezeichnung: <i>Identification:</i>	POLYLAC® PA-757		
Anlieferungszustand: <i>Delivery condition:</i>	apparent good	Eingangsdatum: <i>Date of Receipt:</i>	2019-12-09
Prüfört: <i>Testing location:</i>	TÜV Rheinland (Shanghai) Co. Ltd.		
Prüfgrundlage: <i>Test specification:</i>	According to RoHS (recast): Restriction of the Use of Certain Hazardous Substances in Electrical and Electronic Equipment, 2011/65/EU Annex II and its amendment Directive (EU) 2015/863: Total Content of Lead, Cadmium, Mercury, Chromium VI, Polybrominated Biphenyls, Polybrominated Diphenyl Ethers; and Benzylbutyl phthalate (BBP), Dibutyl phthalate (DBP), Bis(2-ethylhexyl) phthalate (DEHP), Diisobutyl phthalate (DIBP) and Halogen (Fluorine, Chlorine, Bromine, Iodine)		
Prüfergebnis: <i>Test result:</i>	The test results are the measurements, stated in the test report.		
geprüft: tested by:	kontrolliert: checked by:		
			
2020-01-13 Fanny Lin /Project Coordinator		2020-01-13 Anya Wang /Project Coordinator	
Datum <i>Date</i>	Name/Stellung <i>Name/Position</i>	Unterschrift <i>Signature</i>	Datum <i>Date</i>
Sonstiges/ Other Aspects: Test period: 2019-12-09 – 2020-01-02 ; 2020-01-03 – 2020-01-13			
Abkürzungen:	ok / P = entspricht Prüfgrundlage fail / F = entspricht nicht Prüfgrundlage n.a. / N = nicht anwendbar	Abbreviations:	ok / P = passed fail / F = failed n.a. / N = not applicable
<p>Dieser Prüfbericht bezieht sich nur auf das o.g. Prüfmuster und darf ohne Genehmigung der Prüfstelle nicht auszugsweise vervielfältigt werden. Dieser Bericht berechtigt nicht zur Verwendung eines Prüfzeichens.</p> <p><i>This test report relates to the a. m. test sample. Without permission of the test center this test report is not permitted to be duplicated in extracts. This test report does not entitle to carry any safety mark on this or similar products.</i></p>			

Test Report No. : 238113368s1 001 2020-01-13
 Customer : Chi Mei Corporation
 Test Method : Total Cadmium, Lead, Mercury, Chromium
 - Ref. to IEC 62321-4:2013 and IEC 62321-5:2013
 Chromium (VI)
 - For Metal material - Ref. to IEC 62321-7-1:2015
 - For Plastic or Electronic material - Ref. to IEC 62321-7-2:2017
 - For Leather material - Ref. to EN ISO 17075-1:2017
 PBBs, PBDEs - Ref. to IEC 62321-6:2015

Sample Material Lab.-No.		LoD	POLYLAC® PA-757 plastic/off white TCL191209-34
Cadmium (Cd)	mg/kg	2	n.d.
Lead (Pb)	mg/kg	2	n.d.
Mercury (Hg)	mg/kg	2	n.d.
Chromium VI (Cr VI)*	mg/kg	8	n.d.
Sum of Polybrominated biphenyls (PBBs)	mg/kg	-	n.d.
Monobromobiphenyl	mg/kg	5	n.d.
Dibromobiphenyl	mg/kg	5	n.d.
Tribromobiphenyl	mg/kg	5	n.d.
Tetrabromobiphenyl	mg/kg	5	n.d.
Pentabromobiphenyl	mg/kg	5	n.d.
Hexabromobiphenyl	mg/kg	5	n.d.
Heptabromobiphenyl	mg/kg	5	n.d.
Octabromobiphenyl	mg/kg	5	n.d.
Nonabromobiphenyl	mg/kg	5	n.d.
Decabromobiphenyl	mg/kg	5	n.d.
Sum of Polybrominated diphenyl ethers (PBDEs)	mg/kg	-	n.d.
Monobromodiphenyl ether	mg/kg	5	n.d.
Dibromodiphenyl ether	mg/kg	5	n.d.
Tribromodiphenyl ether	mg/kg	5	n.d.
Tetrabromodiphenyl ether	mg/kg	5	n.d.
Pentabromodiphenyl ether	mg/kg	5	n.d.
Hexabromodiphenyl ether	mg/kg	5	n.d.
Heptabromodiphenyl ether	mg/kg	5	n.d.
Octabromodiphenyl ether	mg/kg	5	n.d.
Nonabromodiphenyl ether	mg/kg	5	n.d.
Decabromodiphenyl ether	mg/kg	5	n.d.

Notes:

- n.d. - not detected
- LoD - Limit of Detection
- mg/kg is equal to ppm (parts per million)
- *Once the total Cr content in metal/ plastic or electronic sample is found to be exceeded the limit, the Cr (VI) content will be confirmed with reference to IEC 62321-7-1:2015/ IEC 62321-7-2:2017

	Cd	Cr(VI)	Pb	Hg	PBBs	PBDEs
Maximum permissible Limit acc. to 2011/65/EU (mg/kg)	100	1000	1000	1000	1000	1000

Produkte
Products

Test Report No. : 238113368s1 001
 Customer : Chi Mei Corporation
 Test Method : BBP/DBP/DEHP/DIBP - Ref. to IEC 62321-8:2017
 Halogen - Following EN 14582; determination by I.C.

2020-01-13

Sample Material Lab.-No.		LoD	POLYLAC® PA-757 plastic/off white TCL191209-34
Benzylbutylphthalate (BBP)	mg/kg	50	n.d.
Dibutylphthalate (DBP)	mg/kg	50	n.d.
Diethylhexylphthalate (DEHP)	mg/kg	50	n.d.
Diisobutylphthalate (DIBP)	mg/kg	50	n.d.

	BBP	DBP	DEHP	DIBP
Maximum permissible Limit acc. to (EU) 2015/863 (mg/kg)	1000	1000	1000	1000

Sample Material Lab.-No.		LoD	POLYLAC® PA-757 plastic/off white TCL191209-34
Halogen	Unit	LoD	Result
Fluorine (F)	mg/kg	50	n.d.
Chlorine (Cl)	mg/kg	50	n.d.
Bromine (Br)	mg/kg	50	n.d.
Iodine (I)	mg/kg	50	n.d.

Notes:

- n.d. - not detected
- n.a. - not applicable
- LoD - Limit of Detection
- mg/kg is equal to ppm (parts per million)

Test Sample

Test Report No. : 238113368s1 001
 Customer : Chi Mei Corporation

2020-01-13

Testing procedure:

RoHS (Pb, Cd, Hg, Cr(VI))

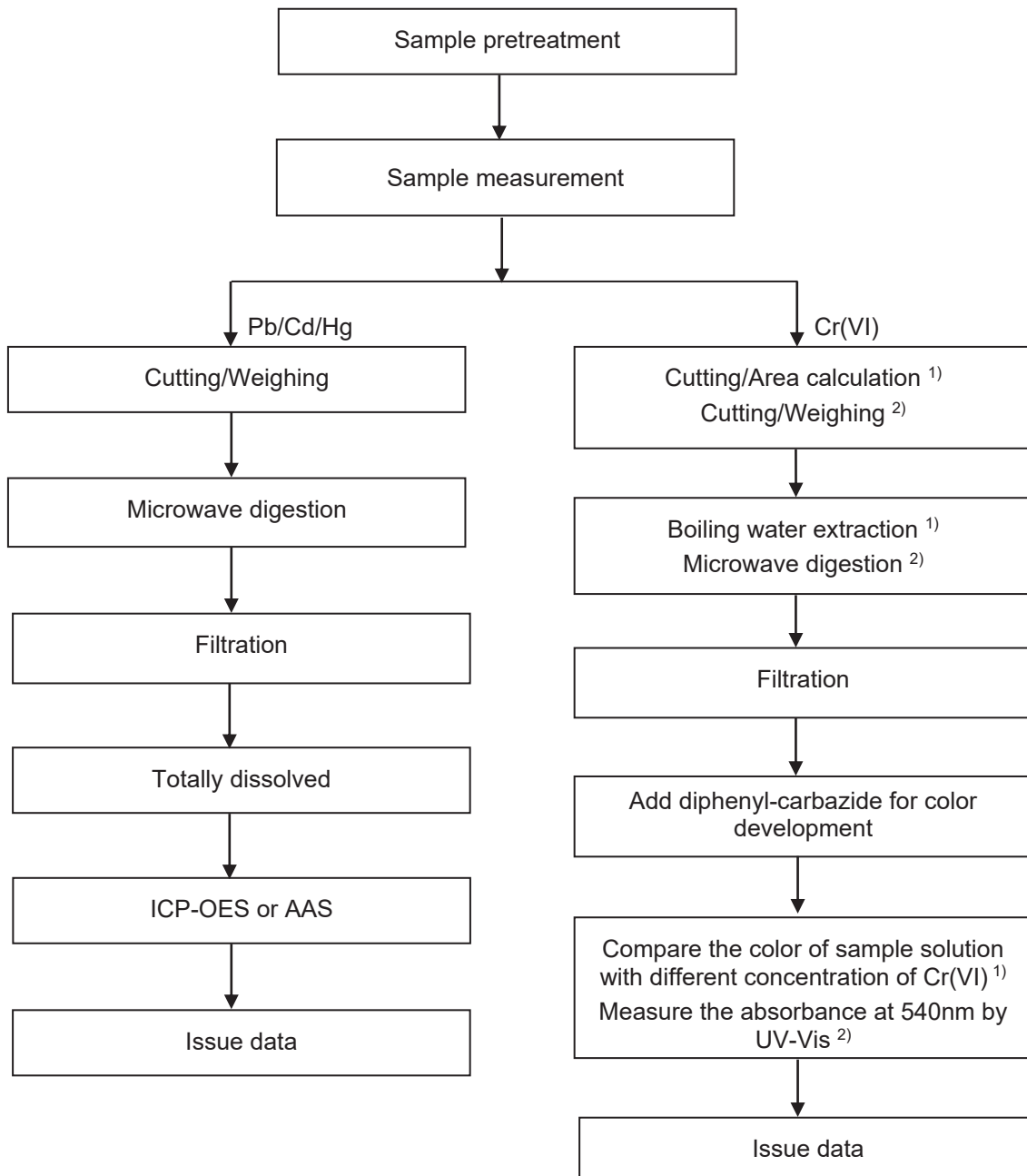

Notes: ¹⁾ For metallic material
²⁾ For non-metallic material

Test Report No. : 238113368s1 001
Customer : Chi Mei Corporation

2020-01-13

Testing procedure:

RoHS (PBBs/PBDEs, DEHP/DBP/BBP/DIBP)

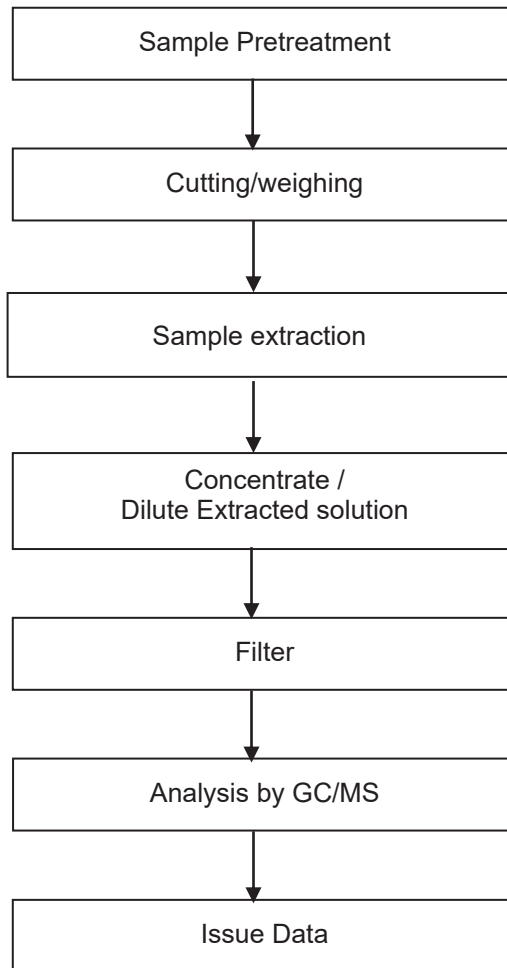

Test Report No. : 238113368s1 001
Customer : Chi Mei Corporation

2020-01-13

Testing procedure:

Halogen

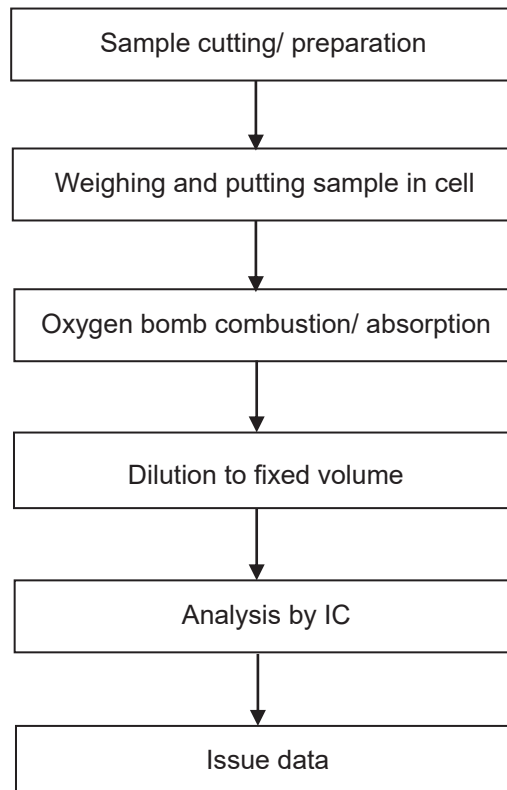

--- End of Test-Report ---



Test Report No. F690101/LF-CTSAYAA20-01642

Issued Date : 2020. 01. 16

Page 1 of 5

KOREA ENGINEERING PLASTICS CO., LTD.
84,Jangsaengpogorae-ro
Nam-gu,Ulsan
Korea

The following sample(s) was/were submitted and identified by/on behalf of the client as:-

SGS File No. : AYAA20-01642
Product Name : KEPITAL 1
Item No./Part No. : F20-03
Received Date : 2020. 01. 10
Test Period : 2020. 01. 10 to 2020. 01. 16
Test Results : For further details, please refer to following page(s)

SGS Korea Co., Ltd.
/ Gimhae Laboratory

Thomas Hwang / Lab Manager

This document is issued by the Company subject to its General Conditions of Service printed overleaf, available on request or accessible at <http://www.sgs.com/en/Terms-and-Conditions.aspx> and, for electronic format documents, subject to Terms and Conditions for Electronic Documents at www.sgs.com/terms_e-document.htm <http://www.sgs.com/terms_e-document.htm>. Attention is drawn to the limitation of liability, indemnification and jurisdiction issues defined therein. Any holder of this document is advised that information contained hereon reflects the Company's findings at the time of its intervention only and within the limits of Client's instructions, if any. The Company's sole responsibility is to its Client and this document does not exonerate parties to a transaction from exercising all their rights and obligations under the transaction documents. This document cannot be reproduced except in full, without prior written approval of the Company. Any unauthorized alteration, forgery or falsification of the content or appearance of this document is unlawful and offenders may be prosecuted to the fullest extent of the law. Unless otherwise stated the results shown in this test report refer only to the sample(s).



Test Report No. F690101/LF-CTSAYAA20-01642

Issued Date : 2020. 01. 16

Page 2 of 5

Sample No. : AYAA20-01642.001
 Sample Description : KEPITAL 1
 Item No./Part No. : F20-03
 Materials : N/A

Heavy Metals

Test Items	Unit	Test Method	MDL	Results
Cadmium (Cd)	mg/kg	With reference to IEC 62321-5:2013(Determination of Cadmium by ICP-OES)	0.5	N.D.
Lead (Pb)	mg/kg	With reference to IEC 62321-5:2013(Determination of Lead by ICP-OES)	5	N.D.
Mercury (Hg)	mg/kg	With reference to IEC 62321-4:2013(Determination of Mercury by ICP-OES)	2	N.D.
Hexavalent Chromium (Cr VI)	mg/kg	with reference to IEC 62321:2008 (Determination of Hexavalent Chromium by spot test/Colorimetric Method using UV-Vis)	1	N.D.

Flame Retardants-PBBs/PBDEs

Test Items	Unit	Test Method	MDL	Results
Monobromobiphenyl	mg/kg	With reference to IEC 62321:2008 (Determination of PBBs and PBDEs by GC-MS)	5	N.D.
Dibromobiphenyl	mg/kg	With reference to IEC 62321:2008 (Determination of PBBs and PBDEs by GC-MS)	5	N.D.
Tribromobiphenyl	mg/kg	With reference to IEC 62321:2008 (Determination of PBBs and PBDEs by GC-MS)	5	N.D.
Tetrabromobiphenyl	mg/kg	With reference to IEC 62321:2008 (Determination of PBBs and PBDEs by GC-MS)	5	N.D.
Pentabromobiphenyl	mg/kg	With reference to IEC 62321:2008 (Determination of PBBs and PBDEs by GC-MS)	5	N.D.
Hexabromobiphenyl	mg/kg	With reference to IEC 62321:2008 (Determination of PBBs and PBDEs by GC-MS)	5	N.D.
Heptabromobiphenyl	mg/kg	With reference to IEC 62321:2008 (Determination of PBBs and PBDEs by GC-MS)	5	N.D.
Octabromobiphenyl	mg/kg	With reference to IEC 62321:2008 (Determination of PBBs and PBDEs by GC-MS)	5	N.D.
Nonabromobiphenyl	mg/kg	With reference to IEC 62321:2008 (Determination of PBBs and PBDEs by GC-MS)	5	N.D.
Decabromobiphenyl	mg/kg	With reference to IEC 62321:2008 (Determination of PBBs and PBDEs by GC-MS)	5	N.D.
Monobromodiphenyl ether	mg/kg	With reference to IEC 62321:2008 (Determination of PBBs and PBDEs by GC-MS)	5	N.D.
Dibromodiphenyl ether	mg/kg	With reference to IEC 62321:2008 (Determination of PBBs and PBDEs by GC-MS)	5	N.D.
Tribromodiphenyl ether	mg/kg	With reference to IEC 62321:2008 (Determination of PBBs and PBDEs by GC-MS)	5	N.D.

This document is issued by the Company subject to its General Conditions of Service printed overleaf, available on request or accessible at <http://www.sgs.com/en/Terms-and-Conditions.aspx> and, for electronic format documents, subject to Terms and Conditions for Electronic Documents at www.sgs.com/terms_e-document.htm <http://www.sgs.com/terms_e-document.htm>. Attention is drawn to the limitation of liability, indemnification and jurisdiction issues defined therein. Any holder of this document is advised that information contained hereon reflects the Company's findings at the time of its intervention only and within the limits of Client's instructions, if any. The Company's sole responsibility is to its Client and this document does not exonerate parties to a transaction from exercising all their rights and obligations under the transaction documents. This document cannot be reproduced except in full, without prior written approval of the Company. Any unauthorized alteration, forgery or falsification of the content or appearance of this document is unlawful and offenders may be prosecuted to the fullest extent of the law. Unless otherwise stated the results shown in this test report refer only to the sample(s).

Sample No. : AYAA20-01642.001
Sample Description : KEPITAL 1
Item No./Part No. : F20-03
Materials : N/A

Flame Retardants-PBBs/PBDEs

Test Items	Unit	Test Method	MDL	Results
Tetrabromodiphenyl ether	mg/kg	With reference to IEC 62321:2008 (Determination of PBBs and PBDEs by GC-MS)	5	N.D.
Pentabromodiphenyl ether	mg/kg	With reference to IEC 62321:2008 (Determination of PBBs and PBDEs by GC-MS)	5	N.D.
Hexabromodiphenyl ether	mg/kg	With reference to IEC 62321:2008 (Determination of PBBs and PBDEs by GC-MS)	5	N.D.
Heptabromodiphenyl ether	mg/kg	With reference to IEC 62321:2008 (Determination of PBBs and PBDEs by GC-MS)	5	N.D.
Octabromodiphenyl ether	mg/kg	With reference to IEC 62321:2008 (Determination of PBBs and PBDEs by GC-MS)	5	N.D.
Nonabromodiphenyl ether	mg/kg	With reference to IEC 62321:2008 (Determination of PBBs and PBDEs by GC-MS)	5	N.D.
Decabromodiphenyl ether	mg/kg	With reference to IEC 62321:2008 (Determination of PBBs and PBDEs by GC-MS)	5	N.D.

- NOTE:
- (1) N.D. = Not detected.(<MDL)
 - (2) mg/kg = ppm
 - (3) MDL = Method Detection Limit
 - (4) - = No regulation
 - (5) Negative = Undetectable / Positive = Detectable
 - (6) ** = Qualitative analysis (No Unit)
 - (7) * = Boiling-water-extraction:
 - Negative = Absence of CrVI coating
 - Positive = Presence of CrVI coating; the detected concentration in boiling-water-extraction solution is equal or greater than 0.02 mg/kg with 50 cm² sample surface area.

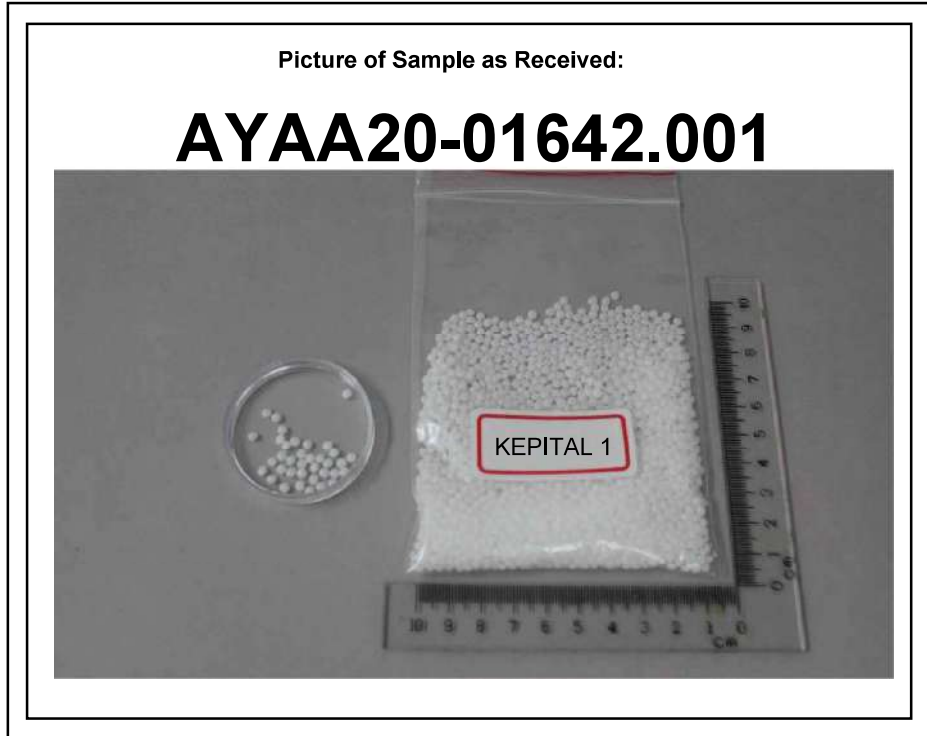

This document is issued by the Company subject to its General Conditions of Service printed overleaf, available on request or accessible at <http://www.sgs.com/en/Terms-and-Conditions.aspx> and, for electronic format documents, subject to Terms and Conditions for Electronic Documents at www.sgs.com/terms_e-document.htm http://www.sgs.com/terms_e-document.htm. Attention is drawn to the limitation of liability, indemnification and jurisdiction issues defined therein. Any holder of this document is advised that information contained hereon reflects the Company's findings at the time of its intervention only and within the limits of Client's instructions, if any. The Company's sole responsibility is to its Client and this document does not exonerate parties to a transaction from exercising all their rights and obligations under the transaction documents. This document cannot be reproduced except in full, without prior written approval of the Company. Any unauthorized alteration, forgery or falsification of the content or appearance of this document is unlawful and offenders may be prosecuted to the fullest extent of the law. Unless otherwise stated the results shown in this test report refer only to the sample(s).



Testing Flow Chart for RoHS: Cd/Pb/Hg/Cr⁶⁺ /PBBs&PBDEs Testing

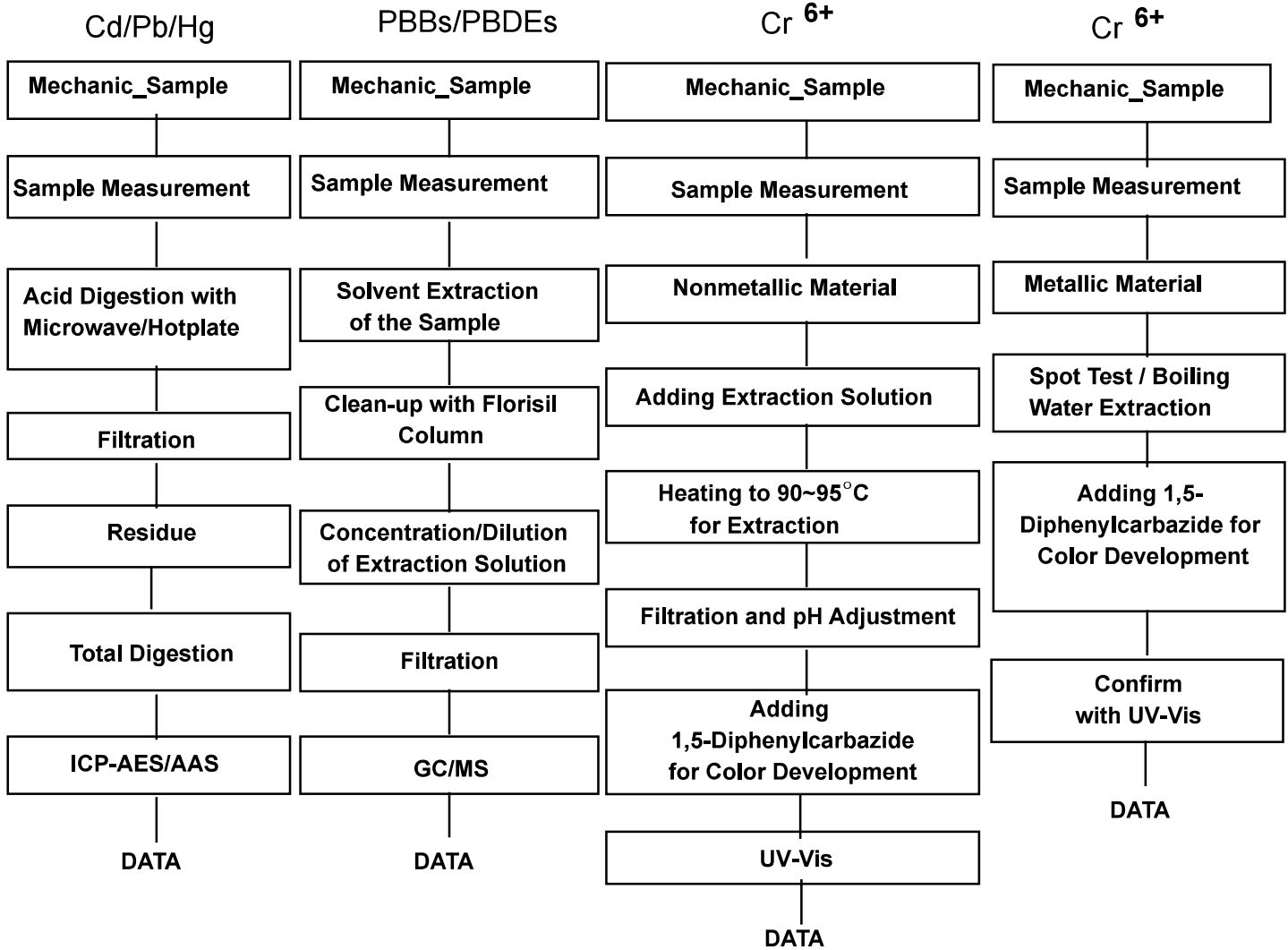

The samples were dissolved totally by pre-conditioning method according to above flow chart for Cd,Pb,Hg.
Section Chief : Shapless Park

*** End of Report ***

This document is issued by the Company subject to its General Conditions of Service printed overleaf, available on request or accessible at <http://www.sgs.com/en/Terms-and-Conditions.aspx> and, for electronic format documents, subject to Terms and Conditions for Electronic Documents at www.sgs.com/terms_e-document.htm http://www.sgs.com/terms_e-document.htm. Attention is drawn to the limitation of liability, indemnification and jurisdiction issues defined therein. Any holder of this document is advised that information contained herein reflects the Company's findings at the time of its intervention only and within the limits of Client's instructions, if any. The Company's sole responsibility is to its Client and this document does not exonerate parties to a transaction from exercising all their rights and obligations under the transaction documents. This document cannot be reproduced except in full, without prior written approval of the Company. Any unauthorized alteration, forgery or falsification of the content or appearance of this document is unlawful and offenders may be prosecuted to the fullest extent of the law. Unless otherwise stated the results shown in this test report refer only to the sample(s).

测试报告

No. CANEC2002180104

日期: 2020年03月10日 第1页,共6页

东莞市恒彩塑胶颜料有限公司
东莞市凤岗镇黄洞村工业区

以下测试之样品是由申请者所提供及确认: 黑色母粒

SGS工作编号: CP20-005691 - GZ

主要成份: PE

样品接收日期: 2020年03月04日

测试周期: 2020年03月04日 - 2020年03月10日

测试要求: 根据客户要求测试

测试方法: 请参见下一页

测试结果: 请参见下一页

结论: 基于所送样品进行的测试, 镉、铅、汞、六价铬、多溴联苯(PBBs)、多溴二苯醚(PBDEs)、邻苯二甲酸酯(如邻苯二甲酸二丁酯(DBP)、邻苯二甲酸丁酯(BBP)、邻苯二甲酸二(2-乙基己基)酯(DEHP)和邻苯二甲酸二异丁酯(DIBP))的测试结果符合欧盟RoHS指令2011/65/EU附录II的修正指令(EU) 2015/863的限值要求。

通标标准技术服务有限公司广州分公司
授权签名



Kelly Qu 屈桃李
批准签署人



测试报告

No. CANEC2002180104

日期: 2020年03月10日 第2页,共6页

测试结果:

测试样品描述:

样品编号	SGS样品ID	描述
SN1	CAN20-021801.002	黑色颗粒

备注:

- (1) 1 mg/kg = 0.0001%
- (2) MDL = 方法检测限
- (3) ND = 未检出 (< MDL)
- (4) "-" = 未规定

RoHS指令2011/65/EU附录II的修正指令(EU) 2015/863

测试方法: 参考IEC 62321-4:2013+A1:2017, IEC62321-5:2013, IEC62321-7-2:2017, IEC 62321-6:2015 和 IEC62321-8:2017, 采用 ICP-OES, UV-Vis 和 GC-MS 进行分析。

测试项目	限值	单位	MDL	002
镉 (Cd)	100	mg/kg	2	ND
铅 (Pb)	1,000	mg/kg	2	ND
汞 (Hg)	1,000	mg/kg	2	ND
六价铬(Cr(VI))	1,000	mg/kg	8	ND
多溴联苯之和(PBBs)	1,000	mg/kg	-	ND
一溴联苯	-	mg/kg	5	ND
二溴联苯	-	mg/kg	5	ND
三溴联苯	-	mg/kg	5	ND
四溴联苯	-	mg/kg	5	ND
五溴联苯	-	mg/kg	5	ND
六溴联苯	-	mg/kg	5	ND
七溴联苯	-	mg/kg	5	ND
八溴联苯	-	mg/kg	5	ND
九溴联苯	-	mg/kg	5	ND
十溴联苯	-	mg/kg	5	ND
多溴二苯醚之和(PBDEs)	1,000	mg/kg	-	ND
一溴二苯醚	-	mg/kg	5	ND
二溴二苯醚	-	mg/kg	5	ND
三溴二苯醚	-	mg/kg	5	ND
四溴二苯醚	-	mg/kg	5	ND
五溴二苯醚	-	mg/kg	5	ND



Unless otherwise agreed in writing, this document is issued by the Company subject to its General Conditions of Service printed overleaf, available on request or accessible at <http://www.sgs.com/en/Terms-and-Conditions.aspx> and, for electronic format documents, subject to Terms and Conditions for Electronic Documents at <http://www.sgs.com/en/Terms-and-Conditions/Terms-e-Documents.aspx>. Attention is drawn to the limitation of liability, indemnification and jurisdiction issues defined therein. Any holder of this document is advised that information contained hereon reflects the Company's findings at the time of its intervention only and within the limits of Client's instructions, if any. The Company's sole responsibility is to its Client and this document does not exonerate parties to a transaction from exercising all their rights and obligations under the transaction documents. This document cannot be reproduced except in full, without prior written approval of the Company. Any unauthorized alteration, forgery or falsification of the content or appearance of this document is unlawful and offenders may be prosecuted to the fullest extent of the law. Unless otherwise stated the results shown in this test report refer only to the sample(s) tested.

Attention: To check the authenticity of testing /inspection report & certificate, please contact us at telephone: (86-755) 8307 1443, or email: CN.Doccheck@sgs.com

测试报告

No. CANEC2002180104

日期: 2020年03月10日 第3页,共6页

测试项目	限值	单位	MDL	002
六溴二苯醚	-	mg/kg	5	ND
七溴二苯醚	-	mg/kg	5	ND
八溴二苯醚	-	mg/kg	5	ND
九溴二苯醚	-	mg/kg	5	ND
十溴二苯醚	-	mg/kg	5	ND
邻苯二甲酸二丁酯 (DBP)	1000	mg/kg	50	ND
邻苯二甲酸丁苯酯(BBP)	1000	mg/kg	50	ND
邻苯二甲酸二(2-乙基己基)酯(DEHP)	1000	mg/kg	50	ND
邻苯二甲酸二异丁酯(DIBP)	1000	mg/kg	50	ND

备注:

- (1)最大允许极限值引用自RoHS指令(EU) 2015/863 。IEC 62321系列等同于 EN 62321系列
https://www.cenelec.eu/dyn/www/f?p=104:30:1742232870351101:::FSP_ORG_ID,FSP_LANG_ID:1258637,25
 - (2) 2021年7月22号开始, DEHP, BBP, DBP 和 DIBP的限制适用于医疗器械, 包括体外医疗器械, 监控仪表, 包括工业监测和控制仪器。
 - (3) DEHP, BBP, DBP 和 DIBP的限制不适用于玩具产品, 因为No.1907/2006附录XVII第51条已对玩具产品中的DEHP, BBP, DBP 和 DIBP含量进行了限制。
- 除非另有说明, 此报告结果仅对测试的样品负责。本报告未经本公司书面许可, 不可部分复制。检测报告仅用于客户科研、教学、内部质量控制、产品研发等目的, 仅供内部参考。



Unless otherwise agreed in writing, this document is issued by the Company subject to its General Conditions of Service printed overleaf, available on request or accessible at <http://www.sgs.com/en/Terms-and-Conditions.aspx> and, for electronic format documents, subject to Terms and Conditions for Electronic Documents at <http://www.sgs.com/en/Terms-and-Conditions/Terms-a-Documents.aspx>. Attention is drawn to the limitation of liability, indemnification and jurisdiction issues defined therein. Any holder of this document is advised that information contained hereon reflects the Company's findings at the time of its intervention only and within the limits of Client's instructions, if any. The Company's sole responsibility is to its Client and this document does not exonerate parties to a transaction from exercising all their rights and obligations under the transaction documents. This document cannot be reproduced except in full, without prior written approval of the Company. Any unauthorized alteration, forgery or falsification of the content or appearance of this document is unlawful and offenders may be prosecuted to the fullest extent of the law. Unless otherwise stated the results shown in this test report refer only to the sample(s) tested.

Attention: To check the authenticity of testing /inspection report & certificate, please contact us at telephone: (86-755) 8307 1443, or email: CN.Doccheck@sgs.com

附件

Pb/Cd/Hg/Cr⁶⁺/PBBs/PBDEs 测试流程图

1) 样品按照下述流程被完全消解（六价铬和多溴联苯/多溴二苯醚测试除外）。

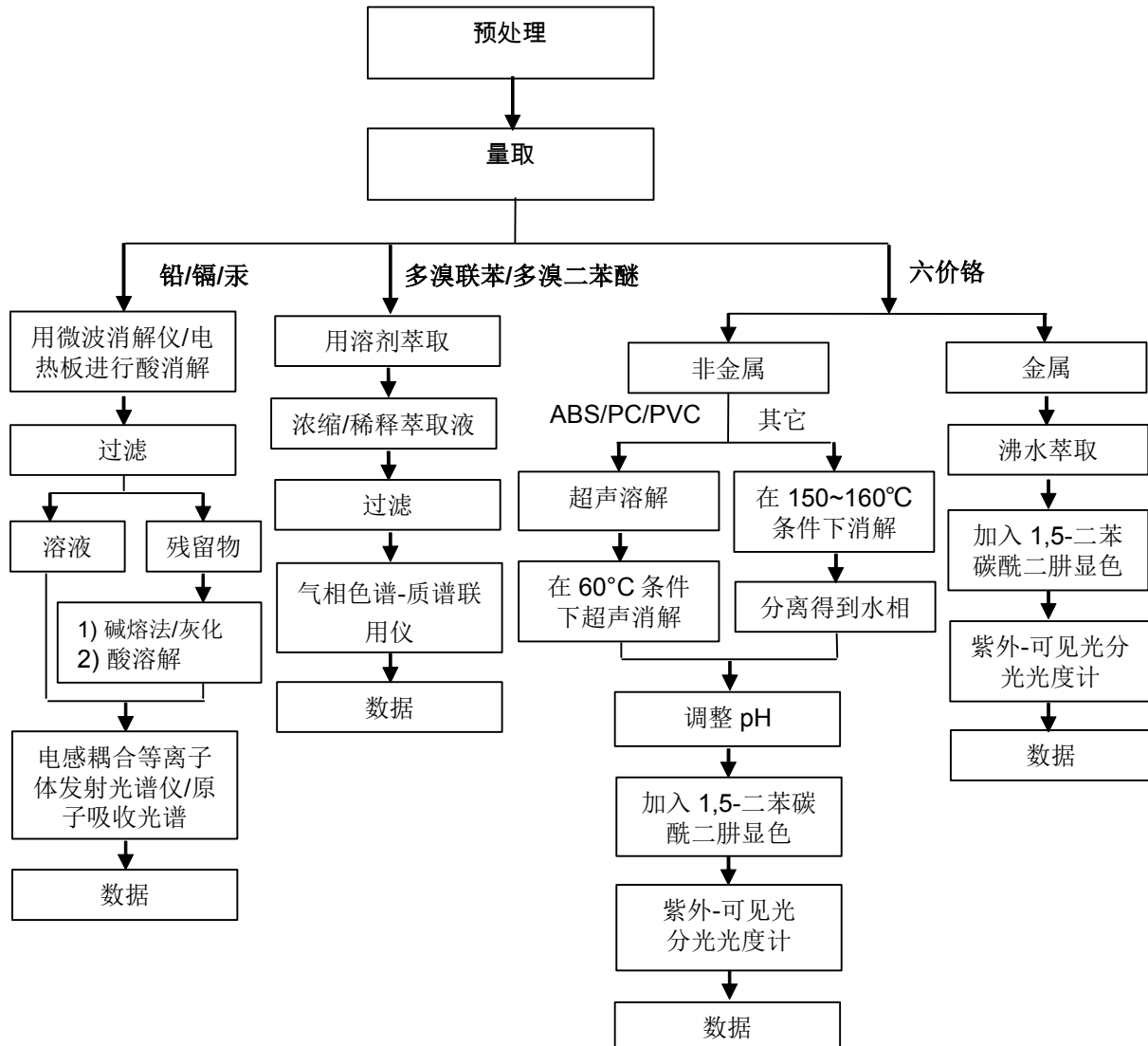

Unless otherwise agreed in writing, this document is issued by the Company subject to its General Conditions of Service printed overleaf, available on request or accessible at <http://www.sgs.com/en/Terms-and-Conditions.aspx> and, for electronic format documents, subject to Terms and Conditions for Electronic Documents at <http://www.sgs.com/en/Terms-and-Conditions/Terms-e-Documents.aspx>. Attention is drawn to the limitation of liability, indemnification and jurisdiction issues defined therein. Any holder of this document is advised that information contained hereon reflects the Company's findings at the time of its intervention only and within the limits of Client's instructions, if any. The Company's sole responsibility is to its Client and this document does not exonerate parties to a transaction from exercising all their rights and obligations under the transaction documents. This document cannot be reproduced except in full, without prior written approval of the Company. Any unauthorized alteration, forgery or falsification of the content or appearance of this document is unlawful and offenders may be prosecuted to the fullest extent of the law. Unless otherwise stated the results shown in this test report refer only to the sample(s) tested.

附件

Phthalates 测试流程图

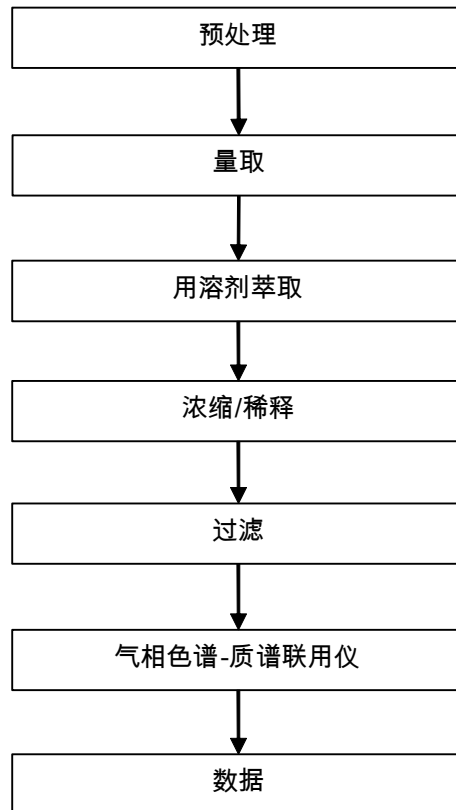

测试报告

No. CANEC2002180104

日期: 2020年03月10日 第6页,共6页

样品照片:



此照片仅限于随SGS正本报告使用

*** 报告完 ***



测试报告

No. CANML2009696204

日期: 2020年06月22日 第1页,共7页

东莞市鑫拓商贸有限公司

广东省东莞市长安镇霄边大街15号5-6号铺

以下测试之样品是由申请者所提供及确认: 无铅环保铜棒

SGS工作编号: GZIN2006029236PC - GZ

型号: HBi59-1

样品接收日期: 2020年06月16日

测试周期: 2020年06月16日 - 2020年06月22日

测试要求: 根据客户要求测试

测试方法: 请参见下一页

测试结果: 请参见下一页

结论: 基于所送样品进行的测试, 镉、铅、汞、六价铬、多溴联苯(PBBs)、多溴二苯醚(PBDEs)、邻苯二甲酸酯(如邻苯二甲酸二丁酯(DBP)、邻苯二甲酸丁苄酯(BBP)、邻苯二甲酸二(2-乙基己基)酯(DEHP)和邻苯二甲酸二异丁酯(DIBP))的测试结果符合欧盟RoHS指令2011/65/EU附录II的修正指令(EU) 2015/863的限值要求。

通标标准技术服务有限公司广州分公司
授权签名

陈江梨

Allie Chen陈江梨
批准签署人

扫码查看在线报告



CANML2009696204



测试报告

No. CANML2009696204

日期: 2020年06月22日 第2页,共7页

测试结果:

测试样品描述:

样品编号	SGS样品ID	描述
SN1	CAN20-096962.004	黄铜色金属

备注:

- (1) 1 mg/kg = 0.0001%
- (2) MDL = 方法检测限
- (3) ND = 未检出 (< MDL)
- (4) "-" = 未规定

RoHS指令2011/65/EU附录II的修正指令(EU) 2015/863

测试方法: 参考IEC 62321-4:2013+A1:2017, IEC 62321-5:2013, IEC 62321-7-1:2015, IEC 62321-6:2015 和 IEC 62321-8:2017, 采用 ICP-OES, UV-Vis 和 GC-MS 进行分析。

测试项目	限值	单位	MDL	004
镉 (Cd)	100	mg/kg	2	ND
铅 (Pb)	1,000	mg/kg	2	30
汞 (Hg)	1,000	mg/kg	2	ND
六价铬(Cr(VI))▼	-	µg/cm ²	0.10	ND
多溴联苯之和(PBBs)	1,000	mg/kg	-	ND
一溴联苯	-	mg/kg	5	ND
二溴联苯	-	mg/kg	5	ND
三溴联苯	-	mg/kg	5	ND
四溴联苯	-	mg/kg	5	ND
五溴联苯	-	mg/kg	5	ND
六溴联苯	-	mg/kg	5	ND
七溴联苯	-	mg/kg	5	ND
八溴联苯	-	mg/kg	5	ND
九溴联苯	-	mg/kg	5	ND
十溴联苯	-	mg/kg	5	ND
多溴二苯醚之和(PBDEs)	1,000	mg/kg	-	ND
一溴二苯醚	-	mg/kg	5	ND
二溴二苯醚	-	mg/kg	5	ND
三溴二苯醚	-	mg/kg	5	ND
四溴二苯醚	-	mg/kg	5	ND
五溴二苯醚	-	mg/kg	5	ND



Unless otherwise agreed in writing, this document is issued by the Company subject to its General Conditions of Service printed overleaf, available on request or accessible at <http://www.sgs.com/en/Terms-and-Conditions.aspx> and, for electronic format documents, subject to Terms and Conditions for Electronic Documents at <http://www.sgs.com/en/Terms-and-Conditions/Terms-e-Documents.aspx>. Attention is drawn to the limitation of liability, indemnification and jurisdiction issues defined therein. Any holder of this document is advised that information contained hereon reflects the Company's findings at the time of its intervention only and within the limits of Client's instructions, if any. The Company's sole responsibility is to its Client and this document does not exonerate parties to a transaction from exercising all their rights and obligations under the transaction documents. This document cannot be reproduced except in full, without prior written approval of the Company. Any unauthorized alteration, forgery or falsification of the content or appearance of this document is unlawful and offenders may be prosecuted to the fullest extent of the law. Unless otherwise stated the results shown in this test report refer only to the sample(s) tested.

Attention: To check the authenticity of testing /inspection report & certificate, please contact us at telephone: (86-755) 8307 1443, or email: CN.Doccheck@sgs.com

测试报告

No. CANML2009696204

日期: 2020年06月22日 第3页,共7页

测试项目	限值	单位	MDL	004
六溴二苯醚	-	mg/kg	5	ND
七溴二苯醚	-	mg/kg	5	ND
八溴二苯醚	-	mg/kg	5	ND
九溴二苯醚	-	mg/kg	5	ND
十溴二苯醚	-	mg/kg	5	ND
邻苯二甲酸二丁酯 (DBP)	1000	mg/kg	50	ND
邻苯二甲酸丁苄酯(BBP)	1000	mg/kg	50	ND
邻苯二甲酸二(2-乙基己基)酯(DEHP)	1000	mg/kg	50	ND
邻苯二甲酸二异丁酯(DIBP)	1000	mg/kg	50	ND

备注:

- (1)最大允许极限值引用自RoHS指令(EU) 2015/863。IEC 62321系列等同于 EN 62321系列
https://www.cenelec.eu/dyn/www/f?p=104:30:1742232870351101:::FSP_ORG_ID,FSP_LANG_ID:1258637,25
- (2) ▼=a. 当六价格的浓度高于0.13 µg/cm²时, 样品为阳性, 即含有六价格;
 b. 当六价格的浓度为ND(低于0.10 µg/cm²)时, 样品为阴性, 即未检测到六价格;
 c. 当六价格的浓度介于0.10 µg/cm²与0.13 µg/cm²之间时, 无法直接判定是否检测到六价格, 因不同个体的样品表面差异可能会影响测定结果;
 由于未获知样品的存储条件和生产日期, 样品的六价格测试结果仅能代表测试时样品含六价格的状态。

卤素

测试方法: 参考EN 14582:2016, 用 IC分析。

测试项目	单位	MDL	004
氟 (F)	mg/kg	50	ND

除非另有说明, 此报告结果仅对测试的样品负责。本报告未经本公司书面许可, 不可部分复制。检测报告仅用于客户科研、教学、内部质量控制、产品研发等目的, 仅供内部参考。



附件

Pb/Cd/Hg/Cr⁶⁺/PBBs/PBDEs 测试流程图

1) 样品按照下述流程被完全消解 (六价铬和多溴联苯/多溴二苯醚测试除外)。

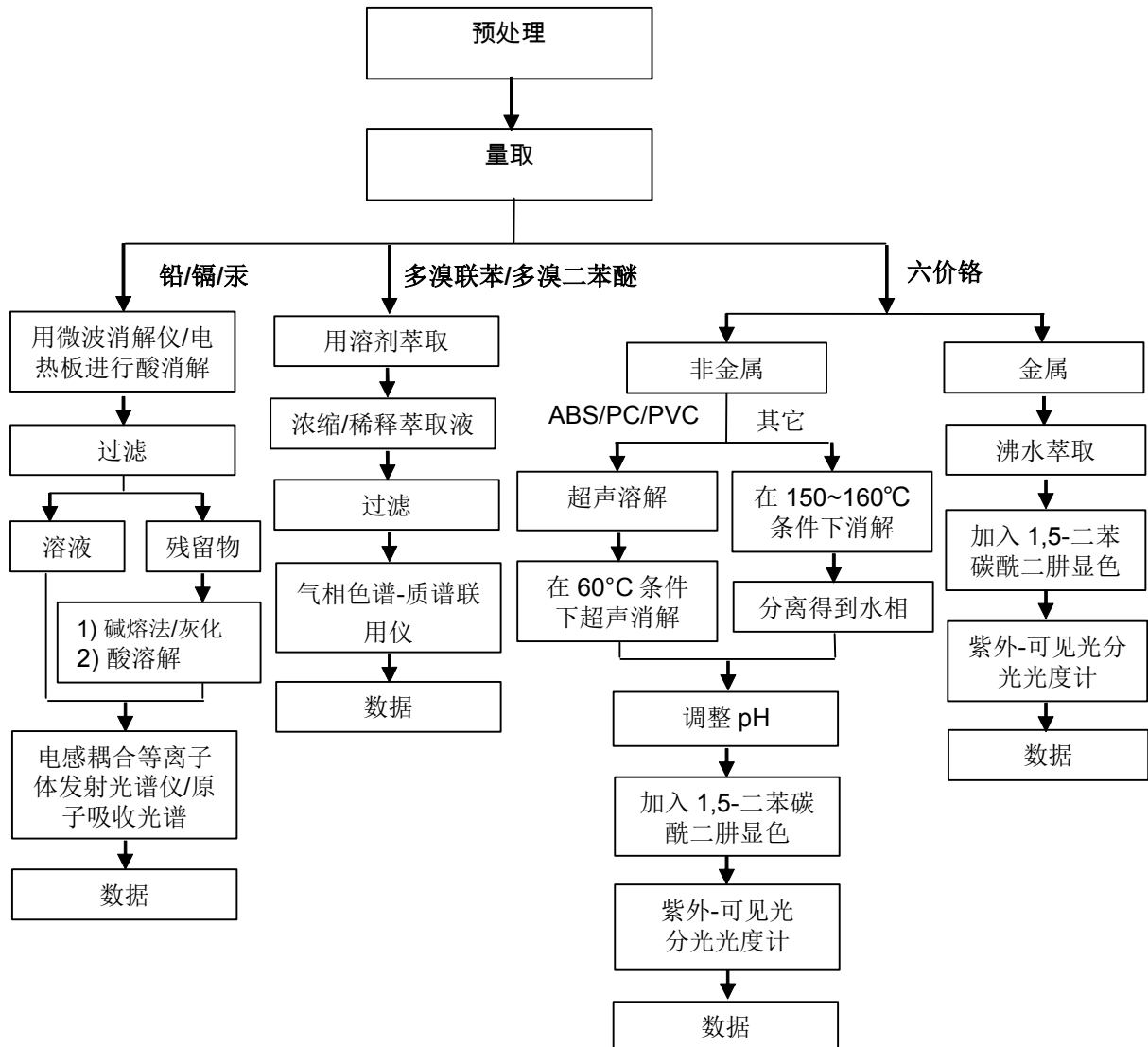

Unless otherwise agreed in writing, this document is issued by the Company subject to its General Conditions of Service printed overleaf, available on request or accessible at <http://www.sgs.com/en/Terms-and-Conditions.aspx> and, for electronic format documents, subject to Terms and Conditions for Electronic Documents at <http://www.sgs.com/en/Terms-and-Conditions/Terms-e-Document.aspx>. Attention is drawn to the limitation of liability, indemnification and jurisdiction issues defined therein. Any holder of this document is advised that information contained hereon reflects the Company's findings at the time of its intervention only and within the limits of Client's instructions, if any. The Company's sole responsibility is to its Client and this document does not exonerate parties to a transaction from exercising all their rights and obligations under the transaction documents. This document cannot be reproduced except in full, without prior written approval of the Company. Any unauthorized alteration, forgery or falsification of the content or appearance of this document is unlawful and offenders may be prosecuted to the fullest extent of the law. Unless otherwise stated the results shown in this test report refer only to the sample(s) tested.

Attention: To check the authenticity of testing /inspection report & certificate, please contact us at telephone: (86-755) 8307 1443, or email: CN.Doccheck@sgs.com

198 Kazhu Road, Sciencetech Park Guangzhou Economic & Technology Development District, Guangzhou, China 510663 t (86-20) 82155555 f (86-20) 82075113 www.sgs.com.cn
 中国·广州·经济技术开发区科学城科珠路198号 邮编: 510663 t (86-20) 82155555 f (86-20) 82075113 e sgs.china@sgs.com

附件

Phthalates 测试流程图

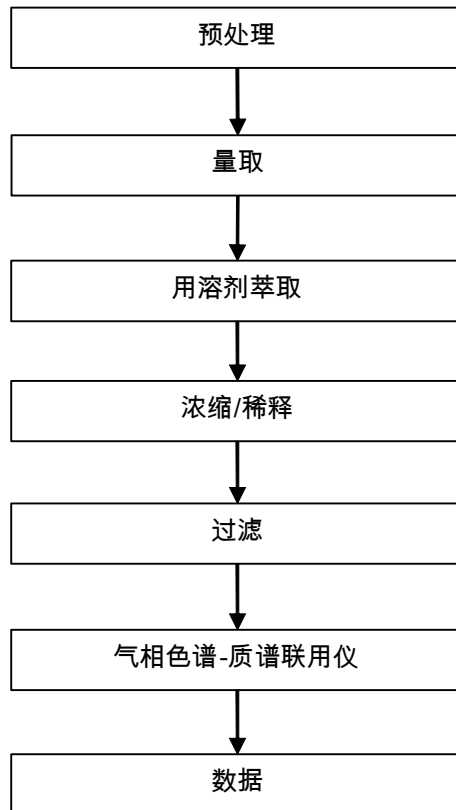

Unless otherwise agreed in writing, this document is issued by the Company subject to its General Conditions of Service printed overleaf, available on request or accessible at <http://www.sgs.com/en/Terms-and-Conditions.aspx> and, for electronic format documents, subject to Terms and Conditions for Electronic Documents at <http://www.sgs.com/en/Terms-and-Conditions/Terms-e-Documents.aspx>. Attention is drawn to the limitation of liability, indemnification and jurisdiction issues defined therein. Any holder of this document is advised that information contained hereon reflects the Company's findings at the time of its intervention only and within the limits of Client's instructions, if any. The Company's sole responsibility is to its Client and this document does not exonerate parties to a transaction from exercising all their rights and obligations under the transaction documents. This document cannot be reproduced except in full, without prior written approval of the Company. Any unauthorized alteration, forgery or falsification of the content or appearance of this document is unlawful and offenders may be prosecuted to the fullest extent of the law. Unless otherwise stated the results shown in this test report refer only to the sample(s) tested.

Attention: To check the authenticity of testing /inspection report & certificate, please contact us at telephone: (86-755) 8307 1443, or email: CN.Doccheck@sgs.com

附件

Halogen 测试流程图

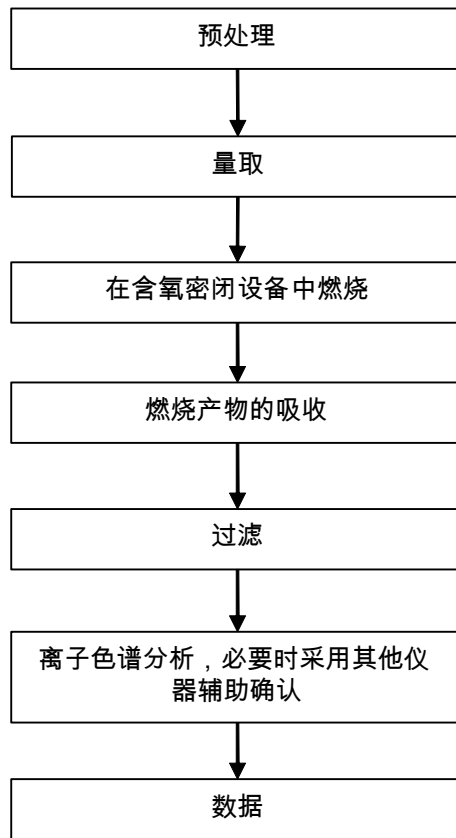

样品照片:



此照片仅限于随SGS正本报告使用

*** 报告完 ***



Test Report

No. CANEC2017668201

Date: 16 Oct 2020

Page 1 of 6

DONG GUAN WAN JIANG SONG ZHENG METAL PRODUCTION FACTORY
LUWU INDUSTRIAL ZONE, XINCUN COMMUNITY, WANJIANG DISTRICT, DONGGUAN CITY

The following sample(s) was/were submitted and identified on behalf of the clients as : H65

SGS Job No. : CP20-052772 - GZ
Client Ref. Info. : Apply to H65(C2680, C2700)
Date of Sample Received : 13 Oct 2020
Testing Period : 13 Oct 2020 - 16 Oct 2020
Test Requested : Selected test(s) as requested by client.
Test Method : Please refer to next page(s).
Test Results : Please refer to next page(s).
Conclusion : Based on the performed tests on submitted sample(s), the results of Lead, Mercury, Cadmium, Hexavalent chromium, Polybrominated biphenyls (PBBs), Polybrominated diphenyl ethers (PBDEs) and Phthalates such as Bis(2-ethylhexyl) phthalate (DEHP) , Butyl benzyl phthalate (BBP), Dibutyl phthalate (DBP) , and Diisobutyl phthalate (DIBP) comply with the limits as set by RoHS Directive (EU) 2015/863 amending Annex II to Directive 2011/65/EU.

Signed for and on behalf of
SGS-CSTC Standards Technical Services Co., Ltd. Guangzhou Branch

Dongyu Xie

Dongyu Xie
Approved Signatory



Test Report

No. CANEC2017668201

Date: 16 Oct 2020

Page 2 of 6

Test Results :

Test Part Description :

Specimen No.	SGS Sample ID	Description
SN1	CAN20-176682.001	Brassy metal

Remarks :

- (1) 1 mg/kg = 0.0001%
- (2) MDL = Method Detection Limit
- (3) ND = Not Detected (< MDL)
- (4) "-" = Not Regulated

RoHS Directive (EU) 2015/863 amending Annex II to Directive 2011/65/EU

Test Method : With reference to IEC 62321-4:2013+A1:2017, IEC 62321-5:2013, IEC 62321-7-1:2015 , IEC 62321-6:2015 and IEC 62321-8:2017, analyzed by ICP-OES , UV-Vis and GC-MS .

<u>Test Item(s)</u>	<u>Limit</u>	<u>Unit</u>	<u>MDL</u>	<u>001</u>
Cadmium (Cd)	100	mg/kg	2	ND
Lead (Pb)	1,000	mg/kg	2	7
Mercury (Hg)	1,000	mg/kg	2	ND
Hexavalent Chromium (Cr(VI))▼	-	µg/cm ²	0.10	ND
Sum of PBBs	1,000	mg/kg	-	ND
Monobromobiphenyl	-	mg/kg	5	ND
Dibromobiphenyl	-	mg/kg	5	ND
Tribromobiphenyl	-	mg/kg	5	ND
Tetrabromobiphenyl	-	mg/kg	5	ND
Pentabromobiphenyl	-	mg/kg	5	ND
Hexabromobiphenyl	-	mg/kg	5	ND
Heptabromobiphenyl	-	mg/kg	5	ND
Octabromobiphenyl	-	mg/kg	5	ND
Nonabromobiphenyl	-	mg/kg	5	ND
Decabromobiphenyl	-	mg/kg	5	ND
Sum of PBDEs	1,000	mg/kg	-	ND
Monobromodiphenyl ether	-	mg/kg	5	ND
Dibromodiphenyl ether	-	mg/kg	5	ND
Tribromodiphenyl ether	-	mg/kg	5	ND
Tetrabromodiphenyl ether	-	mg/kg	5	ND
Pentabromodiphenyl ether	-	mg/kg	5	ND



Unless otherwise agreed in writing, this document is issued by the Company subject to its General Conditions of Service printed overleaf, available on request or accessible at <http://www.sgs.com/en/Terms-and-Conditions.aspx> and, for electronic format documents, subject to Terms and Conditions for Electronic Documents at <http://www.sgs.com/en/Terms-and-Conditions/Terms-e-Document.aspx>. Attention is drawn to the limitation of liability, indemnification and jurisdiction issues defined therein. Any holder of this document is advised that information contained hereon reflects the Company's findings at the time of its intervention only and within the limits of Client's instructions, if any. The Company's sole responsibility is to its Client and this document does not exonerate parties to a transaction from exercising all their rights and obligations under the transaction documents. This document cannot be reproduced except in full, without prior written approval of the Company. Any unauthorized alteration, forgery or falsification of the content or appearance of this document is unlawful and offenders may be prosecuted to the fullest extent of the law. Unless otherwise stated the results shown in this test report refer only to the sample(s) tested.

Attention: To check the authenticity of testing /inspection report & certificate, please contact us at telephone: (86-755) 8307 1443, or email: CN.Doccheck@sgs.com

Test Report

No. CANEC2017668201

Date: 16 Oct 2020

Page 3 of 6

<u>Test Item(s)</u>	<u>Limit</u>	<u>Unit</u>	<u>MDL</u>	<u>001</u>
Hexabromodiphenyl ether	-	mg/kg	5	ND
Heptabromodiphenyl ether	-	mg/kg	5	ND
Octabromodiphenyl ether	-	mg/kg	5	ND
Nonabromodiphenyl ether	-	mg/kg	5	ND
Decabromodiphenyl ether	-	mg/kg	5	ND
Dibutyl phthalate (DBP)	1000	mg/kg	50	ND
Butyl benzyl phthalate (BBP)	1000	mg/kg	50	ND
Bis (2-ethylhexyl) phthalate (DEHP)	1000	mg/kg	50	ND
Diisobutyl Phthalates (DIBP)	1000	mg/kg	50	ND

Notes :

- (1) The maximum permissible limit is quoted from RoHS Directive (EU) 2015/863.IEC 62321 series is equivalent to EN 62321 series
https://www.cenelec.eu/dyn/www/f?p=104:30:1742232870351101:::FSP_ORG_ID,FSP_LANG_ID:1258637,25
- (2) ▽= a. The sample is positive for CrVI if the CrVI concentration is greater than 0.13 µg/cm². The sample coating is considered to contain CrVI
 b. The sample is negative for CrVI if CrVI is ND (concentration less than 0.10 µg/cm²). The coating is considered a non-CrVI based coating
 c. The result between 0.10 µg/cm² and 0.13 µg/cm² is considered to be inconclusive - unavoidable coating variations may influence the determination
 Information on storage conditions and production date of the tested sample is unavailable and thus Cr(VI) results represent status of the sample at the time of testing.



ATTACHMENTS

Pb/Cd/Hg/Cr⁶⁺/PBBs/PBDEs Testing Flow Chart

1) These samples were dissolved totally by pre -conditioning method according to below flow chart. (Cr⁶⁺ and PBBs/PBDEs test method excluded).

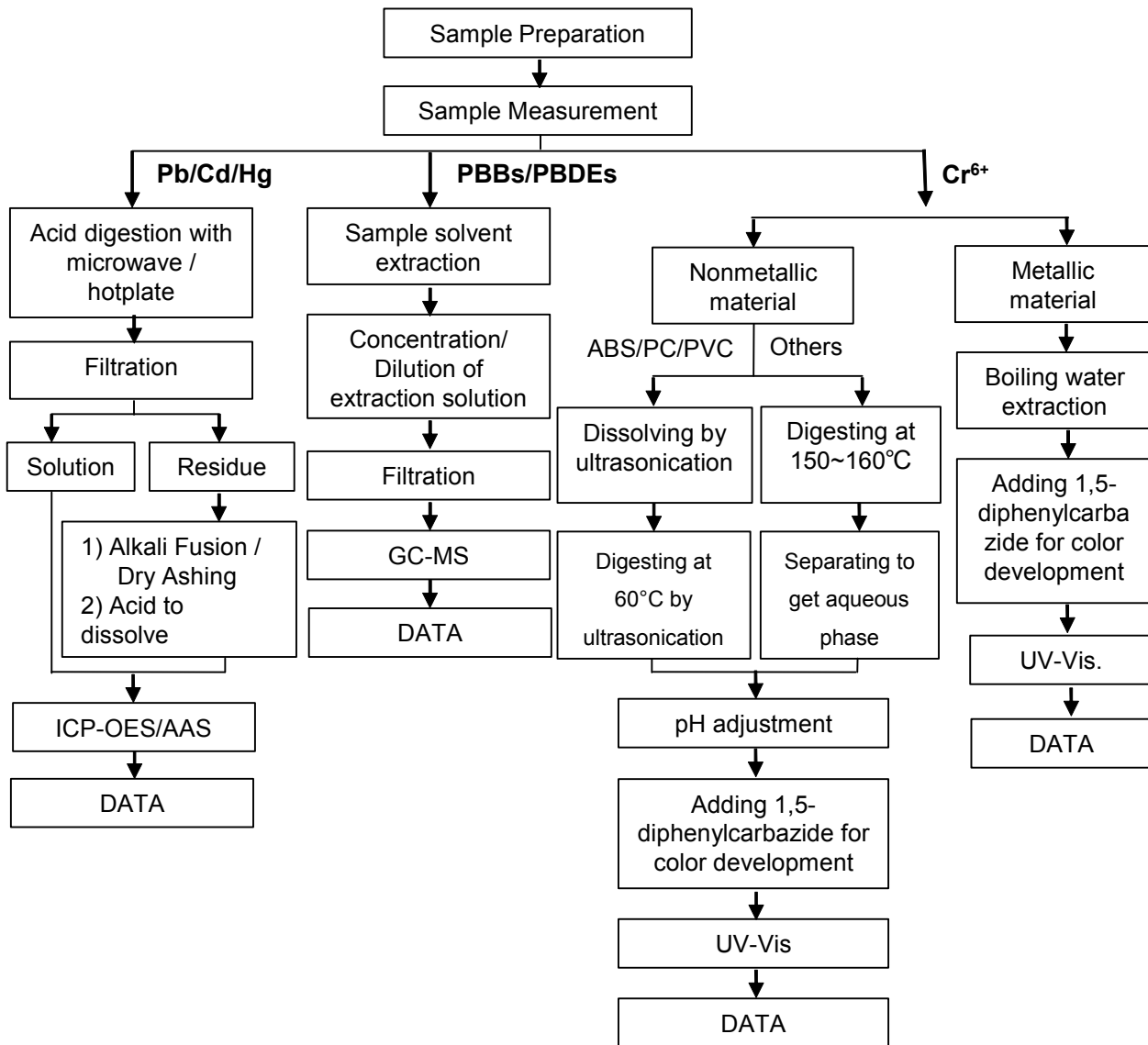

ATTACHMENTS

Phthalates Testing Flow Chart

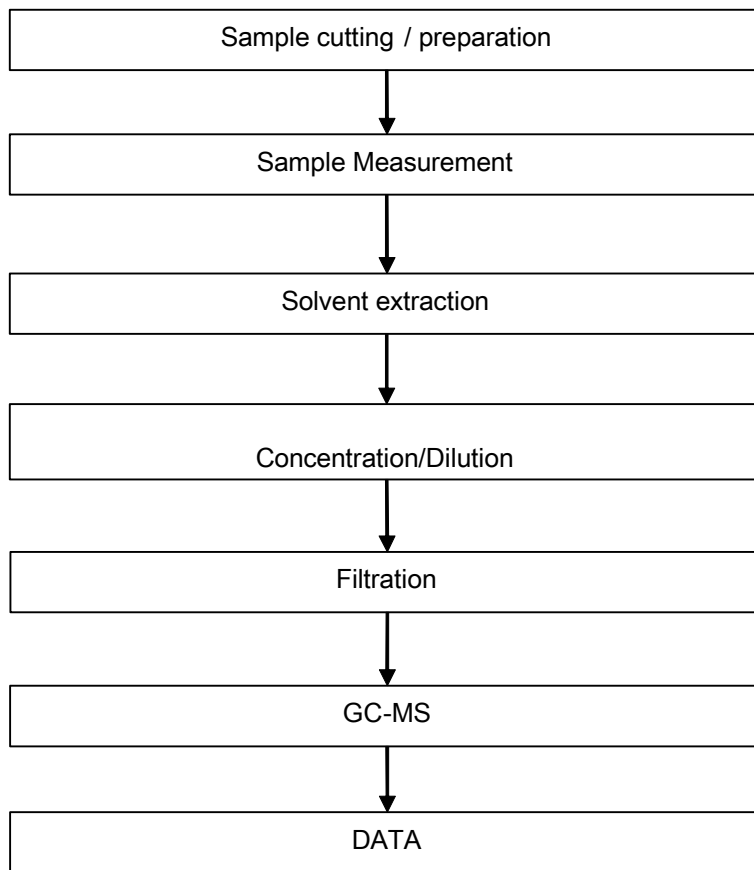

Sample photo:



SGS authenticate the photo on original report only

*** End of Report ***

Test Report

No. CANEC2001879301

Date: 09 Mar 2020

Page 1 of 7

DONGGUAN SALIPT CO.,LTD

SALIPT SCIENCE PARK,JINGXIANG INDUSTRY DIST,LIAOBU,DONGGUAN CITY,GUANGDONG PROVINCE CHINA

The following sample(s) was/were submitted and identified on behalf of the clients as : HEAT SHRINKABLE TUBING (WH)

SGS Job No. : CP20-004523 - SZ
Model No. : S-901-600
Client Ref. Info. : S-901-300
Buyer : Midea and other customers
Manufacturer : SALIPT
Date of Sample Received : 28 Feb 2020
Testing Period : 28 Feb 2020 - 09 Mar 2020
Test Requested : Selected test(s) as requested by client.
Test Method : Please refer to next page(s).
Test Results : Please refer to next page(s).
Conclusion : Based on the performed tests on submitted sample(s), the results of Lead, Mercury, Cadmium, Hexavalent chromium, Polybrominated biphenyls (PBBs), Polybrominated diphenyl ethers (PBDEs) and Phthalates such as Bis(2-ethylhexyl) phthalate (DEHP) , Butyl benzyl phthalate (BBP), Dibutyl phthalate (DBP) , and Diisobutyl phthalate (DIBP) comply with the limits as set by RoHS Directive (EU) 2015/863 amending Annex II to Directive 2011/65/EU.

Signed for and on behalf of
SGS-CSTC Standards Technical Services Co., Ltd. Guangzhou Branch

Jessie Li

Jessie Li
Approved Signatory



Test Report

No. CANEC2001879301

Date: 09 Mar 2020

Page 2 of 7

Test Results :

Test Part Description :

Specimen No.	SGS Sample ID	Description
SN1	CAN20-018793.001	White tube

Remarks :

- (1) 1 mg/kg = 1 ppm = 0.0001%
- (2) MDL = Method Detection Limit
- (3) ND = Not Detected (< MDL)
- (4) "-" = Not Regulated

RoHS Directive (EU) 2015/863 amending Annex II to Directive 2011/65/EU

Test Method : With reference to IEC 62321-4:2013+A1:2017, IEC 62321-5:2013, IEC 62321-7-2:2017 , IEC 62321-6:2015 and IEC 62321-8:2017, analyzed by ICP-OES , UV-Vis and GC-MS .

<u>Test Item(s)</u>	<u>Limit</u>	<u>Unit</u>	<u>MDL</u>	<u>001</u>
Cadmium (Cd)	100	mg/kg	2	ND
Lead (Pb)	1,000	mg/kg	2	ND
Mercury (Hg)	1,000	mg/kg	2	ND
Hexavalent Chromium (CrVI)	1,000	mg/kg	8	ND
Sum of PBBs	1,000	mg/kg	-	ND
Monobromobiphenyl	-	mg/kg	5	ND
Dibromobiphenyl	-	mg/kg	5	ND
Tribromobiphenyl	-	mg/kg	5	ND
Tetrabromobiphenyl	-	mg/kg	5	ND
Pentabromobiphenyl	-	mg/kg	5	ND
Hexabromobiphenyl	-	mg/kg	5	ND
Heptabromobiphenyl	-	mg/kg	5	ND
Octabromobiphenyl	-	mg/kg	5	ND
Nonabromobiphenyl	-	mg/kg	5	ND
Decabromobiphenyl	-	mg/kg	5	ND
Sum of PBDEs	1,000	mg/kg	-	ND
Monobromodiphenyl ether	-	mg/kg	5	ND
Dibromodiphenyl ether	-	mg/kg	5	ND
Tribromodiphenyl ether	-	mg/kg	5	ND
Tetrabromodiphenyl ether	-	mg/kg	5	ND
Pentabromodiphenyl ether	-	mg/kg	5	ND



Unless otherwise agreed in writing, this document is issued by the Company subject to its General Conditions of Service printed overleaf, available on request or accessible at <http://www.sgs.com/en/Terms-and-Conditions.aspx> and, for electronic format documents, subject to Terms and Conditions for Electronic Documents at <http://www.sgs.com/en/Terms-and-Conditions/Terms-e-Documents.aspx>. Attention is drawn to the limitation of liability, indemnification and jurisdiction issues defined therein. Any holder of this document is advised that information contained hereon reflects the Company's findings at the time of its intervention only and within the limits of Client's instructions, if any. The Company's sole responsibility is to its Client and this document does not exonerate parties to a transaction from exercising all their rights and obligations under the transaction documents. This document cannot be reproduced except in full, without prior written approval of the Company. Any unauthorized alteration, forgery or falsification of the content or appearance of this document is unlawful and offenders may be prosecuted to the fullest extent of the law. Unless otherwise stated the results shown in this test report refer only to the sample(s) tested.

Attention: To check the authenticity of testing /inspection report & certificate, please contact us at telephone: (86-755) 8307 1443, or email: CN.Doccheck@sgs.com

Test Report

No. CANEC2001879301

Date: 09 Mar 2020

Page 3 of 7

<u>Test Item(s)</u>	<u>Limit</u>	<u>Unit</u>	<u>MDL</u>	<u>001</u>
Hexabromodiphenyl ether	-	mg/kg	5	ND
Heptabromodiphenyl ether	-	mg/kg	5	ND
Octabromodiphenyl ether	-	mg/kg	5	ND
Nonabromodiphenyl ether	-	mg/kg	5	ND
Decabromodiphenyl ether	-	mg/kg	5	ND
Dibutyl phthalate (DBP)	1000	mg/kg	50	ND
Butyl benzyl phthalate (BBP)	1000	mg/kg	50	ND
Bis (2-ethylhexyl) phthalate (DEHP)	1000	mg/kg	50	ND
Diisobutyl Phthalates (DIBP)	1000	mg/kg	50	ND

Notes :

(1) The maximum permissible limit is quoted from RoHS Directive (EU) 2015/863.

IEC 62321 series is equivalent to EN 62321 series

https://www.cenelec.eu/dyn/www/f?p=104:30:1742232870351101:::FSP_ORG_ID,FSP_LANG_ID:1258637,25

(2) The restriction of DEHP, BBP, DBP and DIBP shall apply to medical devices, including in vitro medical devices, and monitoring and control instruments, including industrial monitoring and control instruments, from 22 July 2021.

(3) The restriction of DEHP, BBP, DBP and DIBP shall not apply to toys which are already subject to the restriction of DEHP, BBP, DBP and DIBP through entry 51 of Annex XVII to Regulation (EC) No 1907/2006.

Halogen

Test Method : With reference to EN 14582:2016, analysis was performed by IC.

<u>Test Item(s)</u>	<u>Unit</u>	<u>MDL</u>	<u>001</u>
Fluorine (F)	mg/kg	50	ND
Chlorine (Cl)	mg/kg	50	ND
Bromine (Br)	mg/kg	50	ND
Iodine (I)	mg/kg	50	ND



ATTACHMENTS

Pb/Cd/Hg/Cr⁶⁺/PBBs/PBDEs Testing Flow Chart

1) These samples were dissolved totally by pre-conditioning method according to below flow chart. (Cr⁶⁺ and PBBs/PBDEs test method excluded).

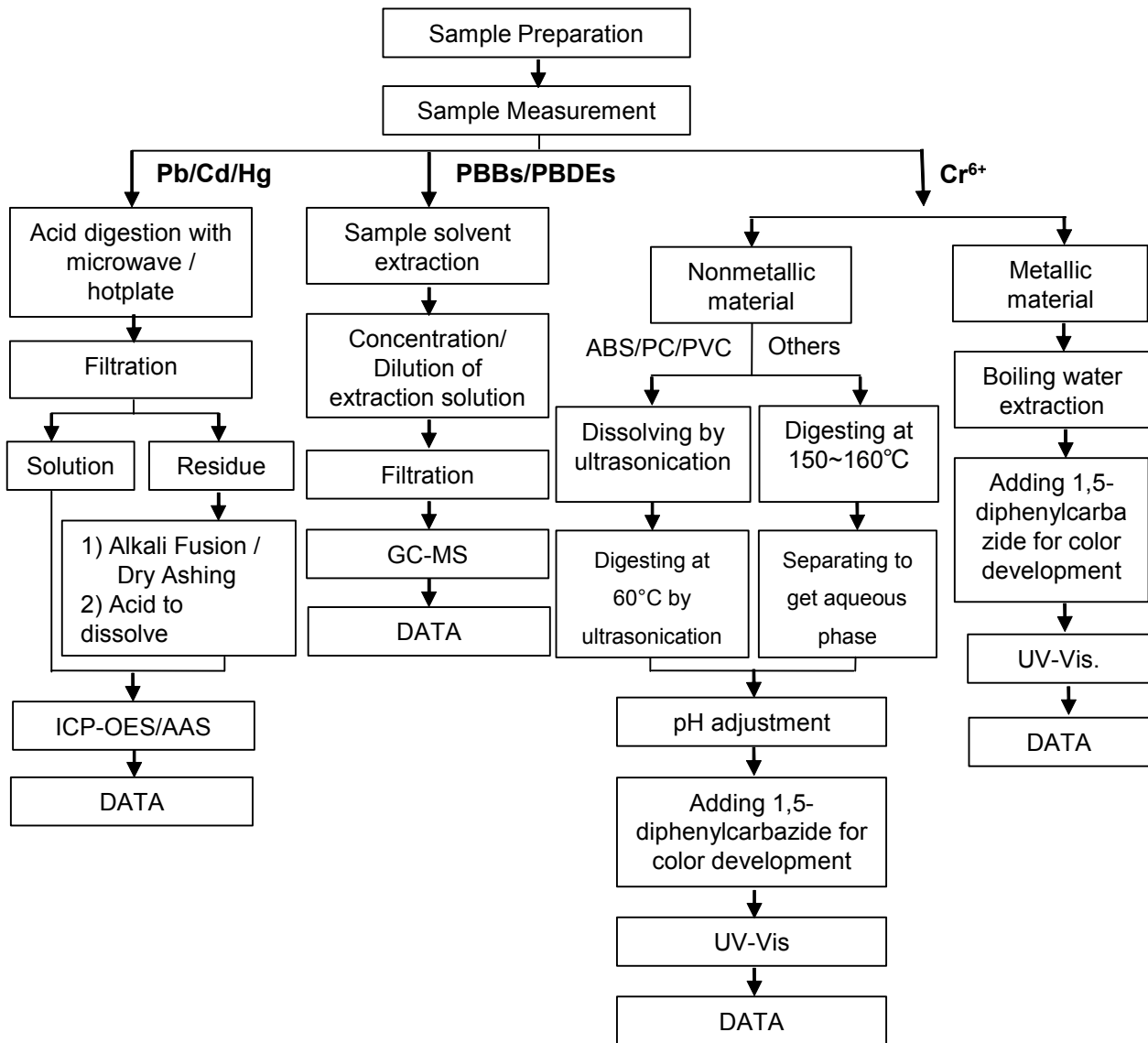

Unless otherwise agreed in writing, this document is issued by the Company subject to its General Conditions of Service printed overleaf, available on request or accessible at <http://www.sgs.com/en/Terms-and-Conditions.aspx> and, for electronic format documents, subject to Terms and Conditions for Electronic Documents at <http://www.sgs.com/en/Terms-and-Conditions/Terms-e-Documents.aspx>. Attention is drawn to the limitation of liability, indemnification and jurisdiction issues defined therein. Any holder of this document is advised that information contained hereon reflects the Company's findings at the time of its intervention only and within the limits of Client's instructions, if any. The Company's sole responsibility is to its Client and this document does not exonerate parties to a transaction from exercising all their rights and obligations under the transaction documents. This document cannot be reproduced except in full, without prior written approval of the Company. Any unauthorized alteration, forgery or falsification of the content or appearance of this document is unlawful and offenders may be prosecuted to the fullest extent of the law. Unless otherwise stated the results shown in this test report refer only to the sample(s) tested.

Attention: To check the authenticity of testing /inspection report & certificate, please contact us at telephone: (86-755) 8307 1443, or email: CN.Doccheck@sgs.com

ATTACHMENTS

Phthalates Testing Flow Chart

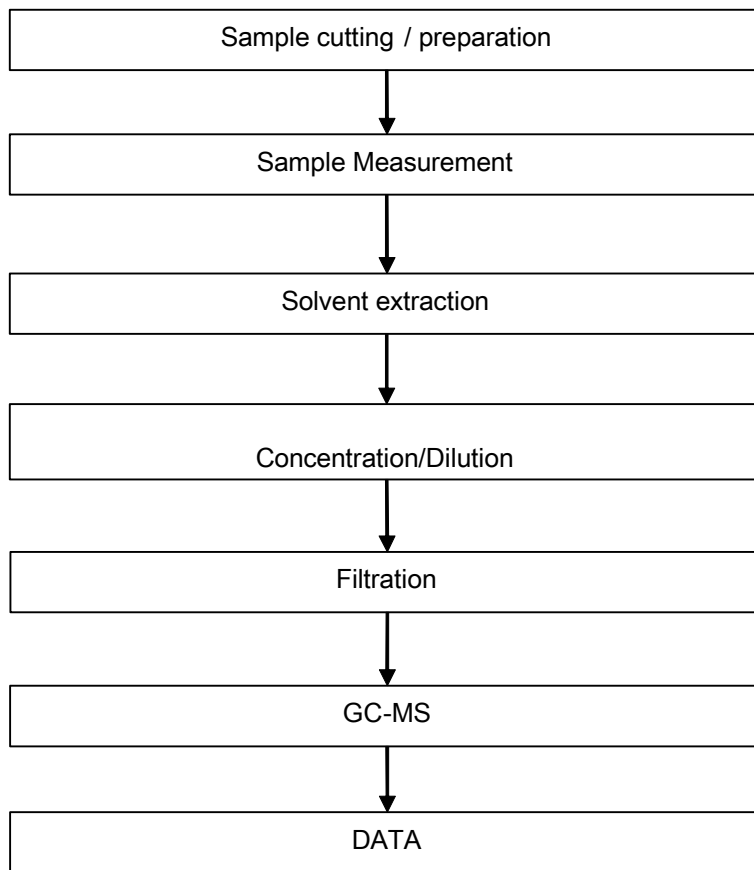

ATTACHMENTS

Halogen Testing Flow Chart

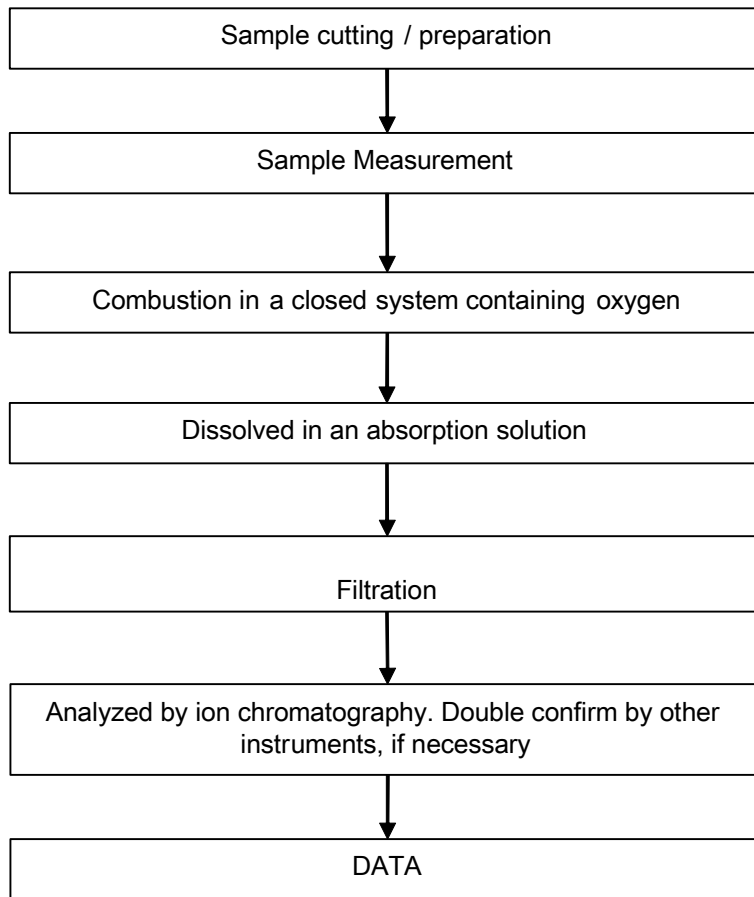

Unless otherwise agreed in writing, this document is issued by the Company subject to its General Conditions of Service printed overleaf, available on request or accessible at <http://www.sgs.com/en/Terms-and-Conditions.aspx> and, for electronic format documents, subject to Terms and Conditions for Electronic Documents at <http://www.sgs.com/en/Terms-and-Conditions/Terms-e-Document.aspx>. Attention is drawn to the limitation of liability, indemnification and jurisdiction issues defined therein. Any holder of this document is advised that information contained hereon reflects the Company's findings at the time of its intervention only and within the limits of Client's instructions, if any. The Company's sole responsibility is to its Client and this document does not exonerate parties to a transaction from exercising all their rights and obligations under the transaction documents. This document cannot be reproduced except in full, without prior written approval of the Company. Any unauthorized alteration, forgery or falsification of the content or appearance of this document is unlawful and offenders may be prosecuted to the fullest extent of the law. Unless otherwise stated the results shown in this test report refer only to the sample(s) tested.

Attention: To check the authenticity of testing /inspection report & certificate, please contact us at telephone: (86-755) 8307 1443, or email: CN.Doccheck@sgs.com

Sample photo:



SGS authenticate the photo on original report only

*** End of Report ***



Test Report

No. CANEC2001834614

Date: 28 Feb 2020

Page 1 of 6

HUI ZHOU CITY FAN-ZHONG-BAO RUBBER&PLASTIC FOAM FACTORY CO.,LTD.
XINTANG INDUSTRIAL ZONE,QIU-BAO ROAD,QIU-CHANG TOWN,HUIYANG
DISTRICT,HUIZHOU,GUANGDONG PROVINCE

The following sample(s) was/were submitted and identified on behalf of the clients as : Environmental protection
EVA foam rubber

SGS Job No. : CP20-004394 - SZ
Date of Sample Received : 31 Dec 2019
Testing Period : 31 Dec 2019 - 08 Jan 2020
Test Requested : Selected test(s) as requested by client.
Test Method : Please refer to next page(s).
Test Results : Please refer to next page(s).
Conclusion : Based on the performed tests on submitted sample(s), the results of Lead, Mercury, Cadmium, Hexavalent chromium, Polybrominated biphenyls (PBBs), Polybrominated diphenyl ethers (PBDEs) and Phthalates such as Bis(2-ethylhexyl) phthalate (DEHP) , Butyl benzyl phthalate (BBP), Dibutyl phthalate (DBP) , and Diisobutyl phthalate (DIBP) comply with the limits as set by RoHS Directive (EU) 2015/863 amending Annex II to Directive 2011/65/EU.

Signed for and on behalf of
SGS-CSTC Standards Technical Services Co., Ltd. Guangzhou Branch

Zm guan
Approved Signatory



Test Results :

Test Part Description :

Specimen No.	SGS Sample ID	Description
SN1	CAN20-018346.003	Black material

Remarks :

- (1) 1 mg/kg = 1 ppm = 0.0001%
- (2) MDL = Method Detection Limit
- (3) ND = Not Detected (< MDL)
- (4) "-" = Not Regulated

RoHS Directive (EU) 2015/863 amending Annex II to Directive 2011/65/EU

Test Method : With reference to IEC 62321-4:2013+A1:2017, IEC 62321-5:2013, IEC 62321-7-2:2017 , IEC 62321-6:2015 and IEC 62321-8:2017, analyzed by ICP-OES , UV-Vis and GC-MS .

<u>Test Item(s)</u>	<u>Limit</u>	<u>Unit</u>	<u>MDL</u>	<u>003</u>
Cadmium (Cd)	100	mg/kg	2	ND
Lead (Pb)	1,000	mg/kg	2	33
Mercury (Hg)	1,000	mg/kg	2	ND
Hexavalent Chromium (CrVI)	1,000	mg/kg	8	ND
Sum of PBBs	1,000	mg/kg	-	ND
Monobromobiphenyl	-	mg/kg	5	ND
Dibromobiphenyl	-	mg/kg	5	ND
Tribromobiphenyl	-	mg/kg	5	ND
Tetrabromobiphenyl	-	mg/kg	5	ND
Pentabromobiphenyl	-	mg/kg	5	ND
Hexabromobiphenyl	-	mg/kg	5	ND
Heptabromobiphenyl	-	mg/kg	5	ND
Octabromobiphenyl	-	mg/kg	5	ND
Nonabromobiphenyl	-	mg/kg	5	ND
Decabromobiphenyl	-	mg/kg	5	ND
Sum of PBDEs	1,000	mg/kg	-	ND
Monobromodiphenyl ether	-	mg/kg	5	ND
Dibromodiphenyl ether	-	mg/kg	5	ND
Tribromodiphenyl ether	-	mg/kg	5	ND
Tetrabromodiphenyl ether	-	mg/kg	5	ND
Pentabromodiphenyl ether	-	mg/kg	5	ND



Unless otherwise agreed in writing, this document is issued by the Company subject to its General Conditions of Service printed overleaf, available on request or accessible at <http://www.sgs.com/en/Terms-and-Conditions.aspx> and, for electronic format documents, subject to Terms and Conditions for Electronic Documents at <http://www.sgs.com/en/Terms-and-Conditions/Terms-e-Documents.aspx>. Attention is drawn to the limitation of liability, indemnification and jurisdiction issues defined therein. Any holder of this document is advised that information contained hereon reflects the Company's findings at the time of its intervention only and within the limits of Client's instructions, if any. The Company's sole responsibility is to its Client and this document does not exonerate parties to a transaction from exercising all their rights and obligations under the transaction documents. This document cannot be reproduced except in full, without prior written approval of the Company. Any unauthorized alteration, forgery or falsification of the content or appearance of this document is unlawful and offenders may be prosecuted to the fullest extent of the law. Unless otherwise stated the results shown in this test report refer only to the sample(s) tested.

Attention: To check the authenticity of testing /inspection report & certificate, please contact us at telephone: (86-755) 8307 1443, or email: CN.Doccheck@sgs.com

Test Report

No. CANEC2001834614

Date: 28 Feb 2020

Page 3 of 6

<u>Test Item(s)</u>	<u>Limit</u>	<u>Unit</u>	<u>MDL</u>	<u>003</u>
Hexabromodiphenyl ether	-	mg/kg	5	ND
Heptabromodiphenyl ether	-	mg/kg	5	ND
Octabromodiphenyl ether	-	mg/kg	5	ND
Nonabromodiphenyl ether	-	mg/kg	5	ND
Decabromodiphenyl ether	-	mg/kg	5	ND
Dibutyl phthalate (DBP)	1,000	mg/kg	50	ND
Butyl benzyl phthalate (BBP)	1,000	mg/kg	50	ND
Bis (2-ethylhexyl) phthalate (DEHP)	1,000	mg/kg	50	ND
Diisobutyl Phthalates (DIBP)	1,000	mg/kg	50	ND

Notes :

- (1) The maximum permissible limit is quoted from RoHS Directive (EU) 2015/863.IEC 62321 series is equivalent to EN 62321 series
https://www.cenelec.eu/dyn/www/f?p=104:30:1742232870351101:::FSP_ORG_ID,FSP_LANG_ID:1258637,25
- (2) The restriction of DEHP, BBP, DBP and DIBP shall apply to medical devices, including in vitro medical devices, and monitoring and control instruments, including industrial monitoring and control instruments, from 22 July 2021.
- (3) The restriction of DEHP, BBP, DBP and DIBP shall not apply to toys which are already subject to the restriction of DEHP, BBP, DBP and DIBP through entry 51 of Annex XVII to Regulation (EC) No 1907/2006.

Remark: Results & photo(s) of this report refer to test report CANEC1926211117.



Unless otherwise agreed in writing, this document is issued by the Company subject to its General Conditions of Service printed overleaf, available on request or accessible at <http://www.sgs.com/en/Terms-and-Conditions.aspx> and, for electronic format documents, subject to Terms and Conditions for Electronic Documents at <http://www.sgs.com/en/Terms-and-Conditions/Terms-e-Documents.aspx>. Attention is drawn to the limitation of liability, indemnification and jurisdiction issues defined therein. Any holder of this document is advised that information contained hereon reflects the Company's findings at the time of its intervention only and within the limits of Client's instructions, if any. The Company's sole responsibility is to its Client and this document does not exonerate parties to a transaction from exercising all their rights and obligations under the transaction documents. This document cannot be reproduced except in full, without prior written approval of the Company. Any unauthorized alteration, forgery or falsification of the content or appearance of this document is unlawful and offenders may be prosecuted to the fullest extent of the law. Unless otherwise stated the results shown in this test report refer only to the sample(s) tested.

Attention: To check the authenticity of testing /inspection report & certificate, please contact us at telephone: (86-755) 8307 1443, or email: CN.Doccheck@sgs.com

ATTACHMENTS

Pb/Cd/Hg/Cr⁶⁺/PBBs/PBDEs Testing Flow Chart

1) These samples were dissolved totally by pre-conditioning method according to below flow chart. (Cr⁶⁺ and PBBs/PBDEs test method excluded).

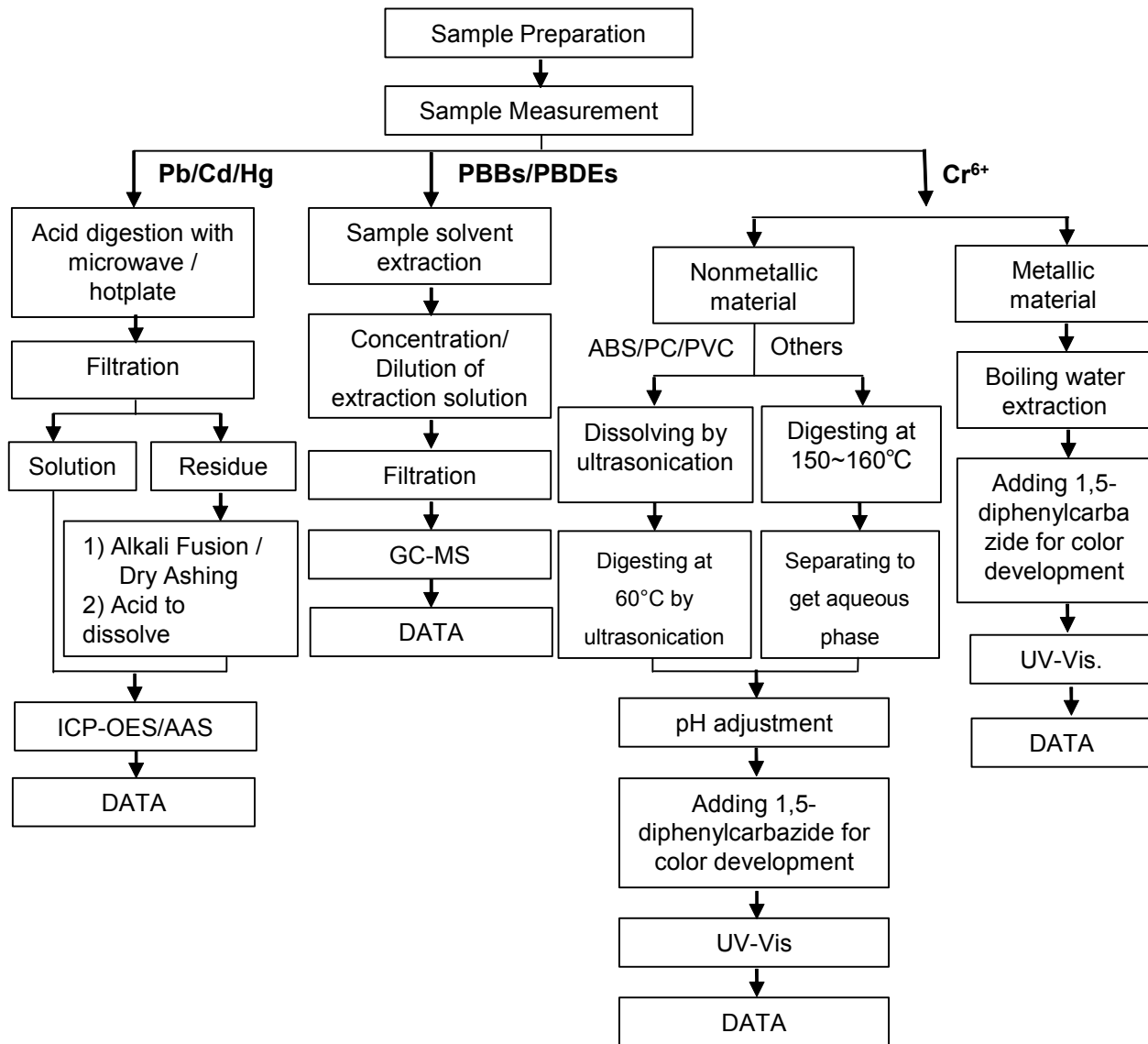

ATTACHMENTS

Phthalates Testing Flow Chart

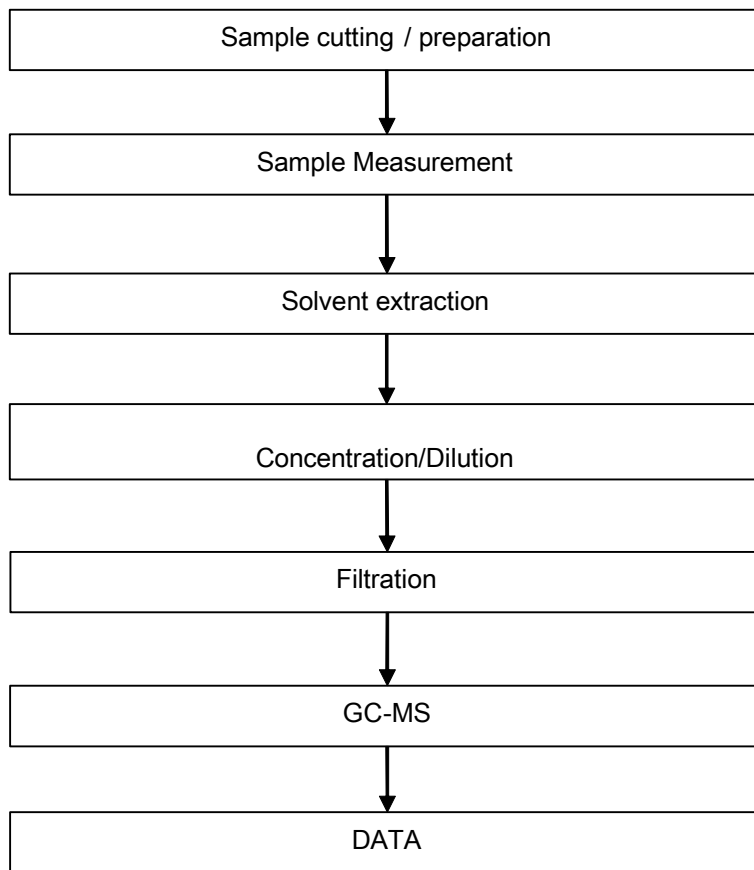

Unless otherwise agreed in writing, this document is issued by the Company subject to its General Conditions of Service printed overleaf, available on request or accessible at <http://www.sgs.com/en/Terms-and-Conditions.aspx> and, for electronic format documents, subject to Terms and Conditions for Electronic Documents at <http://www.sgs.com/en/Terms-and-Conditions/Terms-e-Document.aspx>. Attention is drawn to the limitation of liability, indemnification and jurisdiction issues defined therein. Any holder of this document is advised that information contained hereon reflects the Company's findings at the time of its intervention only and within the limits of Client's instructions, if any. The Company's sole responsibility is to its Client and this document does not exonerate parties to a transaction from exercising all their rights and obligations under the transaction documents. This document cannot be reproduced except in full, without prior written approval of the Company. Any unauthorized alteration, forgery or falsification of the content or appearance of this document is unlawful and offenders may be prosecuted to the fullest extent of the law. Unless otherwise stated the results shown in this test report refer only to the sample(s) tested.

Attention: To check the authenticity of testing /inspection report & certificate, please contact us at telephone: (86-755) 8307 1443, or email: CN.Doccheck@sgs.com

Sample photo:



SGS authenticate the photo on original report only

*** End of Report ***



Unless otherwise agreed in writing, this document is issued by the Company subject to its General Conditions of Service printed overleaf, available on request or accessible at <http://www.sgs.com/en/Terms-and-Conditions.aspx> and, for electronic format documents, subject to Terms and Conditions for Electronic Documents at <http://www.sgs.com/en/Terms-and-Conditions/Terms-e-Documents.aspx>. Attention is drawn to the limitation of liability, indemnification and jurisdiction issues defined therein. Any holder of this document is advised that information contained hereon reflects the Company's findings at the time of its intervention only and within the limits of Client's instructions, if any. The Company's sole responsibility is to its Client and this document does not exonerate parties to a transaction from exercising all their rights and obligations under the transaction documents. This document cannot be reproduced except in full, without prior written approval of the Company. Any unauthorized alteration, forgery or falsification of the content or appearance of this document is unlawful and offenders may be prosecuted to the fullest extent of the law. Unless otherwise stated the results shown in this test report refer only to the sample(s) tested.

Attention: To check the authenticity of testing /inspection report & certificate, please contact us at telephone: (86-755) 8307 1443, or email: CN.Doccheck@sgs.com



中国认可
检测
TESTING
CNAS L4305

测试报告

No. NGBML2000312802

日期: 2020年01月22日 第1页,共14页

浙江巨化股份有限公司
浙江省衢州市柯城区巨化

以下测试之样品是由申请者所提供及确认: 聚全氟乙丙烯树脂

SGS工作编号: NBIN2001000750PC - NB
 样品接收日期: 2020年01月19日
 测试周期: 2020年01月19日 - 2020年01月22日
 测试要求: 根据客户要求测试
 测试方法: 请参见下一页
 测试结果: 请参见下一页
 结论: 基于所送样品进行的测试, 镉、铅、汞、六价铬、多溴联苯(PBBs)、多溴二苯醚(PBDEs)、邻苯二甲酸酯(如邻苯二甲酸二丁酯(DBP)、邻苯二甲酸丁苯酯(BBP)、邻苯二甲酸二(2-乙基己基)酯(DEHP)和邻苯二甲酸二异丁酯(DIBP))的测试结果符合欧盟RoHS指令2011/65/EU附录II的修正指令(EU) 2015/863的限值要求。

通标标准技术服务有限公司宁波分公司
授权签名

肖玲艳

Iris Xiao 肖玲艳
批准签署人

扫码查看在线报告



NGBML2000312802



SGS-CSTC Inspection & Testing Services Co., Ltd.
Ningbo Branch Chemical Laboratory

Unless otherwise agreed in writing, this document is issued by the Company subject to its General Conditions of Service printed overleaf, available on request or accessible at <http://www.sgs.com/en/Terms-and-Conditions.aspx> and, for electronic format documents, subject to Terms and Conditions for Electronic Documents at <http://www.sgs.com/en/Terms-and-Conditions/Terms-e-Documents.aspx>. Attention is drawn to the limitation of liability, indemnification and jurisdiction issues defined therein. Any holder of this document is advised that information contained hereon reflects the Company's findings at the time of its intervention only and within the limits of Client's instructions, if any. The Company's sole responsibility is to its Client and this document does not exonerate parties to a transaction from exercising all their rights and obligations under the transaction documents. This document cannot be reproduced except in full, without prior written approval of the Company. Any unauthorized alteration, forgery or falsification of the content or appearance of this document is unlawful and offenders may be prosecuted to the fullest extent of the law. Unless otherwise stated the results shown in this test report refer only to the sample(s) tested.

Attention: To check the authenticity of testing / inspection report & certificate, please contact us at telephone: (86-755) 8307 1443, or email: CN.Doccheck@sgs.com

15/F West of Building 4, Lingun Industry Park, No.1177 Lingun Road, Ningbo National Hi-Tech Zone, Ningbo, Zhejiang, China 315040 t E&E (86-574)89070249 www.sgsgroup.com.cn
 中国·浙江·宁波市国家高新区凌云路1177号凌云产业园4号楼西1-5层 邮编: 315040 t HL (86-574)89070271 t ML (86-574)89070242 e sgs.china@sgs.com

测试报告

No. NGBML2000312802

日期: 2020年01月22日 第2页,共14页

测试结果:

测试样品描述:

样品编号	SGS样品ID	描述
SN1	NGB20-003128.001	透明固体颗粒

备注:

- (1) 1 mg/kg = 0.0001%
- (2) MDL = 方法检测限
- (3) ND = 未检出 (< MDL)
- (4) "-" = 未规定

RoHS 指令2011/65/EU附录II的修正指令(EU) 2015/863

测试方法: 参考IEC 62321-4:2013+A1:2017, IEC 62321-5:2013, IEC 62321-7-2:2017, IEC 62321-6:2015和IEC 62321-8:2017, 采用ICP-OES,UV-Vis和GC-MS进行分析.

测试项目	限值	单位	MDL	001
镉(Cd)	100	mg/kg	2	ND
铅(Pb)	1000	mg/kg	2	ND
汞(Hg)	1000	mg/kg	2	ND
六价铬 (Cr(VI))	1000	mg/kg	8	ND
多溴联苯(PBBs)之和	1000	mg/kg	-	ND
一溴联苯	-	mg/kg	5	ND
二溴联苯	-	mg/kg	5	ND
三溴联苯	-	mg/kg	5	ND
四溴联苯	-	mg/kg	5	ND
五溴联苯	-	mg/kg	5	ND
六溴联苯	-	mg/kg	5	ND
七溴联苯	-	mg/kg	5	ND
八溴联苯	-	mg/kg	5	ND
九溴联苯	-	mg/kg	5	ND
十溴联苯	-	mg/kg	5	ND
多溴二苯醚之和(PBDEs)	1000	mg/kg	-	ND
一溴二苯醚	-	mg/kg	5	ND
二溴二苯醚	-	mg/kg	5	ND
三溴二苯醚	-	mg/kg	5	ND
四溴二苯醚	-	mg/kg	5	ND



测试报告

No. NGBML2000312802

日期: 2020年01月22日 第3页,共14页

测试项目	限值	单位	MDL	001
五溴二苯醚	-	mg/kg	5	ND
六溴二苯醚	-	mg/kg	5	ND
七溴二苯醚	-	mg/kg	5	ND
八溴二苯醚	-	mg/kg	5	ND
九溴二苯醚	-	mg/kg	5	ND
十溴二苯醚	-	mg/kg	5	ND
邻苯二甲酸二丁酯 (DBP)	1000	mg/kg	50	ND
邻苯二甲酸丁苄酯(BBP)	1000	mg/kg	50	ND
邻苯二甲酸二(2-乙基己基)酯(DEHP)	1000	mg/kg	50	ND
邻苯二甲酸二异丁酯(DIBP)	1000	mg/kg	50	ND

备注:

(1) 最大允许极限值引用自RoHS指令(EU) 2015/863。

IEC 62321 系列等同于 EN 62321 系列

https://www.cenelec.eu/dyn/www/f?p=104:30:1742232870351101:::FSP_ORG_ID,FSP_LANG_ID:1258637,25

(2) 2021年7月22号开始, DEHP, BBP, DBP 和 DIBP的限制适用于医疗器械, 包括体外医疗器械, 监控仪表, 包括工业监测和控制仪器。

(3) DEHP, BBP, DBP 和 DIBP的限制不适用于玩具产品, 因为No.1907/2006附录XVII第51条已对玩具产品中的DEHP, BBP, DBP 和 DIBP含量进行了限制。

元素

测试方法: 参照US EPA 方法3052:1996测定, 采用ICP-OES进行分析。

测试项目	单位	MDL	001
红磷以磷计	mg/kg	20	ND

卤素

测试方法: 参照EN 14582: 2016方法 测定, 采用 IC进行分析。

测试项目	单位	MDL	001
氟 (F)	mg/kg	50	>100000
氯 (Cl)	mg/kg	200	ND
溴 (Br)	mg/kg	50	ND
碘 (I)	mg/kg	50	ND





中国认可
检测
TESTING
CNAS L4305

测试报告

No. NGBML2000312802

日期: 2020年01月22日 第4页,共14页

四溴双酚-A

测试方法: 参照 US EPA 3540C: 1996 方法测定, 采用GC-MS进行分析.

测试项目	单位	MDL	001
四溴双酚-A	mg/kg	10	ND

多环芳香烃(PAHs)

测试方法: 参考AfPS GS 2014:01 PAK 方法测试, 采用 GC-MS进行分析.

测试项目	单位	MDL	001
萘(ANY)	mg/kg	0.1	ND
芘(蔡嵌戊烷)(ANA)	mg/kg	0.1	ND
芴(FLU)	mg/kg	0.1	ND
菲(PHE)	mg/kg	0.1	ND
蒽(ANT)	mg/kg	0.1	ND
荧蒽(FLT)	mg/kg	0.1	ND
芘(PYR)	mg/kg	0.1	ND
苯并(a)芘 (BaP)	mg/kg	0.1	ND
苯并(e)芘(BeP)	mg/kg	0.1	ND
苯并(a)蒽(BaA)	mg/kg	0.1	ND
苯并(b)荧蒽(BbF)	mg/kg	0.1	ND
苯并(j)荧蒽(BjF)	mg/kg	0.1	ND
苯并(k)荧蒽(BkF)	mg/kg	0.1	ND
屈(CHR)	mg/kg	0.1	ND
二苯并(a,h)蒽(DBA)	mg/kg	0.1	ND
苯并(g,h,i)芘(二蔡嵌苯)(BPE)	mg/kg	0.1	ND
茚并(1,2,3-c,d)芘(IPY)	mg/kg	0.1	ND
7项多环芳香烃总和[萘(ANY), 芘(蔡嵌戊烷)(ANA), 芴(FLU), 菲(PHE), 芘(PYR), 蒽(ANT), 荧蒽(FLT)]	mg/kg	-	ND
蔡(NAP)	mg/kg	0.1	ND
18项多环芳香烃总和	mg/kg	-	ND



SGS-CSTC 检测技术服务有限公司宁波分公司
Inspection & Testing Services
Ningbo Branch

Unless otherwise agreed in writing, this document is issued by the Company subject to its General Conditions of Service printed overleaf, available on request or accessible at <http://www.sgs.com/en/Terms-and-Conditions.aspx> and, for electronic format documents, subject to Terms and Conditions for Electronic Documents at <http://www.sgs.com/en/Terms-and-Conditions/Terms-e-Documents.aspx>. Attention is drawn to the limitation of liability, indemnification and jurisdiction issues defined therein. Any holder of this document is advised that information contained hereon reflects the Company's findings at the time of its intervention only and within the limits of Client's instructions, if any. The Company's sole responsibility is to its Client and this document does not exonerate parties to a transaction from exercising all their rights and obligations under the transaction documents. This document cannot be reproduced except in full, without prior written approval of the Company. Any unauthorized alteration, forgery or falsification of the content or appearance of this document is unlawful and offenders may be prosecuted to the fullest extent of the law. Unless otherwise stated the results shown in this test report refer only to the sample(s) tested.

Attention: To check the authenticity of testing /inspection report & certificate, please contact us at telephone: (86-755) 8307 1443, or email: CN.Doccheck@sgs.com

15/F West of Building 4, Lingun Industry Park, No.1177 Lingun Road, Ningbo National Hi-Tech Zone, Ningbo, Zhejiang, China 315040 t E&E (86-574)89070249 www.sgsgroup.com.cn
中国·浙江·宁波市国家高新区凌云路1177号凌云产业园4号楼西1-5层 邮编: 315040 t HL (86-574)89070271 t ML (86-574)89070242 e sgs.china@sgs.com

测试报告

No. NGBML2000312802

日期: 2020年01月22日 第6页,共14页

测试项目	CAS NO.	单位	MDL	001
邻苯二甲酸二异壬酯 (DINP)	28553-12-0/ 68515-48-0	%	0.01	ND
邻苯二甲酸二正辛酯 (DNOP)	117-84-0	%	0.003	ND
邻苯二甲酸二异癸酯 (DIDP)	26761-40-0 /68515-49-1	%	0.01	ND

备注:

(1) DINP, DNOP, DIDP 参考信息: 1907/2006/EC Reach 附录XVII的修正指令——552/2009/EC 第52条 (前身为2005/84/EC) 的要求:

- i) 不允许DINP, DNOP, DIDP 质量浓度高于0.1%的可塑性物料用于可放入儿童口中的玩具和儿童护理品
- ii) 当可放入儿童口中的玩具和儿童护理品中的可塑性物料含DINP, DNOP, DIDP 质量浓度高于0.1%时, 不得投放市场。

详细信息请参见Regulation (EC) No 552/2009

除非另有说明, 此报告结果仅对测试的样品负责。本报告未经本公司书面许可, 不可部分复制。

检测报告仅用于客户科研、教学、内部质量控制、产品研发等目的, 仅供内部参考。



Pb /Cd / Hg 测试流程图

1)样品按照下述流程被完全消解

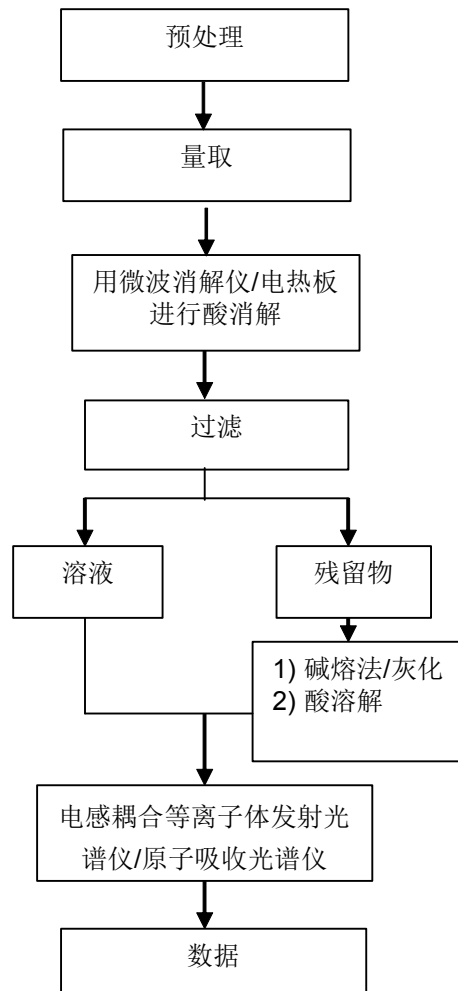

六价铬测试流程图

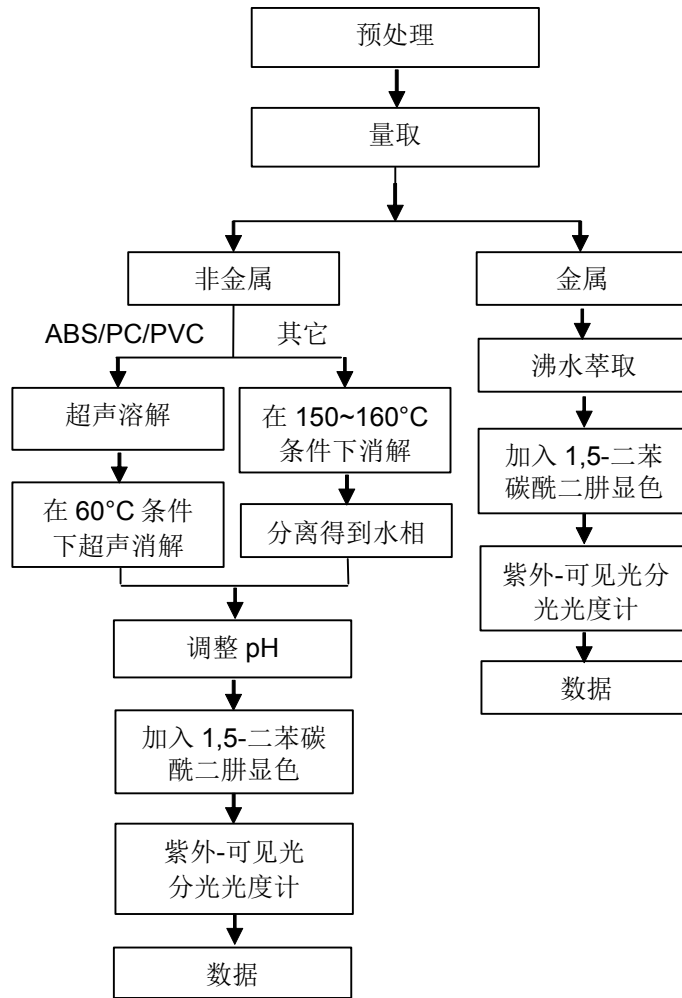

PBBs/PBDEs 测试流程图

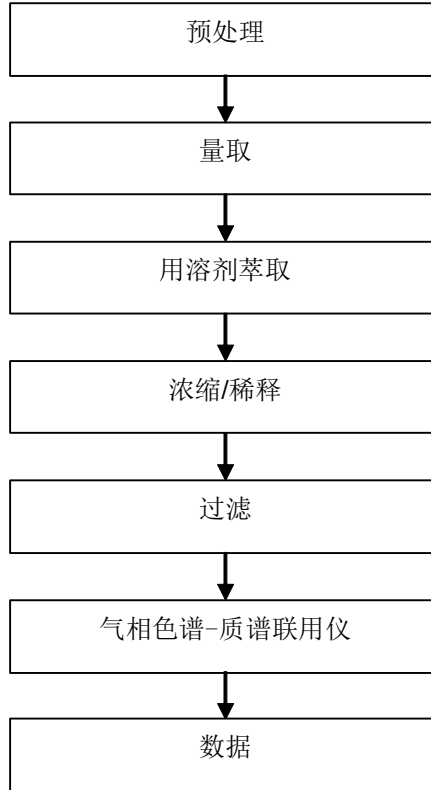

Phthalates 测试流程图

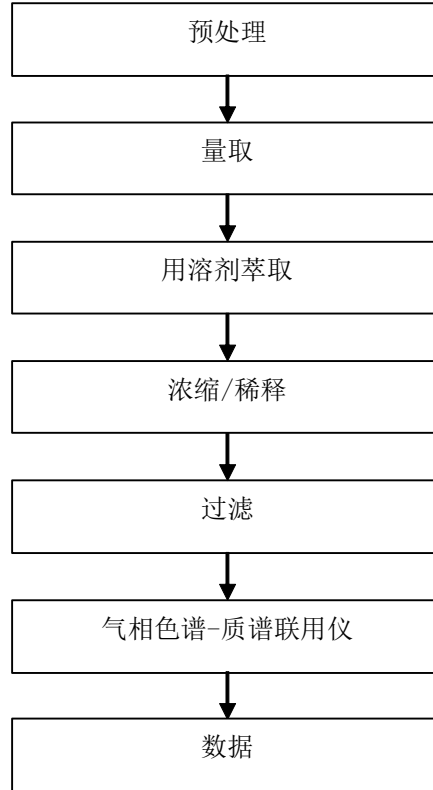

Halogen(氧弹法)测试流程图

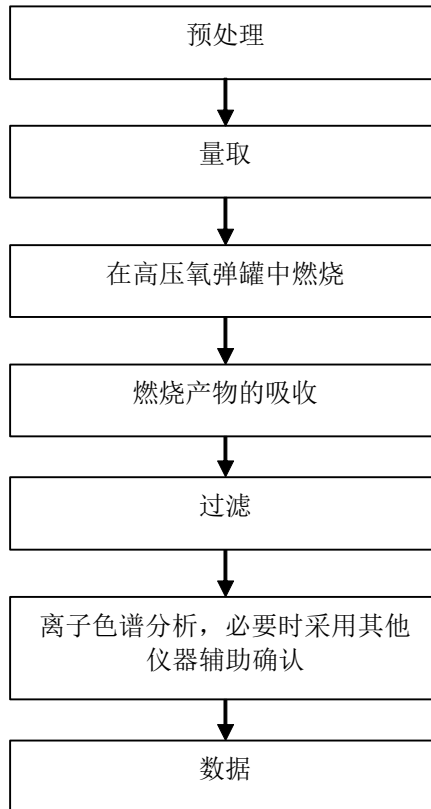

PAHs 测试流程图

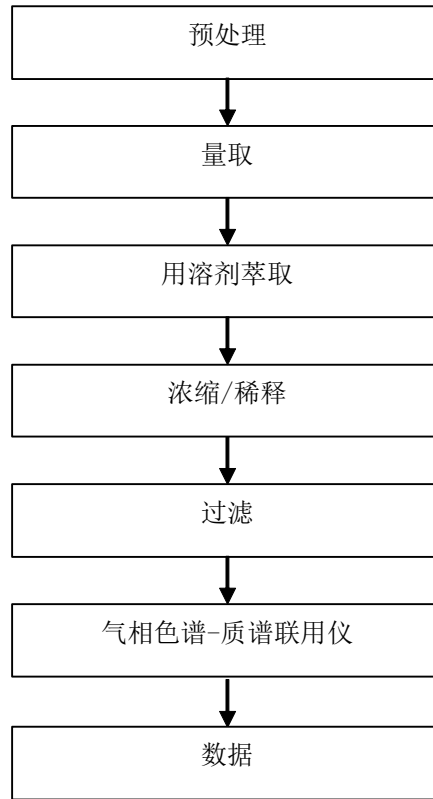

元素测试流程图

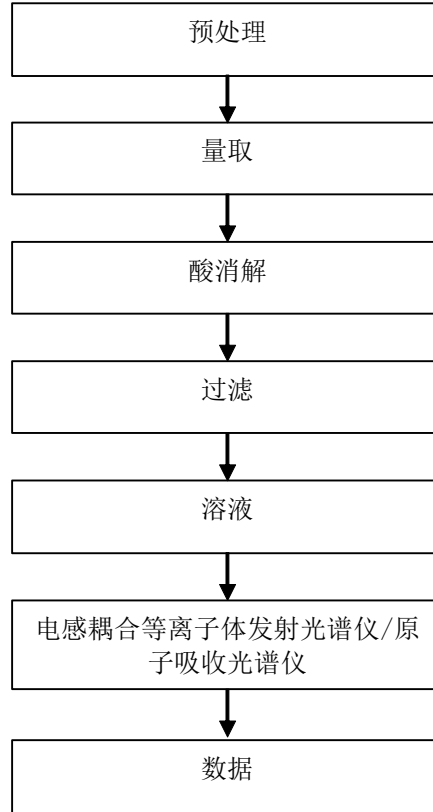

测试报告

No. NGBML2000312802

日期: 2020年01月22日 第14页,共14页

样品照片:



此照片仅限于随SGS正本报告使用

*** 报告完 ***





中国认可
检测
TESTING
CNAS L4305

测试报告

No. NGBML2000309802

日期: 2020年01月22日

第1页,共8页

浙江巨化股份有限公司
浙江省衢州市柯城区巨化

以下测试之样品是由申请者所提供及确认: 聚四氟乙烯模压粉

SGS工作编号: NBIN2001000747PC - NB
 样品接收日期: 2020年01月19日
 测试周期: 2020年01月19日 - 2020年01月22日
 测试要求: 根据客户要求测试
 测试方法: 请参见下一页
 测试结果: 请参见下一页
 结论: 基于所送样品进行的测试, 镉、铅、汞、六价铬、多溴联苯(PBBs)、多溴二苯醚(PBDEs)、邻苯二甲酸酯(如邻苯二甲酸二丁酯(DBP)、邻苯二甲酸丁苄酯(BBP)、邻苯二甲酸二(2-乙基己基)酯(DEHP)和邻苯二甲酸二异丁酯(DIBP))的测试结果符合欧盟RoHS指令2011/65/EU附录II的修正指令(EU) 2015/863的限值要求。

通标标准技术服务有限公司宁波分公司
授权签名

肖玲艳

Iris Xiao 肖玲艳
批准签署人

扫码查看在线报告



NGBML2000309802



SGS-CSTC Inspection & Testing Services Co., Ltd.
Ningbo Branch Chemical Laboratory

Unless otherwise agreed in writing, this document is issued by the Company subject to its General Conditions of Service printed overleaf, available on request or accessible at <http://www.sgs.com/en/Terms-and-Conditions.aspx> and, for electronic format documents, subject to Terms and Conditions for Electronic Documents at <http://www.sgs.com/en/Terms-and-Conditions/Terms-e-Document.aspx>. Attention is drawn to the limitation of liability, indemnification and jurisdiction issues defined therein. Any holder of this document is advised that information contained hereon reflects the Company's findings at the time of its intervention only and within the limits of Client's instructions, if any. The Company's sole responsibility is to its Client and this document does not exonerate parties to a transaction from exercising all their rights and obligations under the transaction documents. This document cannot be reproduced except in full, without prior written approval of the Company. Any unauthorized alteration, forgery or falsification of the content or appearance of this document is unlawful and offenders may be prosecuted to the fullest extent of the law. Unless otherwise stated the results shown in this test report refer only to the sample(s) tested.

Attention: To check the authenticity of testing / inspection report & certificate, please contact us at telephone: (86-755) 8307 1443, or email: CN.Doccheck@sgs.com

15/F West of Building 4, Lingun Industry Park, No.1177 Lingun Road, Ningbo National Hi-Tech Zone, Ningbo, Zhejiang, China 315040 t E&E (86-574)89070249 www.sgsgroup.com.cn
 中国·浙江·宁波市国家高新区凌云路1177号凌云产业园4号楼西1-5层 邮编: 315040 t HL (86-574)89070271 t ML (86-574)89070242 e sgs.china@sgs.com

Member of the SGS Group (SGS SA)

测试报告

No. NGBML2000309802

日期: 2020年01月22日

第2页,共8页

测试结果:

测试样品描述:

样品编号	SGS样品ID	描述
SN1	NGB20-003098.001	白色粉末

备注:

- (1) 1 mg/kg = 0.0001%
- (2) MDL = 方法检测限
- (3) ND = 未检出 (< MDL)
- (4) "-" = 未规定

RoHS 指令2011/65/EU附录II的修正指令(EU) 2015/863

测试方法: 参考IEC 62321-4:2013+A1:2017, IEC 62321-5:2013, IEC 62321-7-2:2017, IEC 62321-6:2015和IEC 62321-8:2017, 采用ICP-OES,UV-Vis和GC-MS进行分析.

测试项目	限值	单位	MDL	001
镉(Cd)	100	mg/kg	2	ND
铅(Pb)	1000	mg/kg	2	ND
汞(Hg)	1000	mg/kg	2	ND
六价铬 (Cr(VI))	1000	mg/kg	8	ND
多溴联苯(PBBs)之和	1000	mg/kg	-	ND
一溴联苯	-	mg/kg	5	ND
二溴联苯	-	mg/kg	5	ND
三溴联苯	-	mg/kg	5	ND
四溴联苯	-	mg/kg	5	ND
五溴联苯	-	mg/kg	5	ND
六溴联苯	-	mg/kg	5	ND
七溴联苯	-	mg/kg	5	ND
八溴联苯	-	mg/kg	5	ND
九溴联苯	-	mg/kg	5	ND
十溴联苯	-	mg/kg	5	ND
多溴二苯醚之和(PBDEs)	1000	mg/kg	-	ND
一溴二苯醚	-	mg/kg	5	ND
二溴二苯醚	-	mg/kg	5	ND
三溴二苯醚	-	mg/kg	5	ND
四溴二苯醚	-	mg/kg	5	ND
五溴二苯醚	-	mg/kg	5	ND
六溴二苯醚	-	mg/kg	5	ND



测试报告

No. NGBML2000309802

日期: 2020年01月22日

第3页,共8页

测试项目	限值	单位	MDL	001
七溴二苯醚	-	mg/kg	5	ND
八溴二苯醚	-	mg/kg	5	ND
九溴二苯醚	-	mg/kg	5	ND
十溴二苯醚	-	mg/kg	5	ND
邻苯二甲酸二丁酯 (DBP)	1000	mg/kg	50	ND
邻苯二甲酸丁苄酯(BBP)	1000	mg/kg	50	ND
邻苯二甲酸二(2-乙基己基)酯(DEHP)	1000	mg/kg	50	ND
邻苯二甲酸二异丁酯(DIBP)	1000	mg/kg	50	ND

备注:

(1) 最大允许极限值引用自RoHS指令(EU) 2015/863。

IEC 62321系列等同于 EN 62321 系列

https://www.cenelec.eu/dyn/www/f?p=104:30:1742232870351101:::FSP_ORG_ID,FSP_LANG_ID:1258637,25

(2) 2021年7月22号开始, DEHP, BBP, DBP 和 DIBP的限制适用于医疗器械, 包括体外医疗器械, 监控仪表, 包括工业监测和控制仪器。

(3) DEHP, BBP, DBP 和 DIBP的限制不适用于玩具产品, 因为No.1907/2006附录XVII第51条已对玩具产品中的DEHP, BBP, DBP 和 DIBP含量进行了限制。

除非另有说明, 此报告结果仅对测试的样品负责。本报告未经本公司书面许可, 不可部分复制。

检测报告仅用于客户科研、教学、内部质量控制、产品研发等目的, 仅供内部参考。



Pb /Cd / Hg 测试流程图

1)样品按照下述流程被完全消解

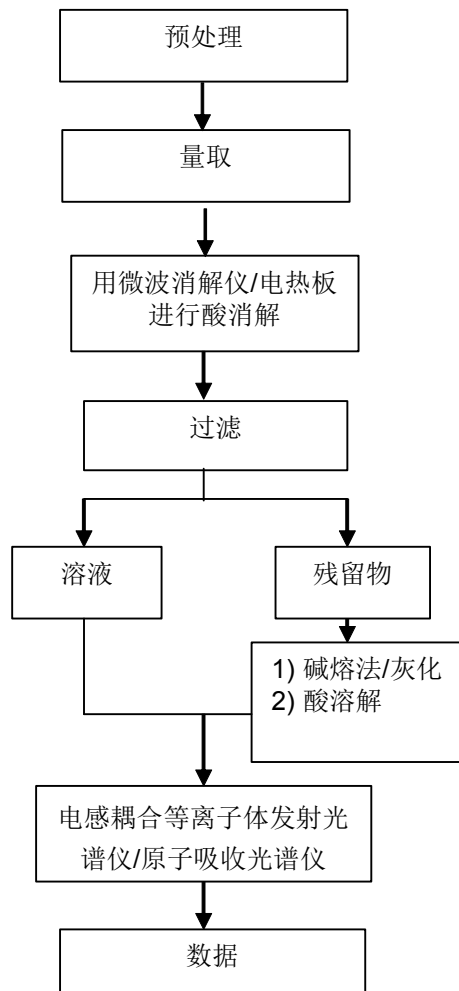

附件

六价铬测试流程图

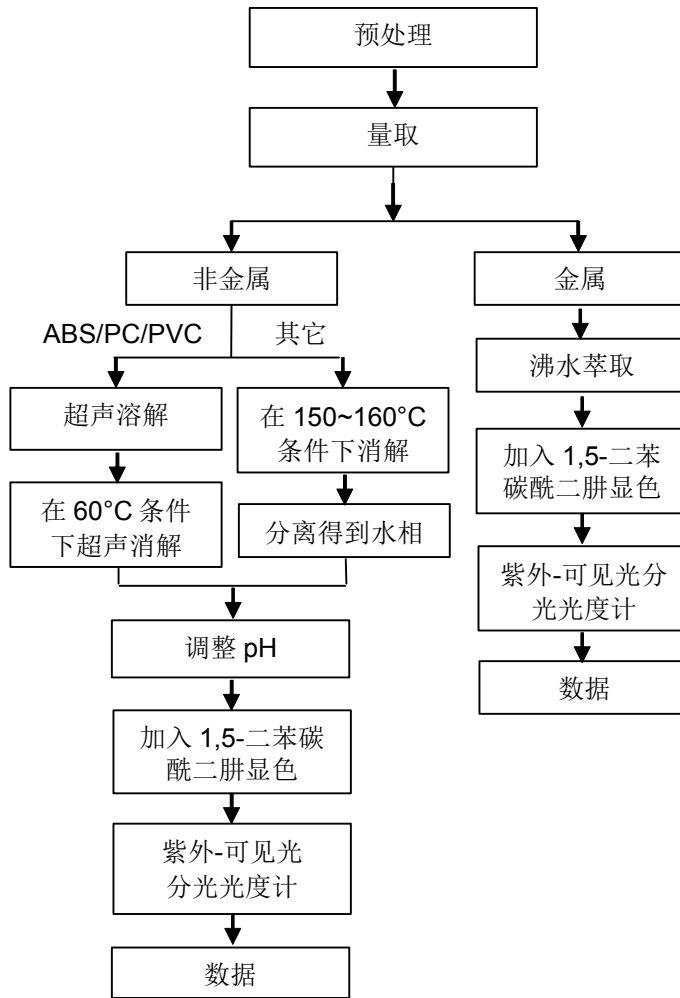

PBBs/PBDEs 测试流程图

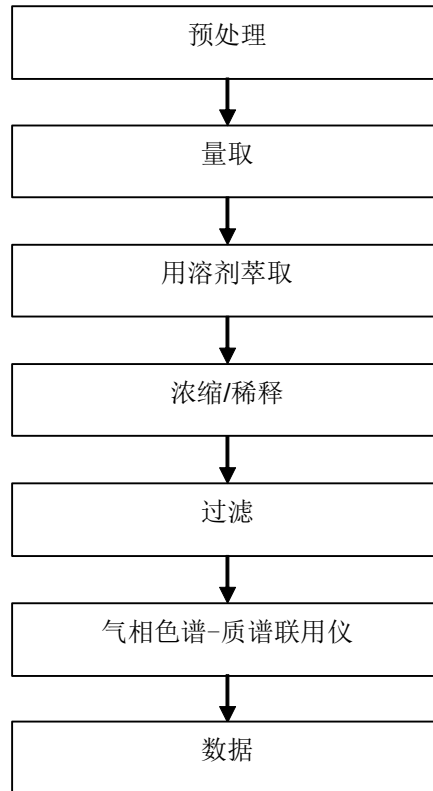

Phthalates 测试流程图

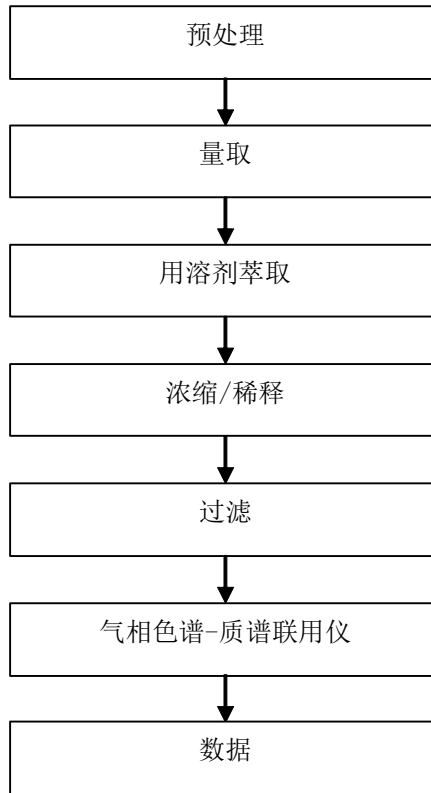

测试报告

No. NGBML2000309802

日期: 2020年01月22日

第8页,共8页

样品照片:



此照片仅限于随SGS正本报告使用

*** 报告完 ***



Test Report

No. CANEC2002004901

Date: 05 Mar 2020

Page 1 of 6

DONGGUAN DIWANG COMMUNICATION TECHNOLOGY CO.,LTD
NO.3 WEST STREET ROAD, CHANGAN TOWN COMMUNITY DONGGUAN CITY

The following sample(s) was/were submitted and identified on behalf of the clients as : SC

SGS Job No. : CP20-005073 - GZ

Date of Sample Received : 02 Mar 2020

Testing Period : 02 Mar 2020 - 05 Mar 2020

Test Requested : Selected test(s) as requested by client.

Test Method : Please refer to next page(s).

Test Results : Please refer to next page(s).

Conclusion : Based on the performed tests on submitted sample(s), the results of Lead, Mercury, Cadmium, Hexavalent chromium, Polybrominated biphenyls (PBBs), Polybrominated diphenyl ethers (PBDEs) and Phthalates such as Bis(2-ethylhexyl) phthalate (DEHP) , Butyl benzyl phthalate (BBP), Dibutyl phthalate (DBP) , and Diisobutyl phthalate (DIBP) comply with the limits as set by RoHS Directive (EU) 2015/863 amending Annex II to Directive 2011/65/EU.

Signed for and on behalf of
SGS-CSTC Standards Technical Services Co., Ltd. Guangzhou Branch

Violet,Shi
Approved Signatory



Test Report

No. CANEC2002004901

Date: 05 Mar 2020

Page 2 of 6

Test Results :

Test Part Description :

Specimen No.	SGS Sample ID	Description
SN1	CAN20-020049.001	Silver-white plated metal wire

Remarks :

- (1) 1 mg/kg = 0.0001%
- (2) MDL = Method Detection Limit
- (3) ND = Not Detected (< MDL)
- (4) "-" = Not Regulated

RoHS Directive (EU) 2015/863 amending Annex II to Directive 2011/65/EU

Test Method : With reference to IEC 62321-4:2013+A1:2017, IEC 62321-5:2013, IEC 62321-7-1:2015 , IEC 62321-6:2015 and IEC 62321-8:2017, analyzed by ICP-OES , UV-Vis and GC-MS .

<u>Test Item(s)</u>	<u>Limit</u>	<u>Unit</u>	<u>MDL</u>	<u>001</u>
Cadmium (Cd)	100	mg/kg	2	ND
Lead (Pb)	1,000	mg/kg	2	ND
Mercury (Hg)	1,000	mg/kg	2	ND
Hexavalent Chromium (Cr(VI))▼	-	µg/cm ²	0.10	ND
Sum of PBBs	1,000	mg/kg	-	ND
Monobromobiphenyl	-	mg/kg	5	ND
Dibromobiphenyl	-	mg/kg	5	ND
Tribromobiphenyl	-	mg/kg	5	ND
Tetrabromobiphenyl	-	mg/kg	5	ND
Pentabromobiphenyl	-	mg/kg	5	ND
Hexabromobiphenyl	-	mg/kg	5	ND
Heptabromobiphenyl	-	mg/kg	5	ND
Octabromobiphenyl	-	mg/kg	5	ND
Nonabromobiphenyl	-	mg/kg	5	ND
Decabromobiphenyl	-	mg/kg	5	ND
Sum of PBDEs	1,000	mg/kg	-	ND
Monobromodiphenyl ether	-	mg/kg	5	ND
Dibromodiphenyl ether	-	mg/kg	5	ND
Tribromodiphenyl ether	-	mg/kg	5	ND
Tetrabromodiphenyl ether	-	mg/kg	5	ND
Pentabromodiphenyl ether	-	mg/kg	5	ND



Unless otherwise agreed in writing, this document is issued by the Company subject to its General Conditions of Service printed overleaf, available on request or accessible at <http://www.sgs.com/en/Terms-and-Conditions.aspx> and, for electronic format documents, subject to Terms and Conditions for Electronic Documents at <http://www.sgs.com/en/Terms-and-Conditions/Terms-e-Document.aspx>. Attention is drawn to the limitation of liability, indemnification and jurisdiction issues defined therein. Any holder of this document is advised that information contained hereon reflects the Company's findings at the time of its intervention only and within the limits of Client's instructions, if any. The Company's sole responsibility is to its Client and this document does not exonerate parties to a transaction from exercising all their rights and obligations under the transaction documents. This document cannot be reproduced except in full, without prior written approval of the Company. Any unauthorized alteration, forgery or falsification of the content or appearance of this document is unlawful and offenders may be prosecuted to the fullest extent of the law. Unless otherwise stated the results shown in this test report refer only to the sample(s) tested.

Attention: To check the authenticity of testing /inspection report & certificate, please contact us at telephone: (86-755) 8307 1443, or email: CN.Doccheck@sgs.com

Test Report

No. CANEC2002004901

Date: 05 Mar 2020

Page 3 of 6

<u>Test Item(s)</u>	<u>Limit</u>	<u>Unit</u>	<u>MDL</u>	<u>001</u>
Hexabromodiphenyl ether	-	mg/kg	5	ND
Heptabromodiphenyl ether	-	mg/kg	5	ND
Octabromodiphenyl ether	-	mg/kg	5	ND
Nonabromodiphenyl ether	-	mg/kg	5	ND
Decabromodiphenyl ether	-	mg/kg	5	ND
Dibutyl phthalate (DBP)	1000	mg/kg	50	ND
Butyl benzyl phthalate (BBP)	1000	mg/kg	50	ND
Bis (2-ethylhexyl) phthalate (DEHP)	1000	mg/kg	50	ND
Diisobutyl Phthalates (DIBP)	1000	mg/kg	50	ND

Notes :

- (1) The maximum permissible limit is quoted from RoHS Directive (EU) 2015/863.IEC 62321 series is equivalent to EN 62321 series
https://www.cenelec.eu/dyn/www/f?p=104:30:1742232870351101:::FSP_ORG_ID,FSP_LANG_ID:1258637,25
- (2) ▽= a. The sample is positive for CrVI if the CrVI concentration is greater than 0.13 µg/cm². The sample coating is considered to contain CrVI
 b. The sample is negative for CrVI if CrVI is ND (concentration less than 0.10 µg/cm²). The coating is considered a non-CrVI based coating
 c. The result between 0.10 µg/cm² and 0.13 µg/cm² is considered to be inconclusive - unavoidable coating variations may influence the determination
 Information on storage conditions and production date of the tested sample is unavailable and thus Cr(VI) results represent status of the sample at the time of testing.



ATTACHMENTS

Pb/Cd/Hg/Cr⁶⁺/PBBs/PBDEs Testing Flow Chart

1) These samples were dissolved totally by pre -conditioning method according to below flow chart. (Cr⁶⁺ and PBBs/PBDEs test method excluded).

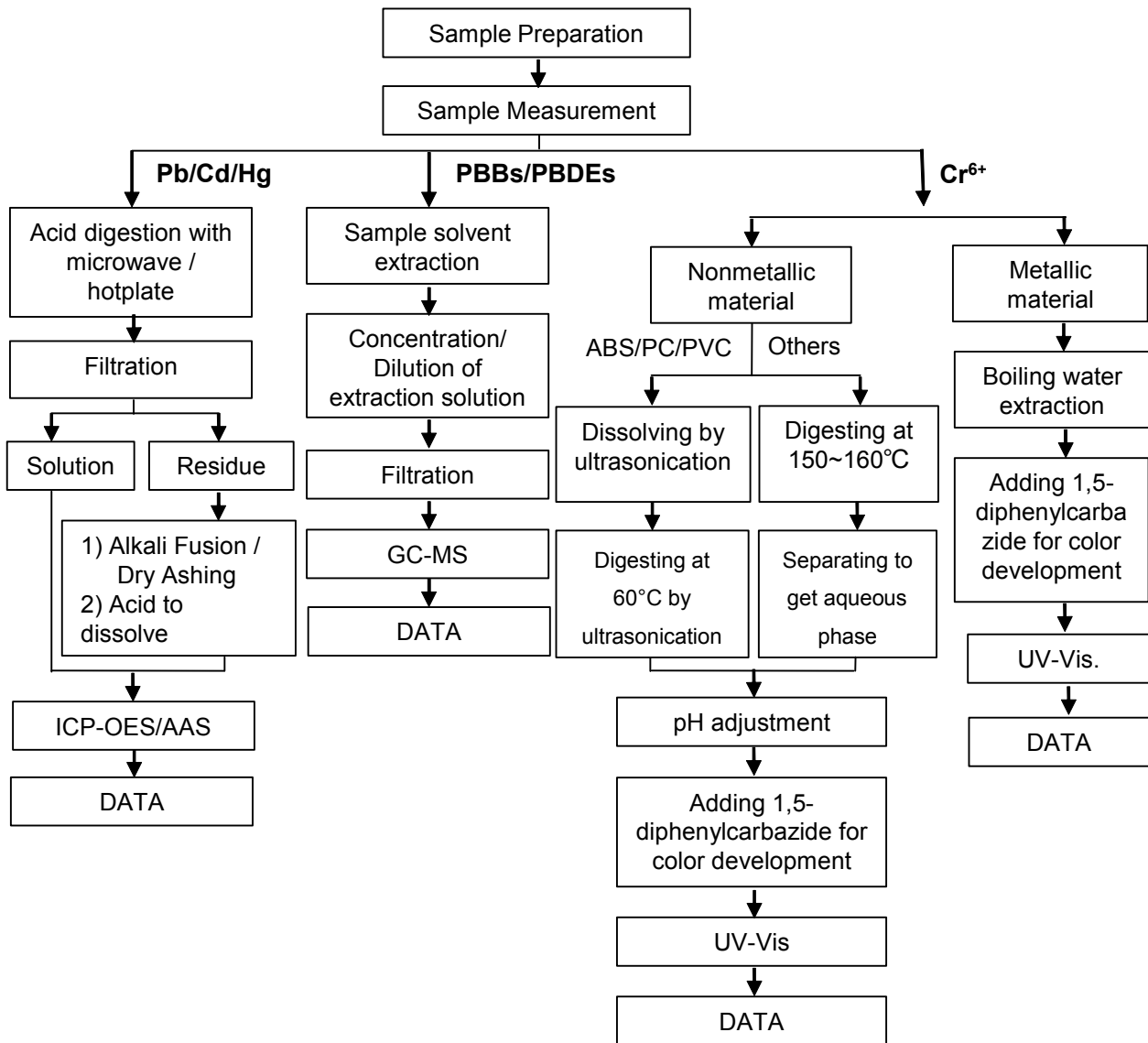

ATTACHMENTS

Phthalates Testing Flow Chart

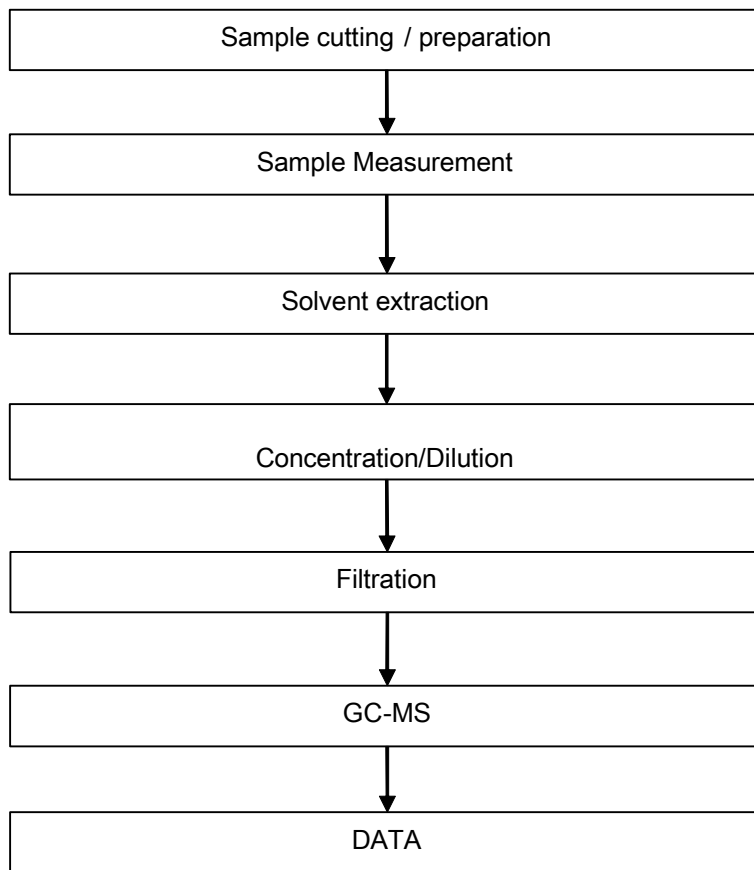

Sample photo:



SGS authenticate the photo on original report only

*** End of Report ***

检测报告



报告编号 A2200069617101001C

第 1 页 共 7 页

申请单位 苏州嘉尚金属材料科技有限公司/嘉尚精密材料科技(宜兴)有限责任公司

地址 苏州市相城区阳澄湖镇石田路7号/宜兴市官林镇丰义村

以下测试之样品及样品信息由申请者提供并确认

样品名称 镀锡圆铜线

样品接收日期 2020.03.30

样品检测日期 2020.03.30-2020.04.01

检测要求 根据客户要求,对所提交样品中的铅(Pb),镉(Cd),汞(Hg),六价铬(Cr(VI)),多溴联苯(PBBs),多溴二苯醚(PBDEs),邻苯二甲酸酯(DBP, BBP, DEHP, DIBP)进行测试。

检测依据 请参见下页。

检测结果 请参见下页。

结论

测试样品	依据标准/指令	结果
提交样品	欧盟RoHS指令2011/65/EU及其修订指令(EU) 2015/863	符合

符合表示检测结果满足欧盟RoHS指令2011/65/EU及其修订指令(EU) 2015/863要求的限值。



王东
陈凯敏

陈凯敏
实验室经理

上海华测品标检测技术有限公司

审 核

陈瑞

日 期

2020.04.01

No. R445411313

上海市闵行区万芳路1351号

检测报告

报告编号 A2200069617101001C

第 2 页 共 7 页

检测依据

测试项目	测试方法	测试仪器
铅(Pb)	IEC 62321-5:2013	ICP-OES
镉(Cd)	IEC 62321-5:2013	ICP-OES
汞(Hg)	IEC 62321-4:2013+AMD1:2017 CSV	ICP-OES
六价铬(Cr(VI))	IEC 62321-7-1:2015	UV-Vis
多溴联苯(PBBs)	IEC 62321-6:2015	GC-MS
多溴二苯醚(PBDEs)	IEC 62321-6:2015	GC-MS
邻苯二甲酸酯(DBP, BBP, DEHP, DIBP)	IEC 62321-8:2017	GC-MS

检测报告

报告编号 A2200069617101001C

第 3 页 共 7 页

检测结果

测试项目	结果	方法检出限	限值
铅 (Pb)	N. D.	2 mg/kg	1000 mg/kg
镉 (Cd)	N. D.	2 mg/kg	100 mg/kg
汞 (Hg)	N. D.	2 mg/kg	1000 mg/kg
六价铬 (Cr(VI))	N. D. ▼	0.10 $\mu\text{g}/\text{cm}^2$ (LOQ)	1000 mg/kg

测试项目	结果	方法检出限	限值
多溴联苯 (PBBs)			
一溴联苯	N. D.	5 mg/kg	1000 mg/kg
二溴联苯	N. D.	5 mg/kg	
三溴联苯	N. D.	5 mg/kg	
四溴联苯	N. D.	5 mg/kg	
五溴联苯	N. D.	5 mg/kg	
六溴联苯	N. D.	5 mg/kg	
七溴联苯	N. D.	5 mg/kg	
八溴联苯	N. D.	5 mg/kg	
九溴联苯	N. D.	5 mg/kg	
十溴联苯	N. D.	5 mg/kg	

测试项目	结果	方法检出限	限值
多溴二苯醚 (PBDEs)			
一溴二苯醚	N. D.	5 mg/kg	1000 mg/kg
二溴二苯醚	N. D.	5 mg/kg	
三溴二苯醚	N. D.	5 mg/kg	
四溴二苯醚	N. D.	5 mg/kg	
五溴二苯醚	N. D.	5 mg/kg	
六溴二苯醚	N. D.	5 mg/kg	
七溴二苯醚	N. D.	5 mg/kg	
八溴二苯醚	N. D.	5 mg/kg	
九溴二苯醚	N. D.	5 mg/kg	
十溴二苯醚	N. D.	5 mg/kg	

检测报告

报告编号 A2200069617101001C

第 4 页 共 7 页

检测结果

测试项目	结果	方法检出限	限值
邻苯二甲酸酯 (DBP, BBP, DEHP, DIBP)			
邻苯二甲酸二丁酯 (DBP) CAS#:84-74-2	N. D.	50 mg/kg	1000 mg/kg
邻苯二甲酸丁基苄基酯 (BBP) CAS#:85-68-7	N. D.	50 mg/kg	1000 mg/kg
邻苯二甲酸二(2-乙基)己酯 (DEHP) CAS#:117-81-7	N. D.	50 mg/kg	1000 mg/kg
邻苯二甲酸二异丁酯 (DIBP) CAS#:84-69-5	N. D.	50 mg/kg	1000 mg/kg

样品/部位描述 有银色镀层的金属丝

备注: 对于检测铅, 镉, 汞之样品已完全溶解。

-N.D. = 未检出 (小于方法检出限或定量限)

-mg/kg = ppm = 百万分之一

-1000 mg/kg = 0.1%

-LOQ = 定量限, 六价铬的定量限为0.10 µg/cm²

-▼六价铬浓度小于0.10 µg/cm², 样品未检出六价铬

注释: 本报告中的数据结果供科研、教学、企业内部质量控制、企业产品研发等目的用。

检测报告

报告编号 A2200069617101001C

第 5 页 共 7 页

检测流程

1. 铅(Pb), 镉(Cd)

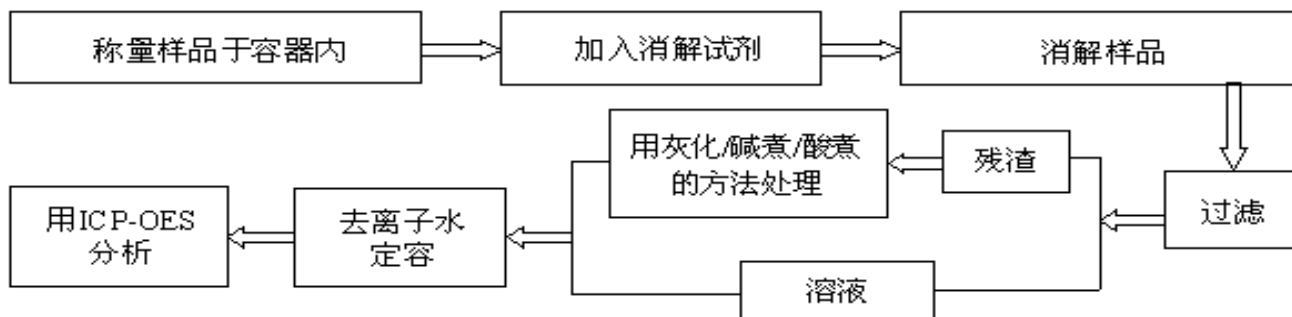

2. 汞(Hg)

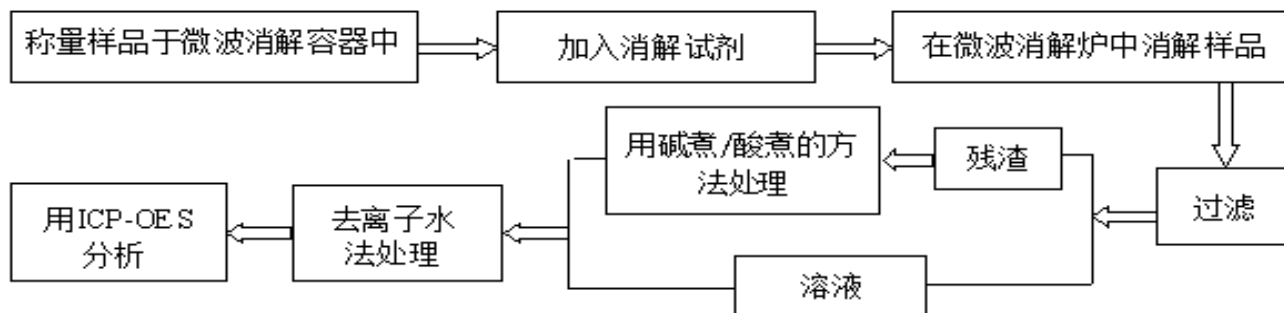

3. 六价铬(Cr(VI))

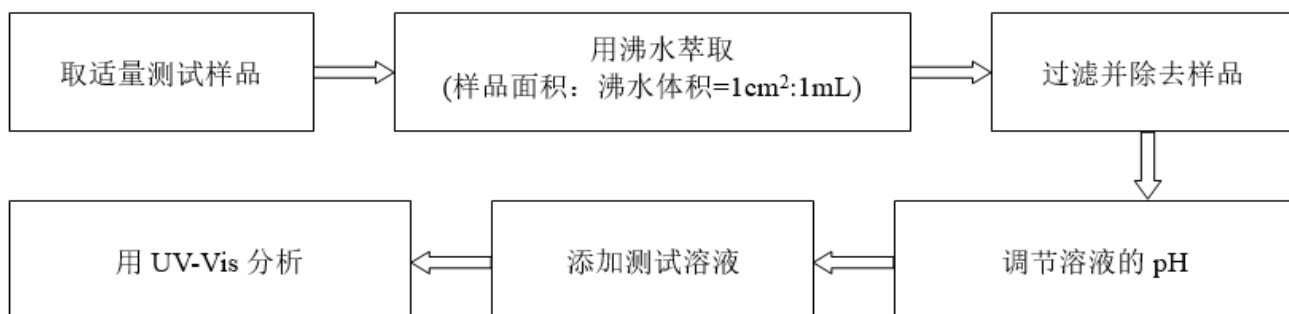

4. 多溴联苯(PBBs), 多溴二苯醚(PBDEs)

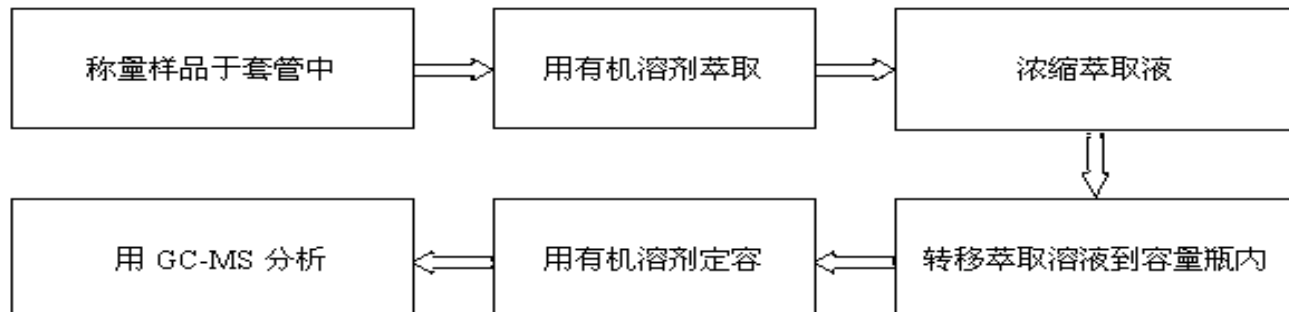

检测报告

报告编号 A2200069617101001C

第 6 页 共 7 页

5. 邻苯二甲酸酯(DBP, BBP, DEHP, DIBP)

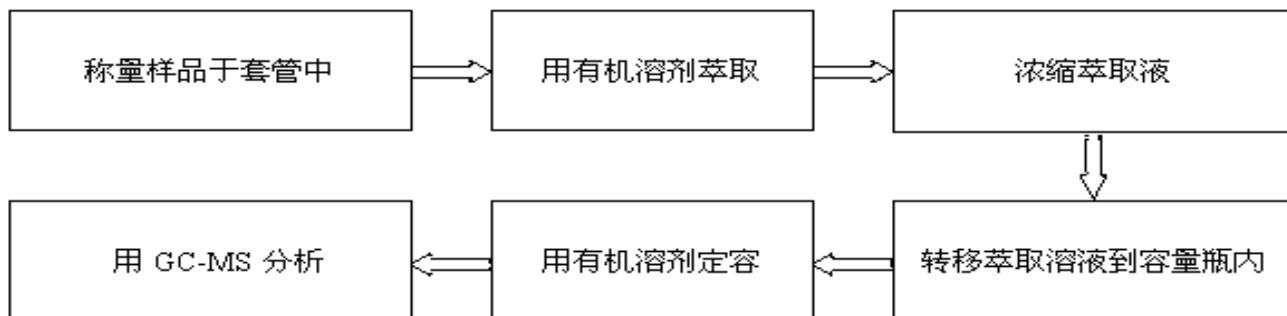

有限公司

检测报告

报告编号 A2200069617101001C

第 7 页 共 7 页

样品图片



*** 报告结束 ***

声明:

1. 检测报告无批准人签字、“专用章”及报告骑缝章无效;
2. 样品及样品信息由申请者提供, 申请者应对其真实性负责, CTI未核实其真实性;
3. 本报告检测结果仅对受测样品负责;
4. 未经CTI书面同意, 不得部分复制本报告。