

## TEST REPORT



|           |   |
|-----------|---|
| Applicant | BenQ Corporation                        |
| Address   | 16 Jihu Road, Neihu, Taipei 114, Taiwan |

|                                     |   |
|-------------------------------------|---|
| Manufacturer or Supplier            | BenQ Corporation                        |
| Address                             | 16 Jihu Road, Neihu, Taipei 114, Taiwan |
| Product Name                        | InstaShare Button                       |
| Brand Name                          | BenQ                                    |
| Model                               | TWY31                                   |
| Additional Model & Model Difference | N/A                                     |
| FCC ID                              | JVPTWY31                                |
| Date of tests                       | Sep. 09, 2021 ~ Nov. 19, 2021           |

the tests have been carried out according to the requirements of the following standard:

- FCC Part 15, Subpart E, Section 15.407**  
**FCC 06-96**  
**KDB 905462 D02 UNII DFS Compliance Procedures New Rules v02**  
**KDB 905462 D03 UNII Clients Without Radar Detection New Rules v01r02**

**CONCLUSION: The submitted sample was found to COMPLY with the test requirement**

|   |   |
|---|---|
| Tested by Andy Zhu<br>Supervisor / EMC Department                                   | Approved by Glyn He<br>Assistant Manager / EMC Department   |
|  | <br><br>Date: Dec. 15, 2021 |

This report is governed by, and incorporates by reference, CPS Conditions of Service as posted at the date of issuance of this report at <https://www.cps.bureauveritas.com/terms-conditions> and is intended for your exclusive use. Any copying or replication of this report to or for any other person or entity, or use of our name or trademark, is permitted only with our prior written permission. This report sets forth our findings solely with respect to the test samples identified herein. The results set forth in this report are not indicative or representative of the quality or characteristics of the lot from which a test sample was taken or any similar or identical product unless specifically and expressly noted. Our report includes all of the tests requested by you and the results thereof based upon the information that you provided to us. Measurement uncertainty is only provided upon request for accredited tests. You have 60 days from date of issuance of this report to notify us of any material error or omission caused by our negligence or if you require measurement uncertainty; provided, however, that such notice shall be in writing and shall specifically address the issue you wish to raise. A failure to raise such issue within the prescribed time shall constitute your unqualified acceptance of the completeness of this report, the tests conducted and the correctness of the report contents.



# TABLE OF CONTENTS

**RELEASE CONTROL RECORD ..... 4**

**1 EUT INFORMATION..... 5**

1.1 OPERATING FREQUENCY BANDS AND MODE OF EUT ..... 5

1.2 EUT SOFTWARE AND FIRMWARE VERSION ..... 5

1.3 DESCRIPTION OF AVAILABLE ANTENNAS TO THE EUT ..... 5

1.4 TRANSMIT POWER CONTROL (TPC) ..... 6

1.5 STATEMENT OF MAUNFACTURER ..... 6

**2 U-NII DFS RULE REQUIREMENTS ..... 7**

2.1 WORKING MODES AND REQUIRED TEST ITEMS ..... 7

2.2 TEST LIMITS AND RADAR SIGNAL PARAMETERS ..... 8

**3 TEST & SUPPORT EQUIPMENT LIST .....11**

3.1 TEST INSTRUMENTS .....11

3.2 DESCRIPTION OF SUPPORT UNITS.....11

**4 TEST PROCEDURE..... 12**

4.1 BVADT DFS MEASUREMENT SYSTEM:..... 12

4.2 CALIBRATION OF DFS DETECTION THRESHOLD LEVEL: ..... 13

4.3 DEVIATION FROM TEST STANDARD ..... 14

4.4 CONDUCTED TEST SETUP CONFIGURATION ..... 14

4.4.1 CLIENT WITHOUT RADAR DETECTION MODE ..... 14

**5 TEST RESULTS ..... 15**

5.1 SUMMARY OF TEST RESULTS..... 15

5.2 DETAILED TEST RESULTS..... 15

5.2.1 TEST MODE: DEVICE OPERATING IN CLIENT WITHOUT RADAR DETECTION  
MODE ..... 15

5.2.2 DFS DETECTION THRESHOLD ..... 16

5.2.3 CHANNEL LOADING ..... 17

5.2.4 CHANNEL CLOSING TRANSMISSION AND CHANNEL MOVE TIME..... 18

5.2.5 NON- OCCUPANCY PERIOD ..... 19

5.2.6 NON-ASSOCIATED TEST ..... 21

5.2.7 NON- CO-CHANNEL TEST ..... 21



**BUREAU**  
**VERITAS**

**Test Report No.: RF2109WDG0104-3**

|          |   |           |
|----------|---|-----------|
| <b>6</b> | <b>PHOTOGRAPHS OF THE TEST CONFIGURATION .....</b>  | <b>22</b> |
| <b>7</b> | <b>APPENDIX A - MODIFICATIONS RECORDERS FOR ENGINEERING CHANGES<br/>TO THE EUT BY THE LAB .....</b> | <b>23</b> |



**BUREAU  
VERITAS**

Test Report No.: RF2109WDG0104-3

## RELEASE CONTROL RECORD

| ISSUE NO.       | REASON FOR CHANGE | DATE ISSUED   |
|-----------------|-------------------|---------------|
| RF2109WDG0104-3 | Original release. | Dec. 15, 2021 |



# 1 EUT INFORMATION

## 1.1 OPERATING FREQUENCY BANDS AND MODE OF EUT

OPERATING FREQUENCY BANDS AND MODE OF EUT

| OPERATIONAL MODE                                   | OPERATING FREQUENCY RANGE |              |
|--|---------------------------|--------------|
|  | 5250~5350MHz              | 5470~5725MHz |
| Client without radar detection and ad hoc function | V                         | V            |

## 1.2 EUT SOFTWARE AND FIRMWARE VERSION

THE EUT SOFTWARE/FIRMWARE VERSION

| NO. | PRODUCT           | MODEL NO. | SOFTWARE/FIRMWARE VERSION                  |
|-----|-------------------|-----------|--|
| 1   | InstaShare Button | TWY31     | BenQ TWY31 Firmware -v1.0.0823 / BQ01-V1.1 |

## 1.3 DESCRIPTION OF AVAILABLE ANTENNAS TO THE EUT

ANTENNA LIST

| Ant. No.                   | Vendor  | Antenna Type | Operation Frequency Range (MHz) | Gain (dBi) |
|----------------------------|---|--------------|---------------------------------|------------|
| Chain 0                    | SHENZHEN SHUODIAN ELECTRONIC AND TECHNOLOGY CO.,LTD | FPC          | 5250 - 5350                     | 3          |
|                            |   |              | 5470 - 5725                     | 3          |
| Chain 1                    |   | FPC          | 5250 - 5350                     | 3          |
|                            |   |              | 5470 - 5725                     | 3          |
| Directional Gain for PSD   |   |              | 6.01dBi                         |            |
| Directional Gain for power |   |              | 3dBi                            |            |

All antennas have the same gain, Directional gain = GANT + Array Gain, where Array Gain is as follows.  
 For power spectral density (PSD) measurements on all devices, Array Gain = 10 log(NANT/NSS=1) dB.  
 For power measurements on IEEE 802.11 devices, Array Gain = 0 dB (i.e., no array gain) for NANT ≤ 4



#### **1.4 TRANSMIT POWER CONTROL (TPC)**

U-NII devices operating in the 5.25-5.35 GHz band and the 5.47-5.725 GHz band shall employ a TPC mechanism. The U-NII device is required to have the capability to operate at least 6 dB below the mean EIRP value of 30 dBm. A TPC mechanism is not required for systems with an EIRP of less than 500 mW.

Maximum EIRP of this device is less than 500mW which less than 500mW, therefore it's not require TPC function.

#### **1.5 STATEMENT OF MAUNFACTURER**

This device (Client) is without radar detection, then the manufacturer statement confirming that information regarding the parameters of the detected Radar Waveforms is not available to the end user. And the device doesn't have Ad Hoc mode on DFS frequency band.



## 2 U-NII DFS RULE REQUIREMENTS

### 2.1 WORKING MODES AND REQUIRED TEST ITEMS

The manufacturer shall state whether the UUT is capable of operating as a Master and/or a Client. If the UUT is capable of operating in more than one operating mode then each operating mode shall be tested separately. See the applicability of DFS requirements for each of the operational modes.

#### APPLICABILITY OF DFS REQUIREMENTS PRIOR TO USE A CHANNEL

| REQUIREMENT                     | OPERATIONAL MODE |                                |                             |
|---------------------------------|------------------|--------------------------------|-----------------------------|
|                                 | MASTER           | CLIENT WITHOUT RADAR DETECTION | CLIENT WITH RADAR DETECTION |
| Non-Occupancy Period            | ✓                | ✓                              | ✓                           |
| DFS Detection Threshold         | ✓                | Not required                   | ✓                           |
| Channel Availability Check Time | ✓                | Not required                   | Not required                |
| Uniform Spreading               | ✓                | Not required                   | Not required                |
| U-NII Detection Bandwidth       | ✓                | Not required                   | ✓                           |

#### APPLICABILITY OF DFS REQUIREMENTS DURING NORMAL OPERATION

| REQUIREMENT                       | OPERATIONAL MODE |                                |                             |
|-----------------------------------|------------------|--------------------------------|-----------------------------|
|                                   | MASTER           | CLIENT WITHOUT RADAR DETECTION | CLIENT WITH RADAR DETECTION |
| DFS Detection Threshold           | ✓                | Not required                   | ✓                           |
| Channel Closing Transmission Time | ✓                | ✓                              | ✓                           |
| Channel Move Time                 | ✓                | ✓                              | ✓                           |
| U-NII Detection Bandwidth         | ✓                | Not required                   | ✓                           |



## 2.2 TEST LIMITS AND RADAR SIGNAL PARAMETERS

### DETECTION THRESHOLD VALUES

#### DFS DETECTION THRESHOLDS FOR MASTER DEVICES AND CLIENT DEVICES WITH RADAR DETECTION

| MAXIMUM TRANSMIT POWER | VALUE (SEE Note 1 and 2) |
|------------------------|--------------------------|
| ≥ 200 milliwatt        | -64 dBm                  |
| < 200 milliwatt        | -62 dBm                  |

**Note 1:** This is the level at the input of the receiver assuming a 0 dBi receive antenna.

**Note 2:** Throughout these test procedures an additional 1 dB has been added to the amplitude of the test transmission waveforms to account for variations in measurement equipment. This will ensure that the test signal is at or above the detection threshold level to trigger a DFS response.

#### DFS RESPONSE REQUIREMENT VALUES

| PARAMETER                         | VALUE   |
|-----------------------------------|---|
| Non-occupancy period              | Minimum 30 minutes  |
| Channel Availability Check Time   | 60 seconds  |
| Channel Move Time                 | 10 seconds<br>See Note 1.   |
| Channel Closing Transmission Time | 200 milliseconds + an aggregate of 60 milliseconds over remaining 10 second period.<br>See Notes 1 and 2. |
| U-NII Detection Bandwidth         | 100% of the UNII transmission power bandwidth.<br>See Note 3.   |

**Note 1:** The instant that the Channel Move Time and the Channel Closing Transmission Time begins is as follows:

- For the Short Pulse Radar Test Signals this instant is the end of the Burst.
- For the Frequency Hopping radar Test Signal, this instant is the end of the last radar Burst generated.
- For the Long Pulse Radar Test Signal this instant is the end of the 12 second period defining the Radar Waveform.

**Note 2:** The Channel Closing Transmission Time is comprised of 200 milliseconds starting at the beginning of the Channel Move Time plus any additional intermittent control signals required to facilitate a Channel move (an aggregate of 60 milliseconds) during the remainder of the 10 second period. The aggregate duration of control signals will not count quiet periods in between transmissions.

**Note 3:** During the U-NII Detection Bandwidth detection test, radar type 1 is used and for each frequency step the minimum percentage of detection is 90 percent. Measurements are performed with no data traffic.





**PARAMETERS OF DFS TEST SIGNALS**

Step intervals of 0.1 microsecond for Pulse Width, 1 microsecond for PRI, 1 MHz for chirp width and 1 for the number of pulses will be utilized for the random determination of specific test waveforms.

Short Pulse Radar Test Waveforms

| <b>Radar Type</b>  | <b>Pulse Width (μsec)</b> | <b>PRI (μsec)</b>   | <b>Number of Pulses</b>  | <b>Minimum Percentage of Successful Detection</b> | <b>Minimum Number of Trials</b> |
|--|---------------------------|---|--|---|---------------------------------|
| 0  | 1                         | 1428  | 18   | See Note 1  | See Note 1                      |
| 1  | 1                         | Test A: 15 unique PRI values randomly selected from the list of 23 PRI values in Table 5a<br>-----<br>Test B: 15 unique PRI values randomly selected within the range of 518-3066 μsec, with a minimum increment of 1 μsec, excluding PRI values selected in Test A | $\text{Roundup} \left\{ \begin{array}{l} \left( \frac{1}{360} \right) \cdot \\ \left( \frac{19 \cdot 10^6}{\text{PRI}_{\mu\text{sec}}} \right) \end{array} \right\}$ | 60%   | 30                              |
| 2  | 1-5                       | 150-230   | 23-29  | 60%   | 30                              |
| 3  | 6-10                      | 200-500   | 16-18  | 60%   | 30                              |
| 4  | 11-20                     | 200-500   | 12-16  | 60%   | 30                              |
| <b>Aggregate (Radar Types 1-4)</b>   |                           |   |  | <b>80%</b>  | <b>120</b>                      |
| Note 1: Short Pulse Radar Type 0 should be used for the detection bandwidth test, channel move time, and channel closing time tests. |                           |   |  |   |                                 |



**LONG PULSE RADAR TEST WAVEFORM**

| <b>RADAR TYPE</b> | <b>PULSE WIDTH (μsec)</b> | <b>CHIRP WIDTH (MHz)</b> | <b>PRI (μsec)</b> | <b>NUMBER OF PULSES PER BURST</b> | <b>NUMBER OF BURSTS</b> | <b>MINIMUM PERCENTAGE OF SUCCESSFUL DETECTION</b> | <b>MINIMUM NUMBER OF TRIALS</b> |
|-------------------|---------------------------|--------------------------|-------------------|-----------------------------------|-------------------------|---|---------------------------------|
| 5                 | 50-100                    | 5-20                     | 1000-2000         | 1-3                               | 8-20                    | 80%   | 30                              |

**FREQUENCY HOPPING RADAR TEST WAVEFORM**

| <b>RADAR TYPE</b> | <b>PULSE WIDTH (μsec)</b> | <b>PRI (μsec)</b> | <b>PULSES PER HOP</b> | <b>HOPPING RATE (kHz)</b> | <b>HOPPING SEQUENCE LENGTH (msec)</b> | <b>MINIMUM PERCENTAGE OF SUCCESSFUL DETECTION</b> | <b>MINIMUM NUMBER OF TRIALS</b> |
|-------------------|---------------------------|-------------------|-----------------------|---------------------------|---------------------------------------|---|---------------------------------|
| 6                 | 1                         | 333               | 9                     | 0.333                     | 300                                   | 70%   | 30                              |



### 3 TEST & SUPPORT EQUIPMENT LIST

#### 3.1 TEST INSTRUMENTS

TEST INSTRUMENTS LIST.

| DESCRIPTION & MANUFACTURER       | MODEL NO. | BRAND      | CALIBRATED UNTIL |
|----------------------------------|-----------|------------|------------------|
| Spectrum Analyzer                | N9020A    | MY55400499 | Mar. 20, 22      |
| R&S Spectrum                     | FSV7      | R&S        | Nov. 24, 21      |
| MXG-B RF Vector Signal Generator | N5182B    | MY56200288 | Jan. 01, 22      |
| Signal generator                 | 8645A     | Agilent    | Aug. 31, 22      |

**NOTE:**

1. The calibration interval of the above test instruments is 12 months and the calibrations are traceable to CEPREI/CHINA, GRGT/CHINA and NIM/CHINA.
2. The FCC Site Registration No. is 749762.

#### 3.2 DESCRIPTION OF SUPPORT UNITS

SUPPORT UNIT INFORMATION.

| NO. | PRODUCT         | BRAND   | MODEL NO.   | FCC ID         | SOFTWARE/FIRMWARE VERSION |
|-----|-----------------|---------|-------------|----------------|---------------------------|
| 1   | wireless router | LINKSYS | WRT-3200ACM | Q87-WRT3200ACM | 1.0.0.174361              |

**NOTE:** This device was functioned as a Master Slave device during the DFS test.



## 4 TEST PROCEDURE

### 4.1 BVADT DFS MEASUREMENT SYSTEM:

A complete DFS Measurement System consists of Radar signal generate system to generating the radar waveforms. The traffic monitoring system is specified to the type of unit under test (UUT).

Conducted setup configuration of DFS Measurement System

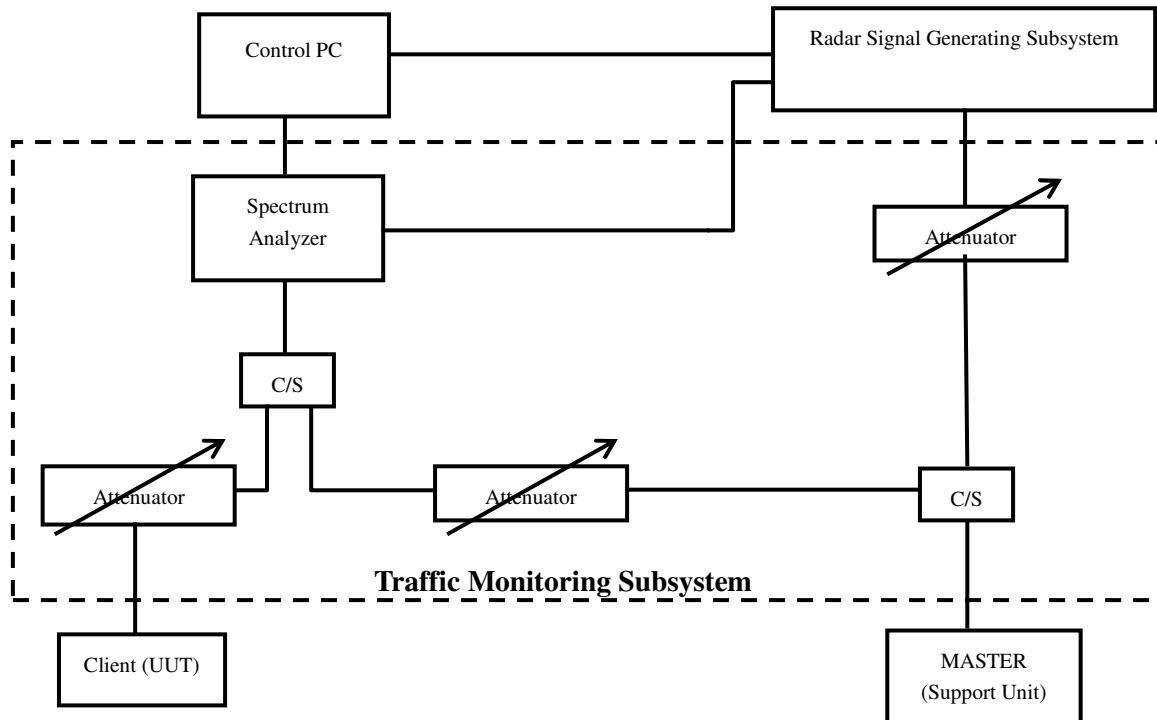

### Channel Loading

System testing will be performed with channel-loading using means appropriate to the data types that are used by the unlicensed device. The following requirements apply:

|    |   |   |
|----|---|---|
| a) | The data file must be of a type that is typical for the device (i.e., MPEG-2, MPEG-4, WAV, MP3, MP4, AVI, etc.) and must generally be transmitting in a streaming mode. |   |
| b) | Software to ping the client is permitted to simulate data transfer but must have random ping intervals.   |   |
| c) | Timing plots are required with calculations demonstrating a minimum channel loading of approximately 17% or greater.  | ✓ |
| d) | Unicast or Multicast protocols are preferable but other protocols may be used. The appropriate protocol used must be described in the test procedures.                  |   |



## 4.2 CALIBRATION OF DFS DETECTION THRESHOLD LEVEL:

The measured channel is 5300MHz and 5500 MHz in 20MHz Bandwidth, 5290MHz and 5530MHz in 80MHz Bandwidth. The radar signal was the same as transmitted channels, and injected into the antenna port of AP (master) or Client Device with Radar Detection, measured the channel closing transmission time and channel move time. The Master maximum transmit power was more than 200mW. The Master antenna gain is 3dBi and required detection threshold is -61dBm ( $=-64+3$ )dBm.

Conducted setup configuration of calibration of DFS detection threshold level:

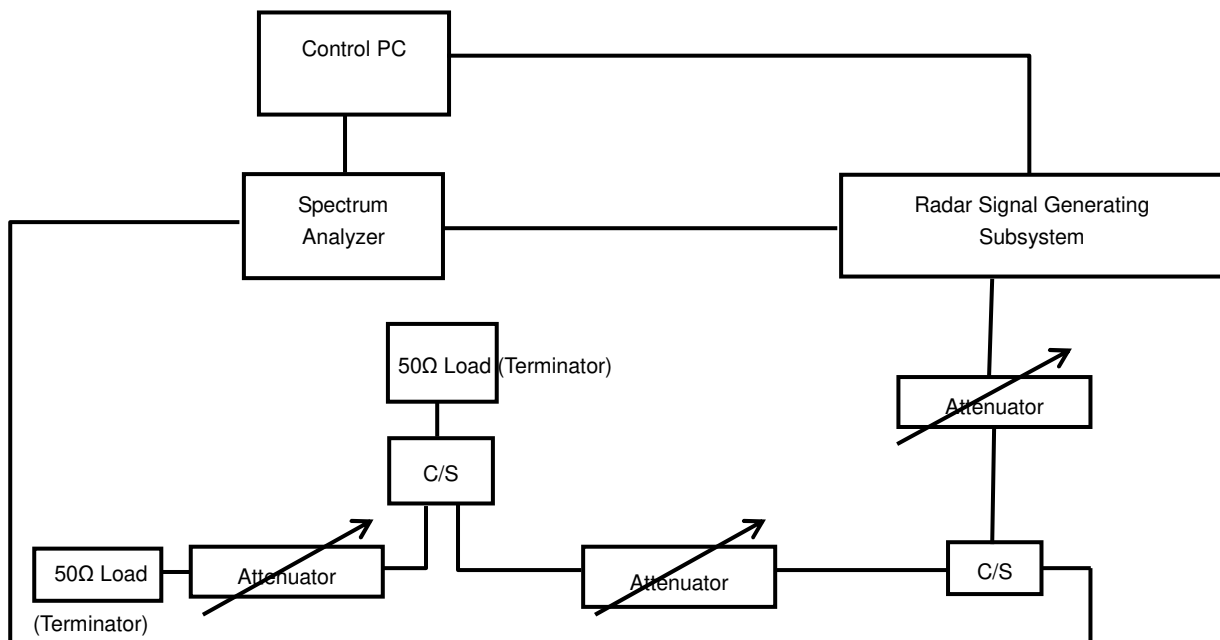



### 4.3 DEVIATION FROM TEST STANDARD

No deviation.

### 4.4 CONDUCTED TEST SETUP CONFIGURATION

#### 4.4.1 CLIENT WITHOUT RADAR DETECTION MODE

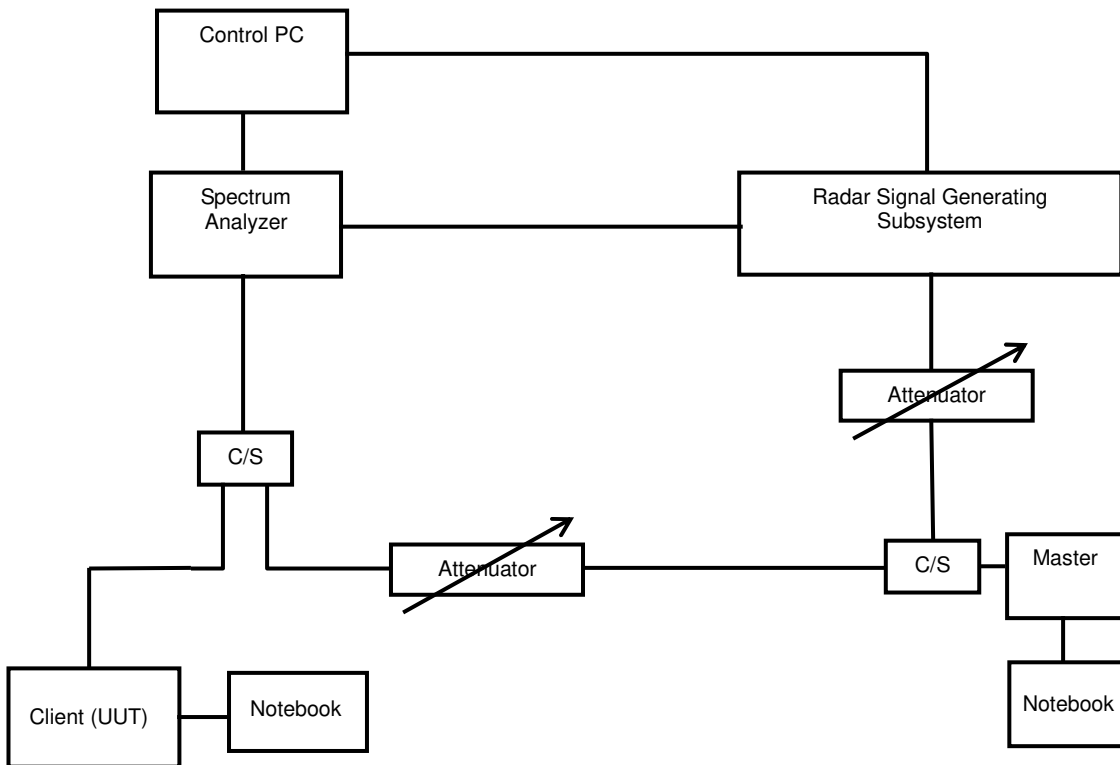

The UUT is a U-NII Device operating in Client mode without radar detection. The radar test signals are injected into the Master Device.



## 5 TEST RESULTS

### 5.1 SUMMARY OF TEST RESULTS

| CLAUSE | TEST PARAMETER                    | REMARKS        | PASS/FAIL |
|--------|-----------------------------------|----------------|-----------|
| 15.407 | DFS Detection Threshold           | Not Applicable | N/A       |
| 15.407 | Channel Availability Check Time   | Not Applicable | N/A       |
| 15.407 | Channel Move Time                 | Applicable     | Pass      |
| 15.407 | Channel Closing Transmission Time | Applicable     | Pass      |
| 15.407 | Non- Occupancy Period             | Applicable     | Pass      |
| 15.407 | Uniform Spreading                 | Not Applicable | N/A       |
| 15.407 | U-NII Detection Bandwidth         | Not Applicable | N/A       |
| 15.407 | Non-associated test               | Applicable     | Pass      |
| 15.407 | Non-Co-Channel test               | Applicable     | Pass      |

Note: Therefore test procedure were completed by KDB 905462

### 5.2 DETAILED TEST RESULTS

#### 5.2.1 TEST MODE: DEVICE OPERATING IN CLIENT WITHOUT RADAR DETECTION MODE

The radar test signals are injected into the Master Device.

This test was investigated for different bandwidth (20MHz,80MHz). The following plots was done on 80MHz as a representative



### 5.2.2 DFS DETECTION THRESHOLD

The Required detection threshold is  $-61.00\text{dBm} = -64 + 3\text{dBi}$ . The conducted radar burst level is set to  $-61.21\text{dBm}$ .

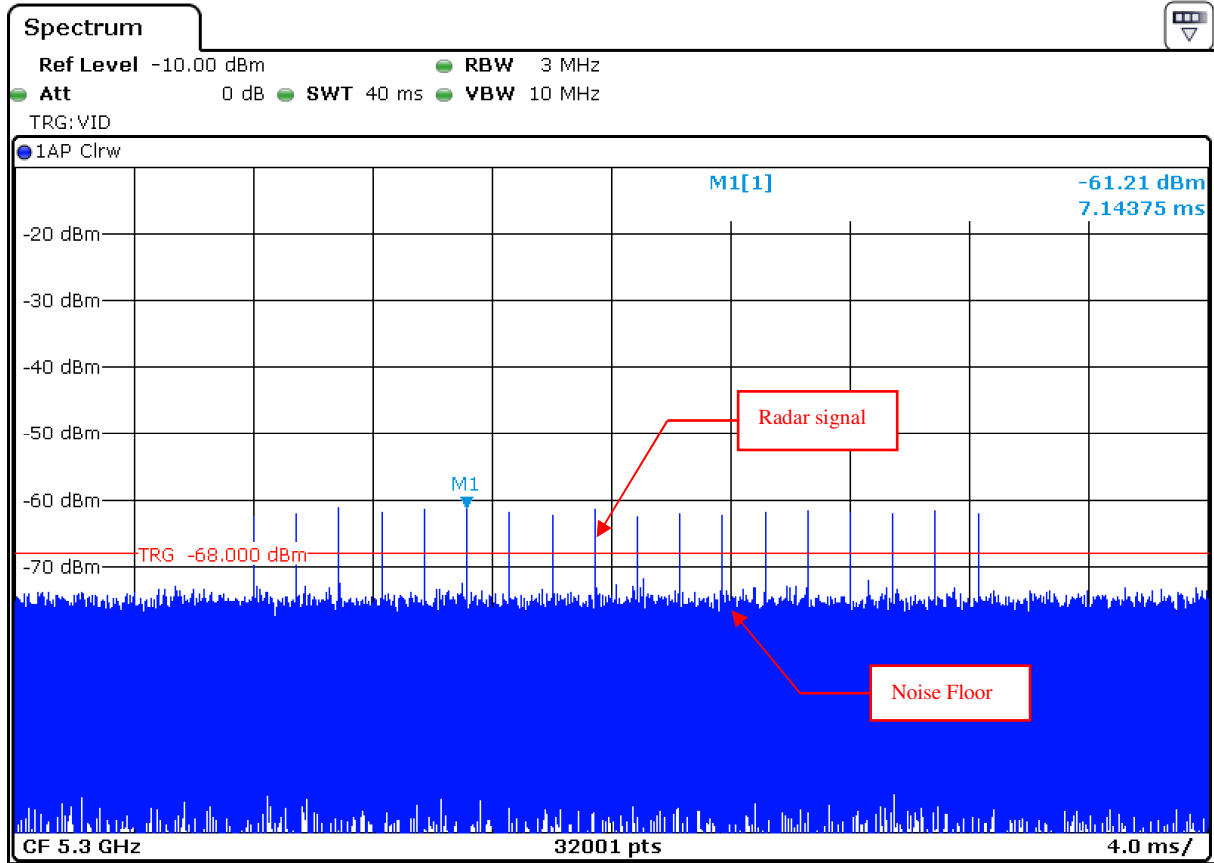

Radar Signal (Type 0)





### 5.2.3 CHANNEL LOADING

The measured channel is 5300MHz and 5500MHz in 20MHz Bandwidth and 5290MHz and 5530MHz in 80MHz Bandwidth. The radar signal was the same as transmitted channels, and injected into the antenna port of AP (master) with radar signal, measured the channel shutdown. The slave transmitted the test data to master, the transmitted duty cycle is 26.64%.

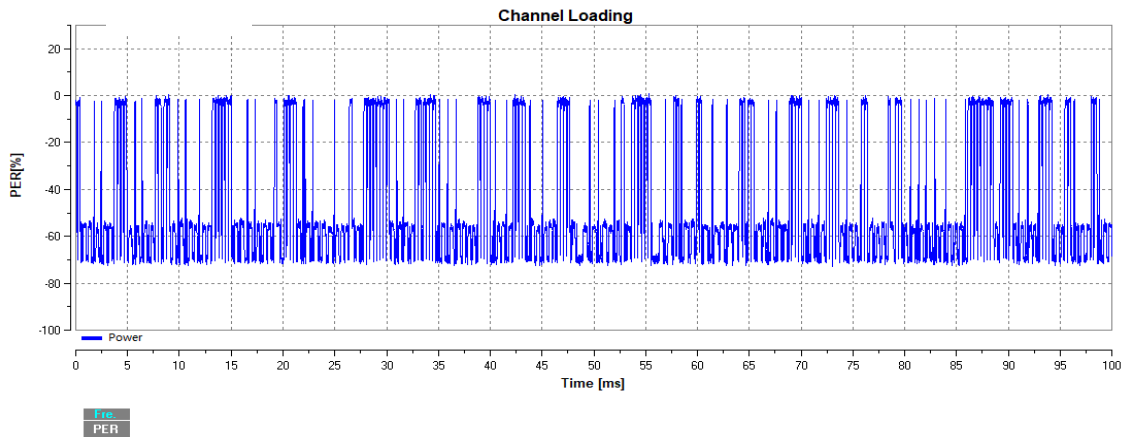

**NOTE:** Traffic signal: from slave transmit to master. Measured over an interval of 100 ms.



### 5.2.4 CHANNEL CLOSING TRANSMISSION AND CHANNEL MOVE TIME

#### Radar Signal 0

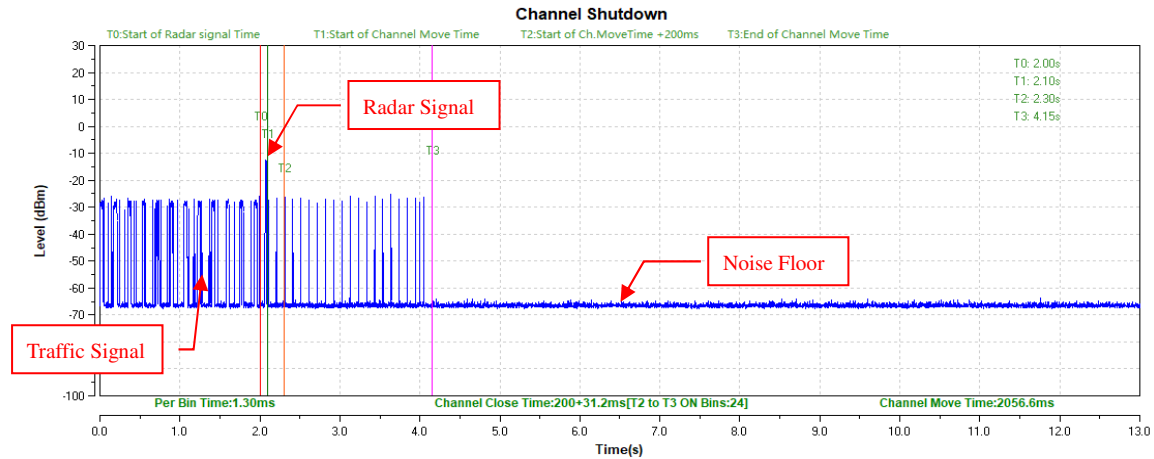

**NOTE:** T1 denotes the start of Channel Move Time upon the end of the last Radar burst. T2 denotes the data transmission time of 200ms from T1. T3 denotes the end of Channel Move Time.

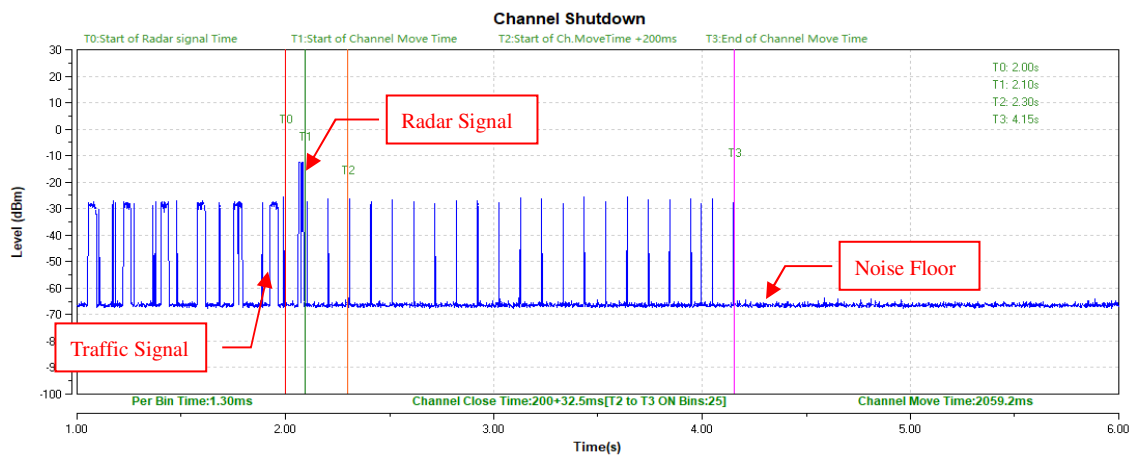

**NOTE:** Zoom in of the first 4000ms after radar signal applied.



### 5.2.5 NON- OCCUPANCY PERIOD

#### ASSOCIATED TEST

1) Test results demonstrating an associated client link is established with the master on a test frequency.

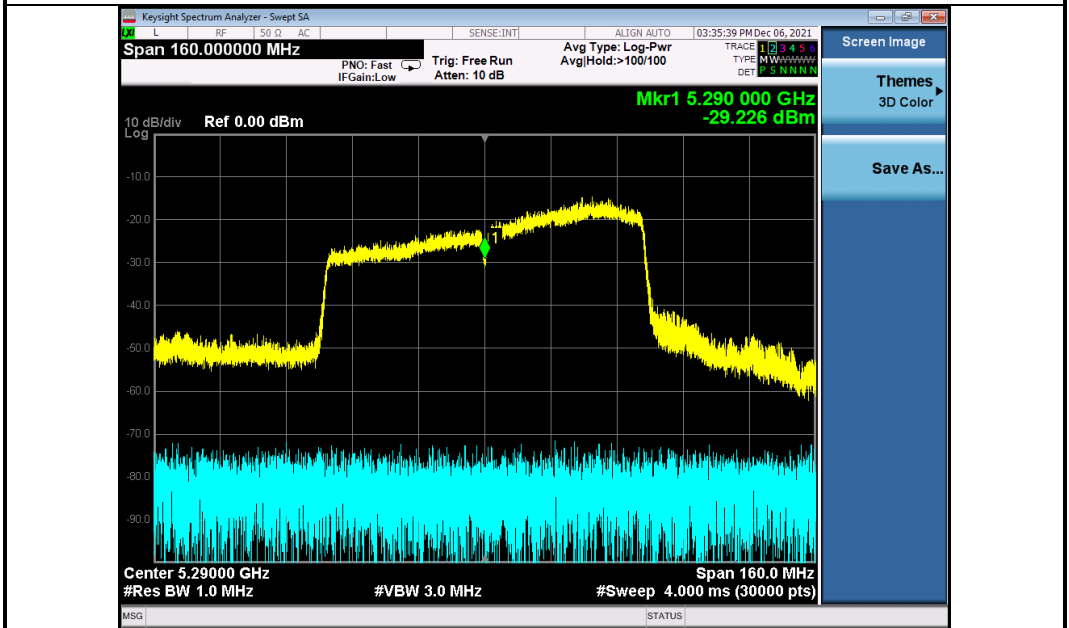

**EUT (Client ) links with master on 5290MHz**

2) The client and DFS-certified master device are associated, and system testing will be performed with channel-loading for a non-occupancy period test.

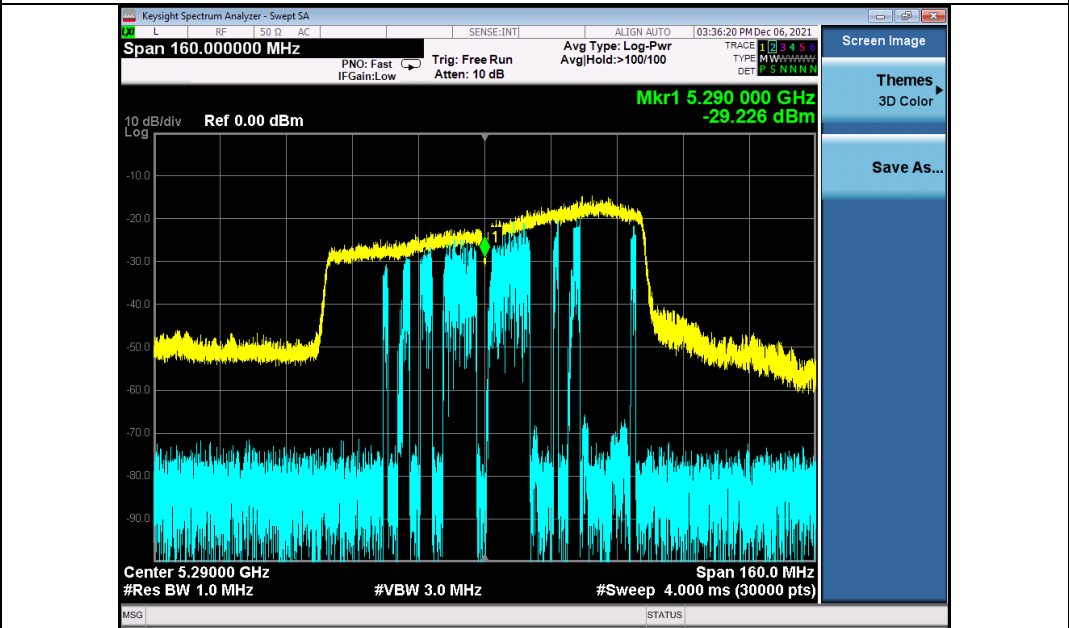

**Client performed with channel-loading via master.**



3). The device transmits one type of radar as specified in the DFS Order.

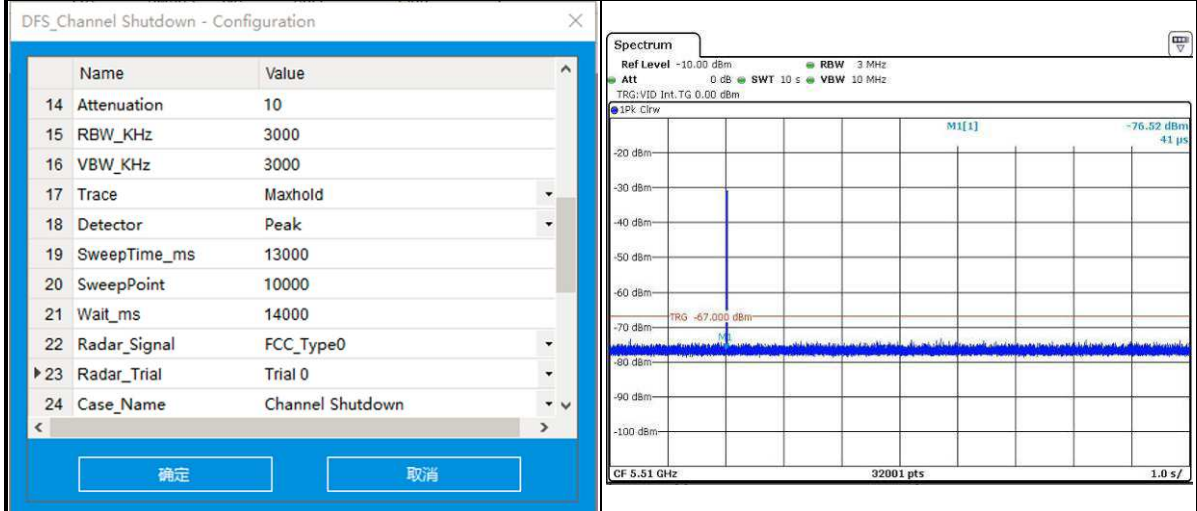

**Radar Signal (Type 0) is used to test during DFS testing.**

4) The test frequency has been monitored to ensure no transmission of any type has occurred for 30 minutes;

Note: If the client moves with the master, the device is considered compliant if nothing appears in the client non-occupancy period test. For devices that shut down (rather than moving channels), no beacons should appear;

5) An analyzer plot that contains a single 30-minute sweep on the original test frequency.

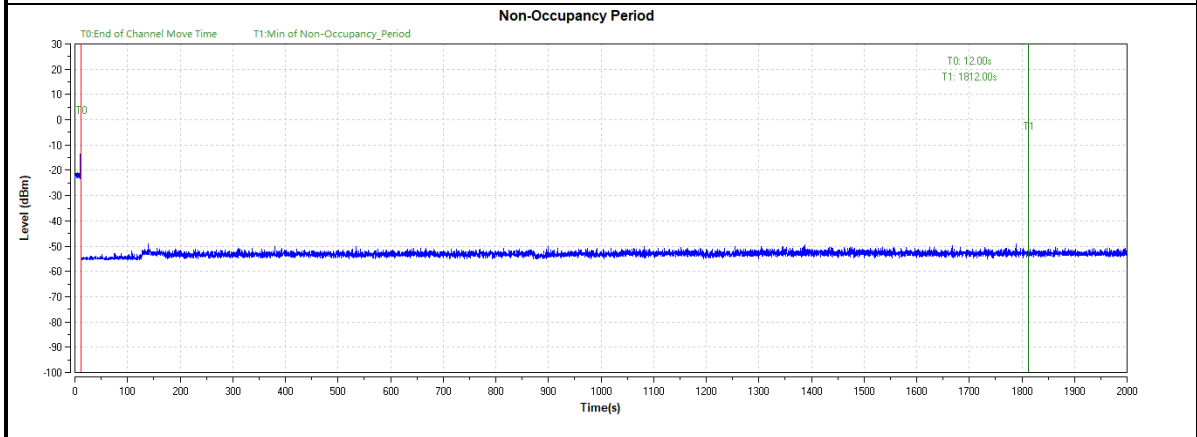



### 5.2.6 NON-ASSOCIATED TEST

Master was off.

During the 30 minutes observation time, The UUT did not make any transmissions in the DFS band after UUT power up.

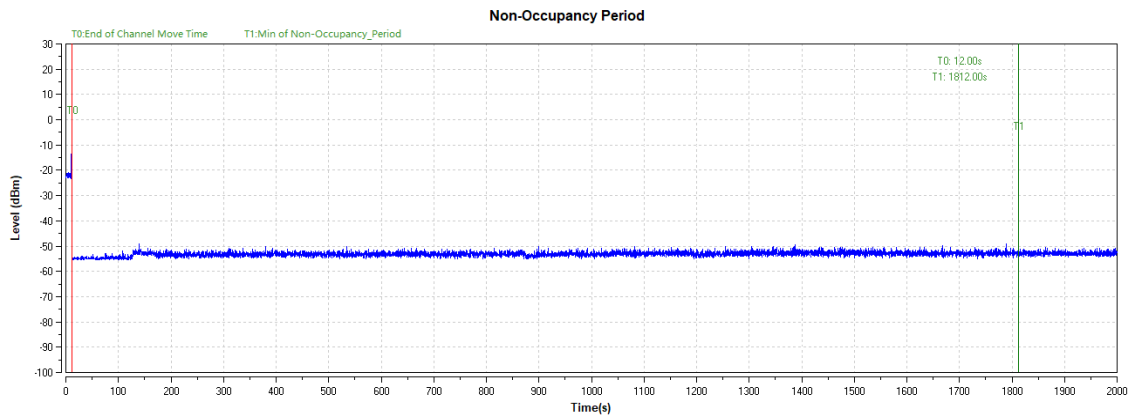

### 5.2.7 NON- CO-CHANNEL TEST

The UUT was investigated after radar was detected the channel and made sure no co-channel operation with radars.



**BUREAU  
VERITAS**

Test Report No.: RF2109WDG0104-3

## 6 PHOTOGRAPHS OF THE TEST CONFIGURATION

Please refer to the attached file (Test Setup Photo).



**BUREAU  
VERITAS**

Test Report No.: RF2109WDG0104-3

## **7 APPENDIX A - Modifications recorders for engineering changes to the EUT BY THE LAB**

No any modifications are made to the EUT by the lab during the test.

**---END---**