

# FCC RF Test Report

**APPLICANT** : BenQ Corporation  
**EQUIPMENT** : Mobile Internet Device (MID)  
**BRAND NAME** : BenQ  
**MODEL NAME** : S6  
**FCC ID** : JVPS6  
**STANDARD** : FCC Part 15 Subpart C §15.247  
**CLASSIFICATION** : Digital Transmission System (DTS)

The product was received on Jul. 08, 2009 and completely tested on Jul. 15, 2009. We, SPORTON INTERNATIONAL INC., would like to declare that the tested sample has been evaluated in accordance with the procedures given in ANSI C63.4-2003 and shown the compliance with the applicable technical standards.

The test results in this report apply exclusively to the tested model / sample. Without written approval of SPORTON INTERNATIONAL INC., the test report shall not be reproduced except in full.

Reviewed by:



Roy Wu / Manager



## **SPORTON INTERNATIONAL INC.**

**No. 52, Hwa Ya 1<sup>st</sup> Rd., Hwa Ya Technology Park, Kwei-Shan Hsiang, Tao Yuan Hsien, Taiwan, R.O.C.**



# TABLE OF CONTENTS

**REVISION HISTORY ..... 3**

**SUMMARY OF TEST RESULT ..... 4**

**1 GENERAL DESCRIPTION ..... 5**

    1.1 Applicant ..... 5

    1.2 Manufacturer ..... 5

    1.3 Feature of Equipment Under Test ..... 5

    1.4 Testing Site ..... 6

    1.5 Applied Standards ..... 6

    1.6 Ancillary Equipment List ..... 7

**2 TEST CONFIGURATION OF EQUIPMENT UNDER TEST ..... 8**

    2.1 Pre-Scanned RF Power ..... 8

    2.2 Test Mode ..... 9

    2.3 Connection Diagram of Test System ..... 10

    2.4 RF Utility ..... 10

**3 TEST RESULT ..... 11**

    3.1 6dB Bandwidth Measurement ..... 11

    3.2 Output Power Measurement ..... 16

    3.3 Band Edges Measurement ..... 21

    3.4 Spurious Emission Measurement ..... 26

    3.5 Power Spectral Density Measurement ..... 33

    3.6 AC Conducted Emission Measurement ..... 38

    3.7 Radiated Emission Measurement ..... 42

    3.8 Antenna Requirements ..... 57

**4 LIST OF MEASURING EQUIPMENT ..... 58**

**5 UNCERTAINTY OF EVALUATION ..... 59**

**6 CERTIFICATION OF TAF ACCREDITATION ..... 61**

**APPENDIX A. PHOTOGRAPHS OF EUT**

**APPENDIX B. SETUP PHOTOGRAPHS**



**SUMMARY OF TEST RESULT**

| Report Section | FCC Rule              | IC Rule   | Description                   | Limit                    | Result | Remark                                   |
|----------------|-----------------------|-----------|-------------------------------|--------------------------|--------|--|
| 3.1            | 15.247(a)(2)          | A8.2(a)   | 6dB Bandwidth                 | $\geq 0.5\text{MHz}$     | Pass   | -  |
| 3.2            | 15.247(b)             | A8.4      | Power Output                  | $\leq 30\text{dBm}$      | Pass   | -  |
| 3.3            | 15.247(d)             | A8.5      | Frequency Band Edges          | $\leq 20\text{dBc}$      | Pass   | -  |
| 3.4            | 15.247(d)             | A8.5      | Spurious Emission             | $< 20\text{ dBc}$        | Pass   | -  |
| 3.5            | 15.247(e)             | A8.2(b)   | Power Spectral Density        | $\leq 8\text{dBm}$       | Pass   | -  |
| 3.6            | 15.207                | Gen 7.2.2 | AC Conducted Emission         | 15.207(a)                | Pass   | Under limit<br>18.3 dB at<br>0.166 MHz   |
| 3.7            | 15.247(d)             | A8.5      | Transmitter Radiated Emission | 15.209(a) &<br>15.247(d) | Pass   | Under limit<br>6.51 dB at<br>2389.99 MHz |
| 3.8            | 15.203 &<br>15.247(b) | A8.4      | Antenna Requirement           | N/A                      | Pass   | -  |

# 1 General Description

## 1.1 Applicant

**BenQ Corporation**

No. 16, Jihu Road, Neihu, Taipei 114, Taiwan

## 1.2 Manufacturer

**BenQ Corporation**

No. 16, Jihu Road, Neihu, Taipei 114, Taiwan

## 1.3 Feature of Equipment Under Test

| Product Feature & Specification          |  |
|--|--|
| <b>Equipment</b>                         | Mobile Internet Device (MID)   |
| <b>Brand Name</b>                        | BenQ   |
| <b>Model Name</b>                        | S6   |
| <b>FCC ID</b>                            | JVPS6  |
| <b>Tx/Rx Frequency Range</b>             | 2400 MHz ~ 2483.5 MHz  |
| <b>Number of Channels</b>                | 11   |
| <b>Carrier Frequency of Each Channel</b> | $2412+(n-1)*5$ MHz; n=1~11   |
| <b>Channel Spacing</b>                   | 5 MHz  |
| <b>Maximum Output Power to Antenna</b>   | 802.11b: 16.94 dBm (49.43 mW)<br>802.11g : 13.13 dBm (20.56 mW)                    |
| <b>Antenna Type</b>                      | PIFA Antenna with gain -2 dBi  |
| <b>Type of Modulation</b>                | 802.11b : DSSS (BPSK / QPSK / CCK)<br>802.11g : OFDM (BPSK / QPSK / 16QAM / 64QAM) |
| <b>EUT Stage</b>                         | Production Unit  |

**Remark:**

1. For other wireless features of this EUT, test report will be issued separately.
2. This test report recorded only product characteristics and test results of Digital Transmission System (DTS).

**List of Accessory:**

| Specification of Accessory |                           |  |
|----------------------------|---------------------------|--|
| <b>AC Adapter</b>          | <b>Brand Name</b>         | BenQ   |
|                            | <b>Model Name</b>         | PA-1360-02   |
|                            | <b>Power Rating</b>       | I/P:100-240Vac, 50-60Hz, 1.0A;<br>O/P: 12Vdc, 3.0A |
|                            | <b>AC Power Cord Type</b> | 1.8 meter shielded cable with ferrite core         |
| <b>Battery</b>             | <b>Brand Name</b>         | BenQ   |
|                            | <b>Model Name</b>         | 2C.20Y29.001                                       |
|                            | <b>Power Rating</b>       | 12Vdc, 2800mAh                                     |
|                            | <b>Type</b>               | Li-ion   |
| <b>Earphone</b>            | <b>Signal Line Type</b>   | 1.4 meter non-shielded cable without ferrite core  |

**Remark:**

1. The above EUT's information was declared by manufacturer. Please refer to the specifications or user's manual for more detailed description.
2. For accessories equipped with this EUT, please refer to the appendix of the external photo.

## 1.4 Testing Site

|                           |  |          |                                |
|---------------------------|--|----------|--------------------------------|
| <b>Test Site</b>          | SPORTON INTERNATIONAL INC.   |          |                                |
| <b>Test Site Location</b> | No. 52, Hwa Ya 1 <sup>st</sup> Rd., Hwa Ya Technology Park,<br>Kwei-Shan Hsiang, Tao Yuan Hsien, Taiwan, R.O.C.<br>TEL: +886-3-3273456 / FAX: +886-3-3284978 |          |                                |
| <b>Test Site No.</b>      | <b>Sporton Site No.</b>  |          | <b>FCC/IC Registration No.</b> |
|                           | CO05-HY  | 03CH07HY | TW1022/4086B-1                 |

## 1.5 Applied Standards

According to the specifications of the manufacturer, the EUT must comply with the requirements of the following standards:

- FCC Part 15 Subpart C §15.247
- FCC KDB Publication No. 558074 (Measurement Guidelines of DTS)
- ANSI C63.4-2003
- IC RSS-210 Issue 7

**Remark:**

1. All test items were verified and recorded according to the standards and without any deviation during the test.
2. This EUT has also been tested and complied with the requirements of FCC Part 15, Subpart B (DoC), recorded in a separate test report.



### 1.6 Ancillary Equipment List

| Item | Equipment          | Trade Name | Model Name | FCC ID          | Data Cable      | Power Cord        |
|------|--------------------|------------|------------|-----------------|-----------------|-------------------|
| 1.   | WLAN AP            | D-Link     | DWL-7100AP | KA22003040018-1 | N/A             | Unshielded, 1.8 m |
| 2.   | Bluetooth Earphone | Nokia      | BH-100     | PYA1YH          | N/A             | N/A               |
| 3.   | i-pod              | Apple      | A1285      | FCC DoC         | Shielded, 1.0 m | N/A               |

## 2 Test Configuration of Equipment Under Test

### 2.1 Pre-Scanned RF Power

Preliminary tests were performed in different data rate and recorded the RF power output in the following table:

| 802.11b Pre-Scanned RF Power (dBm) |                 |              |        |          |         |
|------------------------------------|-----------------|--------------|--------|----------|---------|
| Channel                            | Frequency (MHz) | Data Rate    |        |          |         |
|                                    |                 | 1 Mbps       | 2 Mbps | 5.5 Mbps | 11 Mbps |
| CH 01                              | 2412 MHz        | 13.36        | 13.45  | 13.95    | 14.44   |
| CH 06                              | 2437 MHz        | 14.37        | 15.32  | 15.55    | 15.58   |
| CH 11                              | 2462 MHz        | <b>15.96</b> | 15.35  | 15.73    | 15.90   |

| 802.11g Pre-Scanned RF Power (dBm) |                 |              |        |         |         |         |         |         |         |
|------------------------------------|-----------------|--------------|--------|---------|---------|---------|---------|---------|---------|
| Channel                            | Frequency (MHz) | Data Rate    |        |         |         |         |         |         |         |
|                                    |                 | 6 Mbps       | 9 Mbps | 12 Mbps | 18 Mbps | 24 Mbps | 36 Mbps | 48 Mbps | 54 Mbps |
| CH 01                              | 2412 MHz        | 11.96        | 11.75  | 11.69   | 12.00   | 12.12   | 12.25   | 12.03   | 12.22   |
| CH 06                              | 2437 MHz        | <b>12.39</b> | 12.32  | 11.56   | 11.58   | 12.10   | 12.22   | 11.95   | 11.83   |
| CH 11                              | 2462 MHz        | 11.08        | 11.52  | 11.51   | 11.85   | 11.81   | 11.86   | 12.00   | 11.75   |

**Remark:**

1. For WLAN RF power, the pre-scanned RF power was measured by power meter.
2. The 802.11b data rates were set in 1 Mbps and 802.11g data rates were set in 6 Mbps for all the test cases, due to the highest RF output power.
3. The EUT is programmed to transmit signals continuously for all testing.





## 2.2 Test Mode

The EUT has been associated with peripherals pursuant to ANSI C63.4-2003 and configuration operated in a manner tended to maximize its emission characteristics in a typical application. Frequency range investigated: conducted emission (150 kHz to 30 MHz), radiated emission (30 MHz to the 10th harmonic of the highest fundamental frequency or to 40 GHz, whichever is lower). Pre-scanned tests were conducted to determine the final configuration from all possible combinations. The following tables are showing the test modes as the worst cases and recorded in this report.

| Test Cases            |  |                        |
|-----------------------|--|------------------------|
| Test Item             | 802.11b  | 802.11g                |
| Conducted TCs         | Mode 1 : CH01_2412 MHz   | Mode 4 : CH01_2412 MHz |
|                       | Mode 2 : CH06_2437 MHz   | Mode 5 : CH06_2437 MHz |
|                       | Mode 3 : CH11_2462 MHz   | Mode 6 : CH11_2462 MHz |
| Radiated TCs          | Mode 1 : CH01_2412 MHz   | Mode 4 : CH01_2412 MHz |
|                       | Mode 2 : CH06_2437 MHz   | Mode 5 : CH06_2437 MHz |
|                       | Mode 3 : CH11_2462 MHz   | Mode 6 : CH11_2462 MHz |
| AC Conducted Emission | Mode 1 : Bluetooth Link + WLAN Link + Earphone + USB Cable (Link with i-pod) + Adapter |                        |

## 2.3 Connection Diagram of Test System

### <Conducted Emission>

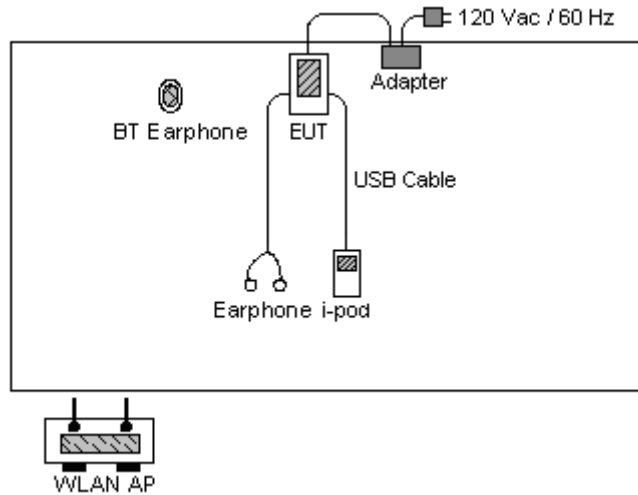

### <Radiated Emission>

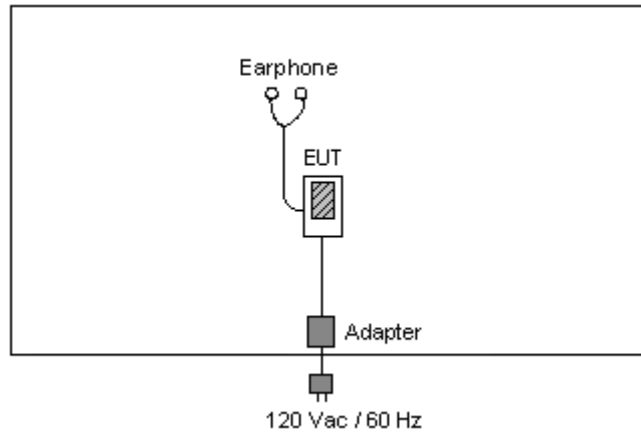

## 2.4 RF Utility

For WLAN function, executed "Wifi Test" to make the EUT transmit and receive signals continuously.

### 3 Test Result

#### 3.1 6dB Bandwidth Measurement

##### 3.1.1 Limit of 6dB Bandwidth

The minimum 6 dB bandwidth shall be at least 500 kHz.

##### 3.1.2 Measuring Instruments

See list of measuring instruments of this test report.

##### 3.1.3 Test Procedures

1. The testing follows FCC KDB Publication No. 558074 (Measurement Guidelines of DTS).
2. The RF output of EUT was connected to the spectrum analyzer by a low loss cable.
3. Make the measurement with the spectrum analyzer's resolution bandwidth (RBW) = 100 kHz.  
In order to make an accurate measurement, set the span greater than RBW. The 6 dB bandwidth must be greater than 500 kHz.
4. The marker-delta reading at this point is the 6 dB bandwidth of the emission.

##### 3.1.4 Test Setup

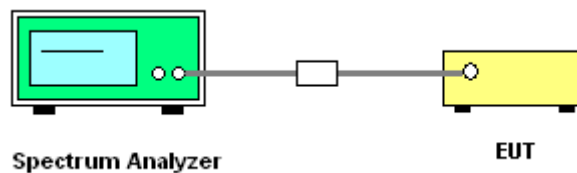



3.1.5 Test Result of 6dB Bandwidth

|                 |              |                     |         |
|-----------------|--------------|---------------------|---------|
| Test Mode :     | Mode 1, 2, 3 | Temperature :       | 23~24°C |
| Test Engineer : | Eric Huang   | Relative Humidity : | 42~43%  |

| Channel | Frequency (MHz) | 802.11b 6dB Bandwidth (MHz) | 6dB Bandwidth Min. Limit (MHz) | Pass/Fail |
|---------|-----------------|-----------------------------|--------------------------------|-----------|
| 01      | 2412            | 10.080                      | 0.5                            | Pass      |
| 06      | 2437            | 10.080                      | 0.5                            | Pass      |
| 11      | 2462            | 10.080                      | 0.5                            | Pass      |

Mode 1 : 6 dB Bandwidth Plot on 802.11b Channel 01

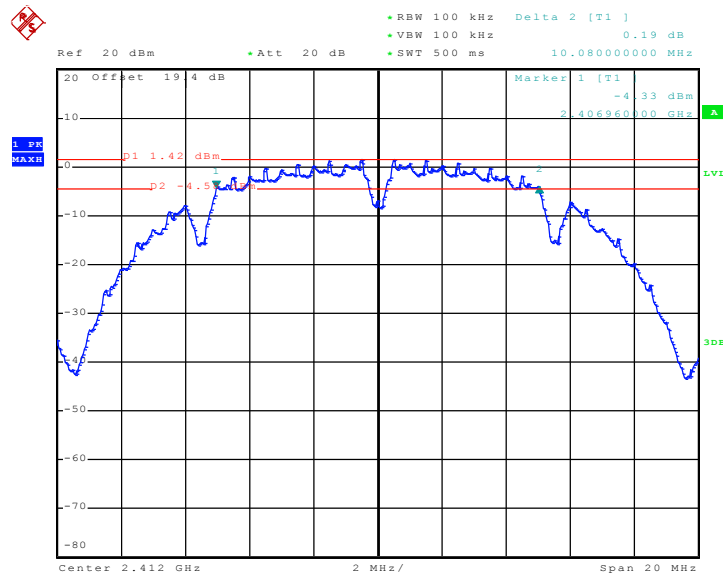

Date: 4..JUN.2009 18:22:49



Mode 2 : 6 dB Bandwidth Plot on 802.11b Channel 06

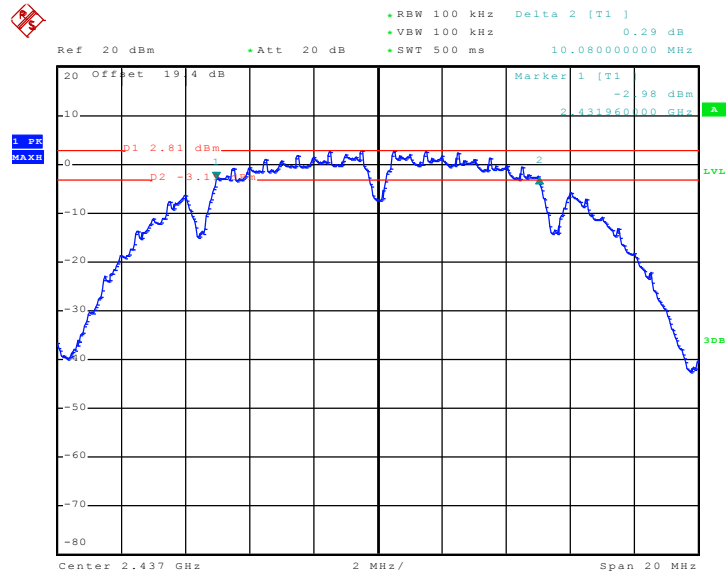

Date: 4.JUN.2009 18:23:55

Mode 3 : 6 dB Bandwidth Plot on 802.11b Channel 11

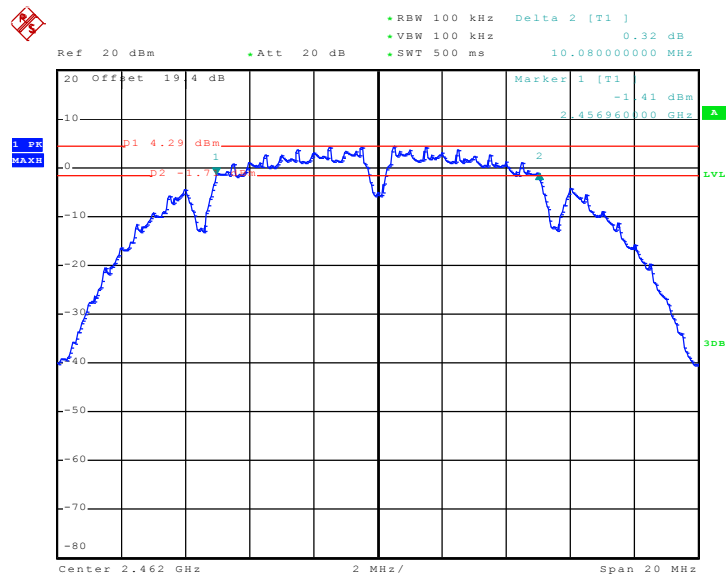

Date: 4.JUN.2009 18:25:17



|                 |              |                     |         |
|-----------------|--------------|---------------------|---------|
| Test Mode :     | Mode 4, 5, 6 | Temperature :       | 23~24°C |
| Test Engineer : | Eric Huang   | Relative Humidity : | 42~43%  |

| Channel | Frequency (MHz) | 802.11g<br>6dB Bandwidth (MHz) | 6dB Bandwidth<br>Min. Limit (MHz) | Pass/Fail |
|---------|-----------------|--------------------------------|-----------------------------------|-----------|
| 01      | 2412            | 16.560                         | 0.5                               | Pass      |
| 06      | 2437            | 16.560                         | 0.5                               | Pass      |
| 11      | 2462            | 16.560                         | 0.5                               | Pass      |

Mode 4 : 6 dB Bandwidth Plot on 802.11g Channel 01

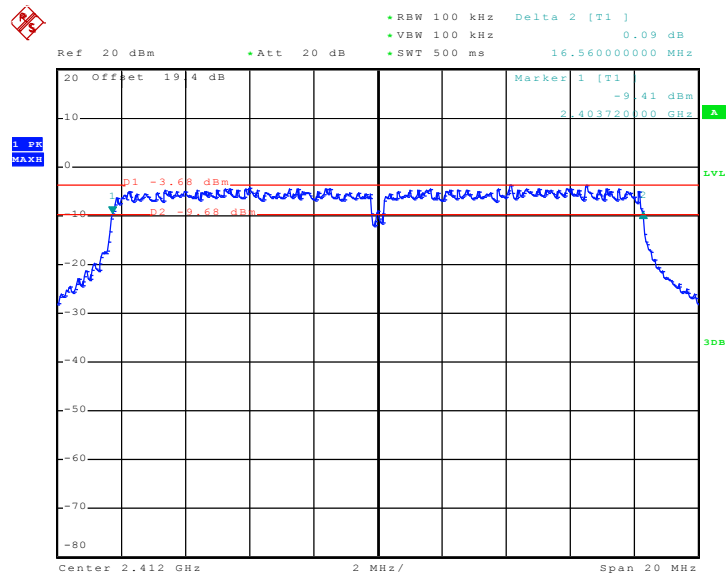

Date: 4..JUN.2009 18:27:08



Mode 5 : 6 dB Bandwidth Plot on 802.11g Channel 06

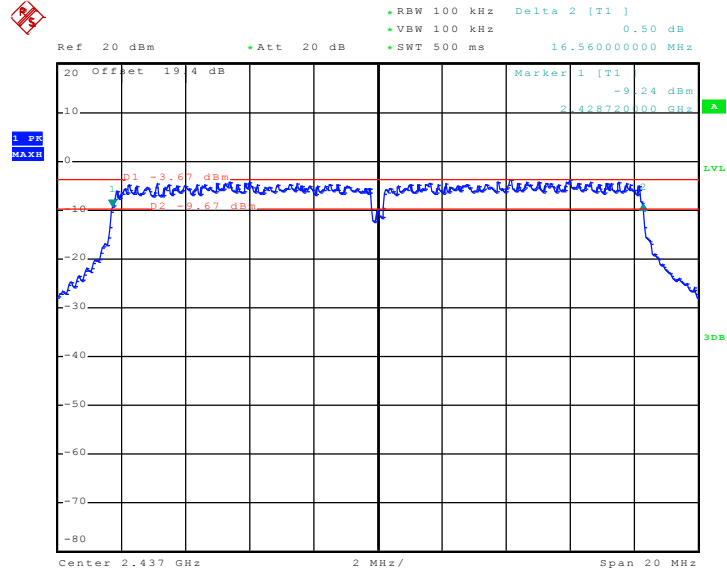

Date: 4.JUN.2009 18:28:07

Mode 6 : 6 dB Bandwidth Plot on 802.11g Channel 11

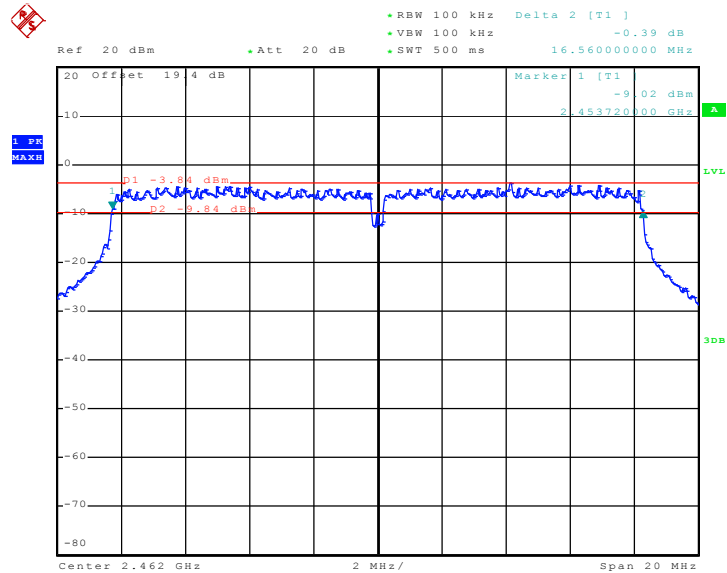

Date: 4.JUN.2009 18:29:10

## 3.2 Output Power Measurement

### 3.2.1 Limit of Output Power

For systems using digital modulation in the 2400-2483.5MHz, the limit for peak output power is 30dBm. If transmitting antenna of directional gain greater than 6dBi are used the peak output power from the intentional radiator shall be reduced below the above stated value by the amount in dB that the directional gain of the antenna exceeds 6 dBi. In case of point-to-point operation, the limit has to be reduced by 1dB for every 3dB that the directional gain of the antenna exceeds 6dBi.

### 3.2.2 Measuring Instruments

See list of measuring instruments of this test report.

### 3.2.3 Test Procedures

1. The testing follows FCC KDB Publication No. 558074 (Measurement Guidelines of DTS).
2. The RF output of EUT was connected to the spectrum analyzer by a low loss cable.
3. Measure the power by spectrum analyzer.

### 3.2.4 Test Setup

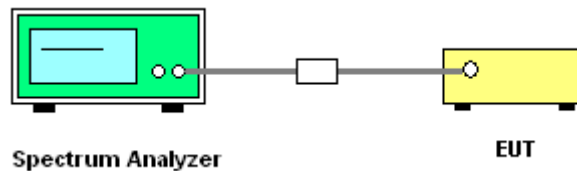





### 3.2.5 Test Result of Output Power

|                 |              |                     |         |
|-----------------|--------------|---------------------|---------|
| Test Mode :     | Mode 1, 2, 3 | Temperature :       | 23~24°C |
| Test Engineer : | Eric Huang   | Relative Humidity : | 42~43%  |

| Channel | Frequency (MHz) | 802.11b Measured Output Power (dBm) | Max. Limits (dBm) | Pass/Fail |
|---------|-----------------|-------------------------------------|-------------------|-----------|
| 01      | 2412            | 12.95                               | 30                | Pass      |
| 06      | 2437            | 15.24                               | 30                | Pass      |
| 11      | 2462            | 16.94                               | 30                | Pass      |

Mode 1 : Output Power Plot on 802.11b Channel 01

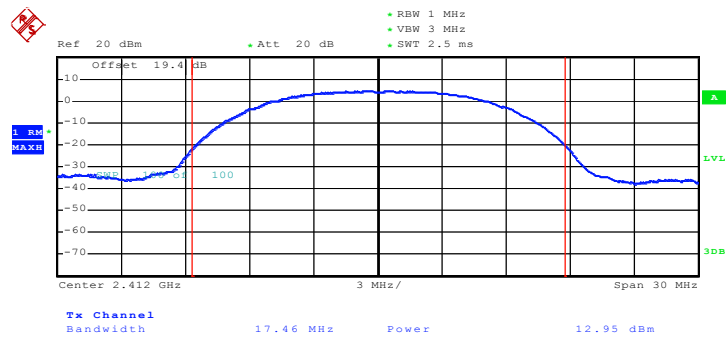

Date: 4.JUN.2009 20:08:31



Mode 2 : Output Power Plot on 802.11b Channel 06

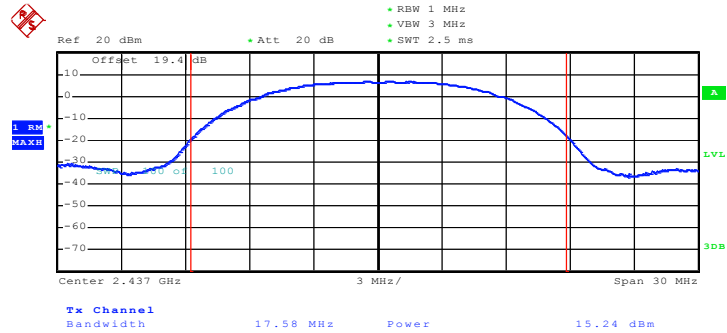

Date: 4.JUN.2009 20:09:23

Mode 3 : Output Power Plot on 802.11b Channel 11

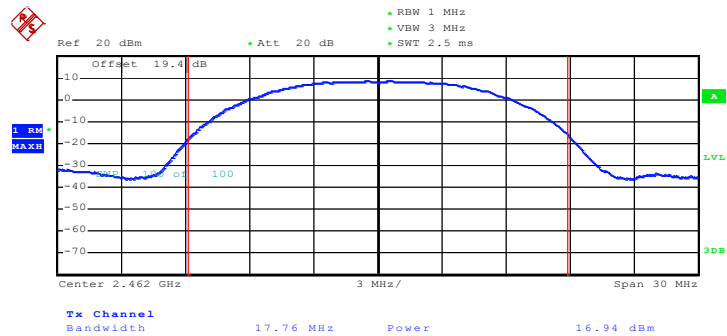

Date: 4.JUN.2009 20:10:22



|                 |              |                     |         |
|-----------------|--------------|---------------------|---------|
| Test Mode :     | Mode 4, 5, 6 | Temperature :       | 23~24°C |
| Test Engineer : | Eric Huang   | Relative Humidity : | 42~43%  |

| Channel | Frequency (MHz) | 802.11g Measured Output Power (dBm) | Max. Limits (dBm) | Pass/Fail |
|---------|-----------------|-------------------------------------|-------------------|-----------|
| 01      | 2412            | 13.05                               | 30                | Pass      |
| 06      | 2437            | 13.13                               | 30                | Pass      |
| 11      | 2462            | 12.61                               | 30                | Pass      |

Mode 4 : Output Power Plot on 802.11g Channel 01

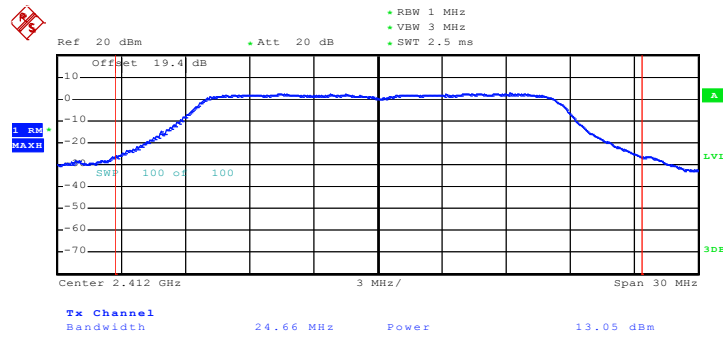

Date: 4..JUN.2009 20:11:16



Mode 5 : Output Power Plot on 802.11g Channel 06

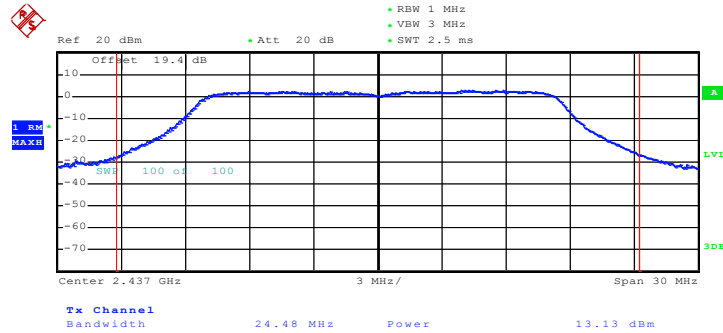

Date: 4.JUN.2009 20:12:35

Mode 6 : Output Power Plot on 802.11g Channel 11

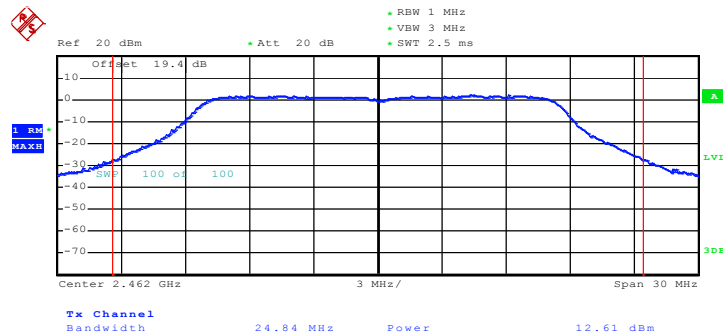

Date: 4.JUN.2009 20:13:27

### 3.3 Band Edges Measurement

#### 3.3.1 Limit of Band Edges

In any 100 kHz bandwidth outside the intentional radiation frequency band, the radio frequency power shall be at least 20 dB below the highest level of the radiated power. If the output power of this device was measured by spectrum analyzer, the attenuation under this paragraph shall be 30 dB instead of 20 dB.

#### 3.3.2 Measuring Instruments

See list of measuring instruments of this test report.

#### 3.3.3 Test Procedures

1. The testing follows the guidelines in ANSI C63.4-2003 and FCC KDB Publication No. 558074 (Measurement Guidelines of DTS).
2. Conducted emission test: Set RBW = 100 kHz, Video bandwidth (VBW) > RBW, scan up through 10th harmonic. Band edge emissions must be at least 20 dB below the highest emission level within the authorized band as measured with a 100 kHz RBW. Note: If the output power of this device was measured by power meter, the attenuation under this paragraph shall be 30 dB instead of 20 dB.
3. Radiated emission test: Apply to band edge emissions that fall in the restricted bands listed in FCC Section 15.205. The maximum permitted average field strength is listed in FCC Section 15.209. A pre-amp is necessary for this measurement. For measurements above 1 GHz, set RBW = 1MHz, VBW = 10 Hz, Sweep=Auto. If the emission is pulsed, modify the unit for continuous operation; use the settings shown above, then correct the reading by subtracting the peak-average correction factor, derived from the appropriate duty cycle calculation as in FCC Section 15.35(b) and (c).

#### 3.3.4 Test Setup

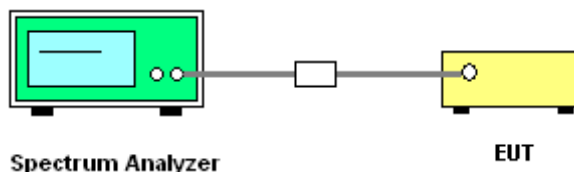



3.3.5 Test Result of Radiated Band Edges

|                |         |                     |         |
|----------------|---------|---------------------|---------|
| Test Mode :    | Mode 1  | Temperature :       | 27~28°C |
| Test Band :    | 802.11b | Relative Humidity : | 40~41%  |
| Test Channel : | 01      | Test Engineer :     | Kay Wu  |

| ANTENNA POLARITY : HORIZONTAL |                  |                   |                       |                     |                       |                   |                      |                |                   |         |
|-------------------------------|------------------|-------------------|-----------------------|---------------------|-----------------------|-------------------|----------------------|----------------|-------------------|---------|
| Frequency ( MHz )             | Level ( dBuV/m ) | Over Limit ( dB ) | Limit Line ( dBuV/m ) | Read Level ( dBuV ) | Antenna Factor ( dB ) | Cable Loss ( dB ) | Preamp Factor ( dB ) | Ant Pos ( cm ) | Table Pos ( deg ) | Remark  |
| 2389.61                       | 57.29            | -16.71            | 74.00                 | 54.20               | 32.02                 | 5.46              | 34.38                | 168            | 190               | Peak    |
| 2389.61                       | 39.73            | -14.27            | 54.00                 | 36.64               | 32.02                 | 5.46              | 34.38                | 168            | 190               | Average |

| ANTENNA POLARITY : VERTICAL |                  |                   |                       |                     |                       |                   |                      |                |                   |         |
|-----------------------------|------------------|-------------------|-----------------------|---------------------|-----------------------|-------------------|----------------------|----------------|-------------------|---------|
| Frequency ( MHz )           | Level ( dBuV/m ) | Over Limit ( dB ) | Limit Line ( dBuV/m ) | Read Level ( dBuV ) | Antenna Factor ( dB ) | Cable Loss ( dB ) | Preamp Factor ( dB ) | Ant Pos ( cm ) | Table Pos ( deg ) | Remark  |
| 2389.99                     | 58.40            | -15.60            | 74.00                 | 55.31               | 32.02                 | 5.46              | 34.38                | 100            | 315               | Peak    |
| 2389.99                     | 40.44            | -13.56            | 54.00                 | 37.35               | 32.02                 | 5.46              | 34.38                | 100            | 315               | Average |

|                |         |                     |         |
|----------------|---------|---------------------|---------|
| Test Mode :    | Mode 3  | Temperature :       | 27~28°C |
| Test Band :    | 802.11b | Relative Humidity : | 40~41%  |
| Test Channel : | 11      | Test Engineer :     | Kay Wu  |

| ANTENNA POLARITY : HORIZONTAL |                  |                   |                       |                     |                       |                   |                      |                |                   |         |
|-------------------------------|------------------|-------------------|-----------------------|---------------------|-----------------------|-------------------|----------------------|----------------|-------------------|---------|
| Frequency ( MHz )             | Level ( dBuV/m ) | Over Limit ( dB ) | Limit Line ( dBuV/m ) | Read Level ( dBuV ) | Antenna Factor ( dB ) | Cable Loss ( dB ) | Preamp Factor ( dB ) | Ant Pos ( cm ) | Table Pos ( deg ) | Remark  |
| 2483.85                       | 56.22            | -17.78            | 74.00                 | 53.15               | 32.09                 | 5.38              | 34.40                | 104            | 356               | Peak    |
| 2483.85                       | 39.79            | -14.21            | 54.00                 | 36.72               | 32.09                 | 5.38              | 34.40                | 104            | 356               | Average |

| ANTENNA POLARITY : VERTICAL |                  |                   |                       |                     |                       |                   |                      |                |                   |         |
|-----------------------------|------------------|-------------------|-----------------------|---------------------|-----------------------|-------------------|----------------------|----------------|-------------------|---------|
| Frequency ( MHz )           | Level ( dBuV/m ) | Over Limit ( dB ) | Limit Line ( dBuV/m ) | Read Level ( dBuV ) | Antenna Factor ( dB ) | Cable Loss ( dB ) | Preamp Factor ( dB ) | Ant Pos ( cm ) | Table Pos ( deg ) | Remark  |
| 2483.85                     | 55.25            | -18.75            | 74.00                 | 52.18               | 32.09                 | 5.38              | 34.40                | 100            | 124               | Peak    |
| 2483.85                     | 39.25            | -14.75            | 54.00                 | 36.18               | 32.09                 | 5.38              | 34.40                | 100            | 124               | Average |



|                |         |                     |         |
|----------------|---------|---------------------|---------|
| Test Mode :    | Mode 4  | Temperature :       | 27~28°C |
| Test Band :    | 802.11g | Relative Humidity : | 40~41%  |
| Test Channel : | 01      | Test Engineer :     | Kay Wu  |

| ANTENNA POLARITY : HORIZONTAL |                  |                   |                       |                     |                       |                   |                      |                |                   |         |
|-------------------------------|------------------|-------------------|-----------------------|---------------------|-----------------------|-------------------|----------------------|----------------|-------------------|---------|
| Frequency ( MHz )             | Level ( dBuV/m ) | Over Limit ( dB ) | Limit Line ( dBuV/m ) | Read Level ( dBuV ) | Antenna Factor ( dB ) | Cable Loss ( dB ) | Preamp Factor ( dB ) | Ant Pos ( cm ) | Table Pos ( deg ) | Remark  |
| 2389.99                       | 67.49            | -6.51             | 74.00                 | 64.40               | 32.02                 | 5.46              | 34.38                | 168            | 189               | Peak    |
| 2389.99                       | 43.80            | -10.20            | 54.00                 | 40.71               | 32.02                 | 5.46              | 34.38                | 168            | 189               | Average |

| ANTENNA POLARITY : VERTICAL |                  |                   |                       |                     |                       |                   |                      |                |                   |         |
|-----------------------------|------------------|-------------------|-----------------------|---------------------|-----------------------|-------------------|----------------------|----------------|-------------------|---------|
| Frequency ( MHz )           | Level ( dBuV/m ) | Over Limit ( dB ) | Limit Line ( dBuV/m ) | Read Level ( dBuV ) | Antenna Factor ( dB ) | Cable Loss ( dB ) | Preamp Factor ( dB ) | Ant Pos ( cm ) | Table Pos ( deg ) | Remark  |
| 2389.42                     | 64.80            | -9.20             | 74.00                 | 61.71               | 32.02                 | 5.46              | 34.38                | 100            | 147               | Peak    |
| 2389.42                     | 42.46            | -11.54            | 54.00                 | 39.37               | 32.02                 | 5.46              | 34.38                | 100            | 147               | Average |

|                |         |                     |         |
|----------------|---------|---------------------|---------|
| Test Mode :    | Mode 6  | Temperature :       | 27~28°C |
| Test Band :    | 802.11g | Relative Humidity : | 40~41%  |
| Test Channel : | 11      | Test Engineer :     | Kay Wu  |

| ANTENNA POLARITY : HORIZONTAL |                  |                   |                       |                     |                       |                   |                      |                |                   |         |
|-------------------------------|------------------|-------------------|-----------------------|---------------------|-----------------------|-------------------|----------------------|----------------|-------------------|---------|
| Frequency ( MHz )             | Level ( dBuV/m ) | Over Limit ( dB ) | Limit Line ( dBuV/m ) | Read Level ( dBuV ) | Antenna Factor ( dB ) | Cable Loss ( dB ) | Preamp Factor ( dB ) | Ant Pos ( cm ) | Table Pos ( deg ) | Remark  |
| 2483.50                       | 61.72            | -12.28            | 74.00                 | 58.65               | 32.09                 | 5.38              | 34.40                | 104            | 356               | Peak    |
| 2483.50                       | 41.71            | -12.29            | 54.00                 | 38.64               | 32.09                 | 5.38              | 34.40                | 104            | 356               | Average |

| ANTENNA POLARITY : VERTICAL |                  |                   |                       |                     |                       |                   |                      |                |                   |         |
|-----------------------------|------------------|-------------------|-----------------------|---------------------|-----------------------|-------------------|----------------------|----------------|-------------------|---------|
| Frequency ( MHz )           | Level ( dBuV/m ) | Over Limit ( dB ) | Limit Line ( dBuV/m ) | Read Level ( dBuV ) | Antenna Factor ( dB ) | Cable Loss ( dB ) | Preamp Factor ( dB ) | Ant Pos ( cm ) | Table Pos ( deg ) | Remark  |
| 2483.50                     | 61.49            | -12.51            | 74.00                 | 58.42               | 32.09                 | 5.38              | 34.40                | 100            | 125               | Peak    |
| 2483.50                     | 41.79            | -12.21            | 54.00                 | 38.72               | 32.09                 | 5.38              | 34.40                | 100            | 125               | Average |



### 3.3.6 Test Plots of Conducted Band Edges

|                |              |                     |            |
|----------------|--------------|---------------------|------------|
| Test Mode :    | Mode 1 and 3 | Temperature :       | 23~24°C    |
| Test Band :    | 802.11b      | Relative Humidity : | 42~43%     |
| Test Channel : | 01 and 11    | Test Engineer :     | Eric Huang |

Low Band Edge Plot on 802.11b Channel 01

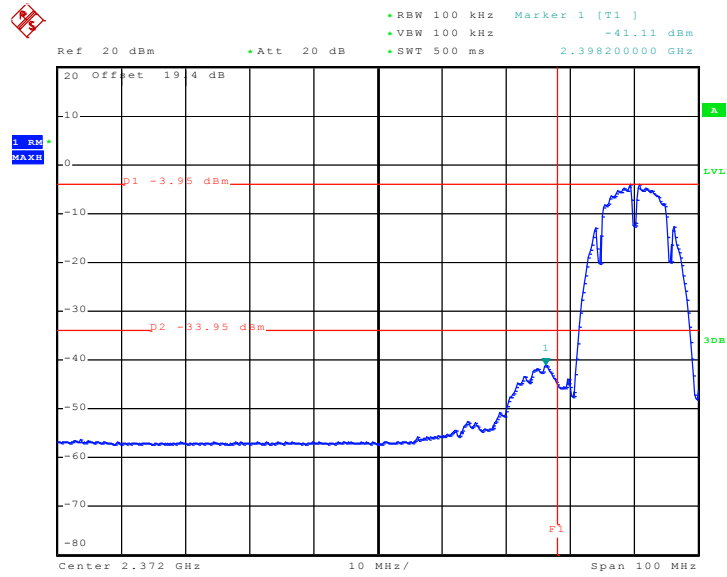

Date: 13.JUL.2009 18:36:14

High Band Edge Plot on 802.11b Channel 11

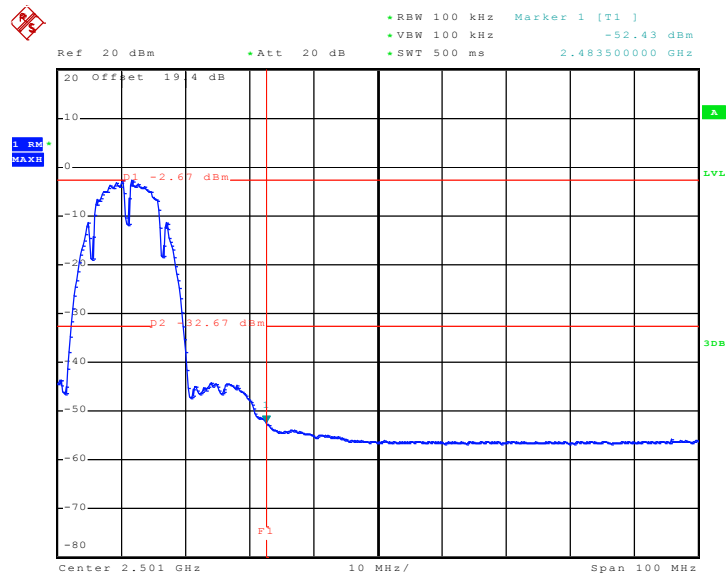

Date: 13.JUL.2009 18:39:41





|                |              |                     |            |
|----------------|--------------|---------------------|------------|
| Test Mode :    | Mode 4 and 6 | Temperature :       | 23~24°C    |
| Test Band :    | 802.11g      | Relative Humidity : | 42~43%     |
| Test Channel : | 01 and 11    | Test Engineer :     | Eric Huang |

Low Band Edge Plot on 802.11g Channel 01

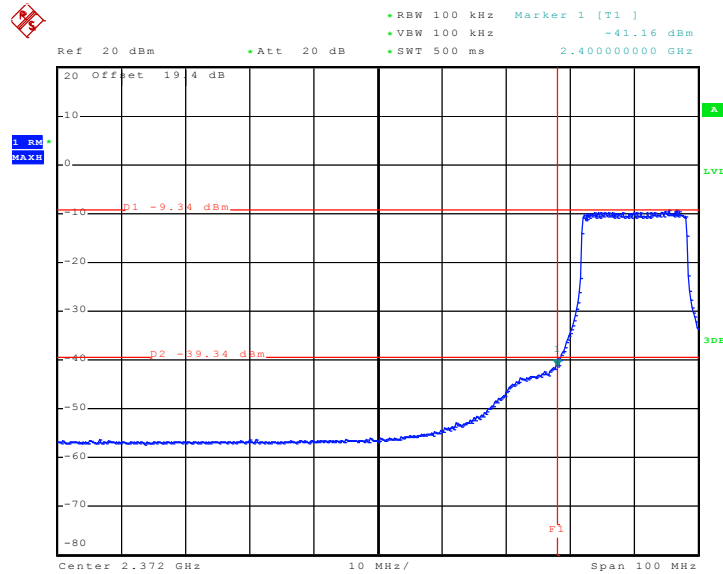

Date: 13.JUL.2009 18:37:32

High Band Edge Plot on 802.11g Channel 11

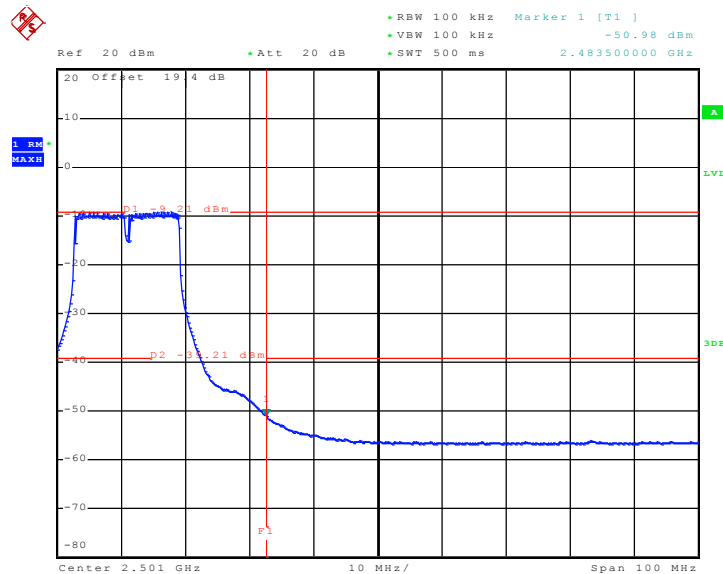

Date: 13.JUL.2009 18:41:05

## 3.4 Spurious Emission Measurement

### 3.4.1 Limit of Spurious Emission Measurement

All harmonics/spurs must be at least 20 dB down from the highest emission level within the authorized band.

### 3.4.2 Measuring Instruments

See list of measuring instruments of this test report.

### 3.4.3 Test Procedure

1. The transmitter output was connected to the spectrum analyzer via a low lose cable.
2. Set RBW = 100 kHz, Video bandwidth (VBW)  $\geq$  RBW, scan up through 10th harmonic. All harmonics/spurs must be at least 20 dB down from the highest emission level within the authorized band as measured with a 100 kHz RBW.

### 3.4.4 Test Setup

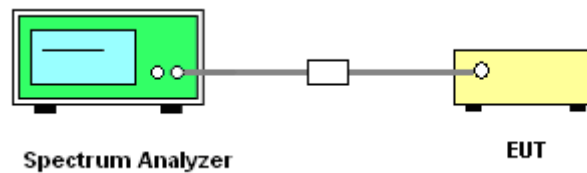

### 3.4.5 Test Plots of Spurious Emission

|                |        |                     |            |
|----------------|--------|---------------------|------------|
| Test Mode :    | Mode 1 | Temperature :       | 23~24°C    |
| Test Channel : | 01     | Relative Humidity : | 42~43%     |
|                |        | Test Engineer :     | Eric Huang |

Conducted Spurious Emission Plot between 9 kHz ~ 3 GHz

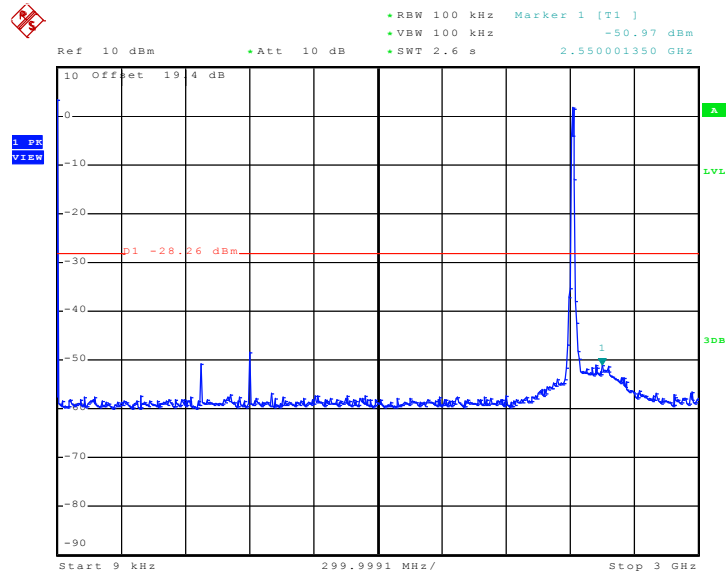

Date: 13.JUL.2009 18:26:48

Conducted Spurious Emission Plot between 1GHz ~ 25 GHz

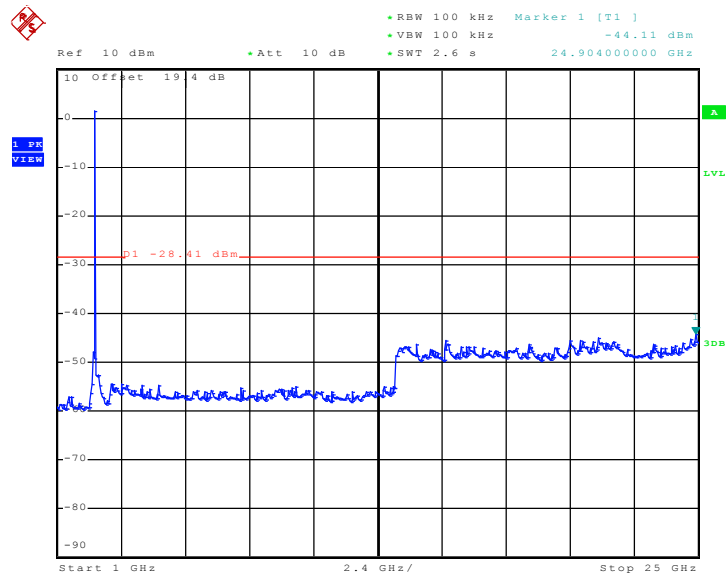

Date: 13.JUL.2009 18:27:12



|                |        |                     |            |
|----------------|--------|---------------------|------------|
| Test Mode :    | Mode 2 | Temperature :       | 23~24°C    |
| Test Channel : | 06     | Relative Humidity : | 42~43%     |
|                |        | Test Engineer :     | Eric Huang |

Conducted Spurious Emission Plot between 9 kHz ~ 3 GHz

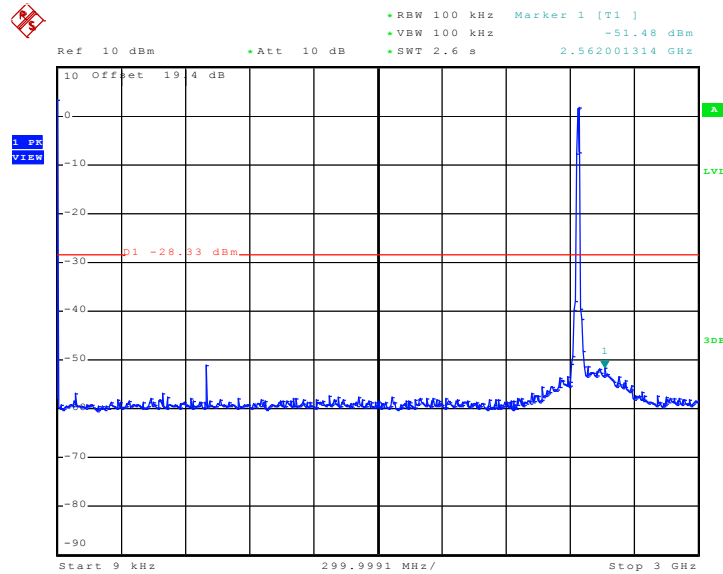

Date: 13.JUL.2009 18:27:56

Conducted Spurious Emission Plot between 1GHz ~ 25 GHz

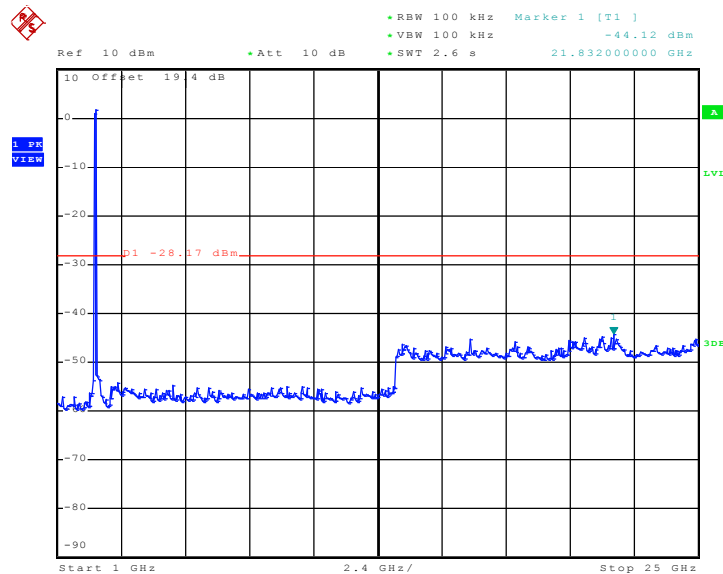

Date: 13..JUL..2009 18:28:18



|                |        |                     |            |
|----------------|--------|---------------------|------------|
| Test Mode :    | Mode 3 | Temperature :       | 23~24°C    |
| Test Channel : | 11     | Relative Humidity : | 42~43%     |
|                |        | Test Engineer :     | Eric Huang |

Conducted Spurious Emission Plot between 9 kHz ~ 3 GHz

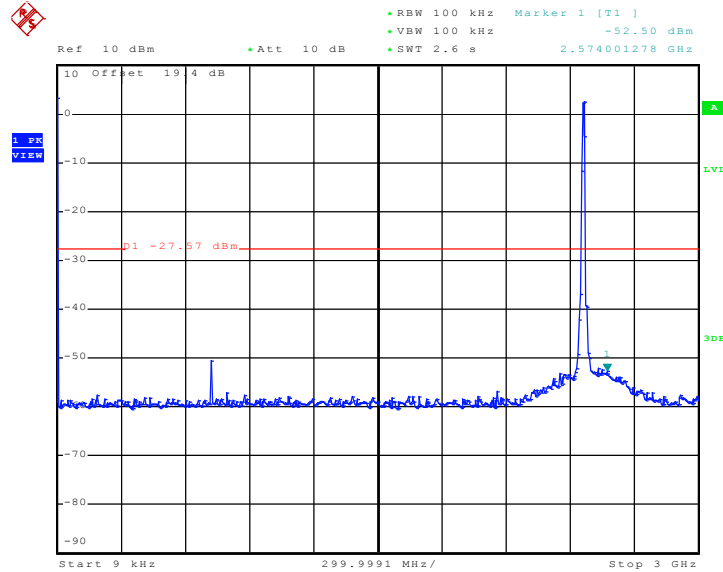

Date: 13.JUL.2009 18:28:54

Conducted Spurious Emission Plot between 1GHz ~ 25 GHz

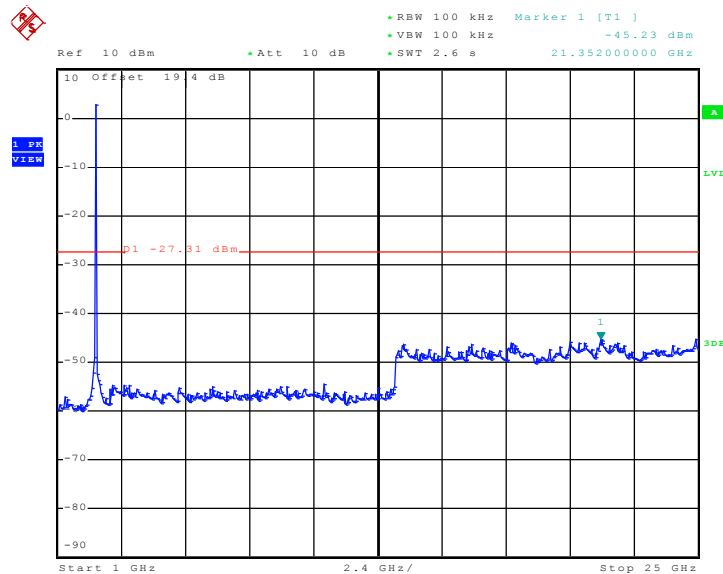

Date: 13..JUL..2009 18:29:07



|                |        |                     |            |
|----------------|--------|---------------------|------------|
| Test Mode :    | Mode 4 | Temperature :       | 23~24°C    |
| Test Channel : | 01     | Relative Humidity : | 42~43%     |
|                |        | Test Engineer :     | Eric Huang |

Conducted Spurious Emission Plot between 9 kHz ~ 3 GHz

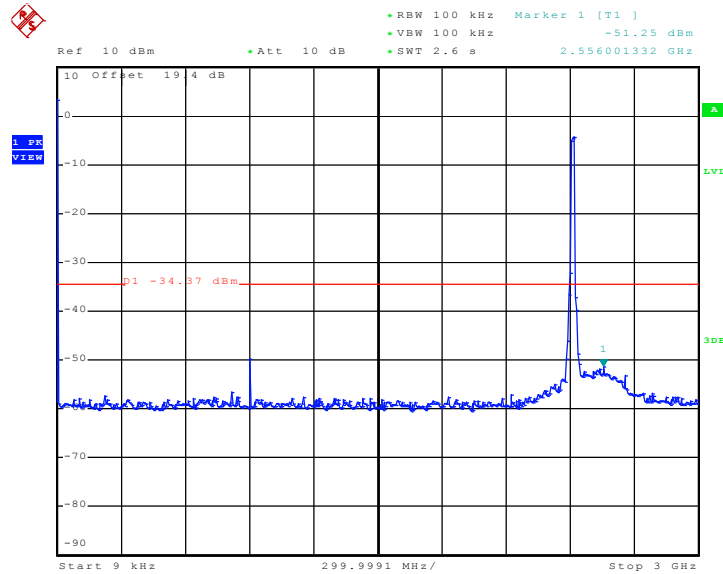

Date: 13.JUL.2009 18:29:44

Conducted Spurious Emission Plot between 1GHz ~ 25 GHz

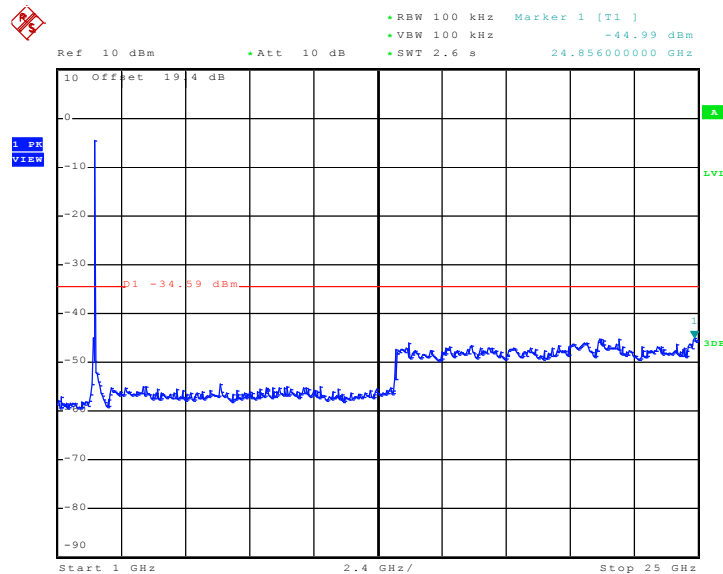

Date: 13..JUL..2009 18:30:03



|                |        |                     |            |
|----------------|--------|---------------------|------------|
| Test Mode :    | Mode 5 | Temperature :       | 23~24°C    |
| Test Channel : | 06     | Relative Humidity : | 42~43%     |
|                |        | Test Engineer :     | Eric Huang |

Conducted Spurious Emission Plot between 9 kHz ~ 3 GHz

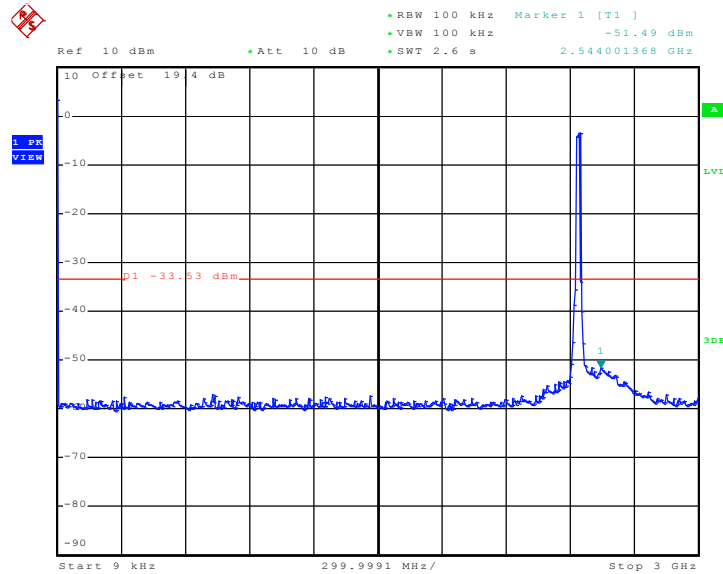

Date: 13.JUL.2009 18:30:41

Conducted Spurious Emission Plot between 1GHz ~ 25 GHz

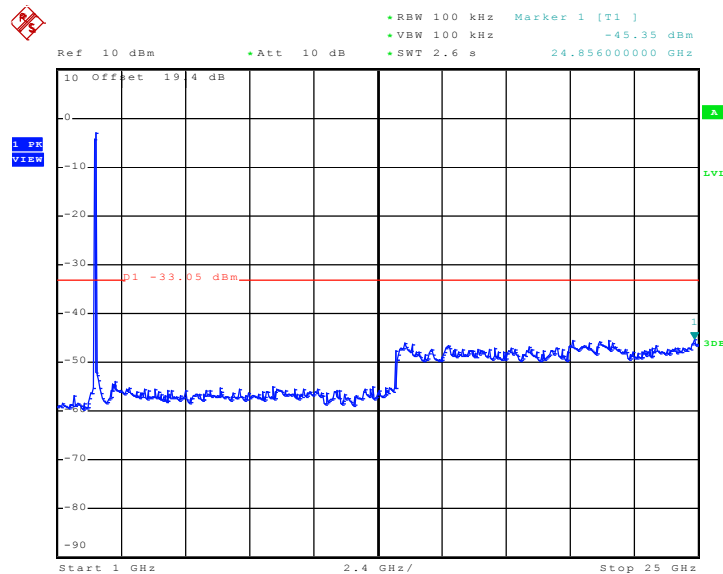

Date: 13..JUL..2009 18:30:57



|                |        |                     |            |
|----------------|--------|---------------------|------------|
| Test Mode :    | Mode 6 | Temperature :       | 23~24°C    |
| Test Channel : | 11     | Relative Humidity : | 42~43%     |
|                |        | Test Engineer :     | Eric Huang |

Conducted Spurious Emission Plot between 9 kHz ~ 3 GHz

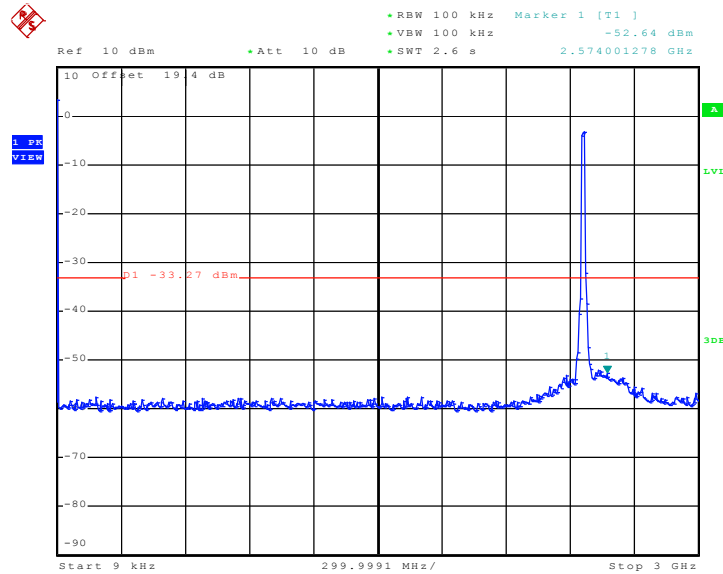

Date: 13.JUL.2009 18:31:34

Conducted Spurious Emission Plot between 1GHz ~ 25 GHz

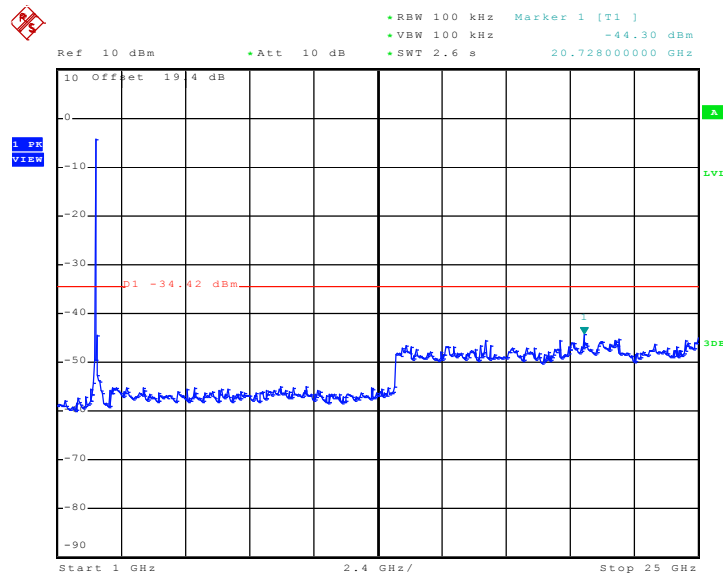

Date: 13..JUL..2009 18:31:48



## 3.5 Power Spectral Density Measurement

### 3.5.1 Limit of Power Spectral Density

The peak power spectral density shall not be greater than 8dBm in any 3kHz band at any time interval of continuous transmission.

### 3.5.2 Measuring Instruments

See list of measuring instruments of this test report.

### 3.5.3 Test Procedures

1. The test follows FCC KDB Publication No. 558074 (Measurement Guidelines of DTS).
2. The RF output of EUT was connected to the spectrum analyzer by a low loss cable.
3. Take the measured data from spectrum analyzer.

### 3.5.4 Test Setup

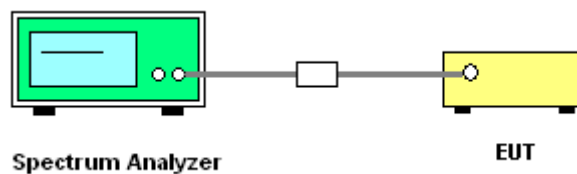



3.5.5 Test Result of Power Spectral Density

|                 |              |                     |         |
|-----------------|--------------|---------------------|---------|
| Test Mode :     | Mode 1, 2, 3 | Temperature :       | 23~24°C |
| Test Engineer : | Eric Huang   | Relative Humidity : | 42~43%  |

| Channel | Frequency (MHz) | 802.11b Measured PSD (dBm) | Max. Limits (dBm) | Pass/Fail |
|---------|-----------------|----------------------------|-------------------|-----------|
| 01      | 2412            | -15.73                     | 8                 | Pass      |
| 06      | 2437            | -14.31                     | 8                 | Pass      |
| 11      | 2462            | -12.29                     | 8                 | Pass      |

Mode 1 : PSD Plot on 802.11b Channel 01

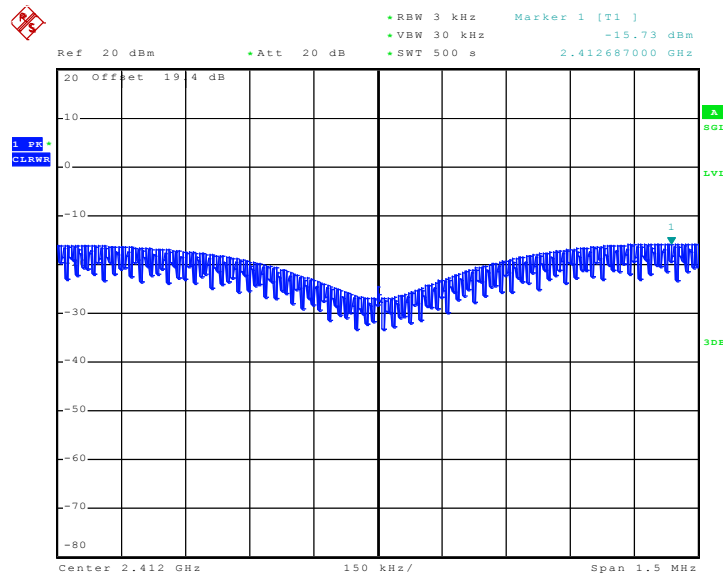

Date: 4..JUN.2009 19:18:39



Mode 2 : PSD Plot on 802.11b Channel 06

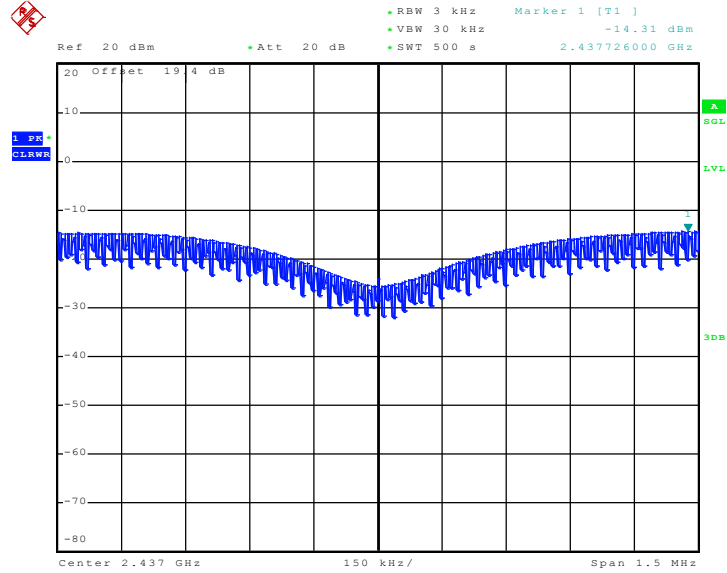

Date: 4.JUN.2009 19:28:57

Mode 3 : PSD Plot on 802.11b Channel 11

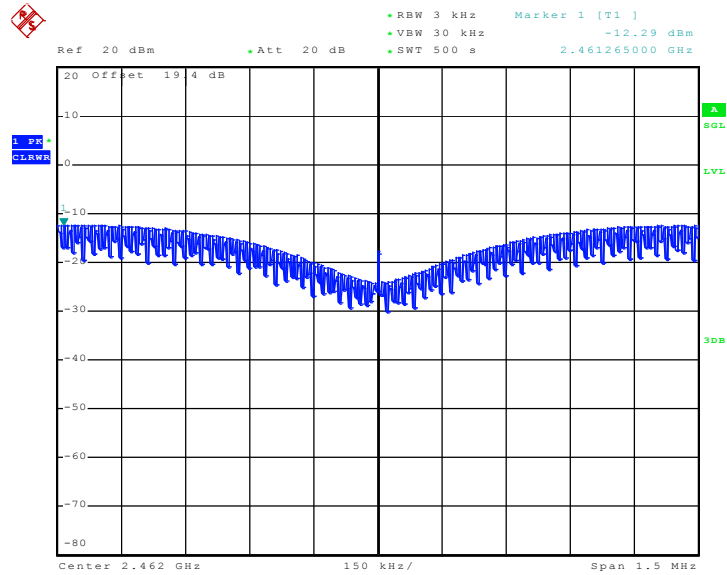

Date: 4.JUN.2009 19:38:41



|                 |              |                     |         |
|-----------------|--------------|---------------------|---------|
| Test Mode :     | Mode 4, 5, 6 | Temperature :       | 23~24°C |
| Test Engineer : | Eric Huang   | Relative Humidity : | 42~43%  |

| Channel | Frequency (MHz) | 802.11g Measured PSD (dBm) | Max. Limits (dBm) | Pass/Fail |
|---------|-----------------|----------------------------|-------------------|-----------|
| 01      | 2412            | -16.39                     | 8                 | Pass      |
| 06      | 2437            | -16.72                     | 8                 | Pass      |
| 11      | 2462            | -17.20                     | 8                 | Pass      |

Mode 4 : PSD Plot on 802.11g Channel 01

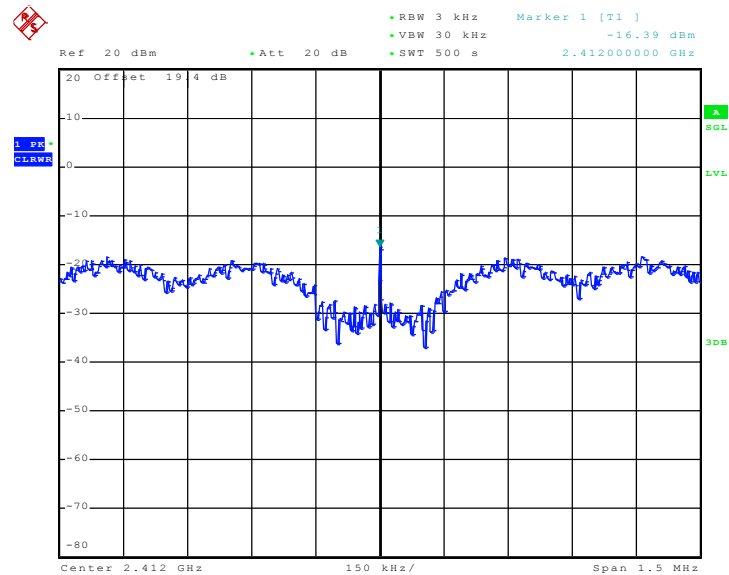

Date: 4..JUN.2009 19:48:03



Mode 5 : PSD Plot on 802.11g Channel 06

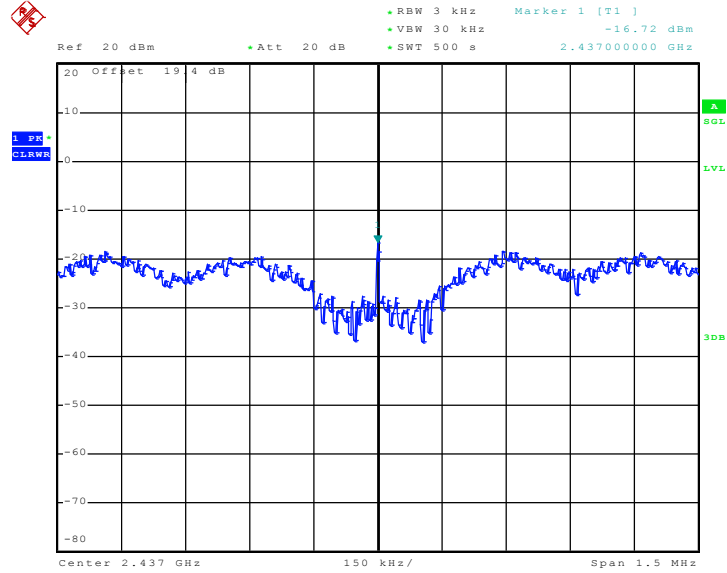

Date: 4.JUN.2009 19:57:15

Mode 6 : PSD Plot on 802.11g Channel 11

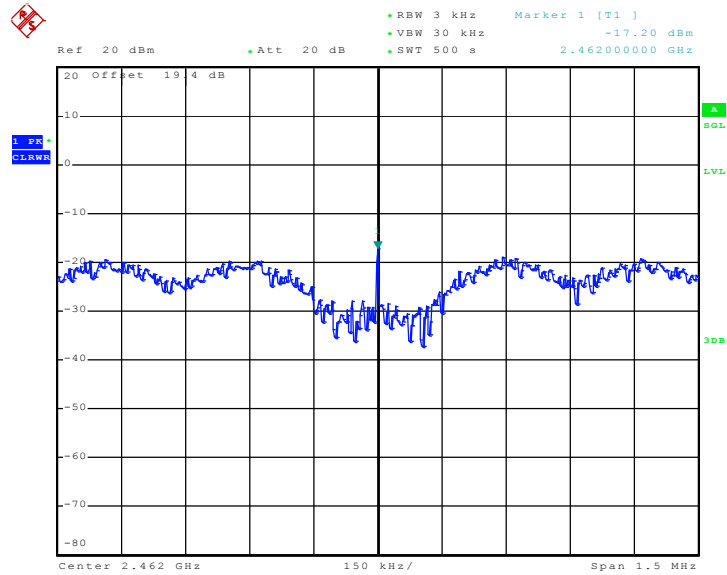

Date: 4.JUN.2009 20:06:24

## 3.6 AC Conducted Emission Measurement

### 3.6.1 Limit of AC Conducted Emission

For equipment that is designed to be connected to the public utility (AC) power line, the radio frequency voltage that is conducted back onto the AC power line on any frequency or frequencies within the band 150 kHz to 30 MHz shall not exceed the limits in the following table.

| Frequency of Emission<br>(MHz) | Conducted Limit (dBuV) |           |
|--------------------------------|------------------------|-----------|
|                                | Quasi-Peak             | Average   |
| 0.15-0.5                       | 66 to 56*              | 56 to 46* |
| 0.5-5                          | 56                     | 46        |
| 5-30                           | 60                     | 50        |

\*Decreases with the logarithm of the frequency.

### 3.6.2 Measuring Instruments

See list of measuring instruments of this test report.

### 3.6.3 Test Procedures

1. The testing follows the guidelines in ANSI C63.4-2003.
2. The EUT was placed 0.4 meter from the conducting wall of the shielding room, and it was kept at least 80 centimeters from any other grounded conducting surface.
3. Connect EUT to the power mains through a line impedance stabilization network (LISN).
4. All the support units are connecting to the other LISN.
5. The LISN provides 50 ohm coupling impedance for the measuring instrument.
6. The FCC states that a 50 ohm, 50 microhenry LISN should be used.
7. Both sides of AC line were checked for maximum conducted interference.
8. The frequency range from 150 kHz to 30 MHz was searched.
9. Set the test-receiver system to Peak Detect Function and specified bandwidth with Maximum Hold Mode.

### 3.6.4 Test Setup

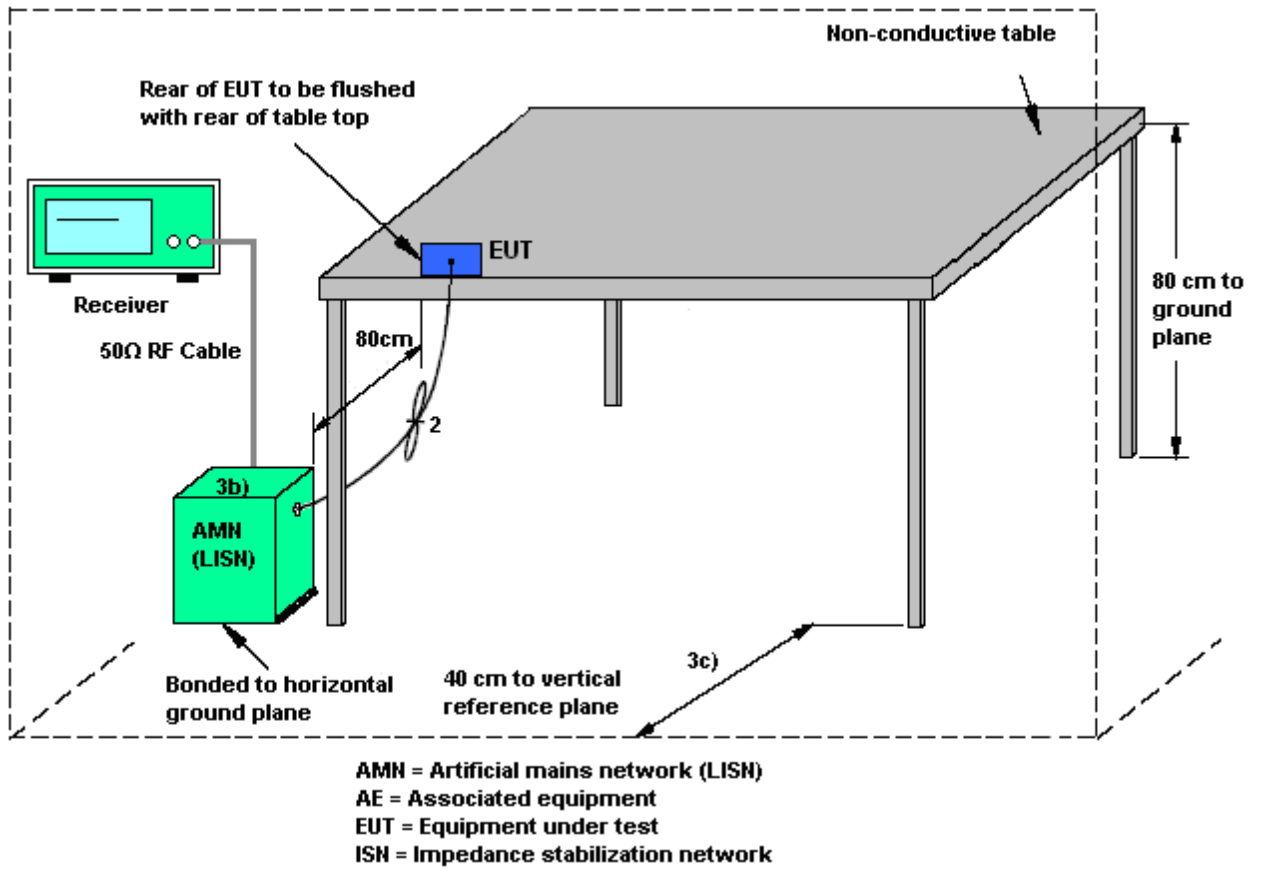

### 3.6.5 Test Result of AC Conducted Emission

|                 |   |                     |         |
|-----------------|---|---------------------|---------|
| Test Mode :     | Mode 1  | Temperature :       | 23~24°C |
| Test Engineer : | Cona Huang  | Relative Humidity : | 42~43%  |
| Test Voltage :  | 120Vac / 60Hz   | Phase :             | Line    |
| Function Type : | Bluetooth Link + WLAN Link + Earphone + USB Cable (Link with i-pod) + Adapter   |                     |         |
| Remark :        | All emissions not reported here are more than 10 dB below the prescribed limit. |                     |         |

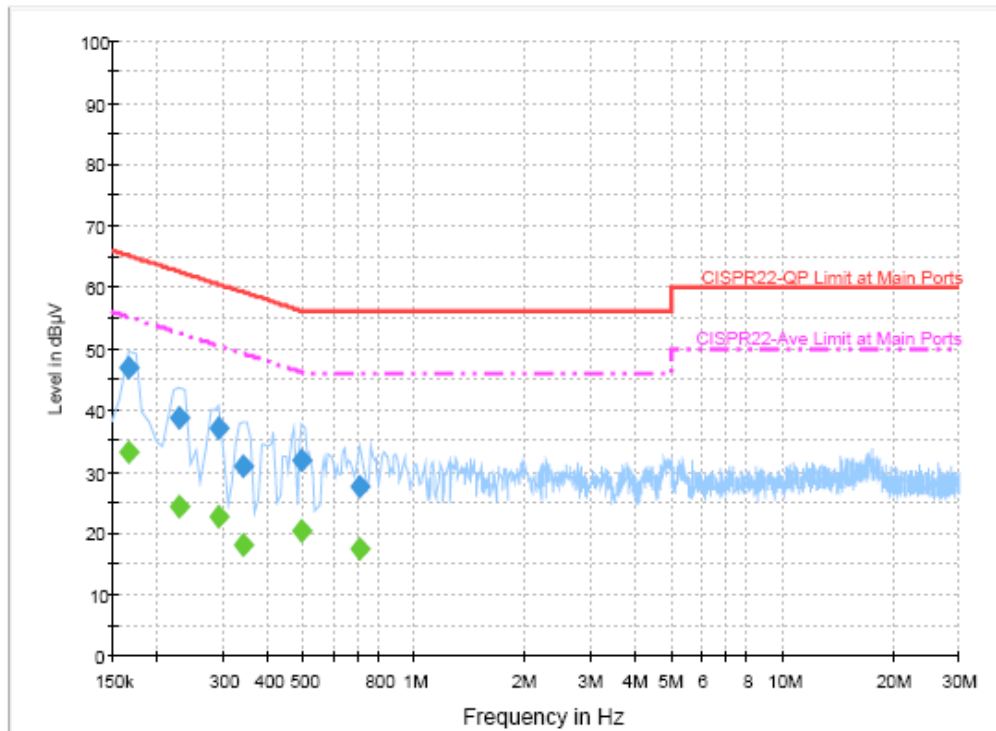

#### Final Result 1

| Frequency (MHz) | QuasiPeak (dBµV) | Filter | Line | Corr. (dB) | Margin (dB) | Limit (dBµV) |
|-----------------|------------------|--------|------|------------|-------------|--------------|
| 0.166000        | 46.9             | Off    | L1   | 19.5       | 18.3        | 65.2         |
| 0.230000        | 38.5             | Off    | L1   | 19.5       | 23.9        | 62.4         |
| 0.294000        | 37.1             | Off    | L1   | 19.4       | 23.3        | 60.4         |
| 0.342000        | 30.8             | Off    | L1   | 19.4       | 28.4        | 59.2         |
| 0.494000        | 31.9             | Off    | L1   | 19.4       | 24.2        | 56.1         |
| 0.710000        | 27.5             | Off    | L1   | 19.5       | 28.5        | 56.0         |

#### Final Result 2

| Frequency (MHz) | Average (dBµV) | Filter | Line | Corr. (dB) | Margin (dB) | Limit (dBµV) |
|-----------------|----------------|--------|------|------------|-------------|--------------|
| 0.166000        | 33.1           | Off    | L1   | 19.5       | 22.1        | 55.2         |
| 0.230000        | 24.2           | Off    | L1   | 19.5       | 28.2        | 52.4         |
| 0.294000        | 22.7           | Off    | L1   | 19.4       | 27.7        | 50.4         |
| 0.342000        | 18.0           | Off    | L1   | 19.4       | 31.2        | 49.2         |
| 0.494000        | 20.2           | Off    | L1   | 19.4       | 25.9        | 46.1         |
| 0.710000        | 17.4           | Off    | L1   | 19.5       | 28.6        | 46.0         |





|                 |   |                     |         |
|-----------------|---|---------------------|---------|
| Test Mode :     | Mode 1  | Temperature :       | 23~24°C |
| Test Engineer : | Cona Huang  | Relative Humidity : | 42~43%  |
| Test Voltage :  | 120Vac / 60Hz   | Phase :             | Neutral |
| Function Type : | Bluetooth Link + WLAN Link + Earphone + USB Cable (Link with i-pod) + Adapter   |                     |         |
| Remark :        | All emissions not reported here are more than 10 dB below the prescribed limit. |                     |         |

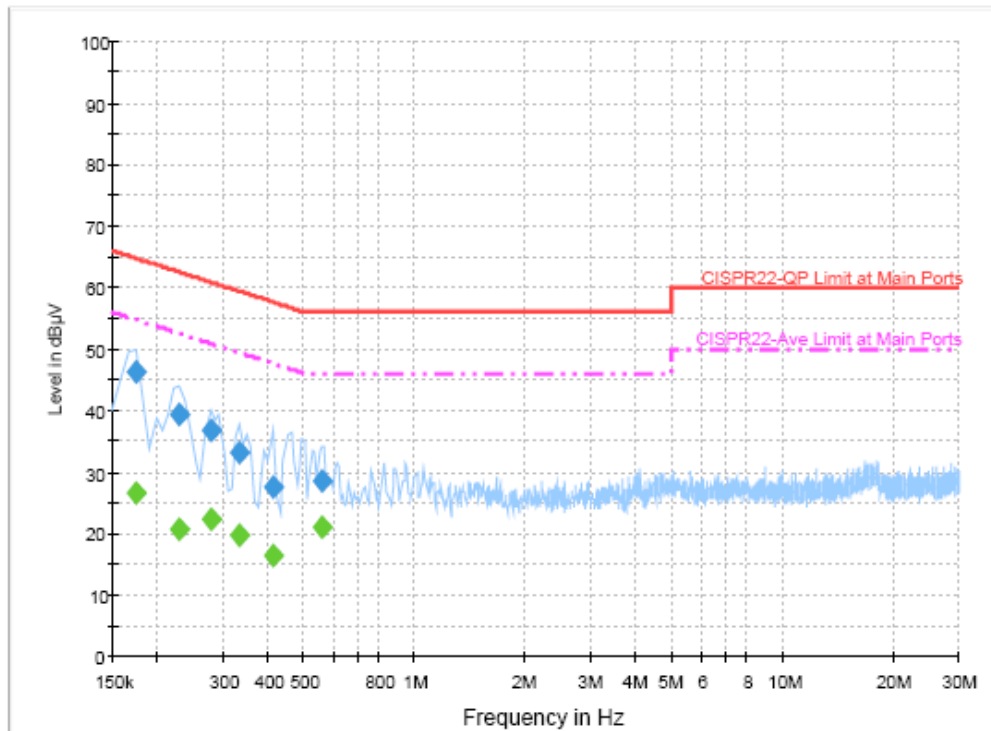

**Final Result 1**

| Frequency (MHz) | QuasiPeak (dBµV) | Filter | Line | Corr. (dB) | Margin (dB) | Limit (dBµV) |
|-----------------|------------------|--------|------|------------|-------------|--------------|
| 0.174000        | 46.3             | Off    | N    | 19.5       | 18.5        | 64.8         |
| 0.230000        | 39.2             | Off    | N    | 19.5       | 23.2        | 62.4         |
| 0.278000        | 36.9             | Off    | N    | 19.5       | 24.0        | 60.9         |
| 0.334000        | 33.1             | Off    | N    | 19.4       | 26.3        | 59.4         |
| 0.414000        | 27.5             | Off    | N    | 19.4       | 30.1        | 57.6         |
| 0.558000        | 28.4             | Off    | N    | 19.5       | 27.6        | 56.0         |

**Final Result 2**

| Frequency (MHz) | Average (dBµV) | Filter | Line | Corr. (dB) | Margin (dB) | Limit (dBµV) |
|-----------------|----------------|--------|------|------------|-------------|--------------|
| 0.174000        | 26.7           | Off    | N    | 19.5       | 28.1        | 54.8         |
| 0.230000        | 20.7           | Off    | N    | 19.5       | 31.7        | 52.4         |
| 0.278000        | 22.3           | Off    | N    | 19.5       | 28.6        | 50.9         |
| 0.334000        | 19.7           | Off    | N    | 19.4       | 29.7        | 49.4         |
| 0.414000        | 16.3           | Off    | N    | 19.4       | 31.3        | 47.6         |
| 0.558000        | 20.9           | Off    | N    | 19.5       | 25.1        | 46.0         |

### 3.7 Radiated Emission Measurement

#### 3.7.1 Limit of Radiated Emission

In any 100 kHz bandwidth outside the intentional radiator frequency band, all harmonics/spurious must be at least 20 dB below the highest emission level within the authorized band. If the output power of this device was measured by spectrum analyzer, the attenuation under this paragraph shall be 30 dB instead of 20 dB. In addition, radiated emissions which fall in the restricted bands must also comply with the FCC section 15.209 limits as below.

| Frequency (MHz) | Field Strength (microvolts/meter) | Measurement Distance (meters) |
|-----------------|-----------------------------------|-------------------------------|
| 0.009 – 0.490   | 2400/F(kHz)                       | 300                           |
| 0.490 – 1.705   | 24000/F(kHz)                      | 30                            |
| 1.705 – 30.0    | 30                                | 30                            |
| 30 – 88         | 100                               | 3                             |
| 88 – 216        | 150                               | 3                             |
| 216 - 960       | 200                               | 3                             |
| Above 960       | 500                               | 3                             |

#### 3.7.2 Measuring Instruments

See list of measuring instruments of this test report.

#### 3.7.3 Test Procedures

1. The testing follows the guidelines in FCC KDB Publication No. 558074 (Measurement Guidelines of DTS).
2. Use the following spectrum analyzer settings:  
Span = wide enough to fully capture the emission being measured; RBW = 1 MHz for  $f \geq 1$  GHz, 100 kHz for  $f < 1$  GHz; VBW  $\geq$  RBW; Sweep = auto; Detector function = peak; Trace = max hold.
3. Follow the guidelines in ANSI C63.4-2003 with respect to maximizing the emission by rotating the EUT, measuring the emission for three EUT orthogonal planes, and adjusting the measurement antenna height and polarization. A pre-amp and a high pass filter are used for this test in order to get the good signal level.

### 3.7.4 Test Setup

For radiated emissions below 30MHz

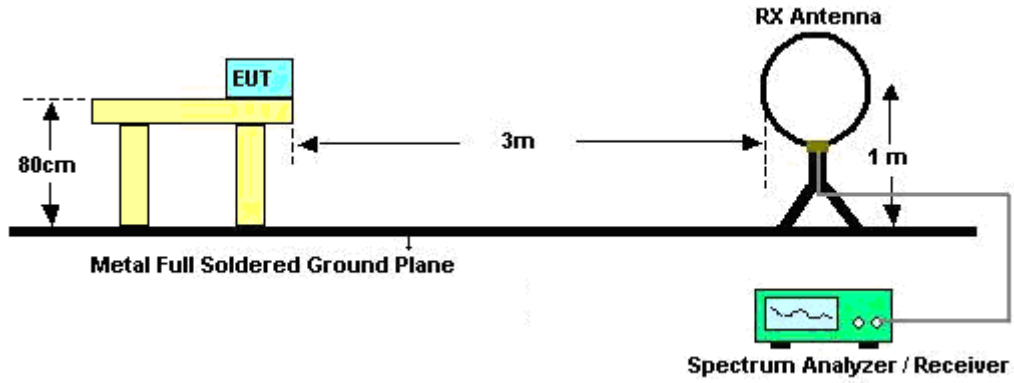

For radiated emissions above 30MHz

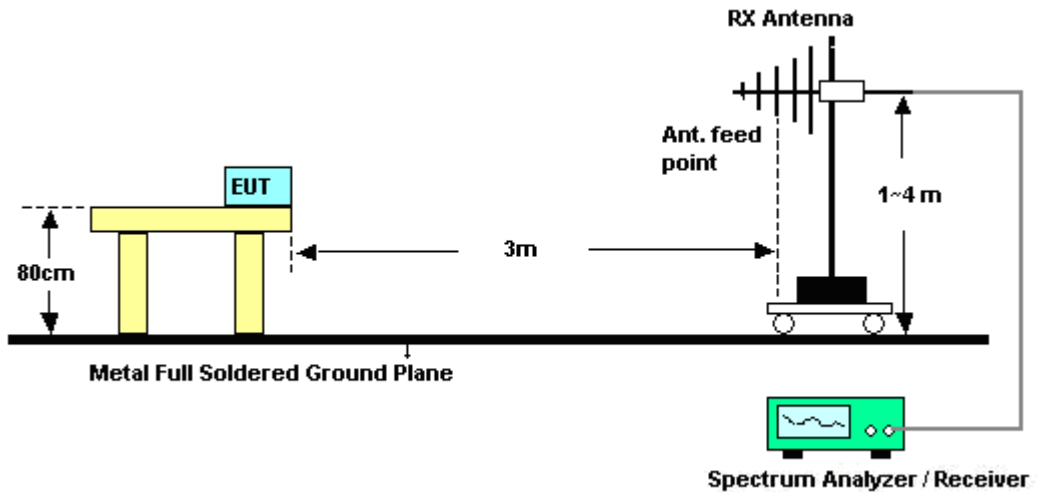



3.7.5 Test Results of Radiated Emissions (9 kHz ~ 30 MHz)

| Test Engineer : | Kay Wu       | Temperature :       | 27~28°C           |          |
|-----------------|--------------|---------------------|-------------------|----------|
|                 |              | Relative Humidity : | 40~41%            |          |
| Frequency (MHz) | Level (dBuV) | Over Limit (dB)     | Limit Line (dBuV) | Remark   |
| -               | -            | -                   | -                 | See Note |

Note:

The amplitude of spurious emissions that are attenuated by more than 20dB below the permissible value has no need to be reported.

Distance extrapolation factor =  $40 \log(\text{specific distance} / \text{test distance})$  (dB);

Limit line = specific limits (dBuV) + distance extrapolation factor.



3.7.6 Test Result of Radiated Emission (30 MHz ~ 10<sup>th</sup> Harmonic)

|                 |  |                     |            |
|-----------------|--|---------------------|------------|
| Test Mode :     | Mode 1   | Temperature :       | 27~28°C    |
| Test Channel :  | 01   | Relative Humidity : | 40~41%     |
| Test Engineer : | Kay Wu   | Polarization :      | Horizontal |
| Remark :        | #9 and #10 are Fundamental Signals which can be ignored. |                     |            |

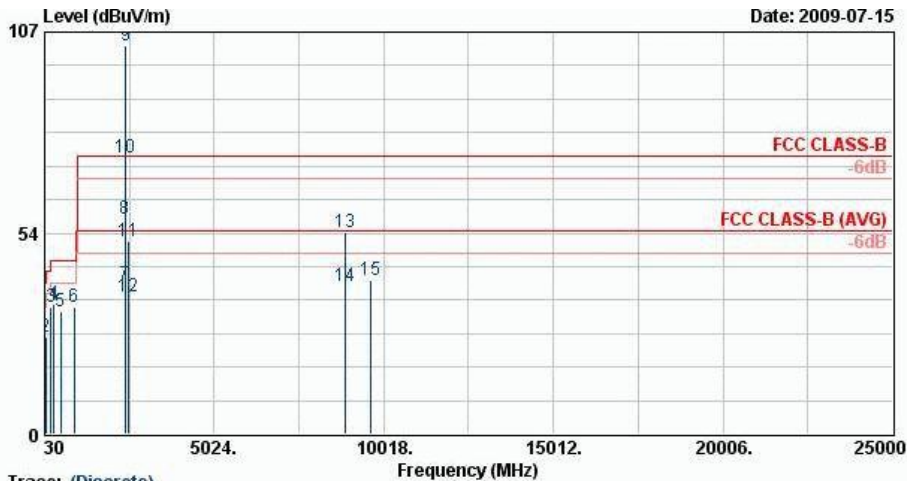

Trace: (Discrete)  
 Site : 03CH07-HY  
 Condition : FCC CLASS-B 3m SHF-EHF HORN HORIZONTAL  
 Project : FR 952730-01

|      | Freq    | Level  | Over   | Limit  | ReadAntenna | Cable  | Preamp | Ant   | Table | Remark      |      |
|------|---------|--------|--------|--------|-------------|--------|--------|-------|-------|-------------|------|
|      | MHz     | dBuV/m | Limit  | Line   | Level       | Loss   | Factor | Pos   | Pos   |             |      |
|      |         |        | dB     | dBuV/m | dBuV        | dB/m   | dB     | dB    | cm    | deg         |      |
| 1    | 30.00   | 31.05  | -8.95  | 40.00  | 42.21       | 19.90  | 0.64   | 31.70 | 100   | 214 Peak    |      |
| 2    | 71.58   | 25.98  | -14.02 | 40.00  | 49.77       | 6.95   | 0.97   | 31.70 | ---   | ---         | Peak |
| 3    | 216.30  | 33.90  | -12.10 | 46.00  | 53.23       | 10.46  | 1.78   | 31.57 | ---   | ---         | Peak |
| 4    | 310.50  | 34.51  | -11.49 | 46.00  | 49.62       | 14.10  | 2.18   | 31.38 | ---   | ---         | Peak |
| 5    | 503.70  | 32.46  | -13.54 | 46.00  | 42.36       | 18.24  | 2.95   | 31.10 | ---   | ---         | Peak |
| 6    | 897.80  | 33.81  | -12.19 | 46.00  | 37.45       | 22.90  | 4.15   | 30.70 | ---   | ---         | Peak |
| 7    | 2389.61 | 39.73  | -14.27 | 54.00  | 36.64       | 32.02  | 5.46   | 34.38 | 168   | 190 Average |      |
| 8    | 2389.61 | 57.29  | -16.71 | 74.00  | 54.20       | 32.02  | 5.46   | 34.38 | 168   | 190 Peak    |      |
| 9 @  | 2412.00 | 103.55 |        |        | 100.46      | 32.03  | 5.44   | 34.38 | 168   | 190 Peak    |      |
| 10 X | 2412.00 | 73.47  |        |        | 70.38       | 32.03  | 5.44   | 34.38 | 168   | 190 Average |      |
| 11   | 2484.00 | 51.47  | -22.53 | 74.00  | 48.40       | 32.09  | 5.38   | 34.40 | 168   | 190 Peak    |      |
| 12   | 2484.00 | 36.59  | -17.41 | 54.00  | 33.52       | 32.09  | 5.38   | 34.40 | 168   | 190 Average |      |
| 13   | 8865.00 | 53.72  | -20.28 | 74.00  | 42.80       | 35.99  | 10.30  | 35.37 | 100   | 132 Peak    |      |
| 14   | 8865.00 | 39.56  | -14.44 | 54.00  | 28.64       | 35.99  | 10.30  | 35.37 | 100   | 132 Average |      |
| 15   | 9648.00 | 40.95  | -33.05 | 74.00  | 75.87       | -10.09 | 10.74  | 35.57 | 100   | 0 Peak      |      |



|                 |  |                     |          |
|-----------------|--|---------------------|----------|
| Test Mode :     | Mode 1   | Temperature :       | 27~28°C  |
| Test Channel :  | 01   | Relative Humidity : | 40~41%   |
| Test Engineer : | Kay Wu   | Polarization :      | Vertical |
| Remark :        | #9 and #10 are Fundamental Signals which can be ignored. |                     |          |

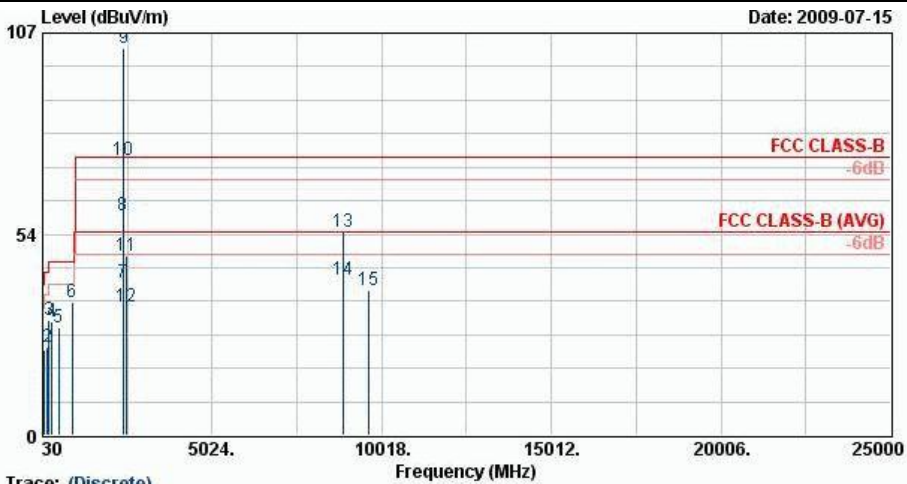

Trace: (Discrete)  
 Site : D3CH07-HY  
 Condition : FCC CLASS-B 3m SHF-EHF HORN VERTICAL  
 Project : FR 952730-01

|      | Freq    | Level  | Over   | Limit  | Read  | Antenna | Cable | Preamp | Ant | Table | Remark  |
|------|---------|--------|--------|--------|-------|---------|-------|--------|-----|-------|---------|
|      | MHz     | dBuV/m | dB     | dBuV/m | dBuV  | dB/m    | dB    | dB     | cm  | deg   |         |
| 1    | 71.58   | 22.60  | -17.40 | 40.00  | 46.39 | 6.95    | 0.97  | 31.70  | --- | ---   | Peak    |
| 2    | 167.97  | 23.64  | -19.86 | 43.50  | 43.43 | 10.30   | 1.54  | 31.63  | --- | ---   | Peak    |
| 3    | 216.30  | 30.50  | -15.50 | 46.00  | 49.83 | 10.46   | 1.78  | 31.57  | --- | ---   | Peak    |
| 4    | 310.50  | 30.06  | -15.94 | 46.00  | 45.17 | 14.10   | 2.18  | 31.38  | --- | ---   | Peak    |
| 5    | 503.70  | 28.82  | -17.18 | 46.00  | 38.73 | 18.24   | 2.95  | 31.10  | --- | ---   | Peak    |
| 6    | 897.80  | 35.57  | -10.43 | 46.00  | 39.22 | 22.90   | 4.15  | 30.70  | 100 | 213   | Peak    |
| 7    | 2389.99 | 40.44  | -13.56 | 54.00  | 37.35 | 32.02   | 5.46  | 34.38  | 100 | 315   | Average |
| 8    | 2389.99 | 58.40  | -15.60 | 74.00  | 55.31 | 32.02   | 5.46  | 34.38  | 100 | 315   | Peak    |
| 9 @  | 2412.00 | 102.93 |        |        | 99.84 | 32.03   | 5.44  | 34.38  | 100 | 315   | Peak    |
| 10 X | 2412.00 | 73.05  |        |        | 69.96 | 32.03   | 5.44  | 34.38  | 100 | 315   | Average |
| 11   | 2500.00 | 47.85  | -26.15 | 74.00  | 44.78 | 32.10   | 5.37  | 34.40  | 100 | 315   | Peak    |
| 12   | 2500.00 | 34.19  | -19.81 | 54.00  | 31.12 | 32.10   | 5.37  | 34.40  | 100 | 315   | Average |
| 13   | 8865.00 | 54.01  | -19.99 | 74.00  | 43.09 | 35.99   | 10.30 | 35.37  | 100 | 214   | Peak    |
| 14   | 8865.00 | 41.49  | -12.51 | 54.00  | 30.57 | 35.99   | 10.30 | 35.37  | 100 | 214   | Average |
| 15   | 9648.00 | 38.40  | -35.60 | 74.00  | 73.32 | -10.09  | 10.74 | 35.57  | 100 | 0     | Peak    |



|                 |  |                     |            |
|-----------------|--|---------------------|------------|
| Test Mode :     | Mode 2   | Temperature :       | 27~28°C    |
| Test Channel :  | 06   | Relative Humidity : | 40~41%     |
| Test Engineer : | Kay Wu   | Polarization :      | Horizontal |
| Remark :        | #9 and #10 are Fundamental Signals which can be ignored. |                     |            |

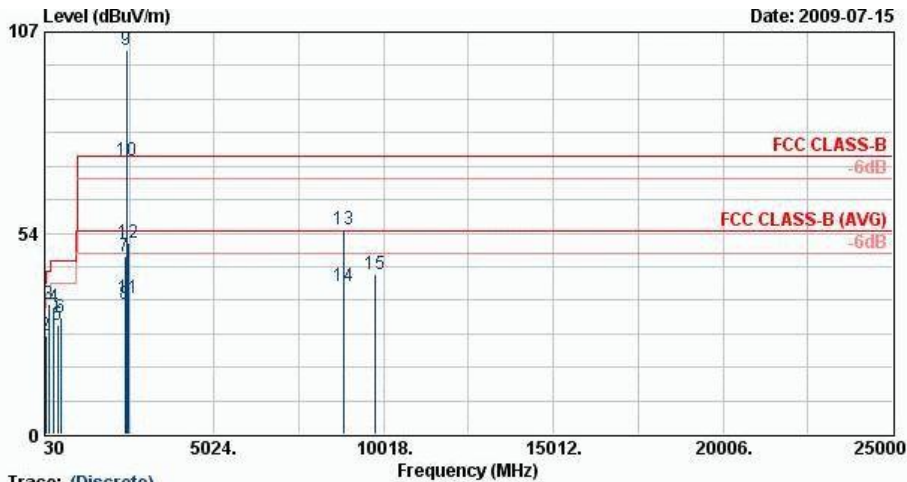

Trace: (Discrete)  
 Site : 03CH07-HY  
 Condition : FCC CLASS-B 3m SHF-EHF HORN HORIZONTAL  
 Project : FR 952730-01

|      | Freq    | Level  | Over   | Limit  | Read  | Antenna | Cable | Preamp | Ant | Table | Remark  |
|------|---------|--------|--------|--------|-------|---------|-------|--------|-----|-------|---------|
|      | MHz     | dBUV/m | dB     | dBUV/m | dBUV  | dB/m    | dB    | dB     | cm  | deg   |         |
| 1    | 30.54   | 22.62  | -17.38 | 40.00  | 34.31 | 19.36   | 0.65  | 31.70  | --- | ---   | Peak    |
| 2    | 71.58   | 26.08  | -13.92 | 40.00  | 49.87 | 6.95    | 0.97  | 31.70  | --- | ---   | Peak    |
| 3    | 145.02  | 34.49  | -9.01  | 43.50  | 52.82 | 11.88   | 1.44  | 31.65  | 100 | 111   | Peak    |
| 4    | 310.50  | 33.70  | -12.30 | 46.00  | 48.80 | 14.10   | 2.18  | 31.38  | --- | ---   | Peak    |
| 5    | 407.80  | 28.86  | -17.14 | 46.00  | 40.93 | 16.54   | 2.59  | 31.19  | --- | ---   | Peak    |
| 6    | 503.70  | 31.00  | -15.00 | 46.00  | 40.91 | 18.24   | 2.95  | 31.10  | --- | ---   | Peak    |
| 7    | 2388.00 | 47.43  | -26.57 | 74.00  | 44.34 | 32.02   | 5.46  | 34.38  | 104 | 357   | Peak    |
| 8    | 2388.00 | 34.58  | -19.42 | 54.00  | 31.49 | 32.02   | 5.46  | 34.38  | 104 | 357   | Average |
| 9 X  | 2437.00 | 102.41 |        |        | 99.32 | 32.06   | 5.41  | 34.39  | 104 | 357   | Peak    |
| 10 X | 2437.00 | 72.81  |        |        | 69.73 | 32.06   | 5.41  | 34.39  | 104 | 357   | Average |
| 11   | 2484.00 | 36.11  | -17.89 | 54.00  | 33.04 | 32.09   | 5.38  | 34.40  | 104 | 357   | Average |
| 12   | 2484.00 | 50.86  | -23.14 | 74.00  | 47.78 | 32.09   | 5.38  | 34.40  | 104 | 357   | Peak    |
| 13   | 8817.00 | 54.50  | -19.50 | 74.00  | 43.63 | 35.95   | 10.28 | 35.36  | 100 | 174   | Peak    |
| 14   | 8817.00 | 39.31  | -14.69 | 54.00  | 28.44 | 35.95   | 10.28 | 35.36  | 100 | 174   | Average |
| 15   | 9748.00 | 42.67  | -31.33 | 74.00  | 77.28 | -9.87   | 10.81 | 35.55  | 100 | 0     | Peak    |



|                 |  |                     |          |
|-----------------|--|---------------------|----------|
| Test Mode :     | Mode 2   | Temperature :       | 27~28°C  |
| Test Channel :  | 06   | Relative Humidity : | 40~41%   |
| Test Engineer : | Kay Wu   | Polarization :      | Vertical |
| Remark :        | #9 and #10 are Fundamental Signals which can be ignored. |                     |          |

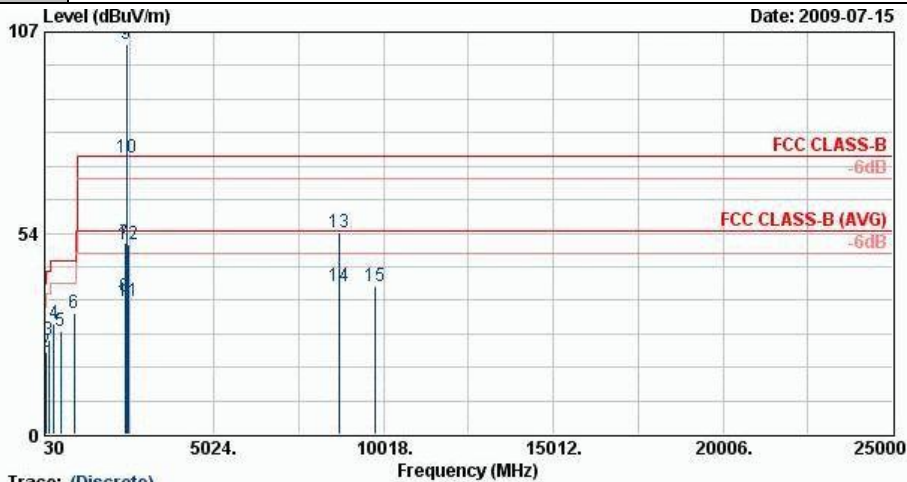

Trace: (Discrete)  
 Site : 03CH07-HY  
 Condition : FCC CLASS-B 3m SHF-EHF HORN VERTICAL  
 Project : FR 952730-01

|      | Freq    | Level  | Over   | Limit  | ReadAntenna | Cable | Preamp | Ant   | Table | Remark      |      |
|------|---------|--------|--------|--------|-------------|-------|--------|-------|-------|-------------|------|
|      | MHz     | dBuV/m | Limit  | Line   | Level       | Loss  | Factor | Pos   | Pos   |             |      |
|      |         |        | dB     | dBuV/m | dBuV        | dB    | dB     | cm    | deg   |             |      |
| 1    | 30.54   | 28.85  | -11.15 | 40.00  | 40.55       | 19.36 | 0.65   | 31.70 | 100   | 212 Peak    |      |
| 2    | 71.58   | 21.96  | -18.04 | 40.00  | 45.75       | 6.95  | 0.97   | 31.70 | ---   | ---         | Peak |
| 3    | 160.41  | 24.92  | -18.58 | 43.50  | 43.95       | 11.10 | 1.51   | 31.64 | ---   | ---         | Peak |
| 4    | 310.50  | 29.45  | -16.55 | 46.00  | 44.55       | 14.10 | 2.18   | 31.38 | ---   | ---         | Peak |
| 5    | 503.70  | 27.63  | -18.37 | 46.00  | 37.54       | 18.24 | 2.95   | 31.10 | ---   | ---         | Peak |
| 6    | 897.80  | 32.09  | -13.91 | 46.00  | 35.74       | 22.90 | 4.15   | 30.70 | ---   | ---         | Peak |
| 7    | 2390.00 | 50.78  | -23.22 | 74.00  | 47.68       | 32.02 | 5.46   | 34.38 | 100   | 314 Peak    |      |
| 8    | 2390.00 | 36.44  | -17.56 | 54.00  | 33.35       | 32.02 | 5.46   | 34.38 | 100   | 314 Average |      |
| 9 @  | 2437.00 | 103.71 |        |        | 100.62      | 32.06 | 5.41   | 34.39 | 100   | 314 Peak    |      |
| 10 X | 2437.00 | 73.44  |        |        | 70.36       | 32.06 | 5.41   | 34.39 | 100   | 314 Average |      |
| 11   | 2484.00 | 35.24  | -18.76 | 54.00  | 32.17       | 32.09 | 5.38   | 34.40 | 100   | 314 Average |      |
| 12   | 2484.00 | 50.48  | -23.52 | 74.00  | 47.41       | 32.09 | 5.38   | 34.40 | 100   | 314 Peak    |      |
| 13   | 8718.00 | 53.81  | -20.19 | 74.00  | 43.03       | 35.87 | 10.25  | 35.34 | 100   | 168 Peak    |      |
| 14   | 8718.00 | 39.25  | -14.75 | 54.00  | 28.47       | 35.87 | 10.25  | 35.34 | 100   | 168 Average |      |
| 15   | 9748.00 | 39.36  | -34.64 | 74.00  | 73.98       | -9.87 | 10.81  | 35.55 | 100   | 0 Peak      |      |





|                 |  |                     |            |
|-----------------|--|---------------------|------------|
| Test Mode :     | Mode 3   | Temperature :       | 27~28°C    |
| Test Channel :  | 11   | Relative Humidity : | 40~41%     |
| Test Engineer : | Kay Wu   | Polarization :      | Horizontal |
| Remark :        | #9 and #10 are Fundamental Signals which can be ignored. |                     |            |

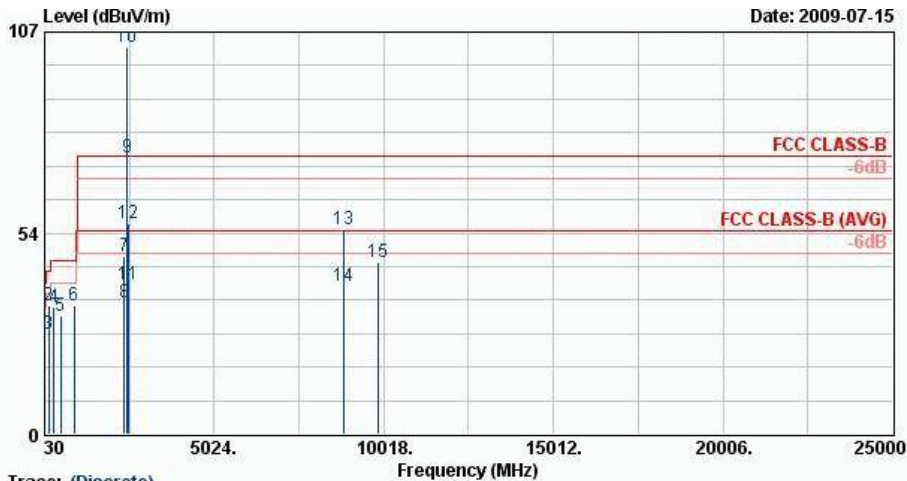

Trace: (Discrete)

Site : 03CH07-HY  
 Condition : FCC CLASS-B 3m SHF-EHF HORN HORIZONTAL  
 Project : FR 952730-01

|      | Freq    | Level  | Over   | Limit  | Read  | Antenna | Cable | Preamp | Ant | Table | Remark  |
|------|---------|--------|--------|--------|-------|---------|-------|--------|-----|-------|---------|
|      | MHz     | dBuV/m | dB     | dBuV/m | dBuV  | dB/m    | dB    | dB     | cm  | deg   |         |
| 1    | 30.54   | 23.69  | -16.31 | 40.00  | 35.38 | 19.36   | 0.65  | 31.70  | --- | ---   | Peak    |
| 2    | 145.02  | 34.26  | -9.24  | 43.50  | 52.60 | 11.88   | 1.44  | 31.65  | 100 | 222   | Peak    |
| 3    | 161.22  | 26.85  | -16.65 | 43.50  | 45.97 | 11.00   | 1.51  | 31.64  | --- | ---   | Peak    |
| 4    | 310.50  | 33.94  | -12.06 | 46.00  | 49.05 | 14.10   | 2.18  | 31.38  | --- | ---   | Peak    |
| 5    | 503.70  | 31.48  | -14.52 | 46.00  | 41.39 | 18.24   | 2.95  | 31.10  | --- | ---   | Peak    |
| 6    | 897.80  | 34.27  | -11.73 | 46.00  | 37.92 | 22.90   | 4.15  | 30.70  | --- | ---   | Peak    |
| 7    | 2382.00 | 47.41  | -26.59 | 74.00  | 44.31 | 32.00   | 5.47  | 34.38  | 104 | 356   | Peak    |
| 8    | 2382.00 | 34.83  | -19.17 | 54.00  | 31.73 | 32.00   | 5.47  | 34.38  | 104 | 356   | Average |
| 9 X  | 2462.00 | 102.98 |        |        | 70.33 | 32.07   | 5.40  | 34.39  | 104 | 356   | Average |
| 10 @ | 2462.00 | 102.98 |        |        | 99.90 | 32.07   | 5.40  | 34.39  | 104 | 356   | Peak    |
| 11   | 2483.85 | 39.79  | -14.21 | 54.00  | 36.72 | 32.09   | 5.38  | 34.40  | 104 | 356   | Average |
| 12   | 2483.85 | 56.22  | -17.78 | 74.00  | 53.15 | 32.09   | 5.38  | 34.40  | 104 | 356   | Peak    |
| 13   | 8841.00 | 54.50  | -19.50 | 74.00  | 43.61 | 35.97   | 10.29 | 35.37  | 100 | 146   | Peak    |
| 14   | 8841.00 | 39.33  | -14.67 | 54.00  | 28.44 | 35.97   | 10.29 | 35.37  | 100 | 146   | Average |
| 15   | 9848.00 | 45.57  | -28.43 | 74.00  | 79.85 | -9.63   | 10.89 | 35.53  | 100 | 0     | Peak    |



|                 |  |                     |          |
|-----------------|--|---------------------|----------|
| Test Mode :     | Mode 3   | Temperature :       | 27~28°C  |
| Test Channel :  | 11   | Relative Humidity : | 40~41%   |
| Test Engineer : | Kay Wu   | Polarization :      | Vertical |
| Remark :        | #9 and #10 are Fundamental Signals which can be ignored. |                     |          |

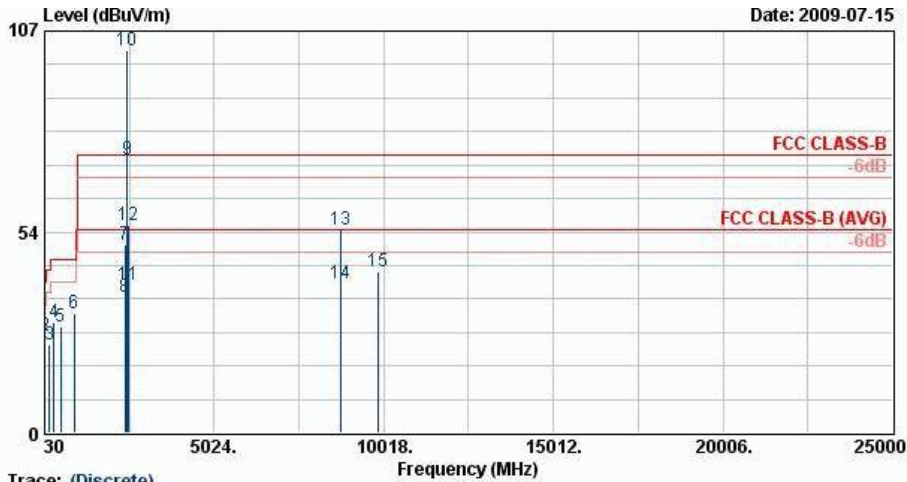

Trace: (Discrete)  
 Site : D3CH07-HY  
 Condition : FCC CLASS-B 3m SHF-EHF HORN VERTICAL  
 Project : FR 952730-01

|      | Freq    | Level  | Over   | Limit  | Read  | Antenna | Cable | Preamp | Ant | Table | Remark  |
|------|---------|--------|--------|--------|-------|---------|-------|--------|-----|-------|---------|
|      | MHz     | dBuV/m | dB     | dBuV/m | dBuV  | dB/m    | dB    | dB     | cm  | deg   |         |
| 1    | 30.54   | 30.70  | -9.30  | 40.00  | 42.39 | 19.36   | 0.65  | 31.70  | 100 | 122   | Peak    |
| 2    | 43.50   | 25.68  | -14.32 | 40.00  | 44.52 | 12.14   | 0.72  | 31.70  | --- | ---   | Peak    |
| 3    | 176.61  | 23.53  | -19.97 | 43.50  | 43.91 | 9.65    | 1.59  | 31.62  | --- | ---   | Peak    |
| 4    | 310.50  | 29.49  | -16.51 | 46.00  | 44.60 | 14.10   | 2.18  | 31.38  | --- | ---   | Peak    |
| 5    | 503.00  | 28.12  | -17.88 | 46.00  | 38.03 | 18.24   | 2.95  | 31.10  | --- | ---   | Peak    |
| 6    | 897.80  | 31.68  | -14.32 | 46.00  | 35.33 | 22.90   | 4.15  | 30.70  | --- | ---   | Peak    |
| 7    | 2390.00 | 50.32  | -23.68 | 74.00  | 47.22 | 32.02   | 5.46  | 34.38  | 100 | 124   | Peak    |
| 8    | 2390.00 | 36.33  | -17.67 | 54.00  | 33.24 | 32.02   | 5.46  | 34.38  | 100 | 124   | Average |
| 9 X  | 2462.00 | 72.65  |        |        | 69.57 | 32.07   | 5.40  | 34.39  | 100 | 124   | Average |
| 10 @ | 2462.00 | 101.70 |        |        | 98.62 | 32.07   | 5.40  | 34.39  | 100 | 124   | Peak    |
| 11   | 2483.85 | 39.25  | -14.75 | 54.00  | 36.18 | 32.09   | 5.38  | 34.40  | 100 | 124   | Average |
| 12   | 2483.85 | 55.25  | -18.75 | 74.00  | 52.18 | 32.09   | 5.38  | 34.40  | 100 | 124   | Peak    |
| 13   | 8742.00 | 54.25  | -19.75 | 74.00  | 43.46 | 35.89   | 10.25 | 35.35  | 100 | 302   | Peak    |
| 14   | 8742.00 | 39.89  | -14.11 | 54.00  | 29.10 | 35.89   | 10.25 | 35.35  | 100 | 302   | Average |
| 15   | 9848.00 | 42.94  | -31.06 | 74.00  | 77.22 | -9.63   | 10.89 | 35.53  | 100 | 0     | Peak    |



|                 |  |                     |            |
|-----------------|--|---------------------|------------|
| Test Mode :     | Mode 4   | Temperature :       | 27~28°C    |
| Test Channel :  | 01   | Relative Humidity : | 40~41%     |
| Test Engineer : | Kay Wu   | Polarization :      | Horizontal |
| Remark :        | #9 and #10 are Fundamental Signals which can be ignored. |                     |            |



Trace: (Discrete)  
 Site : 03CH07-HY  
 Condition : FCC CLASS-B 3m SHF-EHF HORN HORIZONTAL  
 Project : FR 952730-01

|      | Freq    | Level  | Over   | Limit  | Read  | Antenna | Cable | Preamp | Ant | Table | Remark  |
|------|---------|--------|--------|--------|-------|---------|-------|--------|-----|-------|---------|
|      | MHz     | dBuV/m | dB     | dBuV/m | dBuV  | dB/m    | dB    | dB     | cm  | deg   |         |
| 1    | 30.81   | 31.05  | -8.95  | 40.00  | 42.74 | 19.36   | 0.65  | 31.70  | 100 | 314   | Peak    |
| 2    | 145.02  | 34.11  | -9.39  | 43.50  | 52.45 | 11.88   | 1.44  | 31.65  | --- | ---   | Peak    |
| 3    | 216.30  | 32.95  | -13.05 | 46.00  | 52.28 | 10.46   | 1.78  | 31.57  | --- | ---   | Peak    |
| 4    | 310.50  | 32.99  | -13.01 | 46.00  | 48.10 | 14.10   | 2.18  | 31.38  | --- | ---   | Peak    |
| 5    | 407.80  | 28.95  | -17.05 | 46.00  | 41.02 | 16.54   | 2.59  | 31.19  | --- | ---   | Peak    |
| 6    | 503.70  | 31.61  | -14.39 | 46.00  | 41.52 | 18.24   | 2.95  | 31.10  | --- | ---   | Peak    |
| 7    | 2389.99 | 43.80  | -10.20 | 54.00  | 40.71 | 32.02   | 5.46  | 34.38  | 168 | 189   | Average |
| 8    | 2389.99 | 67.49  | -6.51  | 74.00  | 64.40 | 32.02   | 5.46  | 34.38  | 168 | 189   | Peak    |
| 9 @  | 2412.00 | 102.58 |        |        | 99.49 | 32.03   | 5.44  | 34.38  | 168 | 189   | Peak    |
| 10 X | 2412.00 | 76.83  |        |        | 73.74 | 32.03   | 5.44  | 34.38  | 168 | 189   | Average |
| 11   | 2494.00 | 51.50  | -22.50 | 74.00  | 48.43 | 32.10   | 5.37  | 34.40  | 168 | 189   | Peak    |
| 12   | 2494.00 | 38.04  | -15.96 | 54.00  | 34.97 | 32.10   | 5.37  | 34.40  | 168 | 189   | Average |
| 13   | 8934.00 | 53.97  | -20.03 | 74.00  | 42.99 | 36.05   | 10.32 | 35.39  | 100 | 124   | Peak    |
| 14   | 8934.00 | 38.62  | -15.38 | 54.00  | 27.64 | 36.05   | 10.32 | 35.39  | 100 | 124   | Average |
| 15   | 9648.00 | 40.84  | -33.16 | 74.00  | 75.75 | -10.09  | 10.74 | 35.57  | 100 | 0     | Peak    |



|                 |  |                     |          |
|-----------------|--|---------------------|----------|
| Test Mode :     | Mode 4   | Temperature :       | 27~28°C  |
| Test Channel :  | 01   | Relative Humidity : | 40~41%   |
| Test Engineer : | Kay Wu   | Polarization :      | Vertical |
| Remark :        | #9 and #10 are Fundamental Signals which can be ignored. |                     |          |

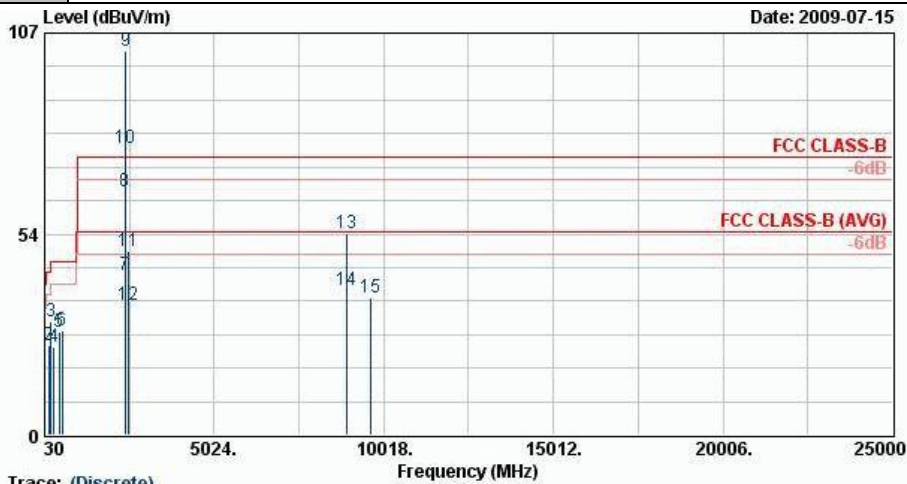

Trace: (Discrete)  
 Site : 03CH07-HY  
 Condition : FCC CLASS-B 3m SHF-EHF HORN VERTICAL  
 Project : FR 952730-01

|      | Freq    | Level  | Over   | Limit  | ReadAntenna | Cable  | Preamp | Ant   | Table | Remark      |
|------|---------|--------|--------|--------|-------------|--------|--------|-------|-------|-------------|
|      | MHz     | dBuV/m | Limit  | Line   | Level       | Loss   | Factor | Pos   | Pos   |             |
|      |         |        | dB     | dBuV/m | dBuV        | dB     | dB     | cm    | deg   |             |
| 1    | 30.00   | 29.87  | -10.13 | 40.00  | 41.03       | 19.90  | 0.64   | 31.70 | 100   | 258 Peak    |
| 2    | 145.02  | 23.67  | -19.83 | 43.50  | 42.01       | 11.88  | 1.44   | 31.65 | ---   | Peak        |
| 3    | 216.30  | 30.42  | -15.58 | 46.00  | 49.75       | 10.46  | 1.78   | 31.57 | ---   | Peak        |
| 4    | 310.50  | 23.58  | -22.42 | 46.00  | 38.68       | 14.10  | 2.18   | 31.38 | ---   | Peak        |
| 5    | 455.40  | 27.56  | -18.44 | 46.00  | 38.48       | 17.40  | 2.82   | 31.14 | ---   | Peak        |
| 6    | 551.30  | 27.92  | -18.08 | 46.00  | 36.97       | 18.91  | 3.09   | 31.05 | ---   | Peak        |
| 7    | 2389.42 | 42.46  | -11.54 | 54.00  | 39.37       | 32.02  | 5.46   | 34.38 | 100   | 147 Average |
| 8    | 2389.42 | 64.80  | -9.20  | 74.00  | 61.71       | 32.02  | 5.46   | 34.38 | 100   | 147 Peak    |
| 9 @  | 2412.00 | 102.11 |        |        | 99.02       | 32.03  | 5.44   | 34.38 | 100   | 147 Peak    |
| 10 X | 2412.00 | 76.22  |        |        | 73.13       | 32.03  | 5.44   | 34.38 | 100   | 147 Average |
| 11   | 2484.00 | 49.03  | -24.97 | 74.00  | 45.96       | 32.09  | 5.38   | 34.40 | 100   | 147 Peak    |
| 12   | 2484.00 | 34.62  | -19.38 | 54.00  | 31.55       | 32.09  | 5.38   | 34.40 | 100   | 147 Average |
| 13   | 8946.00 | 53.88  | -20.12 | 74.00  | 42.90       | 36.05  | 10.32  | 35.39 | 100   | 258 Peak    |
| 14   | 8946.00 | 38.39  | -15.61 | 54.00  | 27.41       | 36.05  | 10.32  | 35.39 | 100   | 258 Average |
| 15   | 9648.00 | 36.63  | -37.37 | 74.00  | 71.55       | -10.09 | 10.74  | 35.57 | 100   | 0 Peak      |



|                 |  |                     |            |
|-----------------|--|---------------------|------------|
| Test Mode :     | Mode 5   | Temperature :       | 27~28°C    |
| Test Channel :  | 06   | Relative Humidity : | 40~41%     |
| Test Engineer : | Kay Wu   | Polarization :      | Horizontal |
| Remark :        | #9 and #10 are Fundamental Signals which can be ignored. |                     |            |

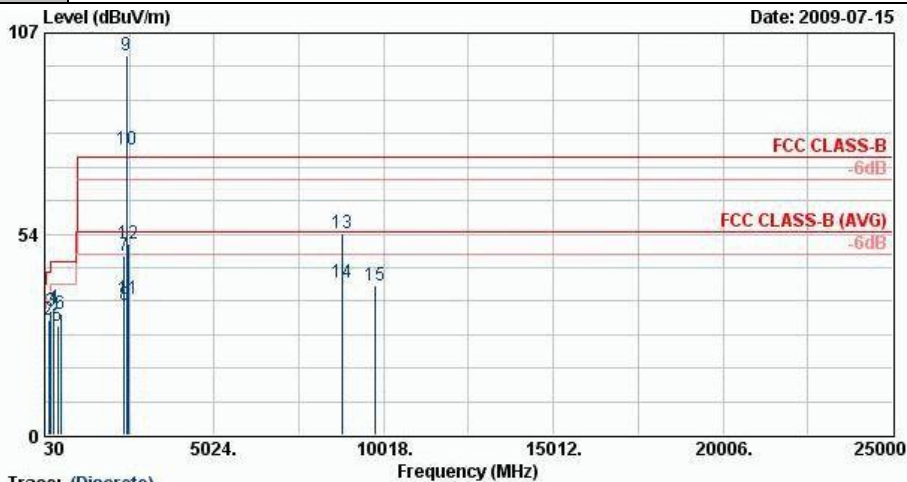

Trace: (Discrete)  
 Site : 03CH07-HY  
 Condition : FCC CLASS-B 3m SHF-EHF HORN HORIZONTAL  
 Project : FR 952730-01

|      | Freq    | Level  | Over   | Limit  | ReadAntenna | Cable | Preamp | Ant   | Table | Remark |         |
|------|---------|--------|--------|--------|-------------|-------|--------|-------|-------|--------|---------|
|      | MHz     | dBuV/m | dB     | dBuV/m | dBuV        | dB/m  | dB     | dB    | cm    | deg    |         |
| 1    | 30.54   | 27.78  | -12.22 | 40.00  | 39.47       | 19.36 | 0.65   | 31.70 | ---   | ---    | Peak    |
| 2    | 144.21  | 30.72  | -12.78 | 43.50  | 49.03       | 11.92 | 1.43   | 31.66 | ---   | ---    | Peak    |
| 3    | 216.30  | 32.93  | -13.07 | 46.00  | 52.26       | 10.46 | 1.78   | 31.57 | ---   | ---    | Peak    |
| 4    | 310.50  | 33.88  | -12.12 | 46.00  | 48.99       | 14.10 | 2.18   | 31.38 | 100   | 147    | Peak    |
| 5    | 407.80  | 28.96  | -17.04 | 46.00  | 41.02       | 16.54 | 2.59   | 31.19 | ---   | ---    | Peak    |
| 6    | 503.00  | 32.23  | -13.77 | 46.00  | 42.14       | 18.24 | 2.95   | 31.10 | ---   | ---    | Peak    |
| 7    | 2374.00 | 47.57  | -26.43 | 74.00  | 44.47       | 32.00 | 5.47   | 34.38 | 102   | 357    | Peak    |
| 8    | 2374.00 | 34.60  | -19.40 | 54.00  | 31.50       | 32.00 | 5.47   | 34.38 | 102   | 357    | Average |
| 9 X  | 2437.00 | 101.12 |        |        | 98.04       | 32.06 | 5.41   | 34.39 | 102   | 357    | Peak    |
| 10 X | 2437.00 | 75.90  |        |        | 72.82       | 32.06 | 5.41   | 34.39 | 102   | 357    | Average |
| 11   | 2486.00 | 36.26  | -17.74 | 54.00  | 33.19       | 32.09 | 5.38   | 34.40 | 102   | 357    | Average |
| 12   | 2486.00 | 50.97  | -23.03 | 74.00  | 47.90       | 32.09 | 5.38   | 34.40 | 102   | 357    | Peak    |
| 13   | 8781.00 | 53.86  | -20.14 | 74.00  | 43.02       | 35.93 | 10.27  | 35.36 | 100   | 179    | Peak    |
| 14   | 8781.00 | 40.42  | -13.58 | 54.00  | 29.58       | 35.93 | 10.27  | 35.36 | 100   | 179    | Average |
| 15   | 9748.00 | 39.78  | -34.22 | 74.00  | 74.39       | -9.87 | 10.81  | 35.55 | 100   | 0      | Peak    |



|                 |  |                     |          |
|-----------------|--|---------------------|----------|
| Test Mode :     | Mode 5   | Temperature :       | 27~28°C  |
| Test Channel :  | 06   | Relative Humidity : | 40~41%   |
| Test Engineer : | Kay Wu   | Polarization :      | Vertical |
| Remark :        | #9 and #10 are Fundamental Signals which can be ignored. |                     |          |

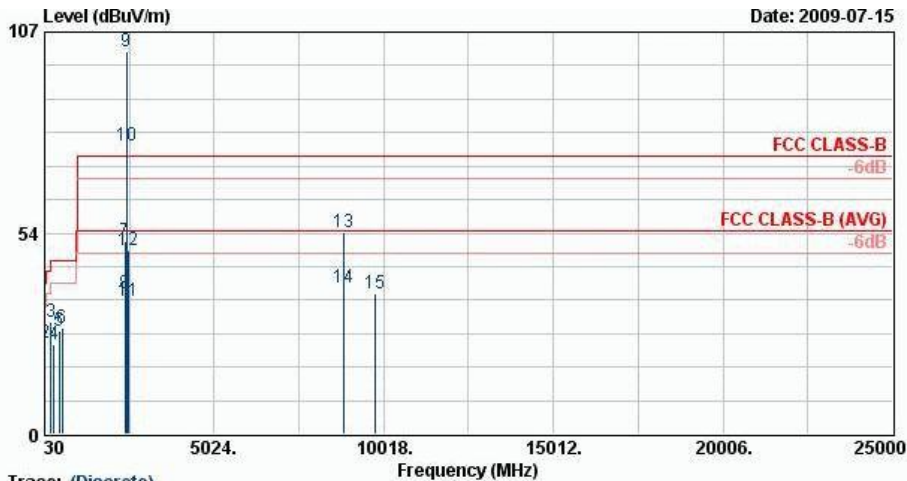

Trace: (Discrete)  
 Site : 03CH07-HY  
 Condition : FCC CLASS-B 3m SHF-EHF HORN VERTICAL  
 Project : FR 952730-01

|      | Freq    | Level  | Over   | Limit  | Read  | Antenna | Cable | Preamp | Ant | Table | Remark  |
|------|---------|--------|--------|--------|-------|---------|-------|--------|-----|-------|---------|
|      | MHz     | dBUV/m | dB     | dBUV/m | dBUV  | dB/m    | dB    | dB     | cm  | deg   |         |
| 1    | 30.54   | 31.42  | -8.58  | 40.00  | 43.11 | 19.36   | 0.65  | 31.70  | 100 | 312   | Peak    |
| 2    | 43.77   | 24.33  | -15.67 | 40.00  | 43.17 | 12.14   | 0.72  | 31.70  | --- | ---   | Peak    |
| 3    | 216.30  | 29.89  | -16.11 | 46.00  | 49.22 | 10.46   | 1.78  | 31.57  | --- | ---   | Peak    |
| 4    | 310.50  | 24.05  | -21.95 | 46.00  | 39.15 | 14.10   | 2.18  | 31.38  | --- | ---   | Peak    |
| 5    | 455.40  | 27.51  | -18.49 | 46.00  | 38.43 | 17.40   | 2.82  | 31.14  | --- | ---   | Peak    |
| 6    | 551.30  | 28.06  | -17.94 | 46.00  | 37.10 | 18.91   | 3.09  | 31.05  | --- | ---   | Peak    |
| 7    | 2388.00 | 51.48  | -22.52 | 74.00  | 48.38 | 32.02   | 5.46  | 34.38  | 100 | 314   | Peak    |
| 8    | 2388.00 | 37.22  | -16.78 | 54.00  | 34.13 | 32.02   | 5.46  | 34.38  | 100 | 314   | Average |
| 9 @  | 2437.00 | 101.96 |        |        | 98.88 | 32.06   | 5.41  | 34.39  | 100 | 314   | Peak    |
| 10 X | 2437.00 | 76.57  |        |        | 73.49 | 32.06   | 5.41  | 34.39  | 100 | 314   | Average |
| 11   | 2492.00 | 35.42  | -18.58 | 54.00  | 32.35 | 32.10   | 5.37  | 34.40  | 100 | 314   | Average |
| 12   | 2492.00 | 48.94  | -25.06 | 74.00  | 45.87 | 32.10   | 5.37  | 34.40  | 100 | 314   | Peak    |
| 13   | 8841.00 | 53.86  | -20.14 | 74.00  | 42.97 | 35.97   | 10.29 | 35.37  | 100 | 194   | Peak    |
| 14   | 8841.00 | 39.02  | -14.98 | 54.00  | 28.13 | 35.97   | 10.29 | 35.37  | 100 | 194   | Average |
| 15   | 9748.00 | 37.35  | -36.65 | 74.00  | 71.96 | -9.87   | 10.81 | 35.55  | 100 | 0     | Peak    |



|                 |  |                     |            |
|-----------------|--|---------------------|------------|
| Test Mode :     | Mode 6   | Temperature :       | 27~28°C    |
| Test Channel :  | 11   | Relative Humidity : | 40~41%     |
| Test Engineer : | Kay Wu   | Polarization :      | Horizontal |
| Remark :        | #9 and #10 are Fundamental Signals which can be ignored. |                     |            |

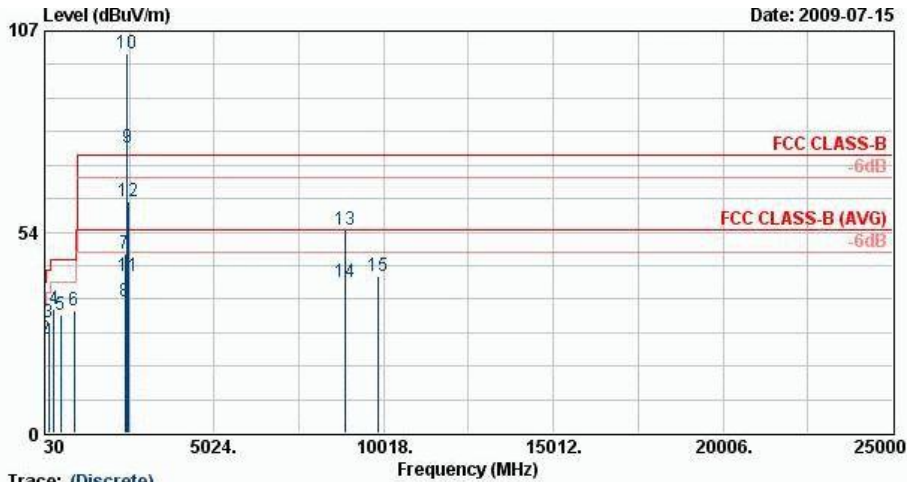

Trace: (Discrete)  
 Site : 03CH07-HY  
 Condition : FCC CLASS-B 3m SHF-EHF HORN HORIZONTAL  
 Project : FR 952730-01

|      | Freq    | Level  | Over   | Limit  | Read  | Antenna | Cable | Preamp | Ant | Table | Remark  |
|------|---------|--------|--------|--------|-------|---------|-------|--------|-----|-------|---------|
|      | MHz     | dBuV/m | dB     | dBuV/m | dBuV  | dB/m    | dB    | dB     | cm  | deg   |         |
| 1    | 30.54   | 32.41  | -7.59  | 40.00  | 44.11 | 19.36   | 0.65  | 31.70  | 100 | 248   | Peak    |
| 2    | 43.50   | 24.89  | -15.11 | 40.00  | 43.72 | 12.14   | 0.72  | 31.70  | --- | ---   | Peak    |
| 3    | 144.21  | 29.35  | -14.15 | 43.50  | 47.65 | 11.92   | 1.43  | 31.66  | --- | ---   | Peak    |
| 4    | 310.50  | 33.14  | -12.86 | 46.00  | 48.24 | 14.10   | 2.18  | 31.38  | --- | ---   | Peak    |
| 5    | 503.00  | 31.46  | -14.54 | 46.00  | 41.36 | 18.24   | 2.95  | 31.10  | --- | ---   | Peak    |
| 6    | 897.80  | 32.42  | -13.58 | 46.00  | 36.07 | 22.90   | 4.15  | 30.70  | --- | ---   | Peak    |
| 7    | 2388.00 | 47.66  | -26.34 | 74.00  | 44.57 | 32.02   | 5.46  | 34.38  | 104 | 356   | Peak    |
| 8    | 2388.00 | 35.14  | -18.86 | 54.00  | 32.05 | 32.02   | 5.46  | 34.38  | 104 | 356   | Average |
| 9 X  | 2462.00 | 75.86  |        |        | 72.78 | 32.07   | 5.40  | 34.39  | 104 | 356   | Average |
| 10 X | 2462.00 | 101.07 |        |        | 97.99 | 32.07   | 5.40  | 34.39  | 104 | 356   | Peak    |
| 11   | 2483.50 | 41.71  | -12.29 | 54.00  | 38.64 | 32.09   | 5.38  | 34.40  | 104 | 356   | Average |
| 12   | 2483.50 | 61.72  | -12.28 | 74.00  | 58.65 | 32.09   | 5.38  | 34.40  | 104 | 356   | Peak    |
| 13   | 8862.00 | 54.13  | -19.87 | 74.00  | 43.23 | 35.98   | 10.29 | 35.37  | 100 | 245   | Peak    |
| 14   | 8862.00 | 40.27  | -13.73 | 54.00  | 29.37 | 35.98   | 10.29 | 35.37  | 100 | 245   | Average |
| 15   | 9848.00 | 41.73  | -32.27 | 74.00  | 76.00 | -9.63   | 10.89 | 35.53  | 100 | 0     | Peak    |



|                 |  |                     |          |
|-----------------|--|---------------------|----------|
| Test Mode :     | Mode 6   | Temperature :       | 27~28°C  |
| Test Channel :  | 11   | Relative Humidity : | 40~41%   |
| Test Engineer : | Kay Wu   | Polarization :      | Vertical |
| Remark :        | #9 and #10 are Fundamental Signals which can be ignored. |                     |          |

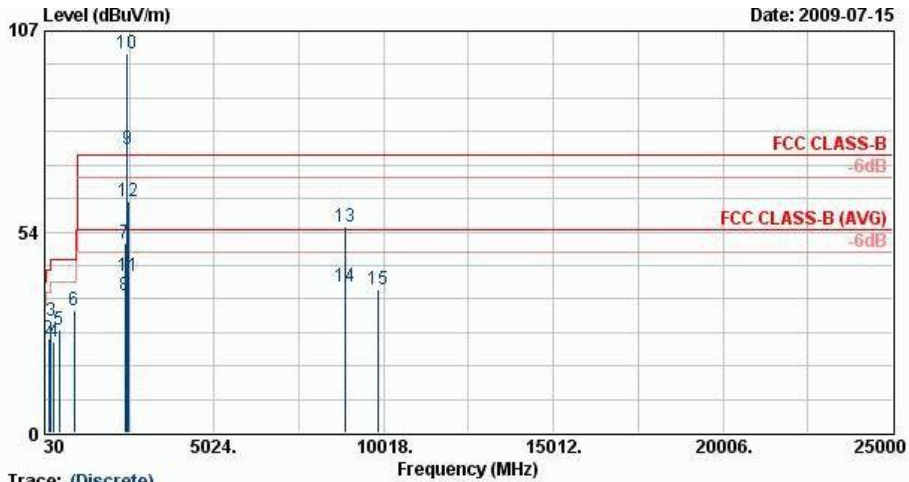

Trace: (Discrete)  
 Site : D3CH07-HY  
 Condition : FCC CLASS-B 3m SHF-EHF HORN VERTICAL  
 Project : FR 952730-01

|      | Freq    | Level  | Over   | Limit  | Read  | Antenna | Cable | Preamp | Ant | Table | Remark  |
|------|---------|--------|--------|--------|-------|---------|-------|--------|-----|-------|---------|
|      | MHz     | dBuV/m | dB     | dBuV/m | dBuV  | dB/m    | dB    | dB     | cm  | deg   |         |
| 1    | 30.54   | 25.27  | -14.73 | 40.00  | 36.96 | 19.36   | 0.65  | 31.70  | --- | ---   | Peak    |
| 2    | 145.02  | 25.17  | -18.33 | 43.50  | 43.51 | 11.88   | 1.44  | 31.65  | --- | ---   | Peak    |
| 3    | 216.30  | 29.68  | -16.32 | 46.00  | 49.01 | 10.46   | 1.78  | 31.57  | --- | ---   | Peak    |
| 4    | 310.50  | 24.38  | -21.62 | 46.00  | 39.49 | 14.10   | 2.18  | 31.38  | --- | ---   | Peak    |
| 5    | 455.40  | 27.42  | -18.58 | 46.00  | 38.35 | 17.40   | 2.82  | 31.14  | --- | ---   | Peak    |
| 6    | 897.80  | 32.66  | -13.34 | 46.00  | 36.30 | 22.90   | 4.15  | 30.70  | 100 | 156   | Peak    |
| 7    | 2390.00 | 50.42  | -23.58 | 74.00  | 47.32 | 32.02   | 5.46  | 34.38  | 100 | 125   | Peak    |
| 8    | 2390.00 | 36.48  | -17.52 | 54.00  | 33.39 | 32.02   | 5.46  | 34.38  | 100 | 125   | Average |
| 9 X  | 2462.00 | 75.72  |        |        | 72.64 | 32.07   | 5.40  | 34.39  | 100 | 125   | Average |
| 10 @ | 2462.00 | 101.10 |        |        | 98.02 | 32.07   | 5.40  | 34.39  | 100 | 125   | Peak    |
| 11   | 2483.50 | 41.79  | -12.21 | 54.00  | 38.72 | 32.09   | 5.38  | 34.40  | 100 | 125   | Average |
| 12   | 2483.50 | 61.49  | -12.51 | 74.00  | 58.42 | 32.09   | 5.38  | 34.40  | 100 | 125   | Peak    |
| 13   | 8865.00 | 54.85  | -19.15 | 74.00  | 43.93 | 35.99   | 10.30 | 35.37  | 100 | 247   | Peak    |
| 14   | 8865.00 | 38.83  | -15.17 | 54.00  | 27.91 | 35.99   | 10.30 | 35.37  | 100 | 247   | Average |
| 15   | 9848.00 | 38.01  | -35.99 | 74.00  | 72.27 | -9.63   | 10.90 | 35.53  | 100 | 0     | Peak    |





## **3.8 Antenna Requirements**

### **3.8.1 Standard Applicable**

If directional gain of transmitting antennas is greater than 6dBi, the power shall be reduced by the same level in dB comparing to gain minus 6dBi. For the fixed point-to-point operation, the power shall be reduced by one dB for every 3 dB that the directional gain of the antenna exceeds 6 dBi. The use of a permanently attached antenna or of an antenna that uses a unique coupling to the intentional radiator shall be considered sufficient to comply with the FCC rule.

### **3.8.2 Antenna Connected Construction**

The antennas type used in this product is PIFA Antenna without connector and it is considered to meet antenna requirement.

### **3.8.3 Antenna Gain**

The antenna peak gain of EUT is less than 6 dBi. Therefore, it is not necessary to reduce maximum peak output power limit.



## 4 List of Measuring Equipment

| Instrument                | Manufacturer | Model No. | Serial No. | Characteristics          | Calibration Date | Due Date      | Remark                |
|---------------------------|--------------|-----------|------------|--------------------------|------------------|---------------|-----------------------|
| Spectrum Analyzer         | R&S          | FSP40     | 100055     | 9kHz~40GHz               | Jun. 23, 2009    | Jun. 22, 2010 | Conducted (TH02-HY)   |
| Power Meter               | Agilent      | E4416A    | GB41292344 | N/A                      | Feb. 19, 2009    | Feb. 18, 2010 | Conducted (TH02-HY)   |
| Power Sensor              | Agilent      | E9327A    | US40441548 | N/A                      | Feb. 19, 2009    | Feb. 18, 2010 | Conducted (TH02-HY)   |
| EMI Receiver              | R&S          | ESCS 30   | 100356     | 9kHz~2.75GHz             | Aug. 01, 2008    | Jul. 31, 2009 | Conduction (CO05-HY)  |
| Two-LISN                  | R&S          | ENV216    | 11-100081  | 9kHz~30MHz               | Nov. 26, 2008    | Nov. 25, 2009 | Conduction (CO05-HY)  |
| Two-LISN                  | R&S          | ENV216    | 11-100080  | 9kHz~30MHz               | Nov. 26, 2008    | Nov. 25, 2009 | Conduction (CO05-HY)  |
| AC Power Source           | APC          | APC-1000W | N/A        | N/A                      | N/A              | N/A           | Conduction (CO05-HY)  |
| Bilog Antenna             | SCHAFFNER    | CBL6111C  | 2726       | 30MHz~1GHz               | Nov. 20, 2008    | Nov. 19, 2009 | Radiation (03CH07-HY) |
| Spectrum Analyzer         | R&S          | FSP       | 101067     | 9kHz~30GHz               | Dec. 02, 2008    | Dec. 01, 2009 | Radiation (03CH07-HY) |
| Double Ridge Horn Antenna | ESCO         | 3117      | 00075962   | 1G~18GHz                 | Aug. 18, 2008    | Aug. 17, 2009 | Radiation (03CH07-HY) |
| Pre Amplifier             | Agilent      | 8449B     | 3008A02362 | 1G~26.5GHz               | Dec. 17, 2008    | Dec. 16, 2009 | Radiation (03CH07-HY) |
| Pre Amplifier             | COM-POWER    | PA-103A   | 161241     | 10~1000MHz.<br>32dB.GAIN | Mar. 27, 2009    | Mar. 26, 2010 | Radiation (03CH07-HY) |
| Double Ridge Horn Antenna | ESCO         | 3117      | 00066584   | 1G~18GHz                 | Aug. 06, 2008    | Aug. 05, 2009 | Radiation (03CH07-HY) |
| Loop Antenna              | R&S          | HFH2-Z2   | 860004/001 | 9 kHz~30 MHz             | May 22, 2008     | May 21, 2010  | Radiation (03CH07-HY) |

## 5 Uncertainty of Evaluation

### Uncertainty of Conducted Emission Measurement (150 kHz ~ 30 MHz)

| Contribution   | Uncertainty of $x_i$ |                          | $u(x_i)$ |
|--|----------------------|--------------------------|----------|
|  | dB                   | Probability Distribution |          |
| Receiver reading   | 0.10                 | Normal(k=2)              | 0.05     |
| Cable loss   | 0.10                 | Normal(k=2)              | 0.05     |
| AMN insertion loss   | 2.50                 | Rectangular              | 0.63     |
| Receiver Spec  | 1.50                 | Rectangular              | 0.43     |
| Site imperfection  | 1.39                 | Rectangular              | 0.80     |
| Mismatch   | +0.34/-0.35          | U-shape                  | 0.24     |
| <b>Combined standard uncertainty Uc(y)</b>                             | <b>1.13</b>          |                          |          |
| <b>Measuring uncertainty for a level of confidence of 95% U=2Uc(y)</b> | <b>2.26</b>          |                          |          |

### Uncertainty of Radiated Emission Measurement (30 MHz ~ 1000 MHz)

| Contribution   | Uncertainty of $x_i$ |                          | $u(x_i)$ |
|--|----------------------|--------------------------|----------|
|  | dB                   | Probability Distribution |          |
| Receiver reading   | 0.41                 | Normal(k=2)              | 0.21     |
| Antenna factor calibration   | 0.83                 | Normal(k=2)              | 0.42     |
| Cable loss calibration   | 0.25                 | Normal(k=2)              | 0.13     |
| Pre Amplifier Gain calibration   | 0.27                 | Normal(k=2)              | 0.14     |
| RCV/SPA specification  | 2.50                 | Rectangular              | 0.72     |
| Antenna Factor Interpolation for Frequency                             | 1.00                 | Rectangular              | 0.29     |
| Site imperfection  | 1.43                 | Rectangular              | 0.83     |
| Mismatch   | +0.39/-0.41          | U-shaped                 | 0.28     |
| <b>Combined standard uncertainty Uc(y)</b>                             | <b>1.27</b>          |                          |          |
| <b>Measuring uncertainty for a level of confidence of 95% U=2Uc(y)</b> | <b>2.54</b>          |                          |          |



**Uncertainty of Radiated Emission Measurement (1 GHz ~ 40 GHz)**

| Contribution  | Uncertainty of $x_i$ |                          | $u(x_i)$ | $C_i$ | $C_i * u(x_i)$ |
|---|----------------------|--------------------------|----------|-------|----------------|
|   | dB                   | Probability Distribution |          |       |                |
| Receiver reading  | ±0.10                | Normal(k=1)              | 0.10     | 1     | 0.10           |
| Antenna factor calibration  | ±1.70                | Normal(k=2)              | 0.85     | 1     | 0.85           |
| Cable loss calibration  | ±0.50                | Normal(k=2)              | 0.25     | 1     | 0.25           |
| Receiver Correction   | ±2.00                | Rectangular              | 1.15     | 1     | 1.15           |
| Antenna Factor Directional  | ±1.50                | Rectangular              | 0.87     | 1     | 0.87           |
| Site imperfection   | ±2.80                | Triangular               | 1.14     | 1     | 1.14           |
| Mismatch<br>Receiver VSWR $\Gamma_1 = 0.197$<br>Antenna VSWR $\Gamma_2 = 0.194$<br>Uncertainty = $20 \log(1 - \Gamma_1 * \Gamma_2)$ | +0.34/-0.35          | U-shaped                 | 0.244    | 1     | 0.244          |
| <b>Combined standard uncertainty <math>U_c(y)</math></b>  | <b>2.36</b>          |                          |          |       |                |
| <b>Measuring uncertainty for a level of confidence of 95% <math>U = 2U_c(y)</math></b>  | <b>4.72</b>          |                          |          |       |                |

## 6 Certification of TAF Accreditation



Certificate No. : L1190-090417

財團法人全國認證基金會  
Taiwan Accreditation Foundation

### Certificate of Accreditation

This is to certify that

**Sporton International Inc.**  
**EMC & Wireless Communications Laboratory**  
No.52, Hwa Ya 1st Rd., Hwa Ya Technology Park, Kwei-Shan Hsiang, Tao Yuan Hsien,  
Taiwan, R.O.C.

**is accredited in respect of laboratory**

|                                       |  |
|---------------------------------------|--|
| <b>Accreditation Criteria</b>         | : ISO/IEC 17025:2005   |
| <b>Accreditation Number</b>           | : 1190   |
| <b>Originally Accredited</b>          | : December 15, 2003  |
| <b>Effective Period</b>               | : January 10, 2007 to January 09, 2010   |
| <b>Accredited Scope</b>               | : Testing Field, see described in the Appendix   |
| <b>Specific Accreditation Program</b> | : Accreditation Program for Designated Testing Laboratory for Commodities Inspection<br>Accreditation Program for Telecommunication Equipment Testing Laboratory<br>Accreditation Program for BSMI Mutual Recognition Arrangement with Foreign Authorities |

  
Jay-San Chen  
President, Taiwan Accreditation Foundation  
Date : April 17, 2009

Pl, total 20 pages

The Appendix forms an integral part of this Certificate, which shall be invalid when use without the Appendix



## **Appendix A. Photographs of EUT**

Please refer to Sporton report number EP952730-01 as below.