

FCC C2PC Test Report

FCC ID : JVPRX-80
Equipment : USB Wireless Receiver
Model No. : RX-80
Brand Name : ZOWIE
Applicant : BENQ CORPORATION
Address : 16 Jihu Road, Neihu, Taipei 114, Taiwan
Standard : 47 CFR FCC Part 15.249
Received Date : Jul. 24, 2023
Tested Date : Aug. 01 ~ Aug. 03, 2023

We, International Certification Corporation, would like to declare that the tested sample has been evaluated and in compliance with the requirement of the above standards. The test results contained in this report refer exclusively to the product. It shall not be reproduced except in full without the written approval of our laboratory.

Reviewed by:

Approved by:

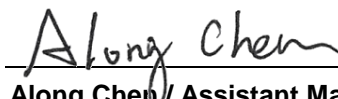

Along Chen / Assistant Manager



Gary Chang / Manager

Table of Contents

1	GENERAL DESCRIPTION	5
1.1	Information.....	5
1.2	Local Support Equipment List	7
1.3	Test Setup Chart	7
1.4	The Equipment List	8
1.5	Test Standards	9
1.6	Deviation from Test Standard and Measurement Procedure.....	9
1.7	Measurement Uncertainty	9
2	TEST CONFIGURATION	10
2.1	Testing Facility.....	10
2.2	The Worst Test Modes and Channel Details	10
3	TRANSMITTER TEST RESULTS.....	11
3.1	Unwanted Emission.....	11
3.2	20dB and Occupied Bandwidth	14
3.3	AC Power Line Conducted Emissions	15
4	TEST LABORATORY INFORMATION	16
Appendix A. Unwanted Emission		
Appendix B. 20dB and Occupied Bandwidth		
Appendix C. AC Power Line Conducted Emissions		

Release Record

Report No.	Version	Description	Issued Date
FR260610-03	Rev. 01	Initial issue	Sep. 04, 2023

Summary of Test Results

FCC Rules	Test Items	Measured	Result
15.207	AC Power Line Conducted Emissions	[dBuV]: 2.321MHz 26.57 (Margin -19.43dB) - AV	Pass
15.249(a)	Field Strength of Fundamental	Meet the requirement of limit	Pass
15.249(a)(d)	Field Strength of Harmonics and Emissions Radiated outside of the Specified Frequency Bands	Meet the requirement of limit	Pass
15.215(c)	20dB bandwidth	Meet the requirement of limit	Pass
15.203	Antenna Requirement	Meet the requirement of limit	Pass

Declaration of Conformity:

The test results with all measurement uncertainty excluded are presented in accordance with the regulation limits or requirements declared by manufacturers.

Comments and Explanations:

The declared of product specification for EUT presented in the report are provided by the manufacturer, and the manufacturer takes all the responsibilities for the accuracy of product specification.

1 General Description

1.1 Information

This is a Class II Permissive Change report (C2PC).

This report is issued as a supplementary report to original report no. FR260610-01. The modifications are concerned with following items:

- Adding channels for 2 Mbps data rate by software setting.
- Adding one USB cable (2.0m).
- Changing model name for original USB cable (2.05m)
- Antenna gain changed.

All related test items had been performed and recorded in the following sections.

1.1.1 Specification of the Equipment under Test (EUT)

RF General Information				
Frequency Range (MHz)	Modulation	Ch. Freq. (MHz)	Channel Number	Data Rate
2400-2483.5	GFSK	2403-2481	1-79 [79]	2 Mbps

1.1.2 Antenna Details

Ant. No.	Brand	Model	Type	Connector	Gain (dBi)
1	BENQ Corporation	USB Receiver ANT	Printed Antenna	N/A	0.09

1.1.3 Power Supply Type of Equipment under Test (EUT)

Power Type	5Vdc from host
------------	----------------

1.1.4 Accessories (New addition is marked in boldface.)

Accessories		
No.	Equipment	Description
1	USB cable	Brand: Le Prestique Electronics Manufacturing Ltd. Model: F41-2500-083-005 2.0m shielded without core
2	USB cable	Brand: Le Prestique Electronics Manufacturing Model: F41-2500-061-004 2.05m non-shielded with one core
3	USB adapter	Brand: BENQ Corporation Model: USB Adapter

1.1.5 Channel List

Channel	Frequency (MHz)	Channel	Frequency (MHz)	Channel	Frequency (MHz)	Channel	Frequency (MHz)
1	2403	21	2423	41	2443	61	2463
2	2404	22	2424	42	2444	62	2464
3	2405	23	2425	43	2445	63	2465
4	2406	24	2426	44	2446	64	2466
5	2407	25	2427	45	2447	65	2467
6	2408	26	2428	46	2448	66	2468
7	2409	27	2429	47	2449	67	2469
8	2410	28	2430	48	2450	68	2470
9	2411	29	2431	49	2451	69	2471
10	2412	30	2432	50	2452	70	2472
11	2413	31	2433	51	2453	71	2473
12	2414	32	2434	52	2454	72	2474
13	2415	33	2435	53	2455	73	2475
14	2416	34	2436	54	2456	74	2476
15	2417	35	2437	55	2457	75	2477
16	2418	36	2438	56	2458	76	2478
17	2419	37	2439	57	2459	77	2479
18	2420	38	2440	58	2460	78	2480
19	2421	39	2441	59	2461	79	2481
20	2422	40	2442	60	2462	--	--

1.1.6 Test Tool and Duty Cycle

Test Tool	Radio test, Version: 1.0.0.0	
Duty Cycle and Duty Factor	Duty Cycle (%)	Duty Factor (dB)
	12.41	9.06

1.1.7 Power Index of Test Tool

Modulation Mode	Test Frequency (MHz)		
	2403	2441	2481
GFSK	4dBm	4dBm	4dBm

1.2 Local Support Equipment List

Support Equipment List					
No.	Equipment	Brand	Model	FCC ID	Remarks
1	Laptop	DELL	Latitude 5400	DoC	---

1.3 Test Setup Chart

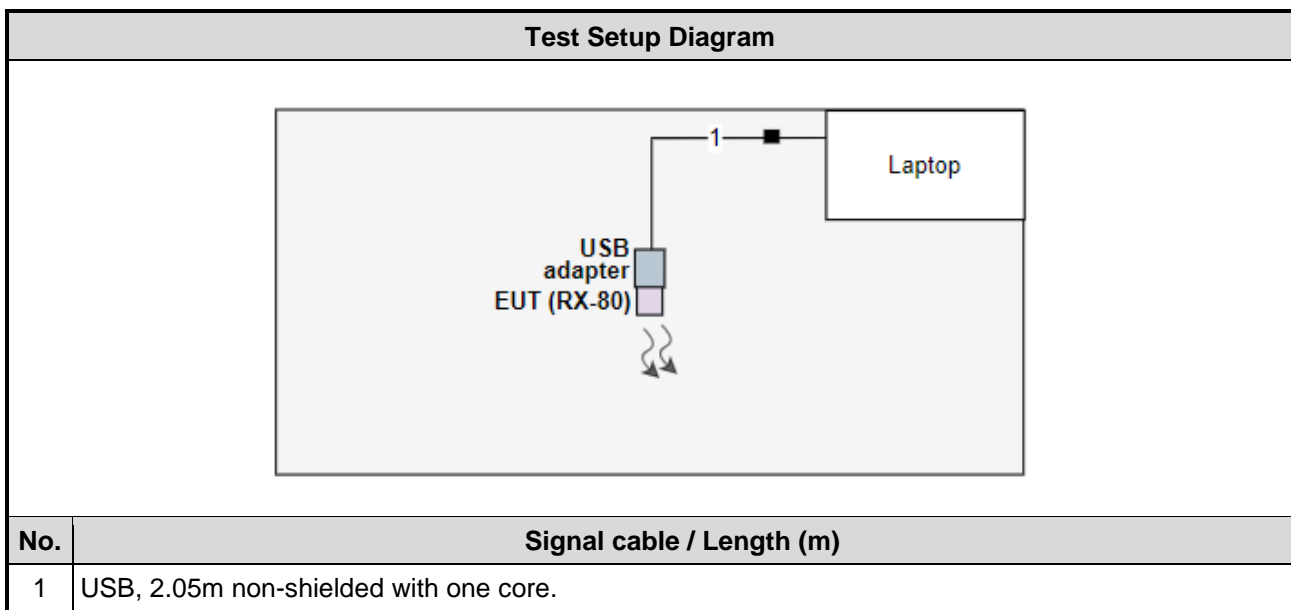

1.4 The Equipment List

Test Item	Conducted Emission				
Test Site	Conduction room 1 / (CO01-WS)				
Tested Date	Aug. 03 .2023				
Instrument	Brand	Model No.	Serial No.	Calibration Date	Calibration Until
Receiver	R&S	ESR3	101658	Feb. 17, 2023	Feb. 16, 2024
LISN	R&S	ENV216	101579	May 09, 2023	May 08, 2024
LISN (Support Unit)	SCHWARZBECK	Schwarzbeck 8127	8127667	Jan .03, 2023	Jan .02, 2024
RF Cable-CON	Woken	CFD200-NL	CFD200-NL-001	Oct. 17, 2022	Oct. 16, 2023
50 ohm terminal (Support Unit)	NA	50	01	Jun. 14, 2023	Jun. 13, 2024
Measurement Software	AUDIX	e3	6.120210k	NA	NA
Note: Calibration Interval of instruments listed above is one year.					

Test Item	Radiated Emission				
Test Site	966 chamber3 / (03CH03-WS)				
Tested Date	Aug. 01, 2023				
Instrument	Brand	Model No.	Serial No.	Calibration Date	Calibration Until
Receiver	R&S	ESR3	101657	Mar. 03, 2023	Mar. 02, 2024
Spectrum Analyzer	R&S	FSV40	101499	Mar. 16, 2023	Mar. 15, 2024
Loop Antenna	R&S	HFH2-Z2	100330	Nov. 01, 2022	Oct. 31, 2023
Bilog Antenna	SCHWARZBECK	VULB9168	VULB9168-685	Jul. 04, 2023	Jul. 03, 2024
Horn Antenna 1G-18G	SCHWARZBECK	BBHA 9120 D	BBHA 9120 D 1206	Dec. 15, 2022	Dec. 14, 2023
Horn Antenna 18G-40G	SCHWARZBECK	BBHA 9170	BBHA 9170517	Oct. 27, 2022	Oct. 26, 2023
Preamplifier	EMC	EMC02325	980187	Jul. 10, 2023	Jul. 09, 2024
Preamplifier	Agilent	83017A	MY39501308	Oct. 26, 2022	Oct. 25, 2023
Preamplifier	EMC	EMC184045SE	980903	Jul. 17, 2023	Jul. 16, 2024
Loop Antenna Cable	KOAX KABEL	101354-BW	101354-BW	Oct. 04, 2022	Oct. 03, 2023
LF cable-0.8M	EMC	EMC8D-NM-NM-800	EMC8D-NM-NM-800-001	Sep. 23, 2022	Sep. 22, 2023
LF cable-3M	EMC	EMC8D-NM-NM-3000	131103	Sep. 23, 2022	Sep. 22, 2023
LF cable-13M	EMC	EMC8D-NM-NM-13000	131104	Sep. 23, 2022	Sep. 22, 2023
RF cable-3M	HUBER+SUHNER	SUCOFLEX104	MY22620/4	Sep. 23, 2022	Sep. 22, 2023
RF cable-8M	EMC	EMC104-SM-SM-8000	181107	Sep. 23, 2022	Sep. 22, 2023
Attenuator	Pasternack	PE7005-10	10-3	Oct. 14, 2022	Oct. 13, 2023
HIGHPASS FILTER	WI	WHK3.1-18G-10SS	43	Sep. 28, 2022	Sep. 27, 2023
Measurement Software	AUDIX	e3	6.120210g	NA	NA
Note: Calibration Interval of instruments listed above is one year.					

1.5 Test Standards

47 CFR FCC Part 15.249
ANSI C63.10-2013

1.6 Deviation from Test Standard and Measurement Procedure

None

1.7 Measurement Uncertainty

The measurement uncertainties given below are based on a 95% confidence level (based on a coverage factor ($k=2$)).

Measurement Uncertainty	
Parameters	Uncertainty
Bandwidth	± 34.130 Hz
AC conducted emission	± 2.92 dB
Unwanted Emission ≤ 1 GHz	± 3.96 dB
Unwanted Emission > 1 GHz	± 4.51 dB

2 Test Configuration

2.1 Testing Facility

Test Laboratory	International Certification Corporation
Test Site	CO01-WS
Address of Test Site	No.3-1, Lane 6, Wen San 3rd St., Kwei Shan Dist., Tao Yuan City 33381, Taiwan (R.O.C.)
Test Site	03CH03-WS
Address of Test Site	No.14-1, Lane 19, Wen San 3rd St., Kwei Shan Dist., Tao Yuan City 33381, Taiwan (R.O.C.)

- FCC Designation No.: TW0009
- FCC site registration No.: 207696
- ISED#: 10807C
- CAB identifier: TW2732

2.2 The Worst Test Modes and Channel Details

Test item	Mode	Test Frequency (MHz)	Data Rate	Test Configuration
AC Power Line Conducted Emissions	GFSK	2481	2 Mbps	-
Unwanted Emissions \leq 1GHz	GFSK	2481	2 Mbps	-
Field Strength of Fundamental Unwanted Emissions > 1GHz 20dB bandwidth	GFSK	2403 / 2441 / 2481	2 Mbps	-
NOTE:				
1. The EUT was pretested with 3 orientations placed on the table for the radiated emission measurement – X, Y, and Z-plane. The X-plane results were found as the worst case and were shown in this report.				
2. Two USB cables had been covered during the pretest and found that the 2.05m USB cable was the worst case and was chosen for final test.				

3 Transmitter Test Results

3.1 Unwanted Emission

This section includes field strength of fundamental, field strength of harmonics and emissions radiated outside of the operating frequency bands.

3.1.1 Limit of field strength of fundamental and field strength of harmonics

Fundamental Frequency	Field strength of fundamental (millivolts/meter)	Field strength of harmonics (microvolts/meter)
2400–2483.5 MHz	50	500

3.1.2 Limit of Unwanted Emissions

Emissions radiated outside of the specified frequency bands, except for harmonics, shall be attenuated by at least 50 dB below the level of the fundamental or to the general radiated emission limits in below table, whichever is the lesser attenuation.

Radiated emission limits			
Frequency Range (MHz)	Field Strength (uV/m)	Field Strength (dBuV/m)	Measure Distance (m)
0.009~0.490	2400/F(kHz)	48.5 - 13.8	300
0.490~1.705	24000/F(kHz)	33.8 - 23	30
1.705~30.0	30	29	30
30~88	100	40	3
88~216	150	43.5	3
216~960	200	46	3
Above 960	500	54	3

Note 1:

Qusai-Peak value is measured for frequency below 1GHz except for 9–90 kHz, 110–490 kHz frequency band. Peak and average value are measured for frequency above 1GHz. The limit on average radio frequency emission is as above table. The limit on peak radio frequency emissions is 20 dB above the maximum permitted average emission limit

Note 2:

Measurements may be performed at a distance other than what is specified provided. When performing measurements at a distance other than that specified, the results shall be extrapolated to the specified distance using an extrapolation factor as below, Frequency at or above 30 MHz: 20 dB/decade Frequency below 30 MHz: 40 dB/decade.

3.1.3 Test Procedures

1. Measurement is made at a semi-anechoic chamber that incorporates a turntable allowing a EUT rotation of 360°. A continuously-rotating, remotely-controlled turntable is installed at the test site to support the EUT and facilitate determination of the direction of maximum radiation for each EUT emission frequency. The EUT is placed at test table. For emissions testing at or below 1 GHz, the table height is 80 cm above the reference ground plane. For emission measurements above 1 GHz, the table height is 1.5 m
2. Measurement is made with the antenna positioned in both the horizontal and vertical planes of polarization. The measurement antenna is varied in height (1m ~ 4m) above the reference ground plane to obtain the maximum signal strength. Distance between EUT and antenna is 3 m.
3. This investigation is performed with the EUT rotated 360°, the antenna height scanned between 1 m and 4 m, and the antenna rotated to repeat the measurements for both the horizontal and vertical antenna polarizations.

Note:

1. Radiated emission below 1GHz
120kHz measurement bandwidth of test receiver and Quasi-peak detector is for radiated emission
2. Radiated emission above 1GHz / Peak value except fundamental
RBW=1MHz, VBW=3MHz and Peak detector
3. Radiated emission above 1GHz / Average value for field strength of fundamental and harmonics
The average value is: Average = Peak value + 20log(Duty cycle) Where the duty factor is calculated from following formula:

$$20\log(\text{Duty cycle}) = 20\log \frac{0.0735 \times 13\text{ms}}{100\text{ms}} = -40.4\text{dB}$$

4. Radiated emission above 1GHz / Average value for other emissions
RBW=1MHz, VBW=1/T and Peak detector
5. Radiated emission Peak value for fundamental
RBW=2MHz, VBW=10MHz and Peak detector

3.1.4 Test Setup

Radiated Emissions below 1 GHz

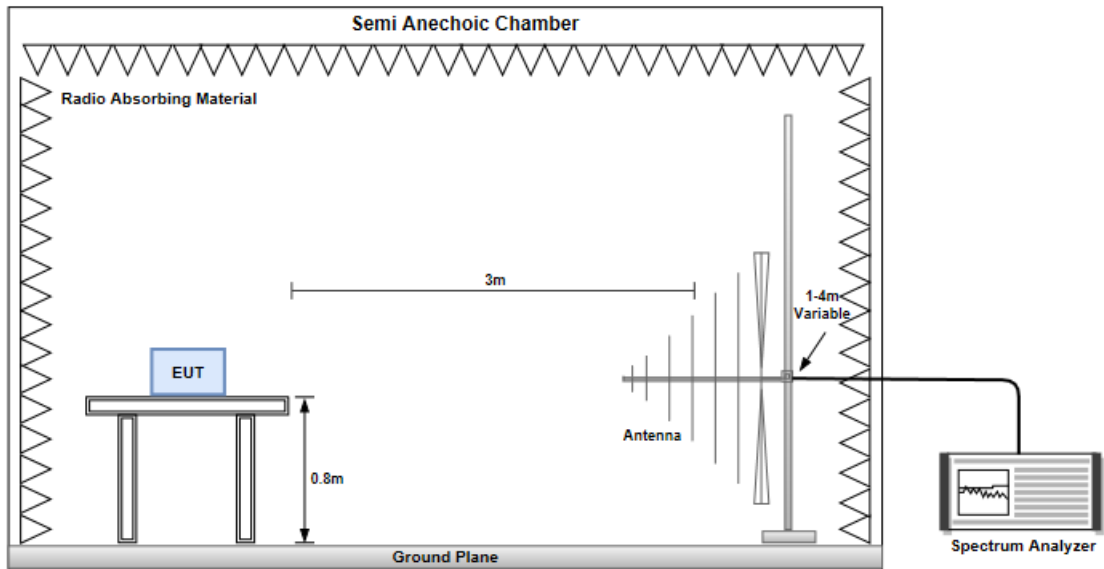

Radiated Emissions above 1 GHz

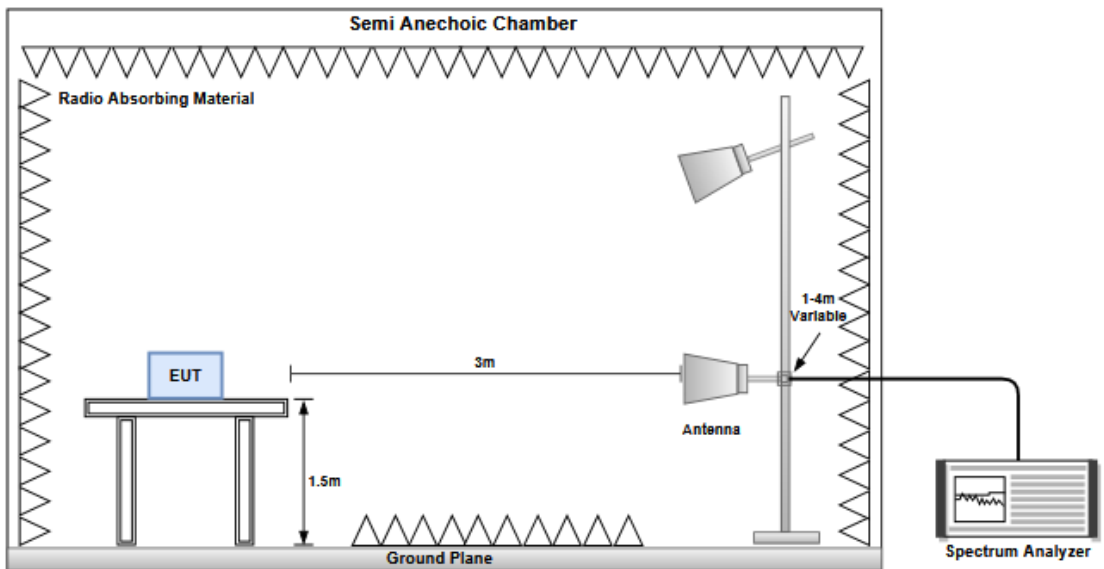

3.1.5 Test Results

Refer to Appendix A.

3.2 20dB and Occupied Bandwidth

3.2.1 Test Procedures

1. Set resolution bandwidth (RBW) = 20 kHz, Video bandwidth = 100 kHz.
2. Detector = Peak(20 dB bandwidth) / Sample(Occupied bandwidth), Trace mode = max hold
3. Sweep = auto couple, Allow the trace to stabilize.
4. Measure the maximum width of the emission that is constrained by the frequencies associated with the two outermost amplitude points (upper and lower) that are attenuated by 20dB relative to the maximum level measured in the fundamental emission.
5. Use the occupied measurement function of spectrum analyzer to measure 99% occupied bandwidth.

3.2.2 Test Setup

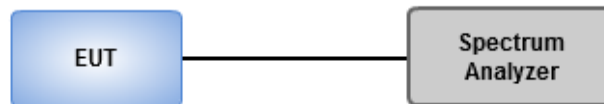

3.2.3 Test Results

Ambient Condition	23°C / 64%	Tested By	Brad Wu
--------------------------	------------	------------------	---------

Refer to Appendix B.

3.3 AC Power Line Conducted Emissions

3.3.1 Limit of AC Power Line Conducted Emissions

Conducted Emissions Limit		
Frequency Emission (MHz)	Quasi-Peak	Average
0.15-0.5	66 - 56 *	56 - 46 *
0.5-5	56	46
5-30	60	50

Note 1: * Decreases with the logarithm of the frequency.

3.3.2 Test Procedures

1. The device is placed on a test table, raised 80 cm above the reference ground plane. The vertical conducting plane is located 40 cm to the rear of the device.
2. The device is connected to line impedance stabilization network (LISN) and other accessories are connected to other LISN. Measured levels of AC power line conducted emission are across the 50 Ω LISN port.
3. AC conducted emission measurements is made over frequency range from 150 kHz to 30 MHz.
4. This measurement was performed with AC 120V / 60Hz.

3.3.3 Test Setup

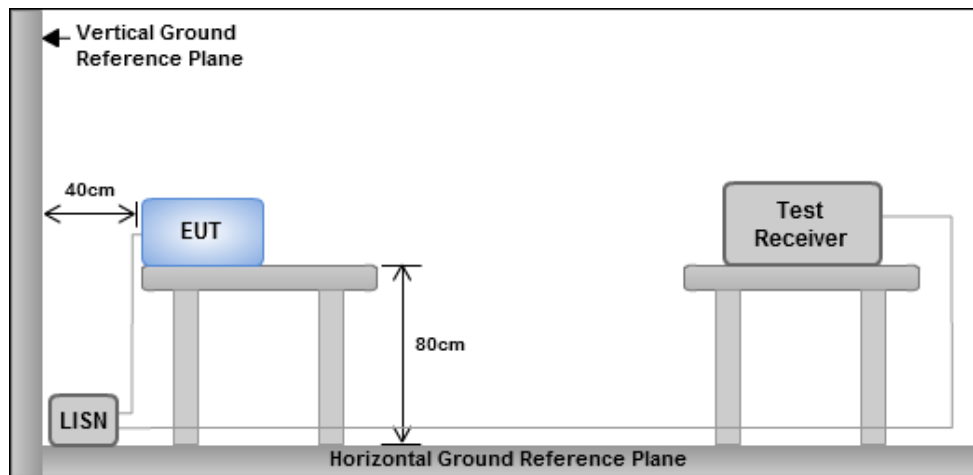

- Note: 1. Support units were connected to second LISN.
2. Both of LISNs (AMN) are 80 cm from EUT and at least 80 cm from other units and other metal planes

3.3.4 Test Results

Refer to Appendix C.

4 Test laboratory information

Established in 2012, ICC provides foremost EMC & RF Testing and advisory consultation services by our skilled engineers and technicians. Our services employ a wide variety of advanced edge test equipment and one of the widest certification extents in the business.

International Certification Corporation (EMC and Wireless Communication Laboratory), it is our definitive objective is to institute long term, trust-based associations with our clients. The expectation we set up with our clients is based on outstanding service, practical expertise and devotion to a certified value structure. Our passion is to grant our clients with best EMC / RF services by oriented knowledgeable and accommodating staff.

Our Test sites are located at Linkou District and Kwei Shan District. Location map can be found on our website <http://www.icertifi.com.tw>.

Linkou

Tel: 886-2-2601-1640

No.30-2, Ding Fwu Tsuen, Lin Kou
District, New Taipei City, Taiwan
(R.O.C.)

Kwei Shan

Tel: 886-3-271-8666

No.3-1, Lane 6, Wen San 3rd
St., Kwei Shan Dist., Tao Yuan
City 33381, Taiwan (R.O.C.)
No.2-1, Lane 6, Wen San 3rd
St., Kwei Shan Dist., Tao Yuan
City 33381, Taiwan (R.O.C.)

Kwei Shan Site II

Tel: 886-3-271-8640

No.14-1, Lane 19, Wen San 3rd
St., Kwei Shan Dist., Tao Yuan
City 33381, Taiwan (R.O.C.)

If you have any suggestion, please feel free to contact us as below information.

Tel: 886-3-271-8666

Fax: 886-3-318-0345

Email: ICC_Service@icertifi.com.tw

==END==



Unwanted Emissions (Below 1GHz)

Modulation	GFSK	Test Freq. (MHz)	2481
Polarization	Horizontal		

Test By :Brad Wu Temperature(°C):23 Humidity(%):64

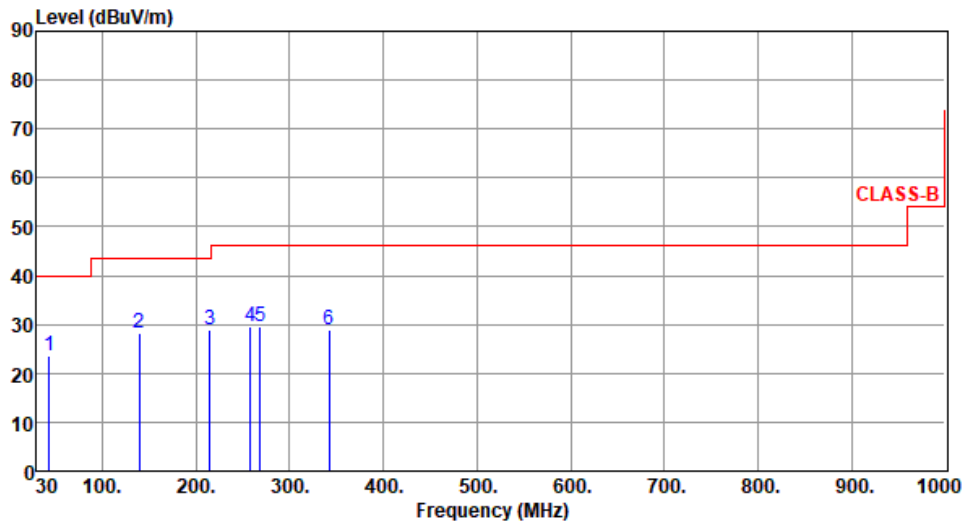

	Freq. MHz	Emission level dBuV/m	Limit dBuV/m	Margin dB	SA reading dBuV	Factor dB/m	Remark	ANT High cm	Turn Table deg
1	43.58	23.52	40.00	-16.48	31.73	-8.21	Peak	---	---
2	139.61	28.09	43.50	-15.41	37.25	-9.16	Peak	---	---
3	215.27	28.90	43.50	-14.60	40.82	-11.92	Peak	---	---
4	257.95	29.49	46.00	-16.51	38.95	-9.46	Peak	---	---
5	268.62	29.40	46.00	-16.60	38.39	-8.99	Peak	---	---
6	342.34	29.04	46.00	-16.96	35.73	-6.69	Peak	---	---

Note 1: Emission Level (dBuV/m) = SA Reading (dBuV) + Factor* (dB/m)

*Factor includes antenna factor , cable loss and amplifier gain

Note 2: Margin (dB) = Emission level (dBuV/m) – Limit (dBuV/m).

Note 3: All spurious emissions below 30MHz are more than 20 dB below the limit.



Modulation	GFSK	Test Freq. (MHz)	2481
Polarization	Vertical		

Test By :Brad Wu Temperature(°C):23 Humidity(%):64

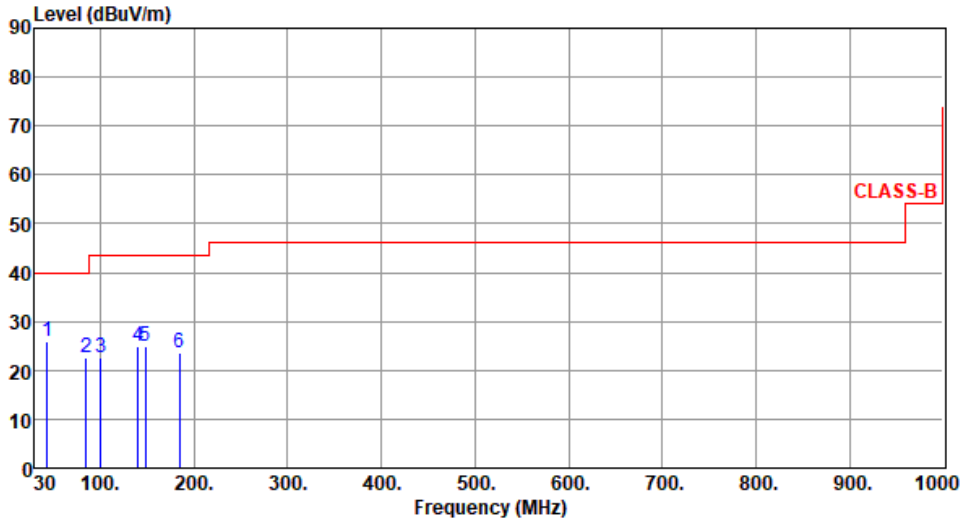

	Freq. MHz	Emission level dBuV/m	Limit dBuV/m	Margin dB	SA reading dBuV	Factor dB/m	Remark	ANT High cm	Turn Table deg
1	43.58	25.95	40.00	-14.05	34.16	-8.21	Peak	---	---
2	85.29	22.68	40.00	-17.32	36.94	-14.26	Peak	---	---
3	100.81	22.58	43.50	-20.92	35.42	-12.84	Peak	---	---
4	140.58	24.86	43.50	-18.64	33.89	-9.03	Peak	---	---
5	148.34	24.83	43.50	-18.67	33.47	-8.64	Peak	---	---
6	184.23	23.56	43.50	-19.94	34.21	-10.65	Peak	---	---

Note 1: Emission Level (dBuV/m) = SA Reading (dBuV) + Factor* (dB/m)

*Factor includes antenna factor , cable loss and amplifier gain

Note 2: Margin (dB) = Emission level (dBuV/m) – Limit (dBuV/m).

Note 3: All spurious emissions below 30MHz are more than 20 dB below the limit.



Unwanted Emissions (Above 1GHz)

Modulation	GFSK	Test Freq. (MHz)	2403
Polarization	Horizontal		

Test By :Brad Wu Temperature(°C):23 Humidity(%):64

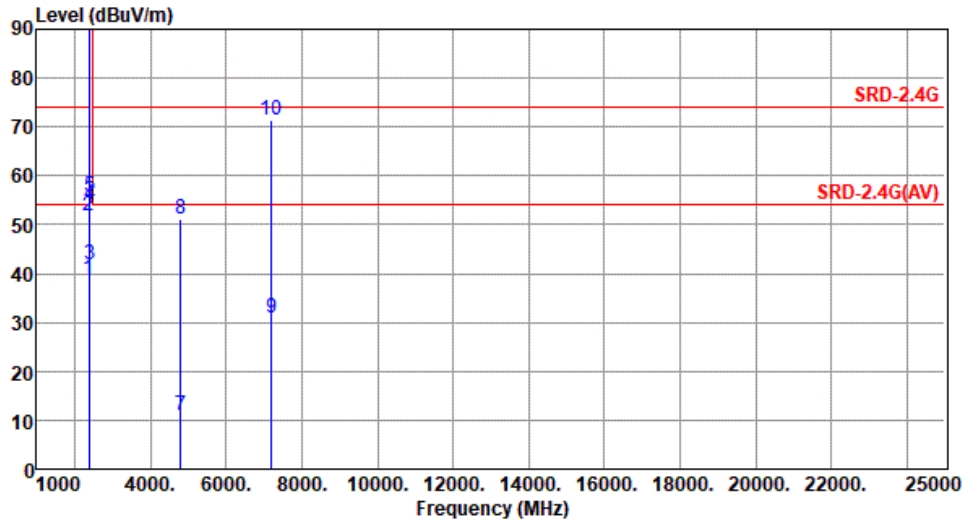

	Freq. MHz	Emission level dBuV/m	Limit dBuV/m	Margin dB	SA reading dBuV	Factor dB/m	Remark	ANT High cm	Turn Table deg
1	2390.00	38.76	54.00	-15.24	40.51	-1.75	Average	100	241
2	2390.00	51.71	74.00	-22.29	53.46	-1.75	Peak	100	241
3	2400.00	41.79	54.00	-12.21	43.59	-1.80	Average	100	241
4	2400.00	54.12	74.00	-19.88	55.92	-1.80	Peak	100	241
5	2403.00	55.77	94.00	-38.23			Average	100	241
6	2403.00	96.17	114.00	-17.83	97.98	-1.81	Peak	100	241
7	4806.00	10.86	54.00	-43.14			Average	100	148
8	4806.00	51.26	74.00	-22.74	46.49	4.77	Peak	100	148
9	7209.00	31.05	54.00	-22.95			Average	100	138
10	7209.00	71.45	74.00	-2.55	60.66	10.79	Peak	100	138

Note 1: Emission Level (dBuV/m) = SA Reading (dBuV) + Factor* (dB/m)
 *Factor includes antenna factor , cable loss and amplifier gain
 Note 2: Margin (dB) = Emission level (dBuV/m) – Limit (dBuV/m).
 Note 3: When average value is calculated not measured, no SA reading and factor value are listed.



Modulation	GFSK	Test Freq. (MHz)	2403
Polarization	Vertical		

Test By :Brad Wu Temperature(°C):23 Humidity(%):64

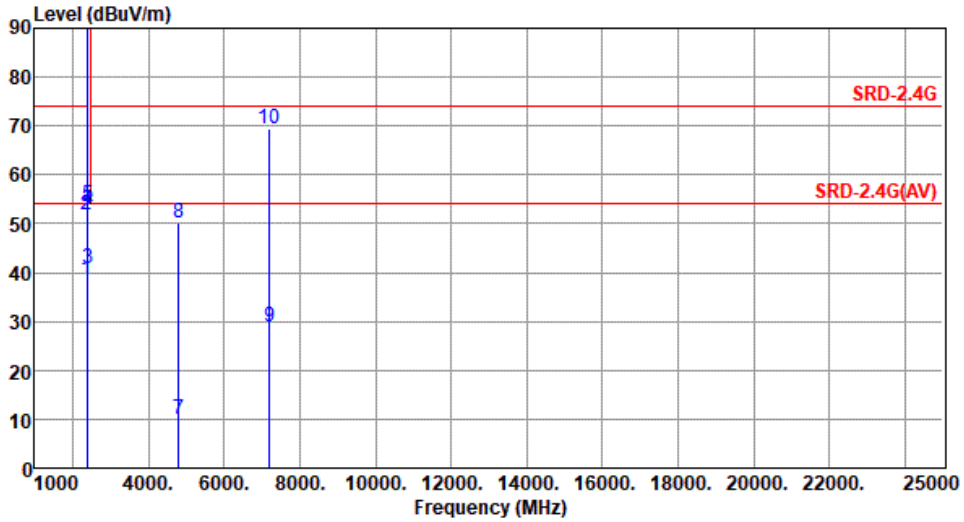

	Freq. MHz	Emission level dBuV/m	Limit dBuV/m	Margin dB	SA reading dBuV	Factor dB/m	Remark	ANT High cm	Turn Table deg
1	2390.00	38.49	54.00	-15.51	40.24	-1.75	Average	100	155
2	2390.00	51.66	74.00	-22.34	53.41	-1.75	Peak	100	155
3	2400.00	40.92	54.00	-13.08	42.72	-1.80	Average	100	155
4	2400.00	52.72	74.00	-21.28	54.52	-1.80	Peak	100	155
5	2403.00	53.81	94.00	-40.19			Average	100	155
6	2403.00	94.21	114.00	-19.79	96.02	-1.81	Peak	100	155
7	4806.00	9.84	54.00	-44.16			Average	100	165
8	4806.00	50.24	74.00	-23.76	45.47	4.77	Peak	100	165
9	7209.00	28.86	54.00	-25.14			Average	100	155
10	7209.00	69.26	74.00	-4.74	58.47	10.79	Peak	100	155

Note 1: Emission Level (dBuV/m) = SA Reading (dBuV) + Factor* (dB/m)

*Factor includes antenna factor , cable loss and amplifier gain

Note 2: Margin (dB) = Emission level (dBuV/m) – Limit (dBuV/m).

Note 3: When average value is calculated not measured, no SA reading and factor value are listed.



Modulation	GFSK	Test Freq. (MHz)	2441
Polarization	Horizontal		

Test By :Brad Wu Temperature(°C):23 Humidity(%):64

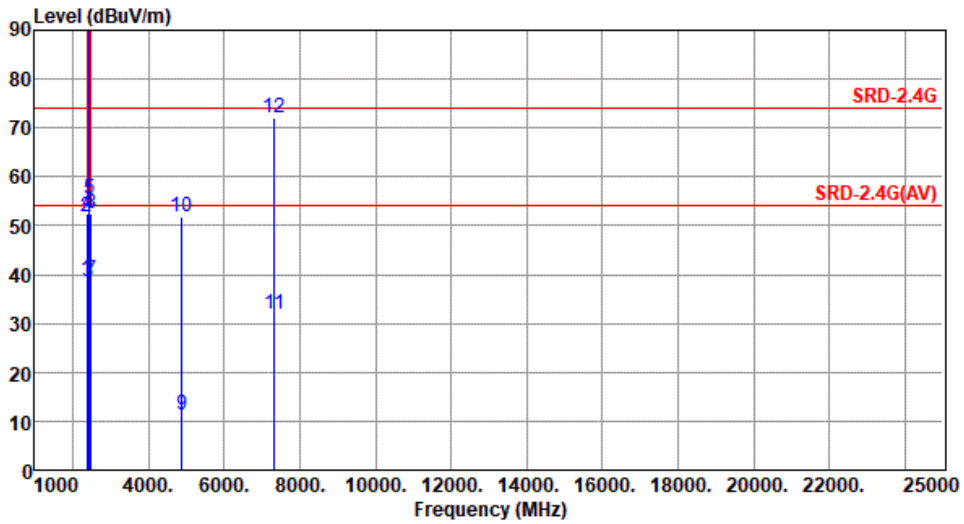

	Freq. MHz	Emission level dBuV/m	Limit dBuV/m	Margin dB	SA reading dBuV	Factor dB/m	Remark	ANT High cm	Turn Table deg
1	2390.00	38.71	54.00	-15.29	40.46	-1.75	Average	100	239
2	2390.00	51.79	74.00	-22.21	53.54	-1.75	Peak	100	239
3	2400.00	38.55	54.00	-15.45	40.35	-1.80	Average	100	239
4	2400.00	52.61	74.00	-21.39	54.41	-1.80	Peak	100	239
5	2441.00	55.30	94.00	-38.70			Average	100	239
6	2441.00	95.70	114.00	-18.30	97.55	-1.85	Peak	100	239
7	2483.50	38.75	54.00	-15.25	40.65	-1.90	Average	100	239
8	2483.50	52.38	74.00	-21.62	54.28	-1.90	Peak	100	239
9	4882.00	11.28	54.00	-42.72			Average	100	138
10	4882.00	51.68	74.00	-22.32	46.77	4.91	Peak	100	138
11	7323.00	31.79	54.00	-22.21			Average	100	134
12	7323.00	72.19	74.00	-1.81	61.40	10.79	Peak	100	134

Note 1: Emission Level (dBuV/m) = SA Reading (dBuV) + Factor* (dB/m)
 *Factor includes antenna factor , cable loss and amplifier gain
 Note 2: Margin (dB) = Emission level (dBuV/m) – Limit (dBuV/m).
 Note 3: When average value is calculated not measured, no SA reading and factor value are listed.



Modulation	GFSK	Test Freq. (MHz)	2441
Polarization	Vertical		

Test By :Brad Wu Temperature(°C):23 Humidity(%):64

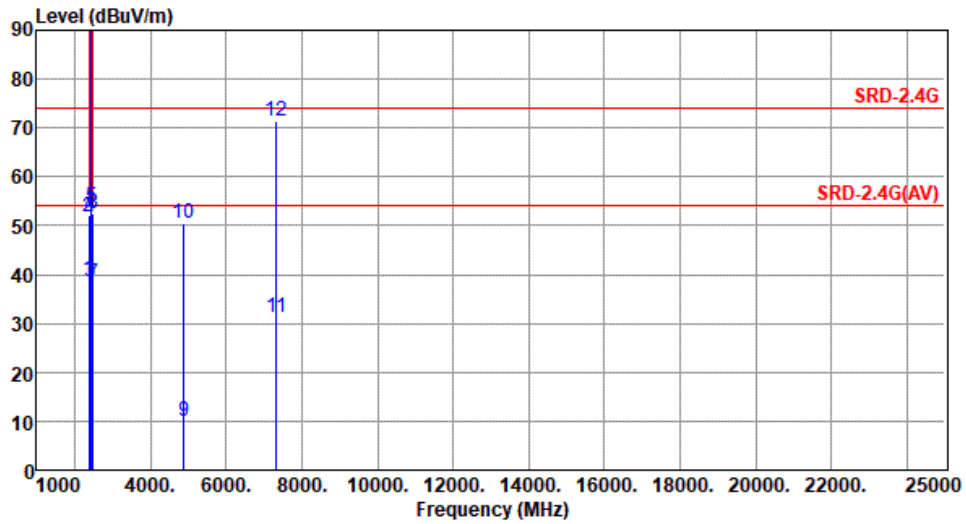

	Freq. MHz	Emission level dBuV/m	Limit dBuV/m	Margin dB	SA reading dBuV	Factor dB/m	Remark	ANT High cm	Turn Table deg
1	2390.00	38.76	54.00	-15.24	40.51	-1.75	Average	100	178
2	2390.00	51.87	74.00	-22.13	53.62	-1.75	Peak	100	178
3	2400.00	38.45	54.00	-15.55	40.25	-1.80	Average	100	178
4	2400.00	51.99	74.00	-22.01	53.79	-1.80	Peak	100	178
5	2441.00	53.81	94.00	-40.19			Average	100	178
6	2441.00	94.21	114.00	-19.79	96.06	-1.85	Peak	100	178
7	2483.50	38.34	54.00	-15.66	40.24	-1.90	Average	100	178
8	2483.50	52.39	74.00	-21.61	54.29	-1.90	Peak	100	178
9	4882.00	9.97	54.00	-44.03			Average	100	172
10	4882.00	50.37	74.00	-23.63	45.46	4.91	Peak	100	172
11	7323.00	31.16	54.00	-22.84			Average	100	151
12	7323.00	71.56	74.00	-2.44	60.77	10.79	Peak	100	151

Note 1: Emission Level (dBuV/m) = SA Reading (dBuV) + Factor* (dB/m)
 *Factor includes antenna factor , cable loss and amplifier gain
 Note 2: Margin (dB) = Emission level (dBuV/m) – Limit (dBuV/m).
 Note 3: When average value is calculated not measured, no SA reading and factor value are listed.



Modulation	GFSK	Test Freq. (MHz)	2481
Polarization	Horizontal		

Test By :Brad Wu Temperature(°C):23 Humidity(%):64

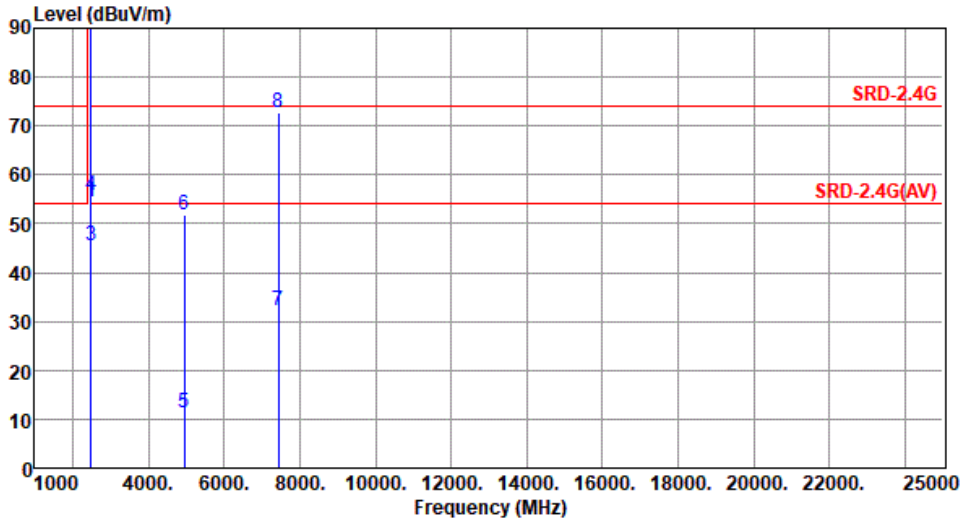

	Freq. MHz	Emission level dBuV/m	Limit dBuV/m	Margin dB	SA reading dBuV	Factor dB/m	Remark	ANT High cm	Turn Table deg
1	2481.00	54.49	94.00	-39.51			Average	100	265
2	2481.00	94.89	114.00	-19.11	96.78	-1.89	Peak	100	265
3	2483.50	45.65	54.00	-8.35	47.55	-1.90	Average	100	265
4	2483.50	55.91	74.00	-18.09	57.81	-1.90	Peak	100	265
5	4962.00	11.45	54.00	-42.55			Average	100	142
6	4962.00	51.85	74.00	-22.15	46.78	5.07	Peak	100	142
7	7443.00	32.20	54.00	-21.80			Average	100	135
8	7443.00	72.60	74.00	-1.40	61.71	10.89	Peak	100	135

Note 1: Emission Level (dBuV/m) = SA Reading (dBuV) + Factor* (dB/m)
 *Factor includes antenna factor , cable loss and amplifier gain
 Note 2: Margin (dB) = Emission level (dBuV/m) – Limit (dBuV/m).
 Note 3: When average value is calculated not measured, no SA reading and factor value are listed.



Modulation	GFSK	Test Freq. (MHz)	2481
Polarization	Vertical		

Test By :Brad Wu Temperature(°C):23 Humidity(%):64

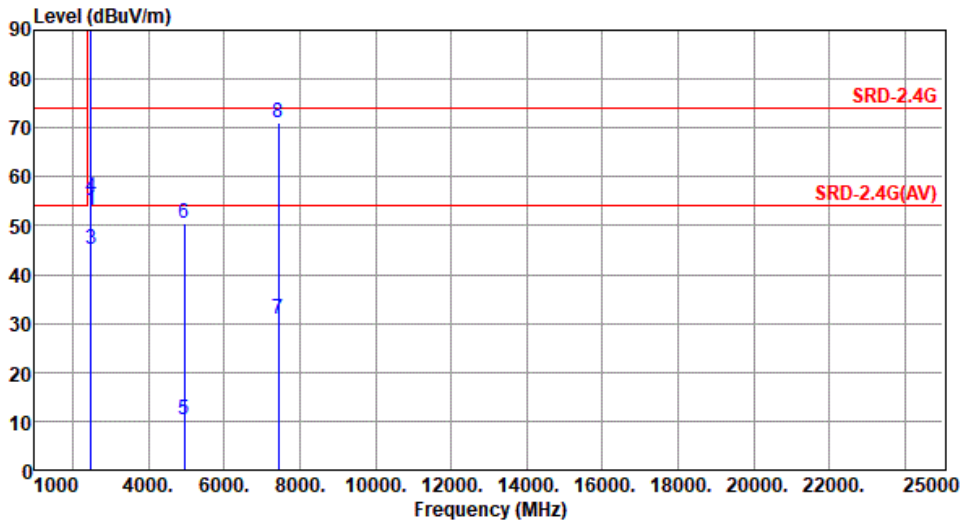

	Freq. MHz	Emission level dBuV/m	Limit dBuV/m	Margin dB	SA reading dBuV	Factor dB/m	Remark	ANT High cm	Turn Table deg
1	2481.00	53.06	94.00	-40.94			Average	100	186
2	2481.00	93.46	114.00	-20.54	95.35	-1.89	Peak	100	186
3	2483.50	45.22	54.00	-8.78	47.12	-1.90	Average	100	186
4	2483.50	55.67	74.00	-18.33	57.57	-1.90	Peak	100	186
5	4962.00	10.14	54.00	-43.86			Average	100	179
6	4962.00	50.54	74.00	-23.46	45.47	5.07	Peak	100	179
7	7443.00	30.78	54.00	-23.22			Average	100	153
8	7443.00	71.18	74.00	-2.82	60.29	10.89	Peak	100	153

Note 1: Emission Level (dBuV/m) = SA Reading (dBuV) + Factor* (dB/m)
 *Factor includes antenna factor , cable loss and amplifier gain
 Note 2: Margin (dB) = Emission level (dBuV/m) – Limit (dBuV/m).
 Note 3: When average value is calculated not measured, no SA reading and factor value are listed.

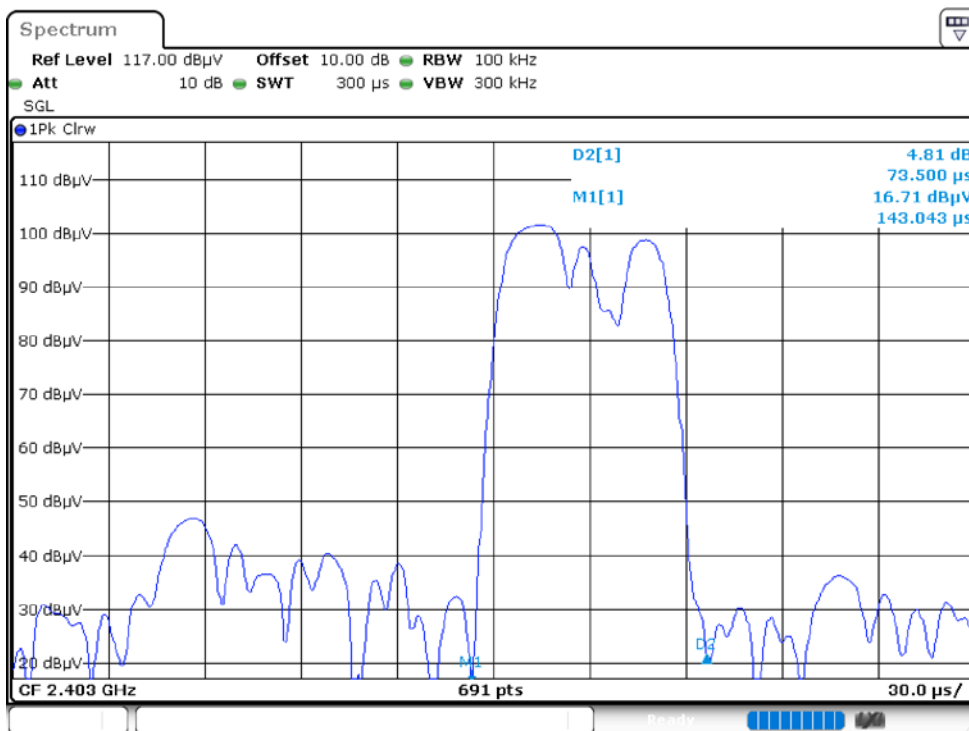
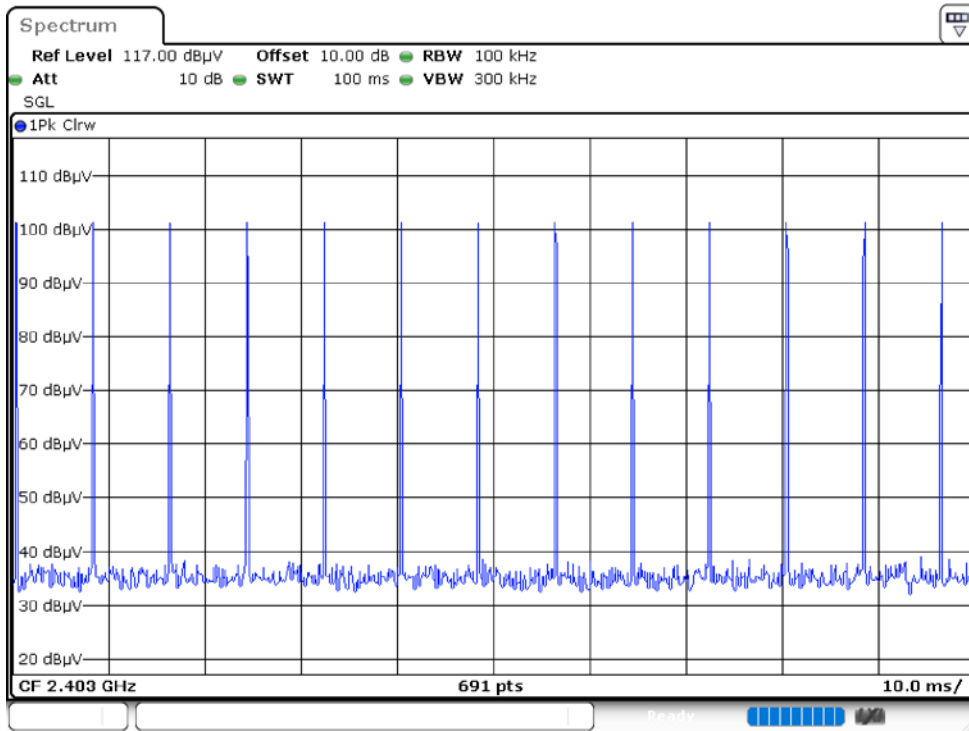

$$20\log(\text{Duty cycle}) = 20\log \frac{0.0735 \times 13\text{ms}}{100\text{ms}} = -40.4\text{dB}$$



Frequency (MHz)	20dB Bandwidth (MHz)	99% Occupied Bandwidth (MHz)
2403.0	1.780	1.737
2441.0	1.816	1.780
2481.0	1.954	1.809

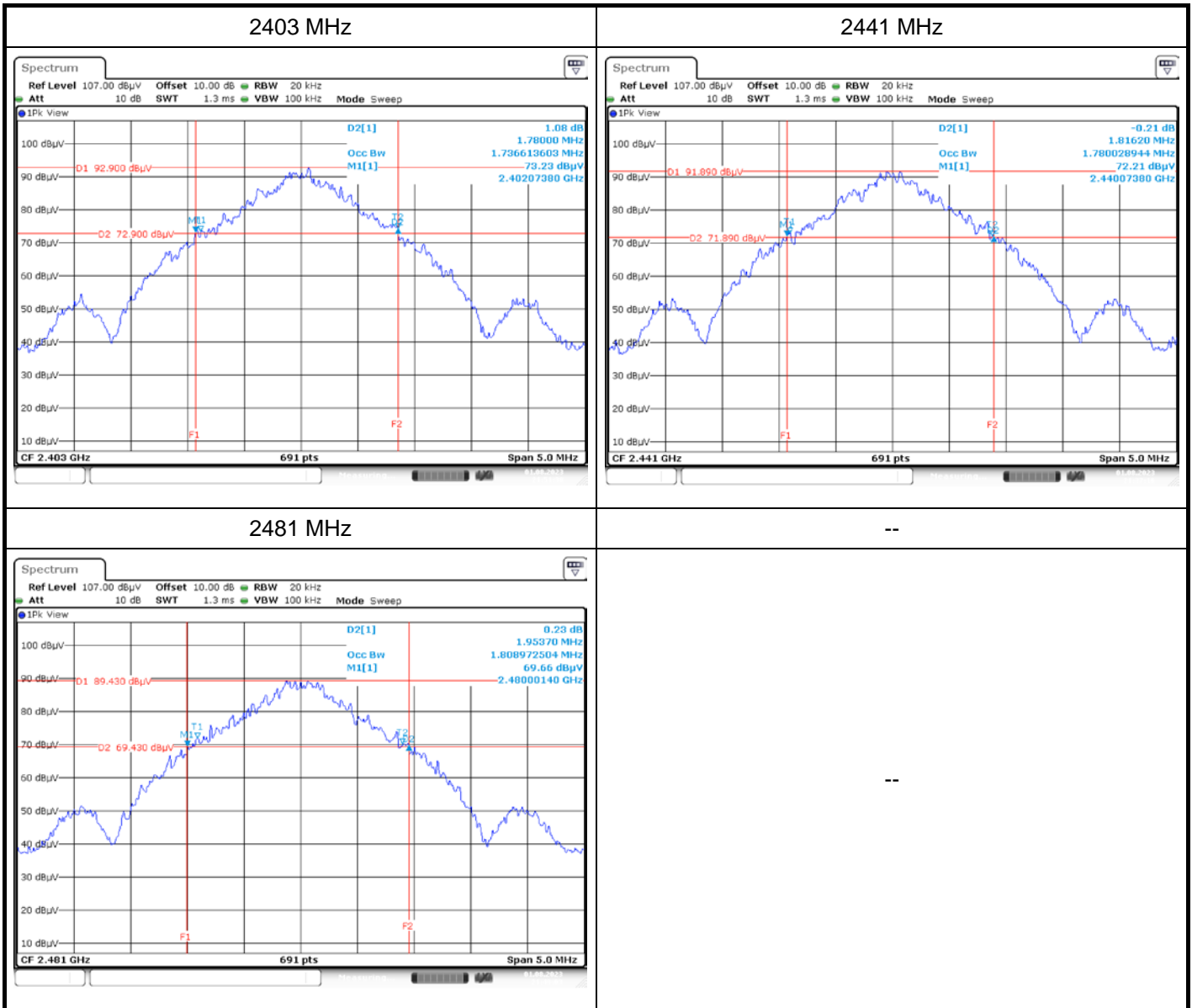



Modulation Mode	GFSK	Test Freq. (MHz)	2481
Power Phase	Line		

Test by : Wish Yu Temperature: 23°C Humidity: 63%

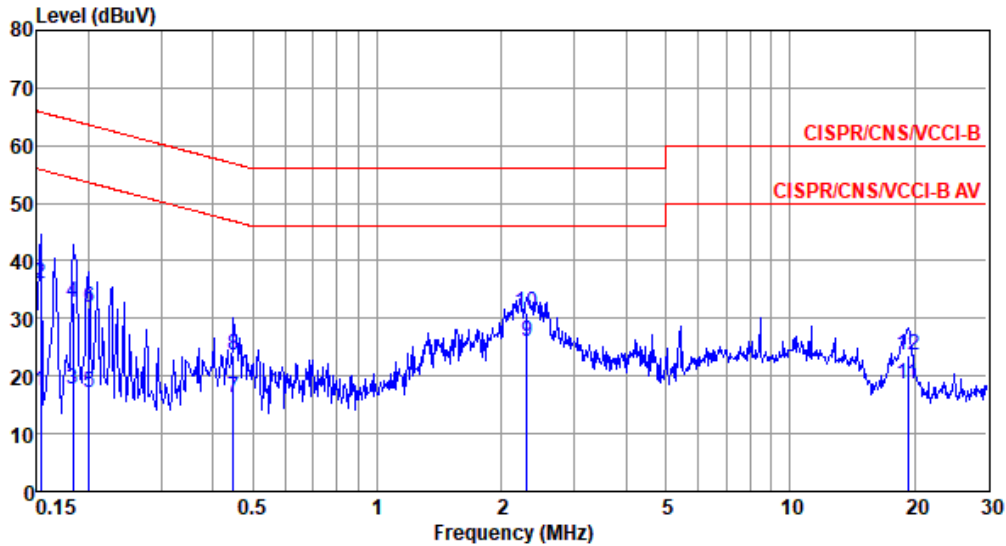

	Freq MHz	Level dBuV	Limit Line dBuV	Over Limit dB	Read Level dBuV	Factor dB	Cable loss dB	Aux dB	Remark
1	0.153	17.35	55.82	-38.47	7.66	9.63	0.06	0.00	Average
2	0.153	35.96	65.82	-29.86	26.27	9.63	0.06	0.00	QP
3	0.183	17.65	54.33	-36.68	7.97	9.62	0.06	0.00	Average
4	0.183	32.83	64.33	-31.50	23.15	9.62	0.06	0.00	QP
5	0.201	17.15	53.58	-36.43	7.47	9.62	0.06	0.00	Average
6	0.201	31.84	63.58	-31.74	22.16	9.62	0.06	0.00	QP
7	0.449	16.19	46.89	-30.70	6.50	9.62	0.07	0.00	Average
8	0.449	23.76	56.89	-33.13	14.07	9.62	0.07	0.00	QP
9*	2.309	26.05	46.00	-19.95	16.28	9.63	0.14	0.00	Average
10	2.309	31.14	56.00	-24.86	21.37	9.63	0.14	0.00	QP
11	19.326	18.56	50.00	-31.44	8.38	9.68	0.50	0.00	Average
12	19.326	23.73	60.00	-36.27	13.55	9.68	0.50	0.00	QP

Note 1: Level (dBuV) = Read Level (dBuV) + LISN Factor (dB) + Cable Loss (dB) + Aux (dB).
 Note 2: Over Limit (dB) = Level (dBuV) - Limit Line (dBuV).



Modulation Mode	GFSK	Test Freq. (MHz)	2481
Power Phase	Neutral		

Test by : Wish Yu Temperature: 23°C Humidity: 63%

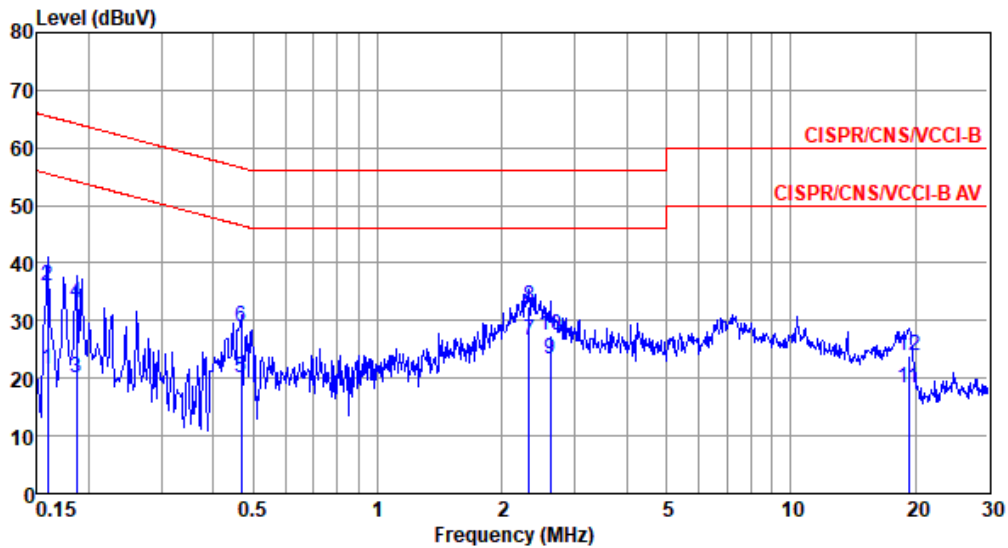

	Freq MHz	Level dBuV	Limit Line dBuV	Over Limit dB	Read Level dBuV	Factor dB	Cable loss dB	Aux dB	Remark
1	0.159	21.62	55.52	-33.90	11.93	9.63	0.06	0.00	Average
2	0.159	36.10	65.52	-29.42	26.41	9.63	0.06	0.00	QP
3	0.186	20.11	54.20	-34.09	10.42	9.63	0.06	0.00	Average
4	0.186	33.18	64.20	-31.02	23.49	9.63	0.06	0.00	QP
5	0.469	20.04	46.54	-26.50	10.35	9.62	0.07	0.00	Average
6	0.469	28.98	56.54	-27.56	19.29	9.62	0.07	0.00	QP
7*	2.321	26.57	46.00	-19.43	16.79	9.64	0.14	0.00	Average
8	2.321	32.41	56.00	-23.59	22.63	9.64	0.14	0.00	QP
9	2.622	23.21	46.00	-22.79	13.42	9.64	0.15	0.00	Average
10	2.622	27.50	56.00	-28.50	17.71	9.64	0.15	0.00	QP
11	19.326	18.29	50.00	-31.71	7.99	9.80	0.50	0.00	Average
12	19.326	23.79	60.00	-36.21	13.49	9.80	0.50	0.00	QP

Note 1: Level (dBuV) = Read Level (dBuV) + LISN Factor (dB) + Cable Loss (dB) + Aux (dB).
 Note 2: Over Limit (dB) = Level (dBuV) - Limit Line (dBuV).