



RP552
Interactive Flat Panel
User Manual



Disclaimer

BenQ Corporation makes no representations or warranties, either expressed or implied, with respect to the contents of this document. BenQ Corporation reserves the right to revise this publication and to make changes from time to time in the contents thereof without obligation to notify any person of such revision or changes.

Copyright

Copyright 2015 BenQ Corporation. All rights reserved. No part of this publication may be reproduced, transmitted, transcribed, stored in a retrieval system or translated into any language or computer language, in any form or by any means, electronic, mechanical, magnetic, optical, chemical, manual or otherwise, without the prior written permission of BenQ Corporation.

Table of Contents

Safety warnings and precautions	1
Important safety instructions	2
Notes on this display	2
Notes on the LCD panel of this display	2
Safety notice for remote control	3
Battery safety notice	3
BenQ ecoFACTS.....	4
Package contents	5
Setting up the display	6
Mounting the display	6
Parts of the display and their functions	8
Front panel	8
Input/output terminals.....	9
AC IN & Power switch.....	10
Remote control.....	11
Using the remote control.....	13
Connection	15
Connecting the VGA input.....	15
Connecting the touch module.....	15
Connecting the digital inputs	16
Connecting the AV inputs.....	17
Connecting the coaxial output.....	18
Connecting the video output.....	19
Connecting to serial port.....	20
Connecting power.....	21
Product information.....	22
Specifications	22
Dimensions	24
Supported input signal resolution.....	25
Troubleshooting	27
Appendix: Using Multi-Display Administrator	30
System requirements.....	30

Initial Setup	31
Overview of components and functions	33
Managing displays	35
Setting up display configurations	39
Additional operations	44
Troubleshooting.....	45

Safety warnings and precautions



The lightning flash with arrowhead symbol, within an equilateral triangle, is intended to alert the user to the presence of uninsulated "dangerous voltage" within the product's enclosure that may be of sufficient magnitude to constitute a risk of electric shock to persons.



The exclamation point within an equilateral triangle is intended to alert the user to the presence of important operating and maintenance (servicing) instructions in the literature accompanying the appliance.



THIS EQUIPMENT MUST BE GROUNDED

To ensure safe operation, the three-pin plug must be inserted only into a standard three-pin power outlet which is effectively grounded through normal household wiring. Extension cords used with the equipment must have three cores and be correctly wired to provide connection to the ground. Wrongly wired extension cords are a major cause of fatalities.

The fact that the equipment operates satisfactorily does not imply that the power outlet is grounded or that the installation is completely safe. For your safety, if you are in any doubt about the effective grounding of the power outlet, please consult a qualified electrician.

- The mains plug of the power supply cord shall remain readily operable. The AC receptacle (mains socket outlet) shall be installed near the equipment and shall be easily accessible. To completely disconnect this equipment from the AC mains, disconnect the power cord plug from the AC receptacle.
- Do not place this display on an uneven, sloping or unstable surface (such as a trolley) where it may fall and cause damage to itself or others.
- Do not place this display near water, like a spa or pool, or in a position which will allow the splashing or spraying of water onto the display, like in front of an open window where rain water may enter.
- Do not install this display in a confined space without proper ventilation and air circulation, such as in a closed cabinet. Allow proper space around the display for dissipating heat inside. Do not block any openings and vents on the display. Overheating may result in hazards and electric shock.
- Installation of this display should only be performed by a qualified technician. Failure to install this display properly may cause injuries and damages to the personnels and the display itself. Check the installation regularly and maintain the display periodically to ensure the best working condition.
- Use only the accessories approved or recommended by the manufacturer to mount this display. Using wrong or unsuitable accessories may cause the display to fall and result in serious personal injuries. Make sure that the surface and fixing points are strong enough to sustain the weight of the display.
- To reduce the risk of electric shock, do not remove covers. No user serviceable parts inside. Refer servicing to qualified service personnel.
- To prevent personal injuries, mounting the display or installing desktop stands is required before use.

Important safety instructions

1. Read these instructions.
2. Keep these instructions.
3. Heed all warnings.
4. Follow all instructions.
5. Do not use this apparatus near water.
6. Clean only with dry cloth.
7. Do not block any ventilation openings. Install in accordance with the manufacturer's instructions.
8. Do not install near any heat sources such as radiators, heat registers, stoves, or other apparatus (including amplifiers) that produce heat.
9. Do not defeat the safety purpose of the polarized or grounding-type plug. A polarized plug has two blades with one wider than the other. A grounding-type plug has two blades and a third grounding prong. The wide blade or the third prong are provided for your safety. If the provided plug does not fit into your outlet, consult an electrician for replacement of the obsolete outlet.
10. Protect the power cord from being walked on or pinched particularly at plugs, convenience receptacles, and the point where they exit from the apparatus.
11. Only use attachments/accessories specified by the manufacturer.
12. Use only with the cart, stand, tripod, bracket, or table specified by the manufacturer, or sold with the apparatus. When a cart is used, use caution when moving the cart/apparatus combination to avoid injury from tip-over.
13. Unplug this apparatus during lightning storms or when unused for long periods of time.
14. Refer all servicing to qualified service personnel. Servicing is required when the apparatus has been damaged in any way, such as power-supply cord or plug is damaged, liquid has been spilled or objects have fallen into the apparatus, the apparatus has been exposed to rain or moisture, does not operate normally, or has been dropped.



Notes on this display

- This display weighs more than 100 kilograms. Do not attempt to lift the display alone.
- Make sure you have four or more people available to help lift or a flat cart to transport the display to its final location.
- Keep the display horizontal as much as possible.
- Clear a floor space before unpacking.

Notes on the LCD panel of this display

- The Liquid Crystal Display (LCD) panel of this display has a very thin protective layer of glass which is liable to marking or scratching, and cracking if struck or pressured. The liquid crystal substrate is also liable to damage under excessive force or extreme temperatures. Please handle with care.
- The response time and brightness of the LCD panel may vary with the ambient temperature.

- Avoid placing the display in direct sun or where direct sun or spot lighting will shine onto the LCD panel, as the heat may damage the panel and the external casing of the display, and the bright light will make viewing the display more difficult than necessary.
- The LCD panel consists of individual pixels to display images and is manufactured according to the design specifications. While 99.9% of these pixels work normally, 0.01% of the pixels may remain constantly lit (in red, blue or green) or unlit. This is a technical limitation of the LCD technology and is not a defect.
- LCD screens, like plasma (PDP) and conventional CRT (Cathode Ray Tube) screens, are also susceptible to 'screen burn-in' or 'image retention' which can be found on the screen as visible fixed lines and shades. To avoid such damage to the screen, avoid displaying still images (like On-Screen Display menus, TV station logos, fixed/inactive text or icons) for more than two hours. Change the aspect ratio from time to time. Fill the entire screen with the image and eliminate the black bars whenever possible. Avoid displaying images in 4:3 aspect ratio over a long period of time, otherwise there may be visible burn marks on the screen as two vertical lines.
Note: Under certain circumstances, condensation may occur on the inner side of the cover glass, it's a natural phenomenon and will not affect the operation of the display. This condensation will usually disappear after around 2 hours of normal operation.

Safety notice for remote control

- Do not put the remote control in the direct heat, humidity, and avoid fire.
- Do not drop the remote control.
- Do not expose the remote control to water or moisture. Failure to do so could result in malfunction.
- Confirm there is no object between the remote control and the remote sensor of the product.
- When the remote control will not be used for an extended period, remove the batteries.

Battery safety notice

The use of the wrong type of batteries may cause chemical leaks or explosion. Please note the following:

- Always ensure that the batteries are inserted with the positive and negative terminals in the correct direction as shown in the battery compartment.
- Different types of batteries have different characteristics. Do not mix different types.
- Do not mix old and new batteries. Mixing old and new batteries will shorten battery life or cause chemical leaks from the old batteries.
- When batteries fail to function, replace them immediately.
- Chemicals which leak from batteries may cause skin irritation. If any chemical matter seeps out of the batteries, wipe it up immediately using a dry cloth, and replace the batteries as soon as possible.
- Due to varying storage conditions, the battery life for the batteries included with your product may be shortened. Replace them within 3 months or as soon as you can after initial use.
- There may be local restrictions on the disposal or recycling of batteries. Consult your local regulations or waste disposal provider.

BenQ ecoFACTS

BenQ has been dedicated to the design and development of greener product as part of its aspiration to realize the ideal of the "Bringing Enjoyment 'N Quality to Life" corporate vision with the ultimate goal to achieve a low-carbon society. Besides meeting international regulatory requirement and standards pertaining to environmental management, BenQ has spared no efforts in pushing our initiatives further to incorporate life cycle design in the aspects of material selection, manufacturing, packaging, transportation, using and disposal of the products. BenQ ecoFACTS label lists key eco-friendly design highlights of each product, hoping to ensure that consumers make informed green choices at purchase. Check out BenQ's CSR Website at <http://csr.BenQ.com/> for more details on BenQ's environmental commitments and achievements.



Package contents

Open the sales package and check the contents. If any item is missing or damaged, please contact your dealer immediately.



LCD display

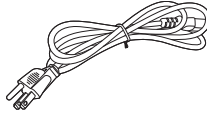

Power cord x 4

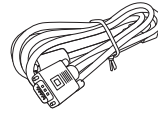

D-Sub (15-pin)
cable x 1



Audio interface
cable



Quick start guide

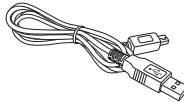

USB cable x 1

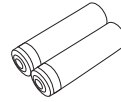

AAA battery x 2

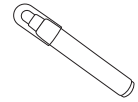

Touch pen x 2



Remote control



- The type of power cord supplied may differ from that illustrated depending on your region of purchase.
- Before discarding the package, check that you haven't left any accessories inside the box.
- Dispose of packaging materials wisely. You can recycle the cardboard carton. Consider storing the package (if possible) for future transport of the display.
- Do not leave plastic bags within reach of young children or babies.

Setting up the display

Mounting the display

You can install the display on a vertical surface with a suitable wall mounting bracket or on a horizontal surface with the optional desktop stands. Please pay attention to the following notes during installation:

- This display should be installed by at least two adult persons. Attempting to install this display by only one person may result in danger and injuries.
- Refer the installation to qualified technicians. Improper installation may cause the display to fall or malfunction.

Installing the display on a wall

1. Place a clean, dry and lint-free cloth on a flat, horizontal and object-free surface. Make sure that the size of the cloth is larger than the display.
2. Gently lay the display on the cloth with the LCD screen facing down.
3. Remove the desktop stands from the display if installed.

4. Identify the wall mounting screw holes on the back of the display as shown in the illustration.

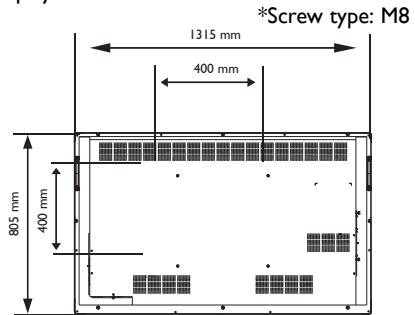

5. Install the wall mounting bracket on the display and attach the display to the wall according to the mounting bracket's instructions. The length of the screw should exceed the thickness of the wall mounting bracket by at least 10 mm. Make sure that all screws are tightened and secured properly. (Recommended torque: 470 - 635N•cm). The mounting means should be strong enough to bear the weight of the display.

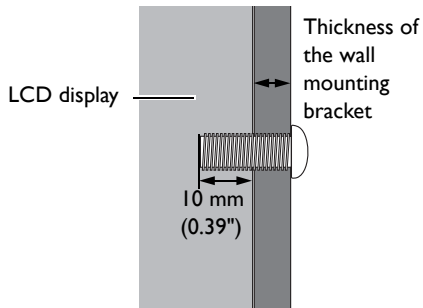



- To maintain proper ventilation, keep at least 10 mm of clear space from the back cover of the display to the wall.
- Please consult a professional technician for wall mount installations. The manufacturer accepts no liability for installations not performed by a professional technician.

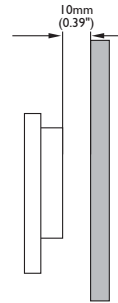

Parts of the display and their functions

Front panel

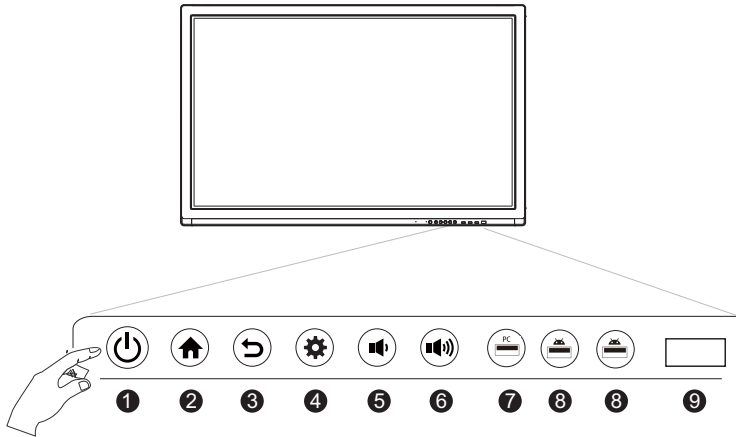

No.	Name	Description
1	Power	Tap to enter energy saving mode. Press and hold for 2 seconds or more to power off.
2	Home	Press to back to main screen.
3	Return	Press to return to previous level of menu.
4	Menu	Press to enter function menu.
5	Volume Down	Press to decrease volume.
6	Volume Up	Press to increase volume.
7	PC USB	Built-in computer USB interface.
8	Media USB	USB interface of Android system, which can access storage device to play media files.
9	Remote Control Signal Receiver	Receive remote control signals. Do not obstruct the receiver.

Input/output terminals

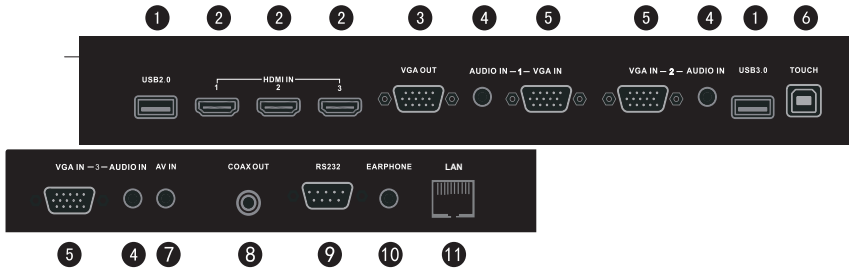

No.	Name	Description
1	USB	Connect USB devices such as USB keyboards, USB mice, and USB flash drives.
2	HDMI IN	High-definition multimedia interface signal input. Connect to PC with an HDMI output, a set-top-box, or other video devices capable of realizing touch function.
3	VGA OUT	Connect to display devices with a VGA input.
4	AUDIO IN	External computer audio input.
5	VGA IN	External computer image input.
6	TOUCH	External computer touch signal input. Default touch function is available under internal computer; when connecting external computer, besides connecting external computer VGA and audio signals, external computer's USB port needs to be connected to the equipment. Under the condition that driver is installed, external computer can be touch controlled through the equipment (touch function is effective in PC, VGA and HDMI channel by default)
7	AV IN	Composite video and audio input.
8	COAX OUT	Coaxial output.
9	RS232	Serial interface, used for mutual transfer of data between devices.
10	EARPHONE	Connected to device with headphone input function.
11	LAN	LAN interface, connecting RJ45 terminals. (This network port is only used for the closed Android OS on this product.)

AC IN & Power switch

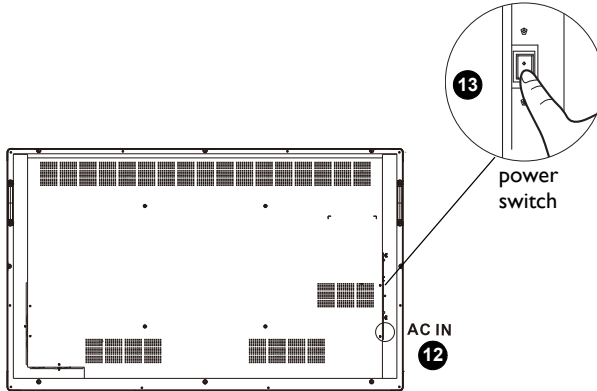

No.	Name	Description
12	AC IN	AC input, connecting AC power supply. Refer to Connecting power on page 21 for more information.
13	POWER SWITCH	Open and shut down AC power supply. Refer to Turning the display on or off on page 22 for more information.

Remote control

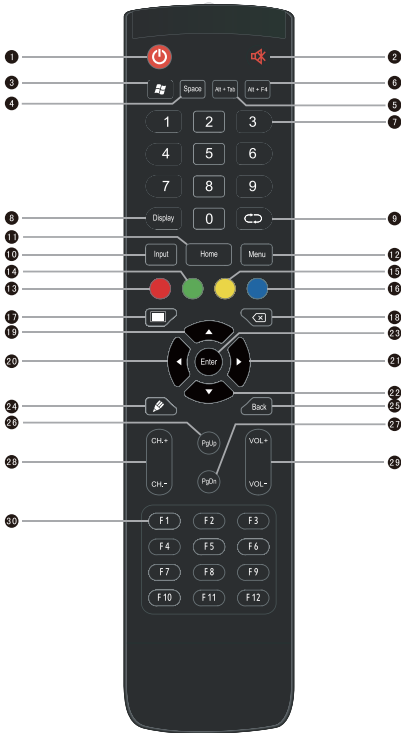

Turn the display on or off.



Turn on or off the mute function.



Built-in computer Windows key.



Built-in computer space key.



Built-in computer Alt+Tab key.



Built-in computer program window close button.



Perform as numeric buttons.



Show the current input source and information.



TV channel return key.



Select the input source. Refer to [Switching input signals on page 23](#) for more information.



Android system main screen button.



Opens or close the OSD menu.



TV channel function button.



TV channel function button.





TV channel function button.



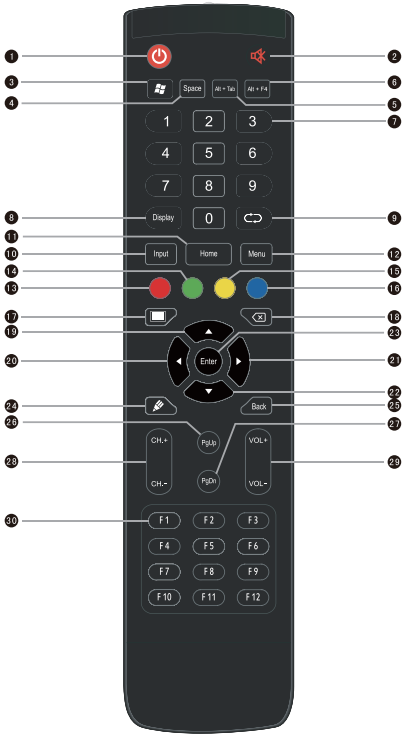

TV channel function button.





17  One key for blank screen.

18  Backspace key.

19  Direction key. Press for upward selection.

20  Direction key. Press for left selection.

21  Direction key. Press for right selection.

22  Direction key. Press for downward selection.

23 **ENTER**
Confirms your selection or save changes.

24  Quickly start writing application (EZWrite). Select writing pen quickly if the application is started.

25 **Back**
Return key.

26 **PgUp**
Built-in computer page (previous page).

27 **PgDn**
Built-in computer page (next page).

28 **CH+/CH-**
Channel switch key.

29 **VOL+/VOL-**
Volume switch key.

30 **F1 - F12**
Built-in computer F1 - F12 function keys.



- Built-in computer is not available. All buttons related to computer are regarded as disabled in case of no built-in computer.
- TV functions are not available.

Using the remote control

Installing remote control batteries

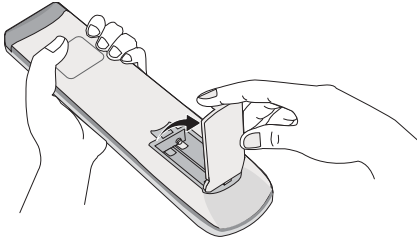

1. Open the remote control battery compartment cover.

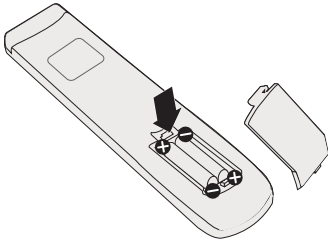

2. Insert the supplied batteries ensuring that the positive and negative marked battery terminals match the (+) and (-) marks in the battery compartment.



The supplied batteries are provided for your convenience so that you can operate the display straight away. You should replace them as soon as possible.

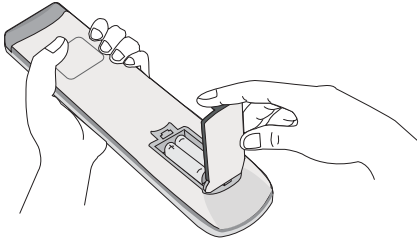

3. Refit the battery compartment cover.