

## 样品承认规格书

### PART SHEET FOR APPROVAL

制造商名称: Manufacturer:	东莞市信博联电子科技有限公司 Dongguan Sinbolin Electronic Technology Co.,Ltd.
供应商名称 Supplier::	东莞市信博联电子科技有限公司 Dongguan Sinbolin Electronic Technology Co.,Ltd.
产品名称: Part Description:	WIFI 金属片天线 WIFI Metal Antenna
规格型号: Model No:	JSP-20049-08YM
物料编码: Cust P/N:	360100313
日期: Issued Date:	2022.04.26

#### 供应商确认 Supplier confirmation

承办 Made By	审核 Engineer	批准 Approver
曹涌	向瑞盛	程志超

#### 华曦达确认 SDMC confirmation

承认原因: Approval Reason:	<input type="checkbox"/> 新物料 New Part <input type="checkbox"/> 替代料 Substitute Part		
承办 Made By	审核 Engineer		批准 Approver
	品质 Quality	研发 R&D	业务 Sales

备注: 签名表明提交样品获得承认, 图纸规格已经受控。Note: Signature indicates that the submitted sample is approved and the drawing/specification is now the controlling document.

地址: 深圳市南山区高新科技园科技南十二路 18 号长虹科技大厦 19 层  
Address: 19/F, Changhong Science & Technology Mansion, No.18, Keji South 12th Road, High-tech Industrial Park, Nanshan District, Shenzhen, China

目录 (Index) :

- A. 承认书封面 (Specification Cover) / Page 1
- B. 承认书项目目录 (Specification Index) / Page 2
  - 1. 产品规格 (Product Specification) / Page 3
  - 2. 网络参数测试数据 (S Parameter Test Data) / Page 4
  - 3. 天线辐射场型测试 (Antenna - Radiation Pattern Test) / Page 5
  - 4. 效率及增益测试数据 (Efficiency and Gain Test Data) / Page 6
  - 5. 隔离度测试数据 (Isolation Test Data) / Page 7
  - 6. 工程图纸 (Mechanical Drawing) / Page 8
  - 7. 包装规范 (Packing Specification) / Page 9

## 1. 产品规格 (Product Specification)

### 产品图片 (Product Photo)

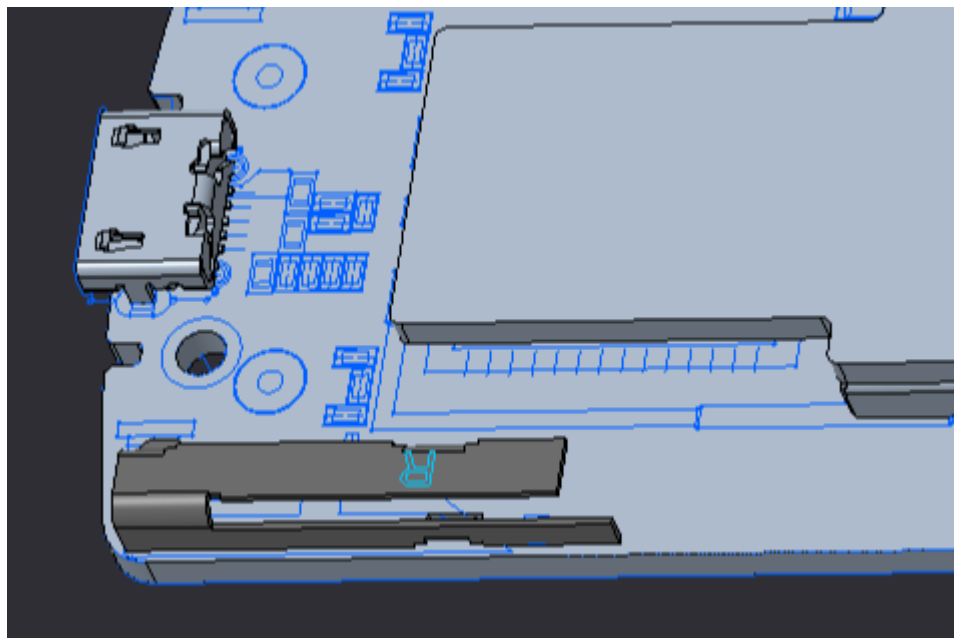

### A. 电性参数 (Electrical Characteristics)

频率 (Frequency)	2400 ~ 2500 MHz & 5150 ~ 5850 MHz
电压驻波比 (V.S.W.R)	$\leq 2.0$ @ 2400 ~ 2500 MHz & 5150 ~ 5850 MHz
返回损失 (Return Loss)	$\leq -10\text{dB}$ @ 2400 ~ 2500 MHz & 5150 ~ 5850 MHz
天线增益 (Antenna Gain)	3.0 ~ 4.0 dBi @ 2400 ~ 2500 MHz 3.0 ~ 4.5 dBi @ 5150 ~ 5850 MHz
辐射效率 (Radiation Efficiency)	50 ~ 60 % @ 2400 ~ 2500 MHz 60 ~ 85 % @ 5150 ~ 5850 MHz
阻抗 (Impedance)	50 Ohm
极化方式 (Polarization)	线性 (Linear)
天线类型 (Antenna Type)	PIFA

### B. 材质及机械特性 (Material & Mechanical Characteristics)

辐射材质 (Material of Radiator)	洋白铜 (Cu)
-----------------------------	----------

### C. 环境因素 (Environmental)

工作温度 (Operation Temperature)	- 40 °C ~ + 75 °C
储存温度 (Storage Temperature)	- 40 °C ~ + 85 °C

## 2. 网络参数测试数据 (S Parameter Test Data)

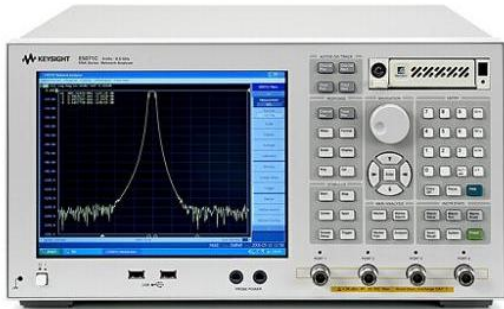

(Agilent Technologies) 安捷伦E5071C网络分析仪

测试频率范围: 300KHz-8.5GHz

测试能力: V. S. W. R、Return Loss、Smith等

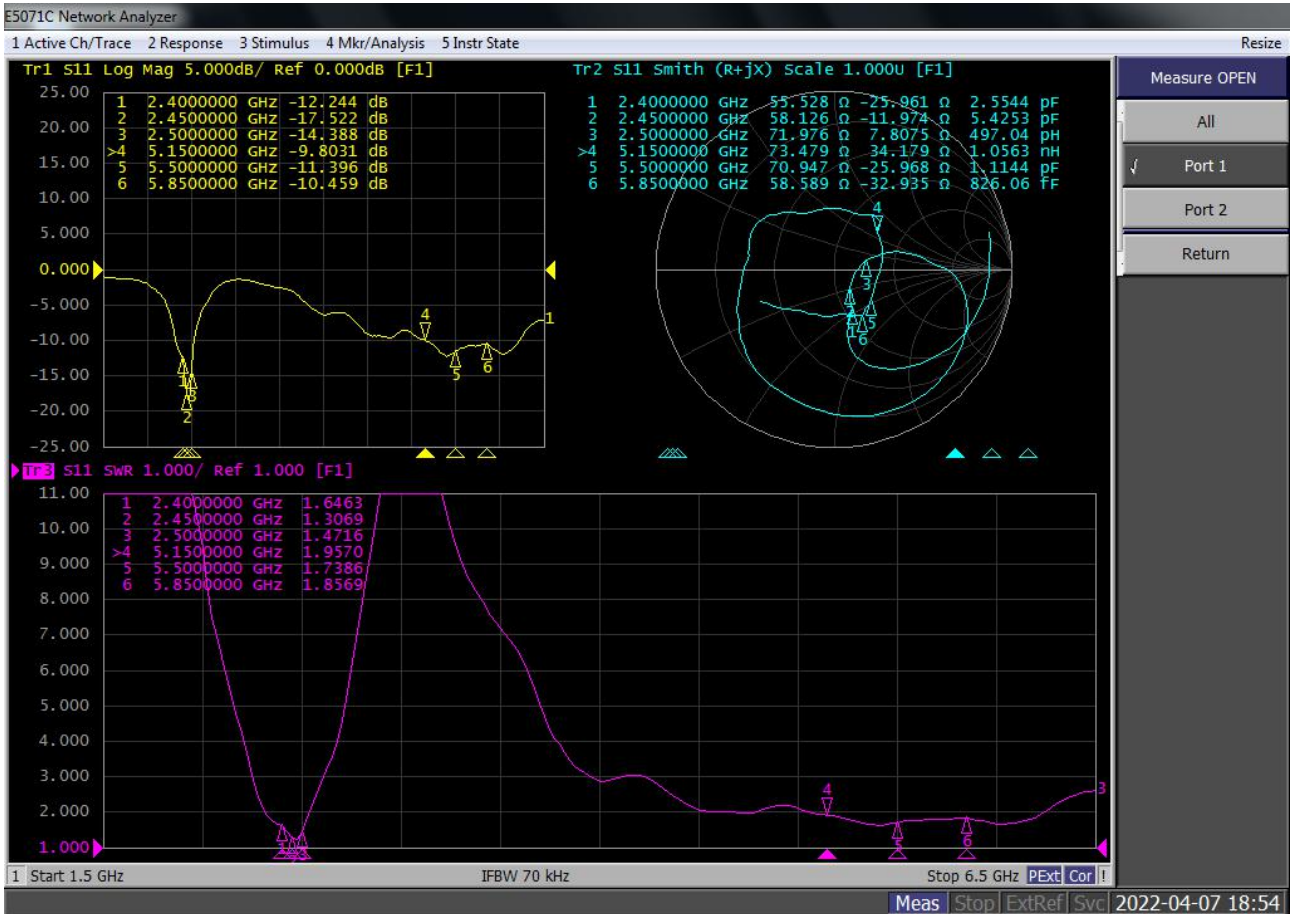

### 3. 天线辐射场型测试 (Antenna - Radiation Pattern Test)

测试设备规格 (Testing Equipment Specification) :

天线微波暗室尺寸 (Antenna Anechoic Chamber Dimension) : 6 x 3 x 3 米 (m)

屏蔽性能 (Isolation) : >100dB @ 1 MHz ~ 10 GHz

测试设备 (Testing Equipment) : (ROHDE&SCHWARZ) ZVL 矢量网络分析仪

接收天线 (Received Antenna) : 0.7 ~ 6.0 GHz 双极喇叭校准天线

(0.7 ~ 6.0 GHz for Gain Calibration Double Ridged Horn Antenna)

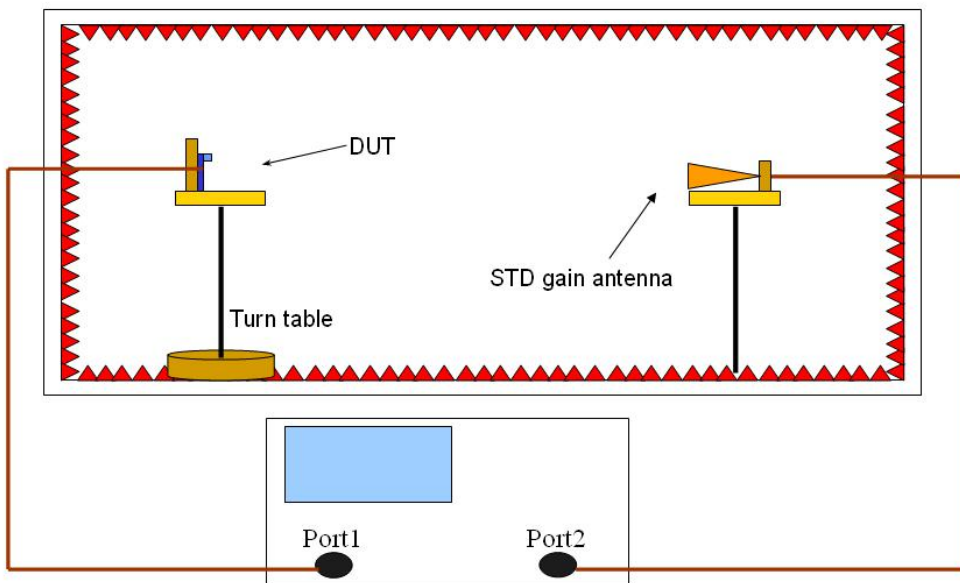

测试原理图

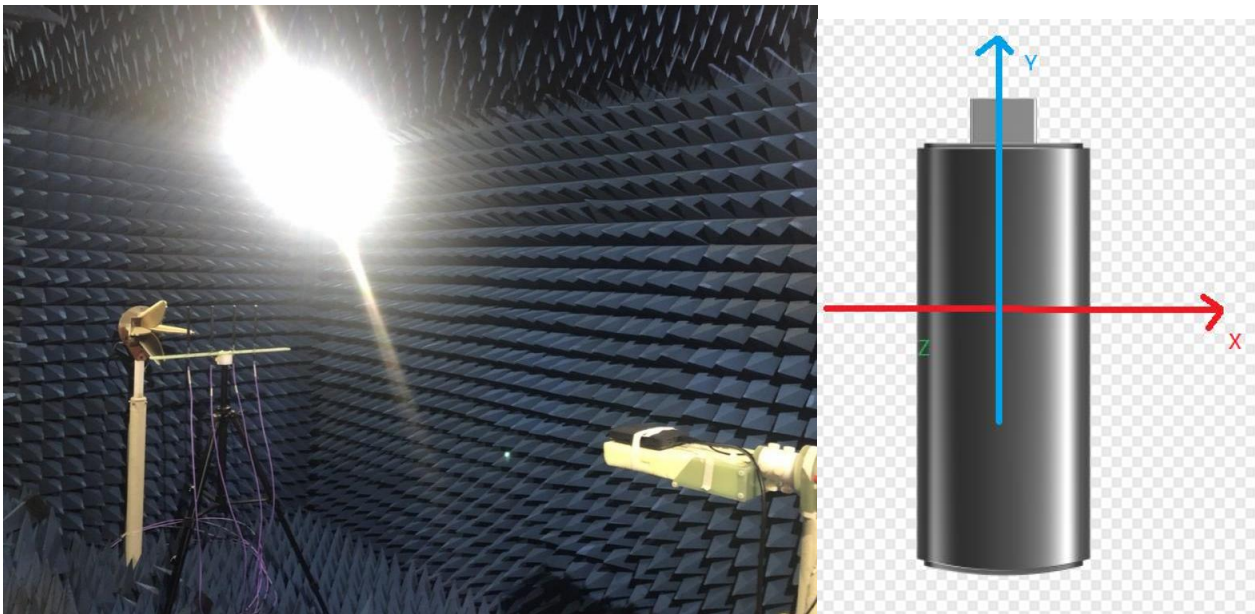



#### 4. 效率及增益测试数据 (Efficiency and Gain Test Data)

WIFI-JSP-20049-08YM					
2.4G			5G		
Frequency / MHz	Gain/ dBi	Efficiency / %	Frequency / MHz	Gain/ dBi	Efficiency / %
2400	3.14	50.64	5160	3.05	70.78
2410	3.13	50.35	5200	3.08	69.98
2420	3.2	51.27	5260	2.96	66.45
2430	3.28	52.14	5300	2.99	64.63
2440	3.44	53.52	5360	3.28	67.65
2450	3.54	54.64	5400	3.77	75.6
2460	3.68	55.66	5460	4.42	83.15
2470	3.76	56.29	5500	4.25	77.57
2480	3.74	56.04	5560	4.12	71.11
2490	3.74	55.76	5600	4.29	70.83
2500	3.45	53.84	5660	3.97	67.51
			5700	3.8	66.72
			5760	3.54	64.09
			5800	3.35	63.13
			5860	2.97	58.52

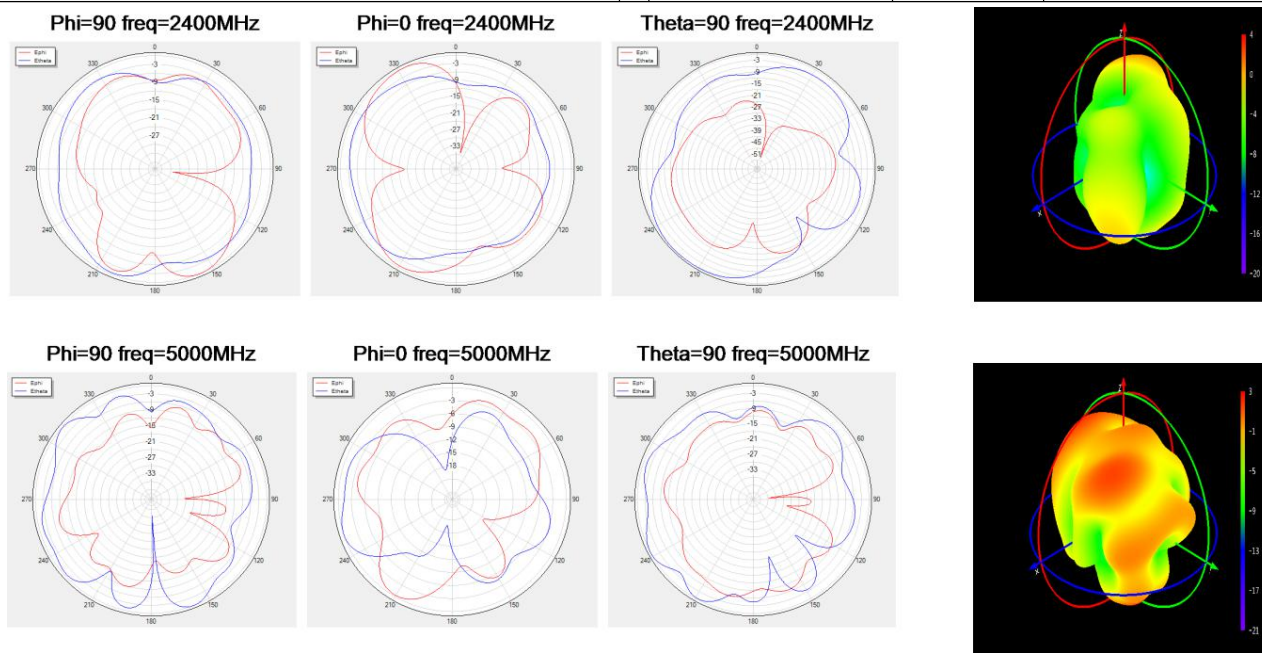

### 5. 隔离度测试数据 (Isolation Test Data)

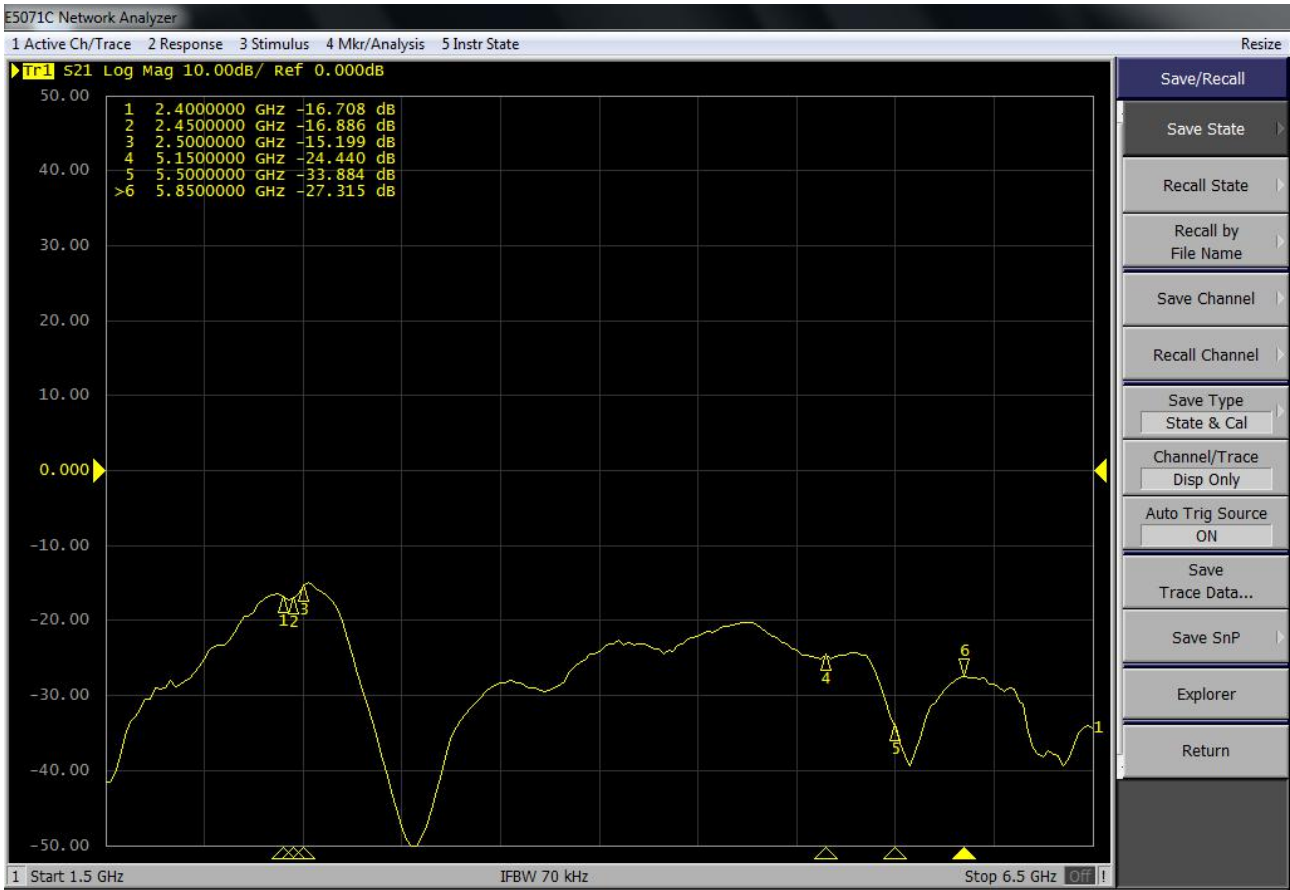

HF

RoHS

REACH

**CONFIDENTIAL**

SIGN	DATE	DESCRIPTION	APPROVER

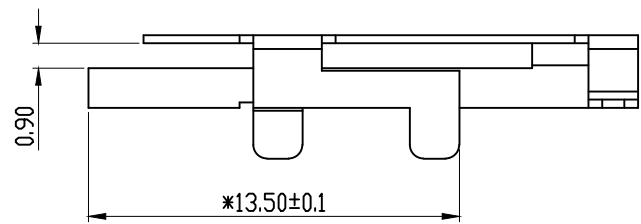
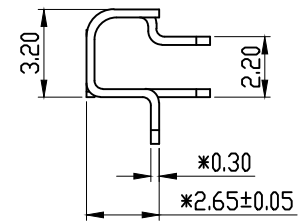
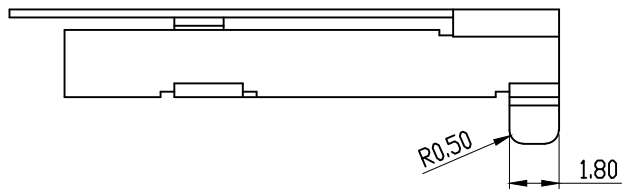
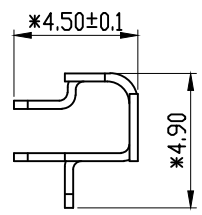
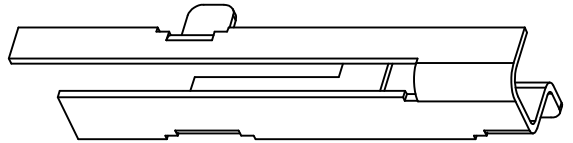
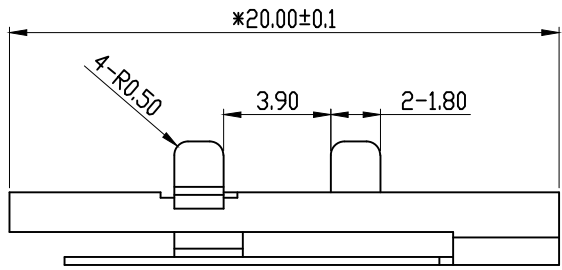

备注：  
 1. 材质为洋白铜。  
 2. 颜色为本色。  
 3. 带\*为重点检验尺寸，产品尺寸需在公差范围内。

东莞市信博联电子科技有限公司			
TITLE: 金属片 6075 WIFI R		CUSTOMER P/N: /	
PART NO.: JSP-20049-08YM			
APP BY	CHK BY	RF BY	DES BY
City 2022/04/26	Yixin 2022/04/26		YJH 2022/04/26
		Standard Tolerance X.X ±0.2    ○ 0.02 X.XX ±0.1    ◎ 0.03 X° ±1    ▱ 0.05 UNITS: mm    // 0.03 SCALE: 1/1    ⊥ 0.05 REVISION: A    ≡ 0.05	



# 產品包裝規範

## PACKING CRITERION

Date: 2022/04/26

Page: 1 of 1

<b>Part Number :</b> JSP-20049-08YM	<b>Revision :</b> A
<b>Name:</b> 金属片 6075 WIFI R	<b>Customer :</b>

### 一. WITH THE ANT INTO THE PE BAG

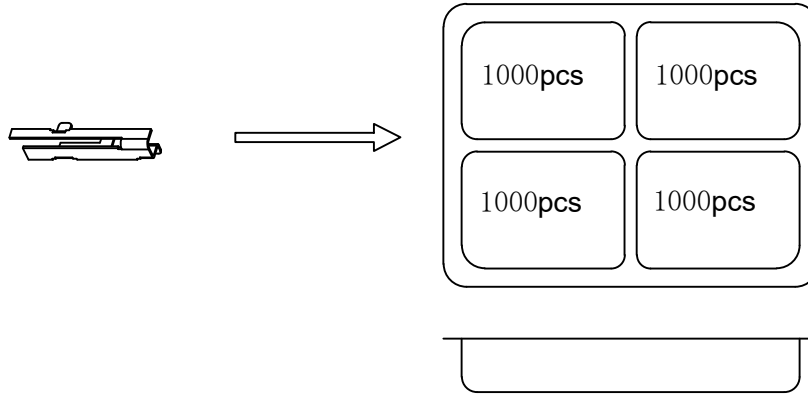

### 二. PACKING

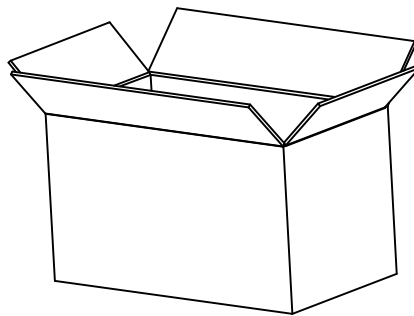

16000PCS/CARTON  
以客人实际下单数量为准

### 三. SEALING

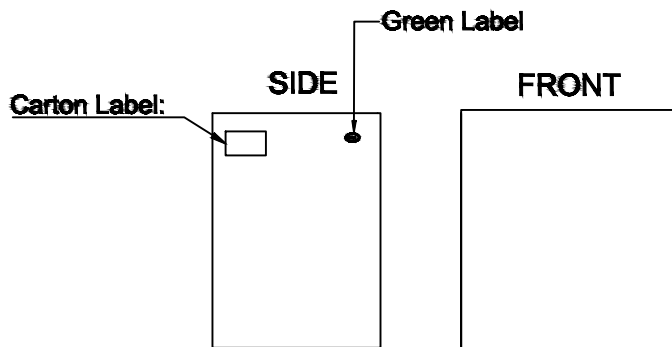
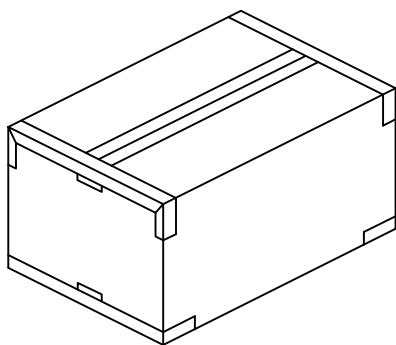

APPROVED BY : City

CHECKED BY : Yixin

DESIGNED BY : YJH