



FCC TEST REPORT

REPORT NO.: RF990419D15

MODEL NO.: PD01

RECEIVED: April 19, 2010

TESTED: April 19 ~ May 3, 2010

ISSUED: May 7, 2010

APPLICANT: BenQ Corporation

ADDRESS: 16 JIHU RD, NEIHU TAIPEI 114, TAIWAN

ISSUED BY: Bureau Veritas Consumer Products Services (H.K.)
Ltd., Taoyuan Branch

LAB LOCATION: No. 47, 14th Ling, Chia Pau Tsuen, Lin Kou Hsiang,
Taipei Hsien, 244 Taiwan

This test report consists of 35 pages in total. It may be duplicated completely for legal use with the approval of the applicant. It should not be reproduced except in full, without the written approval of our laboratory. The client should not use it to claim product endorsement by TAF or any government agencies. The test results in the report only apply to the tested sample.



Table of Contents

1.	CERTIFICATION.....	3
2.	SUMMARY OF TEST RESULTS.....	4
2.1	MEASUREMENT UNCERTAINTY.....	4
3.	GENERAL INFORMATION	5
3.1	GENERAL DESCRIPTION OF EUT.....	5
3.2	DESCRIPTION OF TEST MODES.....	6
3.2.1	CONFIGURATION OF SYSTEM UNDER TEST	7
3.2.2	TEST MODE APPLICABILITY AND TESTED CHANNEL DETAIL:	8
3.3	GENERAL DESCRIPTION OF APPLIED STANDARDS	10
3.4	DESCRIPTION OF SUPPORT UNITS	10
4.	TEST TYPES AND RESULTS.....	11
4.1	CONDUCTED EMISSION MEASUREMENT	11
4.1.1	LIMITS OF CONDUCTED EMISSION MEASUREMENT.....	11
4.1.2	TEST INSTRUMENTS	11
4.1.3	TEST PROCEDURES.....	12
4.1.4	DEVIATION FROM TEST STANDARD	12
4.1.5	TEST SETUP	12
4.1.6	EUT OPERATING CONDITIONS	13
4.1.7	TEST RESULTS.....	14
4.2	RADIATED EMISSION MEASUREMENT	18
4.2.1	LIMITS OF RADIATED EMISSION MEASUREMENT.....	18
4.2.2	TEST INSTRUMENTS	19
4.2.3	TEST PROCEDURES.....	20
4.2.4	DEVIATION FROM TEST STANDARD	20
4.2.5	TEST SETUP	21
4.2.6	EUT OPERATING CONDITIONS	22
4.2.7	TEST RESULTS.....	23
4.3	BAND EDGES MEASUREMENT	30
4.3.1	LIMITS OF BAND EDGES MEASUREMENT.....	30
4.3.2	TEST INSTRUMENTS	30
4.3.3	TEST PROCEDURE	30
4.3.4	DEVIATION FROM TEST STANDARD	30
4.3.5	EUT OPERATING CONDITION	30
4.3.6	TEST RESULTS.....	31
5.	PHOTOGRAPHS OF THE TEST CONFIGURATION.....	33
6.	INFORMATION ON THE TESTING LABORATORIES.....	34
7.	APPENDIX A – MODIFICATIONS RECORDERS FOR ENGINEERING CHANGES TO THE EUT BY THE LAB.....	35



1. CERTIFICATION

PRODUCT: Interactive Pen
BRAND NAME: BenQ
MODEL NO.: PD01
APPLICANT: BenQ Corporation
TESTED: April 19 ~ May 3, 2010
TEST SAMPLE: ENGINEERING SAMPLE
STANDARDS: FCC Part 15, Subpart C (Section 15.249)
ANSI C63.4-2003

The above equipment has been tested by **Bureau Veritas Consumer Products Services (H.K.) Ltd., Taoyuan Branch**, and found compliance with the requirement of the above standards. The test record, data evaluation & Equipment Under Test (EUT) configurations represented herein are true and accurate accounts of the measurements of the sample's EMC characteristics under the conditions specified in this report.

PREPARED BY : Jessica Cheng , **DATE:** May 7, 2010
(Jessica Cheng / Specialist)

TECHNICAL ACCEPTANCE : Jamison Chan , **DATE:** May 7, 2010
Responsible for RF (Jamison Chan / Supervisor)

APPROVED BY : Ken Liu , **DATE:** May 7, 2010
(Ken Liu / Assistant Manager)

2. SUMMARY OF TEST RESULTS

The EUT has been tested according to the following specifications:

APPLIED STANDARD: FCC Part 15, Subpart C (Section 15.249)			
STANDARD SECTION	TEST TYPE AND LIMIT	RESULT	REMARK
15.207	Conducted Emission Test	PASS	Minimum passing margin is -12.37dB at 0.172MHz
15.209 15.249 15.249 (d)	Radiated Emission Test Band Edge Measurement Limit: 50dB less than the peak value of fundamental frequency or meet radiated emission limit in section 12.209	PASS	Minimum passing margin is -5.3dB at 2441.00MHz

2.1 MEASUREMENT UNCERTAINTY

Where relevant, the following measurement uncertainty levels have been estimated for tests performed on the EUT as specified in CISPR 16-4-2:

This uncertainty represents an expanded uncertainty expressed at approximately the 95% confidence level using a coverage factor of k=2.

Measurement	Frequency	Uncertainty
Conducted emissions	150kHz ~ 30MHz	2.41 dB
Radiated emissions	30MHz ~ 1GHz	3.67 dB
	Above 1GHz	2.89 dB

3. GENERAL INFORMATION

3.1 GENERAL DESCRIPTION OF EUT

EUT	Interactive Pen
MODEL NO.	PD01
FCC ID	JVPPD1
POWER SUPPLY	3.3Vdc from battery, 5Vdc from host equipment or adapter
MODULATION TYPE	MSK
OPERATING FREQUENCY	2402MHz ~ 2479MHz
NUMBER OF CHANNEL	78
ANTENNA TYPE	Printed antenna with -6.95dBi gain
ANTENNA CONNECTOR	N/A
DATA CABLE	USB cable with one core (0.6m)
I/O PORTS	USB port
ASSOCIATED DEVICES	N/A

NOTE:

1. The EUT is an Interactive Pen, which is a transceiver.
2. The EUT was power supplied from the following power adapter or battery:

Item	Brand	Model	Rating
Adapter	PHIHONG	PSA105R-05Q	AC I/P: 100-240V, 0.3A, 50-60Hz DC O/P: 5V, 1.0A AC 2-pin
Battery	-	-	3.3V, 30mA

- ✘ The EUT could not transmit or receive under charging mode.
3. The USB function on this product is for battery charging only, no data transmitting and/or receiving function involved.
 4. The above EUT information was declared by the manufacturer and for more detailed features description, please refer to the manufacturer's specifications or User's Manual.



3.2 DESCRIPTION OF TEST MODES

78 channels are provided to this EUT:

CHANNEL	FREQ. (MHZ)	CHANNEL	FREQ. (MHZ)	CHANNEL	FREQ. (MHZ)	CHANNEL	FREQ. (MHZ)
0	2402	20	2422	40	2442	60	2462
1	2403	21	2423	41	2443	61	2463
2	2404	22	2424	42	2444	62	2464
3	2405	23	2425	43	2445	63	2465
4	2406	24	2426	44	2446	64	2466
5	2407	25	2427	45	2447	65	2467
6	2408	26	2428	46	2448	66	2468
7	2409	27	2429	47	2449	67	2469
8	2410	28	2430	48	2450	68	2470
9	2411	29	2431	49	2451	69	2471
10	2412	30	2432	50	2452	70	2472
11	2413	31	2433	51	2453	71	2473
12	2414	32	2434	52	2454	72	2474
13	2415	33	2435	53	2455	73	2475
14	2416	34	2436	54	2456	74	2476
15	2417	35	2437	55	2457	75	2477
16	2418	36	2438	56	2458	76	2478
17	2419	37	2439	57	2459	77	2479
18	2420	38	2440	58	2460		
19	2421	39	2441	59	2461		

3.2.1 CONFIGURATION OF SYSTEM UNDER TEST

Mode A (Charging mode)

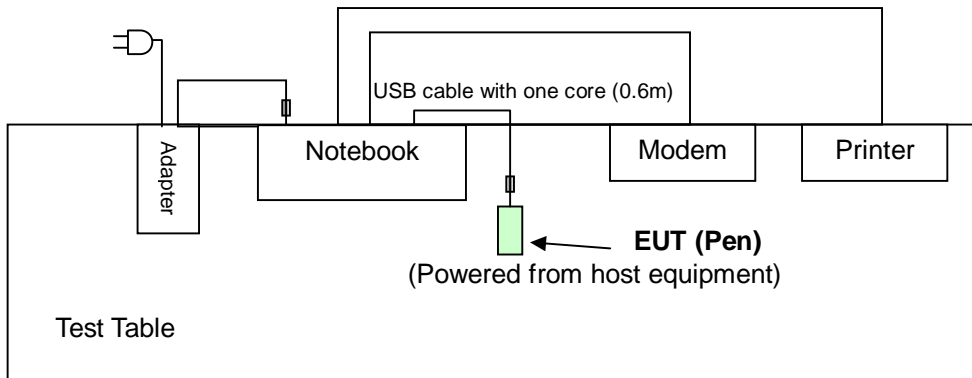

Mode B (Charging mode)

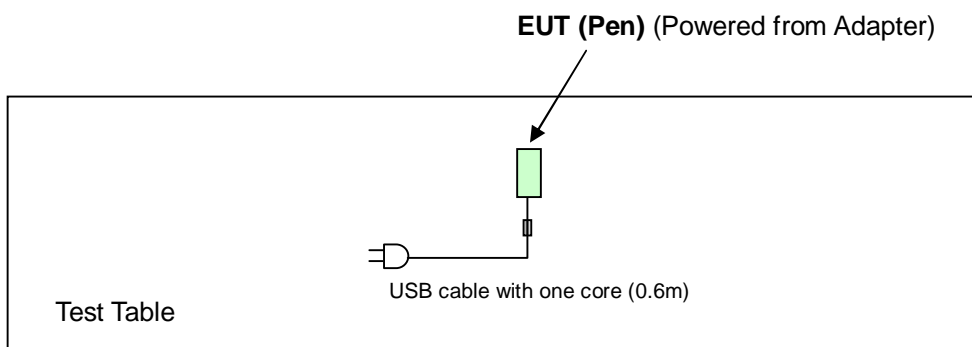

Mode C (Operating Mode)

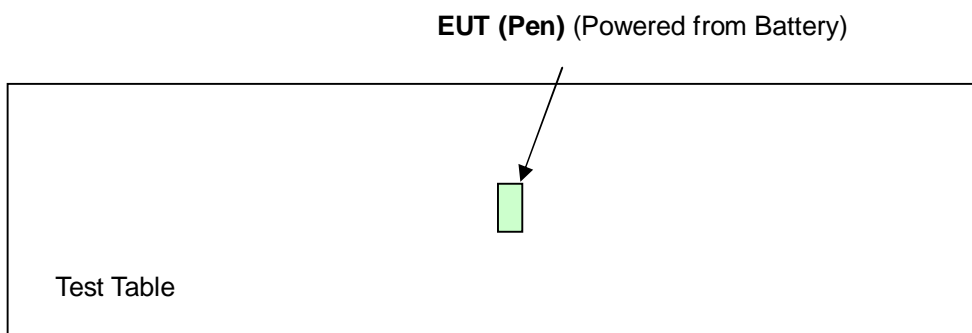

3.2.2 TEST MODE APPLICABILITY AND TESTED CHANNEL DETAIL:

EUT configure mode	Applicable to				Description
	PLC	RE<1G	RE [≥] 1G	BM	
A	√	√	-	-	Charging Mode (EUT with Notebook)
B	√	√	-	-	Charging Mode (EUT with adapter)
C	-	√	√	√	Operating Mode (EUT only)

Where PLC: Power Line Conducted Emission
RE[≥]1G: Radiated Emission above 1GHz

RE<1G RE: Radiated Emission below 1GHz
BM: Bandedge Measurement

POWER LINE CONDUCTED EMISSION TEST:

- Following channel(s) was (were) selected for the final test as listed below.

EUT CONFIGURE MODE	AVAILABLE CHANNEL	TESTED CHANNEL	MODULATION TYPE
A & B	-	-	-

RADIATED EMISSION TEST (BELOW 1 GHz):

- Pre-Scan has been conducted to determine the worst-case mode from all possible combinations between available modulations, XYZ Axis and antenna ports (if EUT with antenna diversity architecture).
- Following channel(s) was (were) selected for the final test as listed below.

EUT CONFIGURE MODE	AVAILABLE CHANNEL	TESTED CHANNEL	MODULATION TYPE	AXIS
A	-	-	-	-
B	-	-	-	-
C	0 to 77	0	MSK	X

RADIATED EMISSION TEST (ABOVE 1 GHz):

- Pre-Scan has been conducted to determine the worst-case mode from all possible combinations between available modulations, XYZ Axis and antenna ports (if EUT with antenna diversity architecture).
- Following channel(s) was (were) selected for the final test as listed below.

EUT CONFIGURE MODE	AVAILABLE CHANNEL	TESTED CHANNEL	MODULATION TYPE	AXIS
C	0 to 77	0, 39, 77	MSK	X



BANDEDGE MEASUREMENT:

- Pre-Scan has been conducted to determine the worst-case mode from all possible combinations between available modulations and antenna ports (if EUT with antenna diversity architecture).
- Following channel(s) was (were) selected for the final test as listed below.

EUT CONFIGURE MODE	AVAILABLE CHANNEL	TESTED CHANNEL	MODULATION TYPE
C	0 to 77	0, 77	MSK

TEST CONDITION:

APPLICABLE TO	EUT CONFIGURE MODE	ENVIRONMENTAL CONDITIONS	INPUT POWER	TESTED BY
PLC	A	20deg. C, 75% RH, 1019hPa	120Vac, 60Hz (System)	Chad Lee
	B		120Vac, 60Hz	
RE<1G	A	20deg. C, 85% RH, 1019hPa	120Vac, 60Hz (System)	Chad Lee
	B		120Vac, 60Hz	
	C		3.3Vdc	
RE ³ 1G	C	20deg. C, 85% RH, 1012hPa	3.3Vdc	Chad Lee
BM	C	18deg. C, 75% RH, 1014hPa	3.3Vdc	Chad Lee

3.3 GENERAL DESCRIPTION OF APPLIED STANDARDS

The EUT is a RF product. According to the specifications of the manufacturer, it must comply with the requirements of the following standards:

FCC Part 15, Subpart C. (15.249)

ANSI C63.4-2003

All test items have been performed and recorded as per the above standards.

3.4 DESCRIPTION OF SUPPORT UNITS

The EUT has been tested as an independent unit together with other necessary accessories or support units. The following support units or accessories were used to form a representative test configuration during the tests.

NO.	PRODUCT	BRAND	MODEL NO.	SERIAL NO.	FCC ID
1	NOTEBOOK COMPUTER	DELL	PP05L	20375526736	FCC DoC Approved
2	PRINTER	EPSON	LQ-300+	DCGY017054	FCC DoC Approved
3	MODEM	ACEEX	1414	980020520	IFAXDM1414

NO.	SIGNAL CABLE DESCRIPTION OF THE ABOVE SUPPORT UNITS
1	N/A
2	1.8m braid shielded wire, terminated with DB25 and Centronics connector via metallic frame, w/o core
3	1.2 m braid shielded wire, terminated with DB25 and DB9 connector via metallic frame, w/o core.

NOTE: All power cords of the above support units are non shielded (1.8m).

4. TEST TYPES AND RESULTS

4.1 CONDUCTED EMISSION MEASUREMENT

4.1.1 LIMITS OF CONDUCTED EMISSION MEASUREMENT

FREQUENCY OF EMISSION (MHz)	CONDUCTED LIMIT (dB μ V)	
	Quasi-peak	Average
0.15-0.5	66 to 56	56 to 46
0.5-5	56	46
5-30	60	50

NOTE:

1. The lower limit shall apply at the transition frequencies.
2. All emanations from a class A/B digital device or system, including any network of conductors and apparatus connected thereto, shall not exceed the level of field strengths specified above.

4.1.2 TEST INSTRUMENTS

DESCRIPTION & MANUFACTURER	MODEL NO.	SERIAL NO.	CALIBRATED DATE	CALIBRATED UNTIL
ROHDE & SCHWARZ Test Receiver	ESCS 30	100276	Dec. 15, 2009	Dec. 14, 2010
ROHDE & SCHWARZ Artificial Mains Network (for EUT)	ESH3-Z5	100218	Nov. 24, 2009	Nov. 23, 2010
LISN With Adapter (for EUT)	AD10	C10Ada-001	Nov. 24, 2009	Nov. 23, 2010
ROHDE & SCHWARZ Artificial Mains Network (for peripherals)	ESH3-Z5	100219	Nov. 23, 2009	Nov. 22, 2010
Software	ADT_Cond_V7.3.7	NA	NA	NA
Software	ADT_ISN_V7.3.7	NA	NA	NA
RF cable (JYEBAO)	5D-FB	Cable-C10.01	Feb. 23, 2010	Feb. 22, 2011
SUHNER Terminator (For ROHDE & SCHWARZ LISN)	65BNC-5001	E1-010773	Feb. 23, 2010	Feb. 22, 2011

- NOTE:**
1. The calibration interval of the above test instruments is 12 months and the calibrations are traceable to NML/ROC and NIST/USA.
 2. The test was performed in Shielded Room No. 10.
 3. The VCCI Site Registration No. C-1852.

4.1.3 TEST PROCEDURES

- The EUT was placed 0.4 meters from the conducting wall of the shielded room with EUT being connected to the power mains through a line impedance stabilization network (LISN). Other support units were connected to the power mains through another LISN. The two LISNs provide 50 ohm/ 50uH of coupling impedance for the measuring instrument.
- Both lines of the power mains connected to the EUT were checked for maximum conducted interference.
- The frequency range from 150kHz to 30MHz was searched. Emission levels under limit - 20dB was not recorded.

4.1.4 DEVIATION FROM TEST STANDARD

No deviation.

4.1.5 TEST SETUP

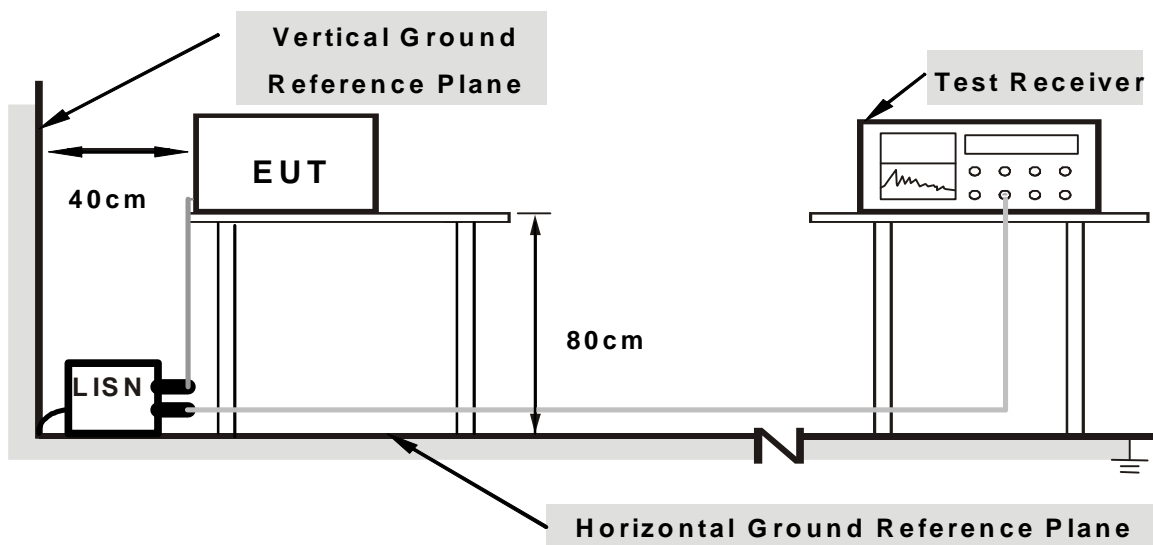

- Note:**
- Support units were connected to second LISN.
 - Both of LISNs (AMN) are 80 cm from EUT and at least 80 from other units and other metal planes

For the actual test configuration, please refer to the related item – Photographs of the Test Configuration.

4.1.6 EUT OPERATING CONDITIONS

For Mode A

- a. Connected the EUT to Notebook via USB cable.
- b. Turned on the power of all equipment.
- c. Notebook ran a test program (provided by manufacturer) to enable all functions.
- d. Set the EUT under charging condition.
- e. Notebook sent messages to printer and the printer printed them out.
- f. Notebook sent messages to modem.
- g. Steps e-g were repeated.

For Mode B

- a. Connected the EUT with AC adapter placed on testing table.
- b. Set the EUT under charging condition.

4.1.7 TEST RESULTS

CONDUCTED WORST CASE DATA

PHASE	Line 1	6dB BANDWIDTH	9 kHz
TEST MODE	A		

No	Freq. [MHz]	Corr. Factor (dB)	Reading Value		Emission Level		Limit		Margin	
			[dB (uV)]		[dB (uV)]		[dB (uV)]		(dB)	
			Q.P.	AV.	Q.P.	AV.	Q.P.	AV.	Q.P.	AV.
1	0.171	0.19	51.33	-	51.52	-	64.92	54.92	-13.40	-
2	0.255	0.22	41.61	-	41.83	-	61.58	51.58	-19.75	-
3	0.344	0.27	33.79	-	34.06	-	59.11	49.11	-25.05	-
4	2.129	0.35	24.65	-	25.00	-	56.00	46.00	-31.00	-
5	10.134	0.72	30.82	-	31.54	-	60.00	50.00	-28.46	-
6	14.005	0.97	26.67	-	27.64	-	60.00	50.00	-32.36	-

- REMARKS:**
1. Q.P. and AV. are abbreviations of quasi-peak and average individually.
 2. "-": The Quasi-peak reading value also meets average limit and measurement with the average detector is unnecessary.
 3. The emission levels of other frequencies were very low against the limit.
 4. Margin value = Emission level - Limit value
 5. Correction factor = Insertion loss + Cable loss
 6. Emission Level = Correction Factor + Reading Value.

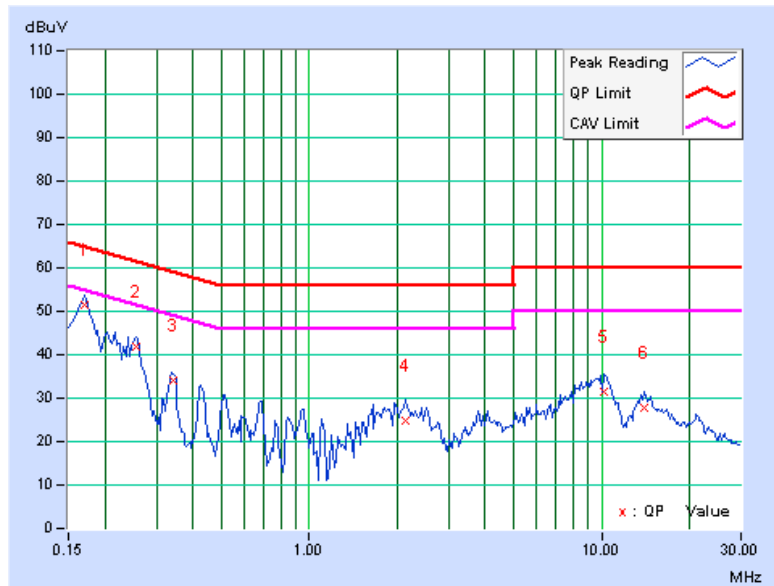

PHASE	Line 2	6dB BANDWIDTH	9 kHz
TEST MODE	A		

No	Freq. [MHz]	Corr. Factor (dB)	Reading Value		Emission Level		Limit		Margin	
			[dB (uV)]		[dB (uV)]		[dB (uV)]		(dB)	
			Q.P.	AV.	Q.P.	AV.	Q.P.	AV.	Q.P.	AV.
1	0.172	0.29	52.20	-	52.49	-	64.86	54.86	-12.37	-
2	0.259	0.31	41.94	-	42.25	-	61.45	51.45	-19.20	-
3	0.347	0.35	33.40	-	33.75	-	59.04	49.04	-25.29	-
4	1.823	0.41	27.66	-	28.07	-	56.00	46.00	-27.93	-
5	10.554	0.72	30.43	-	31.15	-	60.00	50.00	-28.85	-
6	14.573	0.91	27.46	-	28.37	-	60.00	50.00	-31.63	-

- REMARKS:**
1. Q.P. and AV. are abbreviations of quasi-peak and average individually.
 2. "-": The Quasi-peak reading value also meets average limit and measurement with the average detector is unnecessary.
 3. The emission levels of other frequencies were very low against the limit.
 4. Margin value = Emission level - Limit value
 5. Correction factor = Insertion loss + Cable loss
 6. Emission Level = Correction Factor + Reading Value.

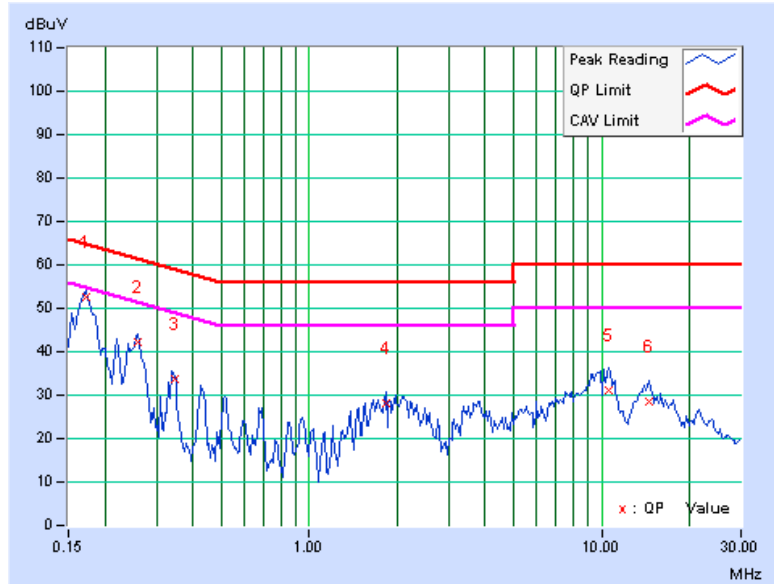

PHASE	Line 1	6dB BANDWIDTH	9 kHz
TEST MODE	B		

No	Freq. [MHz]	Corr. Factor (dB)	Reading Value		Emission Level		Limit		Margin	
			[dB (uV)]		[dB (uV)]		[dB (uV)]		(dB)	
			Q.P.	AV.	Q.P.	AV.	Q.P.	AV.	Q.P.	AV.
1	0.160	0.19	27.49	-	27.68	-	65.48	55.48	-37.80	-
2	0.198	0.19	27.61	-	27.80	-	63.69	53.69	-35.89	-
3	0.352	0.27	31.88	-	32.15	-	58.92	48.92	-26.77	-
4	0.617	0.30	16.34	-	16.64	-	56.00	46.00	-39.36	-
5	1.029	0.31	14.74	-	15.05	-	56.00	46.00	-40.95	-
6	12.827	0.89	9.02	-	9.91	-	60.00	50.00	-50.09	-

- REMARKS:**
1. Q.P. and AV. are abbreviations of quasi-peak and average individually.
 2. "-": The Quasi-peak reading value also meets average limit and measurement with the average detector is unnecessary.
 3. The emission levels of other frequencies were very low against the limit.
 4. Margin value = Emission level - Limit value
 5. Correction factor = Insertion loss + Cable loss
 6. Emission Level = Correction Factor + Reading Value.

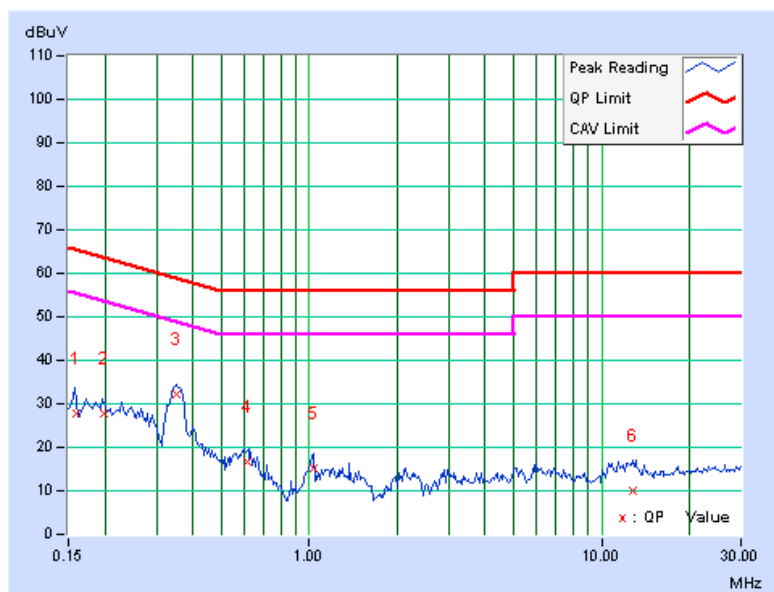

PHASE	Line 2	6dB BANDWIDTH	9 kHz
TEST MODE	B		

No	Freq. [MHz]	Corr. Factor (dB)	Reading Value		Emission Level		Limit		Margin	
			[dB (uV)]		[dB (uV)]		[dB (uV)]		(dB)	
			Q.P.	AV.	Q.P.	AV.	Q.P.	AV.	Q.P.	AV.
1	0.166	0.29	28.13	-	28.42	-	65.18	55.18	-36.76	-
2	0.197	0.28	27.09	-	27.37	-	63.73	53.73	-36.36	-
3	0.353	0.36	30.35	-	30.71	-	58.89	48.89	-28.18	-
4	1.030	0.39	14.92	-	15.31	-	56.00	46.00	-40.69	-
5	4.688	0.57	9.76	-	10.33	-	56.00	46.00	-45.67	-
6	12.932	0.83	16.72	-	17.55	-	60.00	50.00	-42.45	-

- REMARKS:**
1. Q.P. and AV. are abbreviations of quasi-peak and average individually.
 2. "-": The Quasi-peak reading value also meets average limit and measurement with the average detector is unnecessary.
 3. The emission levels of other frequencies were very low against the limit.
 4. Margin value = Emission level - Limit value
 5. Correction factor = Insertion loss + Cable loss
 6. Emission Level = Correction Factor + Reading Value.

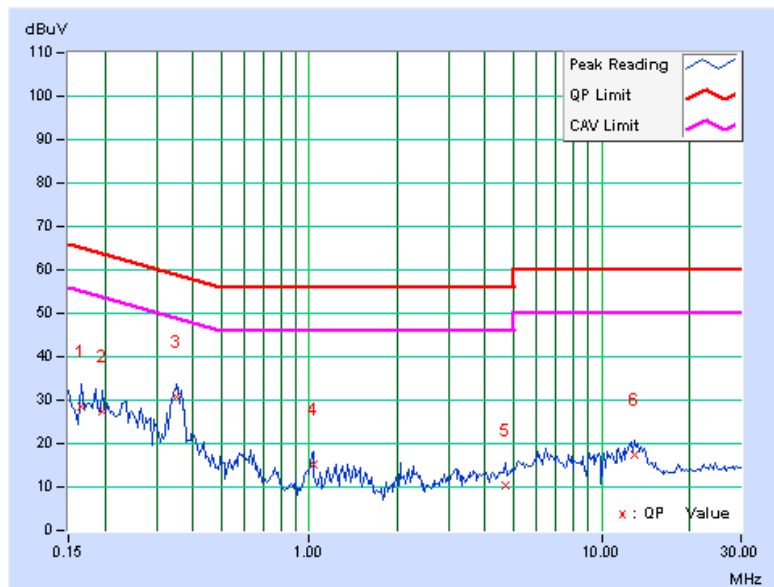

4.2 RADIATED EMISSION MEASUREMENT

4.2.1 LIMITS OF RADIATED EMISSION MEASUREMENT

Emissions radiated outside of the specified bands, shall be according to the general radiated limits in 15.209, 15.249 as following:

15.209 Limit		
Frequencies (MHz)	Field strength (microvolts/meter)	Measurement distance (meters)
0.009 ~ 0.490	2400/F(kHz)	300
0.490 ~ 1.705	24000/F(kHz)	30
1.705 ~ 30.0	30	30
30 ~ 88	100	3
88 ~ 216	150	3
216 ~ 960	200	3
Above 960	500	3
15.249 Limit		
Fundamental Frequency	Field Strength of Fundamental (millivolts/meter)	Field Strength of Harmonics (microvolts/meter)
902 ~ 928 MHz	50	500
2400 ~ 2483.5 MHz	50	500
5725 ~ 5875 MHz	50	500
24 ~ 24.25 GHz	250	2500

NOTE:

1. The lower limit shall apply at the transition frequencies.
2. Emission level (dBuV/m) = 20 log Emission level (uV/m).
3. As shown in 15.35(b), for frequencies above 1000MHz, the field strength limits are based on average detector, however, the peak field strength of any emission shall not exceed the maximum permitted average limits, specified above by more than 20dB under any condition of modulation.



4.2.2 TEST INSTRUMENTS

DESCRIPTION & MANUFACTURER	MODEL NO.	SERIAL NO.	CALIBRATED DATE	CALIBRATED UNTIL
HP Preamplifier	8447D	2432A03504	May 04, 2009	May 03, 2010
HP Preamplifier	8449B	3008A01924	Aug. 31, 2009	Aug. 30, 2010
HP Preamplifier	8449B	3008A01292	Aug. 10, 2009	Aug. 09, 2010
ROHDE & SCHWARZ TEST RECEIVER	ESU26	100005	Jun. 06, 2009	Jun. 05, 2010
Schwarzbeck Antenna	VULB 9168	137	Apr. 29, 2010	Apr. 28, 2011
Schwarzbeck Antenna	VHBA 9123	480	Apr. 29, 2010	Apr. 28, 2011
EMCO Horn Antenna	3115	6714	Oct. 26, 2009	Oct. 25, 2010
EMCO Horn Antenna	3115	9312-4192	Apr. 23, 2010	Apr. 22, 2011
ADT. Turn Table	TT100	0306	NA	NA
ADT. Tower	AT100	0306	NA	NA
Software	ADT_Radiated_V 7.6.15.9.2	NA	NA	NA
SUHNER RF cable	SF104-26.5	CABLE-CH6-17m -01	Aug. 20, 2009	Aug. 19, 2010
ROHDE & SCHWARZ Spectrum Analyzer	FSP 40	100036	Apr. 06, 2010	Apr. 05, 2011

- NOTE:**
1. The calibration interval of the above test instruments is 12/24 months. And the calibrations are traceable to NML/ROC and NIST/USA.
 2. The horn antenna and HP preamplifier (model: 8449B) are used only for the measurement of emission frequency above 1GHz if tested.
 3. The test was performed in Chamber No. 6.
 4. The Industry Canada Reference No. IC 7450E-6.
 5. The FCC Site Registration No. is 447212.

4.2.3 TEST PROCEDURES

- a. The EUT was placed on the top of a rotating table 0.8 meters above the ground at a 3 meter semi- anechoic chamber room. The table was rotated 360 degrees to determine the position of the highest radiation.
- b. The EUT was set 3 meters away from the interference-receiving antenna, which was mounted on the top of a variable-height antenna tower.
- c. The height of antenna is varied from one meter to four meters above the ground to determine the maximum value of the field strength. Both horizontal and vertical polarizations of the antenna are set to make the measurement.
- d. For each suspected emission, the EUT was arranged to its worst case and then the antenna was tuned to heights from 1 meter to 4 meters and the rotatable table was turned from 0 degrees to 360 degrees to find the maximum reading.
- e. The test-receiver system was set to quasi-peak detect function and specified bandwidth with maximum hold mode when the test frequency is below 1 GHz.
- f. If the emission level of the EUT in peak mode was lower than the limit specified, then testing could be stopped and the peak values of the EUT would be reported. Otherwise the emissions would be re-tested one by one using peak, quasi-peak method or average method as specified and then reported in data sheet.

NOTE:

1. The resolution bandwidth and video bandwidth of test receiver/spectrum analyzer is 120kHz for Peak detection (PK) and Quasi-peak detection (QP) at frequency below 1GHz.
2. The resolution bandwidth of test receiver/spectrum analyzer is 1 MHz and video bandwidth is 3MHz for Peak detection at frequency above 1GHz.
3. All modes of operation were investigated and the worst-case emissions are reported.

4.2.4 DEVIATION FROM TEST STANDARD

No deviation

4.2.5 TEST SETUP

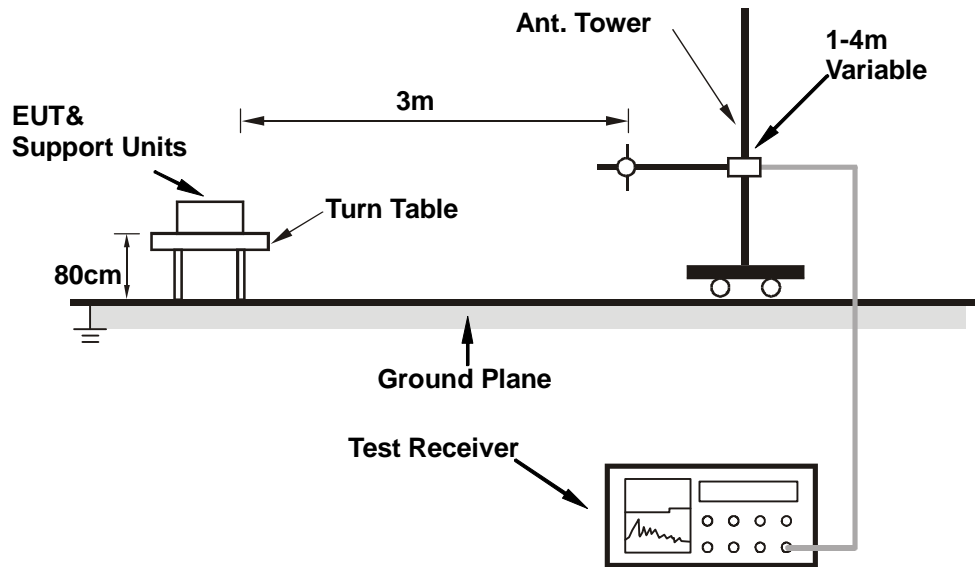

For the actual test configuration, please refer to the related item – Photographs of the Test Configuration.

4.2.6 EUT OPERATING CONDITIONS

For Mode A

- a. Connected the EUT to Notebook via USB cable.
- b. Turned on the power of all equipment.
- c. Notebook ran a test program (provided by manufacturer) to enable all functions.
- d. Set the EUT under charging condition.
- e. Notebook sent messages to printer and the printer printed them out.
- f. Notebook sent messages to modem.
- g. Steps e-g were repeated.

For Mode B

- a. Connected the EUT with AC adapter placed on testing table.
- b. Set the EUT under charging condition.

For Mode C

Set the EUT under transmission condition continuously at specific channel frequency.



4.2.7 TEST RESULTS

ABOVE 1GHz DATA

EUT TEST CONDITION		MEASUREMENT DETAIL	
CHANNEL	Channel 0	FREQUENCY RANGE	1 ~ 25GHz
INPUT POWER	3.3Vdc	DETECTOR FUNCTION	Peak (PK) Average (AV)
ENVIRONMENTAL CONDITIONS	20deg. C, 85%RH 1012hPa	TESTED BY	Chad Lee
TEST MODE	C		

ANTENNA POLARITY & TEST DISTANCE: HORIZONTAL AT 3 M								
NO.	FREQ. (MHz)	EMISSION LEVEL (dBuV/m)	LIMIT (dBuV/m)	MARGIN (dB)	ANTENNA HEIGHT (m)	TABLE ANGLE (Degree)	RAW VALUE (dBuV)	CORRECTION FACTOR (dB/m)
1	2390.00	57.9 PK	74.0	-16.1	1.03 H	292	26.34	31.55
2	2390.00	45.8 AV	54.0	-8.2	1.03 H	292	14.24	31.55
3	2400.00	45.4 PK	74.0	-28.6	1.03 H	292	13.79	31.59
4	2400.00	38.9 AV	54.0	-15.2	1.03 H	292	7.26	31.59
5	*2402.00	94.9 PK	114.0	-19.1	1.03 H	292	63.27	31.60
6	*2402.00	88.2 AV	94.0	-5.8	1.03 H	292	56.74	31.60
7	4804.00	49.9 PK	74.0	-24.1	1.00 H	327	12.26	37.66
8	4804.00	43.4 AV	54.0	-10.6	1.00 H	327	5.73	37.66

ANTENNA POLARITY & TEST DISTANCE: VERTICAL AT 3 M								
NO.	FREQ. (MHz)	EMISSION LEVEL (dBuV/m)	LIMIT (dBuV/m)	MARGIN (dB)	ANTENNA HEIGHT (m)	TABLE ANGLE (Degree)	RAW VALUE (dBuV)	CORRECTION FACTOR (dB/m)
1	2390.00	60.4 PK	74.0	-13.6	1.27 V	6	28.88	31.55
2	2390.00	45.6 AV	54.0	-8.4	1.27 V	6	14.07	31.55
3	2400.00	42.2 PK	74.0	-31.8	1.27 V	6	10.63	31.59
4	2400.00	35.7 AV	54.0	-18.3	1.27 V	6	4.10	31.59
5	*2402.00	91.7 PK	114.0	-22.3	1.27 V	6	60.11	31.60
6	*2402.00	85.2 AV	94.0	-8.8	1.27 V	6	53.58	31.60
7	4804.00	54.3 PK	74.0	-19.7	1.00 V	10	16.64	37.66
8	4804.00	47.8 AV	54.0	-6.2	1.00 V	10	10.11	37.66

- REMARKS:**
- Emission level (dBuV/m) = Raw Value (dBuV) + Correction Factor (dB/m).
 - Correction Factor (dB/m) = Antenna Factor (dB/m) + Cable Factor (dB).
 - The other emission levels were very low against the limit.
 - Margin value = Emission level – Limit value.
 - “ * ” : Fundamental frequency
 - The average value of fundamental frequency is: Average = Peak value + 20log(Duty cycle) Where the duty factor is calculated from following formula:
 $20 \log (\text{Duty cycle}) = 20 \log (12.564 \text{ ms} / 26.667 \text{ ms}) = -6.5\text{dB}$
 Please see page 26 for plotted duty.



A D T

EUT TEST CONDITION		MEASUREMENT DETAIL	
CHANNEL	Channel 39	FREQUENCY RANGE	1 ~ 25GHz
INPUT POWER	3.3Vdc	DETECTOR FUNCTION	Peak (PK) Average (AV)
ENVIRONMENTAL CONDITIONS	20deg. C, 85%RH 1012hPa	TESTED BY	Chad Lee
TEST MODE	C		

ANTENNA POLARITY & TEST DISTANCE: HORIZONTAL AT 3 M								
NO.	FREQ. (MHz)	EMISSION LEVEL (dBuV/m)	LIMIT (dBuV/m)	MARGIN (dB)	ANTENNA HEIGHT (m)	TABLE ANGLE (Degree)	RAW VALUE (dBuV)	CORRECTION FACTOR (dB/m)
1	*2441.00	95.2 PK	114.0	-18.8	1.00 H	293	63.41	31.75
2	*2441.00	88.7 AV	94.0	-5.3	1.00 H	293	56.88	31.75
3	4882.00	48.3 PK	74.0	-25.7	1.00 H	177	10.38	37.94
4	4882.00	41.8 AV	54.0	-12.2	1.00 H	177	3.85	37.94
ANTENNA POLARITY & TEST DISTANCE: VERTICAL AT 3 M								
NO.	FREQ. (MHz)	EMISSION LEVEL (dBuV/m)	LIMIT (dBuV/m)	MARGIN (dB)	ANTENNA HEIGHT (m)	TABLE ANGLE (Degree)	RAW VALUE (dBuV)	CORRECTION FACTOR (dB/m)
1	*2441.00	92.5 PK	114.0	-21.5	1.00 V	6	60.76	31.75
2	*2441.00	86.0 AV	94.0	-8.0	1.00 V	6	54.23	31.75
3	4882.00	54.6 PK	74.0	-19.4	1.00 V	7	16.66	37.94
4	4882.00	48.1 AV	54.0	-5.9	1.00 V	7	10.13	37.94

- REMARKS:**
1. Emission level (dBuV/m) = Raw Value (dBuV) + Correction Factor (dB/m).
 2. Correction Factor (dB/m) = Antenna Factor (dB/m) + Cable Factor (dB).
 3. The other emission levels were very low against the limit.
 4. Margin value = Emission level – Limit value.
 5. “ * ” : Fundamental frequency
 6. The average value of fundamental frequency is: Average = Peak value + 20log(Duty cycle) Where the duty factor is calculated from following formula:
 $20 \log (\text{Duty cycle}) = 20 \log (12.564 \text{ ms} / 26.667 \text{ ms}) = -6.5 \text{ dB}$
 Please see page 26 for plotted duty.



EUT TEST CONDITION		MEASUREMENT DETAIL	
CHANNEL	Channel 77	FREQUENCY RANGE	1 ~ 25GHz
INPUT POWER	3.3Vdc	DETECTOR FUNCTION	Peak (PK) Average (AV)
ENVIRONMENTAL CONDITIONS	20deg. C, 85%RH 1012hPa	TESTED BY	Chad Lee
TEST MODE	C		

ANTENNA POLARITY & TEST DISTANCE: HORIZONTAL AT 3 M								
NO.	FREQ. (MHz)	EMISSION LEVEL (dBuV/m)	LIMIT (dBuV/m)	MARGIN (dB)	ANTENNA HEIGHT (m)	TABLE ANGLE (Degree)	RAW VALUE (dBuV)	CORRECTION FACTOR (dB/m)
1	*2479.00	94.2 PK	114.0	-19.8	1.00 H	295	62.30	31.89
2	*2479.00	87.7 AV	94.0	-6.3	1.00 H	295	55.77	31.89
3	2483.50	49.5 PK	74.0	-24.5	1.00 H	16	17.57	31.91
4	2483.50	43.0 AV	54.0	-11.1	1.00 H	16	11.04	31.91
5	4958.00	48.4 PK	74.0	-25.6	1.00 H	269	10.30	38.10
6	4958.00	41.9 AV	54.0	-12.1	1.00 H	269	3.77	38.10
ANTENNA POLARITY & TEST DISTANCE: VERTICAL AT 3 M								
NO.	FREQ. (MHz)	EMISSION LEVEL (dBuV/m)	LIMIT (dBuV/m)	MARGIN (dB)	ANTENNA HEIGHT (m)	TABLE ANGLE (Degree)	RAW VALUE (dBuV)	CORRECTION FACTOR (dB/m)
1	*2479.00	91.6 PK	114.0	-22.4	1.24 V	20	59.75	31.89
2	*2479.00	85.1 AV	94.0	-8.9	1.24 V	20	53.22	31.89
3	2483.50	46.9 PK	74.0	-27.1	1.00 V	20	15.02	31.91
4	2483.50	40.4 AV	54.0	-13.6	1.00 V	20	8.49	31.91
5	4958.00	51.8 PK	74.0	-22.2	1.00 V	10	13.67	38.10
6	4958.00	45.3 AV	54.0	-8.7	1.00 V	10	7.14	38.10

- REMARKS:**
1. Emission level (dBuV/m) = Raw Value (dBuV) + Correction Factor (dB/m).
 2. Correction Factor (dB/m) = Antenna Factor (dB/m) + Cable Factor (dB).
 3. The other emission levels were very low against the limit.
 4. Margin value = Emission level – Limit value.
 5. “ * ” : Fundamental frequency
 6. The average value of fundamental frequency is: Average = Peak value + 20log(Duty cycle) Where the duty factor is calculated from following formula:
 $20 \log (\text{Duty cycle}) = 20 \log (12.564 \text{ ms} / 26.667 \text{ ms}) = -6.5 \text{ dB}$
 Please see page 26 for plotted duty.



A D T

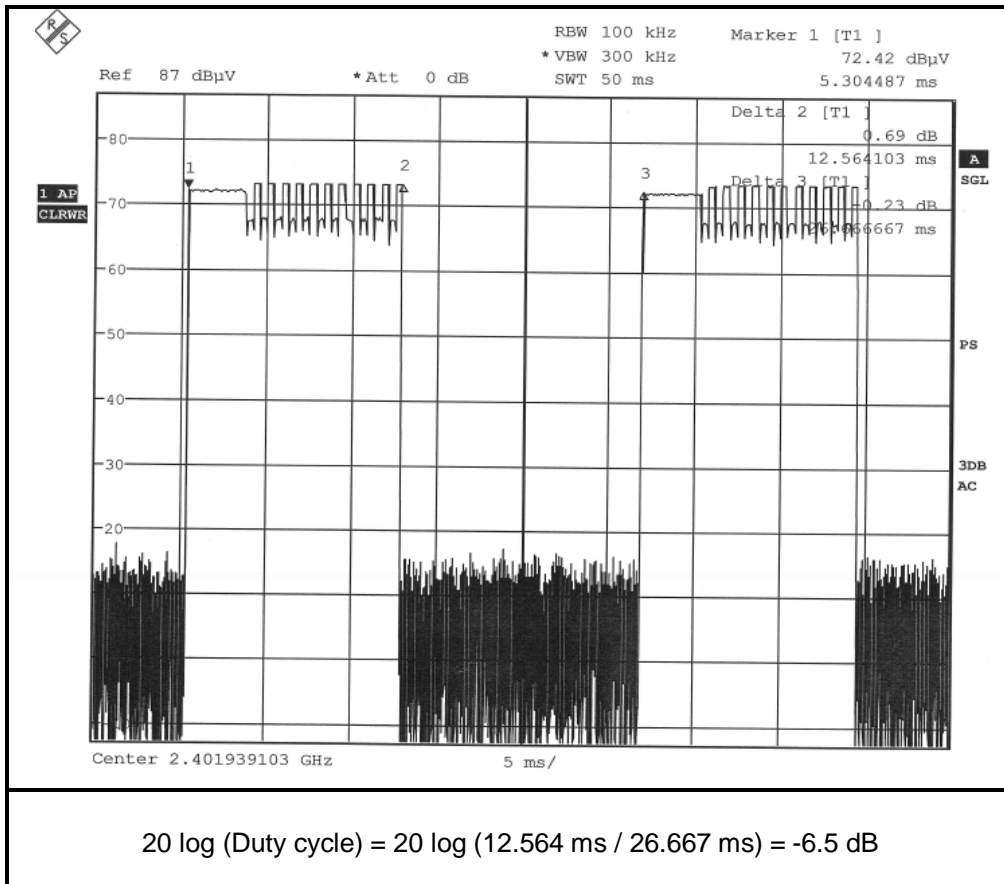



A D T

BELOW 1GHz WORST-CASE DATA

EUT TEST CONDITION		MEASUREMENT DETAIL	
INPUT POWER (SYSTEM)	120Vac, 60Hz	FREQUENCY RANGE	Below 1000MHz
ENVIRONMENTAL CONDITIONS	20deg. C, 85%RH 1019hPa	DETECTOR FUNCTION	Quasi-Peak
TEST MODE	A	TESTED BY	Chad Lee

ANTENNA POLARITY & TEST DISTANCE: HORIZONTAL AT 3 M								
NO.	FREQ. (MHz)	EMISSION LEVEL (dBuV/m)	LIMIT (dBuV/m)	MARGIN (dB)	ANTENNA HEIGHT (m)	TABLE ANGLE (Degree)	RAW VALUE (dBuV)	CORRECTION FACTOR (dB/m)
1	37.77	30.2 QP	40.0	-9.8	1.22 H	133	17.30	12.90
2	93.73	34.2 QP	43.5	-9.3	1.00 H	289	25.83	8.39
3	124.82	35.2 QP	43.5	-8.3	1.08 H	7	23.30	11.89
4	258.51	35.3 QP	46.0	-10.7	1.53 H	166	21.90	13.44
5	455.93	35.2 QP	46.0	-10.8	1.00 H	145	15.37	19.80
6	867.87	37.6 QP	46.0	-8.4	1.00 H	304	9.96	27.63
ANTENNA POLARITY & TEST DISTANCE: VERTICAL AT 3 M								
NO.	FREQ. (MHz)	EMISSION LEVEL (dBuV/m)	LIMIT (dBuV/m)	MARGIN (dB)	ANTENNA HEIGHT (m)	TABLE ANGLE (Degree)	RAW VALUE (dBuV)	CORRECTION FACTOR (dB/m)
1	93.73	34.2 QP	43.5	-9.3	1.55 V	325	25.82	8.39
2	124.82	35.2 QP	43.5	-8.4	1.63 V	322	23.26	11.89
3	132.60	37.5 QP	43.5	-6.0	1.44 V	172	24.74	12.73
4	451.27	37.5 QP	46.0	-8.5	1.87 V	157	17.87	19.66
5	457.48	36.8 QP	46.0	-9.2	1.00 V	160	17.00	19.84
6	866.31	36.6 QP	46.0	-9.5	1.00 V	304	8.95	27.61

- REMARKS:**
1. Emission level (dBuV/m) = Raw Value (dBuV) + Correction Factor (dB/m).
 2. Correction Factor (dB/m) = Antenna Factor (dB/m) + Cable Factor (dB).
 3. The other emission levels were very low against the limit.
 4. Margin value = Emission level – Limit value.



A D T

EUT TEST CONDITION		MEASUREMENT DETAIL	
INPUT POWER	120Vac, 60Hz	FREQUENCY RANGE	Below 1000MHz
ENVIRONMENTAL CONDITIONS	20deg. C, 85%RH 1019hPa	DETECTOR FUNCTION	Quasi-Peak
TEST MODE	B	TESTED BY	Chad Lee

ANTENNA POLARITY & TEST DISTANCE: HORIZONTAL AT 3 M								
NO.	FREQ. (MHz)	EMISSION LEVEL (dBuV/m)	LIMIT (dBuV/m)	MARGIN (dB)	ANTENNA HEIGHT (m)	TABLE ANGLE (Degree)	RAW VALUE (dBuV)	CORRECTION FACTOR (dB/m)
1	36.22	19.7 QP	40.0	-20.4	1.12 H	313	7.07	12.58
2	70.42	22.6 QP	40.0	-17.4	1.56 H	13	10.49	12.08
3	146.59	22.9 QP	43.5	-20.6	1.76 H	280	8.74	14.12
4	494.79	25.1 QP	46.0	-20.9	1.86 H	274	4.19	20.93
5	805.69	25.3 QP	46.0	-20.7	1.22 H	295	-1.44	26.70
6	832.12	26.9 QP	46.0	-19.1	1.00 H	310	-0.20	27.12
ANTENNA POLARITY & TEST DISTANCE: VERTICAL AT 3 M								
NO.	FREQ. (MHz)	EMISSION LEVEL (dBuV/m)	LIMIT (dBuV/m)	MARGIN (dB)	ANTENNA HEIGHT (m)	TABLE ANGLE (Degree)	RAW VALUE (dBuV)	CORRECTION FACTOR (dB/m)
1	39.33	25.6 QP	40.0	-14.4	1.08 V	247	12.36	13.22
2	89.07	28.1 QP	43.5	-15.4	1.50 V	250	19.87	8.25
3	109.28	26.3 QP	43.5	-17.2	1.50 V	28	16.22	10.04
4	141.92	29.3 QP	43.5	-14.2	1.22 V	40	15.64	13.70
5	799.47	25.5 QP	46.0	-20.5	1.50 V	187	-1.08	26.60
6	824.34	25.9 QP	46.0	-20.1	1.53 V	100	-1.11	26.99

- REMARKS:**
1. Emission level (dBuV/m) = Raw Value (dBuV) + Correction Factor (dB/m).
 2. Correction Factor (dB/m) = Antenna Factor (dB/m) + Cable Factor (dB).
 3. The other emission levels were very low against the limit.
 4. Margin value = Emission level – Limit value.



A D T

EUT TEST CONDITION		MEASUREMENT DETAIL	
CHANNEL	Channel 0	FREQUENCY RANGE	Below 1000MHz
INPUT POWER	3.3Vdc	DETECTOR FUNCTION	Quasi-Peak
ENVIRONMENTAL CONDITIONS	20deg. C, 85%RH 1019hPa	TESTED BY	Chad Lee
TEST MODE	C		

ANTENNA POLARITY & TEST DISTANCE: HORIZONTAL AT 3 M								
NO.	FREQ. (MHz)	EMISSION LEVEL (dBuV/m)	LIMIT (dBuV/m)	MARGIN (dB)	ANTENNA HEIGHT (m)	TABLE ANGLE (Degree)	RAW VALUE (dBuV)	CORRECTION FACTOR (dB/m)
1	35.83	21.2 QP	40.0	-18.8	1.82 H	139	8.74	12.50
2	86.37	23.4 QP	40.0	-16.6	1.00 H	289	14.70	8.70
3	154.41	24.9 QP	43.5	-18.6	1.36 H	283	10.64	14.24
4	867.82	26.2 QP	46.0	-19.8	1.00 H	40	-1.41	27.63
5	879.48	27.2 QP	46.0	-18.9	1.14 H	4	-0.63	27.78
6	939.74	27.2 QP	46.0	-18.8	1.59 H	148	-1.25	28.48
ANTENNA POLARITY & TEST DISTANCE: VERTICAL AT 3 M								
NO.	FREQ. (MHz)	EMISSION LEVEL (dBuV/m)	LIMIT (dBuV/m)	MARGIN (dB)	ANTENNA HEIGHT (m)	TABLE ANGLE (Degree)	RAW VALUE (dBuV)	CORRECTION FACTOR (dB/m)
1	35.00	23.4 QP	40.0	-16.6	1.06 V	352	11.09	12.33
2	82.48	25.8 QP	40.0	-14.3	1.12 V	25	16.41	9.34
3	136.91	25.1 QP	43.5	-18.4	1.74 V	181	11.87	13.20
4	852.26	28.3 QP	46.0	-17.7	1.55 V	37	0.84	27.43
5	893.09	29.4 QP	46.0	-16.6	1.03 V	316	1.43	27.95
6	943.63	29.1 QP	46.0	-16.9	1.13 V	25	0.56	28.52

- REMARKS:**
1. Emission level (dBuV/m) = Raw Value (dBuV) + Correction Factor (dB/m).
 2. Correction Factor (dB/m) = Antenna Factor (dB/m) + Cable Factor (dB).
 3. The other emission levels were very low against the limit.
 4. Margin value = Emission level – Limit value.

4.3 BAND EDGES MEASUREMENT

4.3.1 LIMITS OF BAND EDGES MEASUREMENT

Below -50dB of the highest emission level of operating band (in 100kHz Resolution Bandwidth).

4.3.2 TEST INSTRUMENTS

DESCRIPTION & MANUFACTURER	MODEL NO.	SERIAL NO.	CALIBRATED DATE	CALIBRATED UNTIL
SPECTRUM ANALYZER	FSP 40	100036	Apr. 06, 2010	Apr. 05, 2011

NOTE: The calibration interval of the above test instruments is 12 months and the calibrations are traceable to NML/ROC and NIST/USA.

4.3.3 TEST PROCEDURE

The transmitter output was connected to the spectrum analyzer via a low lose cable. Set both RBW and VBW of spectrum analyzer to 100 kHz and 300 kHz with suitable frequency span including 100 MHz bandwidth from band edge. The band edges was measured and recorded.

The spectrum plots are attached on the following pages.

4.3.4 DEVIATION FROM TEST STANDARD

No deviation

4.3.5 EUT OPERATING CONDITION

Same as Item 4.2.6



A D T

4.3.6 TEST RESULTS

MODE C

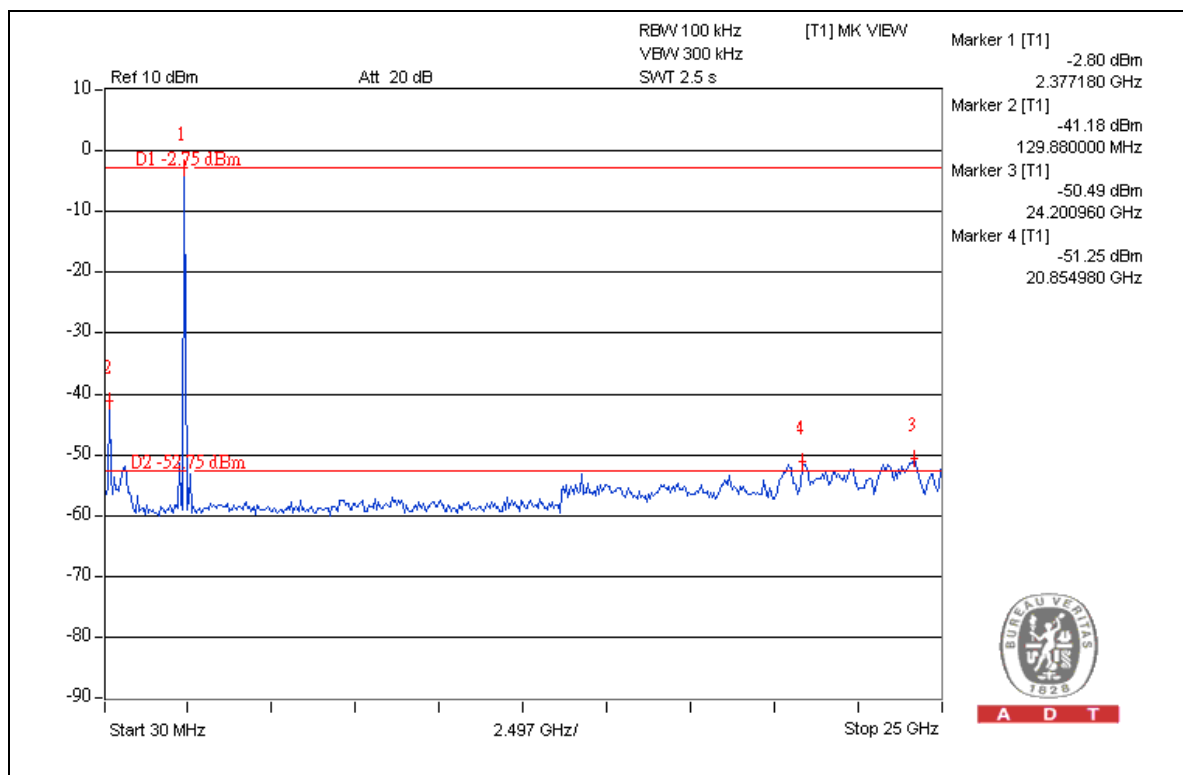
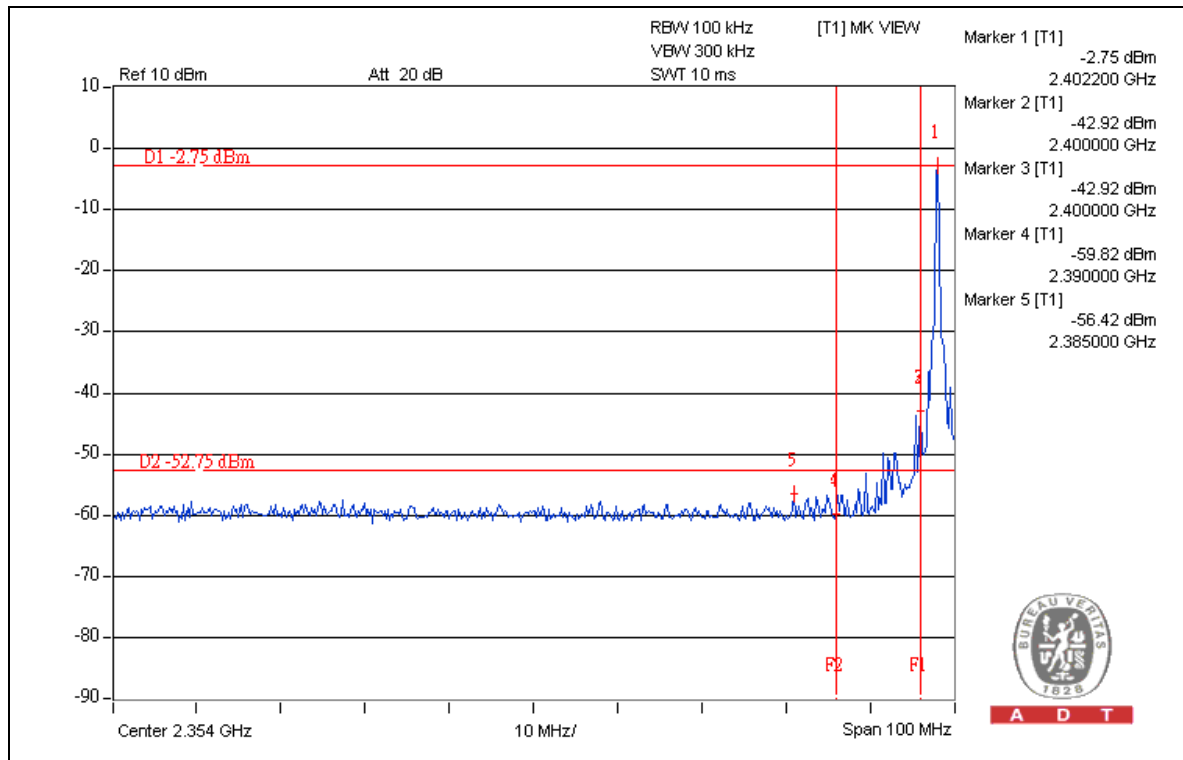



A D T

MODE C

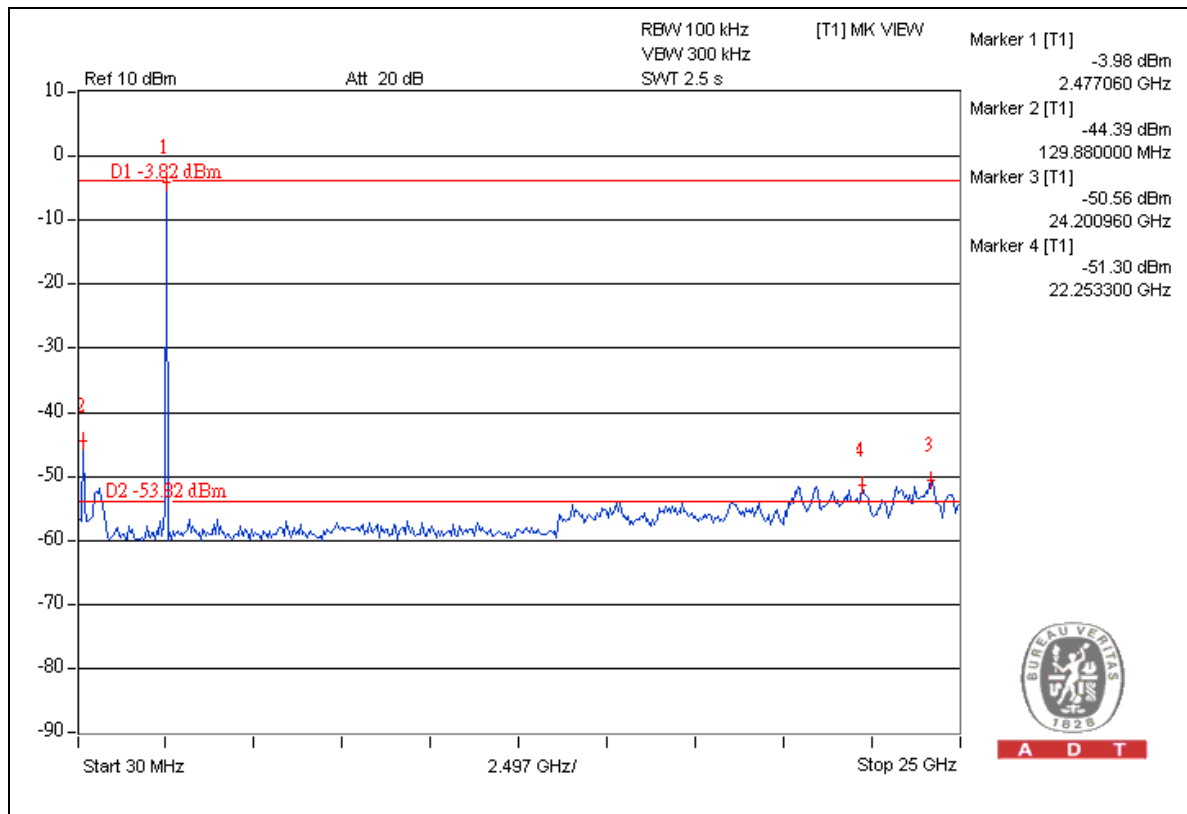
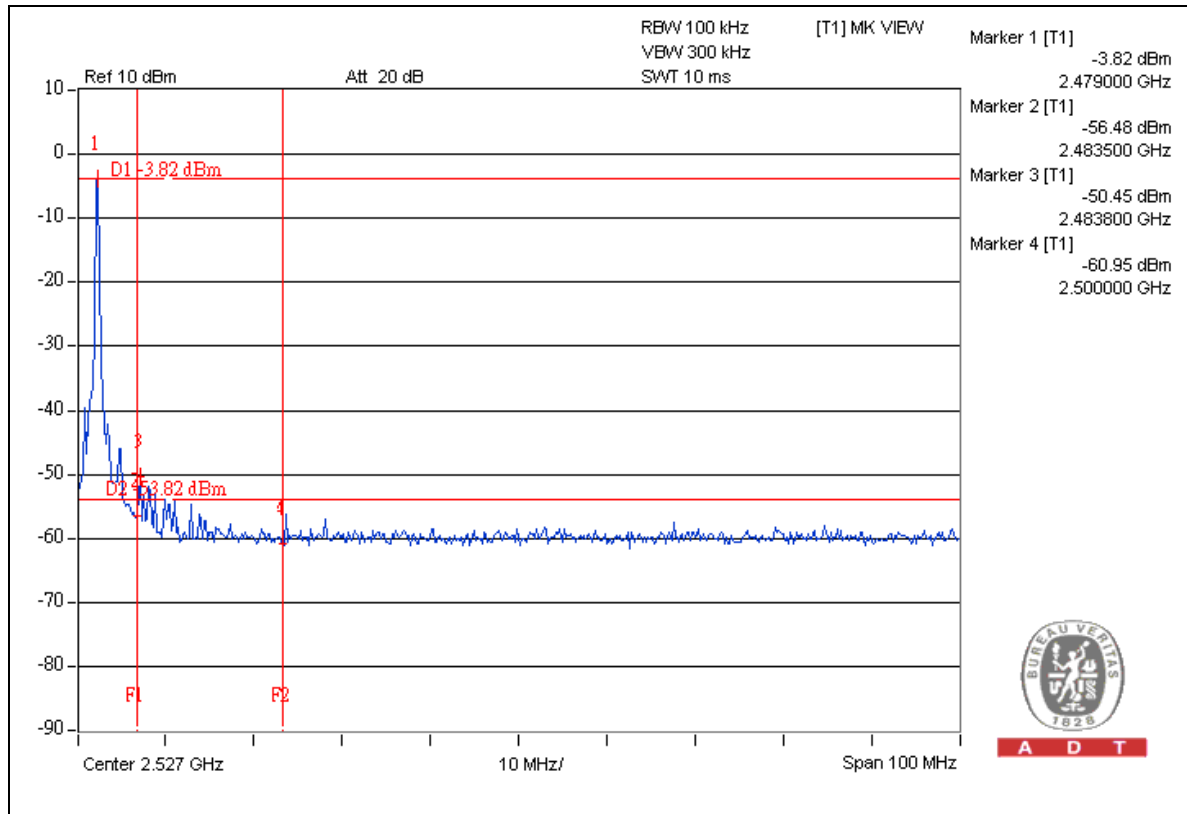

5. PHOTOGRAPHS OF THE TEST CONFIGURATION

Please refer to the attached file (Test Setup Photo).



6. INFORMATION ON THE TESTING LABORATORIES

We, Bureau Veritas Consumer Products Services (H.K.) Ltd., Taoyuan Branch, were founded in 1988 to provide our best service in EMC, Radio, Telecom and Safety consultation. Our laboratories are accredited and approved according to ISO/IEC 17025.

Copies of accreditation certificates of our laboratories obtained from approval agencies can be downloaded from our web site: www.adt.com.tw/index.5/phtml. If you have any comments, please feel free to contact us at the following:

Linko EMC/RF Lab:

Tel: 886-2-26052180

Fax: 886-2-26051924

Hsin Chu EMC/RF Lab:

Tel: 886-3-5935343

Fax: 886-3-5935342

Hwa Ya EMC/RF/Safety Telecom Lab:

Tel: 886-3-3183232

Fax: 886-3-3185050

Web Site: www.adt.com.tw

The address and road map of all our labs can be found in our web site also.



A D T

7. APPENDIX A – MODIFICATIONS RECORDERS FOR ENGINEERING CHANGES TO THE EUT BY THE LAB

No any modifications are made to the EUT by the lab during the test.

---END---