

## SAR Test Report

Product Name : GSM850/DCS1800 / PCS1900  
GSM/GPRS Mobile Phone  
Model No. : HERC3A(M580a)

Applicant : BenQ Corporation  
Address : 157 Shan-Ying Road, Gueishan, Taoyuan 333,  
Taiwan, R.O.C.

Date of Receipt : 2006/01/23  
Issued Date : 2006/02/08  
Report No. : 061L148-HP-US-P10V01  
Reference No. : NL-6341

The test results relate only to the samples tested.

The test report shall not be reproduced except in full without the written approval of QuieTek Corporation.

SAR test report is for production unit.



## TABLE OF CONTENTS

Description	Page
<b>1. General Information.....</b>	<b>5</b>
1.1 EUT Description .....	5
1.2 Test Environment .....	5
<b>2. SAR Measurement System.....</b>	<b>6</b>
2.1 ALSAS-10U System Description .....	6
2.1.1 Applications .....	6
2.1.2 Area Scans.....	6
2.1.3 Zoom Scan (Cube Scan Averaging).....	7
2.1.4 ALSAS-10U Interpolation and Extrapolation Uncertainty.....	7
2.2 Isotropic E-Field Probe .....	7
2.2.1 Isotropic E-Field Probe Specification.....	9
2.3 Boundary Detection Unit and Probe Mounting Device .....	9
2.4 Daq-Paq (Analog to Digital Electronics).....	10
2.5 Axis Articulated Robot .....	10
2.6 ALSAS Universal Workstation.....	11
2.7 Universal Device Positioner.....	11
2.8 Phantom Types.....	11
2.8.1 APREL SAM Phantoms .....	12
2.8.2 APREL Laboratories Universal Phantom.....	12
<b>3. Tissue Simulating Liquid.....</b>	<b>13</b>
3.1 The composition of the tissue simulating liquid.....	13
3.2 Tissue Calibration Result .....	13
3.3 Tissue Dielectric Parameters for Head and Body Phantoms .....	15
<b>4. SAR Measurement Procedure.....</b>	<b>16</b>
4.1 SAR System Validation.....	16
4.1.1 Validation Dipoles.....	16
4.1.2 Validation Result.....	16
4.2 Arrangement Assessment Setup .....	17
4.2.1 Test Positions of Device Relative to Head.....	17
4.2.1.1 Definition of the “Cheek” Position .....	17
4.2.1.2 Definition of the “Tilted” Position.....	18
4.2.2 Test Positions for body-worn.....	19
4.3 SAR Measurement Procedure.....	19
<b>5. SAR Exposure Limits .....</b>	<b>21</b>
<b>6. Test Equipment List.....</b>	<b>22</b>

7. **Measurement Uncertainty**..... **23**

8. **Test Results** ..... **24**

    8.1 SAR Test Results Summary ..... 24

    Appendix A. SAR System Validation Data..... 28

    Appendix B. SAR measurement Data..... 28

    Appendix C. Test Setup Photographs & EUT Photographs..... 28

    Appendix D. Probe Calibration Data ..... 28

    Appendix E. Dipole Calibration Data ..... 28

## 1. General Information

### 1.1 EUT Description

Product Name	GSM850/DCS1800 / PCS1900 GSM/GPRS Mobile Phone
Model No.	HERC3A(M580a)
IMEI No.	358559~61-00-XXXXXXY
TX Frequency	824MHz~849MHz(GSM850) 1850MHz ~ 1910MHz(PCS1900)
RX Frequency	869MHz~894MHz(GSM850) 1930MHz ~ 1990MHz(PCS1900)
Antenna Type	Internal
Device Category	Portable
RF Exposure Environment	Uncontrolled
Hardware version	LDR-3-4-B
Software version	V0.18
Max. Output Power (Conducted) GSM 850	32.5dBm
Max. Output Power (Conducted) PCS 1900	29.8dBm
Test Mode	GSM Mode: Voice Note: It is not intended to be used by the head during the data operation mode.
Handsfree	P/N: 2C.43035.111
Battery Pack	P/N: 2C.2G0M0.101, 870mAh
Changer	P/N: 2E.11060.XXX(X=0~9,A~Z or Blank)

### 1.2 Test Environment

Ambient conditions in the laboratory:

Items	Required	Actual
Temperature (°C)	18-25	21.2
Humidity (%RH)	30-70	57

## 2. SAR Measurement System

### 2.1 ALSAS-10U System Description

**ALSAS-10-U** is fully compliant with the technical and scientific requirements of IEEE 1528, IEC 62209, CENELEC, ARIB, ACA, and the Federal Communications Commission. The system comprises of a six axes articulated robot which utilizes a dedicated controller.

ALSAS-10U uses the latest methodologies and FDTD modeling to provide a platform which is repeatable with minimum uncertainty.

#### 2.1.1 Applications

Predefined measurement procedures compliant with the guidelines of CENELEC, IEEE, IEC, FCC, etc are utilized during the assessment for the device. Automatic detection for all SAR maxima are embedded within the core architecture for the system, ensuring that peak locations used for centering the zoom scan are within a 1mm resolution and a 0.05mm repeatable position. System operation range currently available up-to 6 GHz in simulated tissue.

#### 2.1.2 Area Scans

Area scans are defined prior to the measurement process being executed with a user defined variable spacing between each measurement point (integral) allowing low uncertainty measurements to be conducted. Scans defined for FCC applications utilize a 10mm<sup>2</sup> step integral, with 1mm interpolation used to locate the peak SAR area used for zoom scan assessments.

Where the system identifies multiple SAR peaks (which are within 25% of peak value) the system will provide the user with the option of assessing each peak location individually for zoom scan averaging.

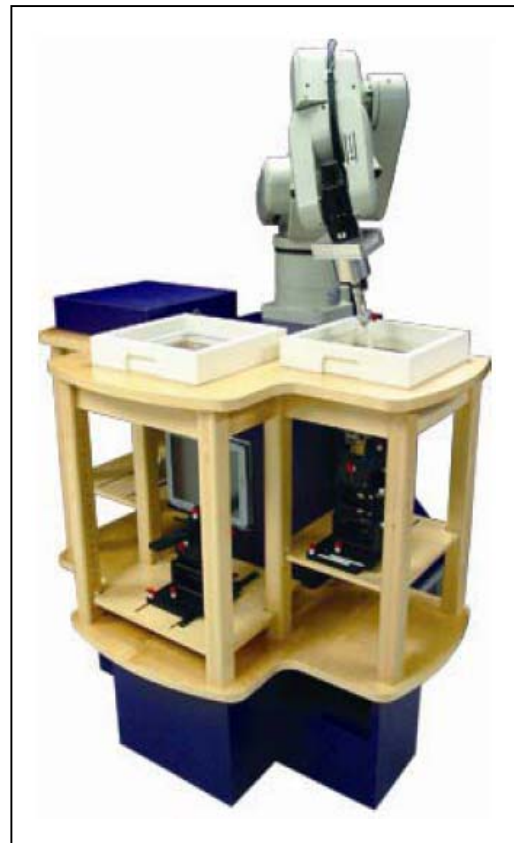

**2.1.3 Zoom Scan (Cube Scan Averaging)**

The averaging zoom scan volume utilized in the ALSAS-10U software is in the shape of a cube and the side dimension of a 1 g or 10 g mass is dependent on the density of the liquid representing the simulated tissue. A density of 1000 kg/m<sup>3</sup> is used to represent the head and body tissue density and not the phantom liquid density, in order to be consistent with the definition of the liquid dielectric properties, i.e. the side length of the 1 g cube is 10mm, with the side length of the 10 g cube 21,5mm.

When the cube intersects with the surface of the phantom, it is oriented so that 3 vertices touch the surface of the shell or the center of a face is tangent to the surface. The face of the cube closest to the surface is modified in order to conform to the tangent surface.

The zoom scan integer steps can be user defined so as to reduce uncertainty, but normal practice for typical test applications (including FCC) utilize a physical step of 5x5x8 (8mmx8mmx5mm) providing a volume of 32mm in the X & Y axis, and 35mm in the Z axis.

**2.1.4 ALSAS-10U Interpolation and Extrapolation Uncertainty**

The overall uncertainty for the methodology and algorithms the used during the SAR calculation was evaluated using the data from IEEE 1528 based on the example f3 algorithm:

$$f_3(x, y, z) = A \frac{a^2}{\frac{a^2}{4} + x'^2 + y'^2} \cdot \left( e^{-\frac{2z}{a}} + \frac{a^2}{2(a + 2z)^2} \right)$$

**2.2 Isotropic E-Field Probe**

The isotropic E-Field probe has been fully calibrated and assessed for isotropicity, and boundary effect within a controlled environment. Depending on the frequency for which the probe is calibrated the method utilized for calibration will change. A number of methods is used for calibrating probes, and these are outlined in the table below:

Calibration Frequency	Air Calibration	Tissue Calibration
835MHz	TEM Cell	Temperature
1900MHz	TEM Cell	Temperature

The E-Field probe utilizes a triangular sensor arrangement as detailed in the diagram below:

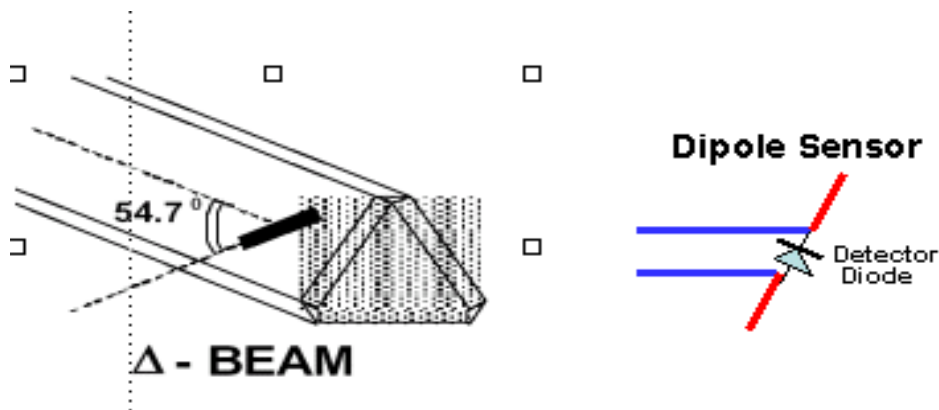

SAR is assessed with a calibrated probe which moves at a default height of 5mm from the center of the diode, which is mounted to the sensor, to the phantom surface (in the Z Axis). The 5mm offset height has been selected so as to minimize any resultant boundary effect due to the probe being in close proximity to the phantom surface.

The following algorithm is an example of the function used by the system for linearization of the output from the probe when measuring complex modulation schemes.

$$V_i = U_i + U_i^2 \cdot \frac{cf}{dcp_i}$$



**2.2.1 Isotropic E-Field Probe Specification**

<b>Calibration in Air</b>	Frequency Dependent Below 2GHz Calibration in air performed in a TEM Cell Above 2GHz Calibration in air performed in waveguide
<b>Sensitivity</b>	0.70 $\mu\text{V}/(\text{V}/\text{m})^2$ to 0.85 $\mu\text{V}/(\text{V}/\text{m})^2$
<b>Dynamic Range</b>	0.0005 W/kg to 100W/kg
<b>Isotropic Response</b>	Better than 0.2dB
<b>Diode Compression point (DCP)</b>	Calibration for Specific Frequency
<b>Probe Tip Radius</b>	< 5mm
<b>Sensor Offset</b>	1.56 (+/- 0.02mm)
<b>Probe Length</b>	290mm
<b>Video Bandwidth</b>	@ 500 Hz: 1dB @1.02 KHz: 3dB
<b>Boundary Effect</b>	Less than 2% for distance greater than 2.4mm
<b>Spatial Resolution</b>	Diameter less than 5mm Compliant with Standards

**2.3 Boundary Detection Unit and Probe Mounting Device**

ALSAS-10U incorporates a boundary detection unit with a sensitivity of 0.05mm for detecting all types of surfaces. The robust design allows for detection during probe tilt (probe normalize) exercises, and utilizes a second stage emergency stop. The signal electronics are fed directly into the robot controller for high accuracy surface detection in lateral and axial detection modes (X, Y, & Z).

The probe is mounted directly onto the Boundary Detection unit for accurate tooling and displacement calculations controlled by the robot kinematics. The probe is connect to an isolated probe interconnect where the output stage of the probe is fed directly into the amplifier stage of the Daq-Paq

**2.4 Daq-Paq (Analog to Digital Electronics)**

ALSAS-10U incorporates a fully calibrated Daq-Paq (analog to digital conversion system) which has a 4 channel input stage, sent via a 2 stage auto-set amplifier module. The input signal is amplified accordingly so as to offer a dynamic range from 5µV to 800mV. Integration of the fields measured is carried out at board level utilizing a Co-Processor which then sends the measured fields down into the main computational module in digitized form via an RS232 communications port. Probe linearity and duty cycle compensation is carried out within the main Daq-Paq module.

<b>ADC</b>	12 Bit
<b>Amplifier Range</b>	20mV to 200mV and 150mV to 800mV
<b>Field Integration</b>	Local Co-Processor utilizing proprietary integration algorithms
<b>Number of Input Channels</b>	4 in total 3 dedicated and 1 spare
<b>Communication</b>	Packet data via RS232

**2.5 Axis Articulated Robot**



ALSAS-10U utilizes a six axis articulated robot, which is controlled using a Pentium based real-time movement controller. The movement kinematics engine utilizes proprietary (Thermo CRS) interpolation and extrapolation algorithms, which allow full freedom of movement for each of the six joints within the working envelope. Utilization of joint 6 allows for full probe rotation with a tolerance better than 0.05mm around the central axis.

<b>Robot/Controller Manufacturer</b>	Thermo CRS
<b>Number of Axis</b>	Six independently controlled axis
<b>Positioning Repeatability</b>	0.05mm
<b>Controller Type</b>	Single phase Pentium based C500C
<b>Robot Reach</b>	710mm
<b>Communication</b>	RS232 and LAN compatible

**2.6 ALSAS Universal Workstation**

ALSAS Universal workstation allows for repeatability and fast adaptability. It allows users to do calibration, testing and measurements using different types of phantoms with one set up, which significantly speeds up the measurement process.

**2.7 Universal Device Positioner**

The universal device positioner allow complete freedom of movement of the EUT. Developed to hold a EUT in a free-space scenario any additional loading attributable to the material used in the construction of the positioner has been eliminated. Repeatability has been enhanced through the linear scales which form the design used to indicate positioning for any given test scenario in all major axes. A 15° tilt indicator is included for the of aid cheek to tilt movements for head SAR analysis. Overall uncertainty for measurements have been reduced due to the design of the Universal device positioner, which allows positioning of a device in as near to a free-space scenario as possible, and by providing the means for complete repeatability.



**2.8 Phantom Types**

The ALSAS-10U allows the integration of multiple phantom types. SAM Phantoms fully compliant with IEEE 1528, Universal Phantom, and Universal Flat.

**2.8.1 APREL SAM Phantoms**

The SAM phantoms developed using the IEEE SAM CAD file. They are fully compliant with the requirements for both IEEE 1528 and FCC Supplement C. Both the left and right SAM phantoms are interchangeable, transparent and include the IEEE 1528 grid with visible NF and MB lines.

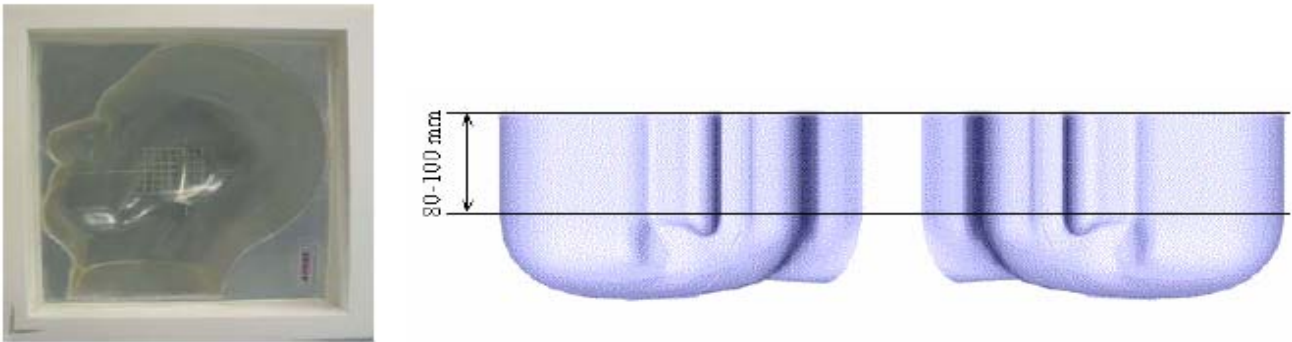

**2.8.2 APREL Laboratories Universal Phantom**

The Universal Phantom is used on the ALSAS-10U as a system validation phantom. The Universal Phantom has been fully validated both experimentally from 800MHz to 6GHz and numerically using XFDTD numerical software. The shell thickness is 2mm overall, with a 4mm spacer located at the NF/MB intersection providing an overall thickness of 6mm in line with the requirements of IEEE-1528.

The design allows for fast and accurate measurements, of handsets, by allowing the conservative SAR to be evaluated at on frequency for both left and right head experiments in one measurement.



### 3. Tissue Simulating Liquid

#### 3.1 The composition of the tissue simulating liquid

INGREDIENT (% Weight)	850MHz Head	850MHz Body	1900MHz Head	1900MHz Body
<b>Water</b>	40.45%	52.4%	54.90	40.5
<b>Salt</b>	1.45%	1.4%	0.18	0.50
<b>Sugar</b>	57.6%	45.0%	0.00	58.0
<b>HEC</b>	0.4%	1.0%	0.00	0.50
<b>Preventol</b>	0.1%	0.1%	0.00	0.50
<b>DGBE</b>	0.0%	0.0%	44.92	0.00

#### 3.2 Tissue Calibration Result

The dielectric parameters of the liquids were verified prior to the SAR evaluation using APREL Dielectric Probe Kit and Anritsu MS4623B Vector Network Analyzer

<b>Head Tissue Simulant Measurement</b>				
Frequency [MHz]	Description	Dielectric Parameters		Tissue Temp. [°C]
		$\epsilon_r$	$\sigma$ [s/m]	
835 MHz	Reference result ± 5% window	41.5 39.425 to 43.573	0.9 0.855 to 0.945	N/A
	24-Jan-06	40.62	0.924	20.8
824 MHz	Low channel	40.73	0.922	20.8
836 MHz	Mid channel	40.6	0.924	20.8
848 MHz	High channel	40.41	0.927	20.8

Body Tissue Simulant Measurement				
Frequency [MHz]	Description	Dielectric Parameters		Tissue Temp. [°C]
		$\epsilon_r$	$\sigma$ [s/m]	
835 MHz	Reference result ± 5% window	55.2 52.44 to 57.96	0.97 0.9215 to 1.0185	N/A
	24-Jan-06	53.54	0.993	20.8
824 MHz	Low channel	53.64	1.001	20.8
836 MHz	Mid channel	53.52	0.993	20.8
848 MHz	High channel	53.33	0.996	20.8

Head Tissue Simulant Measurement				
Frequency [MHz]	Description	Dielectric Parameters		Tissue Temp. [°C]
		$\epsilon_r$	$\sigma$ [s/m]	
1900 MHz	Reference result ± 5% window	40.0 38 to 42	1.4 1.33 to 1.47	N/A
	25-Jan-06	38.46	1.431	20.8
1850 MHz	Low channel	38.78	1.457	20.8
1880 MHz	Mid channel	38.56	1.438	20.8
1910 MHz	High channel	38.42	1.427	20.8

Body Tissue Simulant Measurement				
Frequency [MHz]	Description	Dielectric Parameters		Tissue Temp. [°C]
		$\epsilon_r$	$\sigma$ [s/m]	
1900 MHz	Reference result ± 5% window	53.3 50.635 to 55.965	1.52 1.444 to 1.596	N/A
	25-Jan-06	51.78	1.567	20.8
1850 MHz	Low channel	52.04	1.543	20.8
1880 MHz	Mid channel	51.84	1.557	20.8
1910 MHz	High channel	51.72	1.565	20.8

**3.3 Tissue Dielectric Parameters for Head and Body Phantoms**

The head tissue dielectric parameters recommended by the IEEE SCC-34/SC-2 in P1528 have been incorporated in the following table. These head parameters are derived from planar layer models simulating the highest expected SAR for the dielectric properties and tissue thickness variations in a human head. Other head and body tissue parameters that have not been specified in P1528 are derived from the tissue dielectric parameters computed from the 4-Cole-Cole equations described in Reference [12] and extrapolated according to the head parameters specified in P1528.

Target Frequency (MHz)	Head		Body	
	$\epsilon_r$	$\sigma$ (S/m)	$\epsilon_r$	$\sigma$ (S/m)
150	52.3	0.76	61.9	0.80
300	45.3	0.87	58.2	0.92
450	43.5	0.87	56.7	0.94
835	41.5	0.90	55.2	0.97
900	41.5	0.97	55.0	1.05
915	41.5	0.98	55.0	1.06
1450	40.5	1.20	54.0	1.30
1610	40.3	1.29	53.8	1.40
1800 – 2000	40.0	1.40	53.3	1.52
2450	39.2	1.80	52.7	1.95
3000	38.5	2.40	52.0	2.73
5800	35.3	5.27	48.2	6.00

( $\epsilon_r$  = relative permittivity,  $\sigma$  = conductivity and  $\rho = 1000 \text{ kg/m}^3$ )

## 4. SAR Measurement Procedure

### 4.1 SAR System Validation

#### 4.1.1 Validation Dipoles

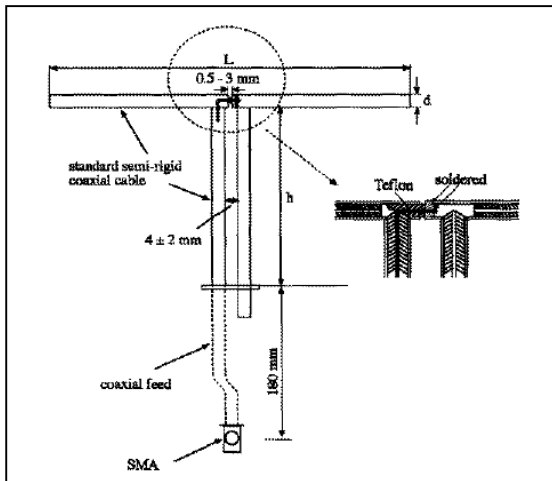

The dipoles used is based on the IEEE-1528 standard, and is complied with mechanical and electrical specifications in line with the requirements of both IEEE and FCC Supplement C. the table below provides details for the mechanical and electrical specifications for the dipoles.

Frequency	L (mm)	h (mm)	d (mm)
835MHz	161.0	89.8	3.6
1900MHz	68.0	39.5	3.6

#### 4.1.2 Validation Result

System Performance Check at 835MHz				
Validation Kit: ASL-D-835-S-2				
Frequency [MHz]	Description	SAR [w/kg] 1g	SAR [w/kg] 10g	Tissue Temp. [°C]
835 MHz	Reference result ± 5% window	9.5 9.025 to 9.975	6.2 5.89 to 6.51	N/A
	24-Jan-06	9.668	6.116	20.8
Note: All SAR values are normalized to 1W forward power.				
System Performance Check at 1900MHz				
Validation Kit: ASL-D-1900-S-2				
Frequency [MHz]	Description	SAR [w/kg] 1g	SAR [w/kg] 10g	Tissue Temp. [°C]
1900 MHz	Reference result ± 5% window	39.7 37.715 to 41.685	20.5 19.475 to 21.525	N/A
	25-Jan-06	40.448	20.384	20.8
Note: All SAR values are normalized to 1W forward power.				



## 4.2 Arrangement Assessment Setup

### 4.2.1 Test Positions of Device Relative to Head

This specifies exactly two test positions for the handset against the head phantom, the “cheek” position and the “tilted” position. The handset should be tested in both positions on the left and right sides of the SAM phantom. If the handset construction is such that it cannot be positioned using the handset positioning procedures described in 4.2.2.1 and 4.2.2.2 to represent normal use conditions (e.g., asymmetric handset), alternative alignment procedures should be considered with details provided in the test report.

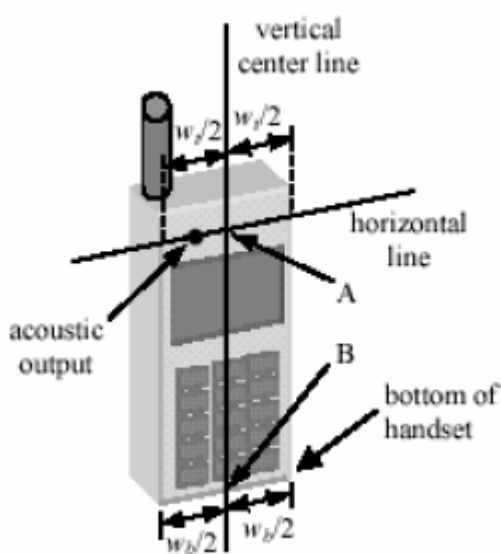

Figure 4.1a Fixed Case

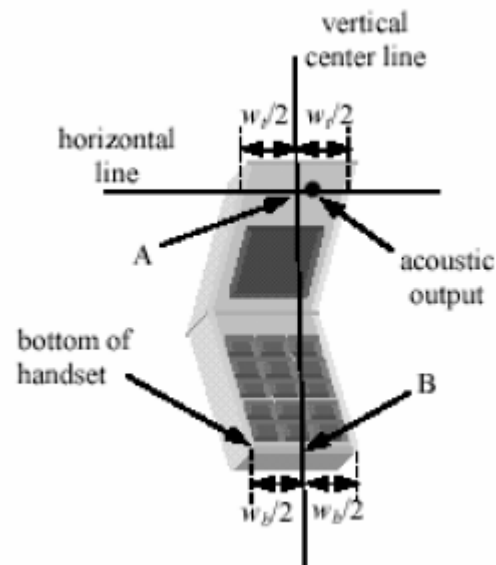

Figure 4.1b Clam Shell

#### 4.2.1.1 Definition of the “Cheek” Position

The “cheek” position is defined as follows:

- a. Ready the handset for talk operation, if necessary. For example, for handsets with a cover piece, open the cover. (If the handset can also be used with the cover closed both configurations must be tested.)
- b. Define two imaginary lines on the handset: the vertical centerline and the horizontal line. The vertical centerline passes through two points on the front side of the handset: the midpoint of the width  $w_t$  of the handset at the level of the acoustic output (point A on Figures 4.1a and 4.1b), and the midpoint of the width  $w_b$  of the bottom of the handset (point B). The horizontal line is perpendicular to the vertical centerline and passes through the center of the acoustic output (see Figure 4.1a). The two lines intersect at point A. Note that for many handsets, point A coincides with the center of the acoustic output. However, the acoustic output may be located elsewhere on the horizontal line. Also note that the vertical centerline is not necessarily parallel to the front face of the

- handset (see Figure 4.1b), especially for clamshell handsets, handsets with flip pieces, and other irregularly-shaped handsets.
- c. Position the handset close to the surface of the phantom such that point A is on the (virtual) extension of the line passing through points RE and LE on the phantom (see Figure 4.2), such that the plane defined by the vertical center line and the horizontal line of the handset is approximately parallel to the sagittal plane of the phantom.
  - d. Translate the handset towards the phantom along the line passing through RE and LE until the handset touches the pinna.
  - e. While maintaining the handset in this plane, rotate it around the LE-RE line until the vertical centerline is in the plane normal to MB-NF including the line MB (called the reference plane).
  - f. Rotate the handset around the vertical centerline until the handset (horizontal line) is symmetrical with respect to the line NF.
  - g. While maintaining the vertical centerline in the reference plane, keeping point A on the line passing through RE and LE and maintaining the handset contact with the pinna, rotate the handset about the line NF until any point on the handset is in contact with a phantom point below the pinna (cheek). See Figure 4.2 the physical angles of rotation should be noted.

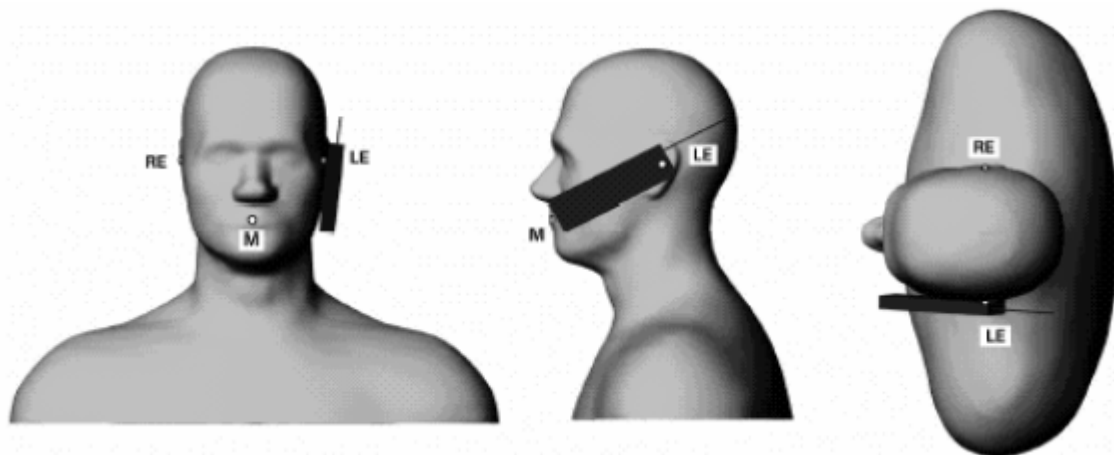

Figure 4.2 – Phone position 1, “cheek” or “touch” position.

**4.2.1.2 Definition of the “Tilted” Position**

The “tilted” position is defined as follows:

- a. Repeat steps (a) – (g) of 4.2.1.1 to place the device in the “cheek position.”
- b. While maintaining the orientation of the handset move the handset away from the pinna along the line passing through RE and LE in order to enable a rotation of the handset by 15 degrees.
- c. Rotate the handset around the horizontal line by 15 degrees.

d. While maintaining the orientation of the handset, move the handset towards the phantom on a line passing through RE and LE until any part of the handset touches the ear. The tilted position is obtained when the contact is on the pinna. If the contact is at any location other than the pinna (e.g., the antenna with the back of the phantom head), the angle of the handset should be reduced. In this case, the tilted position is obtained if any part of the handset is in contact with the pinna as well as a second part of the handset is contact with the phantom (e.g., the antenna with the back of the head).

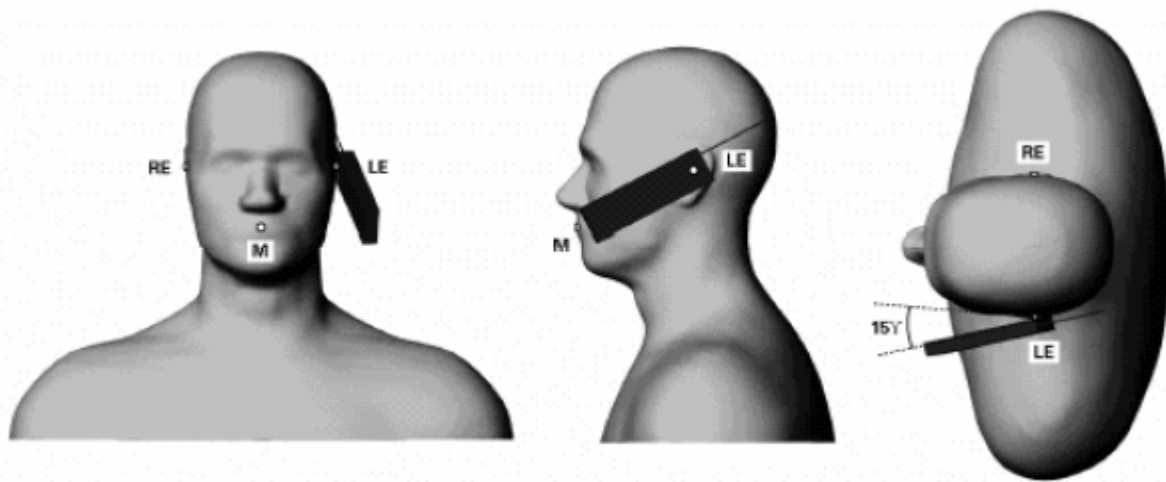

Figure 4.3 – Phone position 2, “tilted” position.

**4.2.2 Test Positions for body-worn**

Body-worn operating configurations should be tested with the belt-clips and holsters attached to the device and positioned against a flat phantom in normal use configurations. A separation distance of 1.5 cm between the back of the device and a flat phantom is recommended for testing body-worn SAR compliance under such circumstances. Other separation distance may be use, but not exceed 2.5 cm.

**4.3 SAR Measurement Procedure**

The ALSAS-10U calculates SAR using the following equation,

$$SAR = \frac{\sigma |E|^2}{\rho}$$

$\sigma$ : represents the simulated tissue conductivity

$\rho$ : represents the tissue density

The EUT is set to transmit at the required power in line with product specification, at each frequency relating to the LOW, MID, and HIGH channel settings.

Pre-scans are made on the device to establish the location for the transmitting antenna, using a large area scan in either air or tissue simulation fluid.

The EUT is placed against the Universal Phantom where the maximum area scan dimensions are larger than the physical size of the resonating antenna. When the scan size is not large enough to cover the peak SAR distribution, it is modified by either extending the area scan size in both the X and Y directions, or the device is shifted within the predefined area.

The area scan is then run to establish the peak SAR location (interpolated resolution set at  $1\text{mm}^2$ ) which is then used to orient the center of the zoom scan. The zoom scan is then executed and the 1g and 10g averages are derived from the zoom scan volume (interpolated resolution set at  $1\text{mm}^3$ ).

**5. SAR Exposure Limits**

SAR assessments have been made in line with the requirements of IEEE-1528, FCC Supplement C, and comply with ANSI/IEEE C95.1-1992 “Uncontrolled Environments” limits. These limits apply to a location which is deemed as “Uncontrolled Environment” which can be described as a situation where the general public may be exposed to an RF source with no prior knowledge or control over their exposure.

**Limits for General Population/Uncontrolled Exposure (W/kg)**

<b>Type Exposure</b>	<b>Uncontrolled Environment Limit</b>
Spatial Peak SAR (1g cube tissue for brain or body)	<b>1.60 W/kg</b>
Spatial Average SAR (whole body)	<b>0.08 W/kg</b>
Spatial Peak SAR (10g for hands, feet, ankles and wrist)	<b>4.00 W/kg</b>

## 6. Test Equipment List

Instrument	Manufacturer	Model No.	Serial No.	Last Calibration
Data Acquisition Package	Aprél	ALS-DAQ-PAQ-2	QTK-337	Nov. 2005
Aprél Laboratories Probe	Aprél	ALS-E020	264	Mar. 2005
Aprél Laboratories Probe	Aprél	ALS-E020	265	Mar. 2005
Aprél Reference Dipole 900Mhz	Aprél	ALS-D-835-S-2	QTK-315	Jun. 2005
Aprél Reference Dipole 1800Mhz	Aprél	ALS-D-1900-S-2	QTK-318	Jun. 2005
Boundary Detection Sensor System	Aprél	ALS-PMDPS-2	QTK-336	N/A
Dielectric Probe Kit	Aprél	ALS-PR-DIEL	QTK-296	N/A
Universal Work Station	Aprél	ALS-UWS	QTK-326	N/A
Device Holder 2.0	Aprél	ALS-H-E-SET-2	QTK-294	N/A
Left Ear SAM Phantom	Aprél	ALS-P-SAM-L	QTK-292	N/A
Right Ear SAM Phantom	Aprél	ALS-P-SAM-R	QTK-288	N/A
Universal Phantom	Aprél	ALS-P-UP-1	QTK-246	N/A
Aprél Dipole Spacer	Aprél	ALS-DS-U	QTK-295	N/A
SAR Software	Aprél	ALSAS-10	Ver. 2.1.0	N/A
CRS C500C Controller	Thermo	ALS-C500	RCF0404433	N/A
CRF F3 Robot	Thermo	ALS-F3	RAF0412222	N/A
Power Amplifier	Mini-Circuit	ZHL-42	D051404-20	N/A
Directional Coupler	Agilent	778D-012	50550	N/A
Universal Radio Communication Tester	Rohde & Schwarz	CMU 200	104846	Mar. 2005
Radio Communication Analyzer	Anritsu	MT8820A	6200323183	Jun. 2005
Vector Network	Anritsu	MS4623B	992801	Mar 2005
Signal Generator	Anritsu	MG3692A	042319	Jun. 2005
Power Meter	Anritsu	ML2487A	6K00001447	Jan. 2006
Wide Bandwidth Sensor	Anritsu	MA2491	030677	Jan. 2006

7. Measurement Uncertainty

Exposure Assessment Measurement Uncertainty

Source of Uncertainty	Tolerance Value	Probability Distribution	Divisor	$c_i^+$ (1-g)	$c_i^-$ (10-g)	Standard Uncertainty (1-g) %	Standard Uncertainty (10-g) %
Measurement System							
Probe Calibration	3.5	normal	1	1	1	3.5	3.5
Axial Isotropy	3.7	rectangular	$\sqrt{3}$	$(1-cp)^{1/2}$	$(1-cp)^{1/2}$	1.5	1.5
Hemispherical Isotropy	10.9	rectangular	$\sqrt{3}$	$\sqrt{cp}$	$\sqrt{cp}$	4.4	4.4
Boundary Effect	1.0	rectangular	$\sqrt{3}$	1	1	0.6	0.6
Linearity	4.7	rectangular	$\sqrt{3}$	1	1	2.7	2.7
Detection Limit	1.0	rectangular	$\sqrt{3}$	1	1	0.6	0.6
Readout Electronics	1.0	normal	1	1	1	1.0	1.0
Response Time	0.8	rectangular	$\sqrt{3}$	1	1	0.5	0.5
Integration Time	1.7	rectangular	$\sqrt{3}$	1	1	1.0	1.0
RF Ambient Condition	3.0	rectangular	$\sqrt{3}$	1	1	1.7	1.7
Probe Positioner Mech.	0.4	rectangular	$\sqrt{3}$	1	1	0.2	0.2
Restriction							
Probe Positioning with respect to Phantom Shell	2.9	rectangular	$\sqrt{3}$	1	1	1.7	1.7
Extrapolation and Integration	3.7	rectangular	$\sqrt{3}$	1	1	2.1	2.1
Test Sample Positioning	4.0	normal	1	1	1	4.0	4.0
Device Holder Uncertainty	2.0	normal	1	1	1	2.0	2.0
Drift of Output Power	4.7	rectangular	$\sqrt{3}$	1	1	2.7	2.7
Phantom and Setup							
Phantom Uncertainty(shape & thickness tolerance)	3.4	rectangular	$\sqrt{3}$	1	1	2.0	2.0
Liquid Conductivity(target)	5.0	rectangular	$\sqrt{3}$	0.7	0.5	2.0	1.4
Liquid Conductivity(meas.)	0.1	normal	1	0.7	0.5	0.1	0.0
Liquid Permittivity(target)	2.0	rectangular	$\sqrt{3}$	0.6	0.5	0.7	0.6
Liquid Permittivity(meas.)	2.6	normal	1	0.6	0.5	1.6	1.3
Combined Uncertainty		RSS				9.6	9.5
Combined Uncertainty (coverage factor=2)		Normal (k=2)				19.3	18.9

8. Test Results

8.1 SAR Test Results Summary

SAR MEASUREMENT						
Ambient Temperature (°C) : 21.2 ±2				Relative Humidity (%): 57		
Liquid Temperature (°C) : 20.8 ±2				Depth of Liquid (cm):>15		
Product: GSM850/DCS1800 / PCS1900 GSM/GPRS Mobile Phone						
Test Mode:GSM 850						
Test Position Head	Antenna Position	Frequency		Conducted Power (dBm)	SAR 1g (W/kg)	Limit (W/kg)
		Channel	MHz			
Right-Cheek	Internal	128	824.2	32.4	<b>0.987</b>	1.6
Right-Cheek	Internal	189	836.4	32.5	0.835	1.6
Right-Cheek	Internal	251	848.8	32.4	0.767	1.6
Left-Cheek	Internal	128	824.2	32.4	0.862	1.6
Left-Cheek	Internal	189	836.4	32.5	0.681	1.6
Left-Cheek	Internal	251	848.8	32.4	0.633	1.6
Right-Tilted	Internal	128	824.2	32.4	**	1.6
Right-Tilted	Internal	189	836.4	32.5	0.176	1.6
Right-Tilted	Internal	251	848.8	32.4	**	1.6
Left-Tilted	Internal	128	824.2	32.4	**	1.6
Left-Tilted	Internal	189	836.4	32.5	0.141	1.6
Left-Tilted	Internal	251	848.8	32.4	**	1.6
Test Mode: GSM 850 with Bluetooth						
Right-Cheek	Internal	128	824.2	32.4	0.976	1.6
Note: The EUT test position is touch & tilted 15 degrees. The SAR measured at the middle channel for this configuration is at least 3 dB lower than SAR limit, testing at the high and low channels is option.						



<b>SAR MEASUREMENT</b>						
Ambient Temperature (°C) :21.2 ±2				Relative Humidity (%): 57		
Liquid Temperature (°C) : 20.8 ±2				Depth of Liquid (cm):>15		
Product: GSM850/DCS1800 / PCS1900 GSM/GPRS Mobile Phone						
Test Mode:GSM850						
Test Position Body	Antenna Position	Frequency		Conducted Power (dBm)	SAR 1g (W/kg)	Limit (W/kg)
		Channel	MHz			
Body-wore	Internal	128	824.2	32.4	<b>0.734</b>	1.6
Body-wore	Internal	189	836.4	32.5	0.554	1.6
Body-wore	Internal	251	848.8	32.4	0.446	1.6
Test Mode: GSM850 with Bluetooth						
Body-wore	Internal	128	824.2	32.4	0.662	1.6
Test Mode: GSM 850 GPRS						
Body-wore	Internal	128	824.2	32.3	0.618	1.6
Body-wore	Internal	189	836.4	32.4	0.538	1.6
Body-wore	Internal	251	848.8	32.3	0.415	1.6
<p>Note: A separation distance of 1.5cm between the back of the device and a flat phantom for test.</p> <p>The SAR measured at the middle channel for this configuration is at least 3 dB lower than SAR limit, testing at the high and low channels is option.</p>						

SAR MEASUREMENT						
Ambient Temperature (°C) : 21.2 ±2			Relative Humidity (%): 57			
Liquid Temperature (°C) : 20.8 ±2			Depth of Liquid (cm):>15			
Product: GSM850/DCS1800 / PCS1900 GSM/GPRS Mobile Phone						
Test Mode: PCS1900						
Test Position Head	Antenna Position	Frequency		Conducted Power (dBm)	SAR 1g (W/kg)	Limit (W/kg)
		Channel	MHz			
Right-Cheek	Internal	512	1850.2	29.5	0.24	1.6
Right-Cheek	Internal	661	1880.0	29.6	0.238	1.6
Right-Cheek	Internal	810	1909.8	29.5	0.241	1.6
Left-Cheek	Internal	512	1850.2	29.5	0.266	1.6
Left-Cheek	Internal	661	1880.0	29.6	0.318	1.6
Left-Cheek	Internal	810	1909.8	29.5	<b>0.362</b>	1.6
Right-Tilted	Internal	512	1850.2	29.5	**	1.6
Right-Tilted	Internal	661	1880.0	29.6	0.172	1.6
Right-Tilted	Internal	810	1909.8	29.5	**	1.6
Left-Tilted	Internal	512	1850.2	29.5	**	1.6
Left-Tilted	Internal	661	1880.0	29.6	0.183	1.6
Left-Tilted	Internal	810	1909.8	29.5	**	1.6
Test Mode: PCS1900 with Bluetooth						
Left-Cheek	Internal	810	1909.8	29.5	0.311	1.6
Note: The EUT test position is touch & tilted 15 degrees. The SAR measured at the middle channel for this configuration is at least 3 dB lower than SAR limit, testing at the high and low channels is option.						

SAR MEASUREMENT						
Ambient Temperature (°C) :21.2 ±2			Relative Humidity (%): 57			
Liquid Temperature (°C) : 20.8 ±2			Depth of Liquid (cm):>15			
Product: GSM850/DCS1800 / PCS1900 GSM/GPRS Mobile Phone						
Test Mode: PCS1900						
Test Position Body	Antenna Position	Frequency		Conducted Power (dBm)	SAR 1g (W/kg)	Limit (W/kg)
		Channel	MHz			
Body-wore	Internal	512	1850.2	29.5	<b>0.43</b>	1.6
Body-wore	Internal	661	1880.0	29.6	0.403	1.6
Body-wore	Internal	810	1909.8	29.5	0.406	1.6
Test Mode: PCS1900 with Bluetooth						
Body-wore	Internal	512	1850.2	29.5	0.397	1.6
Test Mode: PCS1900 GPRS						
Body-wore	Internal	512	1850.2	29.7	0.392	1.6
Body-wore	Internal	661	1880.0	29.6	0.383	1.6
Body-wore	Internal	810	1909.8	29.8	0.353	1.6
<p>Note: A separation distance of 1.5cm between the back of the device and a flat phantom for test.</p> <p>The SAR measured at the middle channel for this configuration is at least 3 dB lower than SAR limit, testing at the high and low channels is option.</p>						

**Appendix A. SAR System Validation Data**

**Appendix B. SAR measurement Data**

**Appendix C. Test Setup Photographs & EUT Photographs**

**Appendix D. Probe Calibration Data**

**Appendix E. Dipole Calibration Data**

**SAR System Validation Data**

ALSAS-10U VER 2.2.0 APREL Laboratories

**SAR Test Report**Validation Date : 24-Jan-2006  
Measurement Date : 24-Jan-2006**Product Data**Device Name : Dipole-835  
Type : Dipole  
Frequency : 835.00 MHz  
Max. Transmit Pwr : 0.25 W  
Drift Time : 0 min(s)  
Length : 161 mm  
Width : 3.6 mm  
Depth : 89.8 mm  
Power Drift-Start : 2.104 W/kg  
Power Drift-Finish: 2.163 W/kg  
Power Drift (%) : 2.799**Phantom Data**Name : APREL-Uni  
Type : Uni-Phantom  
Size (mm) : 280 x 280 x 200  
Location : Center**Tissue Data**Type : HEAD  
Serial No. : 322-H  
Frequency : 835.00 MHz  
Last Calib. Date : 24-Jan-2006  
Temperature : 20.80 °C  
Ambient Temp. : 21.20 °C  
Humidity : 57.00 RH%  
Epsilon : 40.62 F/m  
Sigma : 0.924 S/m  
Density : 1000.00 kg/cu. m**Probe Data**Name : Probe 265  
Model : E020  
Type : E-Field Triangle  
Serial No. : 265  
Last Calib. Date : 23-Mar-2005  
Frequency : 835.00 MHz  
Duty Cycle Factor: 1  
Conversion Factor: 6.2  
Probe Sensitivity: 1.20 1.20 1.20  $\mu\text{V}/(\text{V}/\text{m})^2$   
Compression Point: 95.00 mV  
Offset : 1.56 mm

Measurement Data

Crest Factor : 1  
Tissue Temp. : 20.80 °C  
Ambient Temp. : 21.20 °C  
Area Scan : 5x5x1 : Measurement x=12mm, y=12mm, z=4mm  
Zoom Scan : 7x7x7 : Measurement x=5mm, y=5mm, z=5mm  
Frequency : 835

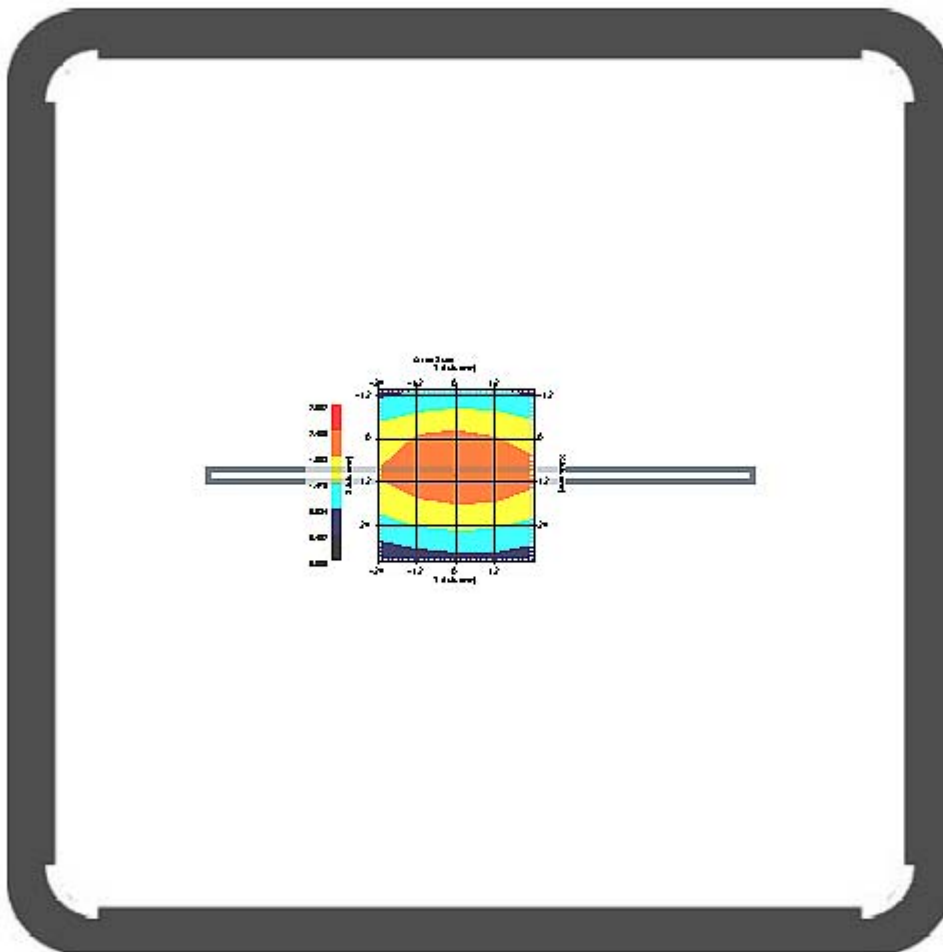

1 gram SAR value : 2.417 W/kg  
10 gram SAR value : 1.579 W/kg  
Area Scan Peak SAR : 2.461 W/kg  
Zoom Scan Peak SAR : 3.523 W/kg

SAR-Z Axis  
at Hotspot x:10.00 y:-2.00

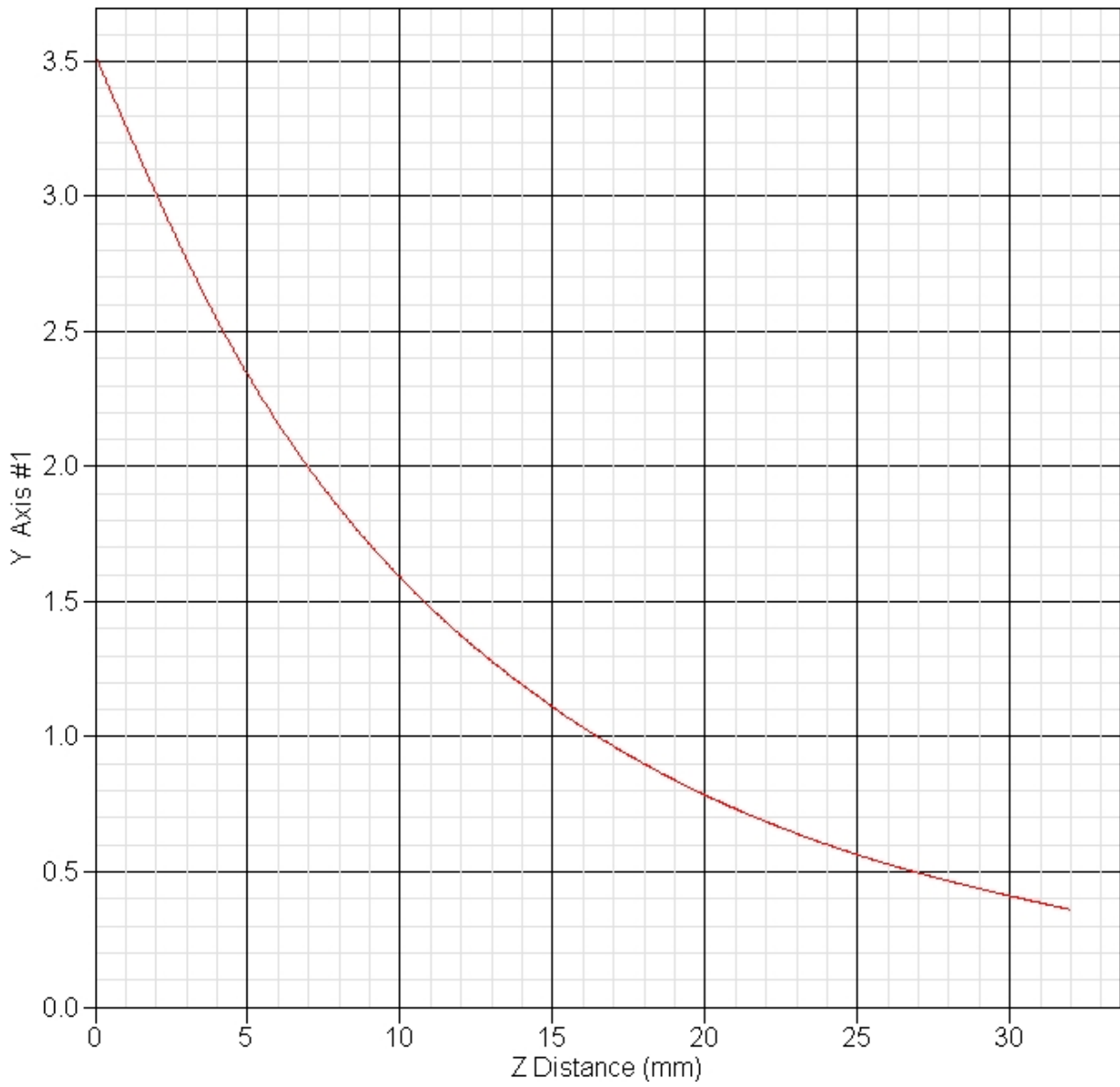

## ALSAS-10U VER 2.2.0 APREL Laboratories

## SAR Test Report

Validation Date : 25-Jan-2006  
Measurement Date : 25-Jan-2006

## Product Data

Device Name : Dipole-1900  
Type : Dipole  
Frequency : 1900.00 MHz  
Max. Transmit Pwr : 0.25 W  
Drift Time : 0 min(s)  
Length : 68 mm  
Width : 3.6 mm  
Depth : 39.5 mm  
Power Drift-Start : 7.796 W/kg  
Power Drift-Finish: 7.549 W/kg  
Power Drift (%) : -3.178

## Phantom Data

Name : APREL-Uni  
Type : Uni-Phantom  
Size (mm) : 280 x 280 x 200  
Location : Center

## Tissue Data

Type : HEAD  
Serial No. : 324-H  
Frequency : 1900.00 MHz  
Last Calib. Date : 25-Jan-2006  
Temperature : 20.80 °C  
Ambient Temp. : 21.20 °C  
Humidity : 57.00 RH%  
Epsilon : 38.46 F/m  
Sigma : 1.431 S/m  
Density : 1000.00 kg/cu. m

## Probe Data

Name : Probe 265  
Model : E020  
Type : E-Field Triangle  
Serial No. : 265  
Last Calib. Date : 23-Mar-2005  
Frequency : 1900.00 MHz  
Duty Cycle Factor: 1  
Conversion Factor: 4.9  
Probe Sensitivity: 1.20 1.20 1.20  $\mu\text{V}/(\text{V}/\text{m})^2$   
Compression Point: 95.00 mV  
Offset : 1.56 mm



Measurement Data

Crest Factor : 1  
Tissue Temp. : 20.80 °C  
Ambient Temp. : 21.20 °C  
Area Scan : 5x5x1 : Measurement x=12mm, y=12mm, z=4mm  
Zoom Scan : 7x7x7 : Measurement x=5mm, y=5mm, z=5mm  
Frequency : 1900

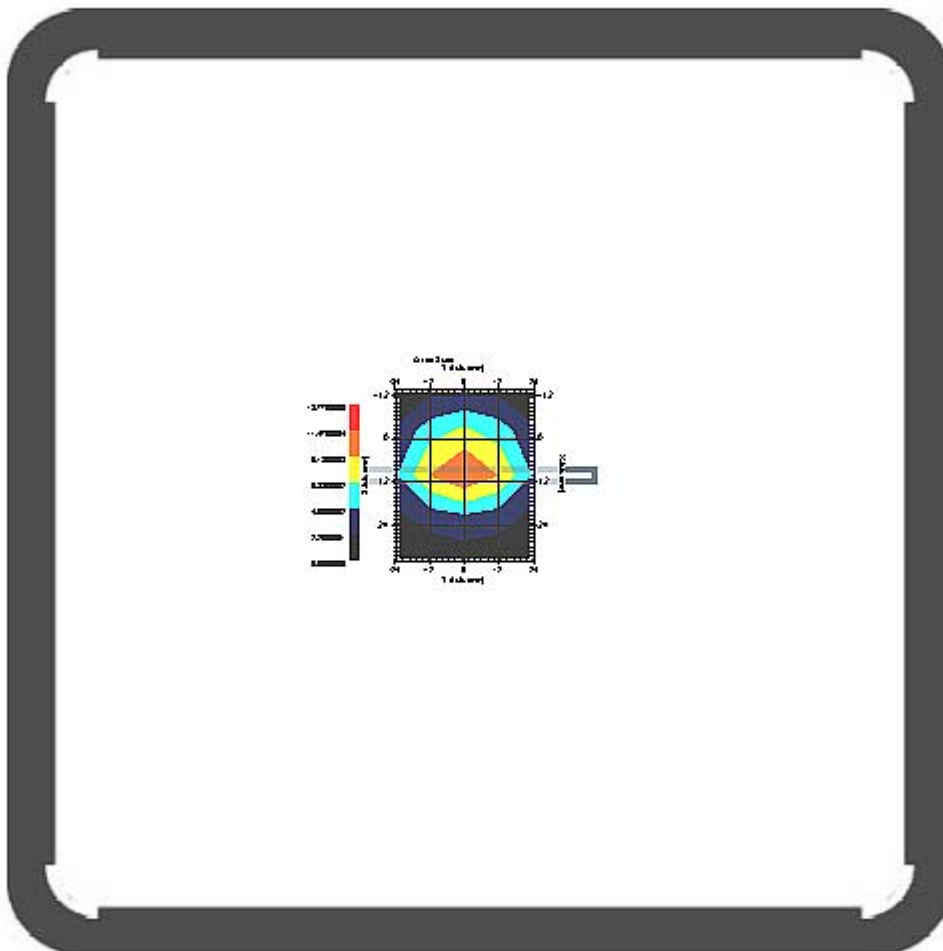

1 gram SAR value : 10.112 W/kg  
10 gram SAR value : 5.096 W/kg  
Area Scan Peak SAR : 11.477 W/kg  
Zoom Scan Peak SAR : 18.916 W/kg

SAR-Z Axis  
at Hotspot x:10.10 y:-2.00

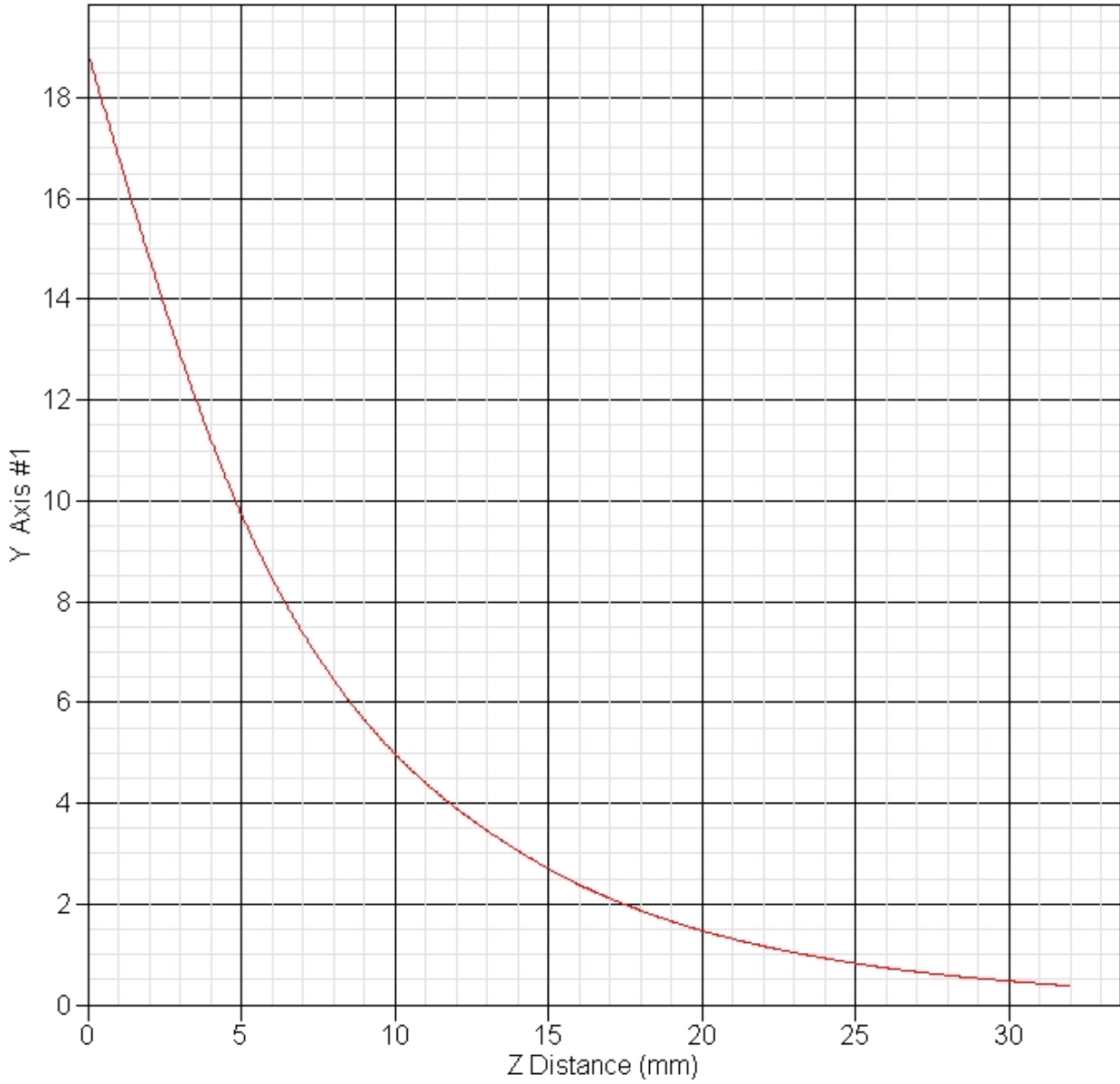

**SAR Measurement Data**

ALSAS-10U VER 2.2.0 APREL Laboratories

## SAR Test Report

Validation Date : 24-Jan-2006  
Measurement Date : 24-Jan-2006

## Product Data

Device Name : Benq  
Type : Clamshell Cell Phone  
Model : HERC3A(M580a)  
Frequency : 850.00 MHz  
Max. Transmit Pwr : 2 W  
Drift Time : 0 min(s)  
Length : 162.4 mm  
Width : 44.2 mm  
Depth : 12.5 mm  
Antenna Type : Internal

## Phantom Data

Type : SAM-Right  
Size (mm) : 280 x 280 x 280  
Location : Right

## Tissue Data

Type : HEAD  
Serial No. : 322-H  
Frequency : 835.00 MHz  
Last Calib. Date : 24-Jan-2006  
Temperature : 20.80 °C  
Ambient Temp. : 21.20 °C  
Humidity : 57.00 RH%  
Epsilon : 40.62 F/m  
Sigma : 0.924 S/m  
Density : 1000.00 kg/cu. m

## Probe Data

Name : Probe 265  
Model : E020  
Type : E-Field Triangle  
Serial No. : 265  
Last Calib. Date : 23-Mar-2005  
Frequency : 835.00 MHz  
Duty Cycle Factor: 8  
Conversion Factor: 6.2  
Probe Sensitivity: 1.20 1.20 1.20  $\mu\text{V}/(\text{V}/\text{m})^2$   
Compression Point: 95.00 mV  
Offset : 1.56 mm

Measurement Data

Crest Factor : 8  
Tissue Temp. : 20.80 °C  
Ambient Temp. : 21.20 °C  
Area Scan : 7x6x1 : Measurement x=12mm, y=12mm, z=4mm  
Zoom Scan : 7x7x7 : Measurement x=5mm, y=5mm, z=5mm  
Power Drift-Start : 0.044 W/kg  
Power Drift-Finish: 0.044 W/kg  
Power Drift (%) : 0.826

DUT Position : Touch  
Channel : 128

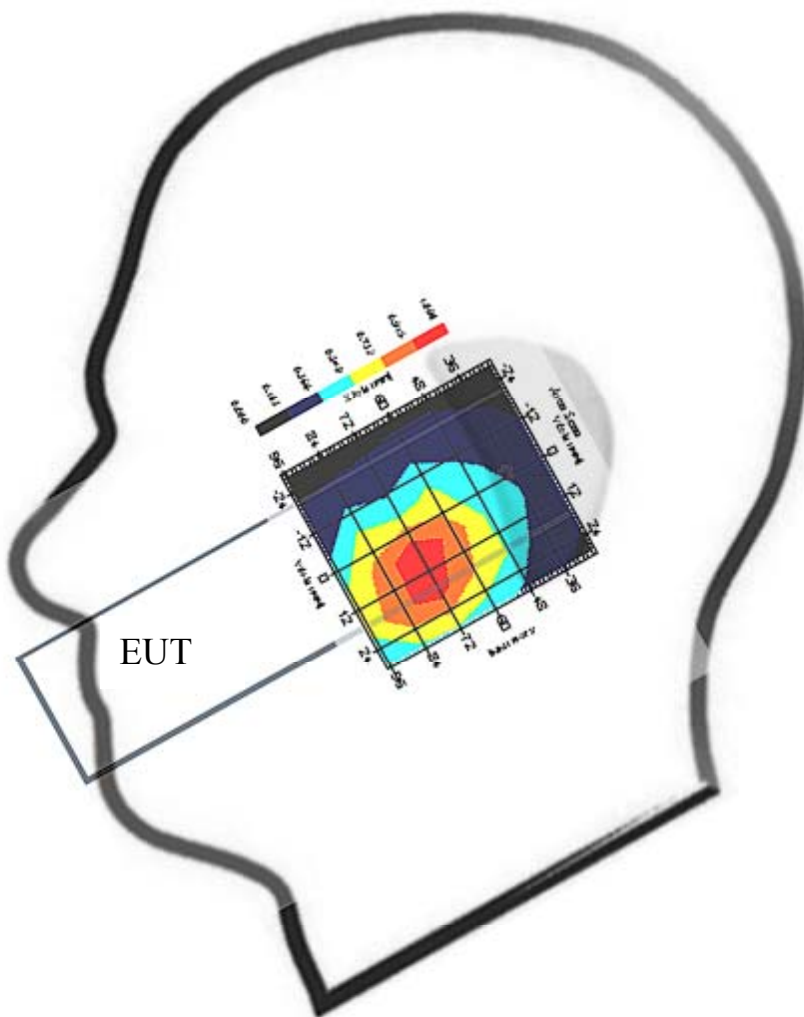

1 gram SAR value : 0.987 W/kg  
10 gram SAR value : 0.632 W/kg  
Area Scan Peak SAR : 1.095 W/kg  
Zoom Scan Peak SAR : 1.611 W/kg

This is previous page plot (zoom in)

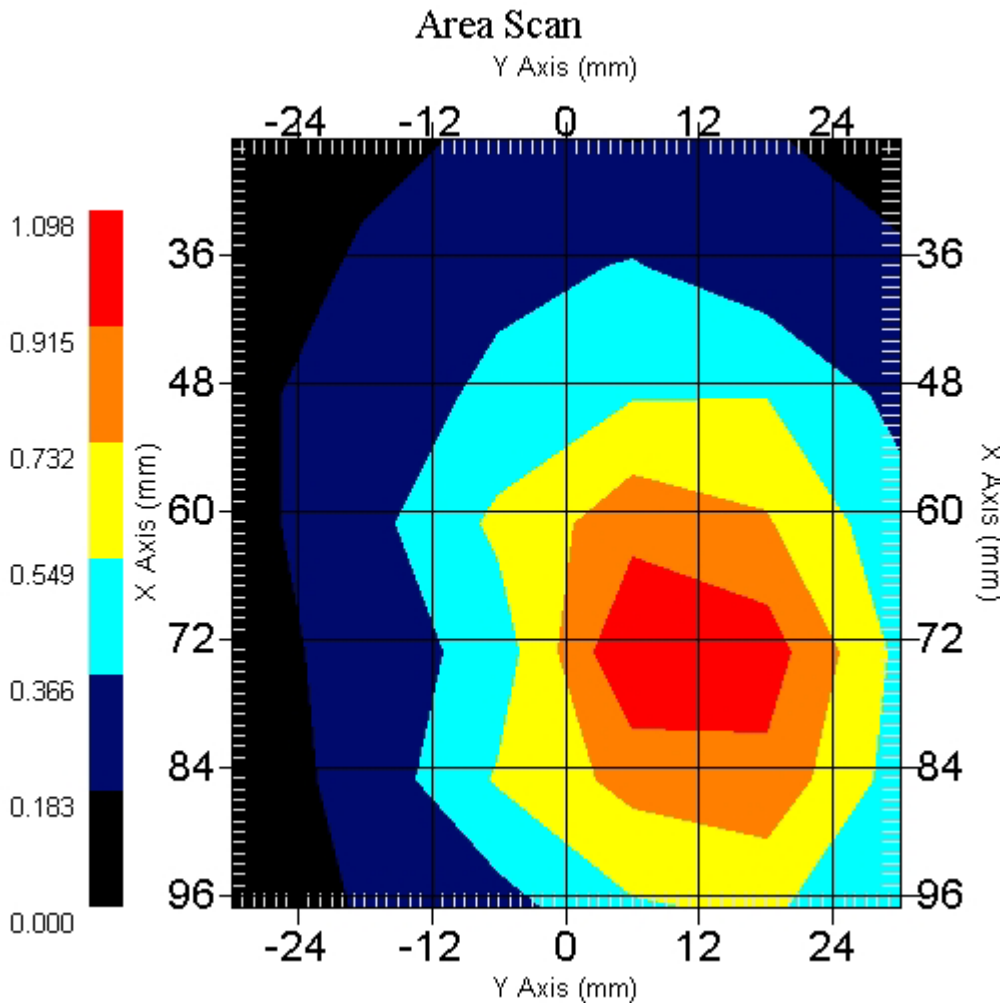

Measurement Data

Crest Factor : 8  
Tissue Temp. : 20.80 °C  
Ambient Temp. : 21.20 °C  
Area Scan : 7x6x1 : Measurement x=12mm, y=12mm, z=4mm  
Zoom Scan : 7x7x7 : Measurement x=5mm, y=5mm, z=5mm  
Power Drift-Start : 0.042 W/kg  
Power Drift-Finish: 0.042 W/kg  
Power Drift (%) : -0.866

DUT Position : Touch  
Channel : 189

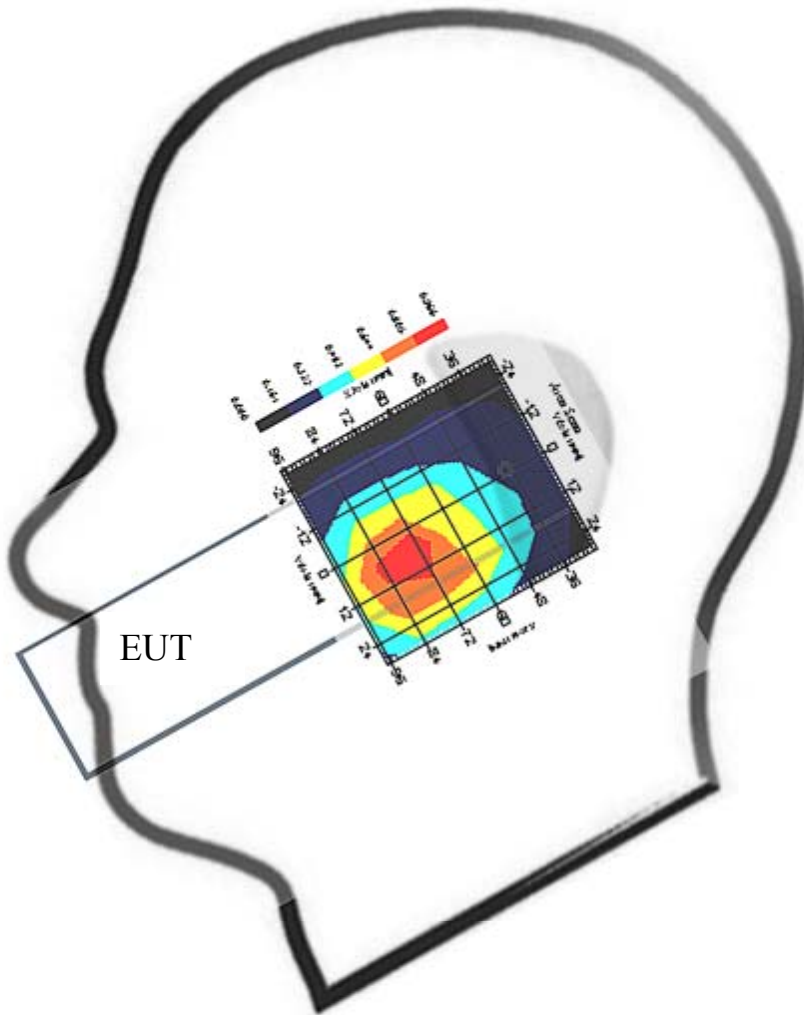

1 gram SAR value : 0.835 W/kg  
10 gram SAR value : 0.536 W/kg  
Area Scan Peak SAR : 0.964 W/kg  
Zoom Scan Peak SAR : 1.371 W/kg

This is previous page plot (zoom in)

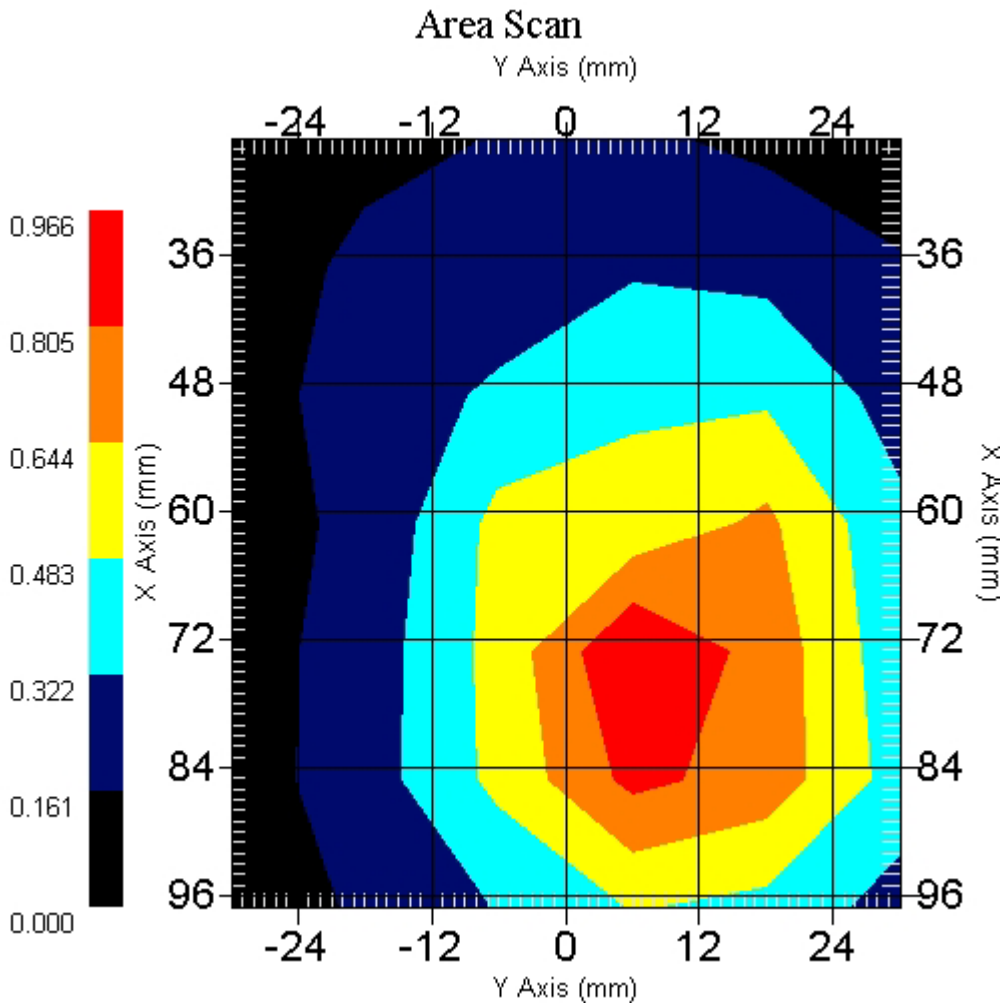

Measurement Data

Crest Factor : 8  
Tissue Temp. : 20.80 °C  
Ambient Temp. : 21.20 °C  
Area Scan : 7x6x1 : Measurement x=12mm, y=12mm, z=4mm  
Zoom Scan : 7x7x7 : Measurement x=5mm, y=5mm, z=5mm  
Power Drift-Start : 0.036 W/kg  
Power Drift-Finish: 0.036 W/kg  
Power Drift (%) : 1.054

DUT Position : Touch  
Channel : 251

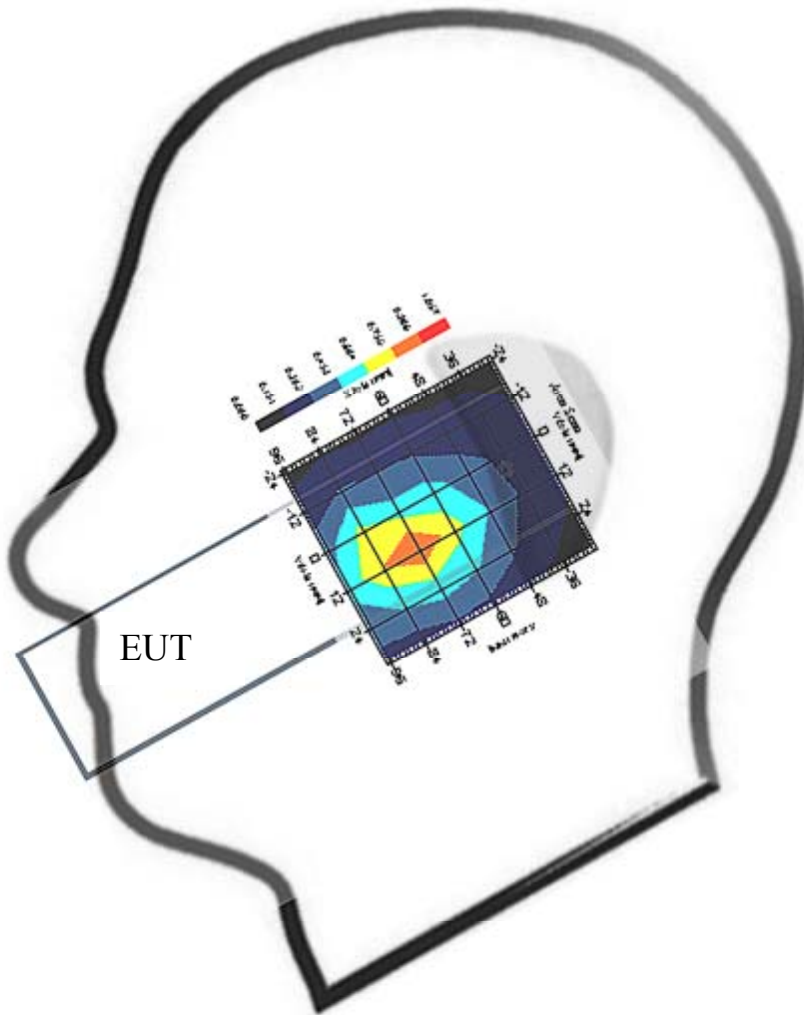



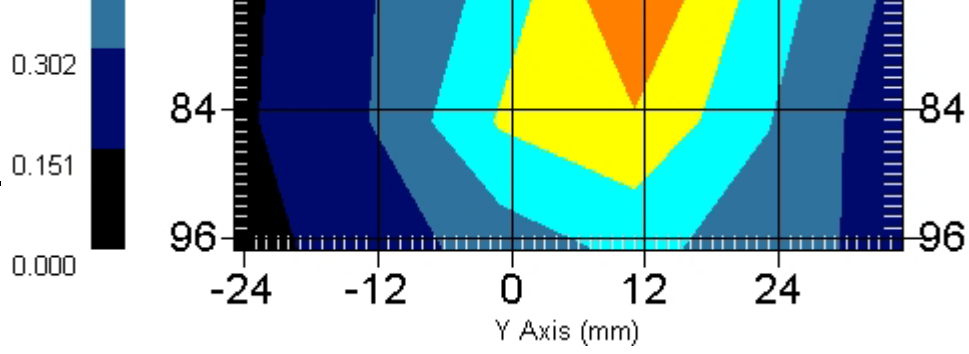

61L148-HP-US-P10V01

---

Measurement Data

Crest Factor : 8  
Tissue Temp. : 20.80 °C  
Ambient Temp. : 21.20 °C  
Area Scan : 7x6x1 : Measurement x=12mm, y=12mm, z=4mm  
Zoom Scan : 7x7x7 : Measurement x=5mm, y=5mm, z=5mm  
Power Drift-Start : 0.062 W/kg  
Power Drift-Finish: 0.060 W/kg  
Power Drift (%) : -3.262

DUT Position : 15° Tilt  
Channel : 189

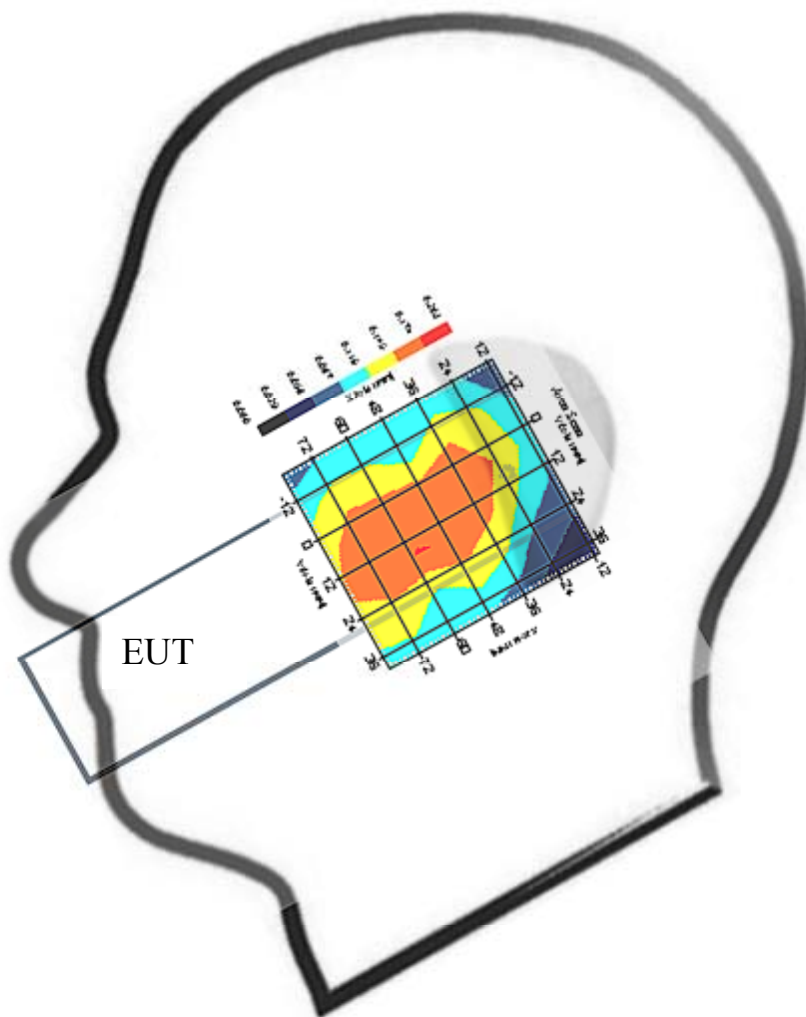

1 gram SAR value : 0.176 W/kg  
10 gram SAR value : 0.129 W/kg  
Area Scan Peak SAR : 0.175 W/kg  
Zoom Scan Peak SAR : 0.210 W/kg

This is previous page plot (zoom in)

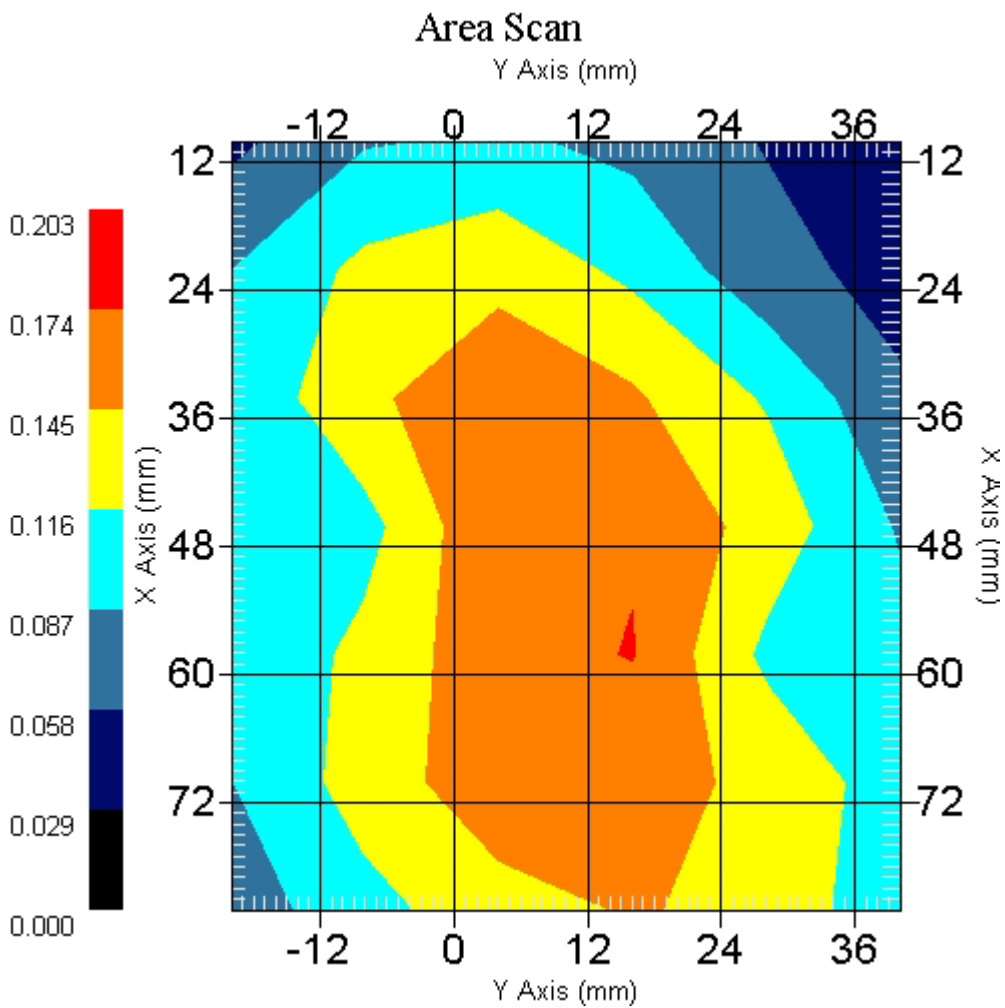

Measurement Data

Crest Factor : 8  
Tissue Temp. : 20.80 °C  
Ambient Temp. : 21.20 °C  
Area Scan : 7x6x1 : Measurement x=12mm, y=12mm, z=4mm  
Zoom Scan : 7x7x7 : Measurement x=5mm, y=5mm, z=5mm  
Power Drift-Start : 0.043 W/kg  
Power Drift-Finish: 0.043 W/kg  
Power Drift (%) : -0.067

DUT Position : GSM with Bluetooth-Touch  
Channel : 128

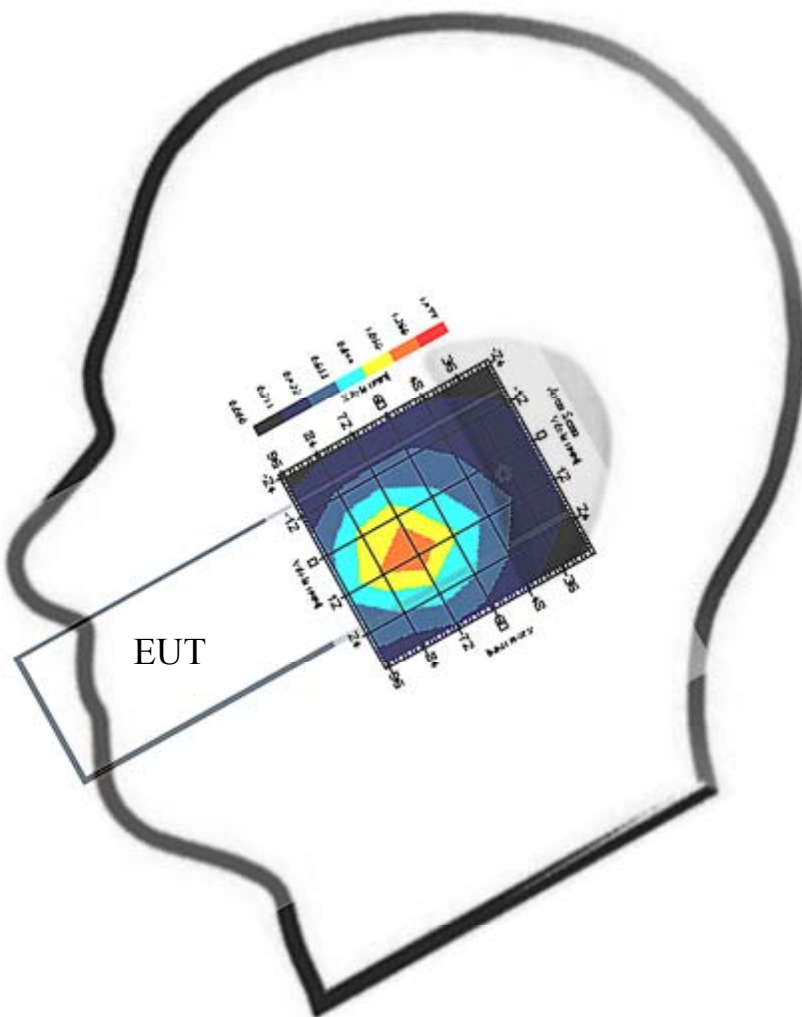

1 gram SAR value : 0.976 W/kg  
10 gram SAR value : 0.633 W/kg  
Area Scan Peak SAR : 1.267 W/kg  
Zoom Scan Peak SAR : 1.681 W/kg

This is previous page plot (zoom in)

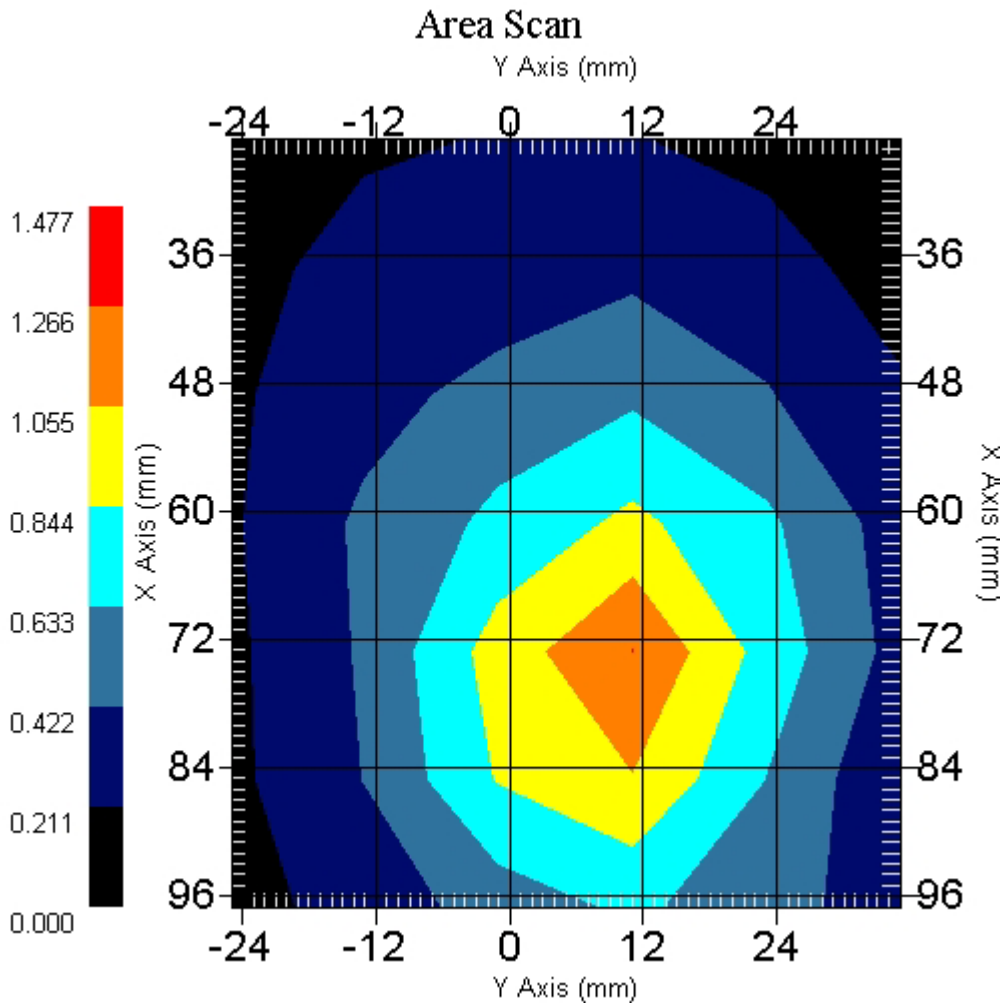

## ALSAS-10U VER 2.2.0 APREL Laboratories

## SAR Test Report

Validation Date : 24-Jan-2006  
Measurement Date : 24-Jan-2006

## Product Data

Device Name : Benq  
Type : Clamshell Cell Phone  
Model : HERC3A(M580a)  
Frequency : 850.00 MHz  
Max. Transmit Pwr : 2 W  
Drift Time : 0 min(s)  
Length : 162.4 mm  
Width : 44.2 mm  
Depth : 12.5 mm  
Antenna Type : Internal

## Phantom Data

Type : SAM-Left  
Size (mm) : 280 x 280 x 280  
Location : Left

## Tissue Data

Type : HEAD  
Serial No. : 322-H  
Frequency : 835.00 MHz  
Last Calib. Date : 24-Jan-2006  
Temperature : 20.80 °C  
Ambient Temp. : 21.20 °C  
Humidity : 57.00 RH%  
Epsilon : 40.62 F/m  
Sigma : 0.924 S/m  
Density : 1000.00 kg/cu. m

## Probe Data

Name : Probe 265  
Model : E020  
Type : E-Field Triangle  
Serial No. : 265  
Last Calib. Date : 23-Mar-2005  
Frequency : 835.00 MHz  
Duty Cycle Factor: 8  
Conversion Factor: 6.2  
Probe Sensitivity: 1.20 1.20 1.20  $\mu\text{V}/(\text{V}/\text{m})^2$   
Compression Point: 95.00 mV  
Offset : 1.56 mm

Measurement Data

Crest Factor : 8  
Tissue Temp. : 20.80 °C  
Ambient Temp. : 21.20 °C  
Area Scan : 7x6x1 : Measurement x=12mm, y=12mm, z=4mm  
Zoom Scan : 7x7x7 : Measurement x=5mm, y=5mm, z=5mm  
Power Drift-Start : 0.044 W/kg  
Power Drift-Finish: 0.044 W/kg  
Power Drift (%) : 1.248

DUT Position : Touch  
Channel : 128

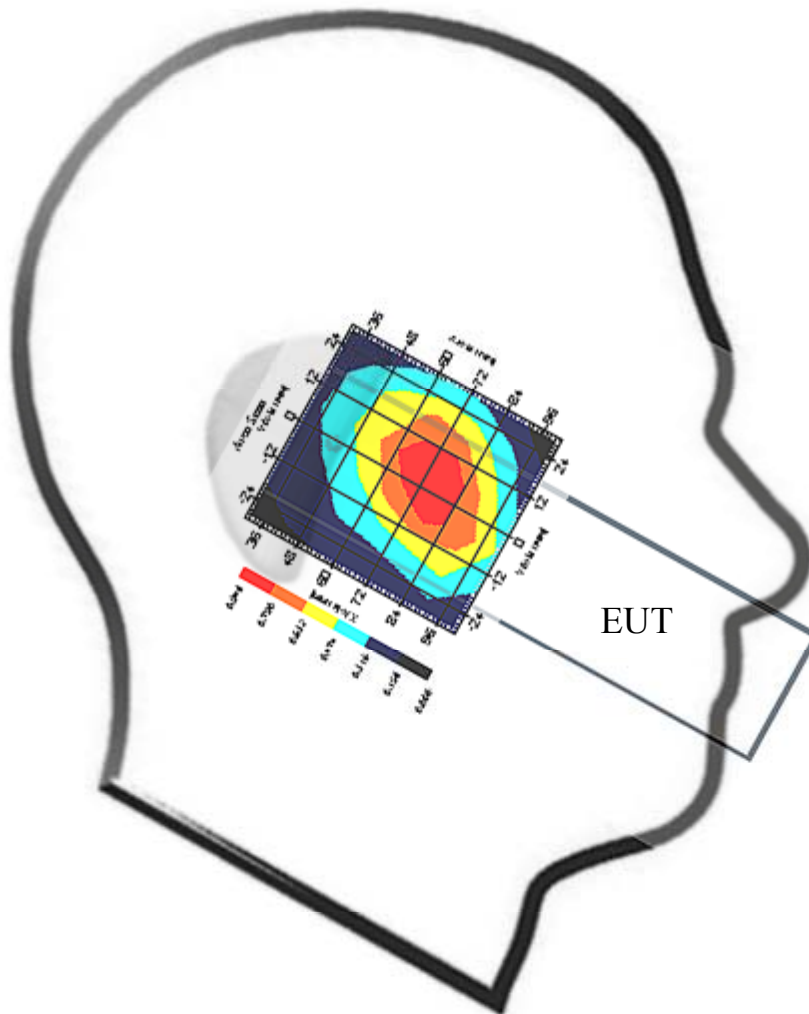

1 gram SAR value : 0.862 W/kg  
10 gram SAR value : 0.569 W/kg  
Area Scan Peak SAR : 0.947 W/kg  
Zoom Scan Peak SAR : 1.261 W/kg

This is previous page plot (zoom in)

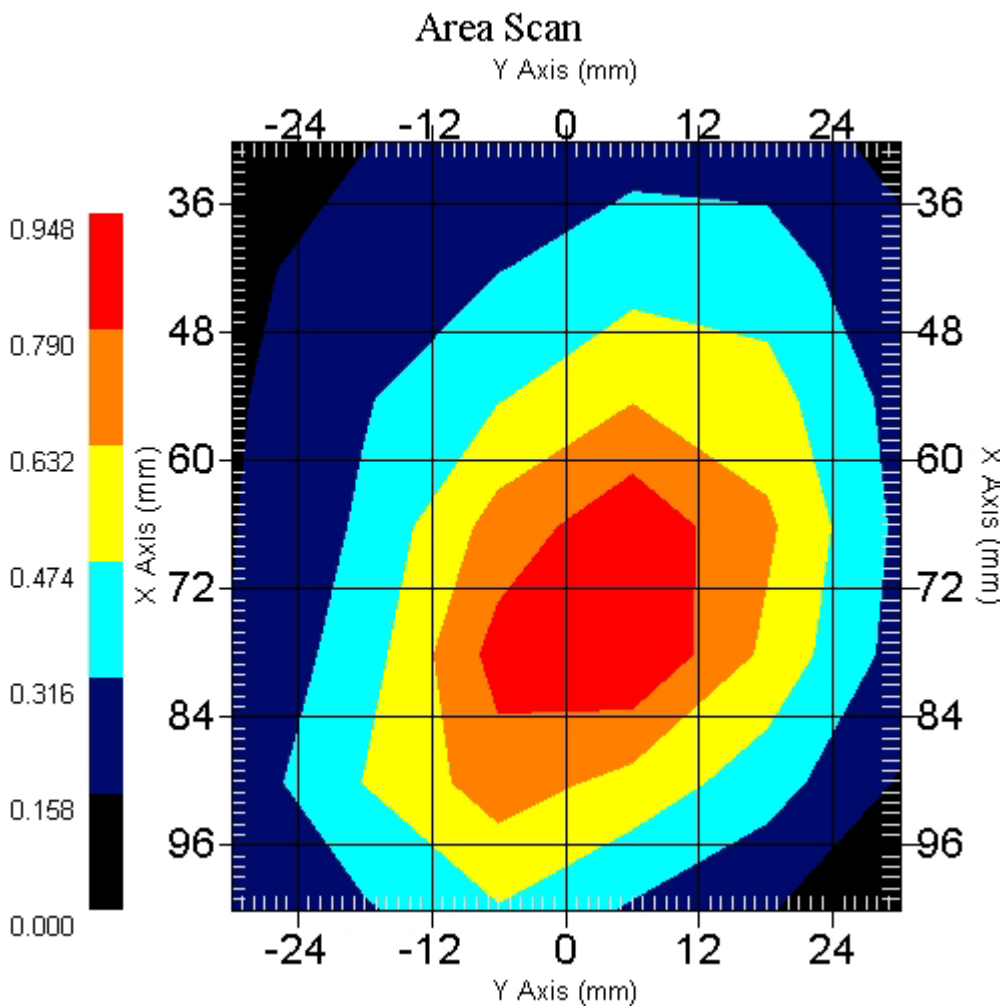



Measurement Data

Crest Factor : 8  
Tissue Temp. : 20.80 °C  
Ambient Temp. : 21.20 °C  
Area Scan : 7x6x1 : Measurement x=12mm, y=12mm, z=4mm  
Zoom Scan : 7x7x7 : Measurement x=5mm, y=5mm, z=5mm  
Power Drift-Start : 0.044 W/kg  
Power Drift-Finish: 0.044 W/kg  
Power Drift (%) : -1.018

DUT Position : Touch  
Channel : 189

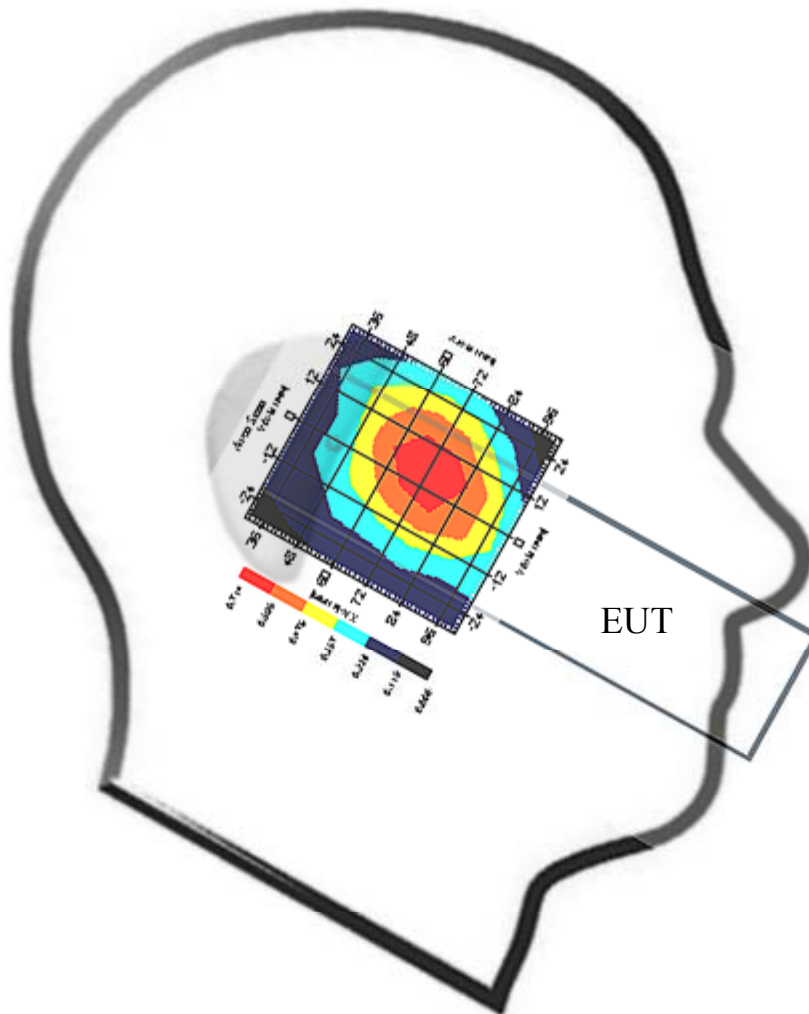

1 gram SAR value : 0.681 W/kg  
10 gram SAR value : 0.453 W/kg  
Area Scan Peak SAR : 0.714 W/kg  
Zoom Scan Peak SAR : 1.050 W/kg

This is previous page plot (zoom in)

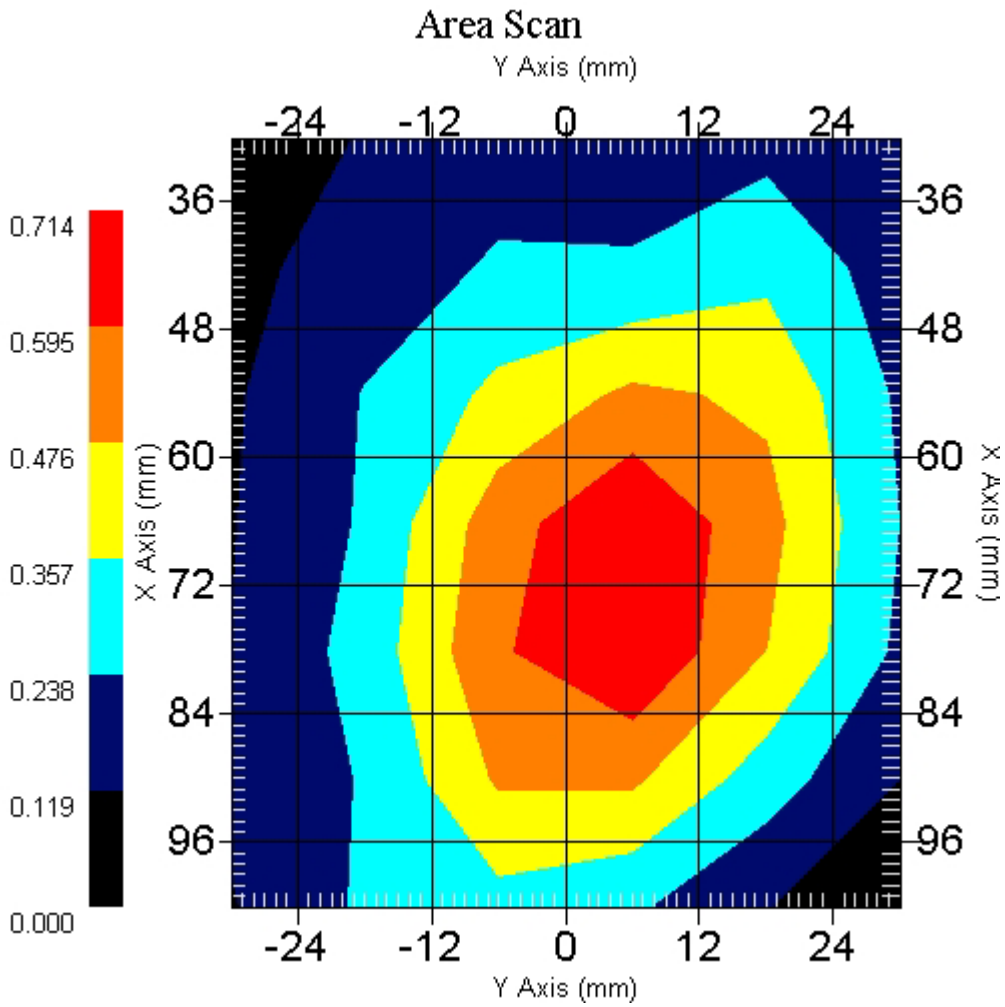

Measurement Data

Crest Factor : 8  
Tissue Temp. : 20.80 °C  
Ambient Temp. : 21.20 °C  
Area Scan : 7x6x1 : Measurement x=12mm, y=12mm, z=4mm  
Zoom Scan : 7x7x7 : Measurement x=5mm, y=5mm, z=5mm  
Power Drift-Start : 0.036 W/kg  
Power Drift-Finish: 0.035 W/kg  
Power Drift (%) : -3.275

DUT Position : Touch  
Channel : 251

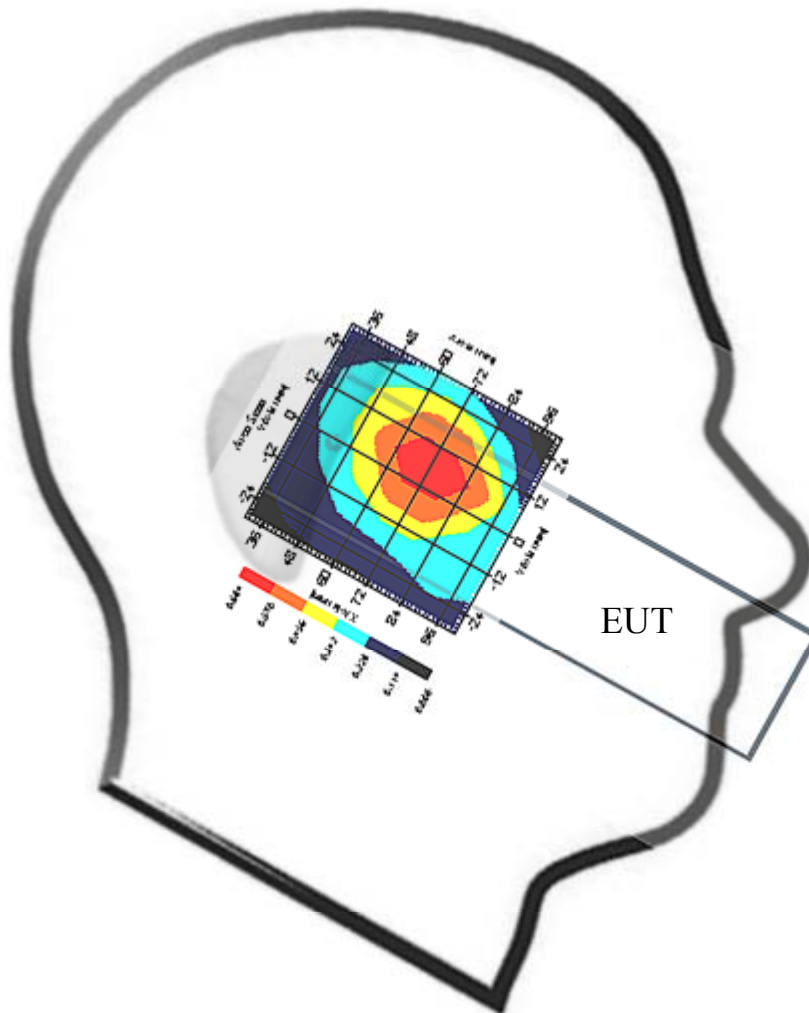

1 gram SAR value : 0.633 W/kg  
10 gram SAR value : 0.413 W/kg  
Area Scan Peak SAR : 0.682 W/kg  
Zoom Scan Peak SAR : 0.910 W/kg

This is previous page plot (zoom in)

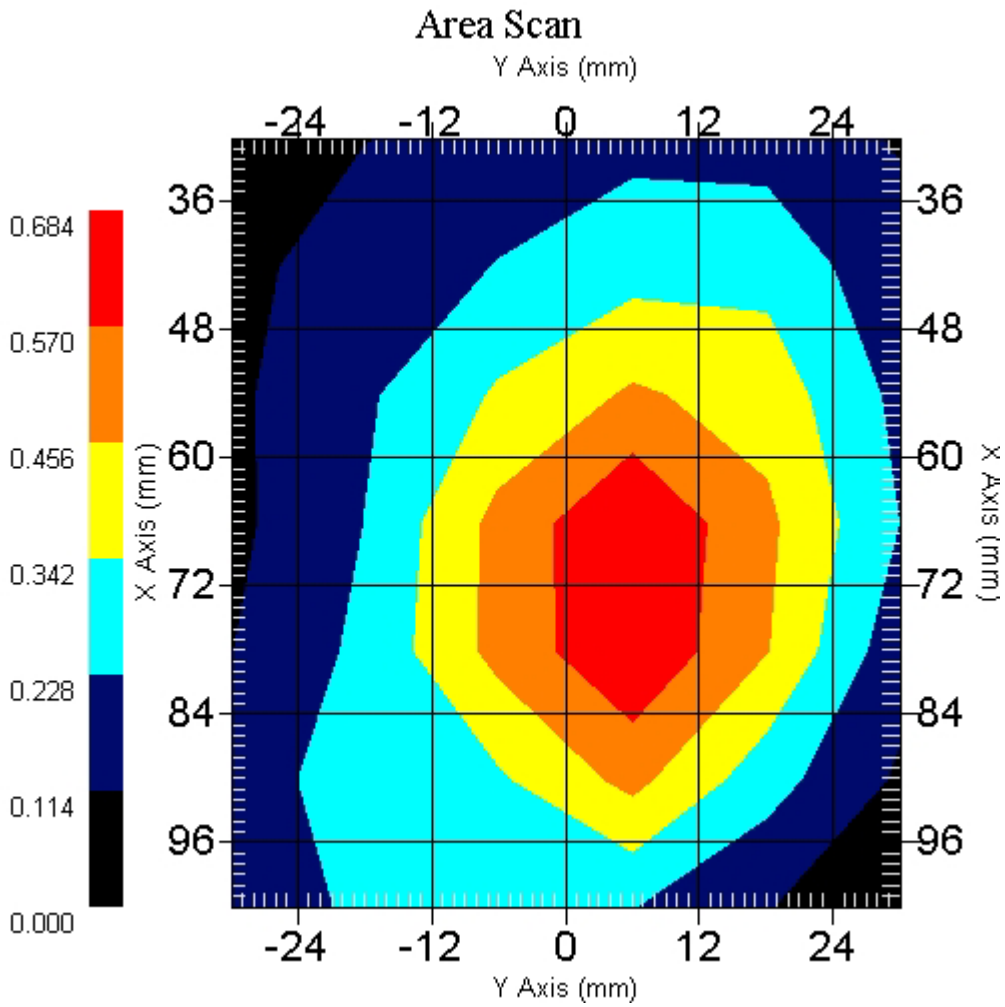

Measurement Data

Crest Factor : 8  
Tissue Temp. : 20.80 °C  
Ambient Temp. : 21.20 °C  
Area Scan : 7x6x1 : Measurement x=12mm, y=12mm, z=4mm  
Zoom Scan : 7x7x7 : Measurement x=5mm, y=5mm, z=5mm  
Power Drift-Start : 0.062 W/kg  
Power Drift-Finish: 0.061 W/kg  
Power Drift (%) : -0.359

DUT Position : 15° Tilt  
Channel : 189

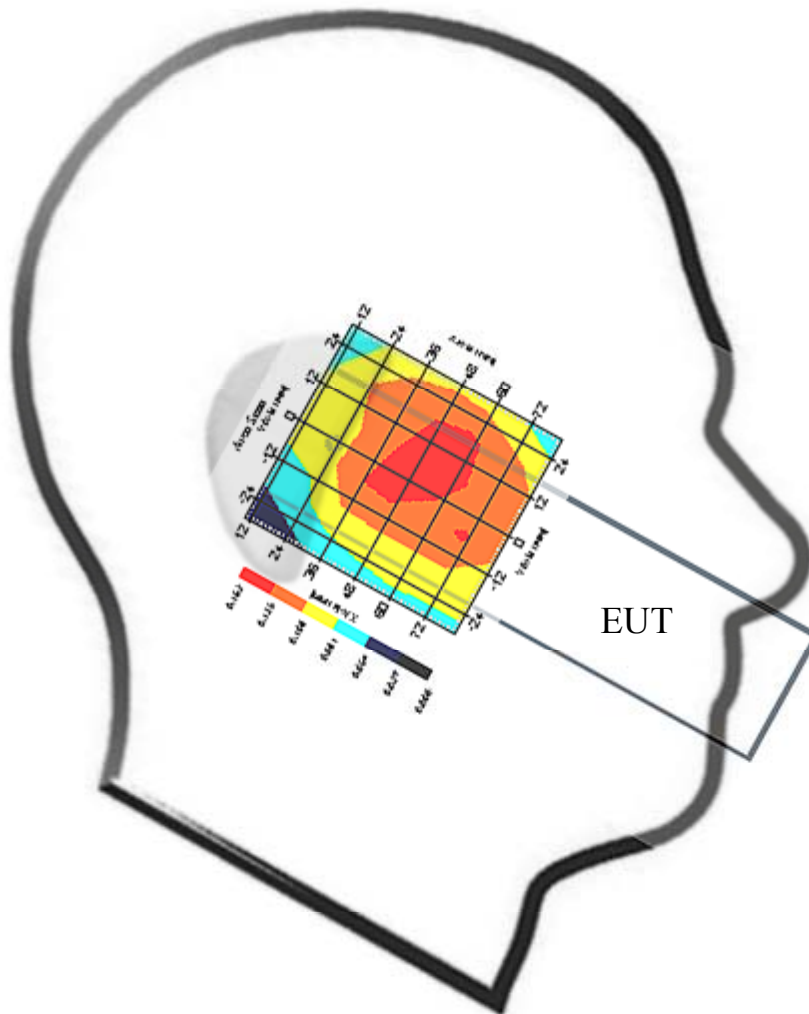

1 gram SAR value : 0.141 W/kg  
10 gram SAR value : 0.104 W/kg  
Area Scan Peak SAR : 0.160 W/kg  
Zoom Scan Peak SAR : 0.180 W/kg

This is previous page plot (zoom in)

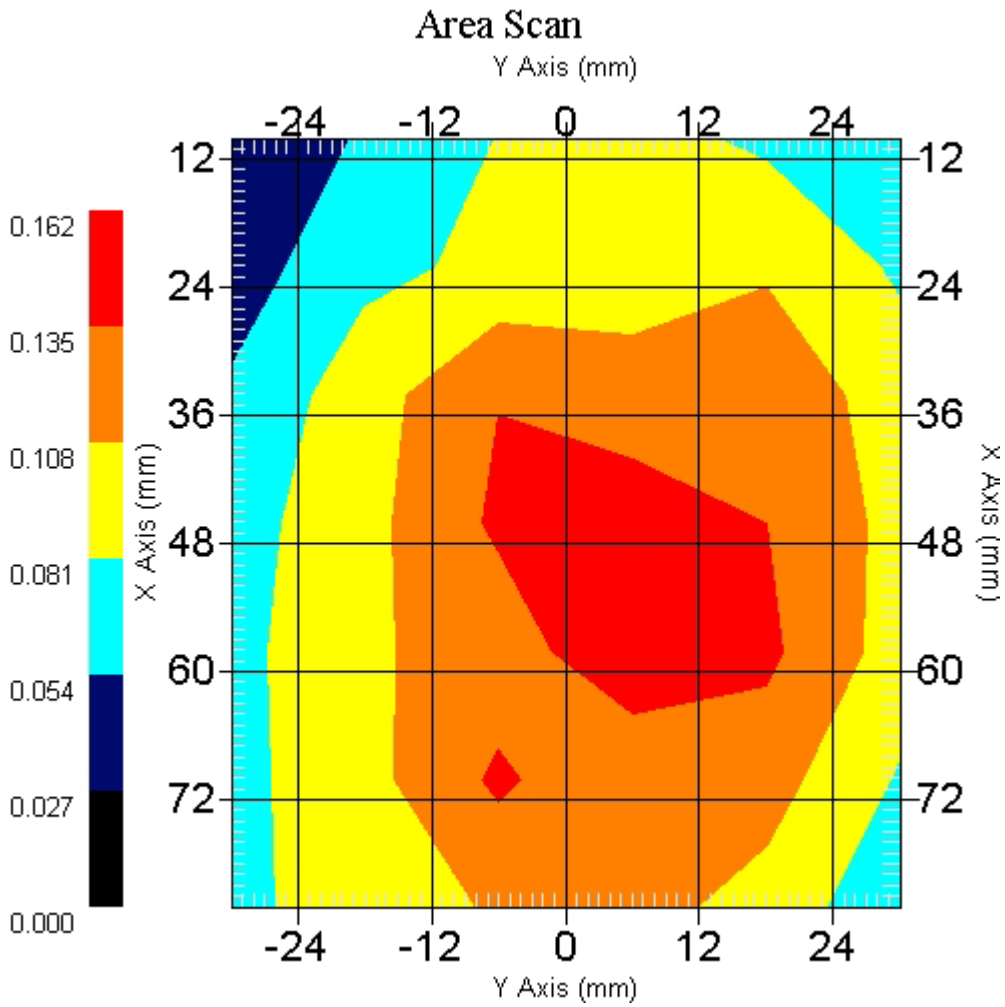

## ALSAS-10U VER 2.2.0 APREL Laboratories

## SAR Test Report

Validation Date : 24-Jan-2006  
Measurement Date : 24-Jan-2006

## Product Data

Device Name : Benq  
Type : Clamshell Cell Phone  
Model : HERC3A(M580a)  
Frequency : 850.00 MHz  
Max. Transmit Pwr : 2 W  
Drift Time : 0 min(s)  
Length : 88.7 mm  
Width : 44.2 mm  
Depth : 22.6 mm  
Antenna Type : Internal

## Phantom Data

Type : Uni-Phantom  
Size (mm) : 280 x 280 x 200  
Location : Center

## Tissue Data

Type : BODY  
Serial No. : 322-B  
Frequency : 835.00 MHz  
Last Calib. Date : 24-Jan-2006  
Temperature : 20.80 °C  
Ambient Temp. : 21.20 °C  
Humidity : 57.00 RH%  
Epsilon : 53.54 F/m  
Sigma : 0.993 S/m  
Density : 1000.00 kg/cu. m

## Probe Data

Name : Probe 265  
Model : E020  
Type : E-Field Triangle  
Serial No. : 265  
Last Calib. Date : 23-Mar-2005  
Frequency : 835.00 MHz  
Duty Cycle Factor: 8  
Conversion Factor: 6.6  
Probe Sensitivity: 1.20 1.20 1.20  $\mu\text{V}/(\text{V}/\text{m})^2$   
Compression Point: 95.00 mV  
Offset : 1.56 mm

Measurement Data

Crest Factor : 8  
 Tissue Temp. : 20.80 °C  
 Ambient Temp. : 21.20 °C  
 Area Scan : 7x6x1 : Measurement x=12mm, y=12mm, z=4mm  
 Zoom Scan : 7x7x7 : Measurement x=5mm, y=5mm, z=5mm  
 Power Drift-Start : 0.756 W/kg  
 Power Drift-Finish: 0.749 W/kg  
 Power Drift (%) : -1.211

DUT Position : Touch  
 Channel : 128

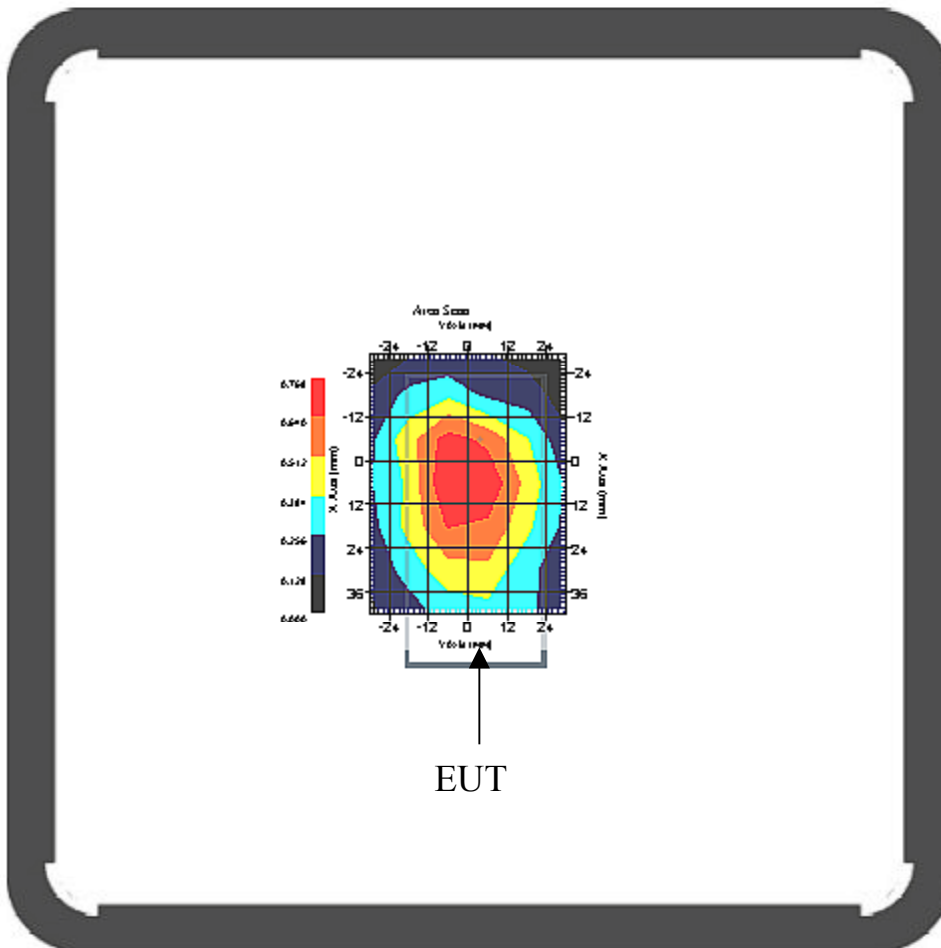

1 gram SAR value : 0.734 W/kg  
 10 gram SAR value : 0.475 W/kg  
 Area Scan Peak SAR : 0.766 W/kg  
 Zoom Scan Peak SAR : 1.060 W/kg



This is previous page plot (zoom in)

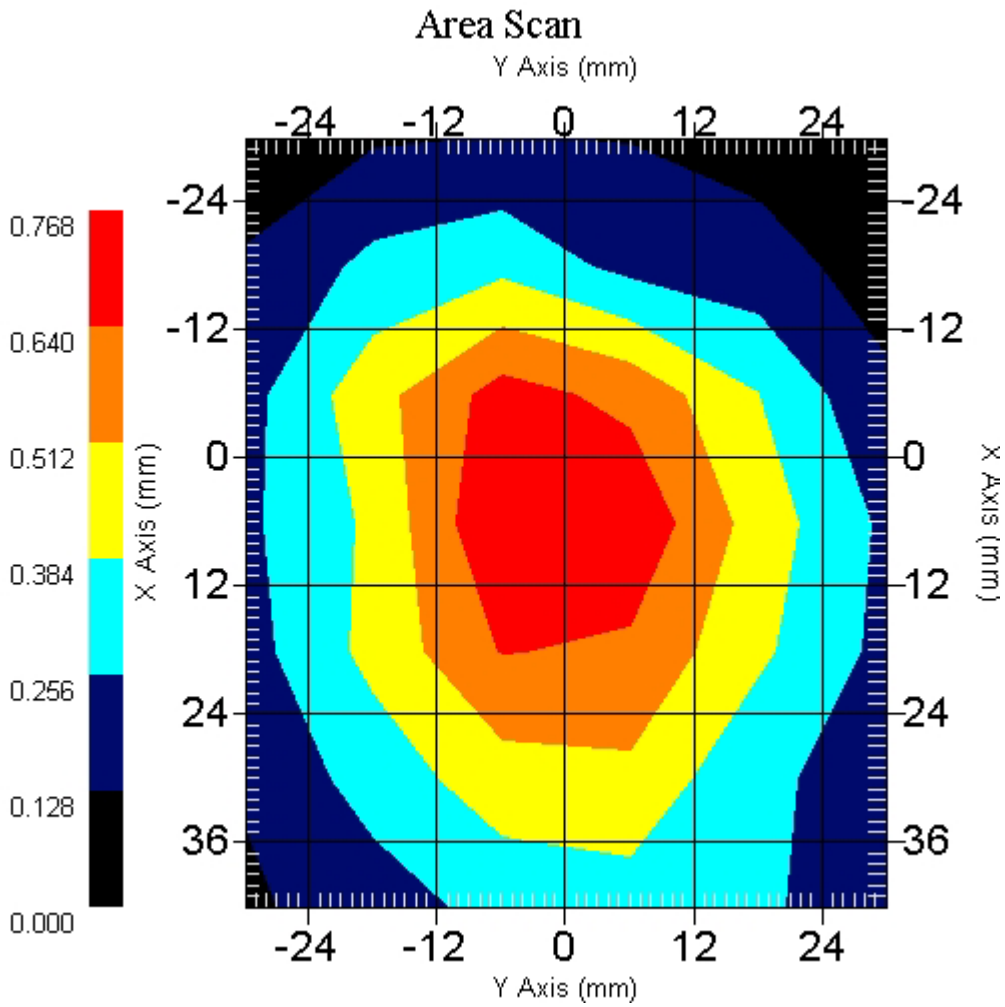

Measurement Data

Crest Factor : 8  
 Tissue Temp. : 20.80 °C  
 Ambient Temp. : 21.20 °C  
 Area Scan : 7x6x1 : Measurement x=12mm, y=12mm, z=4mm  
 Zoom Scan : 7x7x7 : Measurement x=5mm, y=5mm, z=5mm  
 Power Drift-Start : 0.623 W/kg  
 Power Drift-Finish: 0.639 W/kg  
 Power Drift (%) : 2.469

DUT Position : Touch  
 Channel : 189

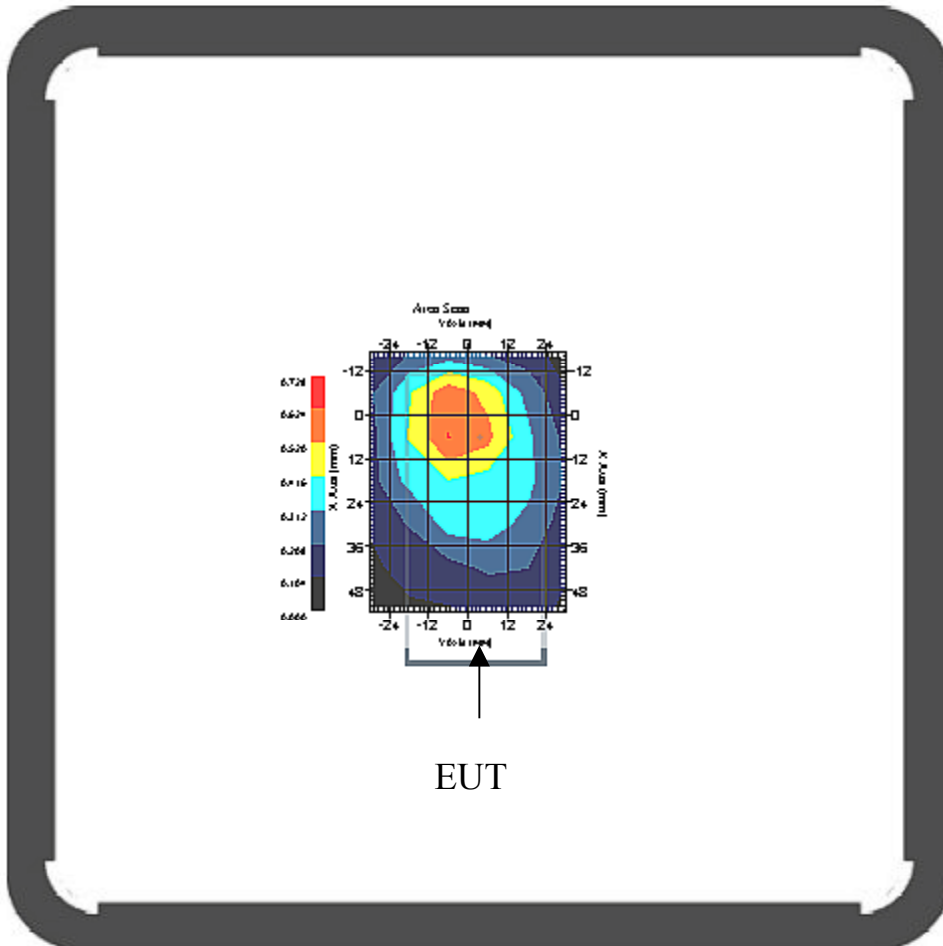

1 gram SAR value : 0.554 W/kg  
 10 gram SAR value : 0.344 W/kg  
 Area Scan Peak SAR : 0.627 W/kg  
 Zoom Scan Peak SAR : 1.080 W/kg

This is previous page plot (zoom in)

