



# FCC TEST REPORT

for

## 47 CFR Part 22H and 24E

**Equipment** : GSM/GPRS Module  
**Trade Name** : BenQ  
**Model No.** : M25  
**FCC ID** : JVPM25  
**Tx Frequency Range** : GSM850 : 824~849 MHz  
PCS1900 : 1850~1910 MHz  
**Max. ERP/EIRP Power** : GSM850 (GSM) : 0.22 W  
PCS1900 (GSM) : 0.93 W  
**Emission Designator** : 300KGXW  
**Applicant** : BenQ Corporation  
157 Shan-Ying Road, Gueishan Taoyuan 333, Taiwan

- The test result refers exclusively to the test presented test model / sample.
- Without written approval of SPORTON International Inc., the test report shall not be reproduced except in full.
- **Certificate or Test Report must not be used by the applicant to claim the product in this test report endorsement by NVLAP or any agency of U.S. government.**
- The data shown in this test report were carried out on Mar. 24, 2007 at **Sporton International Inc. LAB.**
- Report No.: FG731404A, Report Version: Rev. 01.

Roy Wu  
Deputy Manager

### **SPORTON International Inc.**

6F, No.106, Sec. 1, Hsin Tai Wu Rd., Hsi Chih, Taipei Hsien, Taiwan, R.O.C.



# Table of Contents

**History of this test report.....ii**

**1. General Information ..... 1**

    1.1. Applicant ..... 1

    1.2. Manufacturer ..... 1

    1.3. Basic Description of Equipment under Test ..... 1

    1.4. Feature of Equipment under Test ..... 2

    1.5. Report Date ..... 2

**2 Test Configuration of Equipment under Test ..... 3**

    2.1 Test Manner ..... 3

    2.2 Test Mode ..... 3

    2.3 Connection Diagram of Test System ..... 3

    2.4 Ancillary Equipment List ..... 3

**3. General Information of Test Site ..... 4**

    3.1 Test Voltage ..... 4

    3.2 Test in Compliance with ..... 4

    3.3 Frequency Range Investigated ..... 4

    3.4 Test Distance ..... 4

**4. Test Data and Test Result..... 5**

    4.1 List of Measurements and Examinations ..... 5

    4.2 RF Output Power ..... 6

    4.3 ERP / EIRP Measurement ..... 7

    4.4 Occupied Bandwidth and Band Edge Measurement ..... 10

    4.5 Conducted Emission ..... 19

    4.6 Field Strength of Spurious Radiation ..... 29

    4.7 Frequency Stability (Temperature Variation) ..... 50

    4.8 Frequency Stability (Voltage Variation) ..... 52

**5 List of Measurement Equipments ..... 53**

**6 Uncertainty Evaluation..... 54**

**Appendix A. Photographs of EUT**

**Appendix B. Set up Photograph**





## **1. General Information**

### **1.1. Applicant**

**BenQ Corporation**

157 Shan-Ying Road, Gueishan Taoyuan 333, Taiwan

### **1.2 Manufacturer**

**1. BenQ Corporation**

157 Shan-Ying Road, Gueishan Taoyuan 333, Taiwan

**2. BenQ (Shanghai Pudong) Co., Ltd.**

777 Chuanqiao Road, Pudong, Shanghai 201206, P.R., China

### **1.3 Basic Description of Equipment under Test**

Equipment : GSM/GPRS Module  
Trade Name : BenQ  
Model No. : M25  
FCC ID : JVPM25  
AC Power Cable : AC 120V, 2.0 meter, 2 pin

**1.4 Feature of Equipment under Test**

<b>DUT Type :</b>	GSM/GPRS Module
<b>Trade Name :</b>	BenQ
<b>Model Name :</b>	M25
<b>FCC ID :</b>	JVPM25
<b>Tx Frequency :</b>	GSM850 : 824 ~ 849 MHz PCS1900 : 1850 ~1910 MHz
<b>Rx Frequency :</b>	GSM850 : 869 ~ 894 MHz PCS1900 : 1930 ~ 1990 MHz
<b>Maximum Output Power to Antenna :</b>	GSM850(GSM) : 32.9 dBm PCS1900(GSM) : 29.2 dBm
<b>Maximum ERP/EIRP :</b>	GSM850(GSM) : 0.22 W ( 23.36 dBm) PCS1900(GSM) : 0.93 W ( 29.67 dBm)
<b>Antenna Type :</b>	Fixed External
<b>HW Version :</b>	LPR4
<b>SW Version :</b>	0.03
<b>Power Rating (DC/AC , Voltage and Current of RF element or PA) :</b>	DC 3.8V
<b>Digital Modulation Emission :</b>	GMSK
<b>Type of Emission :</b>	300KGXW
<b>Device Power Class :</b>	GSM850 : 4 PCS1900 : 1
<b>DUT Stage :</b>	Production Unit

**1.5 Report Date**

EUT Received : Mar. 14, 2007

Report Date : Mar. 28, 2007

## 2 Test Configuration of Equipment under Test

### 2.1 Test Manner

- a. The spurious emission measurements were carried out in semi-anechoic chamber with 3-meter test range.
- b. During all testings, EUT is in link mode with base station emulator at maximum power level.
- c. Frequency range investigated: radiated emission 30 MHz to 9000 MHz for GSM850; 30MHz to 19000 MHz for PCS.

### 2.2 Test Mode

Application	GSM850	PCS1900
Radiated Emission	<input checked="" type="checkbox"/> Mode 1: GSM Link_CH 189	<input checked="" type="checkbox"/> Mode 2: GSM Link_CH 661
Conducted Measurement	<input checked="" type="checkbox"/> Mode 1: GSM_Link CH 189	<input checked="" type="checkbox"/> Mode 2: GSM Link_CH 661

### 2.3 Connection Diagram of Test System

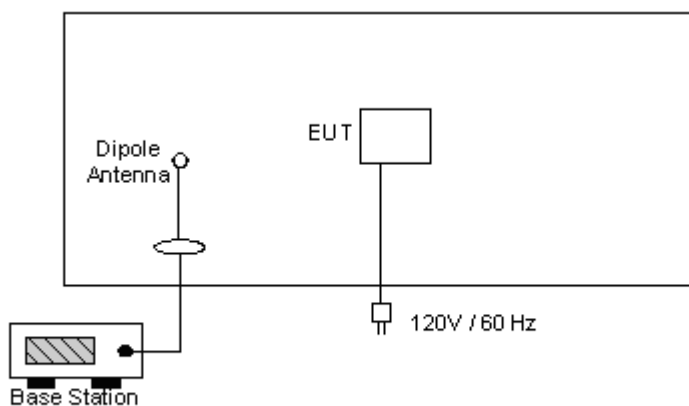

### 2.4 Ancillary Equipment List

Item	Equipment	Model No.	Serial No.
1.	Base Station(R&S)	CMU200	106656



### **3. General Information of Test Site**

Test Site Location : No. 52, Hwa Ya 1st Rd., Hwa Ya Technology Park,  
Kwei-Shan Hsiang, Tao Yuan Hsien, Taiwan, R.O.C.  
TEL : 886-3-327-3456  
FAX : 886-3-318-0055

Test Site No : 03CH06-HY

The chamber meets the characteristics of ANSI C63.4-2003. This site is on file with the FCC.

#### **3.1 Test Voltage**

AC 120V

#### **3.2 Test in Compliance with**

47 CFR Part 22H, 24E and Part 2

#### **3.3 Frequency Range Investigated**

- a. Radiation: from 30MHz to 9000MHz for GSM850.
- b. Radiation: from 30 MHz to 19000 MHz for PCS.

#### **3.4 Test Distance**

The test distance of radiated emission from antenna to EUT is 3 m.



## 4. Test Data and Test Result

### 4.1 List of Measurements and Examinations

FCC Rule	DESCRIPTION OF TEST	Result	Section
§2.1046	RF Output Power	Passed	4.2
§ 22.913 §24.232	ERP / EIRP	Passed	4.3
§2.1049, § 22.917, § 24.238(b)	Occupied Bandwidth & Band Edge Measurement	Passed	4.4
§2.1051	Conducted Emission	Passed	4.5
§2.1053	Field Strength of Spurious Radiation	Passed	4.6
§2.1055, § 22.355, §24.235	Frequency Stability vs. Temperature	Passed	4.7
§2.1055, §22.355, §24.235	Frequency Stability vs. Voltage	Passed	4.8



## 4.2 RF Output Power

### 4.2.1 Measurement Instruments :

As described in chapter 5 of this test report.

### 4.2.2 Test Procedure :

1. The transmitter output was connected to power meter and base station through power divider.
2. Set EUT at PCL=5 for GSM850 and/or PCL=0 for PCS1900 maximum power through base station.
3. Select lowest, middle, and highest channels for each band.

### 4.2.3 Test Setup Layout :

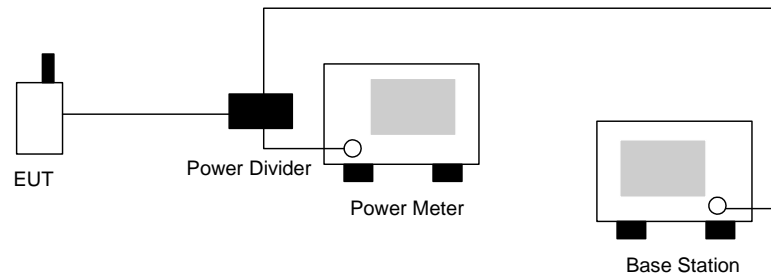

### 4.2.4 Test Result :

Bands	Channel	Frequency (MHz)	Conducted Power (dBm)	Conducted Power (Watts)
GSM850	128	824.2 (Low)	32.9	1.936
	189	836.4 (Mid)	32.5	1.778
	251	848.8 (High)	32.3	1.698
PCS1900	512	1850.2 (Low)	28.9	0.776
	661	1880.0 (Mid)	29.2	0.832
	810	1909.8 (High)	28.7	0.741



### 4.3 ERP / EIRP Measurement

Equivalent isotropic radiated power measurements by substitution method according to ANSI/TIA/EIA-603-C.

#### 4.3.1 Measurement Instruments

As described in chapter 5 of this test report.

#### 4.3.2 Test Procedure

1. The EUT was placed on a rotatable table with 1.0 meter height in an fully anechoic chamber.
2. The EUT was set 1.2 meters from the receiving antenna which was mounted on the antenna tower.
3. The table was rotated 360 degrees to determine the position of the highest radiated power.
4. The height of the receiving antenna is also kept at 1.0M height.
5. Taking the record of maximum ERP/EIRP.
6. A dipole antenna was substituted in place of the EUT and was driven by a signal generator.
7. The conducted power at the terminal of the dipole antenna is measured.
8. Repeat step 3 to step 5 to get the maximum ERP/EIRP of the substitution antenna.
9.  $ERP/EIRP = P_s + E_t - E_s + G_s = P_s + R_t - R_s + G_s$

$P_s$  (dBm) : Input power to substitution antenna.

$G_s$  (dBi or dBd) : Substitution antenna Gain.

$E_t = R_t + AF$

$E_s = R_s + AF$

$AF$  (dB/m) : Receive antenna factor

$R_t$  : The highest received signal in Spectrum Analyzer for EUT.

$R_s$  : The highest received signal in spectrum analyzer for substitution antenna.

4.3.3 Test Setup Layout of ERP/EIRP

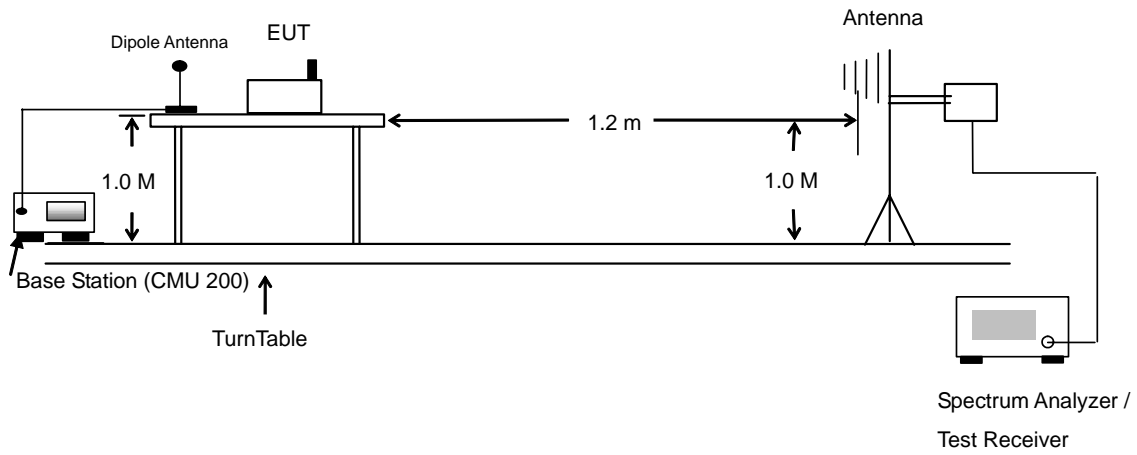



4.3.4 Test Result

<b>GSM850 Radiated Power ERP</b>						
Horizontal Polarization						
Frequency (MHz)	Rt (dBm)	Rs (dBm)	Ps (dBm)	Gs (dBd)	ERP (dBm)	ERP (W)
824.20	-25.86	-48.12	0.00	-1.08	21.18	0.13
836.40	-25.02	-48.28	0.00	-0.93	22.33	0.17
<b>848.80</b>	<b>-24.23</b>	<b>-48.35</b>	<b>0.00</b>	<b>-0.76</b>	<b>23.36</b>	<b>0.22</b>
Vertical Polarization						
Frequency (MHz)	Rt (dBm)	Rs (dBm)	Ps (dBm)	Gs (dBd)	ERP (dBm)	ERP (W)
824.20	-32.67	-47.97	0.00	-1.08	14.22	0.03
836.40	-32.21	-48.01	0.00	-0.93	14.87	0.03
848.80	-31.24	-48.05	0.00	-0.76	16.05	0.04

<b>PCS1900 Radiated Power EIRP</b>						
Horizontal Polarization						
Frequency (MHz)	Rt (dBm)	Rs (dBm)	Ps (dBm)	Gs (dBi)	EIRP (dBm)	EIRP (W)
1850.20	-27.19	-51.88	0.00	1.96	26.65	0.46
1880.00	-28.63	-52.99	0.00	2.00	26.36	0.43
1909.80	-29.96	-54.28	0.00	1.98	26.30	0.43
Vertical Polarization						
Frequency (MHz)	Rt (dBm)	Rs (dBm)	Ps (dBm)	Gs (dBi)	EIRP (dBm)	EIRP (W)
1850.20	-25.47	-52.13	0.00	1.96	28.62	0.73
<b>1880.00</b>	<b>-25.50</b>	<b>-53.17</b>	<b>0.00</b>	<b>2.00</b>	<b>29.67</b>	<b>0.93</b>
1909.80	-26.45	-54.13	0.00	1.98	29.66	0.92

## 4.4 Occupied Bandwidth and Band Edge Measurement

### 4.4.1 Measurement Instruments

As described in chapter 5 of this test report.

### 4.4.2 Test Procedure

1. The EUT was connected to Spectrum Analyzer and Base Station via power divider.
2. The 99% occupied bandwidth of middle channel for the highest and lowest RF powers were measured.
3. The bandedge of low and high channels for the highest RF powers within the transmitting frequency band were measured. Setting RBW as roughly  $BW/100$ .

### 4.4.3 Test Setup Layout

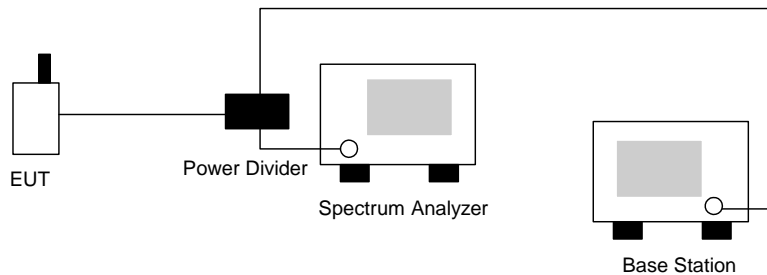



4.4.4 Test Result

- Mode 1
- Test Mode : GSM850 CH128 Lower Band Edge
- Power State : High

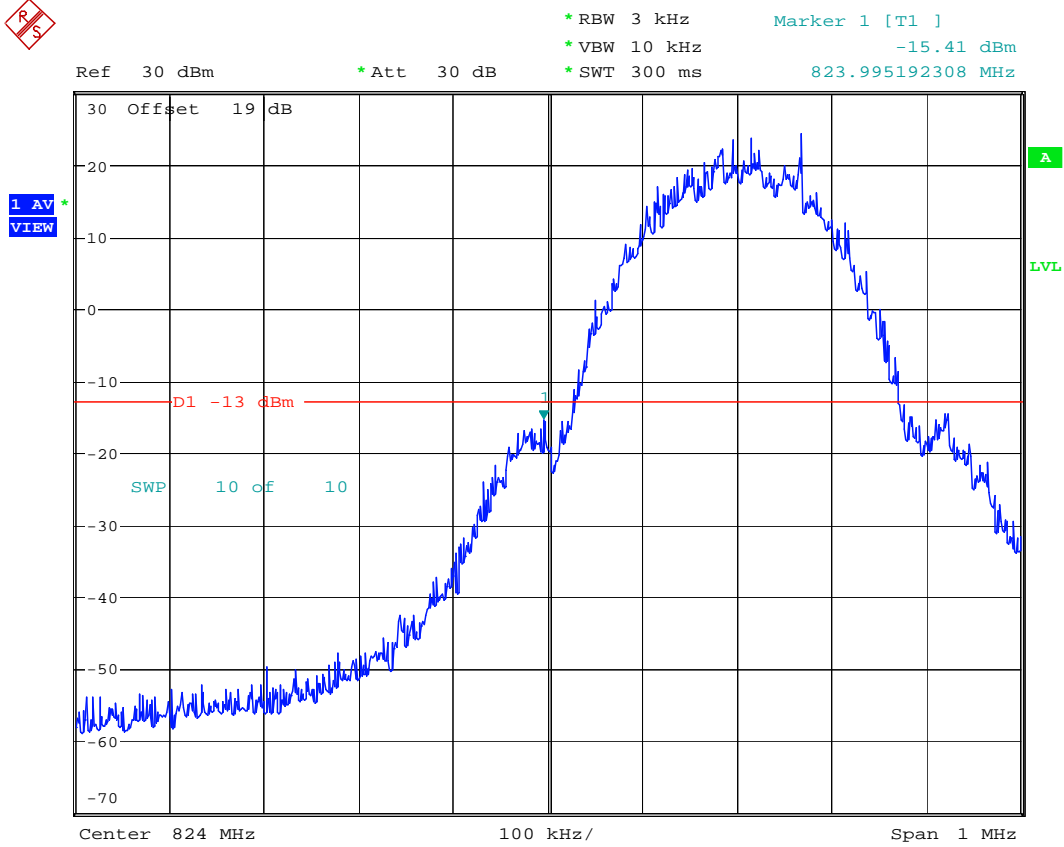

Date: 22.MAR.2007 17:19:10



- Test Mode : GSM850 CH189 99% Occupied Bandwidth
- Power State : Low

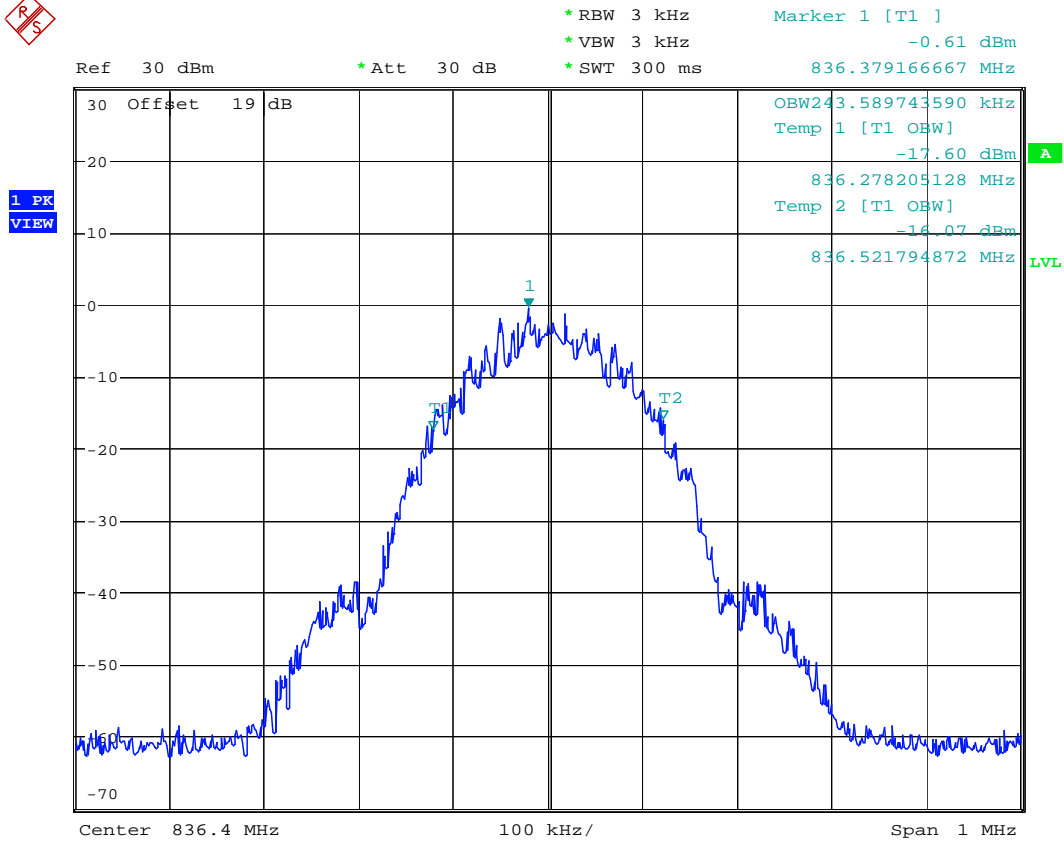

Date: 22.MAR.2007 17:13:56



- Test Mode : GSM850 CH189 99% Occupied Bandwidth
- Power State : High

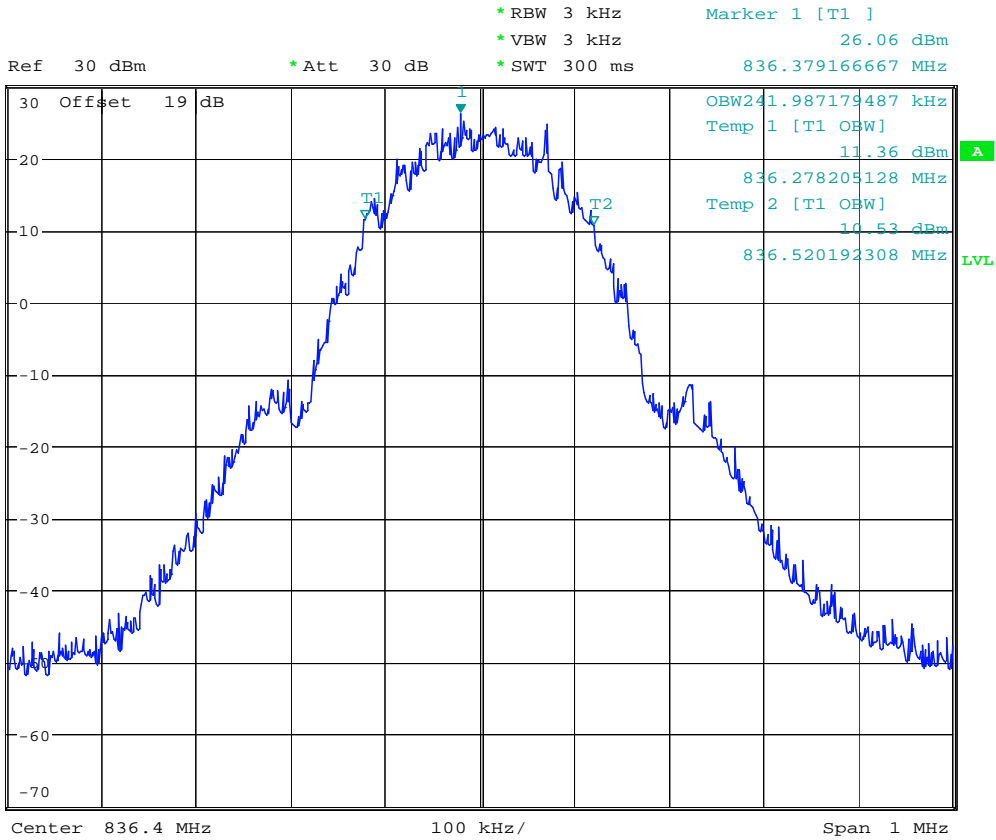

Date: 22.MAR.2007 17:12:40





- Test Mode : GSM850 CH251 Higher Band Edge
- Power State : High

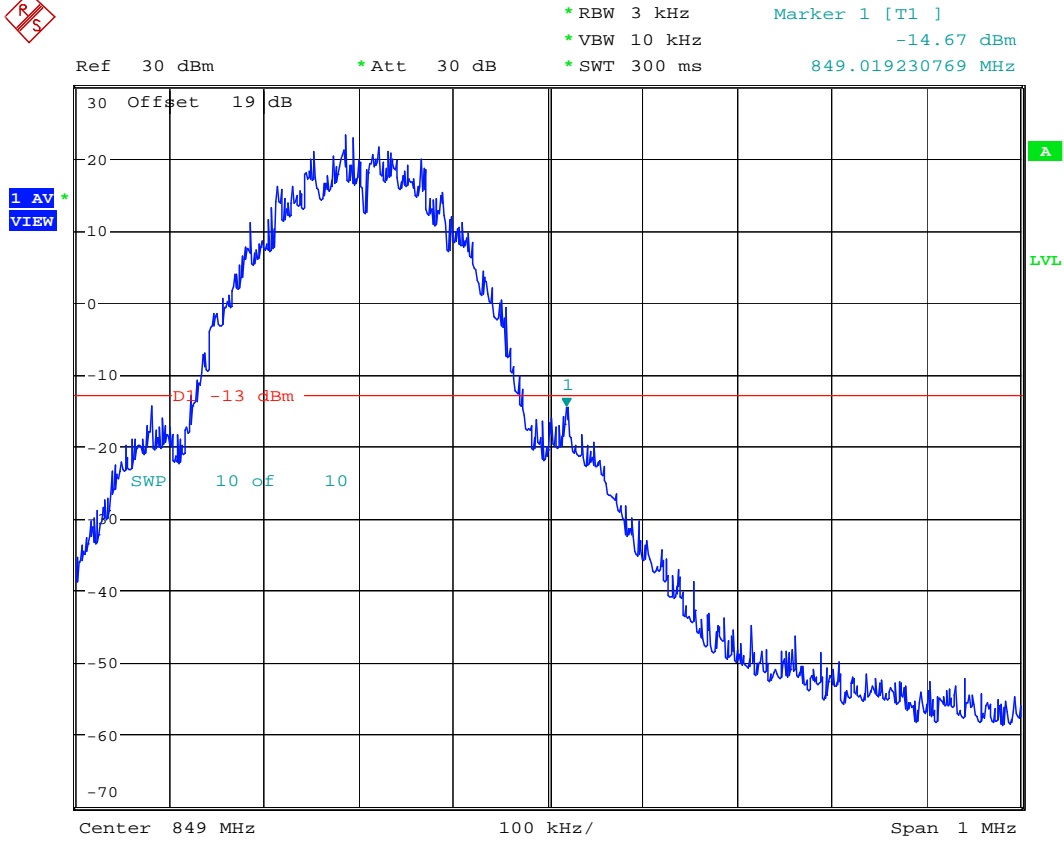

Date: 22.MAR.2007 17:17:56





- Test Mode : PCS1900 CH661 99% Occupied Bandwidth
- Power State : Low

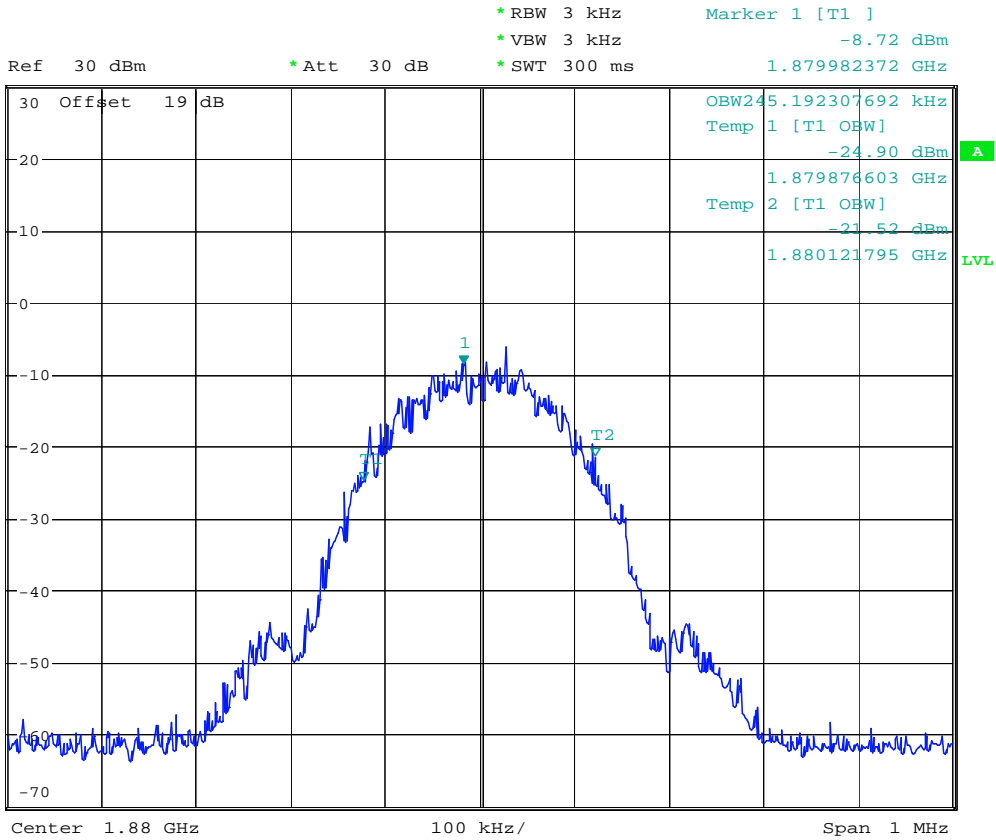

Date: 22.MAR.2007 17:00:56



- Test Mode : PCS1900 CH661 99% Occupied Bandwidth
- Power State : High

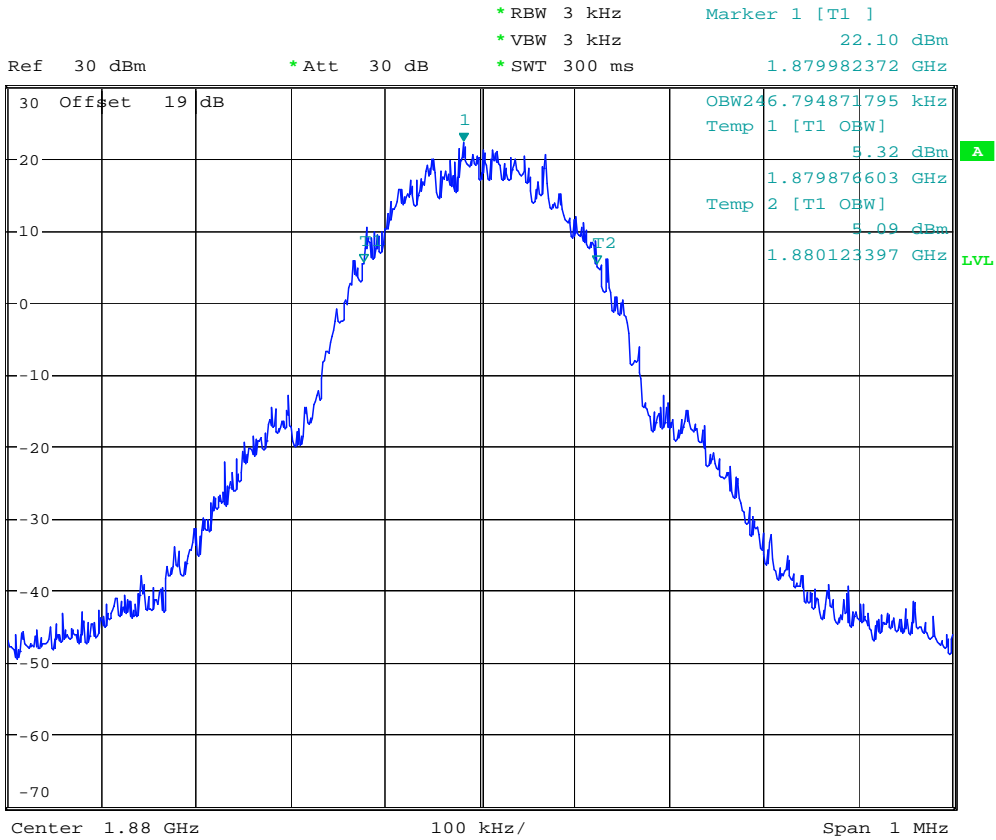

Date: 22.MAR.2007 16:58:47



- Test Mode : PCS1900 CH810 Higher Band Edge
- Power State : High

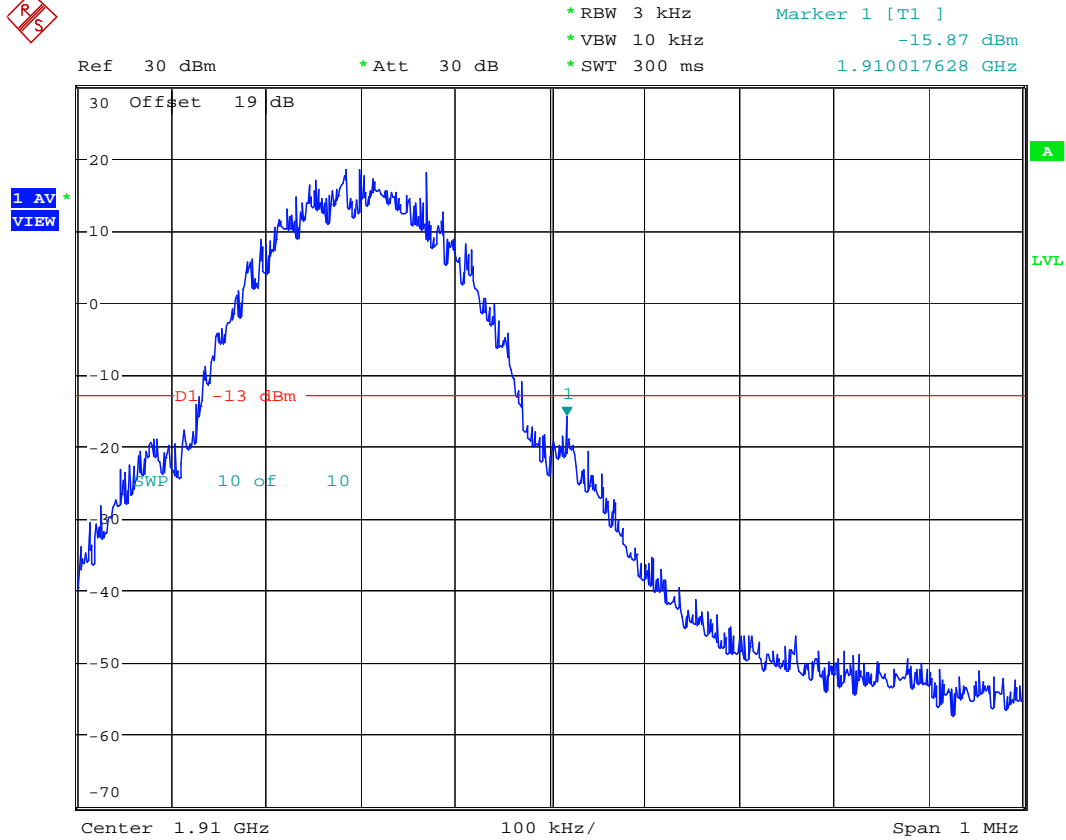

Date: 22.MAR.2007 17:06:50

## 4.5 Conducted Emission

### 4.5.1 Measurement Instruments

As described in chapter 5 of this test report.

### 4.5.2 Test Procedure

1. The EUT was connected to Spectrum Analyzer and Base Station via power divider.
2. The middle channel for the highest RF power within the transmitting frequency was measured.
3. The conducted spurious emission for the whole frequency range was taken.

### 4.5.3 Test Setup Layout

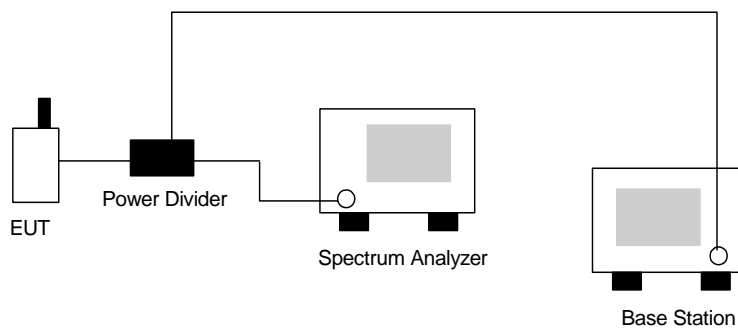



4.5.4 Test Result

- Mode 1
- Test Mode : GSM850 CH189
- Frequency Range : 30M-1G

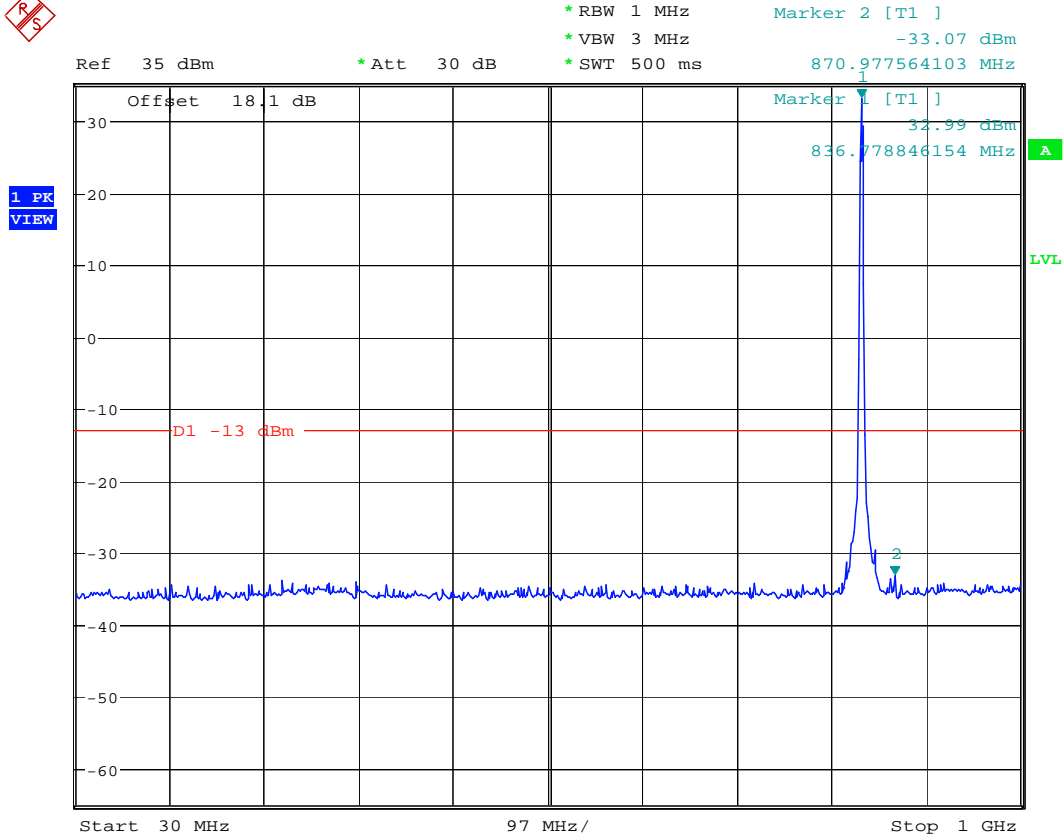

Date: 22.MAR.2007 20:36:35



- Test Mode : GSM850 CH189
- Frequency Range : 1G-3G

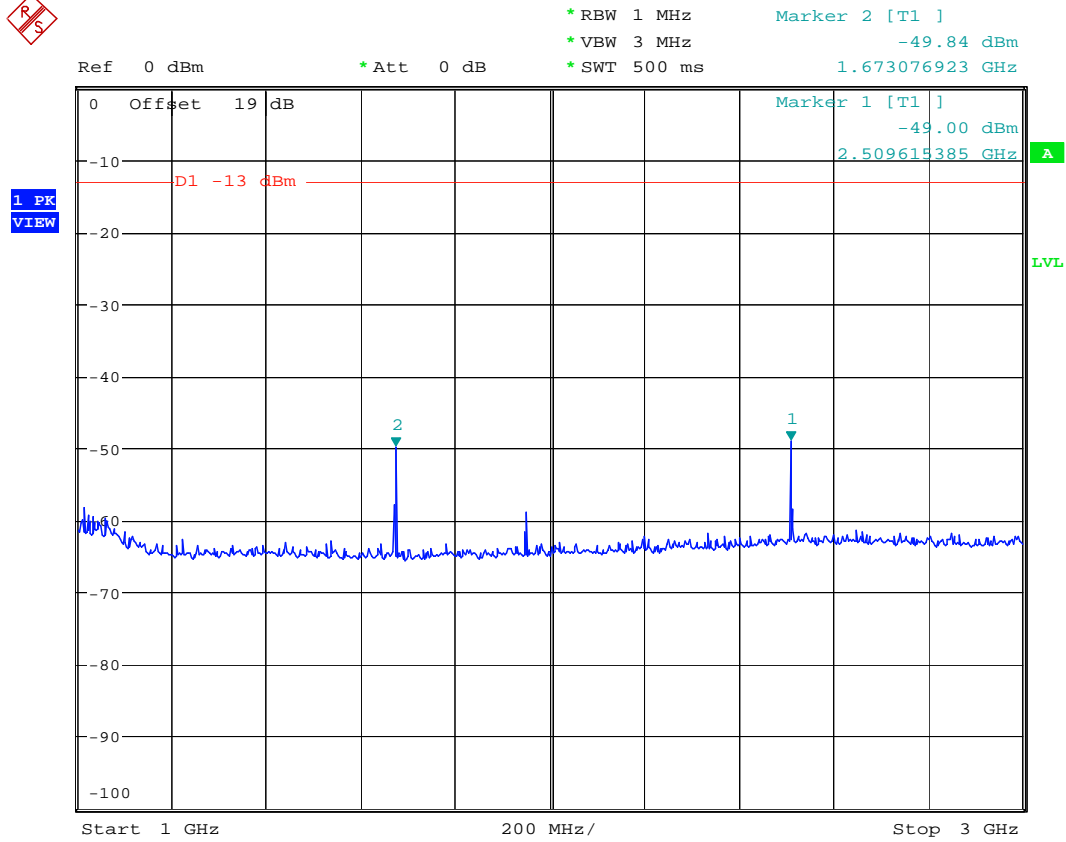

Date: 22.MAR.2007 20:38:58





- Test Mode : GSM850 CH189
- Frequency Range : 3G-7G

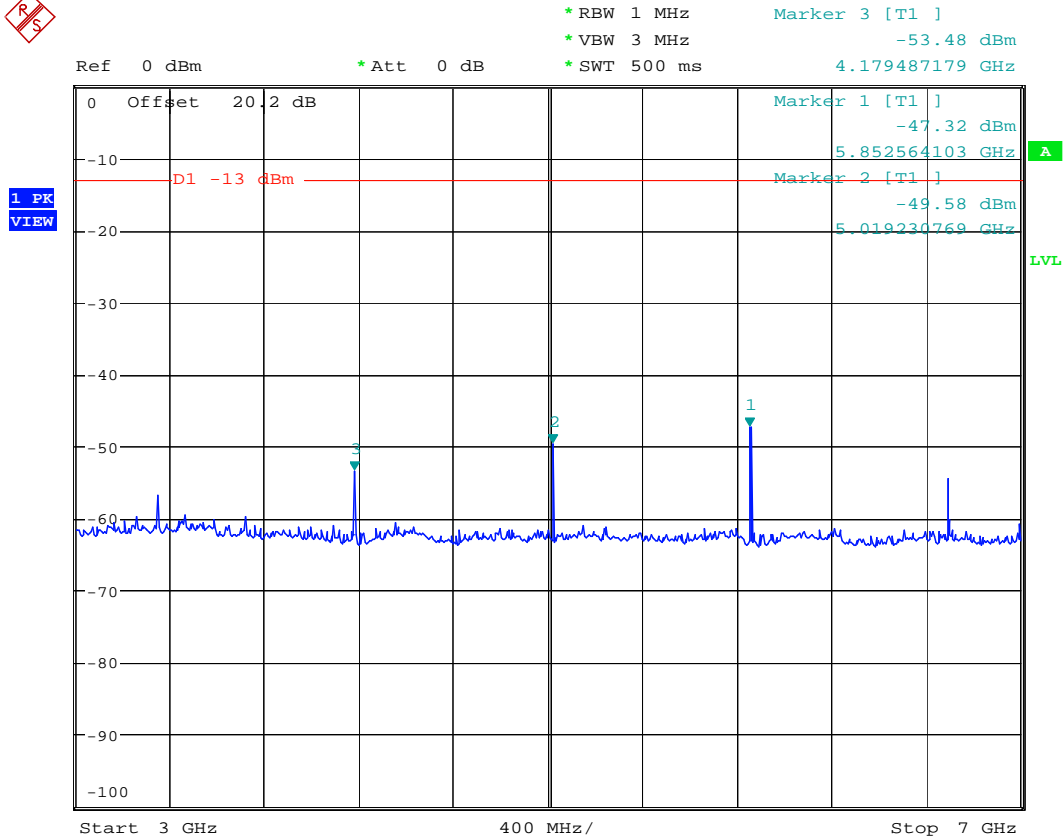

Date: 22.MAR.2007 20:40:56



- Test Mode : GSM850 CH189
- Frequency Range : 7G-9G

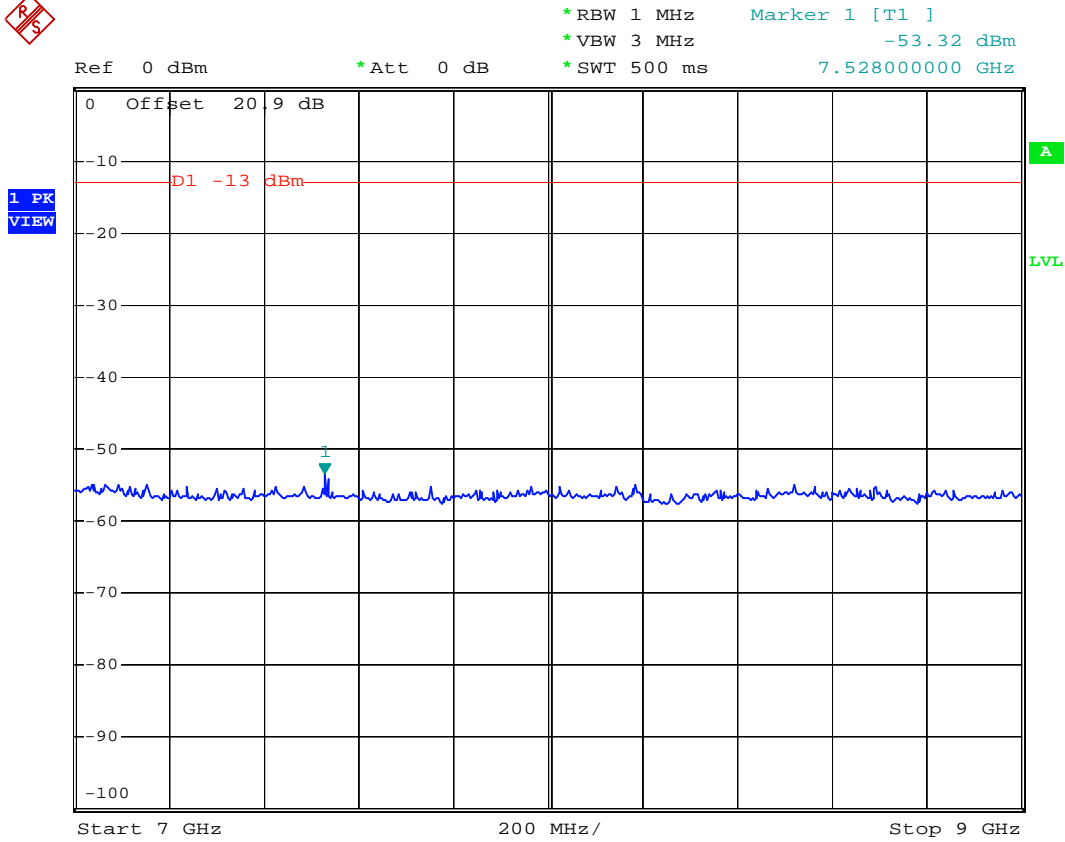

2nd comment ...

Date: 24.MAR.2007 00:49:35



- Mode 2
- Test Mode : PCS1900 CH661
- Frequency Range : 30M-1G

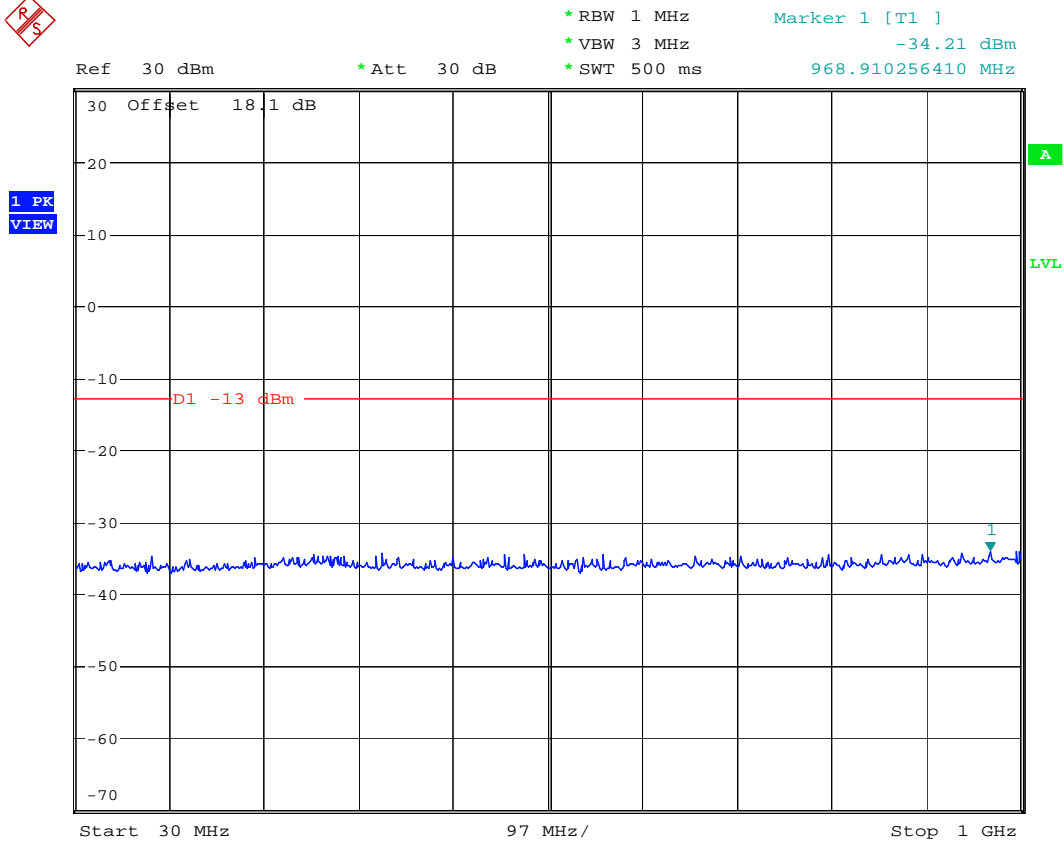

Date: 22.MAR.2007 20:32:46



- Test Mode : PCS1900 CH661
- Frequency Range : 1G-3G

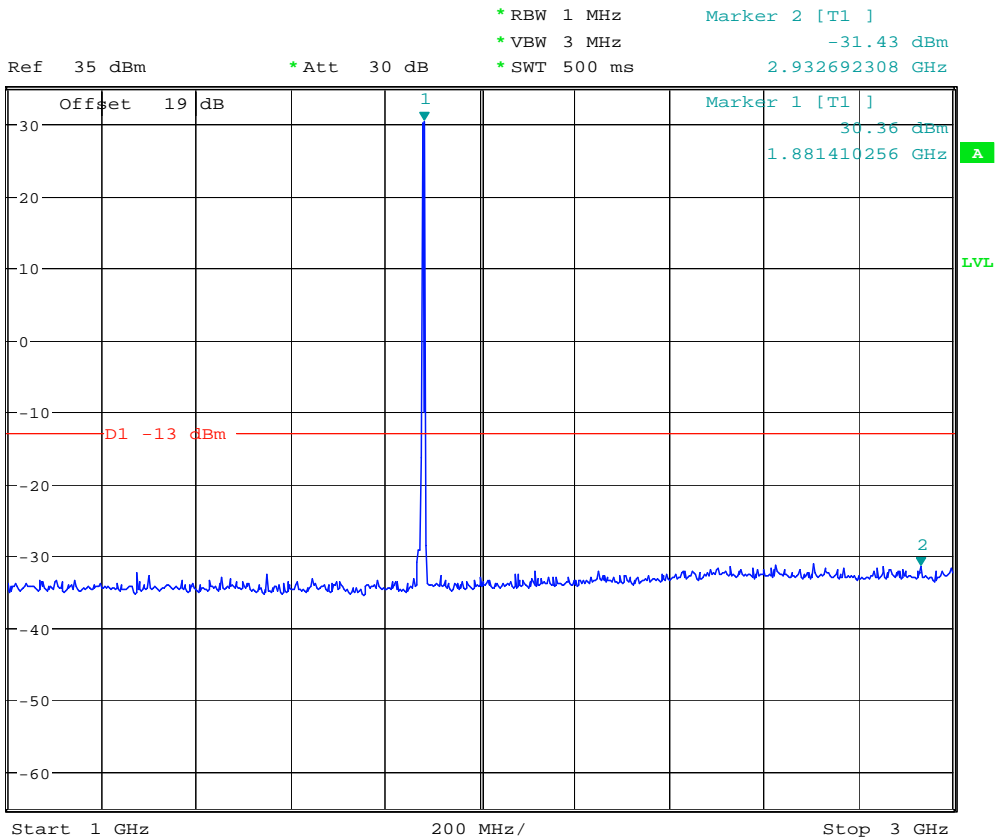

Date: 22.MAR.2007 20:31:13



- Test Mode : PCS1900 CH661
- Frequency Range : 3G-7G

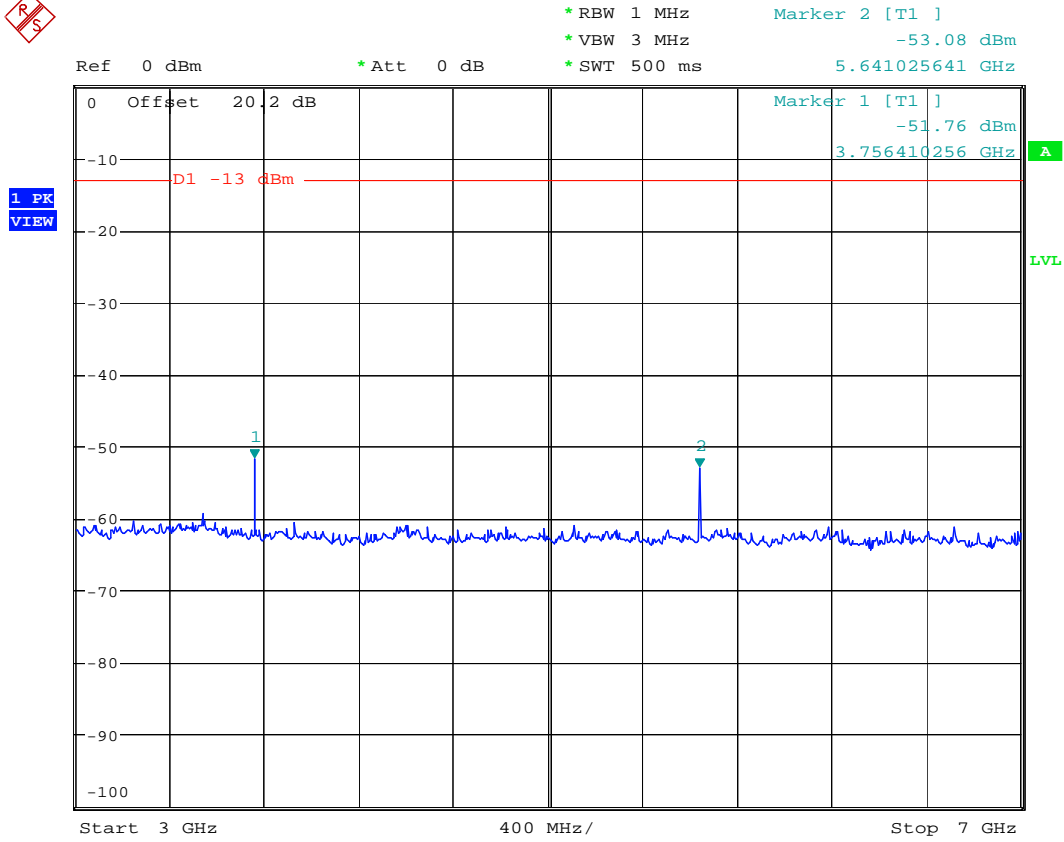

Date: 22.MAR.2007 20:29:31



- Test Mode : PCS1900 CH661
- Frequency Range : 7G-13.6G

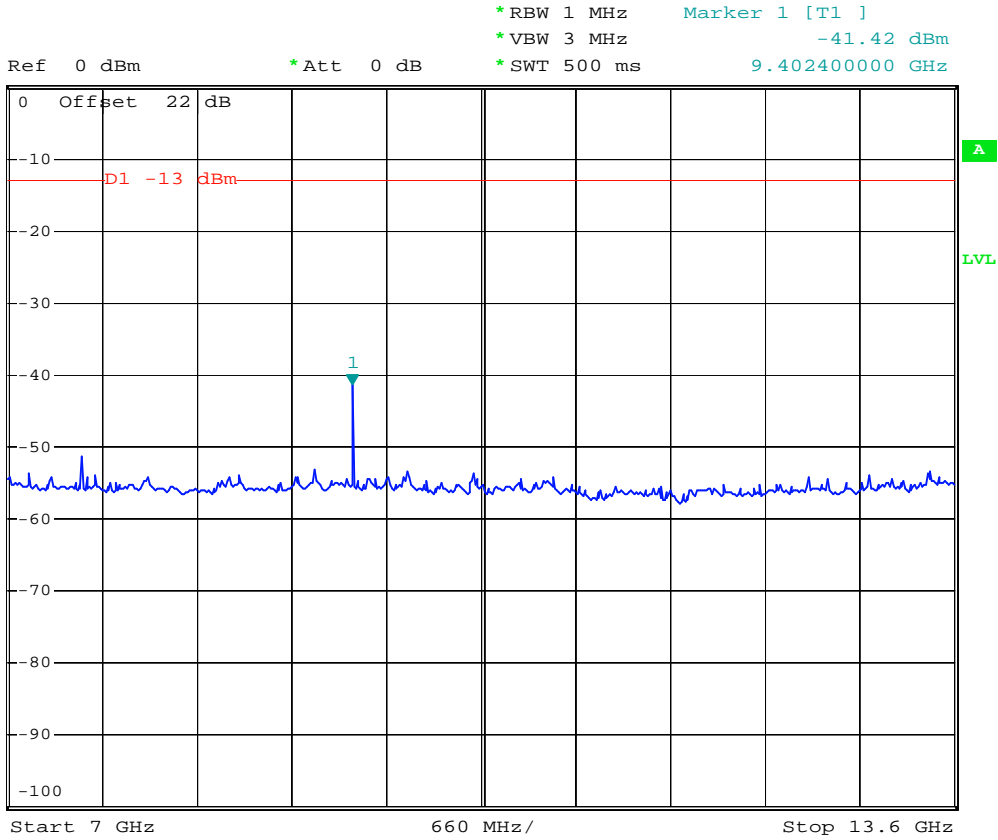

2nd comment ...

Date: 24.MAR.2007 00:50:58



- Test Mode : PCS1900 CH661
- Frequency Range : 13.6G-19.1G

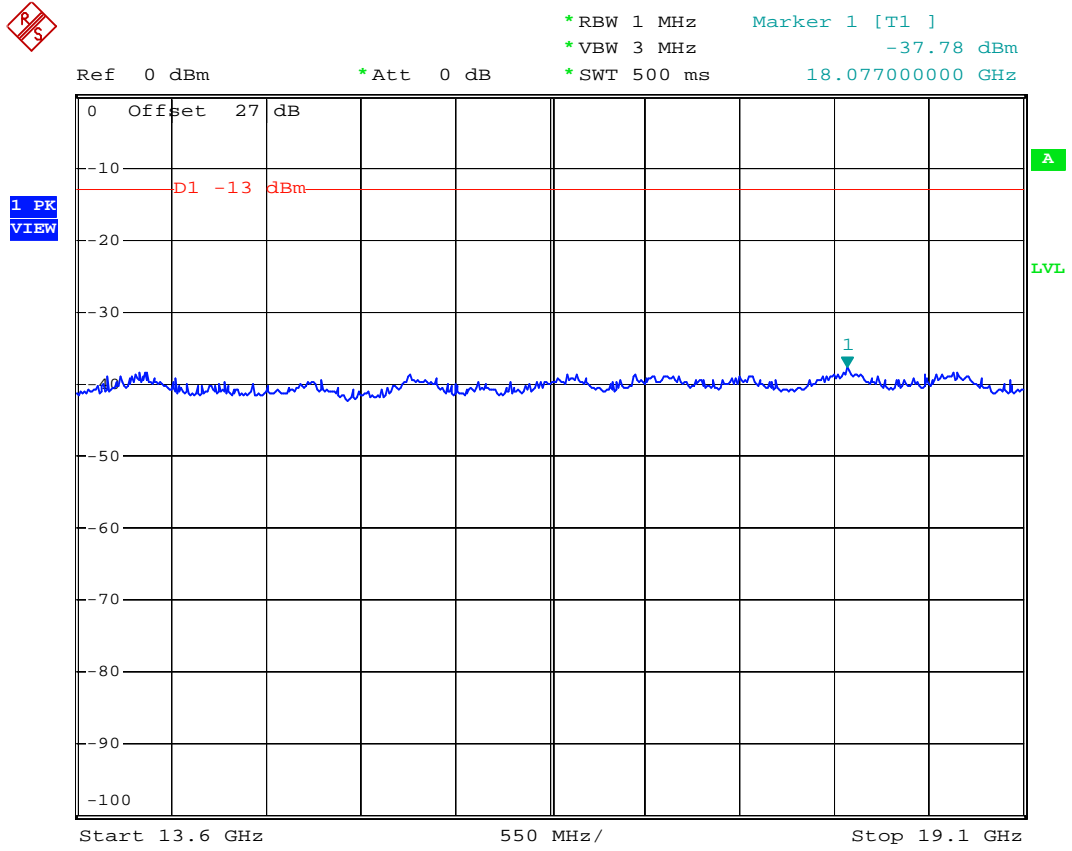

2nd comment ...

Date: 24.MAR.2007 00:52:18



## 4.6 Field Strength of Spurious Radiation

Equivalent isotropic radiated Power Measurements by substitution method according to ANSI/TIA/EIA-603-C.

### 4.6.1 Measurement Instruments

As described in chapter 5 of this test report.

### 4.6.2 Test Procedure

1. The EUT was placed on a rotatable wooden table with 0.8 meter about ground.
2. The EUT was set 3 meters from the receiving antenna which was mounted on the antenna tower.
3. The table was rotated 360 degrees to determine the position of the highest spurious emission.
4. The height of the receiving antenna is varied between one meter and four meters to reach the maximum spurious emission for both horizontal and vertical polarizations.
5. Taking the record of maximum spurious emission, Read level (dBm).
6. A substitution method is used at each frequencies .
7. The Substitution method is performed ahead of testing and saved to the test program,

The total correction factor is in the following formula.

$$\text{Factor}_{, \text{total correction}}(\text{dB}) = \text{Rs} - (\text{Ps} + \text{Gs})$$

Where Ps (dBm) : Input power to substitution antenna.

Gs (dBi or dBd) : Substitution antenna Gain.

Rs : The highest received signal in spectrum analyzer for substitution antenna.

8. The final measurement results are obtained as described below:

$$\text{Level (ERP/EIRP) (dBm)} = \text{Read level (dBm)} + \text{Factor}_{, \text{total correction}}(\text{dB})$$

Where Read level is receiver reading in unit, dBm, and the Factor, total correction is total correction factor including cable loss, preamplifier gain, receiver antenna gain and transmission loss through air path.



4.6.3 Test Setup Layout

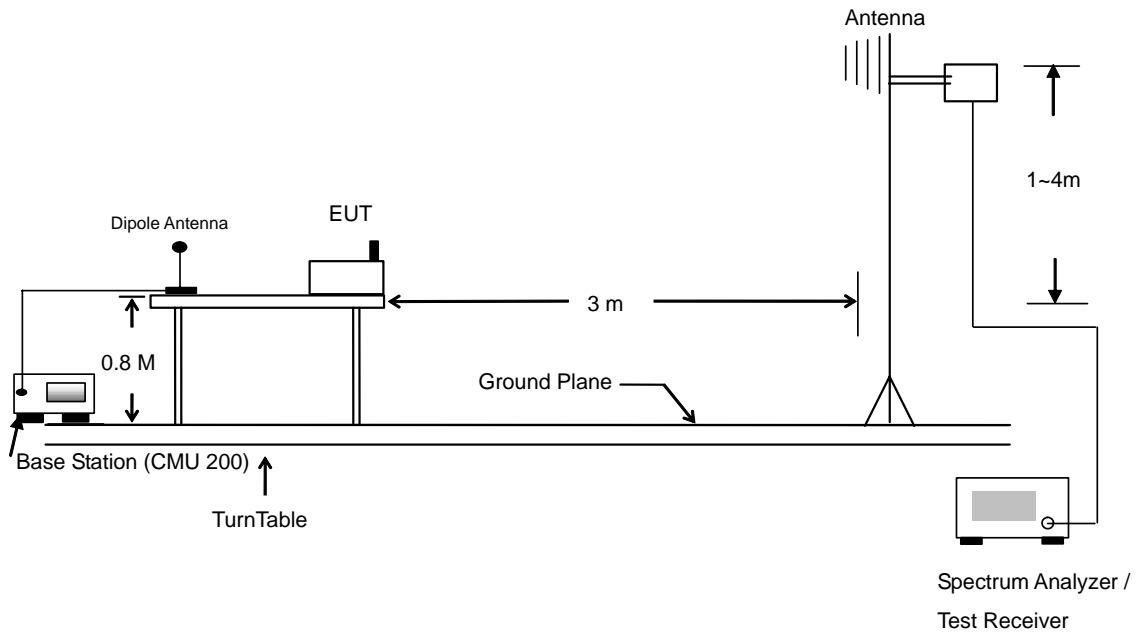



4.6.4 Test Result

- Test Mode : Mode 1

GSM850 Radiated Spurious ERP											
H Polarization						V Polarization					
Frequency (MHz)	EIRP (dBm)	Read Level (dbm)	Factor (db)	Limit (dBm)	Margin (dB)	Frequency (MHz)	EIRP (dBm)	Read Level (dbm)	Factor (db)	Limit (dBm)	Margin (dB)
70.23	-63.56	-49.06	-12.36	-13	-50.56	71.58	-51.58	-37.69	-11.74	-13	-38.58
106.14	-62.60	-48.14	-12.31	-13	-49.60	107.49	-53.40	-43.49	-7.76	-13	-40.40
144.48	-64.64	-49.74	-12.75	-13	-51.64	144.48	-59.65	-49.41	-8.09	-13	-46.65
418.30	-65.65	-57.25	-6.25	-13	-52.65	992.30	-63.06	-63.51	2.60	-13	-50.06
1674.00	-56.88	-54.95	0.22	-13	-43.88	1674.00	-55.73	-53.10	-0.48	-13	-42.73
2508.00	-57.04	-56.09	1.20	-13	-44.04	2508.00	-51.30	-51.42	2.27	-13	-38.30
3344.00	-50.95	-54.20	5.41	-13	-37.95	3344.00	-48.98	-51.29	4.47	-13	-35.98
3494.00	-53.29	-56.95	5.81	-13	-40.29	3494.00	-51.20	-53.92	4.87	-13	-38.20
3524.00	-50.42	-54.16	5.89	-13	-37.42	3524.00	-50.22	-52.99	4.93	-13	-37.22
5018.00	-52.31	-60.40	10.24	-13	-39.31	5018.00	-52.92	-59.62	8.85	-13	-39.92



- Test Mode : Mode 2

<b>PCS1900 Radiated Spurious EIRP</b>											
H Polarization						V Polarization					
Frequency (MHz)	EIRP (dBm)	Read Level (dbm)	Factor (db)	Limit (dBm)	Margin (dB)	Frequency (MHz)	EIRP (dBm)	Read Level (dbm)	Factor (db)	Limit (dBm)	Margin (dB)
30.00	-63.30	-63.66	0.36	-13	-50.30	71.58	-50.22	-38.47	-11.74	-13	-37.22
71.04	-61.65	-49.30	-12.35	-13	-48.65	106.14	-51.50	-43.75	-7.74	-13	-38.50
105.33	-59.66	-47.35	-12.31	-13	-46.66	143.13	-57.36	-49.28	-8.08	-13	-44.36
747.30	-63.27	-61.03	-2.24	-13	-50.27	714.40	-60.23	-60.01	-0.21	-13	-47.23
868.40	-63.26	-62.22	-1.03	-13	-50.26	833.40	-61.63	-62.96	1.33	-13	-48.63
990.90	-63.25	-63.41	0.16	-13	-50.25	976.90	-60.79	-63.27	2.47	-13	-47.79
1644.00	-50.98	-51.29	0.31	-13	-37.98	1644.00	-48.56	-48.10	-0.46	-13	-35.56
1724.00	-57.20	-57.28	0.08	-13	-44.20	1708.00	-54.68	-54.26	-0.42	-13	-41.68
2114.00	-50.17	-50.17	-0.01	-13	-37.17	2114.00	-49.33	-50.07	0.75	-13	-36.33
3758.00	-50.53	-58.45	7.92	-13	-37.53	3758.00	-49.81	-56.44	6.64	-13	-36.81
						3918.00	-51.63	-58.86	7.22	-13	-38.63
						9398.00	-41.14	-58.34	17.20	-13	-28.14



4.6.5 Test Data

4.6.5.1 Mode 1

Horizontal Polarization

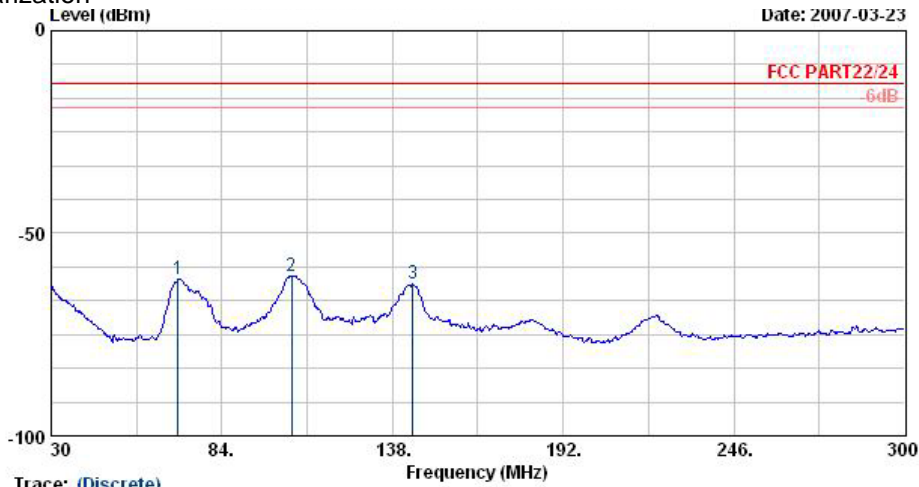

Trace: (Discrete)

Site : 03CH06-WY  
 Condition : LF-SPURIOUS HORIZONTAL  
 EUT : GSM Module  
 Power : 120Vac/60Hz  
 Model : FG 731404  
 Memo : GSM 650 Link;CH169+Adaptor

	Freq	Level	Over	Limit	Read		
	MHz	dBm	Limit	Line	Level	Factor	Remark
			dB	dBm	dBm	dB	
1	70.23	-61.41	-48.41	-13.00	-49.06	-12.36	Peak
2	106.14	-60.45	-47.45	-13.00	-48.14	-12.31	Peak
3	144.48	-62.49	-49.49	-13.00	-49.74	-12.75	Peak

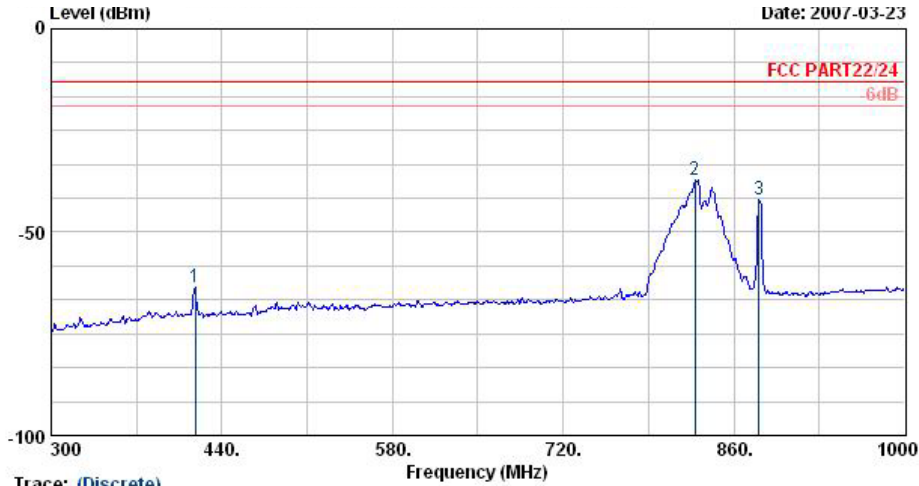

Trace: (Discrete)  
 Site : D3CH06-HY  
 Condition : LP-SPURIOUS HORIZONTAL  
 EUT : GSM Module  
 Power : 120Vac/60Hz  
 Model : FG 731404  
 Memo : GSM 850 Link;CHI80+Adaptor

	Freq	Level	Over	Limit	Read	Factor	Remark
	MHz	dBm	dB	dBm	dBm	dB	
1	418.30	-63.50	-50.50	-13.00	-57.25	-6.25	Peak
2 @	827.80	-37.14			-35.72	-1.43	Peak
3 @	880.30	-42.18			-41.27	-0.91	Peak

Remark:

- #2: MS Signal.
- #3: BS Signal.

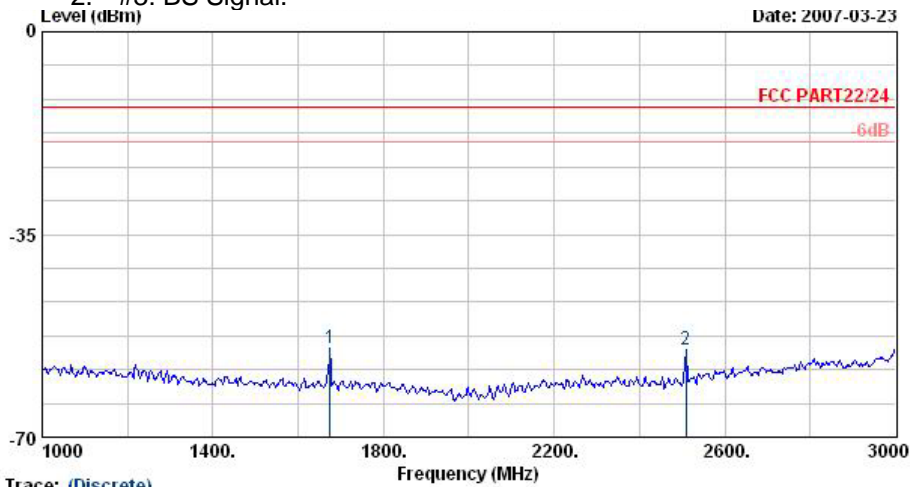

Trace: (Discrete)  
 Site : D3CH06-HY  
 Condition : HF-SPURIOUS HORIZONTAL  
 EUT : GSM Module  
 Power : 120Vac/60Hz  
 Model : FG 731404  
 Memo : GSM 850 Link;CHI80+Adaptor

	Freq	Level	Over	Limit	Read	Factor	Remark
	MHz	dBm	dB	dBm	dBm	dB	
1	1674.00	-54.73	-41.73	-13.00	-54.95	0.22	Peak
2	2508.00	-54.89	-41.89	-13.00	-56.09	1.20	Peak

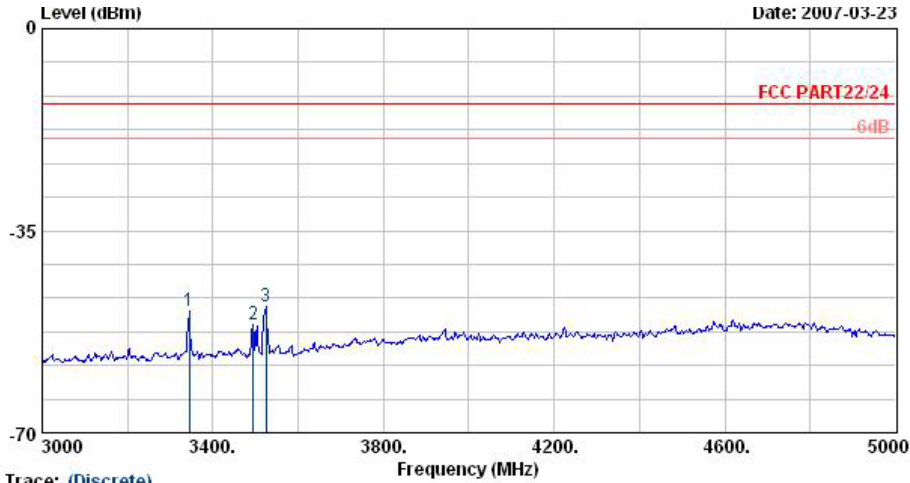

Trace: (Discrete)  
 Site : 03CH06-HY  
 Condition : HF-SPURIOUS HORIZONTAL  
 EUT : GSM Module  
 Power : 120Vac/60Hz  
 Model : FG 731404  
 Memo : GSM 650 Link;CHI69+Adaptor

	Freq	Level	Over	Limit	Read		
	MHz	dBm	Limit	Line	Level	Factor	Remark
			dB	dBm	dBm	dB	
1	3344.00	-48.80	-35.80	-13.00	-54.20	5.41	Peak
2	3494.00	-51.14	-38.14	-13.00	-56.95	5.81	Peak
3	3524.00	-48.27	-35.27	-13.00	-54.16	5.89	Peak

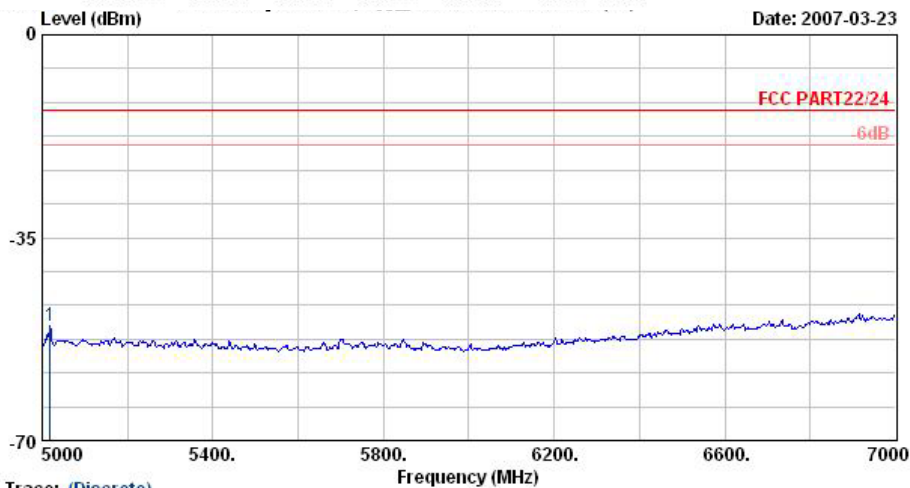

Trace: (Discrete)  
 Site : 03CH06-HY  
 Condition : HF-SPURIOUS HORIZONTAL  
 EUT : GSM Module  
 Power : 120Vac/60Hz  
 Model : FG 731404  
 Memo : GSM 650 Link;CHI69+Adaptor

	Freq	Level	Over	Limit	Read		
	MHz	dBm	Limit	Line	Level	Factor	Remark
			dB	dBm	dBm	dB	
1	5018.00	-50.16	-37.16	-13.00	-60.40	10.24	Peak

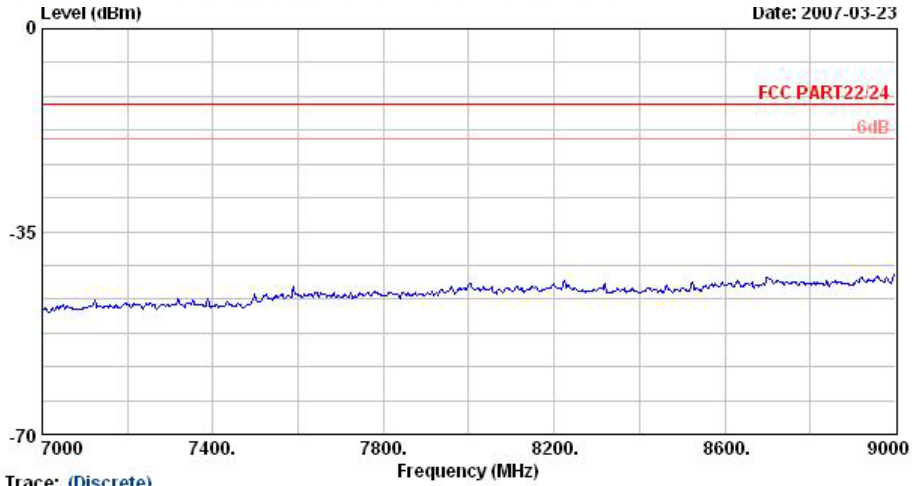

Trace: (Discrete)  
Site : 03CH06-HY  
Condition : HF-SPURIOUS HORIZONTAL  
EUT : GSM Module  
Power : 120Vac/60Hz  
Model : FG 731404  
Memo : GSM 850 Link;CHI 80+Adaptor

Remark: There's no more obvious spurious emission except the listings above.



Vertical Polarization

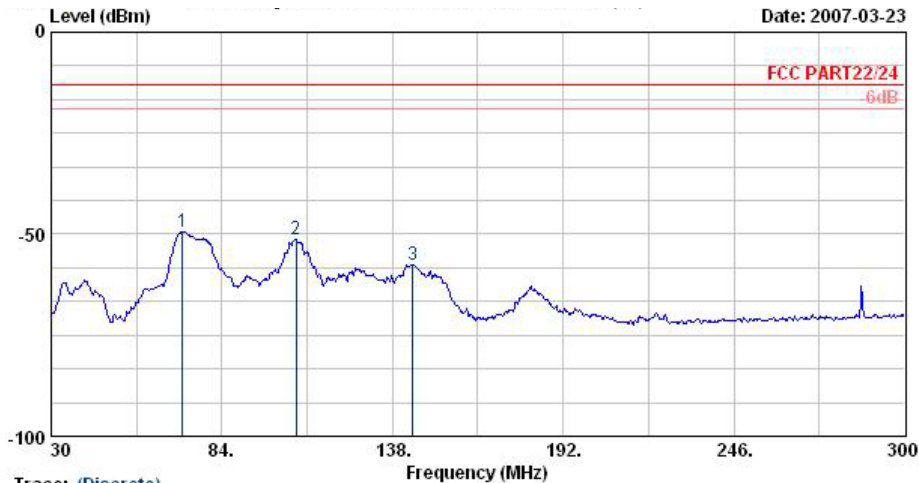

Site :  
 Condition :  
 EUT :  
 Power :  
 Model :  
 Memo :

Trace: (Discrete)

: 03CH06-WY  
 : LF-SPURIOUS VERTICAL  
 : GSM Module  
 : 120Vac/60Hz  
 : FG 731404  
 : GSM 850 Link;CHI89+Adaptor

	Freq	Level	Over	Limit	Read	Factor	Remark
	MHz	dBm	dB	dBm	dBm	dB	
1	71.58	-49.43	-36.43	-13.00	-37.69	-11.74	Peak
2	107.49	-51.25	-38.25	-13.00	-43.49	-7.76	Peak
3	144.48	-57.50	-44.50	-13.00	-49.41	-8.09	Peak

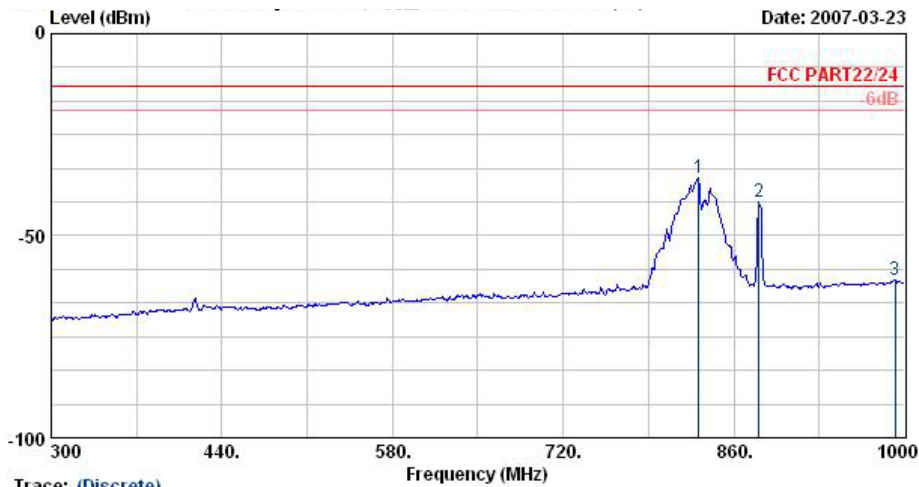

Site :  
 Condition :  
 EUT :  
 Power :  
 Model :  
 Memo :

Trace: (Discrete)

: 03CH06-WY  
 : LF-SPURIOUS VERTICAL  
 : GSM Module  
 : 120Vac/60Hz  
 : FG 731404  
 : GSM 850 Link;CHI89+Adaptor

	Freq	Level	Over	Limit	Read	Factor	Remark
	MHz	dBm	dB	dBm	dBm	dB	
1 @	831.30	-35.74	-22.74	-13.00	-37.06	1.32	Peak
2 @	880.30	-41.80			-43.51	1.71	Peak
3	992.30	-60.91			-63.51	2.60	Peak

Remark:

- #2: MS Signal.
- #3: BS Signal.



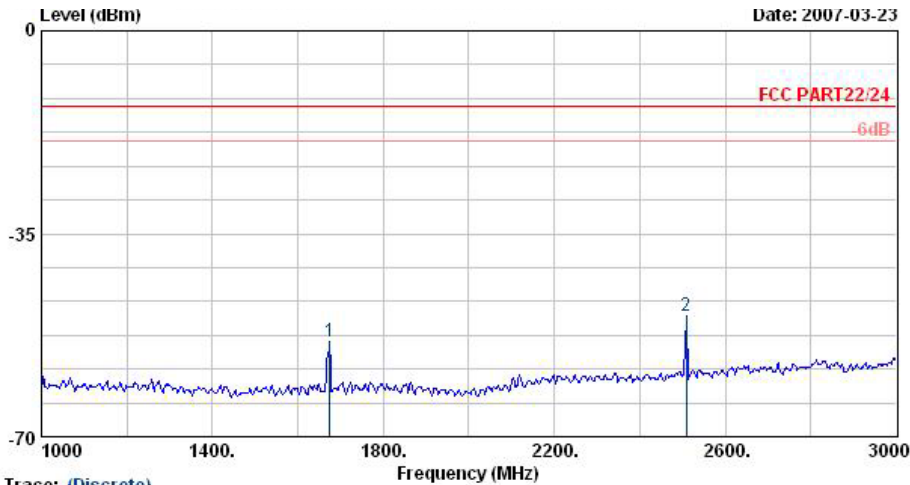

Trace: (Discrete)

Site : 03CH06-HY  
 Condition : HF-SPURIOUS VERTICAL  
 EUT : GSM Module  
 Power : 120Vac/60Hz  
 Model : FG 731404  
 Memo : GSM 850 Link;CHI80+Adaptor

	Freq	Level	Over	Limit	Read	Factor	Remark
	MHz	dBm	Limit	Line	Level	dB	
1	1674.00	-53.58	-40.58	-13.00	-53.10	-0.48	Peak
2	2508.00	-49.15	-36.15	-13.00	-51.42	2.27	Peak

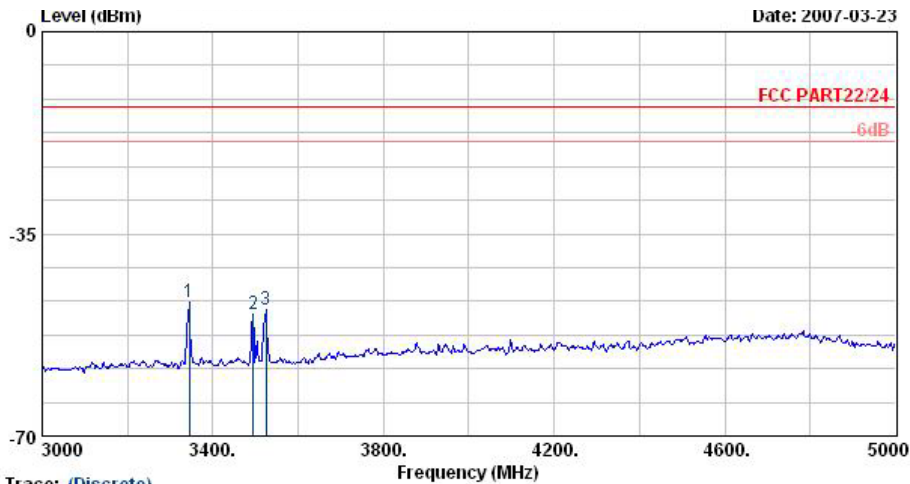

Trace: (Discrete)

Site : 03CH06-HY  
 Condition : HF-SPURIOUS VERTICAL  
 EUT : GSM Module  
 Power : 120Vac/60Hz  
 Model : FG 731404  
 Memo : GSM 850 Link;CHI80+Adaptor

	Freq	Level	Over	Limit	Read	Factor	Remark
	MHz	dBm	Limit	Line	Level	dB	
1 @	3344.00	-46.83	-33.83	-13.00	-51.29	4.47	Peak
2	3494.00	-49.05	-36.05	-13.00	-53.92	4.87	Peak
3	3524.00	-48.07	-35.07	-13.00	-52.99	4.93	Peak

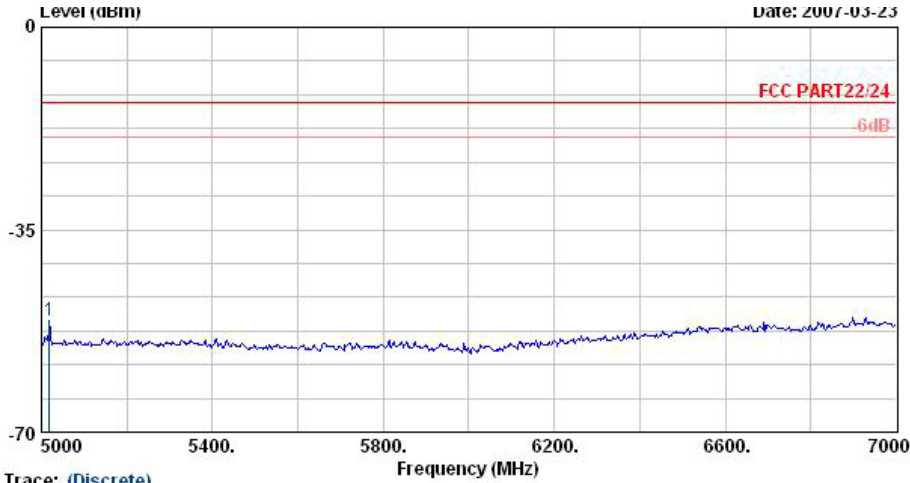

Trace: (Discrete)  
 Site : 03CH06-HY  
 Condition : HF-SPURIOUS VERTICAL  
 EUT : GSM Module  
 Power : 120Vac/60Hz  
 Model : FG 731404  
 Memo : GSM 850 Link;CH189+Adaptor

	Freq	Level	Over	Limit	Read	Factor	Remark
	MHz	dBm	dB	dBm	dBm	dB	
1	5018.00	-59.77	-37.77	-13.00	-59.62	8.85	Peak

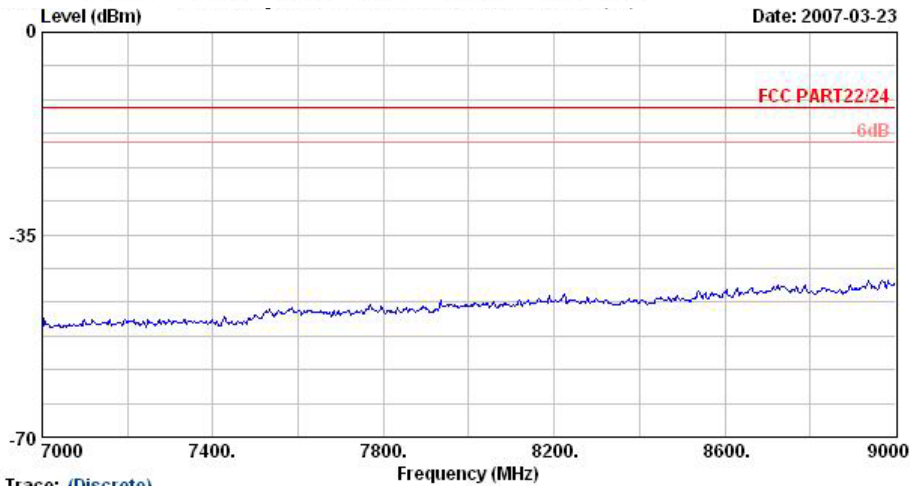

Trace: (Discrete)  
 Site : 03CH06-HY  
 Condition : HF-SPURIOUS VERTICAL  
 EUT : GSM Module  
 Power : 120Vac/60Hz  
 Model : FG 731404  
 Memo : GSM 850 Link;CH189+Adaptor

Remark : There is no more obvious emission except the listings above.



4.6.5.2 Mode 2  
Horizontal Polarization

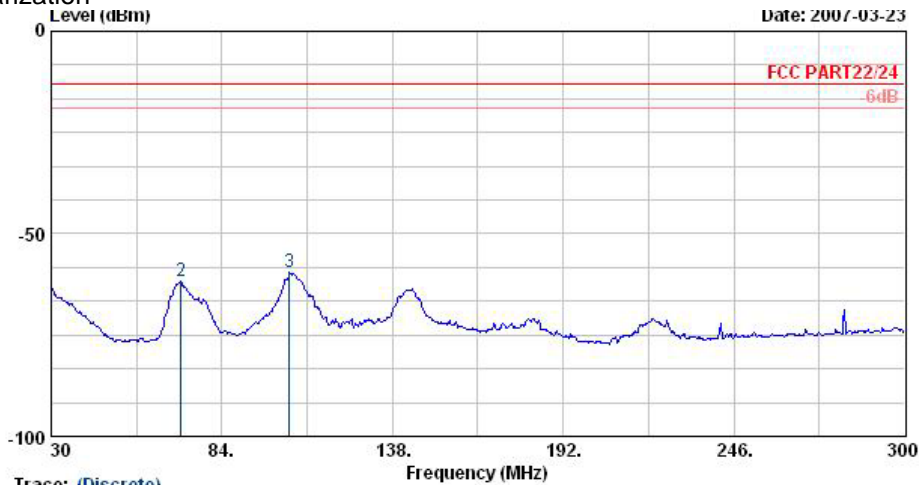

Trace: (Discrete)  
 Site : 03CH06-HY  
 Condition : LF-SPURIOUS HORIZONTAL  
 EUT : GSM Module  
 Power : 120Vac/60Hz  
 Model : FG 731404  
 Memo : PCS 1900 Link;CH661+Adaptor

	Freq	Level	Over	Limit	Read		
	MHz	dBm	Limit	Line	Level	Factor	Remark
			dB	dBm	dBm	dB	
1	30.00	-63.30	-50.30	-13.00	-63.66	0.36	Peak
2	71.04	-61.65	-48.65	-13.00	-49.30	-12.35	Peak
3	105.33	-59.66	-46.66	-13.00	-47.35	-12.31	Peak

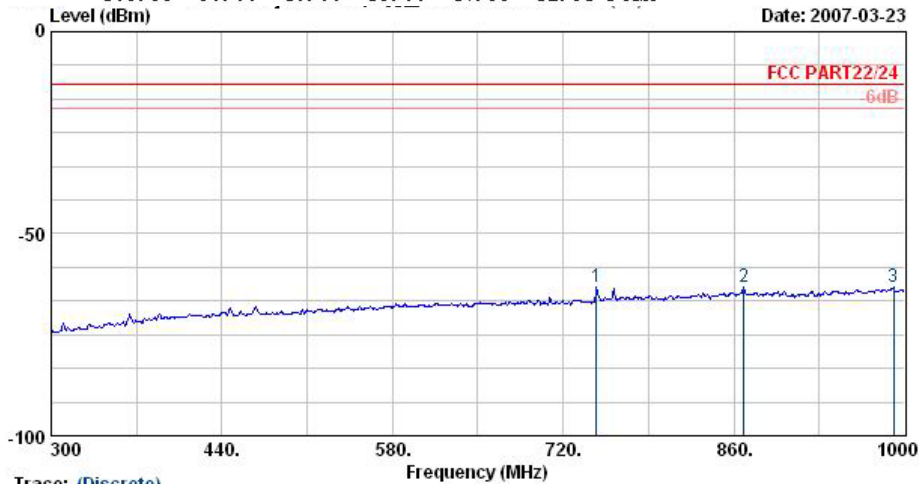

Trace: (Discrete)  
 Site : 03CH06-HY  
 Condition : LF-SPURIOUS HORIZONTAL  
 EUT : GSM Module  
 Power : 120Vac/60Hz  
 Model : FG 731404  
 Memo : PCS 1900 Link;CH661+Adaptor

	Freq	Level	Over	Limit	Read		
	MHz	dBm	Limit	Line	Level	Factor	Remark
			dB	dBm	dBm	dB	
1	747.30	-63.27	-50.27	-13.00	-61.03	-2.24	Peak
2	868.40	-63.26	-50.26	-13.00	-62.22	-1.03	Peak
3	990.90	-63.25	-50.25	-13.00	-63.41	0.16	Peak

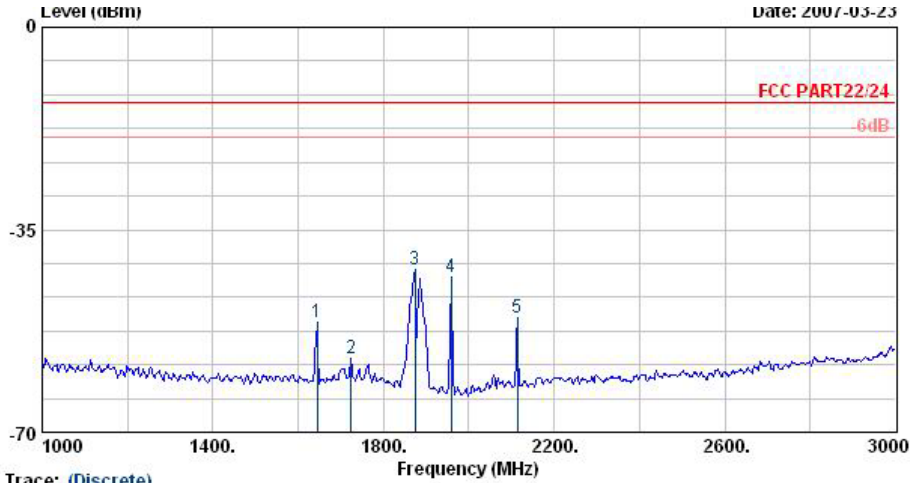

Trace: (Discrete)  
 Site : 03CH06-HY  
 Condition : HF-SPURIOUS HORIZONTAL  
 EUT : GSM Module  
 Power : 120Vac/60Hz  
 Model : FG 731404  
 Memo : PCS 1900 Link;CH661+Adaptor

	Freq	Level	Over	Limit	Read		
	MHz	dBm	Limit	Line	Level	Factor	Remark
			dB	dBm	dBm	dB	
1	1644.00	-50.98	-37.98	-13.00	-51.29	0.31	Peak
2	1724.00	-57.20	-44.20	-13.00	-57.28	0.08	Peak
3	1874.00	-41.82			-41.31	-0.51	Peak
4	1958.00	-43.17			-42.06	-1.11	Peak
5	2114.00	-50.17	-37.17	-13.00	-50.17	-0.01	Peak

Remark:

- #3: MS Signal.
- #4: BS Signal.

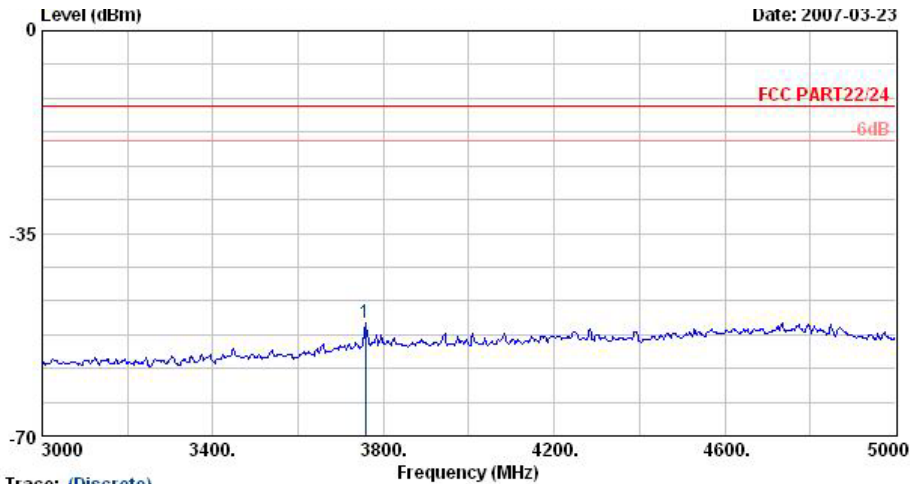

Trace: (Discrete)  
 Site : 03CH06-HY  
 Condition : HF-SPURIOUS HORIZONTAL  
 EUT : GSM Module  
 Power : 120Vac/60Hz  
 Model : FG 731404  
 Memo : PCS 1900 Link;CH661+Adaptor

	Freq	Level	Over	Limit	Read		
	MHz	dBm	Limit	Line	Level	Factor	Remark
			dB	dBm	dBm	dB	
1	3758.00	-50.53	-37.53	-13.00	-58.45	7.92	Peak

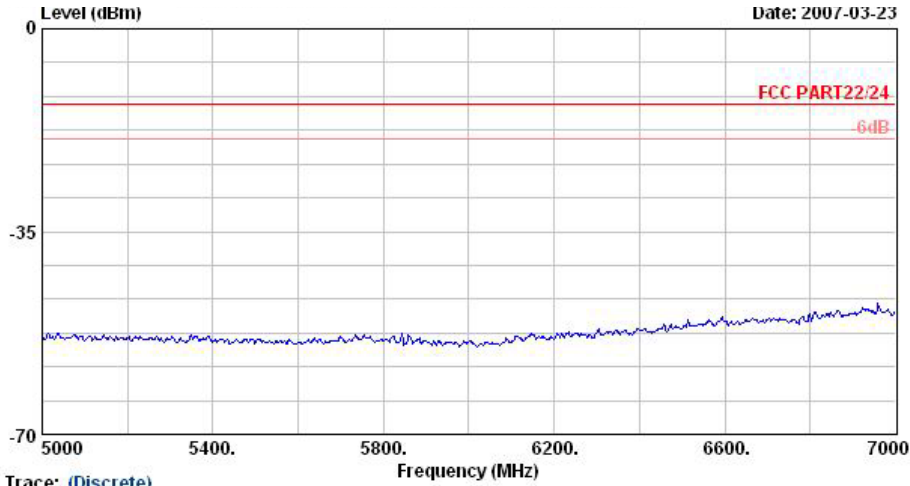

Trace: (Discrete)  
Site : 03CH06-HY  
Condition : HF-SPURIOUS HORIZONTAL  
EUT : GSM Module  
Power : 120Vac/60Hz  
Model : FG 731404  
Memo : PCS 1900 Link;CH661+Adaptor

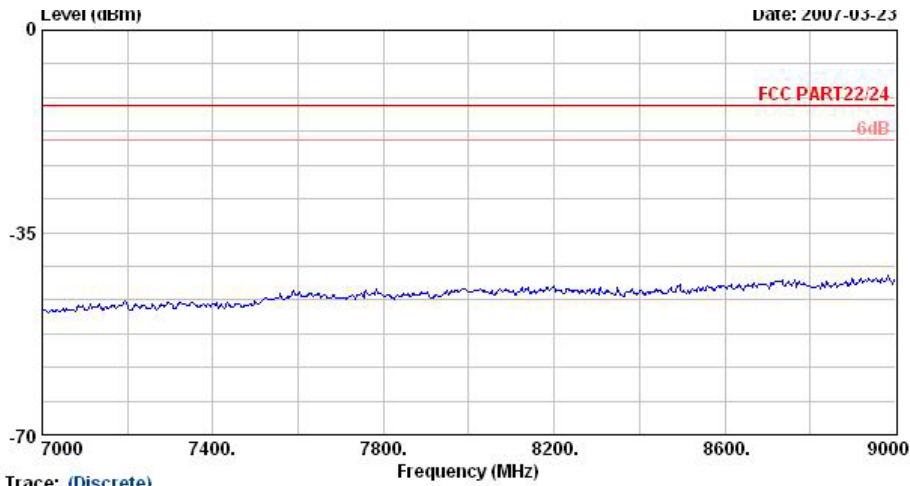

Trace: (Discrete)  
Site : 03CH06-HY  
Condition : HF-SPURIOUS HORIZONTAL  
EUT : GSM Module  
Power : 120Vac/60Hz  
Model : FG 731404  
Memo : PCS 1900 Link;CH661+Adaptor

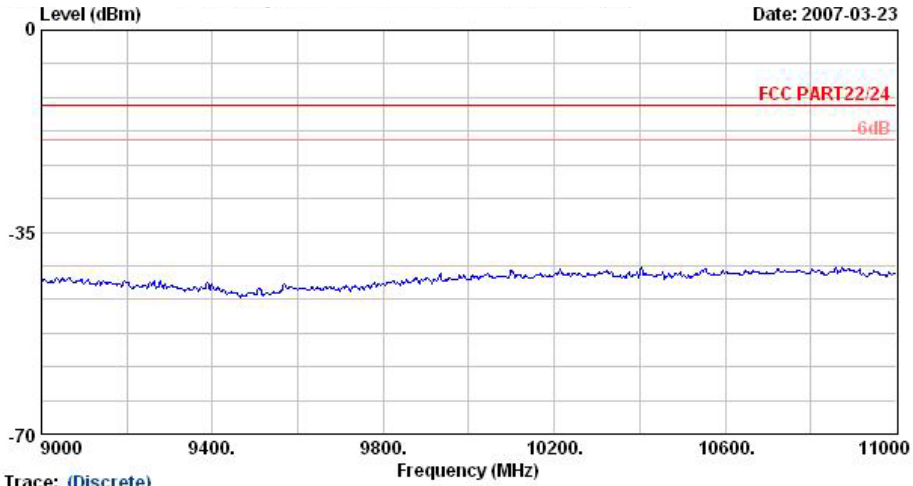

Date: 2007-03-23

Trace: (Discrete)

Site : 03CH06-HY  
Condition : HF-SPURIOUS HORIZONTAL  
EUT : GSM Module  
Power : 120Vac/60Hz  
Model : FG 731404  
Memo : PCS 1900 Link;CH661+Adaptor

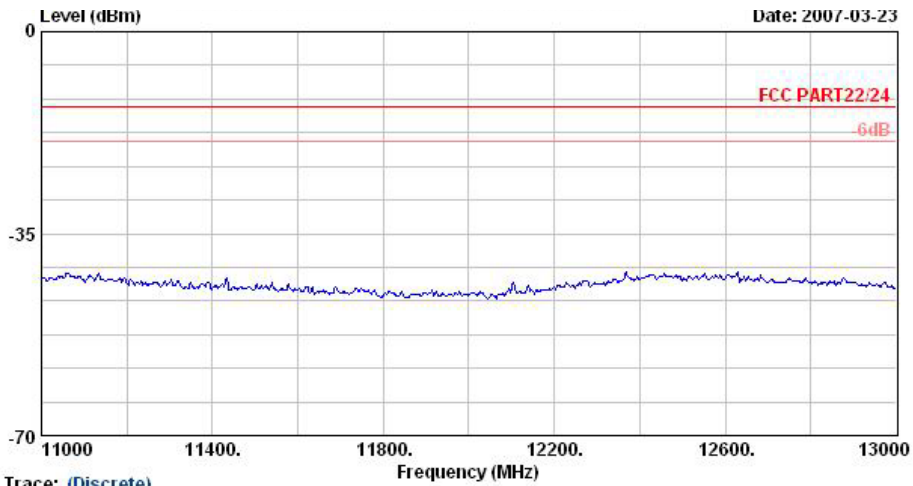

Date: 2007-03-23

Trace: (Discrete)

Site : 03CH06-HY  
Condition : HF-SPURIOUS HORIZONTAL  
EUT : GSM Module  
Power : 120Vac/60Hz  
Model : FG 731404  
Memo : PCS 1900 Link;CH661+Adaptor

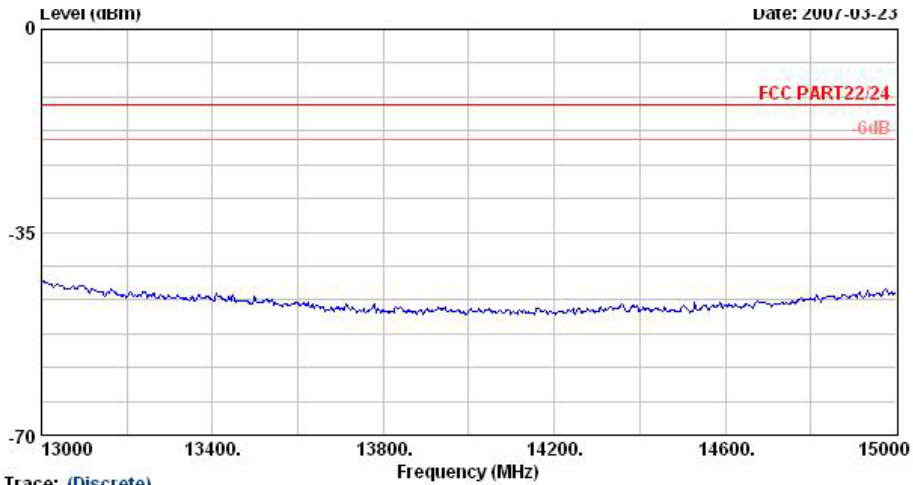

Trace: (Discrete)  
Site : 03CH06-HY  
Condition : HF-SPURIOUS HORIZONTAL  
EUT : GSM Module  
Power : 120Vac/60Hz  
Model : FG 731404  
Memo : PCS 1900 Link;CH661+Adaptor

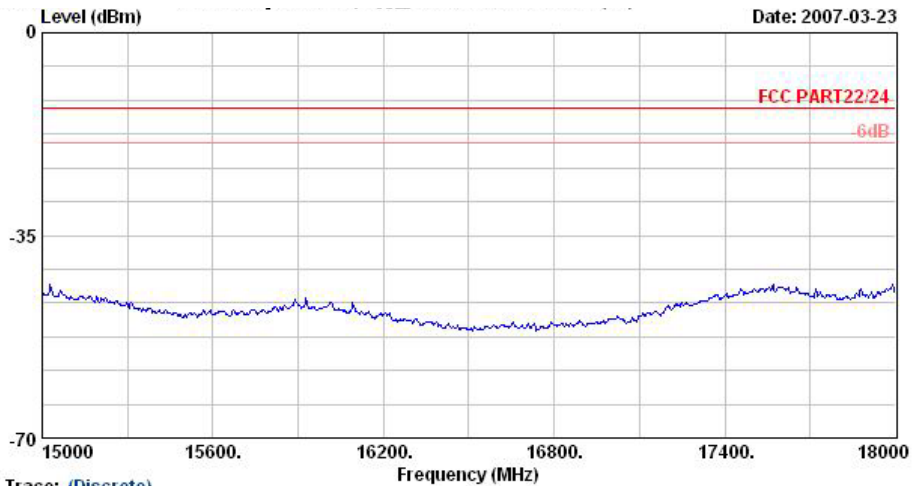

Trace: (Discrete)  
Site : 03CH06-HY  
Condition : HF-SPURIOUS HORIZONTAL  
EUT : GSM Module  
Power : 120Vac/60Hz  
Model : FG 731404  
Memo : PCS 1900 Link;CH661+Adaptor

Remark: There's no more obvious spurious emission except the listings above.





Vertical Polarization

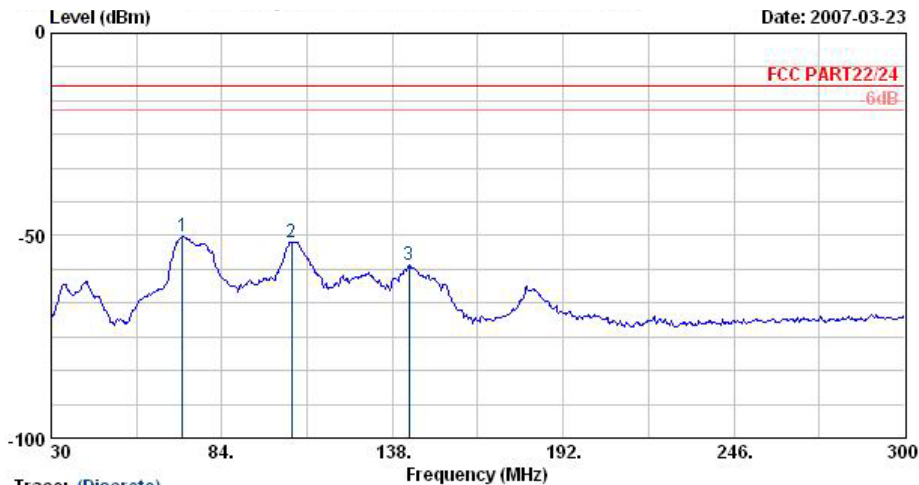

Site :  
 Condition :  
 EUT :  
 Power :  
 Model :  
 Memo :

Trace: (Discrete)

: 03CH06-HY  
 : LF-SPURIOUS VERTICAL  
 : GSM Module  
 : 120Vac/60Hz  
 : FG 731404  
 : PCS 1900 Link;CH661+Adaptor

	Freq	Level	Over	Limit	Read	Factor	Remark
	MHz	dBm	Limit	Line	Level	dB	
1	71.58	-50.22	-37.22	-13.00	-38.47	-11.74	Peak
2	106.14	-51.50	-38.50	-13.00	-43.75	-7.74	Peak
3	143.13	-57.36	-44.36	-13.00	-49.28	-8.08	Peak

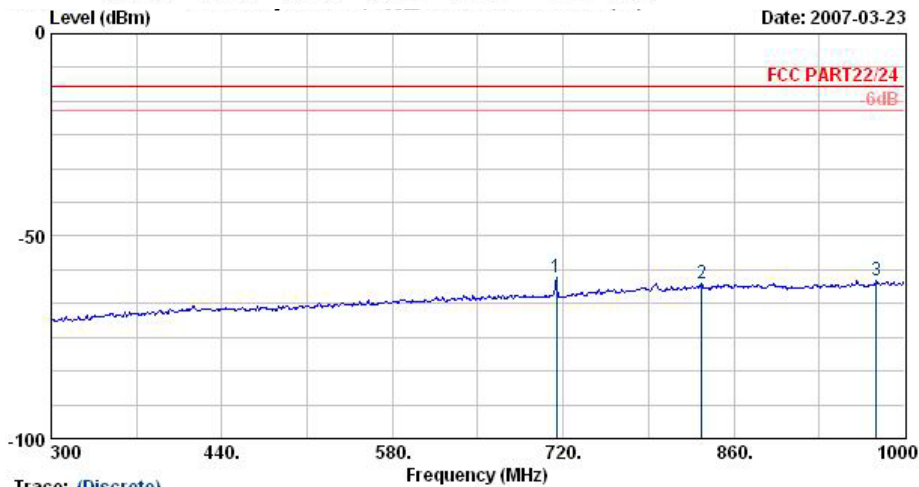

Site :  
 Condition :  
 EUT :  
 Power :  
 Model :  
 Memo :

Trace: (Discrete)

: 03CH06-HY  
 : LF-SPURIOUS VERTICAL  
 : GSM Module  
 : 120Vac/60Hz  
 : FG 731404  
 : PCS 1900 Link;CH661+Adaptor

	Freq	Level	Over	Limit	Read	Factor	Remark
	MHz	dBm	Limit	Line	Level	dB	
1	714.40	-60.23	-47.23	-13.00	-60.01	-0.21	Peak
2	833.40	-61.63	-48.63	-13.00	-62.96	1.33	Peak
3	976.90	-60.79	-47.79	-13.00	-63.27	2.47	Peak



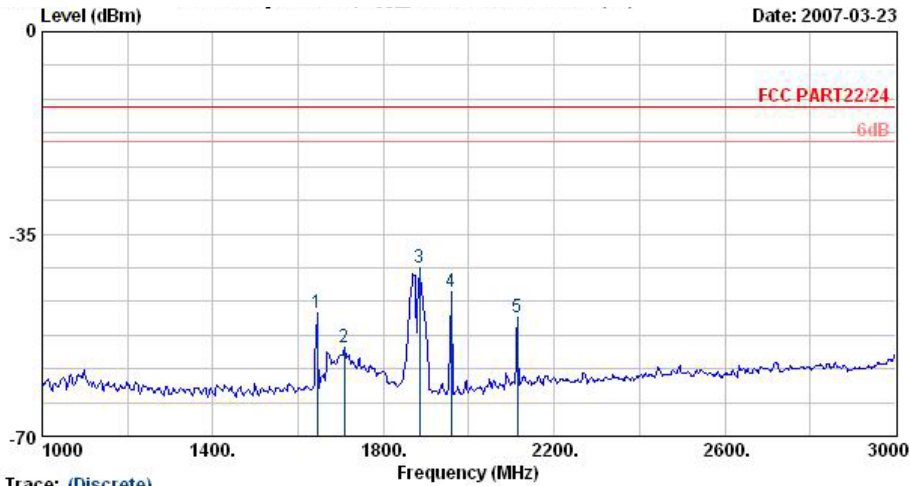

Date: 2007-03-23

Trace: (Discrete)

Site : 03CH06-HY  
 Condition : HF-SPURIOUS VERTICAL  
 EUT : GSM Module  
 Power : 120Vac/60Hz  
 Model : FG 731404  
 Memo : PCS 1900 Link;CH661+Adaptor

	Freq	Level	Over	Limit	Read	Factor	Remark
	MHz	dBm	dB	dBm	dBm	dB	
1	1644.00	-48.56	-35.56	-13.00	-48.10	-0.46	Peak
2	1708.00	-54.68	-41.68	-13.00	-54.26	-0.42	Peak
3 @	1884.00	-40.88			-40.38	-0.50	Peak
4	1958.00	-45.02			-44.43	-0.60	Peak
5	2114.00	-49.33	-36.33	-13.00	-50.07	0.75	Peak

Remark:

- #3: MS Signal.
- #4: BS Signal.

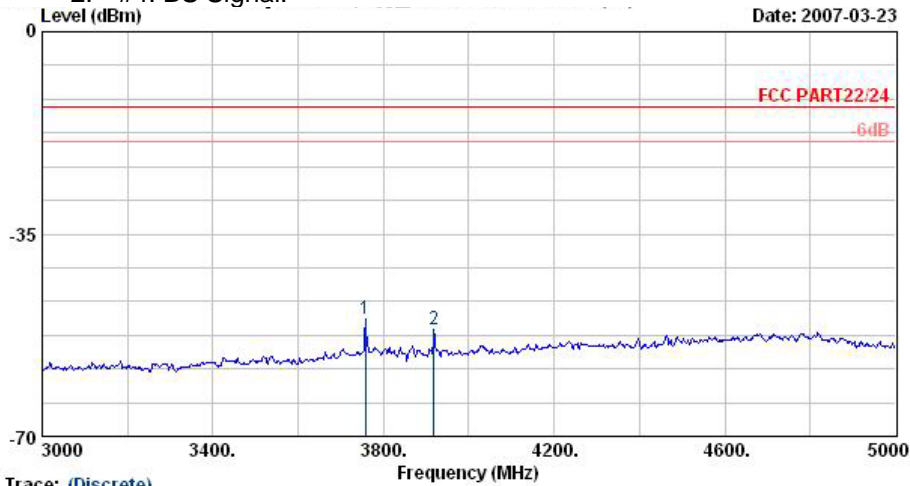

Date: 2007-03-23

Trace: (Discrete)

Site : 03CH06-HY  
 Condition : HF-SPURIOUS VERTICAL  
 EUT : GSM Module  
 Power : 120Vac/60Hz  
 Model : FG 731404  
 Memo : PCS 1900 Link;CH661+Adaptor

	Freq	Level	Over	Limit	Read	Factor	Remark
	MHz	dBm	dB	dBm	dBm	dB	
1	3758.00	-49.81	-36.81	-13.00	-56.44	6.64	Peak
2	3918.00	-51.63	-38.63	-13.00	-58.86	7.22	Peak

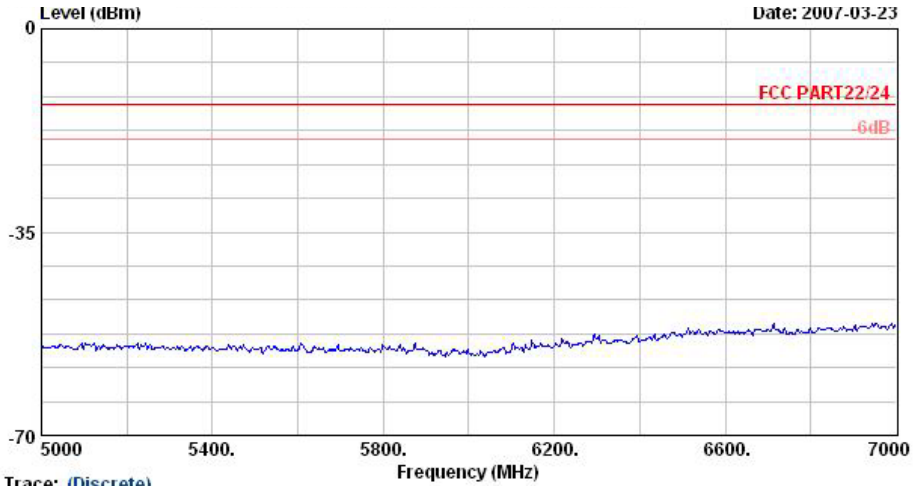

Trace: (Discrete)  
Site : 03CH06-HY  
Condition : HF-SPURIOUS VERTICAL  
EUT : GSM Module  
Power : 120Vac/60Hz  
Model : FG 731404  
Memo : PCS 1900 Link;CH661+Adaptor

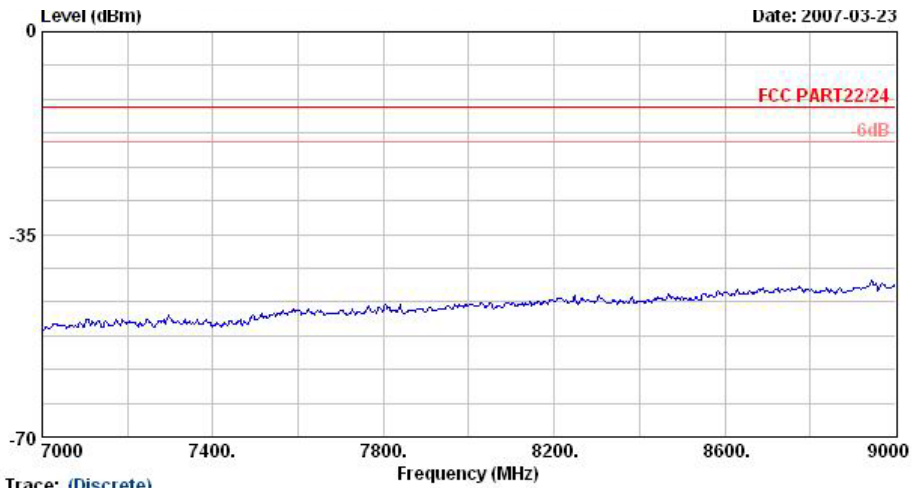

Trace: (Discrete)  
Site : 03CH06-HY  
Condition : HF-SPURIOUS VERTICAL  
EUT : GSM Module  
Power : 120Vac/60Hz  
Model : FG 731404  
Memo : PCS 1900 Link;CH661+Adaptor

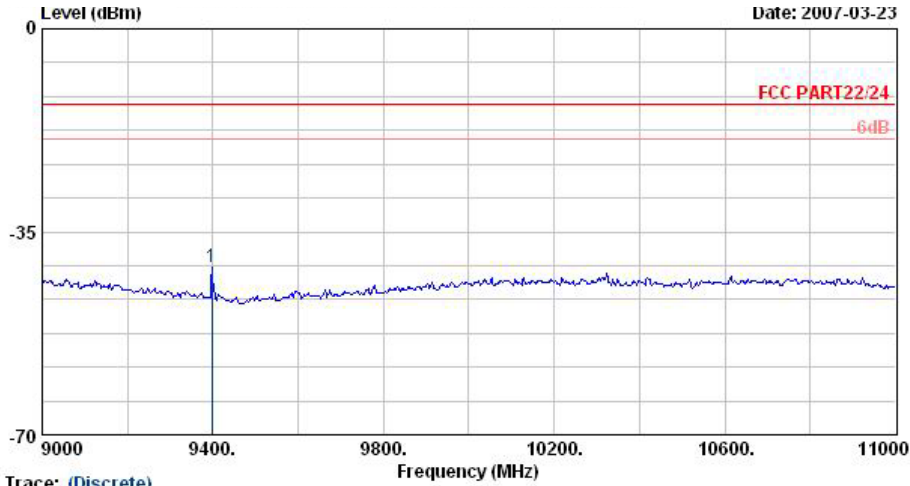

Trace: (Discrete)

Site : 03CH06-HY  
 Condition : HF-SPURIOUS VERTICAL  
 EUT : GSM Module  
 Power : 120Vac/60Hz  
 Model : FG 731404  
 Memo : PCS 1900 Link;CH661+Adaptor

Freq	Level	Over	Limit	Read	Factor	Remark
MHz	dBm	dB	dBm	dBm	dB	

1 @	9398.00	-41.14	-28.14	-13.00	-58.34	17.20 Peak
-----	---------	--------	--------	--------	--------	------------

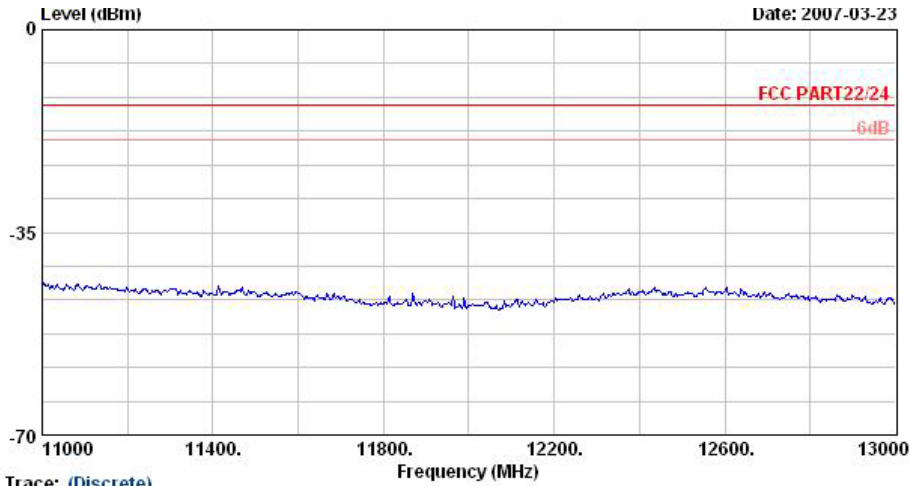

Trace: (Discrete)

Site : 03CH06-HY  
 Condition : HF-SPURIOUS VERTICAL  
 EUT : GSM Module  
 Power : 120Vac/60Hz  
 Model : FG 731404  
 Memo : PCS 1900 Link;CH661+Adaptor

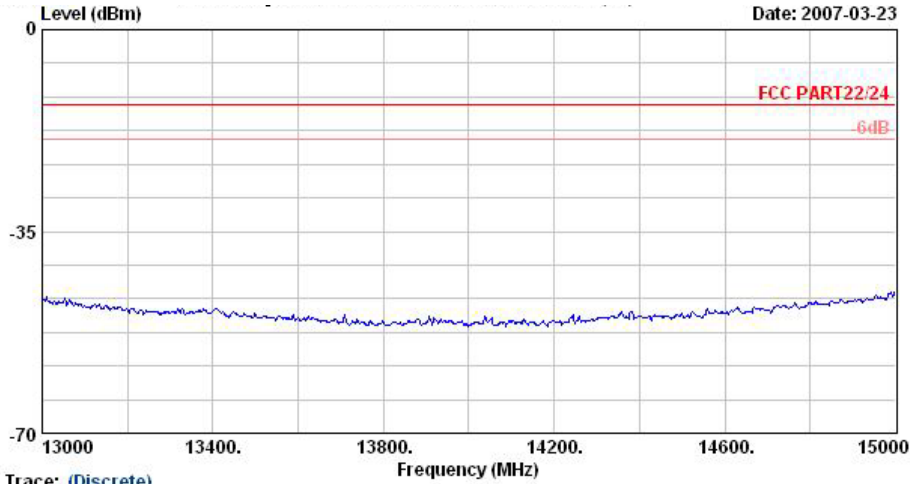

Trace: (Discrete)  
Site : 03CH06-HY  
Condition : HF-SPURIOUS VERTICAL  
EUT : GSM Module  
Power : 120Vac/60Hz  
Model : FG 731404  
Memo : PCS 1900 Link;CH661+Adaptor

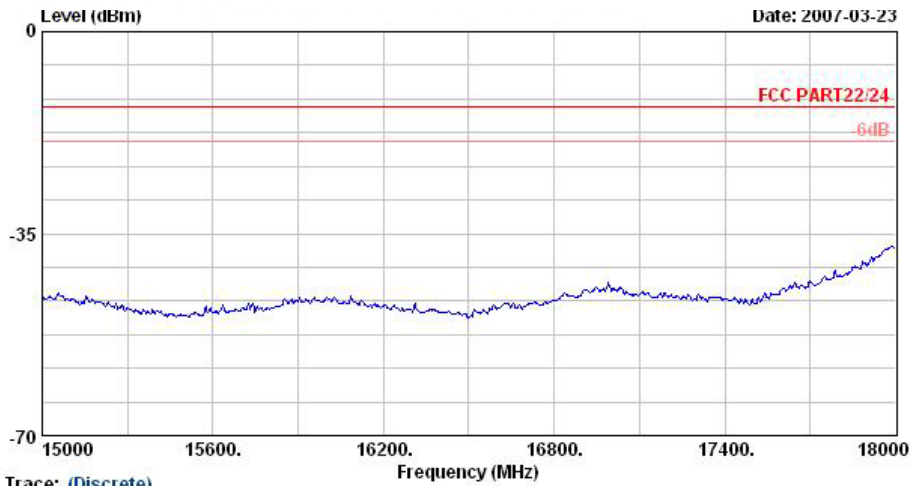

Trace: (Discrete)  
Site : 03CH06-HY  
Condition : HF-SPURIOUS VERTICAL  
EUT : GSM Module  
Power : 120Vac/60Hz  
Model : FG 731404  
Memo : PCS 1900 Link;CH661+Adaptor

Remark : There is no more obvious emission except the listings above.

## 4.7 Frequency Stability (Temperature Variation)

### 4.7.1 Measurement Instrument

As described in chapter 5 of this test report.

### 4.7.2 Test Procedure

1. The EUT and test equipment were set up as shown on the following section.
2. With all power removed, the temperature was decreased to  $-30^{\circ}\text{C}$  and permitted to stabilize for three hours. Power was applied and the maximum change in frequency was noted within one minute.
3. With power OFF, the temperature was raised in  $10^{\circ}\text{C}$  steps. The sample was permitted to stabilize at each step for at least one-half hour. Power was applied and the maximum frequency change was noted within one minute.
4. The temperature tests were performed for the worst case.
5. Test data was recorded.

### 4.7.3 Test Setup Layout

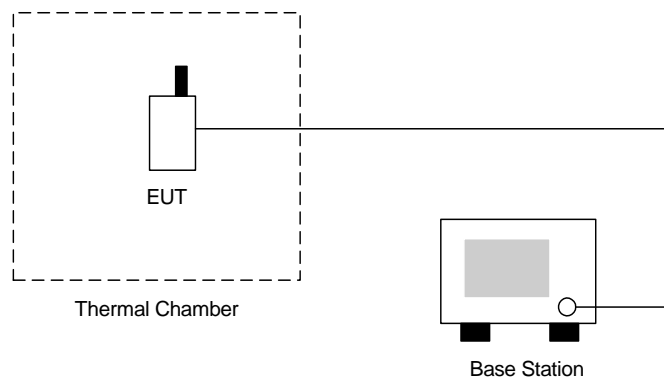



4.7.4 Test Result

- Test Mode : GSM850 CH189

Temperature(°C)	Change (Hz)	Change (ppm)	Limit (ppm)	Result
-30	-45	-0.02	2.5	Passed
-20	-42	-0.02		
-10	-41	-0.02		
0	38	0.02		
10	-38	-0.02		
20	34	0.02		
30	39	0.02		
40	-42	-0.02		
50	-40	-0.02		

- Test Mode : PCS1900 CH661

Temperature(°C)	Change (Hz)	Change (ppm)	Limit (ppm)	Result
-30	-51	-0.03	2.5	Passed
-20	-57	-0.03		
-10	48	0.03		
0	-54	-0.03		
10	62	0.03		
20	39	0.02		
30	-48	-0.03		
40	-50	-0.03		
50	-53	-0.03		

### 4.8 Frequency Stability (Voltage Variation)

#### 4.8.1 Measurement Instrument

As described in chapter 5 of this test report.

#### 4.8.2 Test Procedure

1. The EUT was placed in a temperature chamber at  $25\pm 5^{\circ}\text{C}$  and connected as the following section.
2. The power supply voltage to the EUT was varied from BEP to 115% of the nominal value measured at the input to the EUT.
3. The variation in frequency was measured for the worst case.

#### 4.8.3 Test Setup Layout

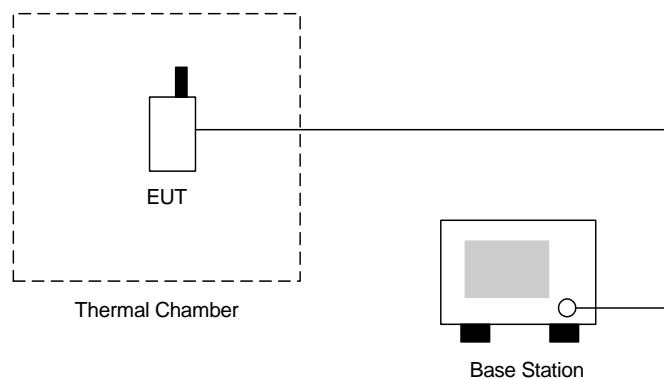

#### 4.8.4 Test Result

- Test Mode : GSM850 CH189

Voltage(Volt)	Change (Hz)	Change (ppm)	Limit (ppm)	Result
9	-42.0	-0.02	2.5	Passed
7.7	-35.0	-0.02		
10.4	40.0	0.02		

- Test Mode : PCS1900 CH661

Voltage(Volt)	Change (Hz)	Change (ppm)	Limit (ppm)	Result
9	-40.0	-0.02	2.5	Passed
7.7	-55.0	-0.03		
10.4	-53.0	-0.03		

Remark:

1. Normal Voltage=7.7 V.



## 5 List of Measurement Equipments

Instrument	Manufacturer	Model No.	Serial No.	Characteristics	Calibration Date	Due Date	Remark
Spectrum analyzer	Agilent	E4408B	MY44211030	9KHz-26.5GHz	Oct. 05, 2006	Oct. 04, 2007	Radiation (03CH06-HY)
EMI Test Receiver	R&S	ESCS30	100356	9KHz-2.75GHz	Jul. 13, 2006	Jul. 12, 2007	Radiation (03CH06-HY)
Controller	INN-CO	CO2000	N/A	N/A	N/A	N/A	Radiation (03CH06-HY)
Bilog Antenna	SCHAFFNER	CBL6112B	2885	30MHz -2GHz	Nov. 20, 2006	Nov. 19, 2007	Radiation (03CH06-HY)
Horn Antenna	Com-Power	AH118	071025	1G-18G	Mar. 29, 2006	Mar. 28, 2007	Radiation (03CH06-HY)
SHF-EHF Horn	SCHWARZBECK	BBHA 9170	9170-249	14G - 40G	Nov. 20, 2006	Nov. 19, 2008	Radiation (03CH06-HY)
Pre Amplifier	Agilent	8449B	3008A01917	1G - 26.5G	Nov. 15, 2006	Nov. 14, 2007	Radiation (03CH06-HY)
Pre Amplifier	Mini Circuits	ZKL-2	D092004-1	10~2500MHz	Nov. 15, 2006	Nov. 14, 2007	Radiation (03CH06-HY)
Turn Table	INN-CO	DS2000	420/650/00	0 ~ 360 degree	N/A	N/A	Radiation (03CH06-HY)
Antenna Mast	INN-CO	MM3000	114/8000604/ L	1 m - 4 m	N/A	N/A	Radiation (03CH06-HY)





## 6 Uncertainty Evaluation

### Uncertainty of Radiated Emission Measurement (30MHz ~ 1000MHz)

Contribution	Uncertainty of $x_i$		$u(x_i)$
	dB	Probability Distribution	
Receiver reading	0.41	Normal(k=2)	0.21
Antenna factor calibration	0.83	Normal(k=2)	0.42
Cable loss calibration	0.25	Normal(k=2)	0.13
Pre Amplifier Gain calibration	0.27	Normal(k=2)	0.14
RCV/SPA specification	2.50	Rectangular	0.72
Antenna Factor Interpolation for Frequency	1.00	Rectangular	0.29
Site imperfection	1.43	Rectangular	0.83
Mismatch	+0.39/-0.41	U-shaped	0.28
<b>combined standard uncertainty Uc(y)</b>	<b>1.27</b>		
<b>Measuring uncertainty for a level of confidence of 95% U=2Uc(y)</b>	<b>2.54</b>		

### Uncertainty of Radiated Emission Measurement (1GHz ~ 40GHz)

Contribution	Uncertainty of $x_i$		$u(x_i)$	$C_i$	$C_i * u(x_i)$
	dB	Probability Distribution			
Receiver reading	±0.10	Normal(k=1)	0.10	1	0.10
Antenna factor calibration	±1.70	Normal(k=2)	0.85	1	0.85
Cable loss calibration	±0.50	Normal(k=2)	0.25	1	0.25
Receiver Correction	±2.00	Rectangular	1.15	1	1.15
Antenna Factor Directional	±1.50	Rectangular	0.87	1	0.87
Site imperfection	±2.80	Triangular	1.14	1	1.14
Mismatch Receiver VSWR $\Gamma_1 = 0.197$ Antenna VSWR $\Gamma_2 = 0.194$ Uncertainty = $20 \log(1 - \Gamma_1 * \Gamma_2 * \Gamma_3)$	+0.34/-0.35	U-shaped	0.244	1	0.244
<b>Combined standard uncertainty Uc(y)</b>	<b>2.36</b>				
<b>Measuring uncertainty for a level of confidence of 95% U=2Ue(y)</b>	<b>4.72</b>				

END OF TEST REPORT