

**ELECTROMAGNETIC EMISSIONS COMPLIANCE REPORT
INTENTIONAL RADIATOR CERTIFICATION TO
FCC PART 24 SUBPART E REQUIREMENT**

OF

Single Band Single-mode CDMA Cellular Phone

MODEL No.: C260

BRAND NAME: BenQ

FCC ID: JVPH1322

REPORT NO: B30603015-RP

ISSUE DATE: Jun. 06, 2003

Prepared for

**BenQ Corporation
18 Jihu Road, Neihu,
Taipei, Taiwan, R.O.C.**

Prepared by

**C&C LABORATORY, CO., LTD.
No. 81-1, Lane 210, Bade Rd. 2,
Luchu Hsiang, Taoyuan Hsien, Taiwan.**

TEL: 886-3-3240332

FAX: 886-3-3245235

**This report shall not be reproduced, except in full, without the written approval of
C&C Laboratory, Co., Ltd.**

VERIFICATION OF COMPLIANCE

Applicant: BenQ Corporation
18 Jihu Road, Neihu,
Taipei, Taiwan, R.O.C.

Equipment Under Test: Signal Band Signal-mode CDMA Cellular Phone

BRAND NAME: Benq

MODEL No.: C260

Model Difference: N/A

Serial Number: N/A

File Number: B30603015-RP

Date of test: Jun 02 ~ Jun. 06, 2003

We hereby certify that:

The above equipment was tested by C&C Laboratory Co., Ltd. The test data, data evaluation, test procedures, and equipment configurations shown in this report were made in accordance with the procedures given in TIA/EIA-603-1-1998 and the energy emitted by the sample EUT tested as described in this report is in compliance with conducted and radiated emission limits of FCC Rule Part 24 subpart E..

The test results of this report relate only to the tested sample identified in this report.

Approved By



Jonson Lee / Director
C&C Laboratory Co., Ltd.

Review By

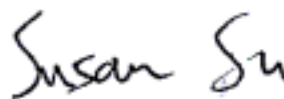

Susan Su / Section Manager
C&C Laboratory Co., Ltd.

Table of Contents

1. GENERAL INFORMATION	5
1.1 Product Description	5
1.2 Related Submittal(s) / Grant (s)	6
1.3 Test Methodology	6
1.4 Test Facility	6
1.5 Special Accessories	6
1.6 Equipment Modifications	6
2. SYSTEM TEST CONFIGURATION	7
2.1 EUT Configuration	7
2.2 EUT Exercise	7
2.3 Test Procedure	7
2.4 Configuration of Tested System	8
3. SUMMARY OF TEST RESULTS	10
4. DESCRIPTION OF TEST MODES	10
5. RF POWER OUTPUT MEASUREMENT	11
5.1 Standard Applicable	11
5.2 Test Set-up:	11
5.3 Measurement Procedure	11
5.4 Measurement Equipment Used:	11
5.5 Measurement Result	11
6. ERP, EIRP MEASUREMENT	12
6.1 Standard Applicable	12
6.2 Test SET-UP (Block Diagram of Configuration)	12
6.3 Measurement Procedure	13
6.4 Measurement Equipment Used:	14
6.5 Measurement Result	15
7. OCCUPIED BANDWIDTH MEASUREMENT	16
7.1 Standard Applicable	16
7.2 Test Set-up:	16
7.3 Measurement Procedure	16
7.4 Measurement Equipment Used:	16
7.5 Measurement Result:	17
8. OUT OF BAND EMISSION AT ANTENNA TERMINALS	19
8.1 Standard Applicable	19
8.2 Test SET-UP	19
8.3 Measurement Procedure	19
8.4 Measurement Equipment Used:	19
8.5 Measurement Result	20

9. FIELD STRENGTH OF SPURIOUS RADIATION MEASUREMENT 31

9.1 Standard Applicable31

9.2 EUT Setup (Block Diagram of Configuration)31

9.3 Measurement Procedure.....32

9.4 Measurement Equipment Used:33

9.5 Measurement Result.....33

10. FREQUENCY STABILITY V.S. TEMPERATURE MEASUREMENT 37

10.1 Standard Applicable37

10.2 Test Set-up:37

10.3 Measurement Procedure.....37

10.4 Measurement Equipment Used:38

10.5 Measurement Result.....38

11. FREQUENCY STABILITY V.S. VOLTAGE MEASUREMENT 39

11.1 Standard Applicable39

11.2 Test Set-up:39

11.3 Measurement Procedure.....39

11.4 Measurement Equipment Used:39

11.5 Measurement Result.....40

12. CONDUCTED EMISSION TEST 41

12.1 Standard Applicable41

12.2 EUT Setup.....41

12.3 Measurement Procedure.....41

12.4 Measurement Equipment Used:42

12.5 Measurement Result.....42

APPENDIX 1 PHOTOGRPHS OF SET UP 45

APPENDIX 2 EXTERNAL PHOTOGRPHS OF EUT..... 48

APPENDIX 3 INTERNAL PHOTOGRPHS OF EUT 54

1. GENERAL INFORMATION

1.1 Product Description

Product	Single Band Single-mode CDMA Cellular Phone	
Model Name	C260	
Model Difference:	N/A	
Trade Name	BenQ	
Frequency Range and Power	TX: 1850 MHz – 1910 MHz, RX: 1930 MHz – 1990 MHz	25.0 dBm (Average)
Cellular Phone Standards	CDMA (PCS)	
Type of Emission	1M25F9W	
Antenna Type	Integrated, non-retractable (internal)	
Antenna Gain	2.95 dBi	
Power Supply	Rated 3.7Vdc INPUT: AC120V, 0.1A, 60Hz OUTPUT: 3.6Vdc, 0.6A	

1.2 Related Submittal(s) / Grant (s)

This submittal(s) (test report) is intended for FCC ID: JVPH1322 filing to comply with Section Part 24 subpart E of the FCC CFR 47 Rules.

1.3 Test Methodology

Both conducted and radiated testing were performed according to the procedures document on chapter 13 of ANSI C63.4 (1992) and FCC CFR 47.1046, 2.1047, 2.1049, 2.1051, 2.1053, 2.1055 and 2.1057.

1.4 Test Facility

The open area test site and conducted measurement facility used to collect the radiated data is located on the address of C&C Laboratory, Co., Ltd. No. 81-1, 210 Lane, Pa-de 2nd Road, Lu-Chu Hsiang, Taoyuan, Taiwan, R.O.C.. The Open Area Test Sites and the Line Conducted labs are constructed and calibrated to meet the FCC requirements in documents ANSI C63.4: 1992 and CISPR 22/EN 55022 requirements. The test facility are listed with Federal Communications Commission (reference number 90471 (Site No. 1 and 3) and 93105 (Site No. 4).

1.5 Special Accessories

Not available for this EUT intended for grant.

1.6 Equipment Modifications

Not available for this EUT intended for grant.

2. SYSTEM TEST CONFIGURATION

2.1 EUT Configuration

The EUT configuration for testing is installed on RF field strength measurement to meet the Commissions requirement and operating in a manner which intends to maximize its emission characteristics in a continuous normal application.

2.2 EUT Exercise

The EUT (Transmitter) was operated in the engineering mode to fix the Tx frequency which was for the purpose of the measurements.

2.3 Test Procedure

2.3.1 Conducted Emissions

The EUT is placed on a turn table which is 0.8 m above ground plane. According to the requirements in Section 13.1.4.1 of ANSI C63.4-1992. Conducted emissions from the EUT measured in the frequency range between 0.15 MHz and 30MHz using CISPR Quasi-Peak and Average detector mode.

2.3.2 Radiated Emissions

The EUT is placed on a turn table which is 1.0 m above ground plane. The turn table shall rotate 360 degrees to determine the position of maximum emission level. EUT is set 3m away from the receiving antenna which varied from 1m to 4m to find out the highest emission. And also, each emission was to be maximized by changing the polarization of receiving antenna both horizontal and vertical. In order to find out the max. emission, the relative positions of this hand-held transmitter(EUT) was rotated through three orthogonal axes according to the requirements in Section 13.1.4.1 of ANSI C63.4-1992.

2.4 Configuration of Tested System

Fig. 2-1 Configuration of Tested System

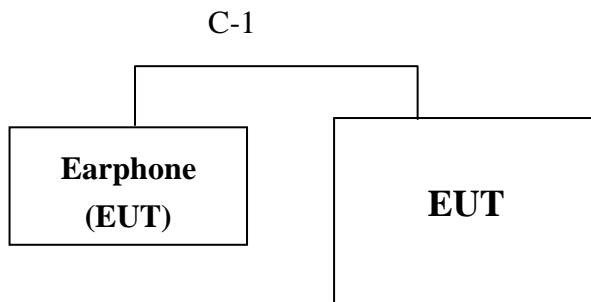

Table 2-1 Equipment Used in Tested System

Item	Equipment	Mfr/Brand	Model/Type No.	FCC ID	Series No.	Note

Table 2-2 Information of Interface Cable

Item	I/O Cable	Device Connected	Shielded Type	Ferrite Core	Detachable/ Permanently	Length	Note
C-1	Earphone Cable	Earphone-	Yes	No	Detachable	120cm	

Note:

- (1) Unless otherwise marked as in 'Remark' column, C&C Laboratory consigns the support equipment to the tested system.
- (2) For detachable type I/O cable should be specified the length in cm in 'Length' column.

3. SUMMARY OF TEST RESULTS

FCC Rules	Description Of Test	Result
§2.1046	RF Power Output	
§2.1046 §24.232(a)	EIRP	Compliant
§2.1049	Occupied Bandwidth	Compliant
§2.1051 §24.238(a)	Out of Band Emissions at Antenna Terminals	Compliant
§2.1053 §24.238(a)	Field Strength of Spurious Radiation	Compliant
§2.1055, §24.235	Frequency Stability vs. Temperature	Compliant
§2.1055, §24.235	Frequency Stability vs. Voltage	Compliant
§15.107;§15.207	AC Power Line Conducted Emission	Compliant

4. DESCRIPTION OF TEST MODES

The EUT (Single Band Single-mode CDMA Cellular Phone) has been tested under operating condition.

EUT staying in continuous transmitting mode is programmed. Channel low, Mid and High for each type and band with rated data rate are chosen for full testing.

The field strength of spurious radiation emission was measured as EUT stand-up position (X mode) and lie down position (Y, Z mode), three modes. The worst case Y mode for channel Low, Mid and High was reported.

5. RF POWER OUTPUT MEASUREMENT

5.1 Standard Applicable

According to FCC §2.1046.

5.2 Test Set-up:

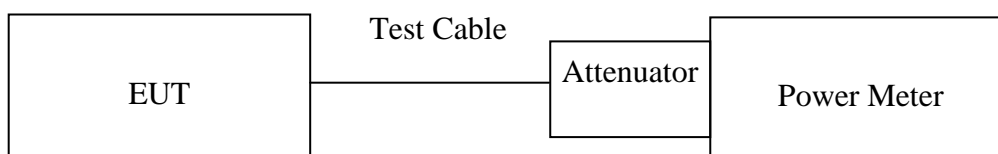

Note: Measurement setup for testing on Antenna connector

5.3 Measurement Procedure

The transmitter output was connected to a calibrated attenuator, the other end of which was connected to a power meter. Transmitter output was read off the power meter in dBm. The power output at the transmitter antenna port was determined by adding the value of the attenuator to the power meter reading.

5.4 Measurement Equipment Used:

EQUIPMENT TYPE	MFR	Model No.	Serial No.	LAST CAL.	Cal. Due.
Power Meter	HP	E4416A	GB41291611	5/6/2003	5/5/2004
Power Sensor	HP	E9327A	US40441097	3/13/2003	3/12/2004
Attenuator	Mini circle	20dB	N/A	05/15/2003	05/14/2004

5.5 Measurement Result

EUT Mode	Frequency (MHz)	CH	Power Meter Reading (dBm)	Attenuator (dB)	Average Power (dBm)
CDMA (PCS)	1851.25	25	4.90	20	24.90
	1880.00	600	4.92	20	24.92
	1908.75	1175	4.92	20	24.92

6. ERP, EIRP MEASUREMENT

6.1 Standard Applicable

According to FCC §2.1046

FCC 24.232(b) Mobile station are limited to 2W EIRP.

6.2 Test SET-UP (Block Diagram of Configuration)

(A) Radiated Emission Test Set-Up, Frequency Below 1000MHz

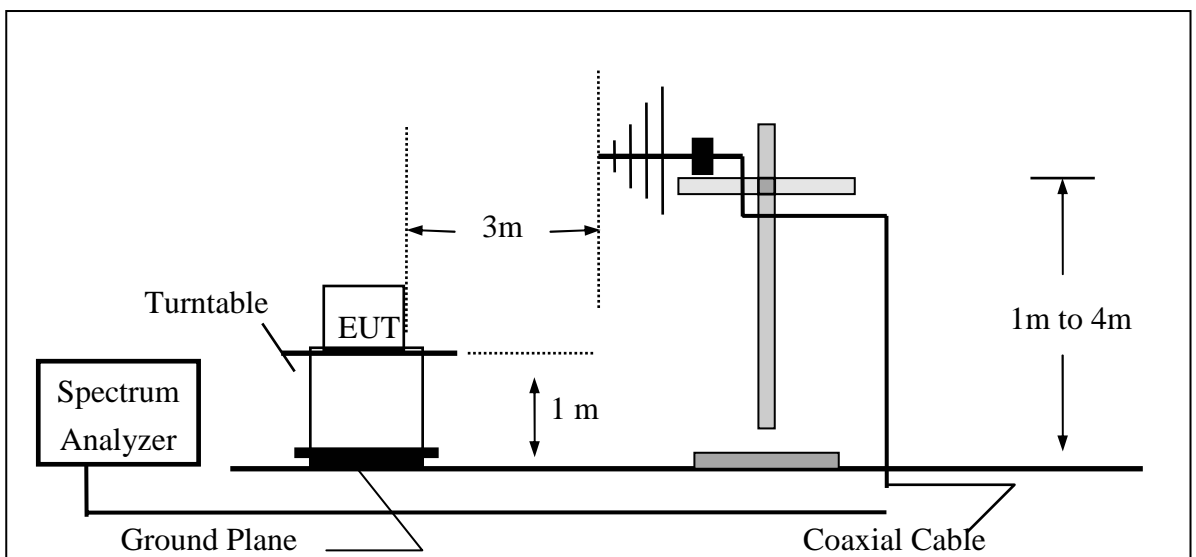

(B) Radiated Emission Test Set-Up Frequency Over 1 GHz

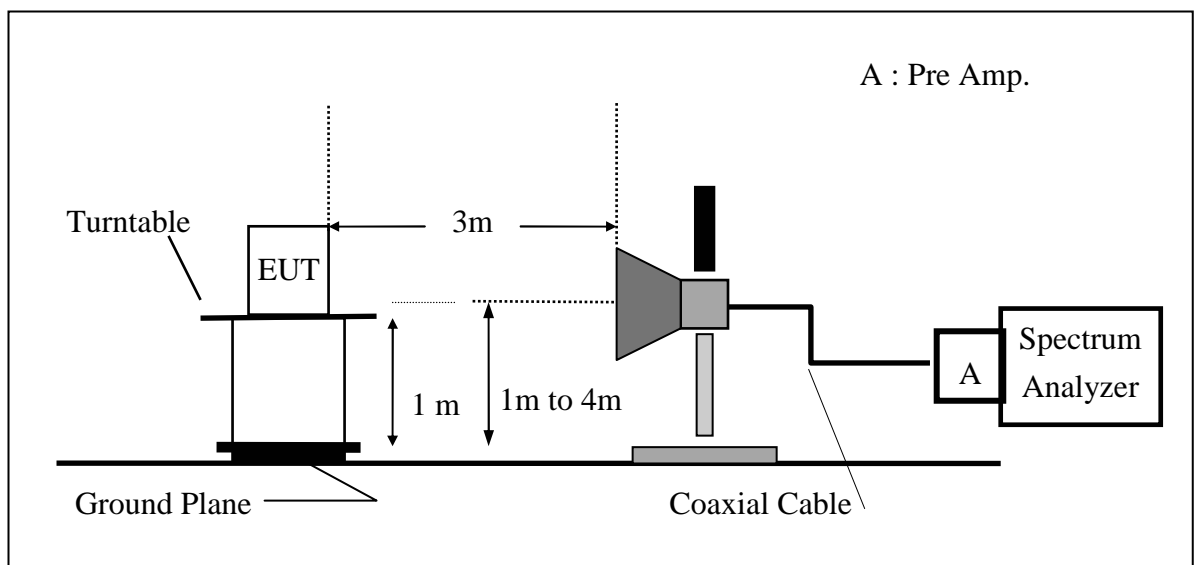

(C) Substituted Method Test Set-UP

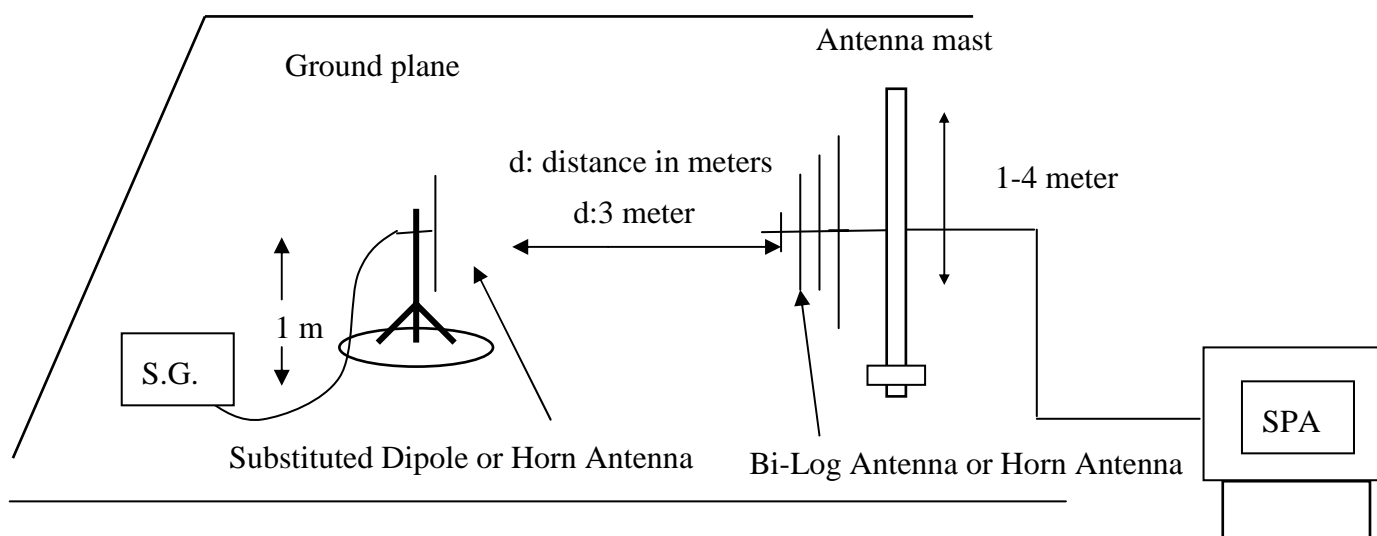

6.3 Measurement Procedure

The EUT was placed on a non-conductive turntable using a non-conductive support. The radiated emission at the fundamental frequency was measured at 3 m with a test antenna and EMI spectrum analyzer.

During the measurement of the EUT, the resolution bandwidth was set to 3MHz and the average bandwidth was set to 3MHz. The highest emission was recorded with the rotation of the turntable and the lowering of the test antenna. The reading was recorded and the field strength (E in dBuV/m) was calculated.

EIRP in frequency band 1851.25 –1910MHz were measured using a substitution method. The EUT was replaced by or horn antenna (1851.25-1910MHz) connected, the S.G. output was recorded and EIRP was calculated as follows:

$$\text{EIRP} = \text{S.G. output (dBm)} + \text{Antenna Gain (dBi)} - \text{Cable (dB)}$$

6.4 Measurement Equipment Used:

EQUIPMENT TYPE	MFR	MODEL NUMBER	SERIAL NUMBER	LAST CAL.	CAL DUE.
Spectrum Analyzer	Agilent	E4446A	US42510252	04/28/2003	04/27/2004
Spectrum Analyzer	R&S	FSP30	100112	6/29/2002	6/28/2003
Pre-Amplifier	HP	8447D	2944A09173	03/04/2003	03/03/2004
Horn antenna	EMCO	3115	00022250	2/25/2003	2/26/2004
Pre-Amplifier	HP	8449B	3008B00965	10/01/2002	10/02/2003
Low Loss Cable#40	HUBER+SUHNER	SUCOFLEX 104EPA-10M	19431	4/9/2003	4/8/2004
Turn Table	EMCO	2081-1.21	9709-1885	N.C.R	N.C.R
Antenna Tower	EMCO	2075-2	9707-2060	N.C.R	N.C.R
Controller	EMCO	2090	9709-1256	N.C.R	N.C.R
Site NSA	C&C	N/A	N/A	09/07/2002	09/06/2003
S.G.	HP	83630B	3844A01022	1/15/2003	1/14/2004
Low Loss Cable#38	HUBER+SUHNER	SUCOFLEX 104EPA-6M	19443	4/9/2003	4/8/2004
Substituted Horn	EMCO	3115	00022256	2/25/2003	2/26/2004

6.5 Measurement Result

EUT Mode	EUT Pol.	Frequency (MHz)	CH	Antenna Pol.	SPA Reading (dBuV)	S.G. Output (dBm)	Antenna Gain (dBi)	Cable Loss (dB)	EIRP (dBm)	Limit (dBm)
CDMA (PCS)	X	1851.25	25	V	-16.51	20.69	8.50	2.75	26.44	33.00
	Y	1851.25	25	H	-13.68	20.91	8.50	2.75	26.66	33.00
	Z	1851.25	25	H	-13.89	20.70	8.50	2.75	26.45	33.00
CDMA (PCS)	X	1880.00	600	V	-16.04	22.09	8.50	2.75	27.84	33.00
	Y	1880.00	600	H	-12.30	23.09	8.50	2.75	28.84	33.00
	Z	1880.00	600	H	-12.57	22.82	8.50	2.75	28.57	33.00
CDMA (PCS)	X	1908.75	1175	V	-18.81	19.26	8.50	2.75	25.01	33.00
	Y	1908.75	1175	H	-15.05	20.02	8.50	2.75	25.77	33.00
	Z	1908.75	1175	H	-15.35	19.72	8.50	2.75	25.47	33.00

7. OCCUPIED BANDWIDTH MEASUREMENT

7.1 Standard Applicable

According to §FCC 2.1049.

7.2 Test Set-up:

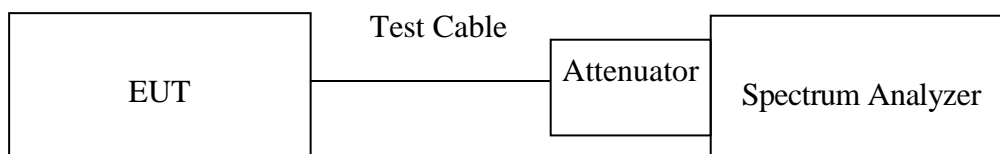

Note: Measurement setup for testing on Antenna connector

7.3 Measurement Procedure

The EUT's output RF connector was connected with a short cable to the spectrum analyzer, RBW(30KHz) was set to about 1% of emission BW, VBW= 300KHz, -26dBc display line was placed on the screen (or 99% bandwidth), the occupied bandwidth is the delta frequency between the two points where the display line intersects the signal trace.

7.4 Measurement Equipment Used:

EQUIPMENT TYPE	MFR	Model No.	Serial No.	LAST CAL.	Cal. Due.
Spectrum Analyzer	Agilent	E4446A	US42510252	04/28/2003	04/27/2004
Spectrum Analyzer	R&S	FSP30	100112	6/29/2002	6/28/2003
Attenuator	Mini circle	20dB	N/A	05/15/2003	05/14/2004

7.5 Measurement Result:

EUT Mode	Frequency (MHz)	CH	Bandwidth (MHz)
CDMA(PCS)	1851.25	25	1.2955
	1880.00	600	1.2813
	1908.75	1175	1.3424

Figure 7-1: CDMA Channel Low

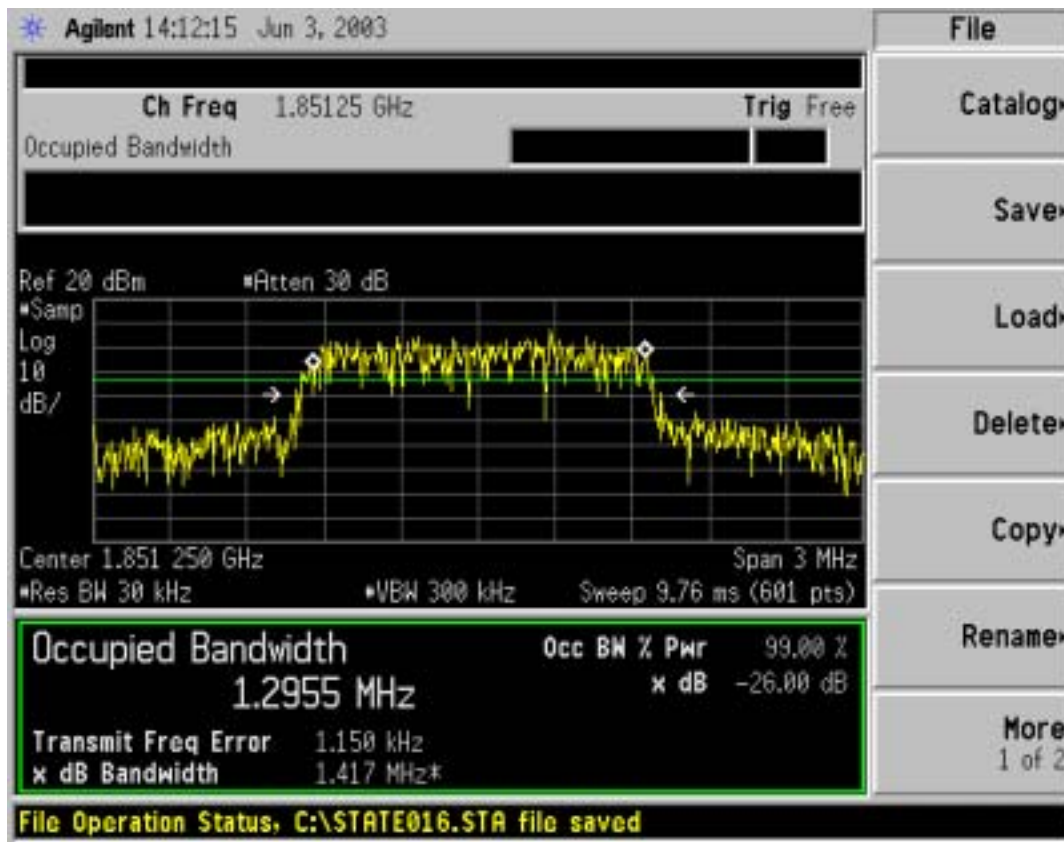

Figure 7-2 CDMA Channel Mid

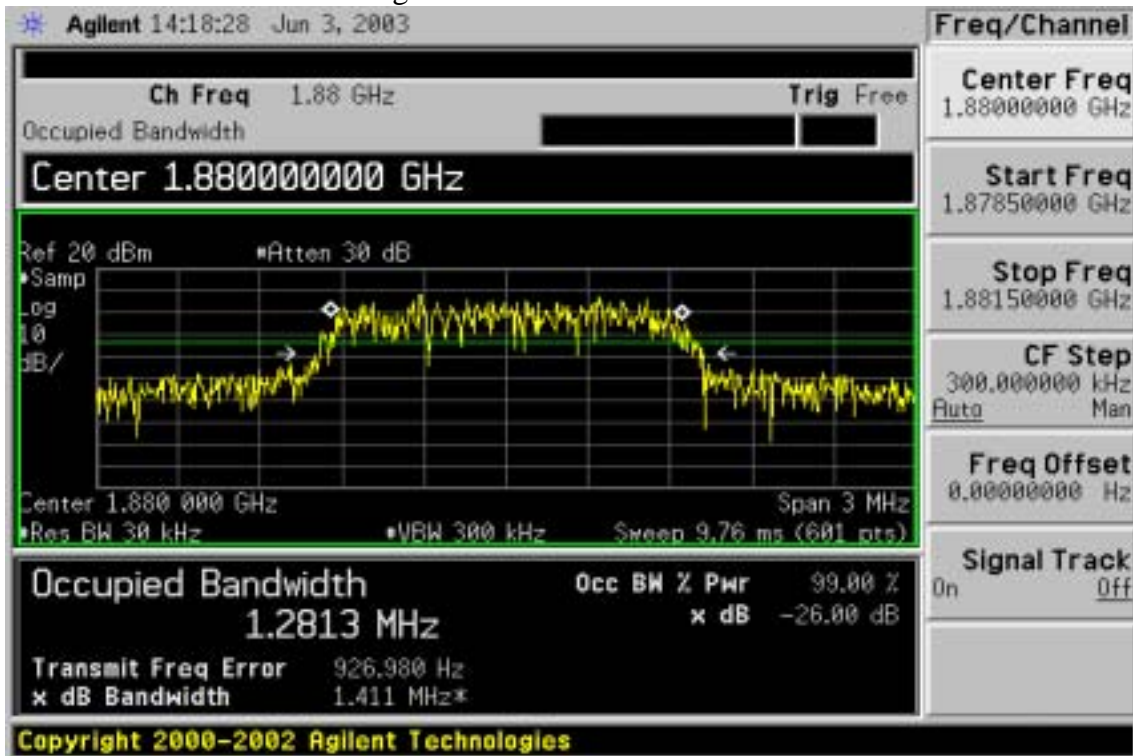
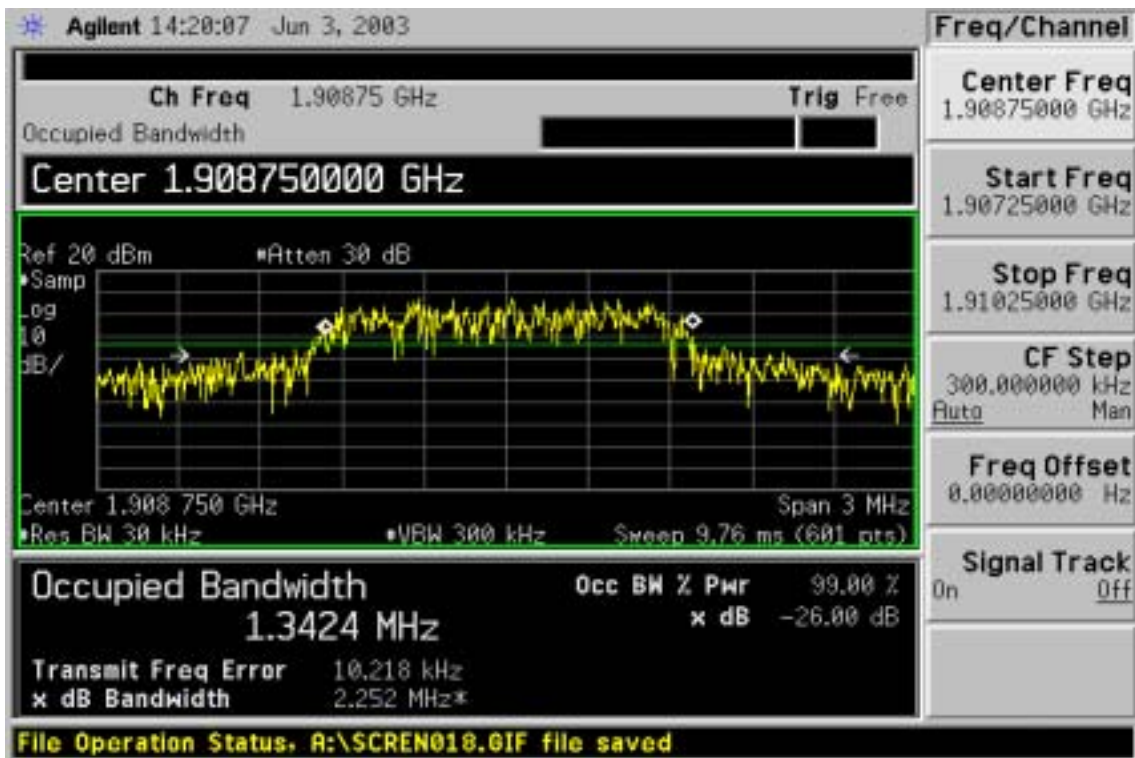

Figure 7-3: CDMA Channel High



8. OUT OF BAND EMISSION AT ANTENNA TERMINALS

8.1 Standard Applicable

According to FCC §2.1051.

FCC §24.238(a), the magnitude of each spurious and harmonic emission that can be detected when the equipment is operated under the conditions specified in the instruction manual and/or alignment procedure, shall not be less than $43 + 10 \log$ (mean output power in watts) dBc below the mean power output outside a license's frequency block (-13dBm)

8.2 Test SET-UP

Out of band emission at antenna terminals:

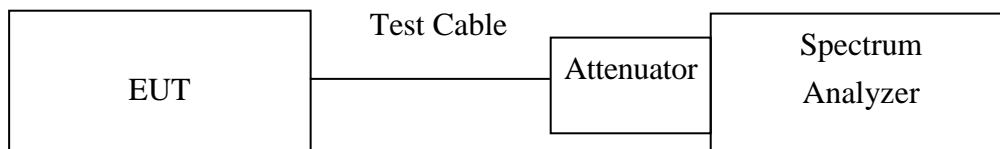

8.3 Measurement Procedure

The RF output of the transceiver was connected to a spectrum analyzer through appropriate attenuation. The resolution bandwidth of the spectrum analyzer was set at 1MHz, sufficient scans were taken to show the out of band Emissions if any up to 10th harmonic.

For the out of band: Set the RBW, VBW = 1MHz, Start=30MHz, Stop= 10 th harmonic.
Limit = -13dBm

Band Edge Requirements(1850MHz and 1910MHz) : In the 1 MHz bands immediately outside and adjacent to the frequency block, a resolution bandwidth of at least 1 percent of the emission bandwidth of the fundamental emission of the transmitter may be employed to measure the out of band Emissions. Limit, -13dBm.

8.4 Measurement Equipment Used:

EQUIPMENT TYPE	MFR	Model No.	Serial No.	LAST CAL.	Cal. Due.
Spectrum Analyzer	Agilent	E4446A	US42510252	04/28/2003	04/27/2004
Spectrum Analyzer	R&S	FSP30	100112	6/29/2002	6/28/2003
Attenuator	Mini circle	10dB	N/A	05/15/2003	05/14/2004

8.5 Measurement Result

Table 8-1: Summary of test result locations

Location	Mode	CH	Description
Figure 8-1	CDMA(PCS)	25	Conducted spurious emissions, 30MHz - 2.5GHz
Figure 8-2	CDMA(PCS)	25	Conducted spurious emissions, 2.5GHz - 20GHz
Figure 8-3	CDMA(PCS)	600	Conducted spurious emissions, 30MHz - 2.5GHz
Figure 8-4	CDMA(PCS)	600	Conducted spurious emissions, 2.5GHz - 20GHz
Figure 8-5	CDMA(PCS)	1175	Conducted spurious emissions, 30MHz - 2.5GHz
Figure 8-6	CDMA(PCS)	1175	Conducted spurious emissions, 2.5GHz - 20GHz
Figure 8-7	CDMA(PCS)	25	Block Edge Emission
Figure 8-8	CDMA(PCS)	375	Block Edge Emission
Figure 8-9	CDMA(PCS)	425	Block Edge Emission
Figure 8-10	CDMA(PCS)	625	Block Edge Emission
Figure 8-11	CDMA(PCS)	925	Block Edge Emission
Figure 8-12	CDMA(PCS)	1175	Block Edge Emission
Figure 8-13	CDMA(PCS)	325	Block Edge Emission
Figure 8-14	CDMA(PCS)	375	Block Edge Emission
Figure 8-15	CDMA(PCS)	725	Block Edge Emission
Figure 8-16	CDMA(PCS)	775	Block Edge Emission
Figure 8-17	CDMA(PCS)	825	Block Edge Emission
Figure 8-18	CDMA(PCS)	875	Block Edge Emission

Figure 8-1: Out of Band emission at antenna terminals– CDMA Channel Low

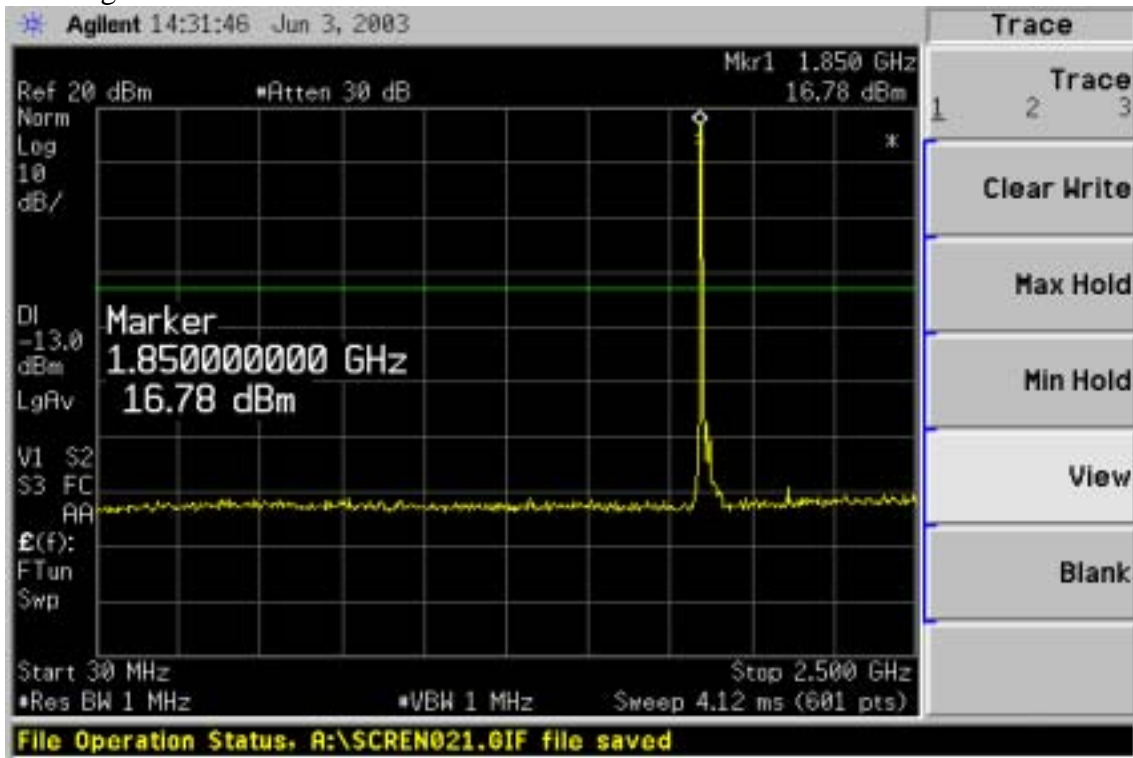

Figure 8-2: Out of Band emission at antenna terminals– CDMA Channel Low

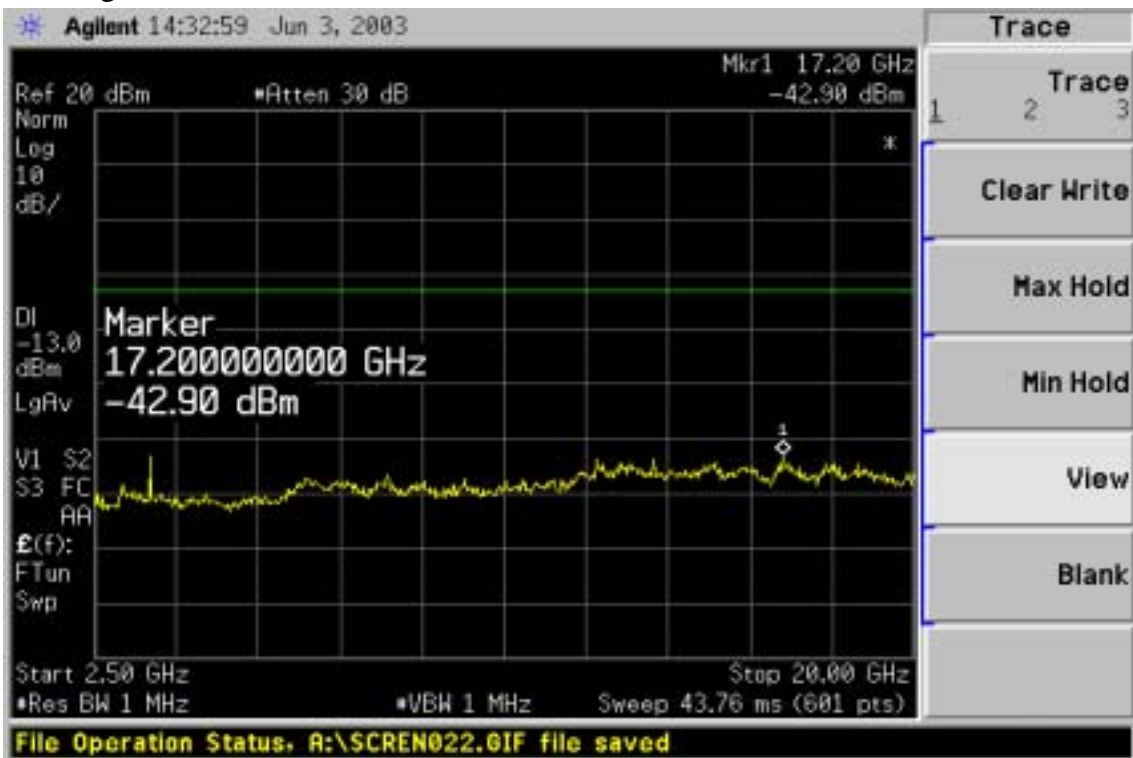

Figure 8-3: Out of Band emission at antenna terminals – CDMA Channel Mid

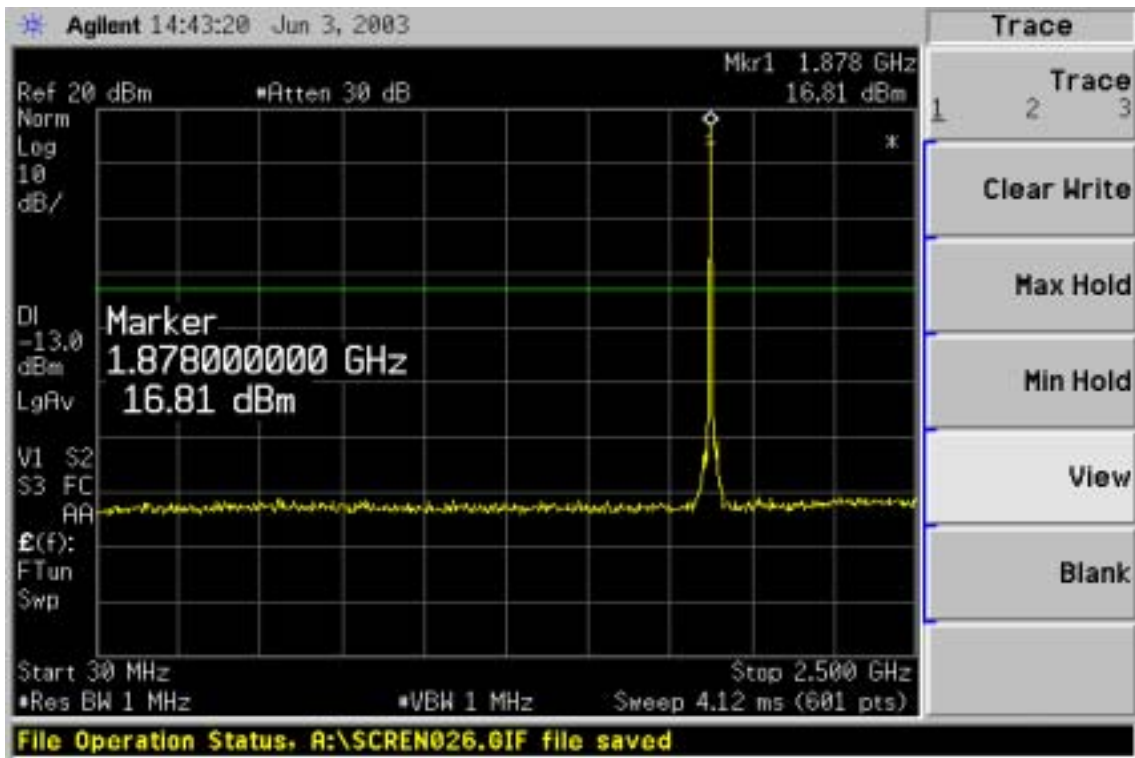

Figure 8-4: Out of Band emission at antenna terminals – CDMA Channel Mid



Figure 8-5: Out of Band emission at antenna terminals– CDMA Channel High

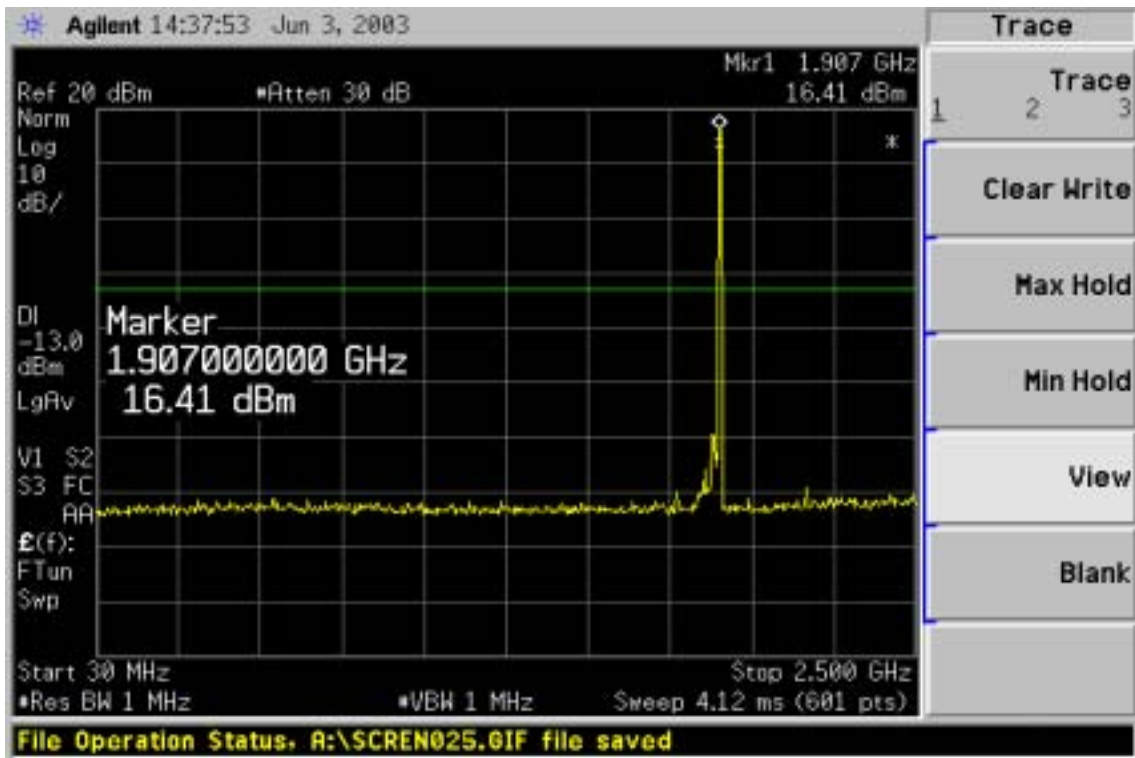

Figure 8-6: Out of Band emission at antenna terminals– CDMA Channel High

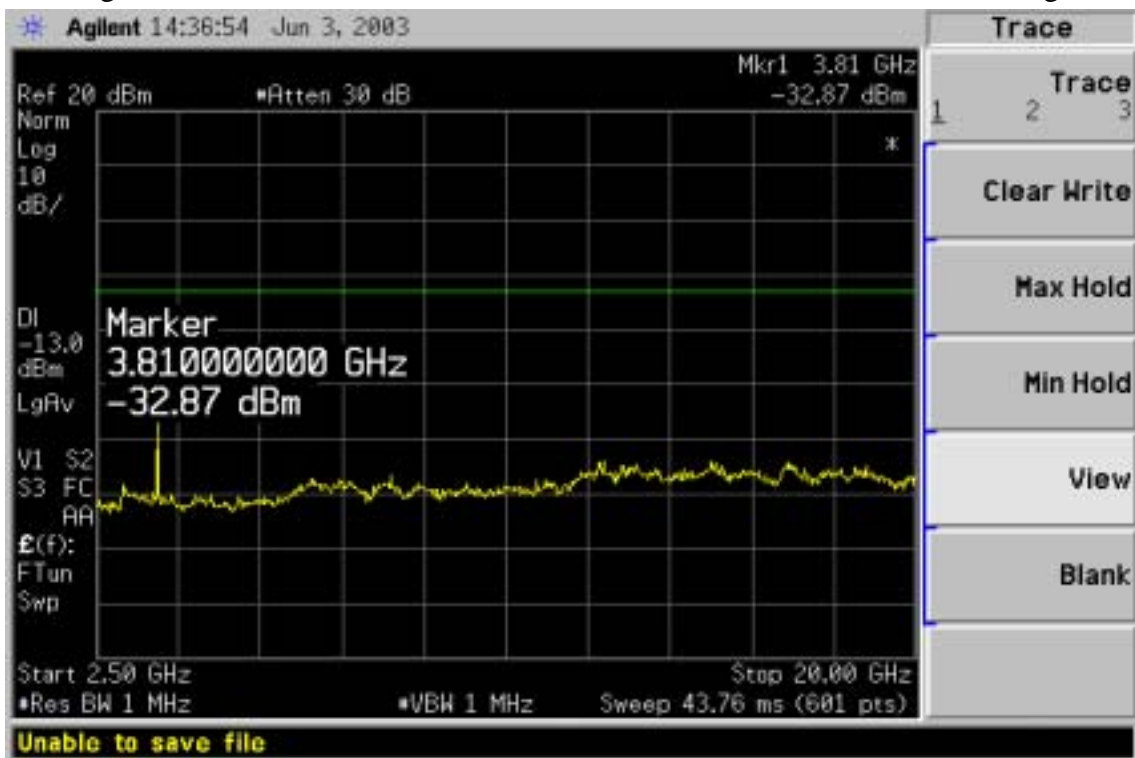
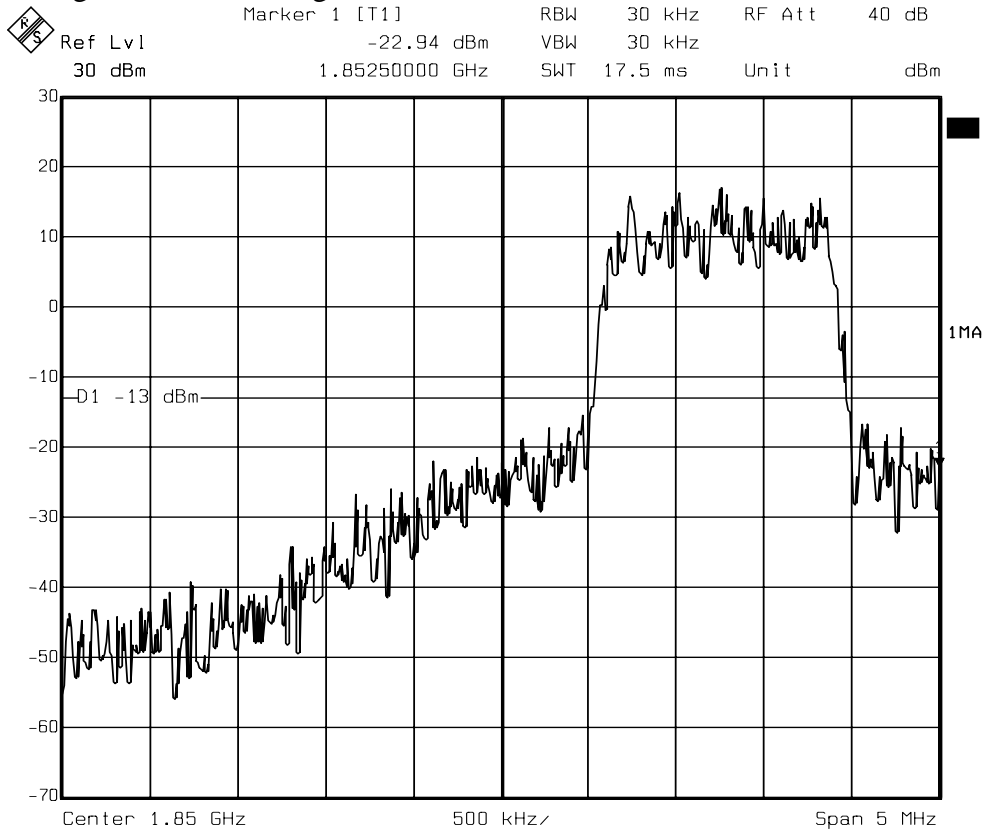
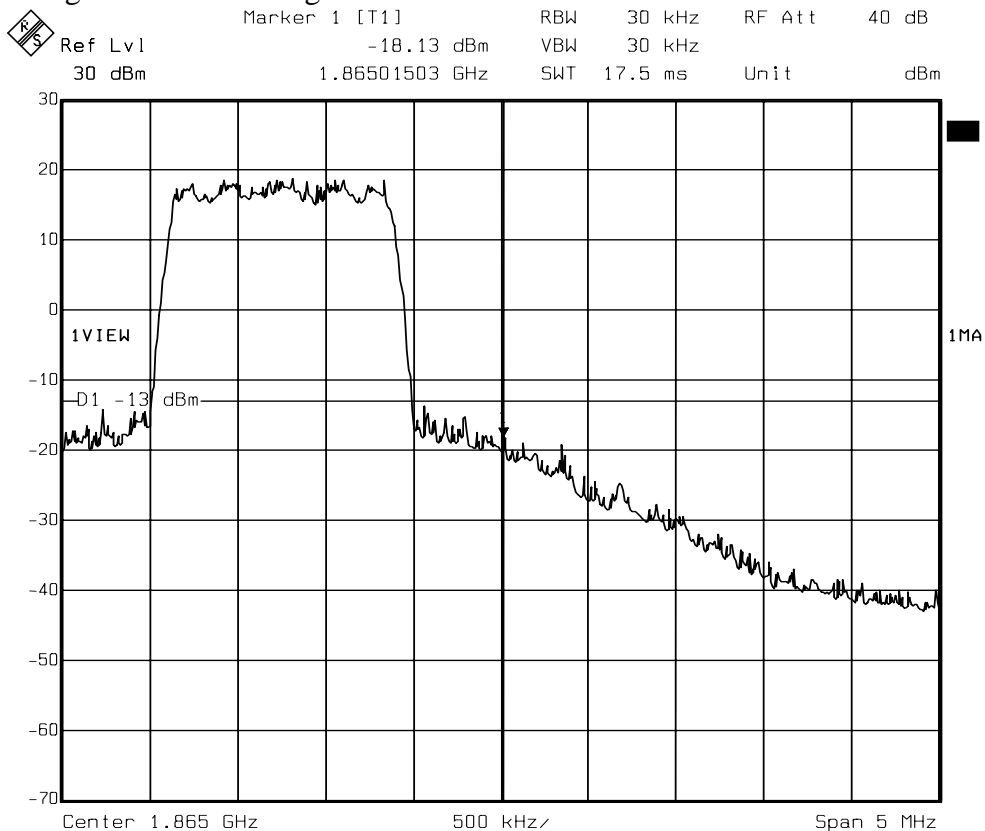

Figure 8-7: Block edge emission at antenna terminals – Block A CH 25



Date: 03.JUL.2003 13:17:35

Figure 8-8: Block edge emission at antenna terminals – Block A CH 275



Date: 03.JUL.2003 13:54:23

Figure 8-9: Block edge emission at antenna terminals – Block B CH 425

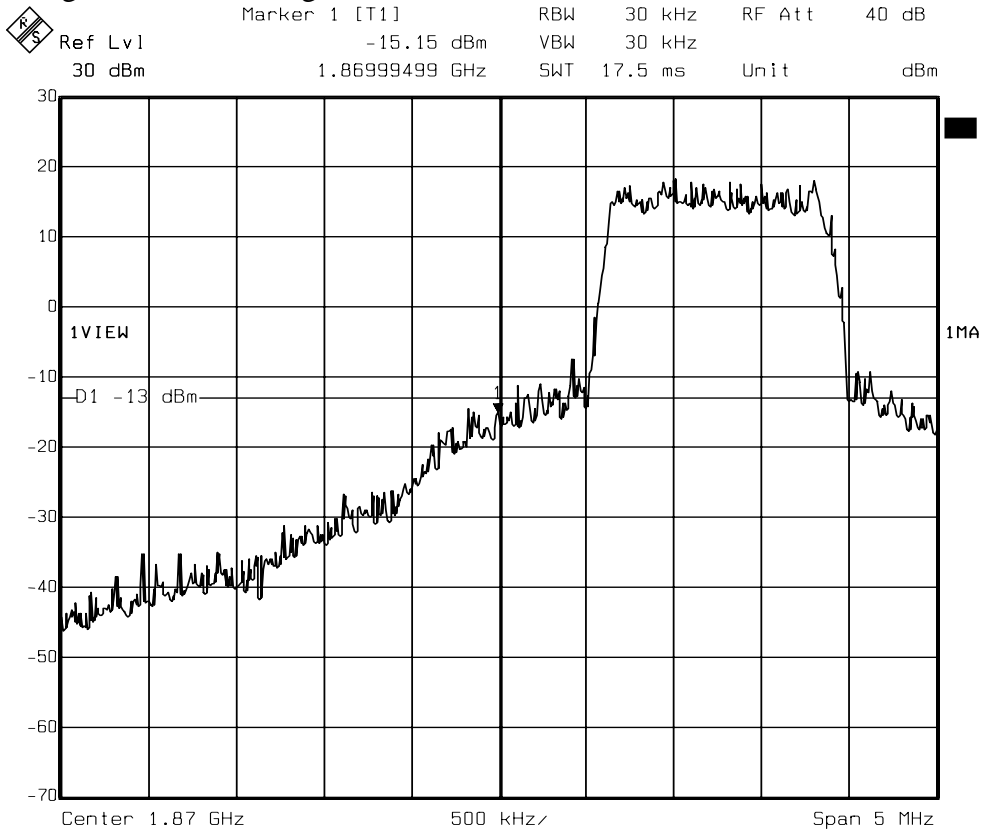

Date: 03.JUL.2003 13:23:25

Figure 8-10: Block edge emission at antenna terminals – Block B CH 675

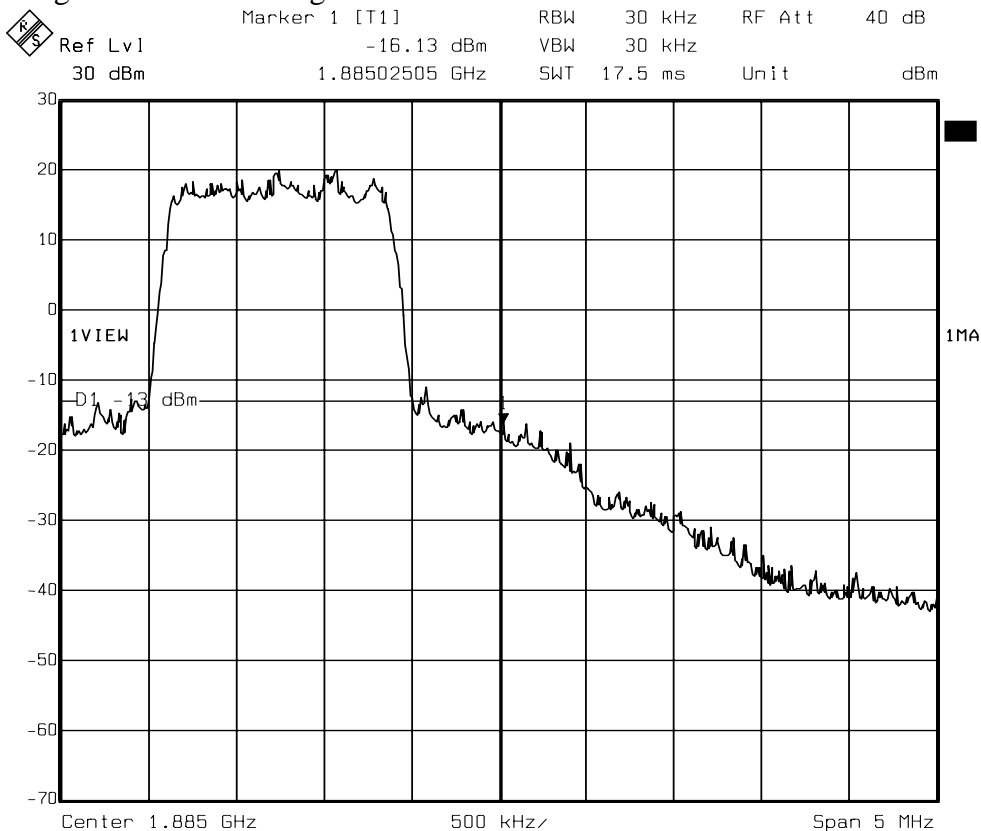

Date: 03.JUL.2003 13:55:46

Figure 8-11: Block edge emission at antenna terminals – Block C CH 925

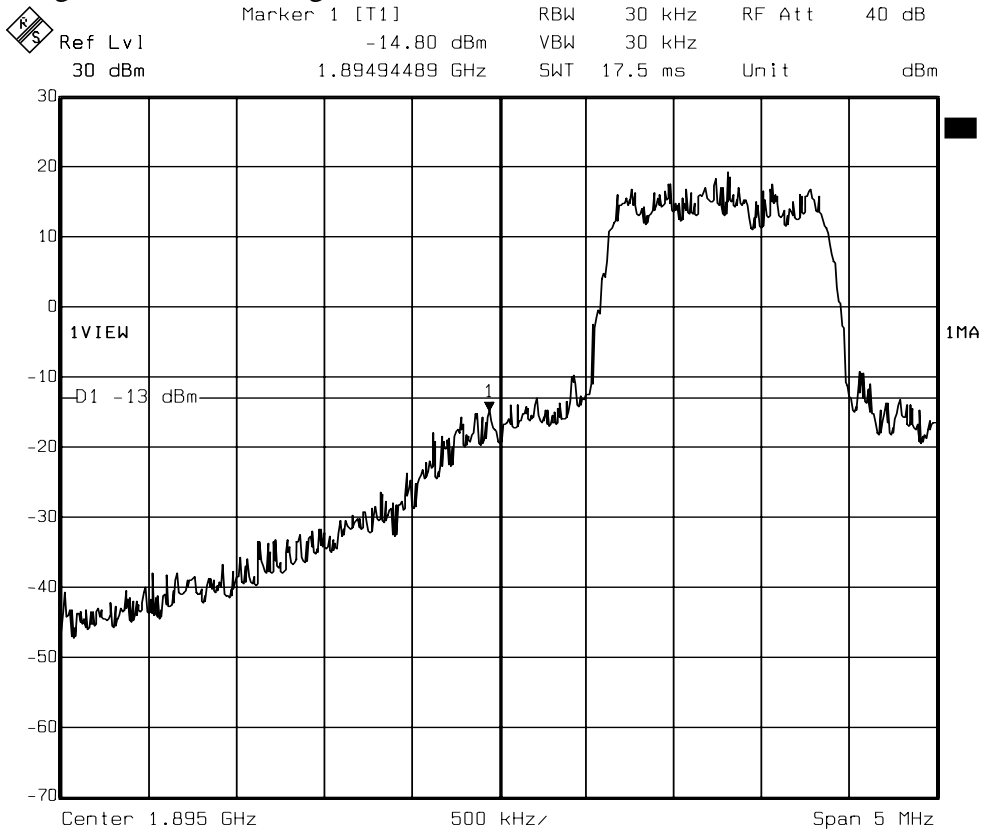

Date: 03.JUL.2003 13:29:36

Figure 8-12: Block edge emission at antenna terminals – Block C CH 1175

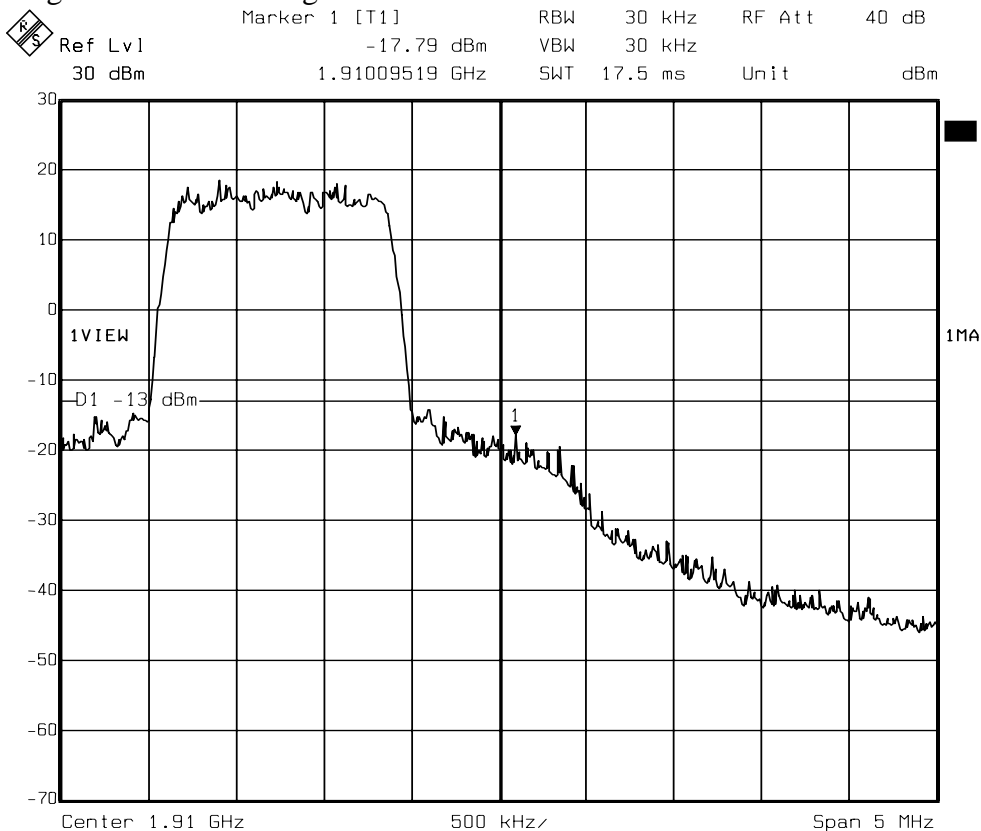

Date: 03.JUL.2003 13:57:40

Figure 8-13: Block edge emission at antenna terminals – Block D CH 325

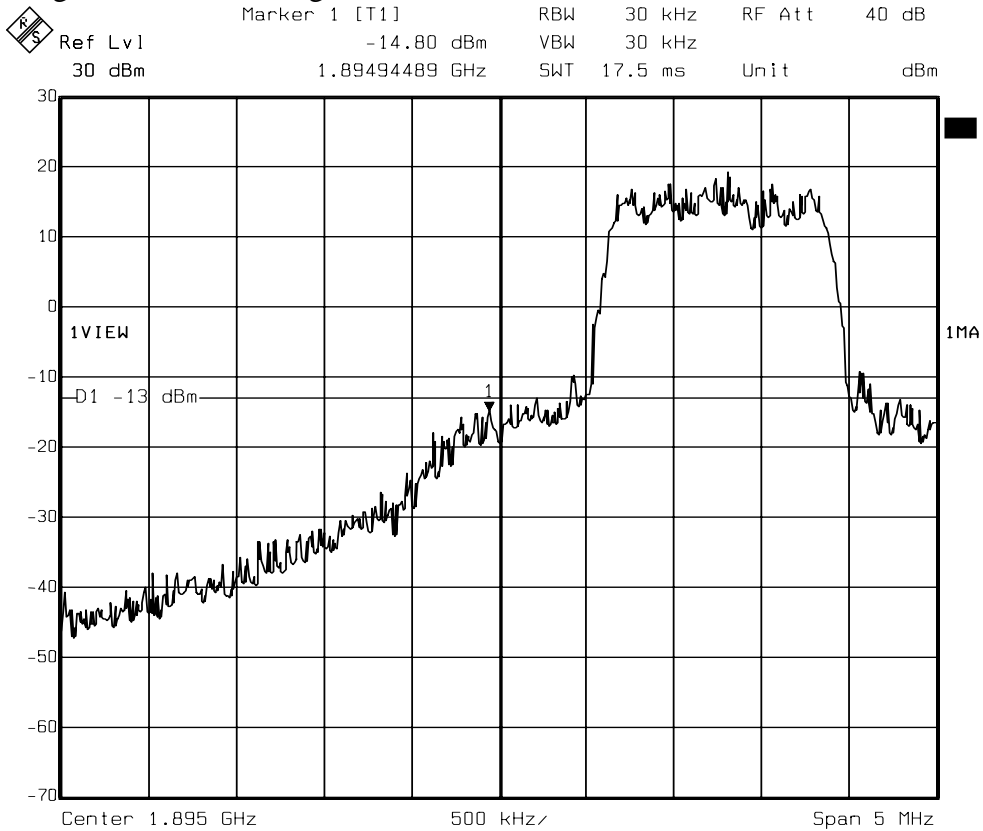

Date: 03.JUL.2003 13:29:36

Figure 8-14: Block edge emission at antenna terminals – Block D CH 375

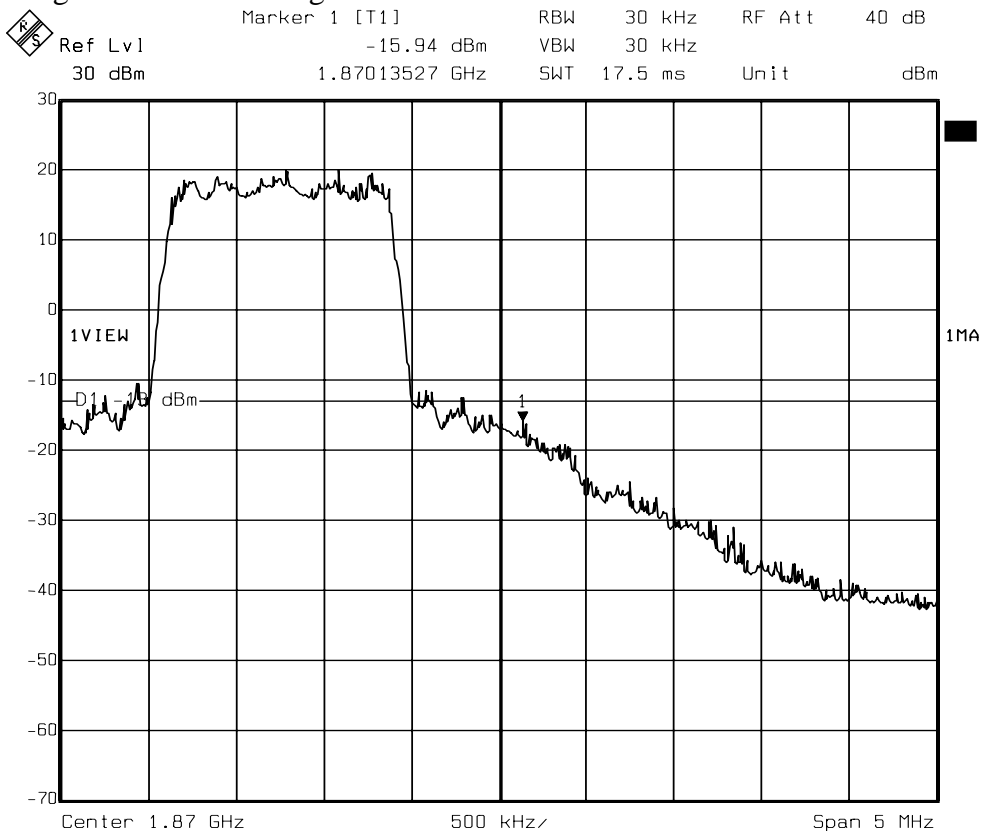

Date: 03.JUL.2003 14:00:15

Figure 8-15: Block edge emission at antenna terminals – Block E CH 725

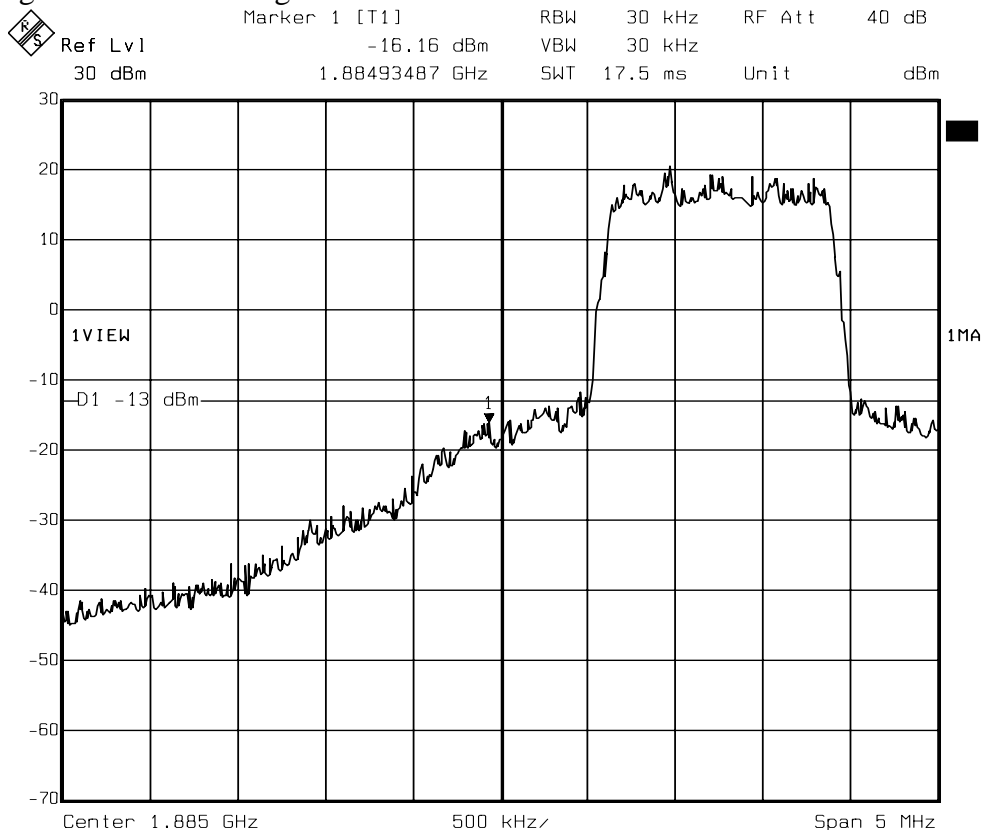

Date: 03.JUL.2003 13:48:01

Figure 8-16: Block edge emission at antenna terminals – Block E CH 775

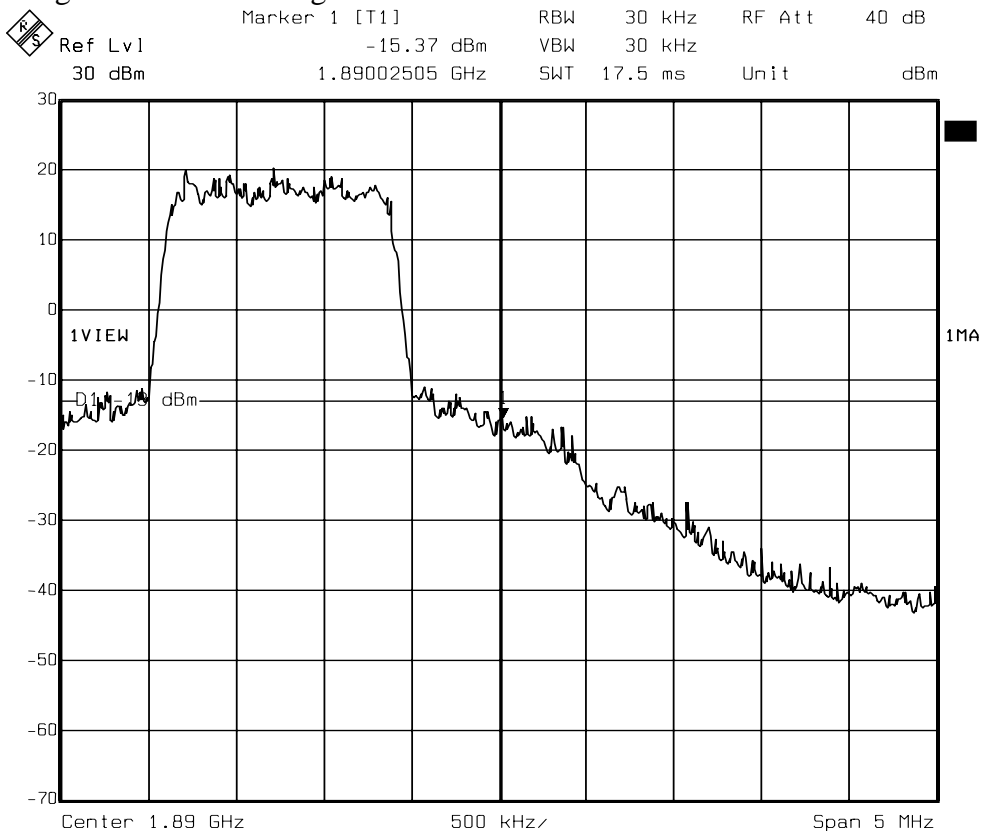

Date: 03.JUL.2003 14:01:52

Figure 8-17: Block edge emission at antenna terminals – Block F CH 825

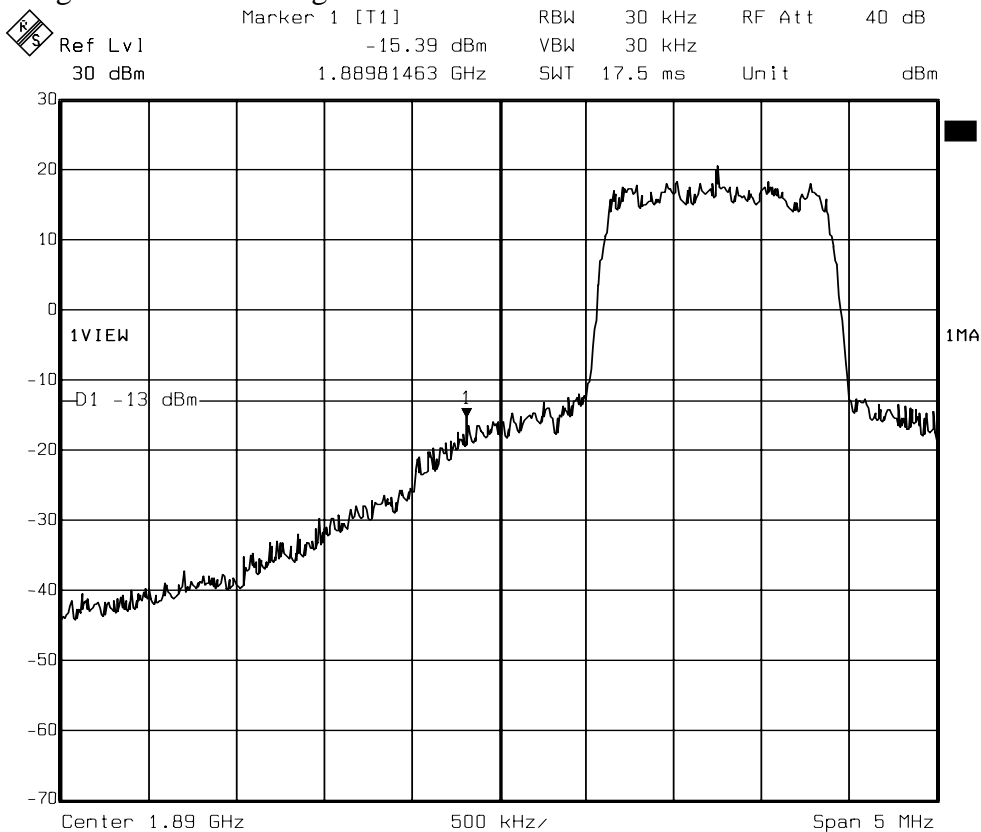

Date: 03.JUL.2003 13:50:01

Figure 8-18: Block edge emission at antenna terminals – Block F CH 875

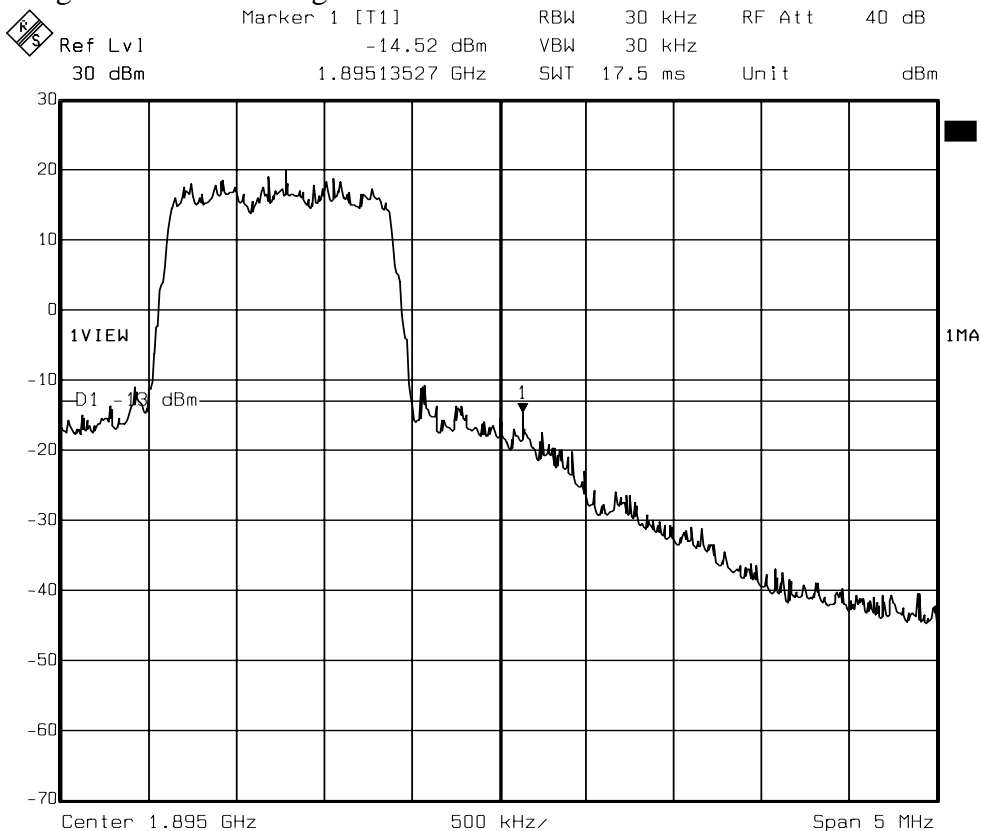

Date: 03.JUL.2003 14:36:38

Figure 8-18: Block edge emission at antenna terminals – Block A CH 25



9. FIELD STRENGTH OF SPURIOUS RADIATION MEASUREMENT

9.1 Standard Applicable

According to FCC §2.1053,

FCC §24.238(a), the magnitude of each spurious and harmonic emission that can be detected when the equipment is operated under the conditions specified in the instruction manual and/or alignment procedure, shall not be less than $43 + 10 \log$ (mean output power in watts) dBc below the mean power output outside a license's frequency block (-13dBm)

9.2 EUT Setup (Block Diagram of Configuration)

(A) Radiated Emission Test Set-Up, Frequency Below 1000MHz

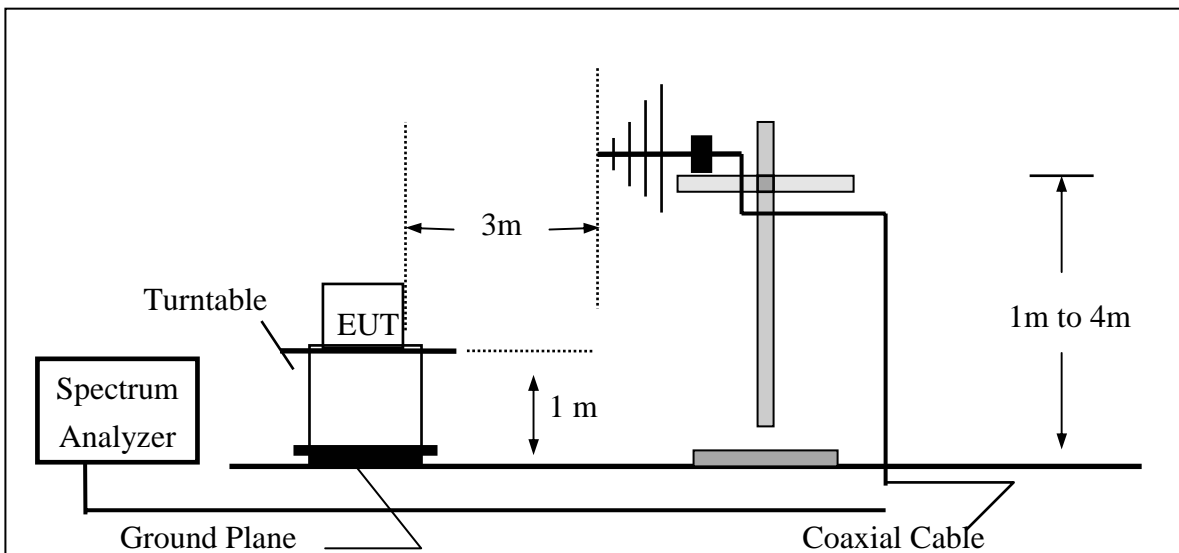

(B) Radiated Emission Test Set-UP Frequency Over 1 GHz

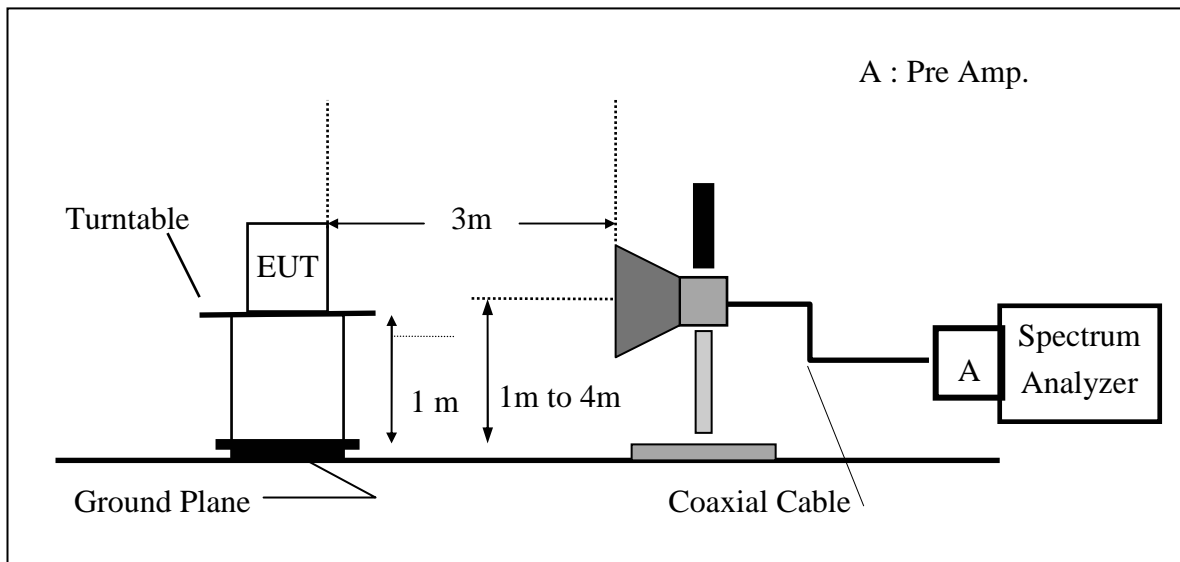

(C) Substituted Method Test Set-UP

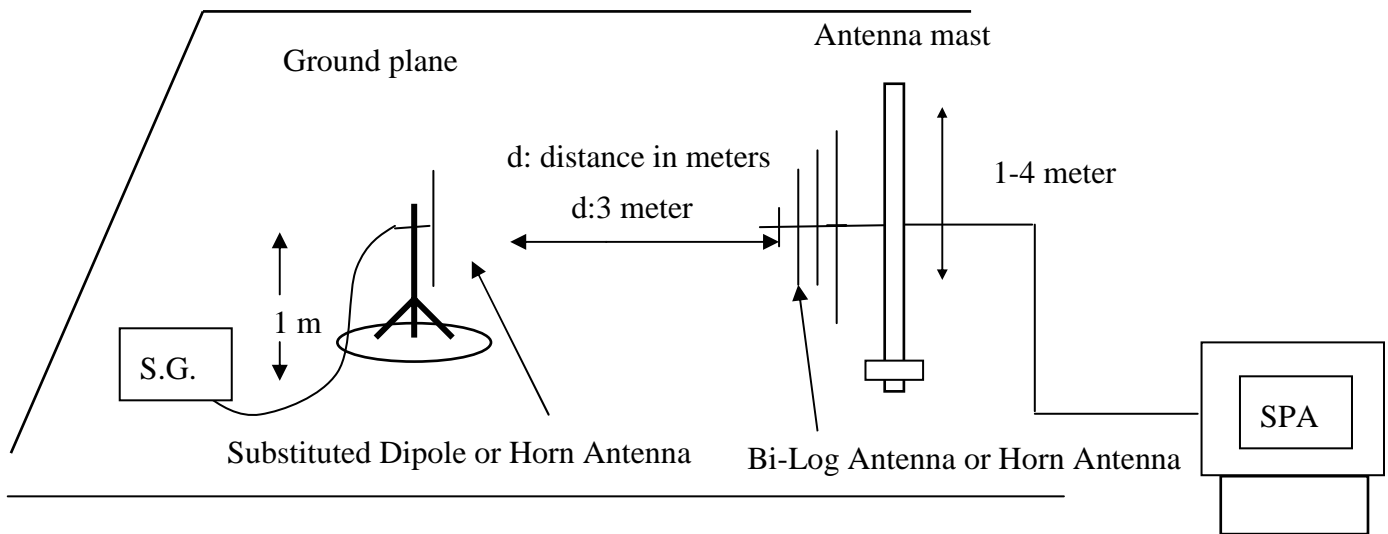

9.3 Measurement Procedure

The EUT was placed on a non-conductive, The measurement antenna was placed at a distance of 3 meters from the EUT. During the tests, the antenna height and the EUT azimuth were varied in order to identify the maximum level of emissions from the EUT. This maximization process was repeated with the EUT positioned in each of its three orthogonal orientations.

The frequency range up to tenth harmonic was investigated for each of three fundamental frequency (low, middle and high channels). Once spurious emission were identified, the power of the emission was determined using the substitution method.

The spurious emissions attenuation was calculated as the difference between radiated power at the fundamental frequency and the spurious emissions frequency.

$$EIRP = S.G. \text{ output (dBm)} + \text{Antenna Gain(dBi)} - \text{Cable (dB)}$$

9.4 Measurement Equipment Used:

Open Area Test Site # 3					
EQUIPMENT TYPE	MFR	MODEL NUMBER	SERIAL NUMBER	LAST CAL.	CAL DUE.
Spectrum Analyzer	Agilent	E4446A	US42510252	04/28/2003	04/27/2004
Spectrum Analyzer	R&S	FSP30	100112	6/29/2002	6/28/2003
Pre-Amplifier	HP	8447D	2944A09173	03/04/2003	03/03/2004
Bi-log Antenna	SCHWAZBECK	VULB9163	145	07/06/2002	07/05/2003
Horn antenna	EMCO	3115	00022250	2/25/2003	2/26/2004
Pre-Amplifier	HP	8449B	3008B00965	10/01/2002	10/02/2003
Reject Filter	Micro-Tronics	HPM13194	003	4/28/2003	4/27/2004
Low Loss Cable#40	HUBER+SUHNER	SUCOFLEX 104EPA-10M	19431	4/9/2003	4/8/2004
Turn Table	EMCO	2081-1.21	9709-1885	N.C.R	N.C.R
Antenna Tower	EMCO	2075-2	9707-2060	N.C.R	N.C.R
Controller	EMCO	2090	9709-1256	N.C.R	N.C.R
Site NSA	C&C	N/A	N/A	09/07/2002	09/06/2003
S.G.	HP	83630B	3844A01022	1/15/2003	1/14/2004
Low Loss Cable#38	HUBER+SUHNER	SUCOFLEX 104EPA-6M	19443	4/9/2003	4/8/2004
Substituted Dipole	SCHWAZBECK	VHAP/UHAP	998 +999/ 981+982	06/13/2002	06/12/2003
Substituted Horn	EMCO	3115	00022256	2/25/2003	2/26/2004

9.5 Measurement Result

Refer to attach tabular data sheets.

Radiated Spurious Emission Measurement Result

Operation Mode	:TX CH Low Y Mode	Test Date	:Jun,5 2003
Fundamental Frequency	:1851.25MHz	Test By	:Robin
Temperature	:30°C	Pol	:Ver
Humidity	:55%		

Freq. (MHz)	Ant. Pol.	EUT Pol.	SPA	S.G	Antenna (dBi)	Cable (dB)	EIRP (dBm)	Limit (dBm)	Margin (dB)
			Reading (dBuV)	Output (dBm)					
3702.50	H	Y	-51.74	-44.8	9.2	2.75	-38.35	-13	-25.35
5553.75	H	Y	--	--	--	--	--	-13	
7405.00	H	Y	--	--	--	--	--	-13	
9256.25	H	Y	--	--	--	--	--	-13	
11107.50	H	Y	--	--	--	--	--	-13	
12958.75	H	Y	--	--	--	--	--	-13	
14810.00	H	Y	--	--	--	--	--	-13	
16661.25	H	Y	--	--	--	--	--	-13	
18512.50	H	Y	--	--	--	--	--	-13	

Remark :

- (1) Measuring frequencies from 30 MHz to the 10th harmonic of highest fundamental frequency.
- (2) Datas of measurement within this frequency range shown “ - ” in the table above means the reading of emissions are attenuated more than 20dB below the permissible limits or the field strength is too small to be measured.
- (3) Spectrum Setting :
30MHz- 1GHz, RBW= 100KHz, VBW= 100kHz, Sweep time= 200 ms.
1GHz- 26GHz, RBW= 1MHz, VBW= 1MHz, Sweep time= 200 ms.
- (4) X Mode means the EUT in stand-up position; Y ,ZMode means the EUT in lie-on position

Radiated Spurious Emission Measurement Result

Operation Mode	:TX CH Mid Y Mode	Test Date	:Jun,5 2003
Fundamental Frequency	:1880MHz	Test By	:Robin
Temperature	:30	Pol	:Ver
Humidity	:55%		

Freq. (MHz)	Ant. Pol.	EUT Pol.	SPA Reading (dBuV)	S.G Output (dBm)	Antenna (dBi)	Cable (dB)	EIRP (dBm)	Limit (dBm)	Margin (dB)
3760.00	H	Y	-47.82	-40.69	8.5	2.75	-34.94	-13	-21.94
5640.00	H	Y	--	--	--	--	--	-13	
7520.00	H	Y	--	--	--	--	--	-13	
9400.00	H	Y	--	--	--	--	--	-13	
11280.00	H	Y	--	--	--	--	--	-13	
13160.00	H	Y	--	--	--	--	--	-13	
15040.00	H	Y	--	--	--	--	--	-13	
16920.00	H	Y	--	--	--	--	--	-13	
18800.00	H	Y	--	--	--	--	--	-13	

Remark :

- (1) Measuring frequencies from 30 MHz to the 10th harmonic of highest fundamental frequency.
- (2) Datas of measurement within this frequency range shown “ - ” in the table above means the reading of emissions are attenuated more than 20dB below the permissible limits or the field strength is too small to be measured.
- (3) Spectrum Setting :
 30MHz- 1GHz, RBW= 100KHz, VBW= 100kHz, Sweep time= 200 ms.
 1GHz- 26GHz, RBW= 1MHz, VBW= 1MHz, Sweep time= 200 ms.
- (4) X Mode means the EUT in stand-up position; Y,Z Mode means the EUT in lie-on position

Radiated Spurious Emission Measurement Result

Operation Mode	:TX CH High Y Mode	Test Date	:Jun,5 2003
Fundamental Frequency	:1908.75MHz	Test By	:Robin
Temperature	:30	Pol	:Ver
Humidity	:55%		

Freq. (MHz)	Ant. Pol.	EUT Pol.	SPA	S.G	Antenna (dBi)	Cable (dB)	EIRP (dBm)	Limit (dBm)	Margin (dB)
			Reading (dBuV)	Output (dBm)					
3817.50	H	Y	-38.75	-31.72	8.5	2.75	-25.97	-13	-12.97
5726.25	H	Y	--	--	--	--	--	-13	
7635.00	H	Y	--	--	--	--	--	-13	
9543.75	H	Y	--	--	--	--	--	-13	
11452.50	H	Y	--	--	--	--	--	-13	
13361.25	H	Y	--	--	--	--	--	-13	
15270.00	H	Y	--	--	--	--	--	-13	
17178.75	H	Y	--	--	--	--	--	-13	
19087.50	H	Y	--	--	--	--	--	-13	

Remark :

- (1) Measuring frequencies from 0 MHz to the 10th harmonic of highest fundamental frequency.
- (2) Datas of measurement within this frequency range shown “ - ” in the table above means the reading of emissions are attenuated more than 20dB below the permissible limits or the field strength is too small to be measured.
- (3) Spectrum Setting :
30MHz- 1GHz, RBW= 100KHz, VBW= 100kHz, Sweep time= 200 ms.
1GHz- 26GHz, RBW= 1MHz, VBW= 1MHz, Sweep time= 200 ms.
- (4) X Mode means the EUT in stand-up position; Y,Z Mode means the EUT in lie-on position

10. FREQUENCY STABILITY V.S. TEMPERATURE MEASUREMENT

10.1 Standard Applicable

According to FCC §2.1055, FCC §24.235.

Frequency Tolerance: 2.5 ppm

10.2 Test Set-up:

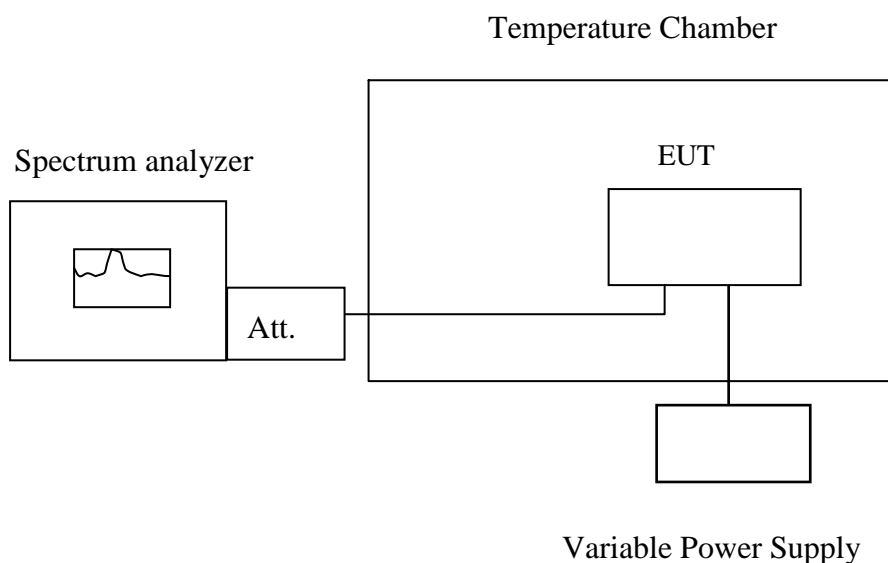

Note : Measurement setup for testing on Antenna connector

10.3 Measurement Procedure

The equipment under test was connected to an external AC or DC power supply and input rated voltage. RF output was connected to a frequency counter or spectrum analyzer via feed through attenuators. The EUT was placed inside the temperature chamber. Set the spectrum analyzer RBW low enough to obtain the desired frequency resolution and measure EUT 25°C operating frequency as reference frequency. Turn EUT off and set the chamber temperature to -30°C. After the temperature stabilized for approximately 30 minutes recorded the frequency. Repeat step measure with 10°C increased per stage until the highest temperature of +50°C reached.

10.4 Measurement Equipment Used:

EQUIPMENT TYPE	MFR	Model No.	Serial No.	LAST CAL.	Cal. Due.
DC Power Source	Agilent	E3640A	MY40001774	1/13/2003	1/12/2004
Temperature Chamber	K.son	THS-M1	242	3/21/2003	3/20/2004
Spectrum Analyzer	Agilent	E4446A	US42510252	04/28/2003	04/27/2004
Spectrum Analyzer	R&S	FSP30	100112	6/29/2002	6/28/2003
Attenuator	Mini circle	20dB	N/A	05/15/2003	05/14/2004
low loss cable#32	Huber + Suhner	SUCOFLEX 104EPA-6M	19428	4/9/2003	4/8/2004

10.5 Measurement Result

Reference Frequency: CDMA Mid Channel 1880 MHz @ 25				
Limit: +/- 2.5 ppm = 4700 Hz				
Power Supply	Environment	Frequency	Delta (Hz)	Limit (Hz)
Vdc	Temperature ()	(MHz)		
3.7	50	1879.998329	-204.60	4700
3.7	40	1879.998267	-143.00	4700
3.7	30	1879.998145	-21.00	4700
3.7	25	1879.998124	0.00	4700
3.7	20	1879.998117	7.00	4700
3.7	10	1879.997903	221.00	4700
3.7	0	1879.997846	278.39	4700
3.7	-10	1879.997653	471.00	4700
3.7	-20	1879.997627	497.00	4700
3.7	-30	1879.997243	881.00	4700

11. FREQUENCY STABILITY V.S. VOLTAGE MEASUREMENT

11.1 Standard Applicable

According to FCC §2.1055, FCC §24.235,

Frequency Tolerance: 2.5 ppm

11.2 Test Set-up:

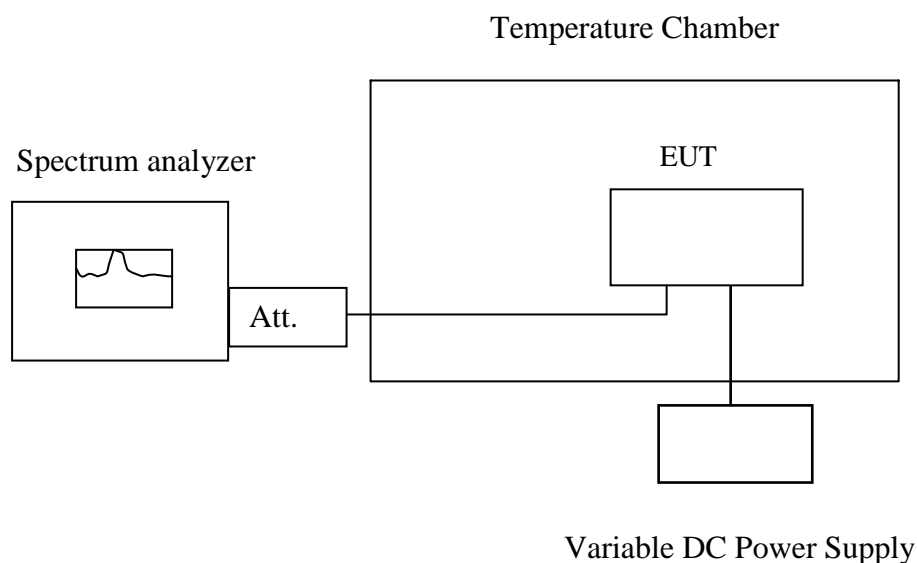

Note: Measurement setup for testing on

11.3 Measurement Procedure

Set chamber temperature to 25 °C. Use a variable AC power supply / DC power source to power the EUT and set the voltage to rated voltage. Set the spectrum analyzer RBW low enough to obtain the desired frequency resolution and recorded the frequency.

Reduce the input voltage to specified extreme voltage variation (+/- 15%) and endpoint, record the maximum frequency change.

11.4 Measurement Equipment Used:

EQUIPMENT TYPE	MFR	Model No.	Serial No.	LAST CAL.	Cal. Due.
DC Power Source	Agilent	E3640A	MY40001774	1/13/2003	1/12/2004
Temperature Chamber	K.son	THS-M1	242	3/21/2003	3/20/2004
Spectrum Analyzer	Agilent	E4446A	US42510252	04/28/2003	04/27/2004
Spectrum Analyzer	R&S	FSP30	100112	6/29/2002	6/28/2003
Attenuator	Mini circle	20dB	N/A	05/15/2003	05/14/2004
Low loss cable#32	Huber + Suhner	SUCOFLEX 104EPA-6M	19428	4/9/2003	4/8/2004

11.5 Measurement Result

Reference Frequency: CDMA Mid Channel 1880 MHz @ 25				
Limit: +/- 2.5 ppm = 4700 Hz				
Power Supply	Environment	Frequency	Delta (Hz)	Limit (Hz)
Vdc	Temperature ()	(MHz)		
3.7	25	1879.998124	0	4700
3.145	25	1879.998950	-826	4700
4.255	25	1879.999275	-1151	4700
2.79 (End Point)	25	1879.999436	-1312	4700

12. CONDUCTED EMISSION TEST

12.1 Standard Applicable

According to §15.207. The emission value for frequency within 150KHz to 30MHz shall not exceed criteria of below chart.

Frequency range MHz	Limits dB(uV)	
	Quasi-peak	Average
0.15 to 0.50	66 to 56	56 to 46
0.50 to 5	56	46
5 to 30	60	50

Note

- 1.The lower limit shall apply at the transition frequencies
- 2.The limit decreases linearly with the logarithm of the frequency in the range 0.15 MHz to 0.50 MHz.

12.2 EUT Setup

1. The conducted emission tests were performed in the test site, using the setup in accordance with the ANSI C63.4-1992.
2. The EUT was plug-in DC power adaptor and was placed on the center of the back edge on the test table. The peripherals like earphone was placed on the side of the EUT. The rear of the EUT and peripherals were placed flushed with the rear of the tabletop.
3. The Power adaptor was connected with 110Vac/60Hz power source.

12.3 Measurement Procedure

1. The EUT was placed on a table which is 0.8m above ground plane.
2. Maximum procedure was performed on the six highest emissions to ensure EUT compliance.
3. Repeat above procedures until all frequency measured were complete.

12.4 Measurement Equipment Used:

Conducted Emission Test Site # 4					
EQUIPMENT TYPE	MFR	MODEL NUMBER	SERIAL NUMBER	LAST CAL.	CAL DUE.
EMI Test Receiver	R&S	ESHS30	828144/003	08/08/2002	08/07/2003
LISN	R&S	ESH2-Z5	843285/010	12/16/2002	12/15/2003
LISN	EMCO	3825/2	9003-1628	07/26/2002	07/25/2003
Spectrum Analyzer	ADVANTEST	R3261A	91720031	N/A	N/A
2X2 WIRE ISN	R&S	ENY22	100020	06/20/2002	06/19/2003
FOUR WIRE ISN	R&S	ENY41	100006	06/20/2002	06/19/2003

12.5 Measurement Result

The initial step in collecting conducted data is a spectrum analyzer peak scan of the measurement range. Significant peaks are then marked as shown on the following data page, and these signals are then quasi-peaked.

LINE CONDUCTED TEST**Model Number:** C260**Tested by:** Robin**Test Mode:** normal operating**Detector Function:** Quasi-Peak**Temperature:** 22°C**Humidity:**58%RH

(The chart below shows the highest readings taken from the final data)

FREQ MHz	Q.P. Raw dBuV	AVG Raw dBuV	Q.P. Limit dBuV	AVG Limit dBuV	Q.P. Margin dB	AVG Margin dB	NOTE
0.159	28.33	20.96	65.52	55.52	-37.19	-34.56	L1
0.153	19.58	18.77	65.84	55.84	-46.26	-37.07	L1
0.168	22.40	21.16	65.06	55.06	-42.66	-33.90	L1
0.224	11.66	11.47	62.67	52.67	-51.01	-41.20	L1
0.566	10.68	2.07	56.00	46.00	-45.32	-43.93	L1
0.631	9.89	8.26	56.00	46.00	-46.11	-37.74	L1
0.150	16.15	15.02	66.00	56.00	-49.85	-40.98	L2
0.159	19.81	17.18	65.52	55.52	-45.71	-38.34	L2
0.168	23.63	22.79	65.06	55.06	-41.43	-32.27	L2
0.193	16.82	13.40	63.91	53.91	-47.09	-40.51	L2
0.230	10.08	9.63	62.45	52.45	-52.37	-42.82	L2
0.298	6.05	5.84	60.30	50.30	-54.25	-44.46	L2

Remark :

- (1) Measuring frequencies from 0.15 MHz to 30MHz.
- (2) The emissions measured in frequency range from 0.15 MHz to 30MHz were made with an instrument using Quasi-Peak detector and Average detector.
- (3) “---” denotes the emission level was or more than 2dB below the Average limit, so no re-check anymore.
- (4) The IF bandwidth of SPA between 0.15MHz to 30MHz was 10KHz;
The IF bandwidth of Test Receiver between 0.15MHz to 30MHz was 9KHz;
- (5) L1 = Line One (Hot side) / L2 = Line Two (Neutral side)

Conducted Emission Test Plot

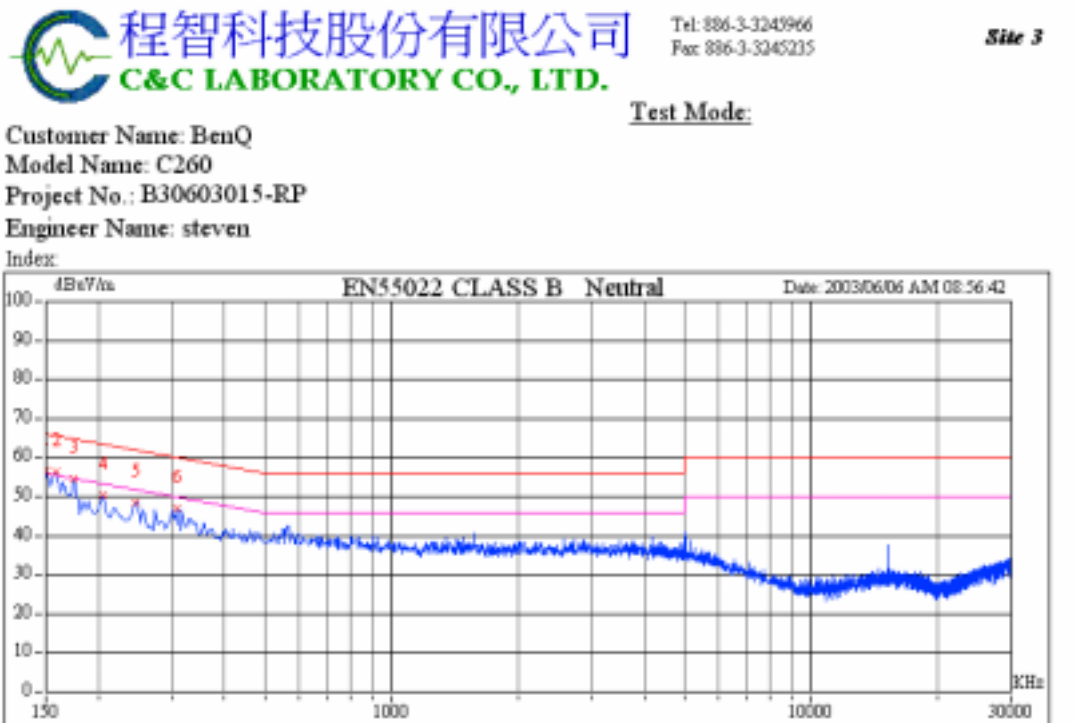
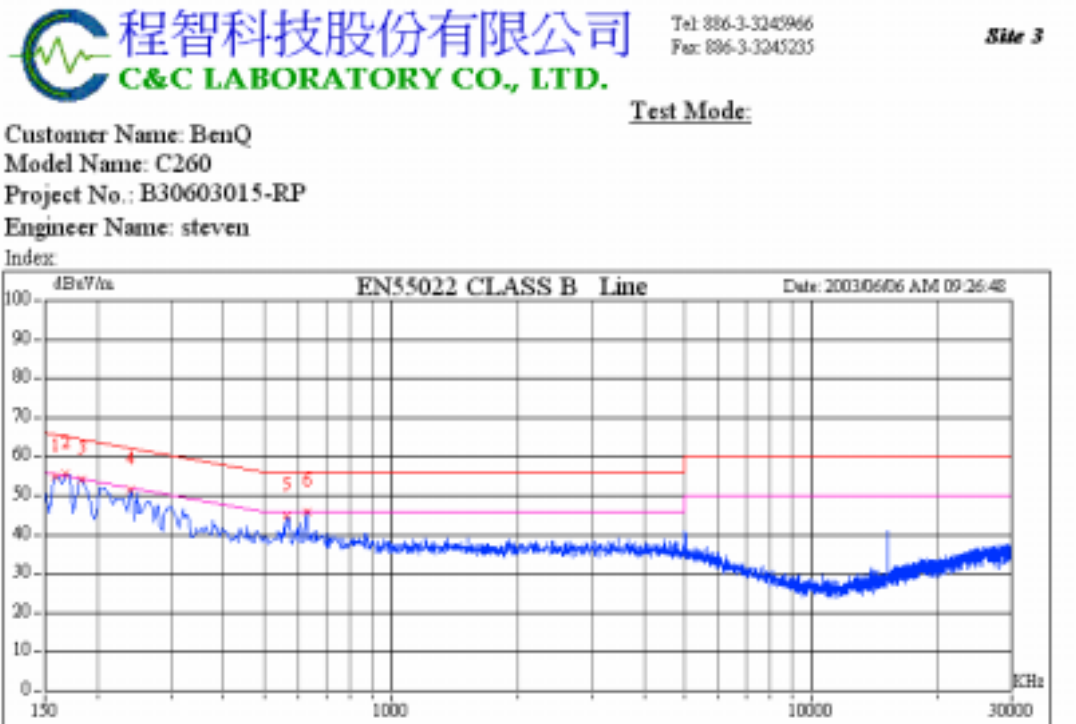

APPENDIX 1

PHOTOGRPHS OF SET UP

Radiated Emission Set up Photos



Conducted Emission Set Up Photos



APPENDIX 2

EXTERNAL PHOTOGRPHS OF EUT

Front View of EUT



Back View of EUT



Left View of EUT



Right View of EUT



Top View of EUT



Open View of EUT



Front View of Adaptor



Back View of Adaptor



Earphone



APPENDIX 3

INTERNAL PHOTOGRPHS OF EUT

Internal of EUT --- 1



Internal of EUT --- 2



Internal of EUT --- 3



Internal of EUT --- 4

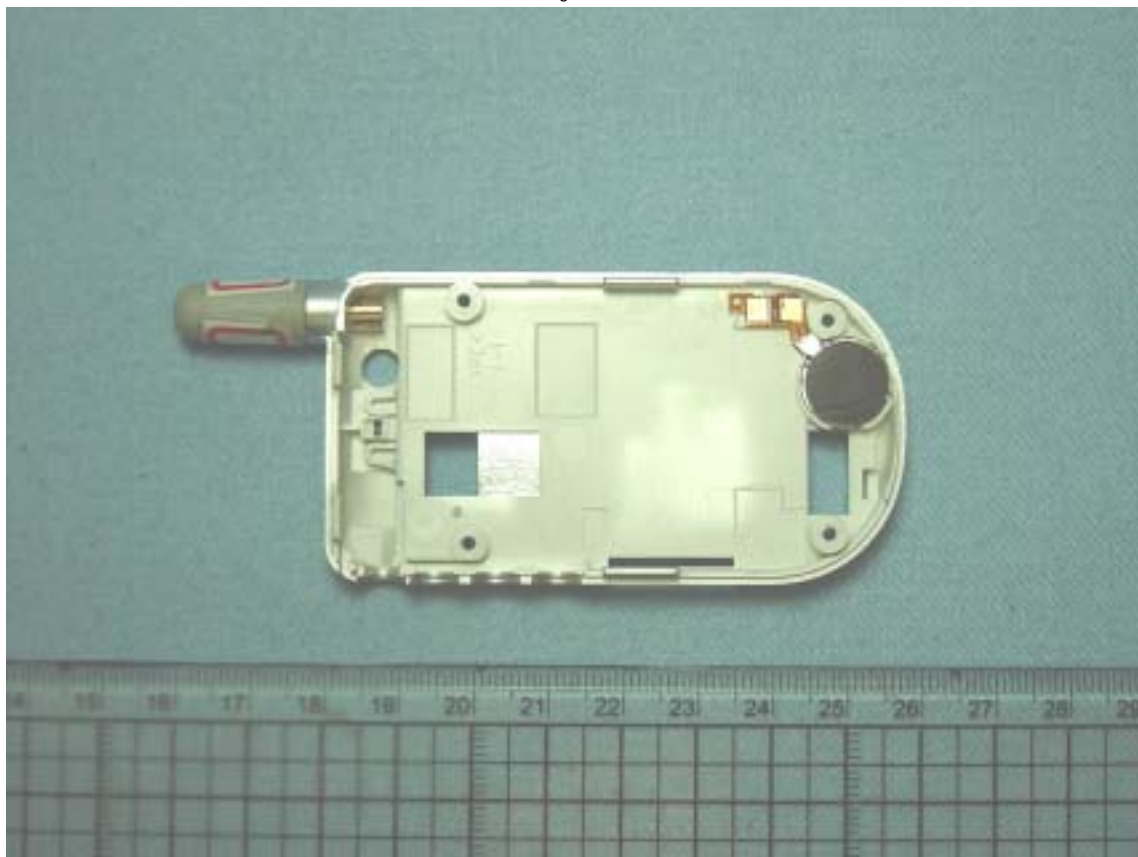

Internal of EUT --- 5



Internal of EUT --- 6



Internal of EUT --- 7



Internal of EUT --- 8

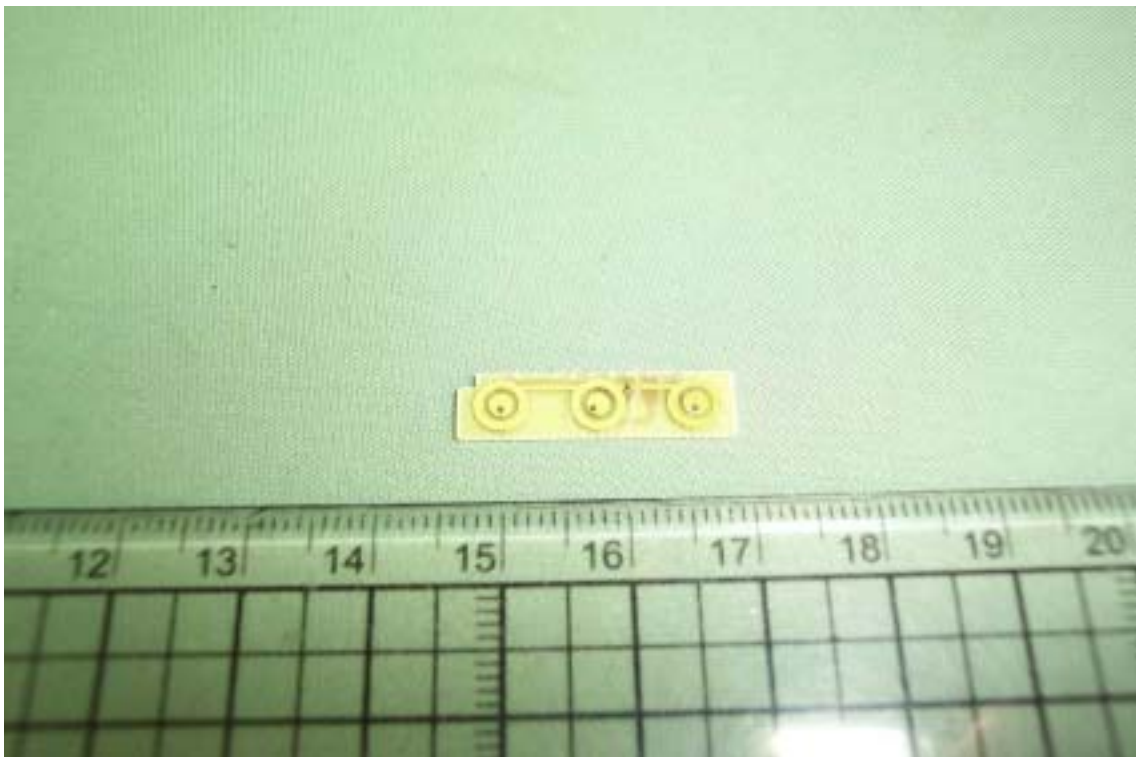

Internal of EUT --- 9



Internal of EUT --- 10

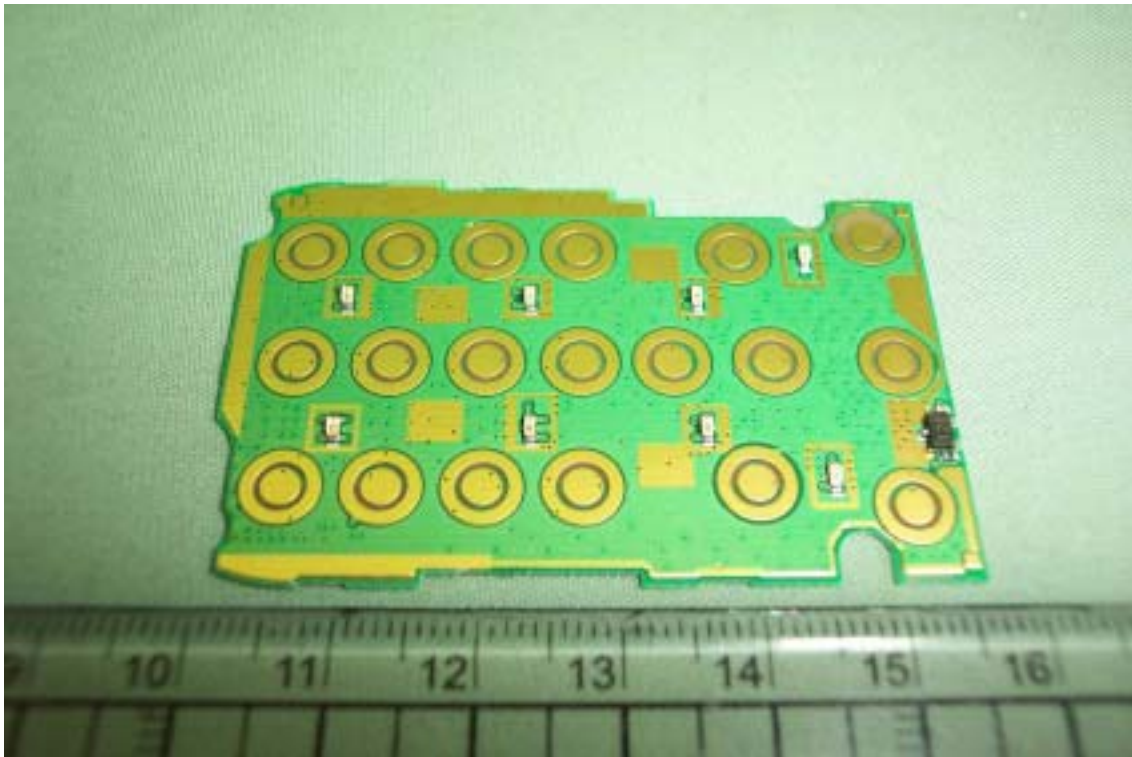

Internal of EUT --- 11

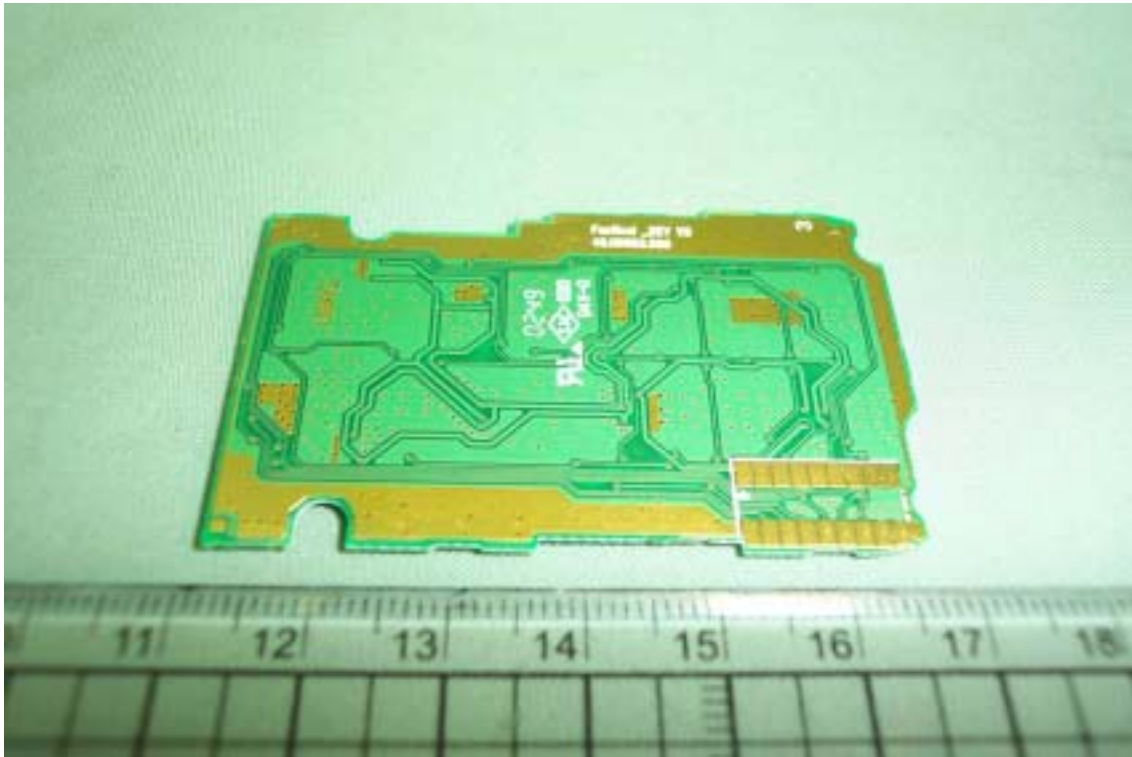

Internal of EUT --- 12



Internal of EUT --- 13



Internal of EUT --- 14

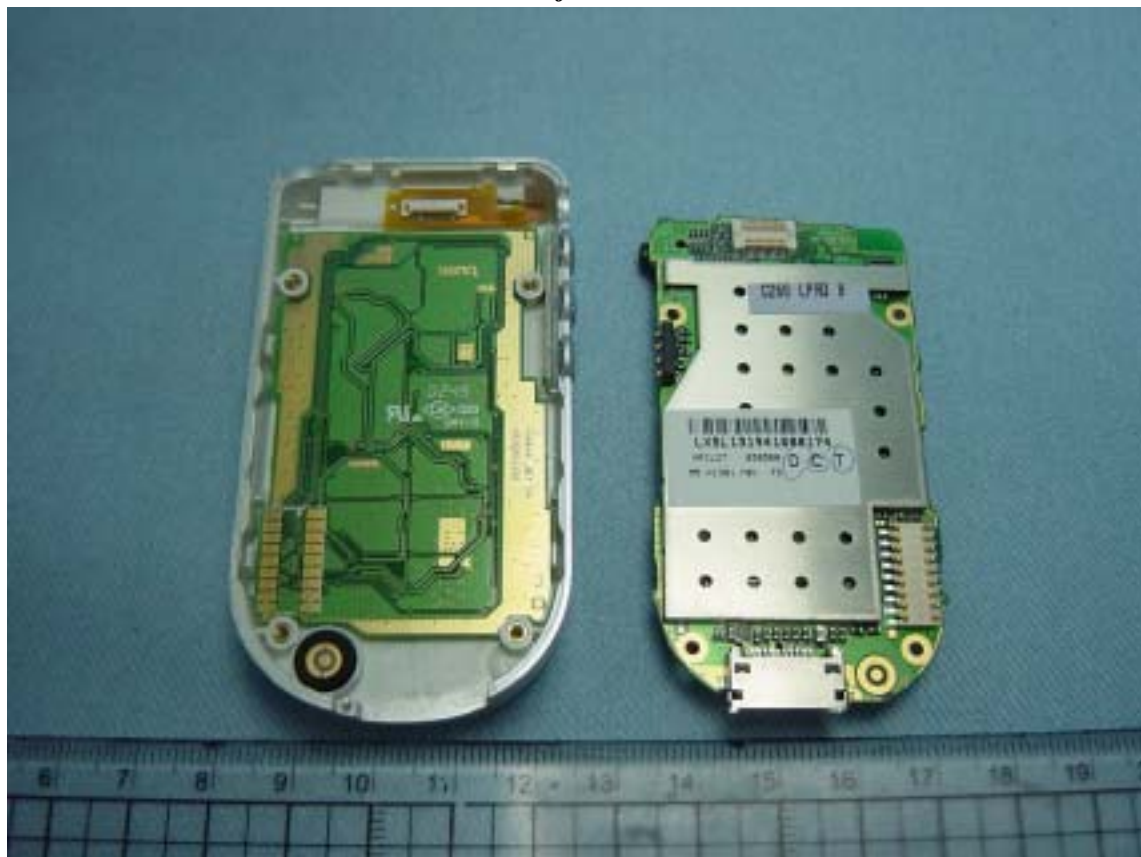

Internal of EUT --- 15

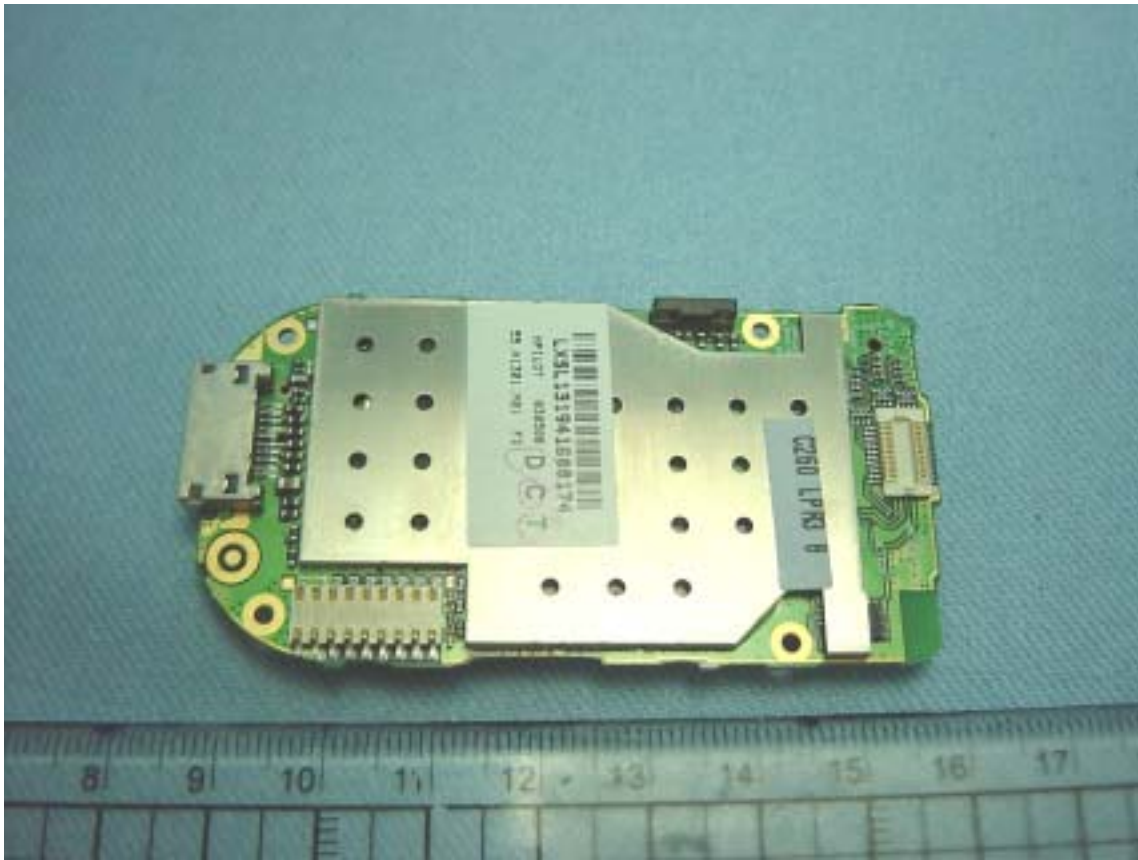

Internal of EUT --- 16

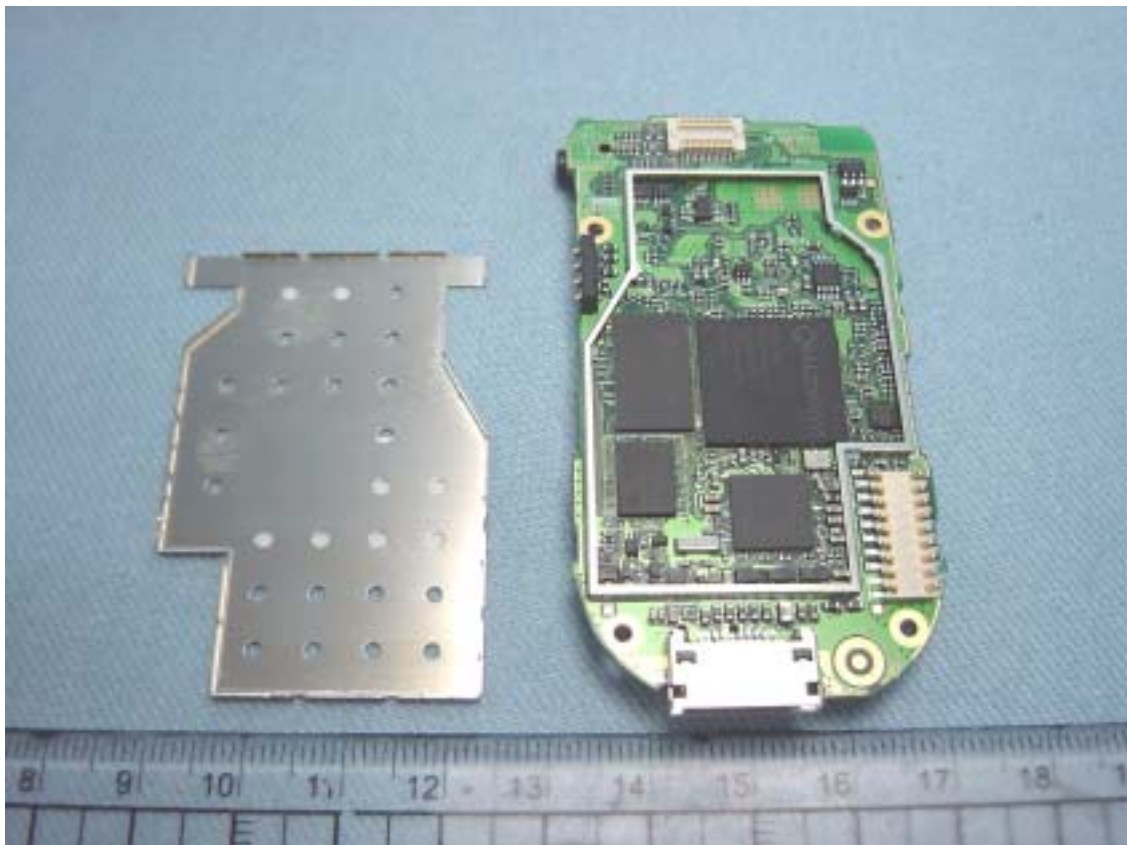

Internal of EUT --- 17

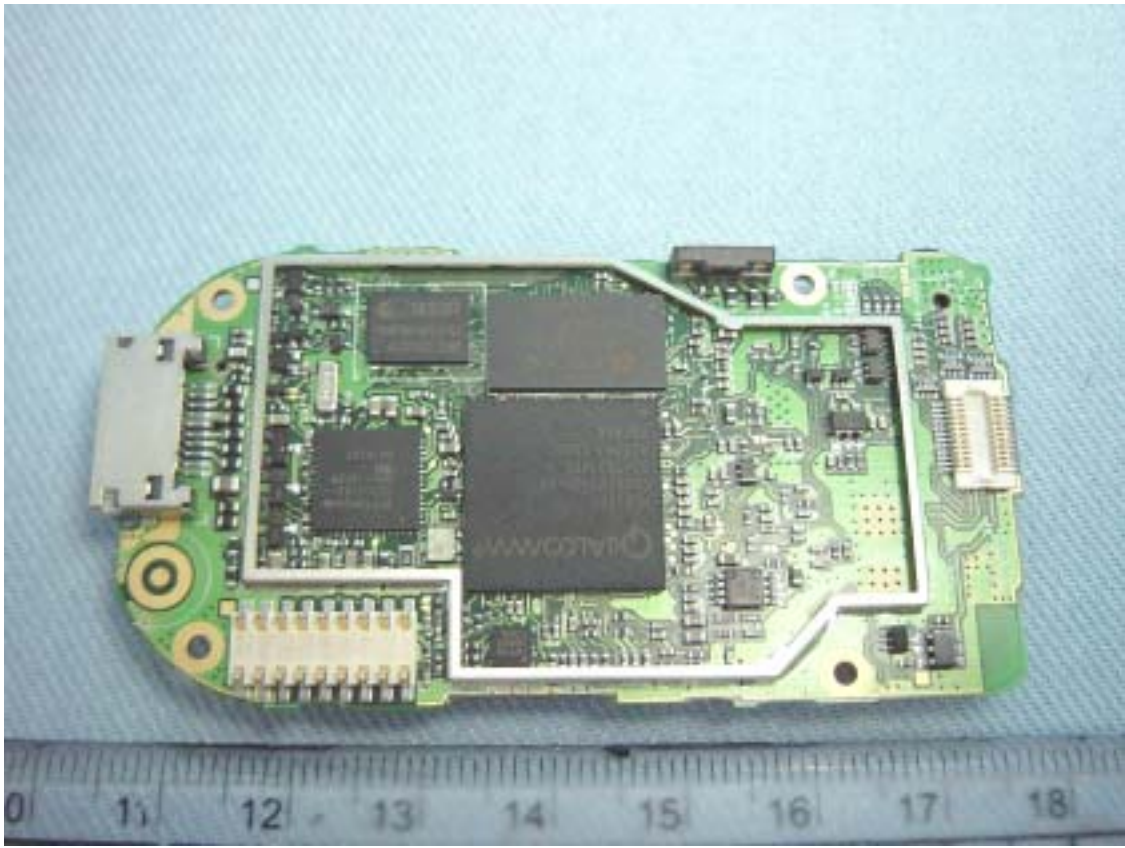

Internal of EUT --- 18

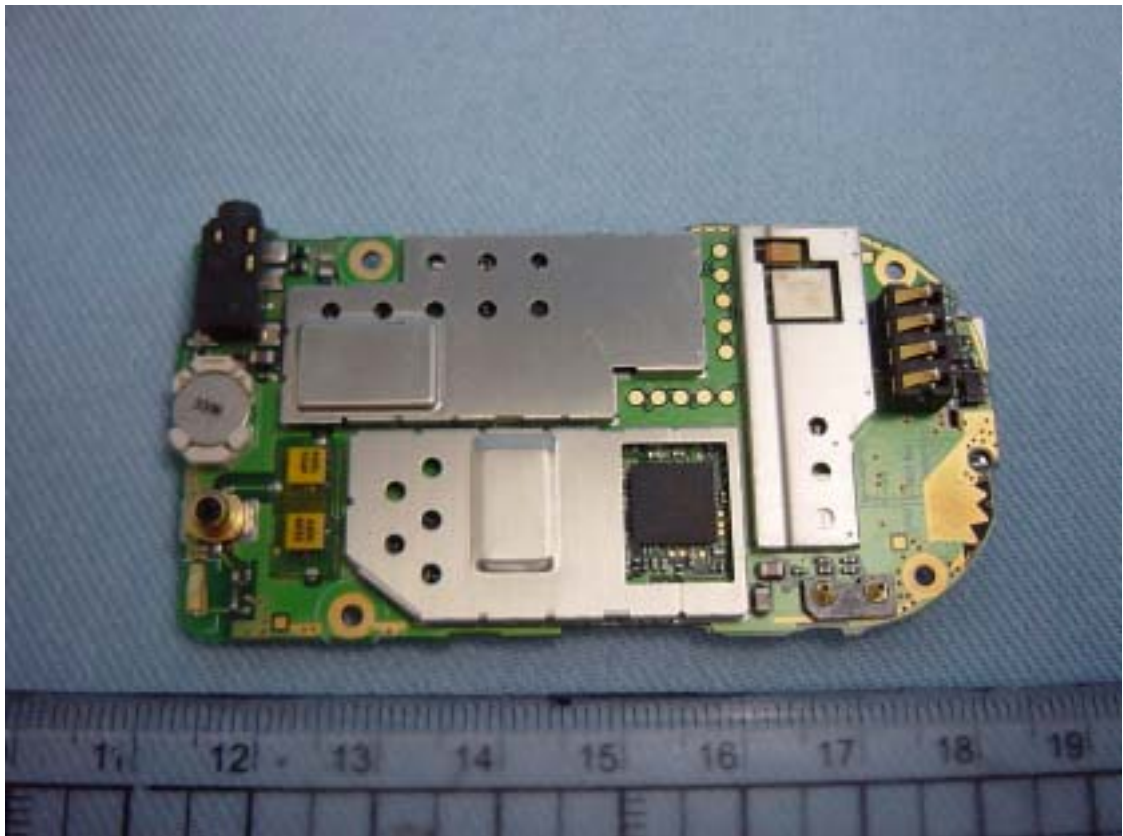

Internal of EUT --- 19

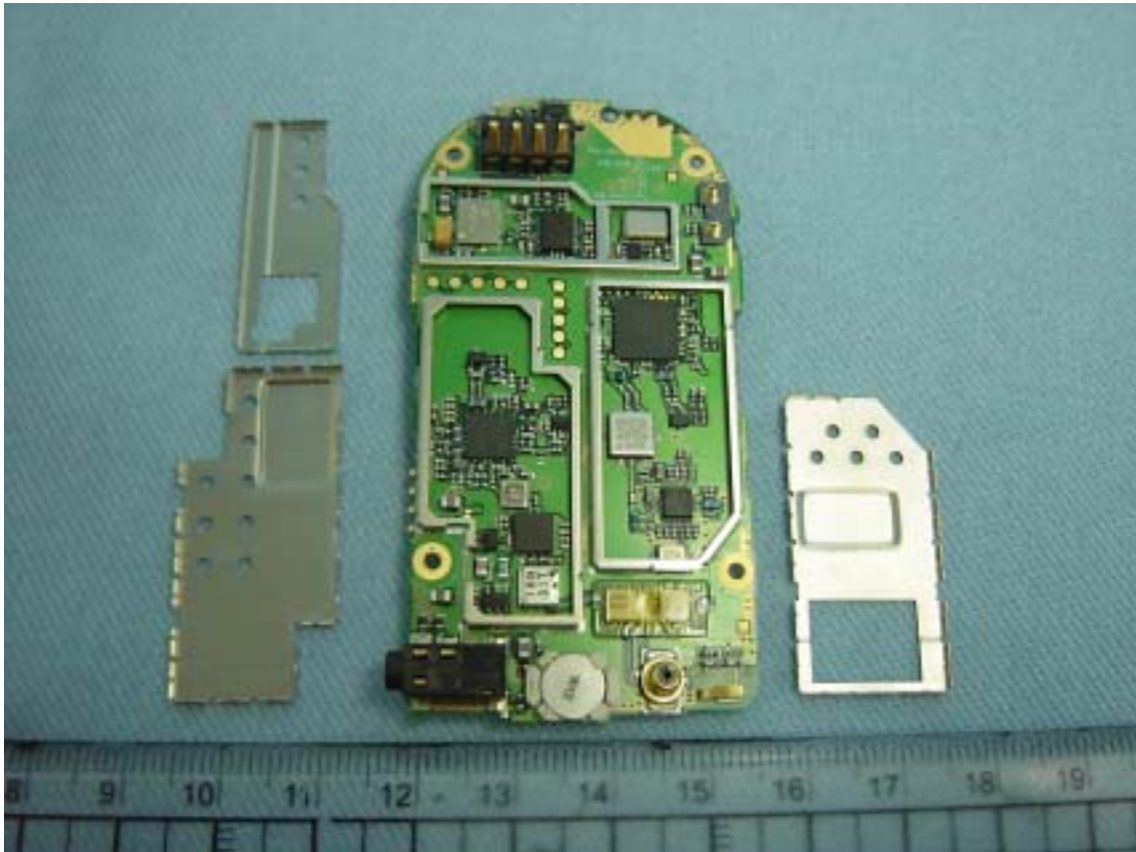

Internal of EUT --- 20



Internal of EUT --- 21



Internal of EUT --- 22



Internal of EUT --- 23



Internal of EUT --- 24

