



6660-B Dobbin Road • Columbia, MD 21045 • U.S.A.  
 TEL (410) 290-6652 • FAX (410) 290-6654  
<http://www.pctestlab.com>



## CERTIFICATE OF COMPLIANCE (SAR EVALUATION)

Benq Corporation  
 157 Shan-Ying Road Kweishan  
 Taoyuan 333  
 TAIWAN, R.O.C.  
 Attn: Mr. George Chiou  
 Technical Manager

Dates of Tests: Jan. 9-10, 2002  
 Test Report S/N: SAR.220110006.JVP  
 Test Site: PCTEST Lab, Columbia, MD USA

FCC ID

**JVPH0622**

APPLICANT

**Benq Corporation**

EUT Type: Dual-Mode Cellular Phone (AMPS/CDMA)  
 Tx Frequency: 824.04 – 848.97 MHz (AMPS) / 824.70 – 848.31 MHz (CDMA)  
 Rx Frequency: 869.04 – 893.97 MHz (AMPS) / 869.70 – 893.31 MHz (CDMA)  
 Max. RF Output Power: 0.424W ERP AMPS (26.273 dBm)  
 0.344W ERP CDMA (25.373 dBm)  
 Trade Name/Model(s): **BENQ ACTON**  
 FCC Classification: Non-Broadcast Transmitter Held to Ear (TNE)  
 Application Type: Certification  
 FCC Rule Part(s): §2.1093; ET Docket 96.326  
 Maximum SAR: 1.4395 W/kg AMPS Brain SAR; 0.8122 W/kg AMPS Body SAR;  
 1.1917 W/kg CDMA Brain SAR; 0.7064 W/kg CDMA Body SAR;



This wireless portable device has been shown to be compliant for localized specific absorption rate (SAR) for uncontrolled environment/general population exposure limits specified in ANSI/IEEE Std. C95.1-1992 and has been tested in accordance with the measurement procedures specified in ANSI/IEEE Std. C95.3-1992. (See Test Report)

I attest to the accuracy of data. All measurements reported herein were performed by me or were made under my supervision and are correct to the best of my knowledge and belief. I assume full responsibility for the completeness of these measurements and vouch for the qualifications of all persons taking them.

PCTEST certifies that no party to this application has been denied the FCC benefits pursuant to Section 5301 of the Anti-Drug Abuse Act of 1988, 21 U.S.C. 862.

  
 Randy Ortanez  
 President

**SAR. 220110006. JVP**

**NVLAQ**<sup>®</sup>  
 LAB CODE 100431-0

# Table of Contents

1.1 SCOPE .....	1
2.1 INTRODUCTION.....	2
2.2 SAR Definition .....	2
3.1 SAR MEASUREMENT SET-UP .....	3
4.1 ISOTROPIC E-FIELD PROBE SYSTEM.....	4
5.1 E-FIELD PROBE CALIBRATION PROCESS.....	5
6.1 PHANTOM AND EQUIVALENT TISSUES .....	7
7.1 SYSTEM SPECIFICATIONS .....	8
8.1 MEASUREMENT PROCESS.....	9
9.1 TEST POSITIONS OF THE PHONE .....	10
10.1 BODY-WORN TEST SETUP.....	11
11.1 ANSI/IEEE C95.1 - 1992 RF EXPOSURE LIMITS .....	12
12.1 MEASUREMENT UNCERTAINTIES.....	13
13.1 SAR TEST DATA SUMMARY.....	14
14.1 SAR TEST EQUIPMENT .....	24
15.1 CONCLUSION .....	25

# SAR MEASUREMENT REPORT

## 1.1 SCOPE

*Environmental evaluation measurements of specific absorption rate<sup>1</sup> (SAR) distributions in simulated human tissues exposed to radiofrequency (RF) radiation from wireless portable devices for compliance with the rules and regulations of the U.S. Federal Communications Commission (FCC).<sup>2</sup>*

<b>Applicant Name:</b>	<b>Benq Corporation</b>
<b>Address:</b>	<b>157 Shan-Ying Road Kweishan Taoyuan 333 TAIWAN, R.O.C.</b>
<b>Attention:</b>	<b>Mr. George Chiou Technical Manager</b>

EUT Type: Dual-Mode Cellular Phone (AMPS/CDMA)

Trade Name: **BENQ**

Model(s): **ACTON**

FCC IDENTIFIER: **JVPH0622**

Tx Frequency: 824.04 – 848.97 MHz (AMPS)  
824.70 – 848.31 MHz (CDMA)

Rx Frequency: 869.04 – 893.97 MHz (AMPS)  
869.70 – 893.31 MHz (CDMA)

Application Type: Certification

FCC Classification: Non-Broadcast Transmitter Held to Ear (TNE)

FCC Rule Part(s): § 2.1093, Docket 96-326

Modulation(s): AMPS/CDMA

Max RF. Output Power: 0.424W ERP AMPS (26.273 dBm)  
0.344W ERP CDMA (25.373 dBm)

Date(s) of Tests: Jan. 9-10, 2002

Place of Tests: PCTEST Engineering Lab.  
Columbia, MD, U.S.A.

Report Serial No.: SAR.220110006.JVP



**Fig. 1**  
**SAR Test Setup**



<sup>1</sup> Specific Absorption Rate (SAR) is a measure of the rate of energy absorption due to exposure to an RF transmitting source (wireless portable device).

<sup>2</sup> IEEE/ANSI Std. C95.1-1992 limits are used to determine compliance with FCC ET-Docket 93-62.

## 2.1 INTRODUCTION

---

The FCC has adopted the guidelines for evaluating the environmental effects of radio frequency radiation in ET Docket 98-62 on Aug. 6, 1996 to protect the public and workers from the potential hazards of RF emissions due to FCC-regulated portable devices.[1]

The safety limits used for the environmental evaluation measurements are based on the criteria published by the American National Standards Institute (ANSI) for localized specific absorption rate (SAR) in *IEEE/ANSI C95.1-1992 Standard for Safety Levels with Respect to Human Exposure to Radio Frequency Electromagnetic Fields, 3 kHz to 300 GHz*. (c) 1992 by the Institute of Electrical and Electronics Engineers, Inc., New York, New York 10017.[2] The measurement procedure described in *IEEE/ANSI C95.3-1992 Recommended Practice for the Measurement of Potentially Hazardous Electromagnetic Fields - RF and Microwave*[3] is used for guidance in measuring SAR due to the RF radiation exposure from the Equipment Under Test (EUT). These criteria for SAR evaluation are similar to those recommended by the National Council on Radiation Protection and Measurements (NCRP) in *Biological Effects and Exposure Criteria for Radiofrequency Electromagnetic Fields*," NCRP Report No. 86 (c) NCRP, 1986, Bethesda, MD 20814.[4] SAR is a measure of the rate of energy absorption due to exposure to an RF transmitting source. SAR values have been related to threshold levels for potential biological hazards.

## 2.2 SAR Definition

Specific Absorption Rate (SAR) is defined as the time derivative (rate) of the incremental energy ( $dU$ ) absorbed by (dissipated in) an incremental mass ( $dm$ ) contained in a volume element ( $dV$ ) of a given density ( $r$ ). It is also defined as the rate of RF energy absorption per unit mass at a point in an absorbing body (see Fig. 2).

$$SAR = \frac{d}{dt} \left( \frac{dU}{dm} \right) = \frac{d}{dt} \left( \frac{dU}{r dV} \right)$$

Figure 2. SAR Mathematical Equation

**SAR is expressed in units of Watts per Kilogram (W/kg).**

$$SAR = s E^2 / r$$

where:

- $s$  = conductivity of the tissue-simulant material (S/m)
- $r$  = mass density of the tissue-simulant material (kg/m<sup>3</sup>)
- $E$  = Total RMS electric field strength (V/m)

NOTE: The primary factors that control rate of energy absorption were found to be the wavelength of the incident field in relations to the dimensions and geometry of the irradiated organism, the orientation of the organism in relation to the polarity of field vectors, the presence of reflecting surfaces, and whether conductive contact is made by the organism with a ground plane.[4]

### 3.1 SAR MEASUREMENT SET-UP

PCTEST Lab SAR measurement system consists of completely automated robotics system, cell controller (Pentium Pro 200 computer), E-field probe, and phantom containing the brain equivalent material. The robot is a six-axis industrial robot performing precise movements to position the probe to the location (points) of maximum electromagnetic field (EMF) (see Fig. 3).

The Robot table consists of the power supply, robot controller, safety computer, teach pendant (Joystick), six-axis robot arm, and the probe. The cell controller consists of PCTEST Pentium-Pro 200 MHz computer with Windows NT system and SAR Measurement software, National Instruments analog card, NEC monitor, keyboard, and mouse. The robot controller is connected to the cell controller to communicate between the two computers. The probe data is connected to the cell controller via high-impedance carbon-fiber cable to avoid field distortions and minimize external noise from interfering with the data.

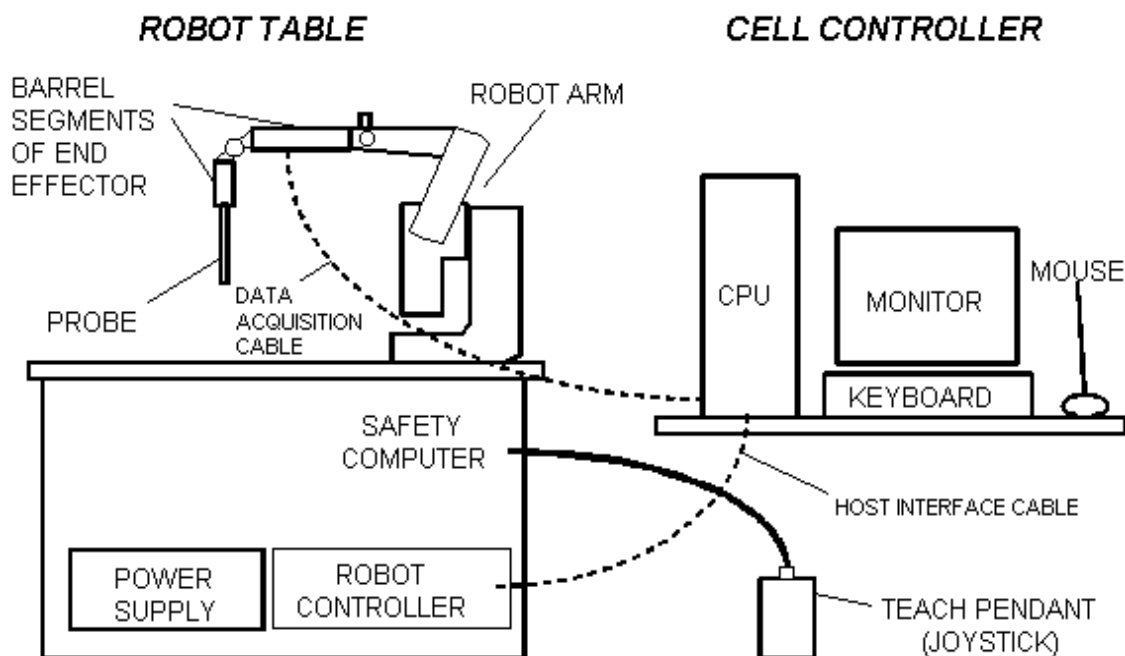

Figure 3. PCTEST Robotics SAR Test Measurement Set-up

When the Robot is in the home position, the Y-axis of the coordinate system parallels the line of intersection between the tabletop and the long axis of the Robot's Large Shoulder. The Teach Pendant may be used to establish the X,Y coordinate directions by depressing the 0X and 0Y MOTOR/AXIS switches while in axis mode.

The robot is first taught to position the probe sensor following a specific pattern of points. In the first sweep the sensor enclosure touches the inside of the phantom head. The SAR is measured on a defined grid of points that are concentrated on the surface of the head closest to the antenna of the transmitting device (EUT).

## 4.1 ISOTROPIC E-FIELD PROBE SYSTEM

### 4.2 E-Field Probe

The near-field probe is an implantable isotropic E-field probe that measures the voltages proportional to the  $|E|^2$  (electric) or  $|H|^2$  (magnetic) fields. The probe is enclosed in a hollow plastic protective cylinder 9mm. outer diameter, 0.5 mm. thickness and 30 cm. in length. This SAR measurement system and the probe are similar to the one developed by Motorola.[8] The E-probe contains three electrically small array of orthogonal dipoles strategically placed to provide greater accuracy and to compensate for near-field spatial gradients. The probe contains diodes that are placed over the gap of the dipoles to improve RF detection. The electrical signal detected by each diode is amplified by three dc amplifiers and are contained in a shielded container in the robot end effector so its performance is not affected by the presence of incident electromagnetic fields (see Fig. 4).

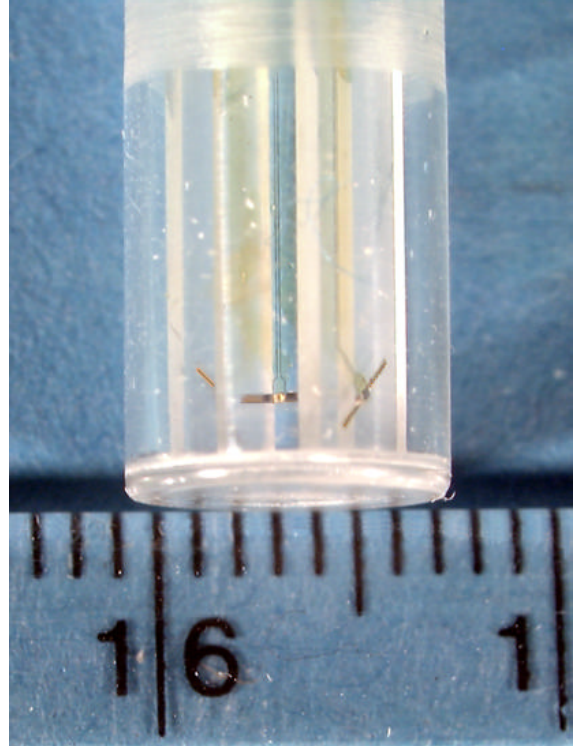

Figure 4. Isotropic E-field Probe



Figure 5. Photograph of the Probe and the Phantom

(See Section 6.2 for E-Probes Specifications)

## 5.1 E-FIELD PROBE CALIBRATION PROCESS

### 5.2 E-Probe Calibration

Each E-Probe/Probe amplifier combination has unique calibration parameters. A TEM calibration procedure is conducted to determine the proper amplifier settings to enter in the probe parameters. The amplifier settings are determined for a given frequency by subjecting the Probe to a known E-field density (1mW/cm<sup>2</sup>) using an RF Signal generator, TEM cell, and RF Power Meter. The SAR measurement software is used for Probe calibration (see Fig. 6).

Calibration is performed in two steps:

The free space E-field from amplified probe outputs is determined in a test chamber. This calibration can be performed in a TEM cell if the frequency is below 1 GHz and in a waveguide or some other methodologies above 1 GHz for free space. For the free space calibration, we place the probe in the volumetric center of the cavity and at the proper orientation with the field. We then rotate the probe 360 degrees until the three channels show the maximum reading. The power density readings equates to 1mW/cm<sup>2</sup>.

E-field temperature correlation calibration is performed in a flat phantom filled with the appropriate simulated brain tissue. The measured free space E-field in the medium correlates to temperature rise in a dielectric medium.

For temperature correlation calibration, a RF transparent thermistor-based temperature probe is used in conjunction with the E-field probe. The location of the maximum E-field close to the phantom's bottom is determined as a function of power into the RF source; in this case, a dipole. The E-field probe is moved sideways so that the temperature probe, while affixed to the E-field probe, is placed at the previous location of power levels used for the E-field measurement are recorded. The following equation related SAR to initial temperature slope:

$$SAR = C \frac{\Delta T}{\Delta t} \quad \text{where:}$$

$\Delta t$  = exposure time (30 seconds),

C = heat capacity of tissue (brain or muscle),

$\Delta T$  = temperature increase due to RF exposure.

SAR is proportional to  $\Delta T / \Delta t$ , the initial rate of tissue heating, before thermal diffusion takes place. Now it's possible to quantify the electric field in the simulated tissue by equating the thermally derived SAR to the E-field;

$$SAR = \frac{|E|^2 \cdot \sigma}{P} \quad \text{where:}$$

$\sigma$  = simulated tissue conductivity,

P = Tissue density (1.25 g/cm<sup>3</sup> for brain tissue)

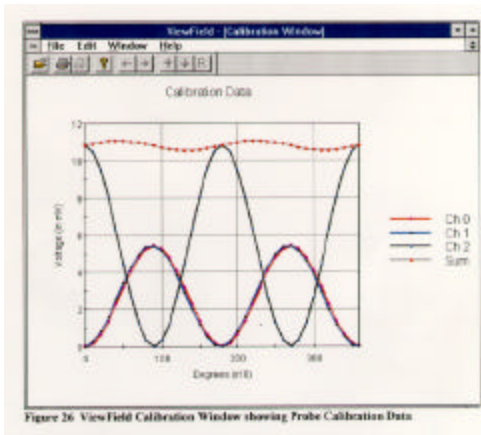

Figure 6. Probe Calibration Data in ViewField Window



### 5.3 Data Extrapolation

The probe offset is determined by measuring the distance between the center of the sensor to the end of the protective tube. The data is collected when the probe outer surface make contact with the surface of the phantom and measures the corresponding field in the simulated tissue near the shell surface. An average slope is obtained from these data points nearest the surface and is used to define an exponential decay of the energy density with the depth.

The field attenuation versus depth is recorded and extrapolated to obtain the  $|E|^2$  value at the surface of the phantom where the maximum SAR is located.

$$Slope = \frac{\frac{E_{total} \cdot Z_1}{E_{total} \cdot Z_2} + \frac{E_{total} \cdot Z_2}{E_{total} \cdot Z_3}}{2}$$

$$\exp = \ln(slope) \frac{offset}{spacing}$$

$$E_{total} \cdot Z_0 = E_{total} \cdot Z_1 \cdot e^{\exp}$$

### 5.4 Interpolation and Gram Averaging

The 1 cm. voltage ( $E_{total} 1cm$ ) above the phantom's surface is needed to calculate the exposure of one gram of tissue. The SAR value (mW/g) estimates the average over a one gram cube obtained from the extrapolated value ( $E_{total} Z_0$ ) and interpolated value ( $E_{total} 1cm$ ) obtained by interpolation as shown below.

$$SAR(mW / g) = \frac{E_{total} \cdot Z_0 + E_{total} 1cm}{2} \cdot \frac{CF}{SensorFactor}$$

$$SensorFactor = \frac{10.8 mV}{mW / cm^2} = \frac{0.0108V}{mW / cm^2}$$

Conversion Factor (CF) = *intermediate scaling constant for a particular probe which produced an output of 10.8 mV in the TEM cell when the flux density is 1 mW/cm<sup>2</sup>*



## 6.1 PHANTOM AND EQUIVALENT TISSUES

### 6.2 Phantom

The phantom is an anatomically shaped homogeneous torso model filled with a liquid simulating brain or muscle tissue. The phantom is placed at 0 degrees (horizontal position) with the left/right ear placed on the EUT (see Fig. 5). The phantom is made of a shell of fiberglass 1.5mm thick (giving the worst case SAR value absorbed by brain or muscle tissue and the skull bones) and the EUT supported by a non-metallic (delrin) material\*. Similar phantoms have been used to simulate human head modeling studies[6][7].

### 6.3 Brain & Muscle Simulating Mixture Characterization

The brain & muscle mixture consist of a viscous gel using hydroxyethylcellulose (HEC) gelling agent and saline solution (see Table 1). Preservation with a bactericide is added and visual inspection is made to make sure air bubbles are not trapped during the mixing process. The mixture is calibrated to obtain proper dielectric constant (permittivity) and conductivity of the brain or muscle. The mixture characterizations used for the brain or muscle tissue simulating liquid are according to the data by C. Gabriel and G. Hartsgrve [9].

Ingredients (% by weight)	Frequency (MHz)									
	450		835		915		1900		2450	
Tissue Type	Head	Body	Head	Body	Head	Body	Head	Body	Head	Body
Water	38.56	51.16	41.45	52.4	41.05	56.0	54.9	40.4	62.7	73.2
Salt (NaCl)	3.95	1.49	1.45	1.4	1.35	0.76	0.18	0.5	0.5	0.04
Sugar	56.32	46.78	56.0	45.0	56.5	41.76	0.0	58.0	0.0	0.0
HEC	0.98	0.52	1.0	1.0	1.0	1.21	0.0	1.0	0.0	0.0
Bactericide	0.19	0.05	0.1	0.1	0.1	0.27	0.0	0.1	0.0	0.0
Triton X-100	0.0	0.0	0.0	0.0	0.0	0.0	0.0	0.0	36.8	0.0
DGBE	0.0	0.0	0.0	0.0	0.0	0.0	44.92	0.0	0.0	26.7

Salt: 99% Pure Sodium Chloride      Sugar: 98% Pure Sucrose  
 Water: De-ionized, 16 MΩ resistivity      HEC: Hydroxyethyl Cellulose  
 DGBE: 99% Di(ethylene glycol) butyl ether, [2-(2-butoxyethoxy)ethanol]  
 Triton X-100 (ultra pure): Polyethylene glycol mono [4-(1,1,3,3-tetramethylbutyl)phenyl] ether

Table 1. Composition of the Brain & Muscle Tissue Equivalent Matter\*\*

\* Note: A simulating human hand is not used due to the complex anatomical and geometrical structure that may produce an infinite number of configurations [8]. To produce the worst-case condition (the hand absorbs antenna output power), the hand is omitted during the tests.

\*\* OET 65 Supplement C

## 7.1 SYSTEM SPECIFICATIONS

---

### 7.2 Robotic System Specifications

#### Specifications

POSITIONER: IDX Robot with 6 axis  
Repeatability: 0.002 in.  
Accuracy: 0.004 in.

#### Data Acquisition

Processor: Pentium PRO CPU  
Clock Speed: 200 MHz  
Operating System: Windows NT  
Data Card: National Instruments Analog Card  
Software: IDX Flexware  
AMPLIFIER GAIN: Adjustable 20 - 40, high isolation between channels  
Connecting Lines: High Impedance 4.5 kohm/foot  
Sample Rate: 6000

#### E-Field Probe

##### E-Probe #PCT486C

Probe Offset: 2.0 mm  
Frequency Band: 150 - 2500 MHz  
Dynamic Response: 2  $\mu$ W/g - 10 mW/g  
Input: 2.2 meg  
Isotropy:  $\pm$  0.5 dB  
Resolution: 0.1 cm<sup>3</sup>

#### Phantom

	<u>Phantom #1 (Left)</u>	<u>Phantom #2 (Right)</u>
Phantoms:	Anthropomorphic	Anthropomorphic
Shell Material:	Vivac Composite	Vivac Composite
Thickness:	2 $\pm$ 0.2 mm	2 $\pm$ 0.2 mm
Head:	Left ear	Right ear

##### Tissue Parameters

	<u>835 MHz</u> (Brain)	<u>835 MHz</u> (Muscle)
Dielectric Constant: $\epsilon$	41.5	56.1
Conductivity: $\sigma$	0.90	0.95

## 8.1 MEASUREMENT PROCESS

The measurement process consists of the process parameters, probe parameters, EUT product data, and measurement scans (teach points). The measurement process is a set of predefined points to be scanned and measured by the probe, DC amplified and process by the cell controller. The corresponding voltages determined by the electric and magnetic fields are extrapolated to determine peak SAR value.

## 8.2 Area & Zoom Scan Grids

The SAR Measurement System measures field strength by employing three different types of systematic measurement scans; an Area scan, a Zoom Scan, and an SAR scan. Area and Zoom scans measure field strength in a rectangular area within the XY plane (a plane parallel to the top of the Robot Table). The measurement area is divided into a grid of small squares defined by equally spaced grid lines. During an actual measurement process, the probe moves along grid lines systematically recording the field strength at grid line intersections. Typically, after an Area scan is completed, a Zoom scan is conducted at the peak field strength value (hot spots) that was measured in the Area scan. The Zoom scan usually has a greater resolution (smaller grid squares) than the Area scan, and covers only a fraction of the measurement area in the Area Scan (see Fig. 6).

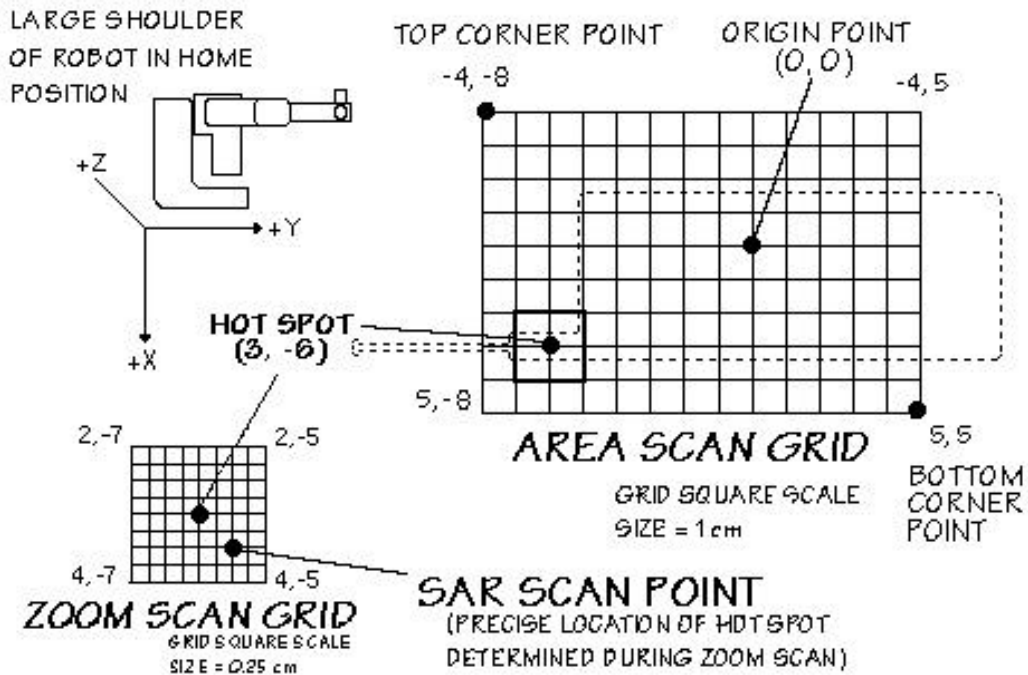

Figure 7. SAR Measurement Points in Area Scan and Zoom Scan Grids Showing the Typical Hot Spot with respect to the Phone

## 9.1 TEST POSITIONS OF THE PHONE

### 9.2 Handset Test Positions

The test device was placed in a normal operating position with the "test device reference point" located along the "vertical centerline" on the front of the device aligned to the "ear reference point" (See Fig. 11). The "test device reference point" was then located at the same level as the center of the earpiece region. The test device was positioned so that the "vertical centerline" was bisecting the front surface of the handset at its top and bottom edges, positioning the "ear reference point" on the outer surface of the both the left and right head phantoms on each ear spacer.

### 9.3 EAR Reference Point

The test device was initially positioned with the earpiece region pressed against the ear spacer of both the left & right head phantoms. The device was positioned parallel to the cheek for maximum RF energy coupling. The "test device reference point" was aligned to the "ear reference point" on both head phantoms and the "vertical centerline" was aligned to the "phantom reference plane". (See Fig. 12). While maintaining these three alignments, the body of the test device was gradually adjusted to both of the following positions for SAR evaluation [5]:

#### A. Cheek / Touch Position

For Cheek/Touch Position, the test device was brought toward the mouth of the both head phantoms by pivoting against the "ear reference point" of the head phantoms. The test position was established:

- When any point on the display, keypad or mouthpiece portions of the test device was in contact with the head phantom, or
- When any portion of a foldout, sliding or similar keypad cover opened to its intended self-adjusting normal use position was in contact with the cheek or mouth of the head phantom.

When the test device lost contact with the phantom at the pivoting point, rotation continued until the device touched the cheek of the head phantom or broke its last contact from the ear spacer (See Figure 13).

#### B. Ear / 15° Tilt Position

With the test device aligned in the "Cheek/Touch Position":

- If the earpiece of the test device was not in full contact with the head phantom's ear spacer in the Cheek/Touch Position and the peak SAR location for the "Cheek/Touch" position was located at the ear spacer region or corresponded to the earpiece region of the test device, the device was returned to the "initial ear position" by rotating it away from the mouth until the earpiece was in full contact with the ear spacer, otherwise
- The test device was moved (translated) away from the cheek perpendicular to the line that passes through both the "ear reference points". While in this position, the handset was tilted away from the mouth with respect to the "test device reference point" by 15°. After the tilt, the test device was then moved (translated) back toward the head perpendicular to the line spacer. If the antenna touched the head phantom first, then the positioning process was repeated with a tilt angle less than 15° so that the device and its antenna touched the phantom simultaneously.

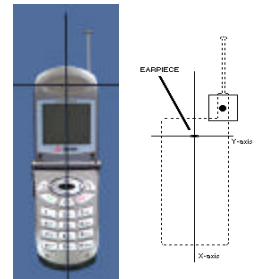

Fig. 8  
Ear Reference Point

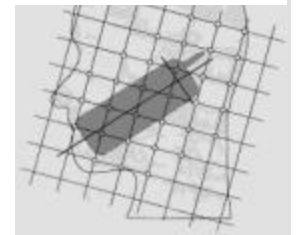

Fig. 9  
Grid Scan Reference

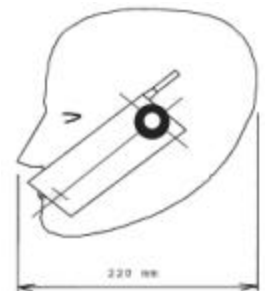

Fig. 10  
Cheek/Touch Position

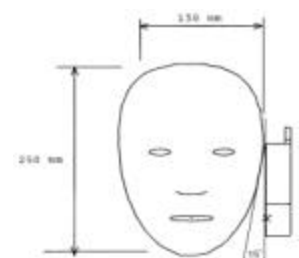

Figure 11.  
Ear/15° Tilt Position

## 10.1 BODY-WORN TEST SETUP

### 10.2 Ear-Microphone Jack

Portable transmitting devices that have an Ear-Microphone jack must be evaluated for RF exposure in a body-worn configuration. The testing is performed with the use of a torso phantom filled with muscle equivalent tissue. The EUT is positioned with the keypad facing away from the phantom, and the Ear-Microphone wires attached to the phone jack, simulating the device placed in a shirt pocket or attached to a body holster. The SAR tests are then performed in both the antenna in and antenna out positions using the low, middle, and high channels to investigate the worst case SAR value (see figure 11). Please note that Body-worn configurations that have not been SAR tested may result in operating conditions that could exceed FCC RF exposure limits, therefore, users are cautioned to use tested and/or approved accessories.

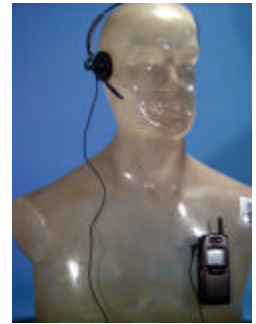

Figure 12.  
Ear-Microphone Jack

#### A. Shirt Pocket Configuration

The shirt pocket configuration is used for devices designed to be body-worn, and small enough to be placed inside a shirt pocket. To simulate the worst-case configuration, the EUT is placed in a torso position on the phantom with the keypad facing away from the phantom, and the Ear-Microphone wire connected to the phone to simulate hands-free operation in a shirt-pocket configuration (see figure 12).



Figure 13.  
Shirt Pocket Configuration

#### B. Body Holster Configuration

The body holster configuration is used for body-worn devices that are supplied with a holster. Typically, a holster or carrying case is provided or available as an accessory item for supporting headset and body-worn operations. SAR may vary depending on the body separation distance provided by the type of holster and batteries supplied for a phone. In most cases, the antenna may become closer to the user's body than next to the head. The design of the holster permits the phone to be positioned only with the keypad facing away from the phantom. Proper usage of the holster restricts the antenna to a specified distance away from the surface of the body. For this test the EUT is placed into the holster and the holster is put against the torso of the phantom in a normal operating position. The Ear-Microphone cord is then connected to the phone to simulate hands free operation in a body holster configuration. (See Figure 13)



Figure 14.  
Body Holster Configuration

#### C. Other Configurations

If other operating configurations are possible (i.e.: pants pocket, car adapter kit, etc), it will be indicated to users in the instruction manual about untested conditions and the possibility of exceeding FCC exposure limits for such use or the use of third-party accessories. If there is a high potential for exceeding limits in certain unintended configurations, a warning statement will be included in the manual warning the user to avoid such operating conditions.

## 11.1 ANSI/IEEE C95.1 - 1992 RF EXPOSURE LIMITS

---

HUMAN EXPOSURE	UNCONTROLLED ENVIRONMENT General Population (W/kg) or (mW/g)	CONTROLLED ENVIRONMENT Occupational (W/kg) or (mW/g)
SPATIAL PEAK SAR * (Brain)	1.60	8.00
SPATIAL AVERAGE SAR ** (Whole Body)	0.08	0.40
SPATIAL PEAK SAR *** (Hands / Feet / Ankle / Wrist)	4.00	20.00

**Table 2. Safety Limits for Partial Body Exposure [2]**

**NOTES:**

- \* The Spatial Peak value of the SAR averaged over any 1 gram of tissue (defined as a tissue volume in the shape of a cube) and over the appropriate averaging time.
- \*\* The Spatial Average value of the SAR averaged over the whole-body.
- \*\*\* The Spatial Peak value of the SAR averaged over any 10 grams of tissue (defined as a tissue volume in the shape of a cube) and over the appropriate averaging time.

**Uncontrolled Environments** are defined as locations where there is the exposure of individuals who have no knowledge or control of their exposure.

**Controlled Environments** are defined as locations where there is exposure that may be incurred by persons who are aware of the potential for exposure, (i.e. as a result of employment or occupation).

## 12.1 MEASUREMENT UNCERTAINTIES

---

Measurement uncertainties in SAR measurements are difficult to quantify due to several variables including biological, physiological, and environmental. However, we estimate the measurement uncertainties in SAR to be less than 15-25 %.

According to ANSI/IEEE C95.3, the overall uncertainty are difficult to assess and will vary with the type of meter and usage situation. However, accuracies of  $\pm 1$  to 3 dB can be expected in practice, with greater uncertainties in near-field situations and at higher frequencies (shorter wavelengths), or areas where large reflecting objects are present. Under optimum measurement conditions, SAR measurement uncertainties of at least  $\pm 2$ dB can be expected.[3]

According to CENELEC [5], typical worst-case uncertainty of field measurements is  $\pm 5$  dB. For well defined modulation characteristics, the uncertainty can be reduced to  $\pm 3$  dB.

Estimated Errors	Percent
Measurement of the Conductivity/Dielectric Constant of the Tissue Simulant	$\pm 5$ %
Temperature Rise Calibration of Probe	$\pm 5$ %
Measurement of Thermal Capacity of Tissue Simulant	$\pm 5$ %
Accuracy of a Repeatable Phone Position	$\pm 10$ %
Probe Isotropic Response	$\pm 12$ %
Total Root-Sum Square Calculation	$\pm 17.9$ %

Table 3. Breakdown of Individual Errors



### 13.1 SAR TEST DATA SUMMARY

Ambient TEMPERATURE (°C)	20.6
Liquid TEMPERATURE (°C)	20.1
Relative HUMIDITY (%)	53.4
Atmospheric PRESSURE (kPa)	101.0

**Measured Values:**

Mixture Type: Brain  
 Dielectric Constant: 41.5  
 Conductivity: 0.90  
 Liquid Depth: 15.0 cm

Closest Distance (between E-Probe & Antenna): 1.4 cm

### 13.2 Measurement Results (AMPS Head SAR)

FREQUENCY		Modulation	POWER (dBm)		Phantom Position	Antenna Position	SAR (W/kg)
MHZ	CH		Start	End			
824.04	991	AMPS	26.0	26.0	Left Tilt	Fixed	1.2068
836.49	383	AMPS	26.0	26.0	Left Tilt	Fixed	0.9844
848.97	799	AMPS	26.0	26.0	Left Tilt	Fixed	0.9530
<b>ANSI / IEEE C95.1 1992 - SAFETY LIMIT Spatial Peak Uncontrolled Exposure/General Population</b>						<b>Brain 1.6 W/kg (mW/g) averaged over 1 gram</b>	

**NOTES:**

- The test data reported are the worst-case SAR value with the antenna-head position set in a typical configuration.
- All modes of operation were investigated and the worst-case are reported.
- Battery condition is fully charged for all readings.
- Power Measured  Conducted  EIRP  ERP
- SAR Measurement System  SPEAG  IDX
- SAR Configuration  Head  Body  Hand

  
 Randy Ortanez  
 President



Fig. 14  
 Head SAR Test Setup

### 13.1 SAR TEST DATA SUMMARY (Continued)

Ambient TEMPERATURE (°C)	20.6
Liquid TEMPERATURE (°C)	20.1
Relative HUMIDITY (%)	53.4
Atmospheric PRESSURE (kPa)	101.0

**Measured Values:**

Mixture Type: Brain

Dielectric Constant: 41.5

Conductivity: 0.90

Liquid Depth: 15.0 cm

Closest Distance (between E-Probe & Antenna): 1.3 cm

### 13.3 Measurement Results (AMPS Head SAR)

FREQUENCY		Modulation	POWER (dBm)		Phantom Position	Antenna Position	SAR (W/kg)
MHZ	CH		Start	End			
824.04	991	AMPS	26.0	26.0	Right Tilt	Fixed	0.8419
836.49	383	AMPS	26.0	26.0	Right Tilt	Fixed	0.7072
848.97	799	AMPS	26.0	26.0	Right Tilt	Fixed	0.6890
<b>ANSI / IEEE C95.1 1992 - SAFETY LIMIT</b>						<b>Brain</b>	
<b>Spatial Peak</b>						<b>1.6 W/kg (mW/g)</b>	
<b>Uncontrolled Exposure/General Population</b>						averaged over 1 gram	

**NOTES:**

- The test data reported are the worst-case SAR value with the antenna-head position set in a typical configuration.
- All modes of operation were investigated and the worst-case are reported.
- Battery condition is fully charged for all readings.
- Power Measured  Conducted  EIRP  ERP
- SAR Measurement System  SPEAG  IDX
- SAR Configuration  Head  Body  Hand
- \* Extended Battery Measurement

  
 Randy Ortanez  
 President



Fig. 15  
 Head SAR Test Setup

## 13.1 SAR TEST DATA SUMMARY (Continued)

Ambient TEMPERATURE (°C)	20.6
Liquid TEMPERATURE (°C)	20.1
Relative HUMIDITY (%)	53.4
Atmospheric PRESSURE (kPa)	101.0

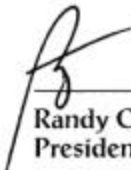
**Measured Values:**

Mixture Type:	Brain
Dielectric Constant:	41.5
Conductivity:	0.90
Liquid Depth:	15.0

Closest Distance (between E-Probe & Antenna): 1.6 cm

## 13.4 Measurement Results (AMPS Head SAR)

FREQUENCY		Modulation	POWER (dBm)		Phantom Position	Antenna Position	SAR (W/kg)
MHZ	CH		Start	End			
824.04	991	AMPS	26.0	26.0	Left Cheek	Fixed	1.4395
836.49	383	AMPS	26.0	26.0	Left Cheek	Fixed	1.2298
848.97	799	AMPS	26.0	26.0	Left Cheek	Fixed	1.2032
<b>ANSI / IEEE C95.1 1992 - SAFETY LIMIT</b>						<b>Brain</b>	
<b>Spatial Peak</b>						<b>1.6 W/kg (mW/g)</b>	
<b>Uncontrolled Exposure/General Population</b>						averaged over 1 gram	

**NOTES:**

- The test data reported are the worst-case SAR value with the antenna-head position set in a typical configuration.
- All modes of operation were investigated and the worst-case are reported.
- Battery condition is fully charged for all readings.
- Power Measured  Conducted  EIRP  ERP
- SAR Measurement System  SPEAG  IDX
- SAR Configuration  Head  Body  Hand
- \* Extended Battery Measurement

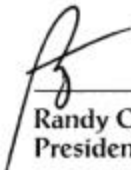
  
 Randy Ortanez  
 President

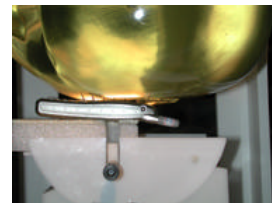

Fig. 16  
 Head SAR Test Setup

## 13.1 SAR TEST DATA SUMMARY (Continued)

Ambient TEMPERATURE (°C)	20.6
Liquid TEMPERATURE (°C)	20.1
Relative HUMIDITY (%)	53.4
Atmospheric PRESSURE (kPa)	101.0

**Measured Values:**

Mixture Type:	Brain
Dielectric Constant:	41.5
Conductivity:	0.90
Liquid Depth:	15.0

Closest Distance (between E-Probe & Antenna): 1.5 cm

## 13.5 Measurement Results (AMPS Head SAR)

FREQUENCY		Modulation	POWER (dBm)		Phantom Position	Antenna Position	SAR (W/kg)
MHZ	CH		Start	End			
824.04	991	AMPS	26.0	26.0	Right Cheek	Fixed	1.4061
836.49	383	AMPS	26.0	26.0	Right Cheek	Fixed	1.1386
848.97	799	AMPS	26.0	26.0	Right Cheek	Fixed	1.2291
<b>ANSI / IEEE C95.1 1992 - SAFETY LIMIT</b>						<b>Brain</b>	
<b>Spatial Peak</b>						<b>1.6 W/kg (mW/g)</b>	
<b>Uncontrolled Exposure/General Population</b>						averaged over 1 gram	

**NOTES:**

- The test data reported are the worst-case SAR value with the antenna-head position set in a typical configuration.
- All modes of operation were investigated and the worst-case are reported.
- Battery condition is fully charged for all readings.
- Power Measured  Conducted  EIRP  ERP
- SAR Measurement System  SPEAG  IDX
- SAR Configuration  Head  Body  Hand

  
 Randy Ortanez  
 President



Fig. 17  
 Head SAR Test Setup

### 13.1 SAR TEST DATA SUMMARY (Continued)

Ambient TEMPERATURE (°C)	20.6
Liquid TEMPERATURE (°C)	20.1
Relative HUMIDITY (%)	53.4
Atmospheric PRESSURE (kPa)	101.0

**Measured Values:**

Mixture Type: Brain

Dielectric Constant: 41.5

Conductivity: 0.90

Liquid Depth: 15.0 cm

Closest Distance (between E-Probe & Antenna): 1.3 cm

### 13.6 Measurement Results (CDMA Head SAR)

FREQUENCY		Modulation	POWER (dBm)		Phantom Position	Antenna Position	SAR (W/kg)
MHZ	CH		Start	End			
824.70	1013	CDMA	25.0	25.0	Right Tilt	Fixed	0.6988
835.89	363	CDMA	25.0	25.0	Right Tilt	Fixed	0.5719
848.31	777	CDMA	25.0	25.0	Right Tilt	Fixed	0.5843
<b>ANSI / IEEE C95.1 1992 - SAFETY LIMIT</b>						<b>Brain</b>	
<b>Spatial Peak</b>						<b>1.6 W/kg (mW/g)</b>	
<b>Uncontrolled Exposure/General Population</b>						averaged over 1 gram	

**NOTES:**

- The test data reported are the worst-case SAR value with the antenna-head position set in a typical configuration.
- All modes of operation were investigated and the worst-case are reported.
- Battery condition is fully charged for all readings.
- Power Measured  Conducted  EIRP  ERP
- SAR Measurement System  SPEAG  IDX
- SAR Configuration  Head  Body  Hand

  
 Randy Ortanez  
 President



Fig. 18  
 Head SAR Test Setup

### 13.1 SAR TEST DATA SUMMARY (Continued)

Ambient TEMPERATURE (°C)	20.6
Liquid TEMPERATURE (°C)	20.1
Relative HUMIDITY (%)	53.4
Atmospheric PRESSURE (kPa)	101.0

**Measured Values:**

Mixture Type: Brain

Dielectric Constant: 41.5

Conductivity: 0.90

Liquid Depth: 15.0 cm

Closest Distance (between E-Probe & Antenna): 1.4 cm

### 13.7 Measurement Results (CDMA Head SAR)

FREQUENCY		Modulation	POWER (dBm)		Phantom Position	Antenna Position	SAR (W/kg)
MHZ	CH		Start	End			
824.70	1013	CDMA	25.0	25.0	Left Tilt	Fixed	0.9416
835.89	363	CDMA	25.0	25.0	Left Tilt	Fixed	0.7771
848.31	777	CDMA	25.0	25.0	Left Tilt	Fixed	0.8264
<b>ANSI / IEEE C95.1 1992 - SAFETY LIMIT</b>						<b>Brain</b>	
<b>Spatial Peak</b>						<b>1.6 W/kg (mW/g)</b>	
<b>Uncontrolled Exposure/General Population</b>						averaged over 1 gram	

**NOTES:**

- The test data reported are the worst-case SAR value with the antenna-head position set in a typical configuration.
- All modes of operation were investigated and the worst-case are reported.
- Battery condition is fully charged for all readings.
- Power Measured  Conducted  EIRP  ERP
- SAR Measurement System  SPEAG  IDX
- SAR Configuration  Head  Body  Hand

  
 Randy Ortanez  
 President

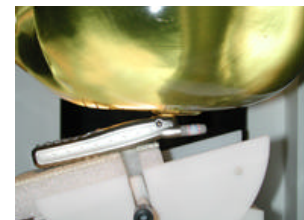

**Fig. 19**  
**Head SAR Test Setup**

### 13.1 SAR TEST DATA SUMMARY (Continued)

Ambient TEMPERATURE (°C)	20.6
Liquid TEMPERATURE (°C)	20.1
Relative HUMIDITY (%)	53.4
Atmospheric PRESSURE (kPa)	101.0

**Measured Values:**

Mixture Type: Brain

Dielectric Constant: 41.5

Conductivity: 0.90

Liquid Depth: 15.0 cm

Closest Distance (between E-Probe & Antenna): 1.5 cm

### 13.8 Measurement Results (CDMA Head SAR)

FREQUENCY		Modulation	POWER (dBm)		Phantom Position	Antenna Position	SAR (W/kg)
MHZ	CH		Start	End			
824.70	1013	CDMA	25.0	25.0	Right Cheek	Fixed	1.1199
835.89	363	CDMA	25.0	25.0	Right Cheek	Fixed	0.9073
848.31	777	CDMA	25.0	25.0	Right Cheek	Fixed	0.9874
<b>ANSI / IEEE C95.1 1992 - SAFETY LIMIT</b>						<b>Brain</b>	
<b>Spatial Peak</b>						<b>1.6 W/kg (mW/g)</b>	
<b>Uncontrolled Exposure/General Population</b>						averaged over 1 gram	

**NOTES:**

- The test data reported are the worst-case SAR value with the antenna-head position set in a typical configuration.
- All modes of operation were investigated and the worst-case are reported.
- Battery condition is fully charged for all readings.
- Power Measured  Conducted  EIRP  ERP
- SAR Measurement System  SPEAG  IDX
- SAR Configuration  Head  Body  Hand

  
 Randy Ortanez  
 President



**Fig. 20**  
**Head SAR Test Setup**



### 13.1 SAR TEST DATA SUMMARY (Continued)

Ambient TEMPERATURE (°C)	20.6
Liquid TEMPERATURE (°C)	20.1
Relative HUMIDITY (%)	53.4
Atmospheric PRESSURE (kPa)	101.0

**Measured Values:**

Mixture Type:	Brain
Dielectric Constant:	41.5
Conductivity:	0.90
Liquid Depth:	15.0 cm

Closest Distance (between E-Probe & Antenna): 1.6 cm

### 13.9 Measurement Results (CDMA Head SAR)

FREQUENCY		Modulation	POWER (dBm)		Phantom Position	Antenna Position	SAR (W/kg)
MHZ	CH		Start	End			
824.70	1013	CDMA	25.0	25.0	Left Cheek	Fixed	1.1917
835.89	363	CDMA	25.0	25.0	Left Cheek	Fixed	0.9653
848.31	777	CDMA	25.0	25.0	Left Cheek	Fixed	1.0163
<b>ANSI / IEEE C95.1 1992 - SAFETY LIMIT</b>						<b>Brain</b>	
<b>Spatial Peak</b>						<b>1.6 W/kg (mW/g)</b>	
<b>Uncontrolled Exposure/General Population</b>						averaged over 1 gram	

**NOTES:**

- The test data reported are the worst-case SAR value with the antenna-head position set in a typical configuration.
- All modes of operation were investigated and the worst-case are reported.
- Battery condition is fully charged for all readings.
- Power Measured  Conducted  EIRP  ERP
- SAR Measurement System  SPEAG  IDX
- SAR Configuration  Head  Body  Hand

  
 Randy Ortanez  
 President

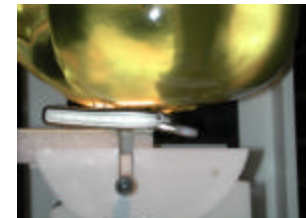

Fig. 21  
 Head SAR Test Setup

### 13.1 SAR TEST DATA SUMMARY (Continued)

Ambient TEMPERATURE (°C)	20.6
Liquid TEMPERATURE (°C)	20.1
Relative HUMIDITY (%)	53.4
Atmospheric PRESSURE (kPa)	101.0

**Measured Values:**

Mixture Type:	Muscle
Dielectric Constant:	56.1
Conductivity:	0.95
Liquid Depth:	15.0 cm

### 13.10 Measurement Results (AMPS Body SAR)

FREQUENCY		Modulation	POWER* (dBm)		Separation Distance** (cm)	Antenna Position	SAR (W/kg)
MHZ	CH		Start	End			
824.04	991	AMPS	26.0	26.0	1.5	Fixed	0.8122
836.49	383	AMPS	26.0	26.0	1.5	Fixed	0.6963
848.97	799	AMPS	26.0	26.0	1.5	Fixed	0.6690
<b>ANSI / IEEE C95.1 1992 - SAFETY LIMIT Spatial Peak Uncontrolled Exposure/General Population</b>						<b>Body 1.6 W/kg (mW/g) averaged over 1 gram</b>	

NOTES:

- All modes of operation were investigated and the worst-case are reported.
- Battery condition is fully charged for all readings.
- \* Power Measured  Conducted  EIRP  ERP
- SAR Measurement System  SPEAG  IDX
- SAR Configuration  Head  Body  Hand
- \*\* Test Configuration  Body Holster  Without Body Holster

  
 Randy Ortanez  
 President



Fig. 22  
 Body SAR Test Setup

### 13.1 SAR TEST DATA SUMMARY (Continued)

Ambient TEMPERATURE (°C)	20.6
Liquid TEMPERATURE (°C)	20.1
Relative HUMIDITY (%)	53.4
Atmospheric PRESSURE (kPa)	101.0

**Measured Values:**

Mixture Type:	Muscle
Dielectric Constant:	56.1
Conductivity:	0.95
Liquid Depth:	15.0 cm

### 13.11 Measurement Results (CDMA Body SAR)

FREQUENCY		Modulation	POWER* (dBm)		Separation Distance** (cm)	Antenna Position	SAR (W/kg)
MHZ	CH		Start	End			
824.70	1013	CDMA	25.0	25.0	1.5	Fixed	0.7064
835.89	363	CDMA	25.0	25.0	1.5	Fixed	0.5910
848.31	777	CDMA	25.0	25.0	1.5	Fixed	0.5262
<b>ANSI / IEEE C95.1 1992 - SAFETY LIMIT</b>						<b>Body</b> <b>1.6 W/kg (mW/g)</b> averaged over 1 gram	
<b>Spatial Peak</b> <b>Uncontrolled Exposure/General Population</b>							

**NOTES:**

- All modes of operation were investigated and the worst-case are reported.
- Battery condition is fully charged for all readings.
- \* Power Measured  Conducted  EIRP  ERP
- SAR Measurement System  SPEAG  IDX
- SAR Configuration  Head  Body  Hand
- \*\* Test Configuration  Body Holster  Without Body Holster

  
 Randy Ortanez  
 President



Fig. 23  
 Body SAR Test Setup

## 14.1 SAR TEST EQUIPMENT

Type / Model	Calib. Date	S/N:
PCTEST Robot Arm	Jan. 01	PCT482
PCTEST Computer 200 MHz Pentium Pro Windows NT	Jan. 01	PCT480
Robot Controller	Jan. 01	PCT464
Teach Pendant (Joystick)	Jan. 01	PCT467
SAM Phantom Head Model (Right)	Oct. 01	PCT658
SAM Phantom Head Model (Left)	Oct. 01	PCT657
Brain Equivalent Matter (800MHz)	Jan. 02	PCTBEM10
Brain Equivalent Matter (1900MHz)	Jan. 02	PCTBEM11
Muscle Equivalent Matter (800MHz)	Jan. 02	PCTMEM12
Muscle Equivalent Matter (1900MHz)	Jan. 02	PCTMEM13
E-Field Probe	Feb. 01	PCT486A
E-Field Probe	May. 01	PCT486B
E-Field Probe	Aug. 01	PCT486C
HP Spectrum Analyzer	Dec. 01	PCT200
IFI TEM Cell Model: CC110EXX (DC - 2000 MHz)	Jan. 01	A427-0697
Microwave Amp. Model: 5S1G4 (800MHz - 4.2GHz, 5 Watts)	Jan. 01	22332
Non-metallic Handset Tripod		PCT487

**NOTE:**

The E-field probe was calibrated by IDX Systems, Inc. The SAR calibration of the Efield probe is performed by temperature measurement procedure. A TEM cell is used for the free space calibration of the probe. The brain simulating material is calibrated by PCTEST using the dielectric probe system and network analyzer to determine the conductivity and permittivity (dielectric constant) of the brain-equivalent material.

The following list of equipment was used to calibrate the system (from IDX):

Power Meter	HP-437B
RF Generator	HP-8657B
Power Amp	Power System Technology (Amplifier Research)
TEM cell	IFI CC-110
Network Analyzer	HP-8753C

## 15.1 CONCLUSION

---

The SAR measurement indicates that the EUT complies with the RF radiation exposure limits of the FCC. These measurements are taken to simulate the RF effects exposure under worst-case conditions. Precise laboratory measures were taken to assure repeatability of the tests.

Please note that the absorption and distribution of electromagnetic energy in the body are very complex phenomena that depend on the mass, shape, and size of the body, the orientation of the body with respect to the field vectors, and the electrical properties of both the body and the environment. Other variables that may play a substantial role in possible biological effects are those that characterize the environment (e.g. ambient temperature, air velocity, relative humidity, and body insulation) and those that characterize the individual (e.g. age, gender, activity level, debilitation, or disease). Because innumerable factors may interact to determine the specific biological outcome of an exposure to electromagnetic fields, any protection guide shall consider maximal amplification of biological effects as a result of field-body interactions, environmental conditions, and physiological variables.[3]

### REFERENCES:

- [1] Federal Communications Commission, ET Docket 93-62, *Guidelines for Evaluating the Environmental Effects of Radiofrequency Radiation*, Aug. 1996.
- [2] ANSI/IEEE C95.1 - 1991, *American National Standard safety levels with respect to human exposure to radio frequency electromagnetic fields, 300kHz to 100GHz*, New York: IEEE, Aug. 1992
- [3] ANSI/IEEE C95.3 - 1991, *IEEE Recommended Practice for the Measurement of Potentially Hazardous Electromagnetic Fields - RF and Microwave*, New York: IEEE, 1992.
- [4] NCRP, National Council on Radiation Protection and Measurements, *Biological Effects and Exposure Criteria for RadioFrequency Electromagnetic Fields*, NCRP Report No. 86, 1986. Reprinted Feb. 1995.
- [5] CENELEC CLC/SC111B, European Prestandard (prENV 50166-2), *Human Exposure to Electromagnetic Fields High-Frequency: 10kHz-300GHz*, Jan. 1995.
- [6] V. Hombach, K. Meier, M. Burkhardt, E. Kuhn, N. Kuster, *The Dependence of EM Energy Absorption upon Human Head Modeling at 900 MHz*, IEEE Transaction on Microwave Theory and Techniques, vol. 44 no. 10, Oct. 1996, pp. 1865-1873.
- [7] N. Kuster and Q. Balzano, *Energy absorption mechanism by biological bodies in the near field of dipole antennas above 300MHz*, IEEE Transaction on Vehicular Technology, vol. 41, no. 1, Feb. 1992, pp. 17-23.
- [8] Q. Balzano, O. Garay, T. Manning Jr., *Electromagnetic Energy Exposure of Simulated Users of Portable Cellular Telephones*, IEEE Transactions on Vehicular Technology, vol. 44, no.3, Aug. 1995.
- [9] G. Hartsgrove, A. Kraszewski, A. Surowiec, *Simulated Biological Materials for Electromagnetic Radiation Absorption Studies*, University of Ottawa, Bioelectromagnetics, Canada: 1987, pp. 29-36.