



Digital Projector

# User Manual

Portable Entertainment Series | GVI

V 1.00

# Copyright and disclaimer

## Copyright

Copyright © 2018 by BenQ Corporation. All rights reserved. No part of this publication may be reproduced, transmitted, transcribed, stored in a retrieval system or translated into any language or computer language, in any form or by any means, electronic, mechanical, magnetic, optical, chemical, manual or otherwise, without the prior written permission of BenQ Corporation.

All other logos, products, or company names mentioned in this manual may be the registered trademarks or copyrights of their respective companies, and are used for informational purposes only.

The Bluetooth® word mark and logos are registered trademarks owned by Bluetooth SIG, Inc. and any use of such marks by BenQ Corporation is under license.

*Android is a trademark of Google LLC.*

## Disclaimer

BenQ Corporation makes no representations or warranties, either expressed or implied, with respect to the contents hereof and specifically disclaims any warranties, merchantability or fitness for any particular purpose. Further, BenQ Corporation reserves the right to revise this publication and to make changes from time to time in the contents hereof without obligation of BenQ Corporation to notify any person of such revision or changes. This user manual aims to provide the most updated and accurate information to customers, and thus all contents may be modified from time to time without prior notice. Please visit <http://www.benq.com> for the latest version of this manual.

## Warranty

BenQ warrants this product against any defects in material and workmanship, under normal usage and storage.

Proof of purchase date will be required with any warranty claim. In the event this product is found to be defective within the warranty period, BenQ's only obligation and your exclusive remedy shall be replacement of any defective parts (labor included). To obtain warranty service, immediately notify the dealer from which you purchased the product of any defects.

Important: The above warranty shall be void if the customer fails to operate the product in accordance with BenQ's written instructions, especially the ambient humidity must be in-between 10% and 90%, temperature in-between 0°C and 35°C, altitude lower than 3000 meters, and avoiding to operate the projector in a dusty environment. This warranty gives you specific legal rights, and you may have other rights which vary from country to country.

For other information, please visit [www.BenQ.com](http://www.BenQ.com).

## Statement regarding hyperlinks and third-party websites

BenQ is not responsible for the content of the websites or of similar resources, which are maintained and controlled by third parties, that may be linked from this product. Providing links to those websites or to similar resources does not mean that BenQ makes any warranty or representation to their content by expression or by implication.

Any third party content or service preinstalled in this product is provided "as is". BenQ does not, by expression or by implication, make any warrant to the content or to the services provided by third parties. BenQ does not warrant or guarantee that the content or services provided by third parties are accurate, effective, most up-to-date, legal, or complete. Under no circumstances shall BenQ be liable for the content or services provided by third parties including their negligence.

Services provided by third parties may be terminated temporarily or permanently. BenQ does not warrant or guarantee that any content or services provided by third parties are in good condition at any time, and is not liable for the termination of the said content and services.

In addition, BenQ is not involved in any transactions you conduct in the websites or similar resources maintained by third parties.

You should contact the content or service providers for any questions, concerns, or disputes.

## Table of contents

Copyright and disclaimer .....	2
Copyright .....	2
Disclaimer .....	2
Warranty .....	2
Statement regarding hyperlinks and third-party websites .....	3
Package contents .....	11
Standard accessories .....	11
Introduction .....	14
Projector features .....	14
Projector exterior view .....	16
Front and left side view .....	16
Rear and right side view .....	17
Bottom view .....	17
Controls and functions .....	18
Control panel .....	18
LED Indicators .....	19
Remote control .....	21
Activating the remote control battery .....	22
Replacing the remote control battery .....	23
Remote control effective range .....	24
Installation .....	25

Choosing a location .....	25
Obtaining a preferred projected image size .....	27
Projection dimensions .....	27
Operations .....	29
Attaching the plug head.....	29
Removing the plug head.....	29
Charging the battery.....	30
Starting up the projector .....	31
Shutting down the projector .....	35
Operating in a high altitude environment.....	35
Adjusting the projected image .....	37
Adjusting the projection angle.....	37
Fine-tuning the image clarity .....	38
Correcting keystone .....	39
<b>BenQ Launcher</b> .....	40
The <b>BenQ Launcher</b> home page.....	40
Navigating the <b>BenQ Launcher</b> home page.....	41
Using the <b>BenQ Launcher</b> Settings Menus .....	42
Inputting text .....	42
Connections .....	44
Wireless Connections .....	46
Connecting the projector to a Wi-Fi network.....	46
iOS Mobile Projection .....	48
Android Mobile Projection.....	51
PC Mobile Projection.....	53

Wi-Fi Hotspot .....	55
Wired Connections.....	59
Connecting a USB-C™ device with DisplayPort.....	59
Connecting a USB-C™ device without DisplayPort .....	62
Connecting a USB-C™ flash drive.....	63
Media Player .....	64
Bluetooth Connections .....	73
Pairing/Connecting to a Bluetooth speaker or headphones .....	73
Using the Projector as a Bluetooth speaker.....	75
Navigating the Settings menus .....	77
About the Settings menus.....	77
Using the Settings menu .....	78
<b>Picture</b> .....	79
<b>Sound</b> .....	81
<b>Wi-Fi</b> .....	82
<b>Bluetooth</b> .....	83
<b>Hotspot</b> .....	84
<b>Installation</b> .....	85
<b>Preference</b> .....	88
<b>About</b> .....	89
Maintenance .....	90
Care of the projector.....	90
Cleaning the lens .....	90
Storing the projector.....	90
Transporting the projector.....	91
Extending LED life.....	91
Troubleshooting .....	93

Specifications .....	94
Projector specifications .....	94
Dimensions.....	97
Timing chart.....	98

# Important safety instructions

Your projector is designed and tested to meet the latest standards for safety of information technology equipment. However, to ensure safe use of this product, it is important that you follow the instructions mentioned in this manual and marked on the product.

1. Please read this user manual before you operate your projector.  
Keep this manual in a safe place for future reference.

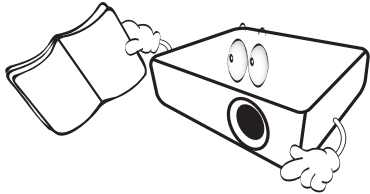

2. Always place the projector on a level, horizontal surface during operation.
  - Do not place the projector on an unstable cart, stand, or table as it may fall and be damaged.
  - Do not place inflammables near the projector.
  - Do not use if tilted at an angle of more than 10 degrees left to right, nor at angle of more than 15 degrees front to back.

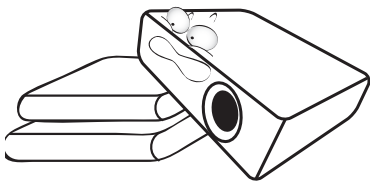

3. Do not store the projector on end vertically. Doing so may cause the projector to fall over, causing injury or resulting in damage.

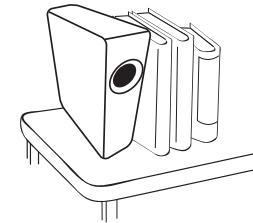

4. Do not place the projector in any of the following environments:
  - Space that is poorly ventilated or confined. Allow at least 50 cm clearance from walls and free flow of air around the projector.
  - Locations where temperatures may become excessively high, such as the inside of a car with all windows closed.
  - Locations where excessive humidity, dust, or cigarette smoke may contaminate optical components, shorten the projector's lifespan and darken the screen.

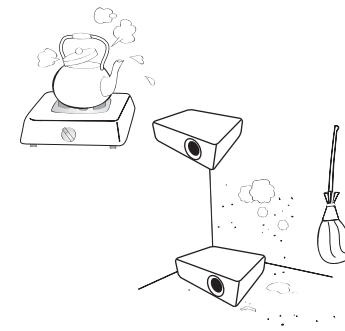

- Locations near fire alarms.
- Locations with an ambient temperature above 35°C/95°F.



- Locations where the altitudes are higher than 3000 m (10000 feet).

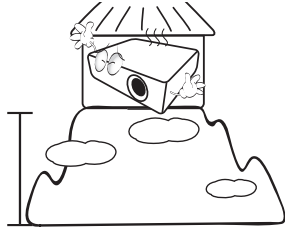

- Do not block the vents holes while the projector is on (even in standby mode).
  - Do not cover the projector with any item.
  - Do not place the projector on a blanket, bedding or any other soft surface.

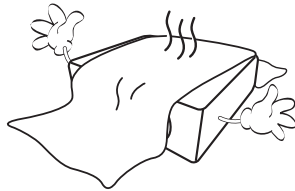

- In areas where the mains power supply voltage may fluctuate by  $\pm 10$  volts, it is recommended that you connect the projector through a power stabilizer, surge protector or uninterruptible power supply (UPS) as appropriate to your situation.

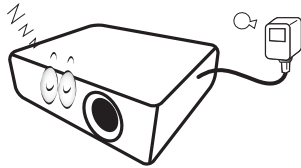

- Do not step on the projector or place any objects upon it.

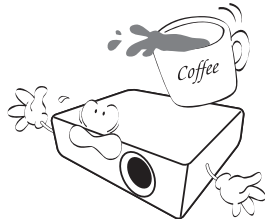

- Do not place liquids near or on the projector. Liquids spilled into the projector will void your warranty. If the projector does become wet, disconnect it from the power point and call BenQ to have the projector repaired.

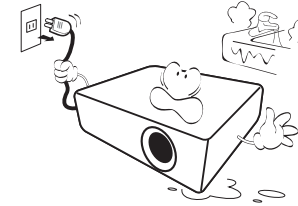

- Do not look straight into the projector lens during operation. It may harm your sight.

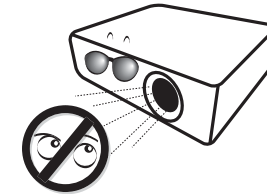

- Do not operate the projector lamp beyond the rated lamp life. Excessive operation of lamps beyond the rated life could cause a lamp to break on rare occasions.

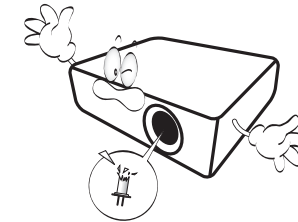

- The lamp becomes extremely hot during operation. Allow the projector to cool for approximately 45 minutes prior to removing the lamp assembly for replacement.

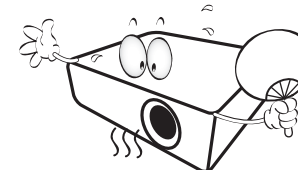

12. This projector is capable of displaying inverted images for ceiling installation.

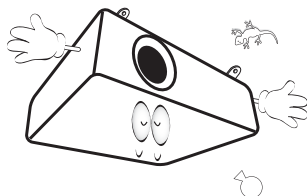

13. Do not attempt to disassemble this projector. There are dangerous high voltages inside which may cause death if you should come into contact with live parts.

Under no circumstances should you ever undo or remove any other covers. Refer servicing only to suitably qualified professional service personnel.

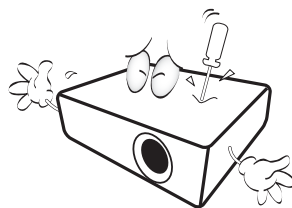

Please keep the original packing for possible future shipment. If you need to pack your projector after use, adjust the projection lens to an appropriate position, put the lens cushion around the lens, and fit the lens cushion and projector cushion together to prevent damage during transportation.

14. When you think service or repair is required, take the projector only to a suitably qualified technician.

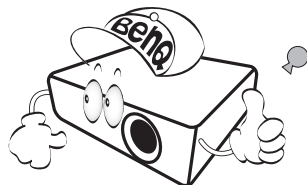

## Moisture condensation

Never operate the projector immediately after moving it from a cold location to a hot location. When the projector is exposed to such a change in temperature, moisture may condense on the crucial internal parts. To prevent the projector from possible damage, do not use the projector for at least 2 hours when there is a sudden change in temperature.

## Avoid volatile liquids

Do not use volatile liquids, such as insecticide or certain types of cleaner, near the projector. Do not have rubber or plastic products touching the projector for a long time. They will leave marks on the finish. If cleaning with a chemically treated cloth, be sure to follow the cleaning product's safety instructions.

## Disposal

This product contains the following materials which are harmful to human bodies and environment.

- Lead, which is contained in solder.
- Mercury, which is used in the lamp.

To dispose of the product or used lamps, consult your local environment authorities for regulations.



The illustrations and the images shown in this document are for your reference. The actual content may vary by the product supplied for your region.

# Package contents

Carefully unpack and verify that you have the items below. Some of the items may not be available depending on your region of purchase. Please check with your place of purchase.

## Standard accessories

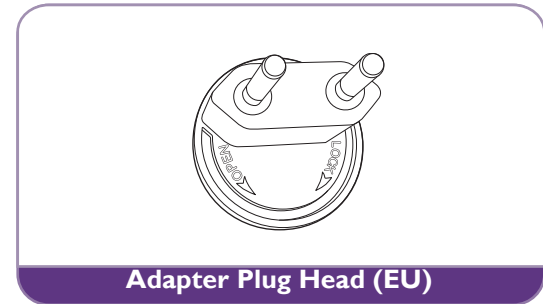
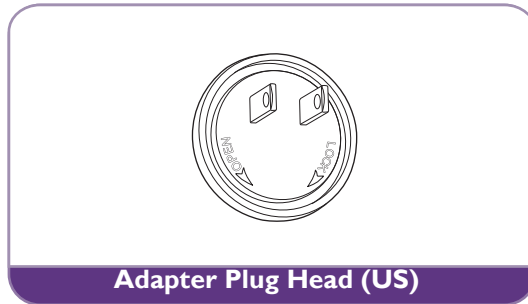
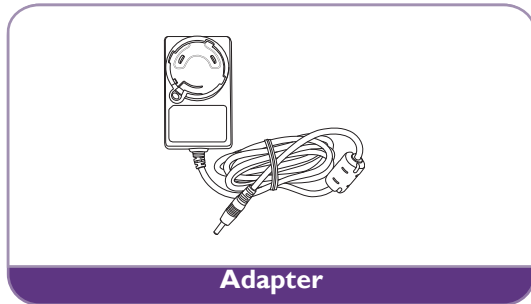
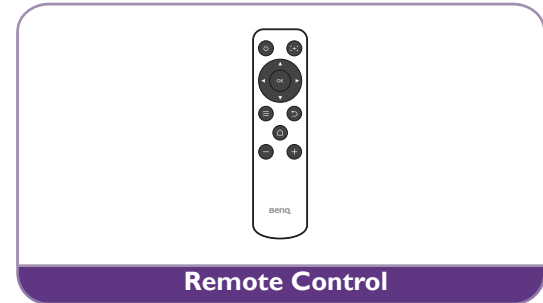
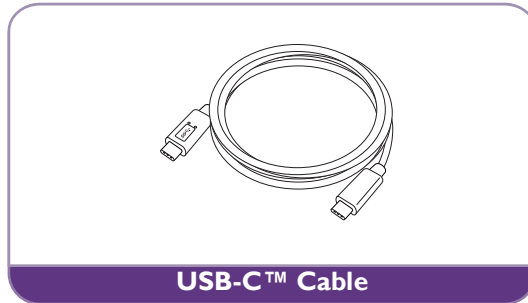

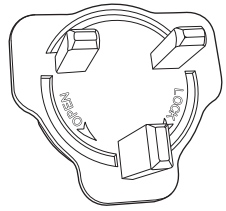

**Adapter Plug Head (UK)**

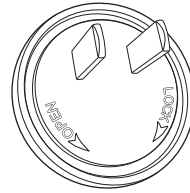

**Adapter Plug Head (CHINA)**

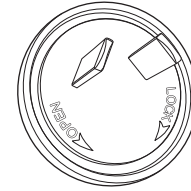

**Adapter Plug Head (AUS)**

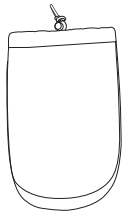

**Carry Bag**



**Quick Start Guide**

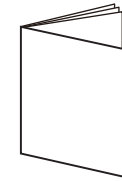

**Regulatory Statement**



**Warranty Card**

- 
- 
- Lamp life results will vary depending on environmental conditions and usage. Actual product's features and specifications are subject to change without notice.
  - Some of the accessories may vary from region to region.
  - The warranty card is only supplied in some specific regions. Please consult your dealer for detailed information.
  - For AC/DC Adapter, the socket-outlet shall be installed near the equipment and shall be easily accessible.
-

# Introduction

## Projector features

- **Instant Wireless Projection**

Release your hands and eyes to enjoy binge-watching on a big screen. If you have access to internet connection, you can cast the screen from a mobile device through GVI instantly. With GVI, you can just sit back, relax and enjoy some well-earned downtime.

- **Bluetooth Speaker Mode**

Entertaining friends and family in style is easy with the GVI. With Bluetooth 4.0 intelligent connection, you can set GVI as a speaker, and play music from mobile device through it. Bluetooth 4.0 lets you waste less battery power because, unless critical data is being shared, the connection is solid and secure. You can connect to your devices without draining the battery.

- **Media playback from USB-C™ DisplayPort**

GVI supports laptop or mobile phone projection by USB-C™ DisplayPort interface. Once GVI is plugged into the USB-C™ DisplayPort port via the USB-C™ Gen 3.1 cable, you can extend the screen for business meetings or entertainment projection.

- **Multimedia entertainment at your finger tips**

With a built-in USB reader, streaming content like movies, music and videos in a few seconds has never been simpler. You can share memorable photos or videos and everyone can enjoy them without huddling around a small screen.

- **Convenient Android-based BenQ Launcher**

The projector operates through the Android-based BenQ Launcher which is complemented by a WLAN connection that allows you to project/broadcast media via embedded or downloaded streaming apps. (The app market will be introduced by OTA update in late 2018)

- **15-Degree Adjustable Tilt for Flexible Installation**

To satisfy diverse projection scenarios, GVI introduces a considerable 15-degree adjustable tilt to avoid troublesome obstacles and ensure a perfect big screen projection.

- **Auto Keystone**

GVI offers an automatic vertical keystone adjustment function which adjusts the projected image accordingly. With 15-Degree Adjustable Tilt, you can stream content without installation hassles.

- **High Portability**

The GVI is handy and portable, making it useful for business trips and leisure activities.

- **Advanced LED light source**

The projector features a long lasting LED lightbulb that provides a longer lifespan than traditional bulbs.

- **Low Heat**

Unlike other projectors, GVI emits lower temperature, making it safe enough for inquisitive children to touch without hurting their hands.

# Projector exterior view

## Front and left side view

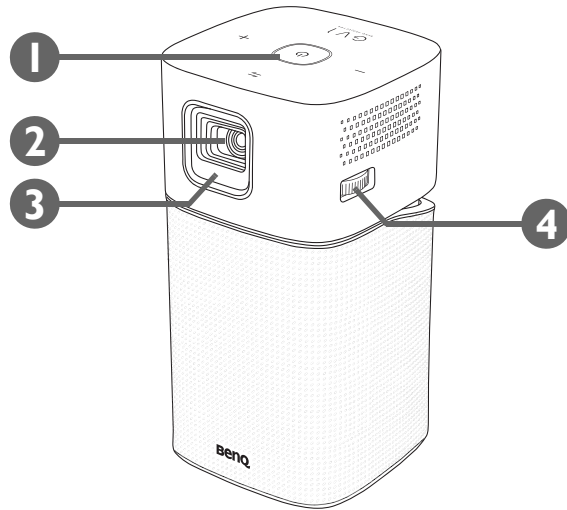

1. Control panel (See [Control panel on page 18](#) for details.)
2. Projection lens
3. Front IR sensor
4. Focus ring



## Rear and right side view

See [Connections on page 44](#) for connection details.

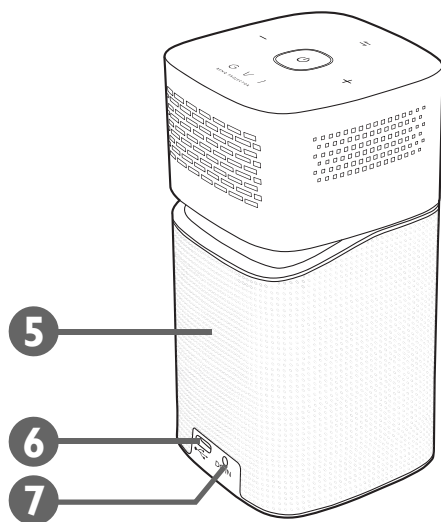

### 5. Speaker grill

Inside the speaker grill is the rear speaker.

### 6. USB-C™ port

Used to connect devices with DisplayPort functionality to project video from the device or flash drives to project/broadcast media stored on the card.

### 7. DC-IN power jack



Please only use the supplied power adapter to avoid possible dangers such as electric shock and fire.

## Bottom view

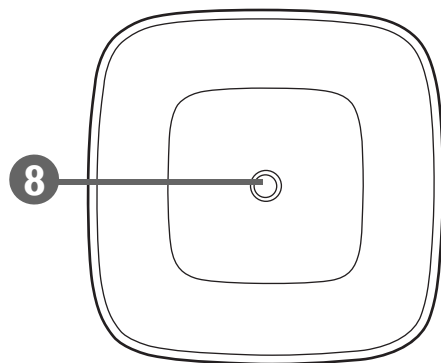

### 8. Tripod screwhole

Used to attach a tripod plate to mount the projector onto a tripod.

# Controls and functions

## Control panel

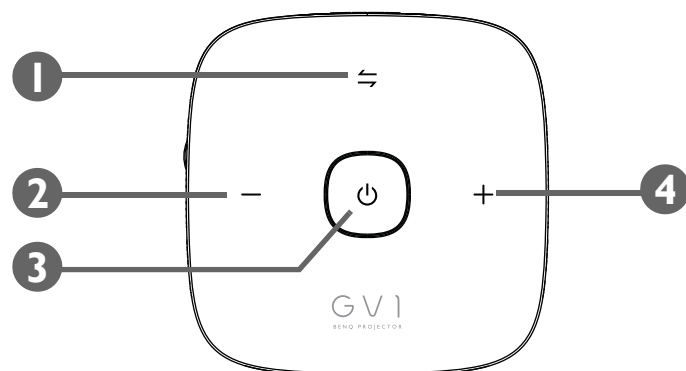

**1. ⇆ Switch mode key/LED indicator**

- Toggles the Bluetooth speaker on and off.
- Acts as an LED indicator for Bluetooth and errors. See [LED Indicators on page 19](#) for more details.

**2. - Volume down key**

Decreases the projector volumes.

**3. ⏻ Power key/LED indicator**

- Turns the projector on and off. See [Starting up the projector on page 31](#) for more details.
- Acts as an LED indicator for the battery. See [LED Indicators on page 19](#) for more details.









**4. + Volume up key**

Increases the projector volume.

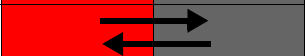
## LED Indicators

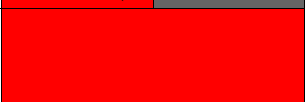
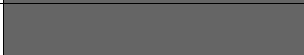
The power and switch mode keys feature LEDs that help indicate the status and possible operating errors for the projector, refer to the table below for definitions of various LED behaviors.

Scenario	Status	Power Key		Switch Mode Key	
		LED Behavior	Schema	LED Behavior	Schema
Charging with Adapter	Battery capacity < 20%	Red - breathing		N/A	
	Battery capacity = 20 - 60%	Yellow - breathing		N/A	
	Battery capacity > 60%	Green - breathing		N/A	
	Battery capacity = 100%	Green - solid		N/A	
Battery Mode	Battery capacity < 20%	Red - flashing		N/A	
	Battery capacity = 20 - 60%	Yellow - solid		N/A	
	Battery capacity > 60%	Green - solid		N/A	
Bluetooth Speaker Mode	Ready to pair / Pairing	Depends on power status		Blue - flashing	
	Pairing successful			Blue - solid	
System Update	System update in progress	Green - flashing		Blue - flashing	
	System update has failed	Red - solid		Red - solid	
	System update is successful; system is restarting	Green - solid		Blue - solid	

Scenario	Status	Power Key		Switch Mode Key	
		LED Behavior	Schema	LED Behavior	Schema
Error*	LED error	Yellow - solid		Red - flashing	
	Fan error	Red - solid		Red - flashing	
	Optical engine temperature error	N/A		Red - solid	
	Battery temperature error	N/A		Red - flashing	
	Driver board error	Red - flashing		Red - flashing	

\*If there are any errors, turn the projector off.

# Remote control

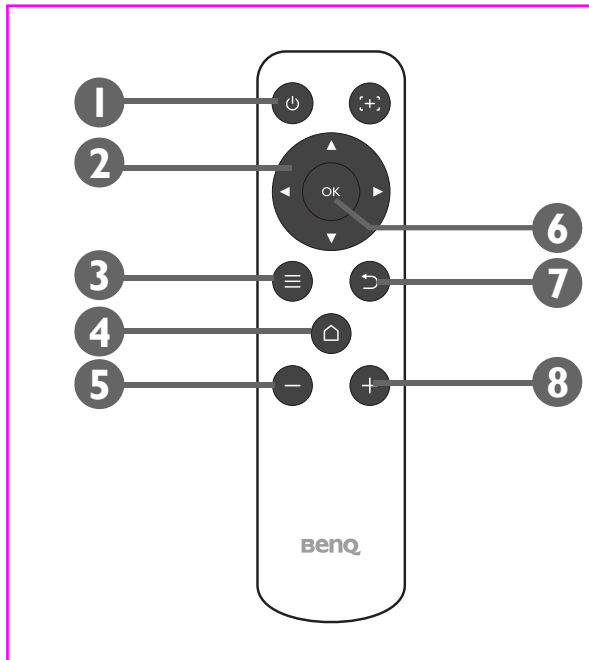

## 1. Power

Turns the projector off and on after initial startup.



After initially starting up the projector using the keypad button, the remote control power button can be used to turn the projector off or on for subsequent power ups.

See [Starting up the projector on page 31](#) for more details.

## 2. **Arrow keys (◀Left, ▶Right, ▲Up, ▼Down)**

Used as directional arrows to select the desired menu items and to make adjustments.

## 3. Settings

Launches the **BenQ Launcher** settings menu.

## 4. HOME

Press this key to enter the **BenQ Launcher** home menu



This key is only active when the projector is under **BenQ Launcher** mode.

## 5. **– Volume Down**

Decreases the projector volume.

---

## 6. **OK**

Used to confirm the selection on the **BenQ Launcher** menu.

## 7. BACK

Used to return to the previous layer.

## 8. **+ Volume Up**

Increases the projector volume.

## Activating the remote control battery

Before you can begin to use the remote control, you must first remove the clear plastic battery sticker between the battery and the contact on the remote control.

1. Use a flat-tipped instrument to rotate the battery cover counter-clockwise to the unlocked position.

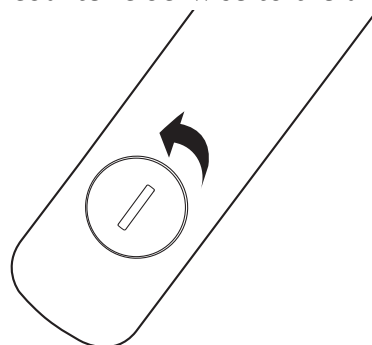

2. Remove the battery cover from the remote control.
3. Pull and remove the plastic battery sticker.

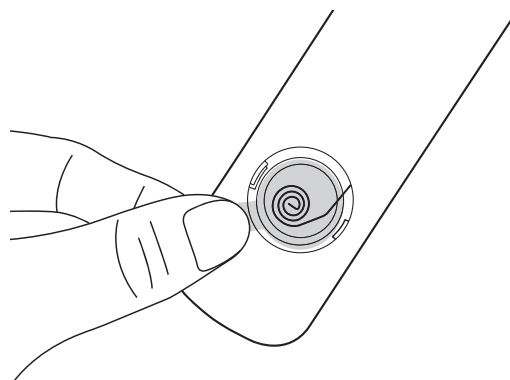

4. Place the battery cover back onto the remote control and rotate it clockwise to the locked position.

---

 Avoid leaving the remote control and battery in an excessive heat or humid environment like the kitchen, bathroom, sauna, sunroom or in a closed car.

---

## Replacing the remote control battery

1. Use a flat-tipped instrument to rotate the battery cover counter-clockwise to the unlocked position.

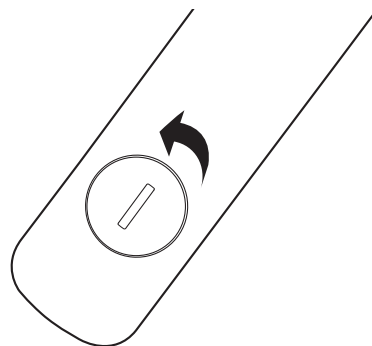

2. Remove the battery cover from the remote control.
3. Carefully dislodge the used battery from underneath the retention coil and slide it out from the remote control.

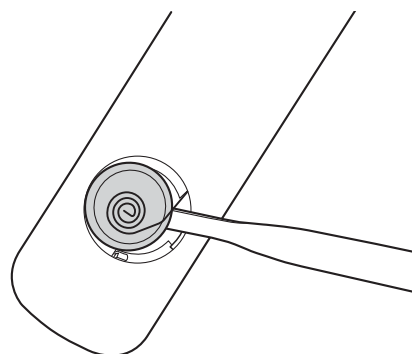

4. Slide the new battery into its position underneath the retention coil.
5. Place the battery cover back onto the remote control and rotate it clockwise to the locked position.

- 
- Avoid leaving the remote control and battery in an excessive heat or humid environment like the kitchen, bathroom, sauna, sunroom or in a closed car.
  - Replace only with the same or equivalent type recommended by the battery manufacturer.
  - Dispose of the used batteries according to the manufacturer's instructions and local environment regulations for your region.
  - Never throw the battery into a fire. There may be danger of an explosion.
-

## Remote control effective range

The projector's IR remote control sensor is located at the front of the projector with a range of 8 metres (~26 feet) at an angle of 30-degrees (left and right) and 20-degrees (up and down). The remote control can be used either by pointing it at the front of the projector or by reflecting the IR signal off of a wall.

Make sure that there are no obstacles between the remote control and the IR sensor on the projector.

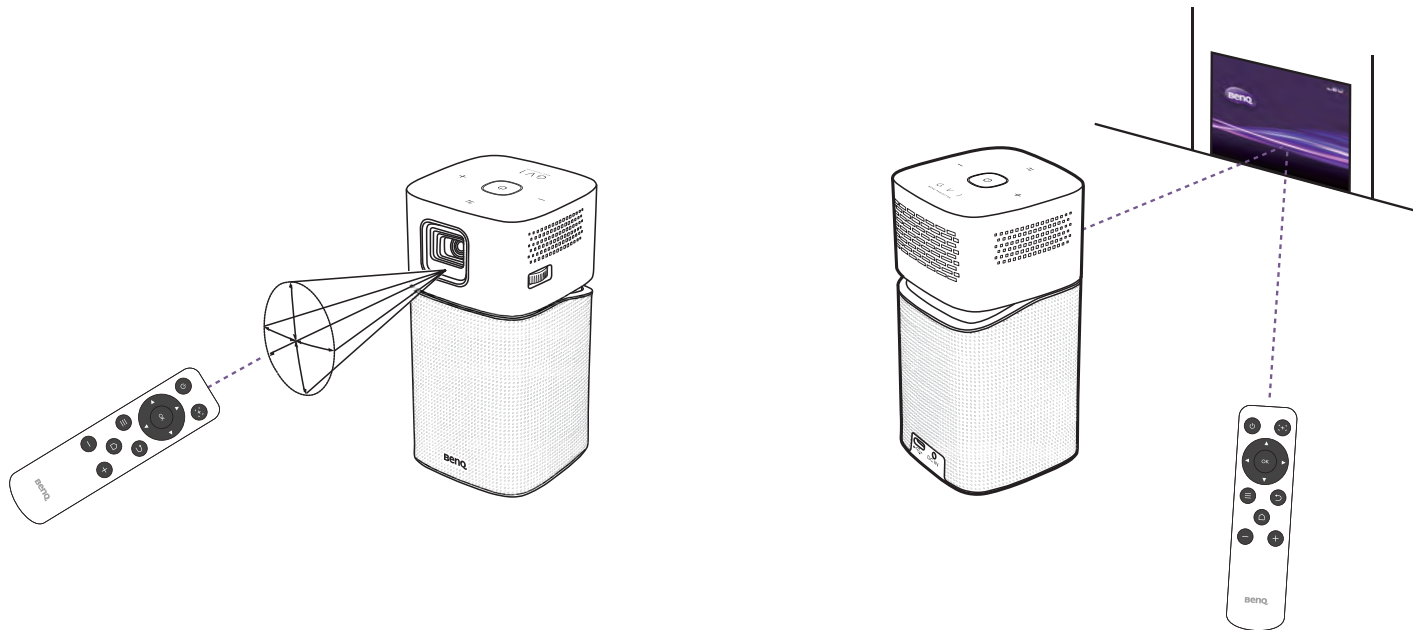





# Installation

## Choosing a location

Before choosing an installation location for your projector, take the following factors into consideration:

- Size and position of your screen
- Electrical outlet location
- Location and distance between the projector and the rest of your equipment
- Location and distance between the projector and the wireless access point, or if using a LAN cable, the internet hub

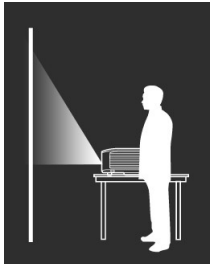
You can install your projector in the following ways.

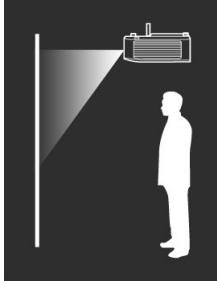
<p><b>1. Front:</b></p> <p>Select this location with the projector placed near the floor in front of the screen.</p> <p>This is the most common way to position the projector for quick setup and portability.</p> <p>Turn on the projector and select the following settings:</p> <p><b>Settings &gt; Installation &gt; Projector Installation &gt; Front</b></p>	 A silhouette of a person sitting at a desk, looking at a screen. A projector is positioned on the desk in front of the screen, projecting a beam of light onto the screen.
<p><b>2. Front Ceiling:</b></p> <p>Select this location with the projector elevated near the ceiling in front of the screen.</p> <p>Turn on the projector and select the following settings:</p> <p><b>Settings &gt; Installation &gt; Projector Installation &gt; Front Ceiling</b></p> <p> The projector does not feature ceiling mount components/equipment so when choosing to use a front ceiling location you must place it on an elevated location of your choice.</p>	 A silhouette of a person standing, looking at a screen. A projector is mounted on the ceiling in front of the screen, projecting a beam of light onto the screen.

### 3. Rear:

Select this location with the projector placed near the floor behind the screen.

Turn on the projector and select the following settings:

**Settings > Installation > Projector Installation > Rear**



A special rear projection screen is required.

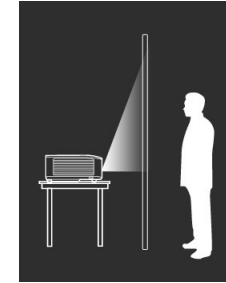

### 4. Rear Ceiling:

Select this location with the projector elevated from the ceiling behind the screen.

Turn on the projector and select the following settings:

**Settings > Installation > Projector Installation > Rear Ceiling**



A special rear projection screen is required.



The projector does not feature ceiling mount components/equipment so when choosing to use a front ceiling location you must place it on an elevated location of your choice.

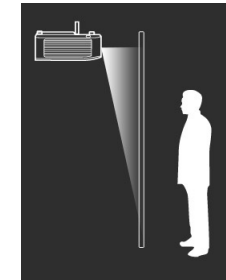

## Obtaining a preferred projected image size

The projected image size is determined by the distance from the projector lens to the screen, and the video format. The data in the table below is based on a normal projection method and not the result of adjusting the projection angle (1-15 degrees).

### Projection dimensions

Use the illustration and tables below to help you determine the projection distance.

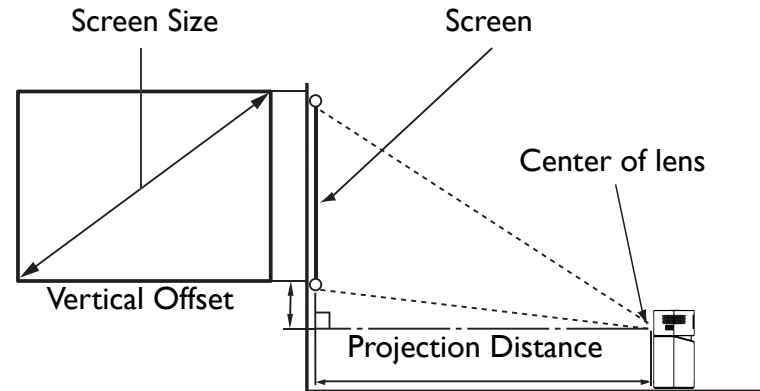

Screen size			Projector distance (mm)	
Diagonal		H (mm)	W (mm)	Average
Inch	mm			
30	762	664	373	864
35	889	775	436	1007
40	1016	886	498	1151
45	1143	996	560	1295
50	1270	1107	622	1439
55	1397	1218	684	1583

Screen size			Projector distance (mm)	
Diagonal		H (mm)	W (mm)	Average
Inch	mm			
60	1524	1329	747	1727
65	1651	1439	809	1871
70	1778	1550	871	2015
75	1905	1661	933	2159
80	2032	1771	996	2303
85	2159	1882	1058	2447
90	2286	1993	1120	2591
95	2413	2104	1182	2735
100	2540	2214	1245	2879

 All measurements are approximate and may vary from the actual sizes. If you want a permanent installation of the projector, we recommend that you use the actual projector to physically test the projection size, distance, and the projector's optical characteristics prior to the installation. This helps you determine the exact mounting position which best suits your installation.

# Operations

## Attaching the plug head

1. Place the plug head onto the adapter.
2. Rotate the plug head clockwise until it clicks into place.

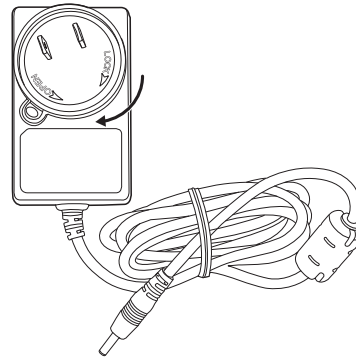

## Removing the plug head

1. Press the button next to the plug head on the adapter.
2. Rotate the plug head counter-clockwise and remove the plug head from the adapter.

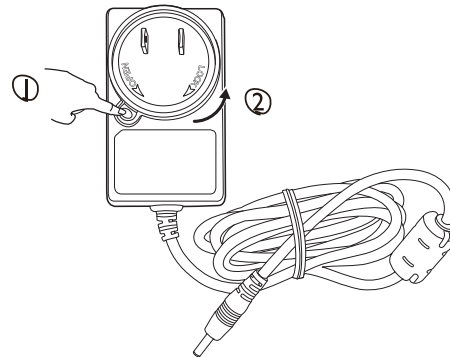

---

 Images above may differ depending on the region of the plug head.

---

## Charging the battery

1. Charge the projector's battery by leaving the supplied power adapter connected to the projector and a power outlet.

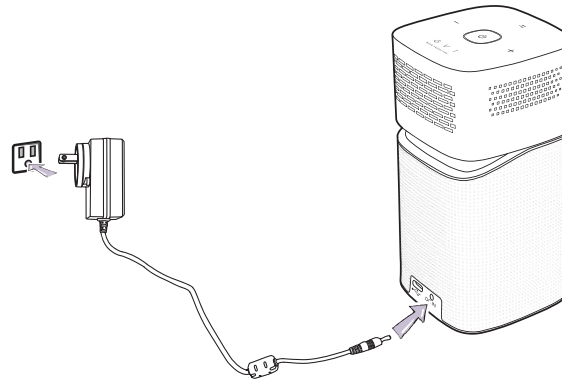

2. The power LED indicator will illuminate according to its charge status, for a full charge wait until the indicator lights up solid green (see [LED Indicators on page 19](#) for more information on LED behavior).

