

BenQ-SIEMENS EF61

Mobile Phone

User Manual

Copyright

© 2006. BenQ Mobile GmbH & Co. OHG. All rights reserved. No part of this publication may be reproduced, transmitted, transcribed, stored in a retrieval system or translated into any language or computer language, in any form or by any means, electronic, mechanical, magnetic, optical, chemical, manual or otherwise, without the prior written permission of BenQ Mobile GmbH & Co. OHG.

Disclaimer

BenQ Mobile GmbH & Co. OHG makes no warranty or representation, either expressed or implied, with respect to the quality, accuracy or fitness for any particular purpose of this document. The information in this document is correct at the time of printing and subject to change without notice.

Safety information

For your safety, please read the guidelines below carefully before you use your phone:

Exposure to radio frequency signals

Max. SAR measurement

EU: GSM900: 0.79 W/Kg; DCS1800: 0.369 W/Kg.

USA: PCS1900:0.71 W/Kg (head); 0.46 W/Kg (body).

Your wireless handheld portable telephone is a low power transmitter and receiver. When it is ON, it receives and also sends out radio frequency (RF) signals.

European and international agencies have set standards and recommendations for the protection of public exposure to RF electromagnetic energy.

- International Commission on Non-Ionizing Radiation Protection (ICNIRP) 1996
- Verband Deutscher Elektringenieure (VDE) DIN- 0848
- Directives of the European Community, Directorate General V in Matters of Radio Frequency Electromagnetic Energy
- National Radiological Protection Board of the United Kingdom, GS 11, 1988
- American National Standards Institute (ANSI) IEEE. C95.1- 1992
- National Council on Radiation Protection and Measurements (NCRP). Report 86
- Department of Health and Welfare Canada. Safety Code 6

These standards are based on extensive scientific review. For example, over 120 scientists, engineers and physicians from universities, government health agencies and industry reviewed the available body of research to develop the updated ANSI Standard.

The design of your phone complies with these standards when used normally.

Specific operating restrictions

No metallic component allowed in body-worn accessories.

Phone operation

- Normal Position: Hold the phone as you would with any other telephone.
- To avoid potential RF interference, please do not wear the phone around your neck or in front your chest for long hours.

Batteries

- For safety concerns, when the temperature of the phone goes over 45°C (113F) or below 0°C (32F), charging will halt.
- Do not expose batteries to temperatures below -10°C (14F) or above 45°C (113F). Always take your phone with you when you leave your vehicle.
- Use only genuine battery to ensure the phone's normal operation.

All batteries can cause property damage, injury or burns if a conductive material such as jewelry, keys or beaded chains touches exposed terminals. The material may complete electrical circuit and become quite hot. To protect against such unwanted current drain, exercise care in handling any charged battery, particularly when placing it inside your pocket, purse or other container with metal objects. When battery is detached from the phone, your batteries are packed with a protective battery cover; please use this cover for storing your batteries when not in use.

Driving

Check the laws and regulations on the use of wireless telephones in the areas where you drive. Always obey them. Also, if using your phone while driving, please:

- Give full attention to driving--driving safety is your first responsibility.
- Use hands-free operation, if available.
- Pull off the road and park before making or answering a call if driving conditions so require.

Electronic devices

Most modern electronic equipment is shielded from RF signals. However, certain electronic equipment may not be shielded against the RF signals from your wireless phone.

Pacemakers

The Health Industry Manufacturers Association recommends that a minimum separation of six (6") inches be maintained between a handheld wireless phone and a pacemaker to avoid potential interference with the pacemaker. These recommendations are consistent with the independent research by and recommendations of Wireless Technology Research.

Persons with pacemakers:

- Should **ALWAYS** keep the phone more than six inches from their pacemaker when the phone is turned **ON**.
- Should not carry the phone in a breast pocket.
- Should use the ear opposite the pacemaker to minimize the potential for interference.

If you have any reason to suspect that the interference is taking place, turn your phone **OFF** immediately.

Hearing aids

Some digital wireless phones may interfere with some hearing aids. In the event of such interference you may want to consult your hearing aid manufacturer to discuss alternatives.

Other medical devices

If you use any other personal medical device, consult the manufacturer of your device to determine if they are adequately shielded from external RF energy. Your physician may be able to assist you in obtaining this information.

Turn your phone **OFF** in health care facilities when any regulations posted in these areas instruct you to do so. Hospitals or health care facilities may be using equipment that could be sensitive to external RF energy.

Vehicles

RF signals may affect improperly installed or inadequately shielded electronic systems in motor vehicles. Check with the manufacturer or its representative regarding your vehicle. You should also consult the manufacturer of any equipment that has been added to your vehicle.

Posted facilities

Turn your phone **OFF** in any facility where posted notice so requires.

Aircraft

FCC regulations prohibit using your phone while in the air. Switch **OFF** your phone before boarding an aircraft.

Blasting areas

To avoid interfering with blasting operations, turn your phone **OFF** when in a “blasting area” or in area posted “TURN OFF TWO-WAY RADIO.” Obey all signs and instructions.

Potentially explosive atmospheres

Turn your phone **OFF** and do not remove the battery when in any area with a potentially explosive atmosphere and obey all signs and instructions. Sparks, from your battery, in such areas could cause an explosion or fire resulting in bodily injury or even death.

Areas with a potentially explosive atmosphere are often, but not always clearly marked. They include fueling areas such as gasoline stations; below deck on boats; fuel or chemical transfer or storage facilities; vehicles using liquefied petroleum gas (such as propane or butane); areas where the air contains chemicals or particles, such as grain, dust, or metal powders; and any other area where you would normally be advised to turn off your vehicle engine.

For vehicles equipped with an air bag

An air bag inflates with great force. **DO NOT** place objects, including both installed or portable wireless equipment, in the area over the air bag or in the air bag deployment area. If in-vehicle wireless equipment is improperly installed and the air bag inflates, serious injury could result.

**This device complies with Part 15 of the FCC Rules.
Operation is subject to the following two conditions:**

1. this device may not cause harmful interference, and
2. this device must accept any interference received, including interference that may cause undesired operation.

Changes or modifications not expressly approved by the party responsible for compliance could void the user's authority to operate the equipment.

For body worn operation, this phone has been tested and meets the FCC RF exposure guidelines for use with an accessory that contains no metal and that positions the handset a minimum of 1.5 cm from the body. Use of other enhancements may not ensure compliance with FCC RF exposure guidelines. If you do not use a body-worn accessory and are not holding the phone at the ear, position the handset a minimum of 1.5 cm from your body when the phone is switched on.

European Union Directives Conformance Statement

Hereby, BenQ Mobile, declares that this EF61 is in compliance with the essential requirements and other relevant provisions of Directive 1999/5/EC. The relevant declaration of conformity (DoC) has been signed. Please call the company hotline if you require a copy of the original or visit:

www.BenQMobile.com/conformity

CE0168



Permanent hearing loss may occur if you use ear- or head-phones at high volume. You can adapt over time to a higher volume, which may sound normal but can be damaging to your hearing. Set your volume to a safe level. If you experience ringing in your ears, reduce the volume or discontinue use of your system.



Dispose of unwanted batteries and phones as permitted by the laws in your countries.

Table of Contents

1. Safety information.....	i
2. Preparing your phone for use.....	1
Removing the back cover	1
Removing the battery.....	1
Inserting a SIM card	2
Installing a battery	3
Installing the back cover	3
Charging the phone	4
Turning the phone on	5
The microSD card.....	6
3. Getting to know your phone	7
Your phone at a glance	7
External display	8
Idle screen	9
Using the keys in idle mode	11
Menu navigation.....	14
4. Using your phone.....	15
Call functions	15
Making a phone call	15
Ending a phone call.....	15
Answering a phone call	15
Rejecting an incoming call.....	15
Adjusting the volume	16
Making an international call.....	16

Making an emergency call.....	16
Dialing an extension number	16
Speed dialing.....	16
Listening to voicemails.....	17
Operations during a call.....	17
Phone Book.....	21
Adding contacts to the Phone Book.....	21
Finding contacts in the Phone Book	24
Last missed, dialed, and received calls	25
Using the silent profile.....	25
Camera	26
Taking photos.....	26
Adjusting camera mode settings.....	27
Icons in camera mode	29
Attaching a voice annotation to your photo.....	31
Managing your photos.....	32
MP3 player	34
Playing music.....	34
Shortcuts.....	38
Setting shortcuts.....	38
Using shortcuts.....	38
Messages	39
SMS	39
MMS.....	42
Voicemail	46
Cell Broadcast.....	47
Memory Status	47

Input methods.....	48
Changing the input method	48
Shifting between upper and lower case letters.....	48
Multitap text input	48
T9 text input	49
Numeric input	51
Entering symbols.....	51
Bluetooth and USB connection	51
Bluetooth	51
USB Connection.....	53
5. Menus	56
Phone Book.....	56
Find	56
Add.....	56
Edit	56
Copy.....	56
Delete	57
Caller Group	57
Privacy Manager.....	57
Business Card	57
My Number	57
Memory Status	58
Messages	58
Calls	58
Missed	58
Received	58
Dialed.....	58

Cleanup All	58
Duration.....	59
Cost	59
Games	60
All Games.....	60
Settings.....	60
Memory Status	61
Entertainment	61
Camera.....	61
MP3 Player.....	61
FM Radio	61
Recorder.....	62
Media Center.....	63
Images	63
Music.....	64
Other	65
Format microSD.....	65
Memory Status	65
Tools	65
Alarm	65
World Clocks.....	66
Bluetooth	66
Calendar	67
To Do List	67
Note.....	68
Shortcuts.....	68
Calculator.....	68

Currency Converter	68
Stopwatch	69
Countdown Timer.....	69
USB Connection.....	69
Services	70
ClubBenQ Online.....	70
WAP Service	70
NAP Settings.....	72
Service Number	72
STK Menu.....	72
Settings	73
Date & Time	73
Auto Power On/Off.....	73
Profiles	74
Display	75
Audio.....	76
Call Ring.....	76
Message Tone.....	76
Calendar Tone	76
Keypad Tone.....	77
Ring Volume.....	77
Speech Volume	77
Key Assignment	77
Call Settings	77
Answer Mode.....	77
Connect Alert.....	78
Minute Minder	78
Show Number	78
Call Divert	78

Call Barring.....	79
Call Waiting	80
Auto Redial	80
Fixed Dialing No.....	81
Active Line	81
User Group	81
Network	82
Network Mode.....	82
Available List.....	82
Band Setting	83
Connection	83
Security	83
PIN Code.....	83
Phone Lock	84
SIM Lock	84
Power Saving Mode.....	84
Language	84
Input.....	84
Flight Mode.....	85
Restore	85
6. Care and maintenance	86
7. Troubleshooting.....	87

1 Preparing your phone for use

Removing the back cover

1. Use a thin object such as a finger nail to press in at the groove just below the cover on the center top edge of the phone as illustrated.
2. Lift the cover off the phone.

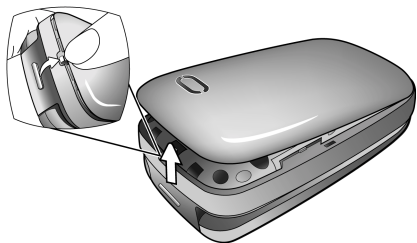

Removing the battery

1. Push to release the battery latch.
2. Lift the battery off the phone.

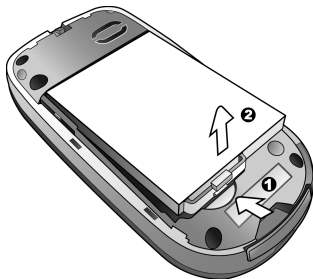

Inserting a SIM card

1. To release the SIM card holder, slide the card holder backward (1) and lift it up (2).
2. Insert the SIM card into the card holder (3). Ensure that the cut corner is at the top and the metal contacts face the phone (4).
3. Slide the card holder forward to lock it (5).

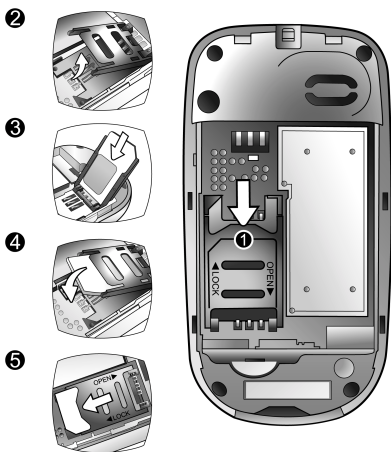

A SIM card can be easily damaged if its metal contacts become scratched. Therefore, take special care when holding or inserting it.

Installing a battery

1. Carefully place the battery onto the back of the phone, with the battery's contacts facing downwards in alignment with the tab in the battery compartment.
2. Push the battery against the top of the compartment and press it down to click it into the compartment.



Do not remove the battery when the phone is on. Doing so could cause you to lose personal settings or data stored either on your SIM card or in the phone's memory.

Installing the back cover

1. Place the back cover onto the back of your phone.
2. Slide forward until the latch catches the cover.



Charging the phone

The battery is not fully charged when first unpacked.

1. Attach the larger end of the provided data cable to the power adapter.
2. Plug the smaller end of the data cable into the connector jack at the left edge of your phone, with the arrow showing upwards.
3. Plug the power adapter to an appropriate wall outlet and charge for at least 4 hours.
4. Once the phone is fully charged, remove the data cable from both the wall outlet and the phone.

Alternatively, you can connect the phone to the USB port on your computer with the provided data cable for charging.



Do not remove the battery while the phone is charging.





Please note:

- It takes approximately 4 hours to fully charge a battery.
- When the battery is weak, the phone will play an alert sound.
- When the battery is discharged, the charging may not start immediately when you plug in the connector. Wait 10 to 15 minutes for the phone to begin charging.

Turning the phone on

1. Long-press  to turn the phone on. The phone will display the welcome animation.

 To set a welcome message, go to: **Settings > Display > Welcome Message**. For details, please refer to page 75.

 In this user manual, "long-press" means to press and hold down a key for about two seconds. "Press" means to press a key and release immediately.

2. Enter your PIN code and press  to confirm.

 The PIN (Personal Identification Number) is the password provided by your network operator. You need this password in order to use the SIM card.



If you enter the PIN incorrectly three times in a row, the SIM card will be locked. You must now enter the PUK (Personal Unblocking Key) for that SIM card in order to unlock it. Please contact your network operator to obtain a PUK.

 To activate/disable PIN password authentication, go to **Settings > Security > PIN Code > PIN1 Code > Set Status**. See page 83.

3. When the PIN code entered has been accepted, the phone will automatically search for the designated network. This search process may take a few seconds.
 4. The idle screen will be displayed, as well as network signal strength and the name of the network operator. You can now use the phone.
-  If the phone is not able to detect the designated network, or links to a network that you are not authorized to use, the signal strength meter will show no bars. You will only be able to make emergency calls.

The microSD card

Your phone features a microSD slot designed specifically for use with the microSD card, a removable flash memory card intended to add greater storage capacity to your phone.

The microSD card enables you to store multimedia data, including images, photos, MP3 audio files, and ring tones.

Installing the microSD card

1. Lift the cover.
2. Insert the microSD card into the slot. Ensure that the card's metal contacts face upwards.
3. Close the cover.

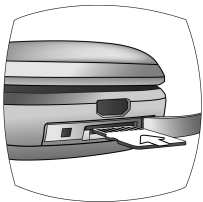

 Please note:

-  will appear in the status bar when the microSD card is loaded.
- Your phone does not support a microSD card which is on **FAT32** or **NTFS** format.

Removing the microSD card

1. Lift the cover.
2. Press the microSD card to release it.

2 Getting to know your phone

Your phone at a glance

Front open view

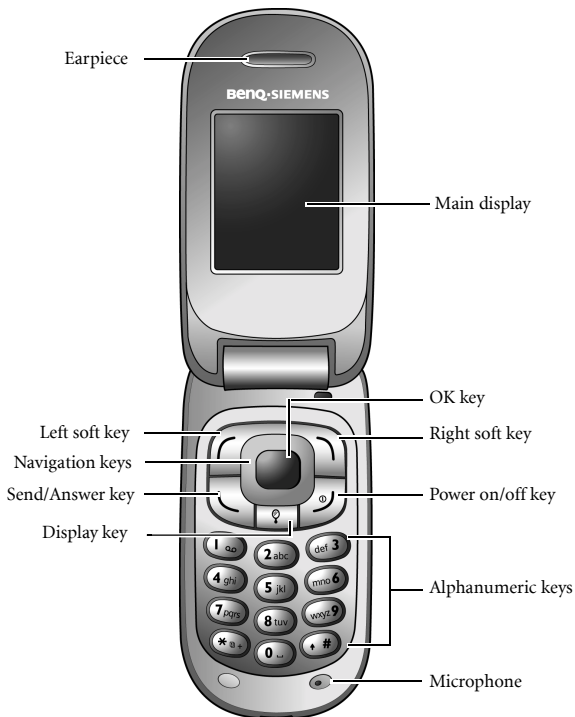

Side view

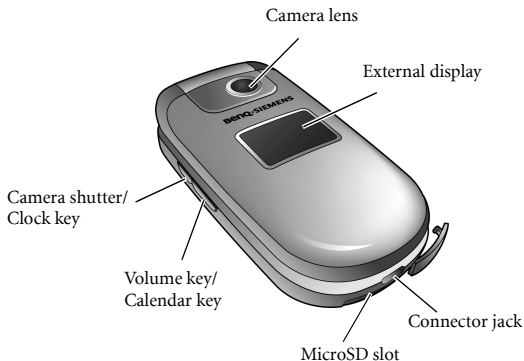

External display





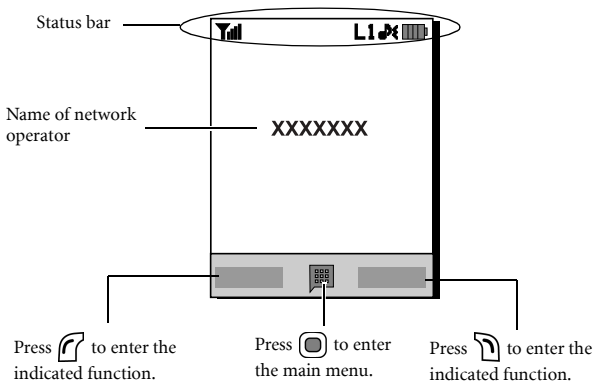









When the flip is closed, the external display's status bar will show icons for network strength, battery power, the current time and the current profile in use. The external display will also alert you to incoming calls, new messages and missed calls.







Idle screen





- To set the wallpaper of the display, go to **Settings > Display > Wallpaper**. Alternatively, you can go to **Media Center > Images**. See page 63 and page 75.
- To set the theme of the display, go to **Settings > Display > Theme**. See page 75.
- To set the current time and date, as well as the format to be shown, go to **Settings > Date & Time**. See page 73.
- To enter text (such as the user name) to be displayed on the idle screen, go to **Settings > Display > Personal Banner**.







Icons in the status bar





Icon	Function	Description
	Signal strength	Signal strength of the network. The more bars indicated, the stronger the signal.
	Battery status	The current level of battery power. The more bars indicated, the more power remains.
	GPRS in use	GPRS has been activated.
	Bluetooth	Bluetooth is turned on.
	Message	You have new or unread SMS messages.
	MMS message	You have new or unread MMS messages.
	WAP message	You have new or unread WAP messages.
	Voicemail	You have new voicemail messages (this icon will only appear if the function is supported by your network operator).
	Alarm	The alarm is turned on.
	Line1 or Line 2 in use	Shows the line now in use.
	Normal	The profile is Normal .
	Meeting	The profile is Meeting .
	Silent	The profile is Silent .
	Outdoors	The profile is Outdoors .

Icon	Function	Description
	Personal	The profile is Personal .
	Flight mode	The profile is Flight mode .
	Headset	A headset is connected to the phone.
	Divert	The call divert is activated.
	Roaming	Roaming is activated (not your regular network).
	MicroSD Card	MicroSD card is loaded.



Using the keys in idle mode



Key	Commands and functions
	<p>Power on/off key</p> <ul style="list-style-type: none"> • Long-press to turn the phone on or off. • Press to end a call, reject an incoming call, or to cancel a dialing.
	<p>Send/Answer key</p> <ul style="list-style-type: none"> • Press to send or answer a call. • Press to access the call record list.
	<p>Left soft key</p> <p>Press to perform the function indicated on the bottom left of the display. To designate the function to be accessed by the left soft key, go to Settings > Key Assignment. See page 77.</p>

Key	Commands and functions
	<p>Right soft key</p> <ul style="list-style-type: none"> • Press to perform the function indicated on the bottom right of the display. To designate the function to be accessed by the right soft key, go to Settings > Key Assignment. See page 77. • Long-press to turn the silent profile on or off.
	<p>OK key and navigation keys</p> <ul style="list-style-type: none"> • Press the OK key to open up the main menu. • Press the navigation keys to perform the functions indicated. To assign the key function, go to Settings > Key Assignment. See page 77.
	<p>Display key</p> <p>Press to switch the display on/off and to use it as a mirror.</p> <p> The keypad is still active when display is turned off.</p>
	<p>Asterisk key</p> <ul style="list-style-type: none"> • Press to enter an asterisk " * ". • To make an international call, long-press this key until the display shows "+", then enter the recipient's country code, area code and phone number.
	<p>Voicemail key</p> <p>Long-press to dial your voicemail number.</p>

Key	Commands and functions
	<p># key</p> <ul style="list-style-type: none"> • Press to enter "#". • For extensions: After entering a phone number, long-press to enter a "P" and then enter the extension number.
	<p>Alphanumeric keys</p> <ul style="list-style-type: none"> • Press to enter digits. • Shortcut key: Long-press a key to immediately access the function, or dial the number, that it represents. See page 38, "Shortcuts".
	<ul style="list-style-type: none"> • Long-press to open the camera. • When the flip is closed, press to check the time.
	<p>Volume key</p> <ul style="list-style-type: none"> • Press the upper or lower portion of the key to adjust volume. • Long-press the upper portion of the key to reject an incoming call. • Long-press the lower portion of the key to mute an incoming call. • When the flip is closed, press to open the calendar.

Menu navigation

1. In idle mode, press  to bring up the main menu.
2. Use the navigation keys to move up, down, right or left through the menu, for example, scroll to **Settings**, and press  to enter its menu.
3. Use the navigation keys to scroll to a submenu, for example **Profiles**, and press .

 You can also access a menu item by pressing the corresponding menu number. In the above example, press  in **Settings** to access **Profiles**.

Using your phone

Call functions

Making a phone call

In idle mode, enter the phone number. Press  to dial your call.

Ending a phone call

To end a call, press  or close the flip. The display will show the total call time, and then return to idle mode.

Answering a phone call

To answer a call, do one of the following:

- With the flip closed, open the flip.
- With the flip open, press .

 If you wish to press any key to answer a call, go to **Settings > Call Settings > Answer Mode > Any Key.**

Rejecting an incoming call

To reject an incoming call, do one of the following:



- Long-press the upper portion of the volume key at the side of the phone.
- With the flip open, press , or close the flip.

Adjusting the volume

During a call, if you want to adjust the speech volume, you can press the volume key at the side of the phone.

 When there is an incoming call, you can mute the ring tone by long-pressing the lower portion of the volume key at the side of the phone.



Making an international call

1. Enter the outgoing international call code, or long-press  until "+" appears on the display.
2. Enter the recipient's country code, area code and phone number. Dial the call by pressing .

Making an emergency call

To call emergency services, enter 112 (the international emergency number) and then press  to dial the call. You can make an emergency call even if your phone is locked, cannot access your network, or there is no SIM card inserted, as long as you are within range of a network of the type supported by your phone.

Dialing an extension number

1. After entering a telephone number, long-press  until "P" appears.
2. Enter the desired extension number, and then press  to dial it.

Speed dialing



 You must assign a number key as the shortcut for a particular phone number in order to use speed dialing for that phone number. For information on how to set up a shortcut, see page 38, "Shortcuts".

After you have assigned a number key to serve as the shortcut key for a particular phone number, long-press this key when the phone is in the idle mode to dial the corresponding phone number.

Listening to voicemails

Long-press  to dial the voicemail phone number and listen to your voicemails.



 Please note:

- If the network vendor supports it, the voicemail icon  will appear on the display when you have new voicemails.
- If the voicemail number is not stored in the memory, you will not be able to access your voicemail by long-pressing . In this case, you will need to manually set the number by going to **Messages > Voicemail > Set Number**.

Operations during a call





 The following options marked with an asterisk (*) are dependent on network support and may require a subscription.

Loudspeaker

Press  (**Loudsp.**) to turn on the loudspeaker. To turn off the loudspeaker, press  (**Handset**).

Putting a call on hold*

- When only one call is active:
 - a. Press  (**Hold**) to hold this call.





- b. Press  to end this call.
- When the only call is on hold:
 - a. Press  (**Unhold**) to resume the call.
 - b. Press  to end this call.
- When there is an active call and a call on hold.
 - a. Press  (**Swap**) to resume the call that is on hold, and put the active call on hold.
 - b. Press  to show a list of calls that you can end.

Making a second call*

Enter a phone number, or select one from the phone number or call record, and then press  to dial it. The currently active call will automatically be placed on hold.

Call waiting*

If there is an incoming call while you are on the phone, the phone will notify you with a call waiting tone. If you want to

- Answer the waiting call: Press . The currently active call will automatically be placed on hold. However, if there is already another call on hold, a list will appear allowing you to select a call to end and then answer the waiting call.
- Reject the waiting call: Press  or  (**End**). Pressing  (**End**) will immediately reject the waiting call; pressing  will bring up a list allowing you to select a call to end.

Call menu

If you press  during a call, it will bring up a call menu which provides a number of functions during a call.

 Items marked with an asterisk (*) depend on network support and may require a subscription.

Use Headset

Allows you to use the Bluetooth headset. For details, see page 52, "Establishing a connection with your Bluetooth headset".

Use Loudspeaker/Handset

Switch between the loudspeaker and handset functions.

Phone Book

Allows you to search for a number in the Phone Book.

Calls

Allows you to view missed, received, and dialed calls.

Conference*

Conference calls allow you to converse with more than one party at a time.

Hold/Unhold/Swap*

Toggles the call status.

Join/Private

Adds a party that is on hold to the current conference call, or isolates a single party in a conference call and puts all other parties on hold.

Transfer

Allows two parties to connect, while ending one's own call (one of the two parties may be involved in an active call while the other is either on hold or being dialed), so as to allow the two parties to have their own call.

Send DTMF

When the phone is connected with other devices or services, you can send DTMF (Dual Tone Multi-Frequency) strings. DTMF strings are keypad tones that can be sent via the microphone as you dial another number. Your phone will emit the tones in order to communicate with answering machines, pagers, computerized telephone services, and so forth.

Enter the number and then press  to send the DTMF string.

End Call

End All

Ends all calls, whether active or on hold.

End Active

Ends only the active call.

End Hold

Ends only a call or calls on hold.

End One

Ends only a single call by the number or the contact.

Anonymous

Ends an anonymous call.

Hold/Unhold/Swap

Toggles the call status.

Mute/Unmute

Activates/cancels the silent mode.

SMS

Allows you to read or write an SMS message during a call. For details, see page 39, "SMS".

Calculator

Allows you to use the calculator. For details, see page 68, "Calculator".





Call Memo

Allows you to record during a call. The recorded files are accessible in **Media Center > Music > Recordings**.

Phone Book

Adding contacts to the Phone Book

 The capacity of a phone book on your SIM card depends on the type of SIM card provided by your network operator.

1. In idle mode, enter the phone number that you want to save, then press  (**Save**).
2. Select the memory where the contact is to be stored. Select from either **Add to SIM** or **Add to Phone**.
3. Scroll to the data field that you want to edit, and then press  to enter data.
4. Press  to return to the phone book data field after filling the entry.
5. Press  (**Option**) to
 - **Save:** Save the entries you have entered.

- **Change Type:** Change the category of the phone number (for example, from **Mobile Number** to **Home number**). This option can only be used in the phone number data field.
 - **Add New Field:** Adds additional data fields for a contact.
 - **Delete Field:** Removes the selected data field.
6. Once you have completed editing, press  (**Option**) and select **Save** to save contact's details.

Phone book entries on SIM card memory

Name	The contact's name.
Number	The contact's phone number.
Caller Group	Used to select a caller group for the contact. To define each caller group, go to Phone Book > Caller Group . See page 57.

Phone book entries on phone memory

Name	The contact's name.
Mobile Number	The contact's mobile phone number.
Home Number	The contact's home phone number.
Email	The contact's email address.
Caller Group	Used to select a caller group for the contact. To define each caller group, go to Phone Book > Caller Group . See page 57.

Additional phone book entries on phone memory





Mobile Number	The contact's mobile phone number.
Home Number	The contact's home phone number.
Office Number	The contact's office phone number.
Other Number	Other phone number for the contact.
Home Address	The contact's home address.
Office Address	The contact's office address.
Company	The contact's company name.
Department	The contact's department name.
Position	The contact's position.
Note	Used to edit notes for the contact.
Special Day	Used to enter a special day of the contact.
Ring ID	<p>Used to set a ring tone for the contact. When there is an incoming call from the contact, the phone will play this ring tone.</p> <p> A ring tone set in this field will replace the one associated with the contact's caller group, if any.</p>



Image ID	<p>Used to set the image that will appear on the display when there is an incoming call from the contact.</p> <p> The image set in this field will replace the image associated with the contact's caller group, if any.</p>
----------	---

Finding contacts in the Phone Book



1. In idle mode, press the corresponding key for **Names** to display contacts stored in the Phone Book.
2. Press the alphanumeric key that corresponds to the first letter of the name you wish to locate the appropriate number of times.
3. If necessary, scroll to the entry you want.

 The default options designated for left and right soft keys may vary by region and may not be **Names**. To designate the function to be accessed by the soft keys, go to **Settings > Key Assignment**. See page 77.

 You can also go to **Phone Book > Find**, and then enter the full name or the first letter of the name to locate a contact.

  will appear on the top of the screen if the contact is stored on your SIM card;  will appear if the contact is stored in your phone memory.

When you have found the entry you want, you can



- Press  to view the contact's details.
- Press  to dial the number. If the entry has more than one phone number, then you will be prompted to select a number.





- Press  (Option) to **Add, Edit, Copy to SIM/Copy to Phone, Delete,** or **Send vCard** to a contact. To send the contact's data by SMS or by Bluetooth, select **Send vCard**.

 For information on using Bluetooth, see page 51, "Bluetooth".



Last missed, dialed, and received calls

There are three ways you can view the last missed, dialed, and received calls on your phone.

- If there have been any missed calls, the display will show a missed call message along with the number of calls that were missed. Press  to view the missed call number.
- In idle mode, press  to view the list of the most recent missed, dialed, and received calls.
- Go to **Calls** and scroll to **Missed, Received, or Dialed**.



 The icon  will show beside missed calls;  will show beside dialed calls;  will show beside received calls.

Scroll to the number you want and then

- Press  to call back.
- Press  (Option) and select your desired function.

Using the silent profile

In idle mode, you can long-press  to activate the silent profile. Once it is activated, the phone will alert you to an incoming call by vibrating without ringing.

1. When you long-press  to activate the silent profile, the phone will vibrate for one second. The icon  will appear in the status bar.
2. To turn off the silent profile, long-press .

 To select or define a profile, go to **Settings > Profiles**. See page 74, "Profiles".

Camera

Your phone features a digital camera that allows you to take a photo, and then set it as an image ID or wallpaper. You can also send a photo by MMS or by Bluetooth.

Taking photos

1. Go to **Entertainment > Camera** to activate camera mode, or long-press  at the side of the phone. The viewfinder is then displayed.

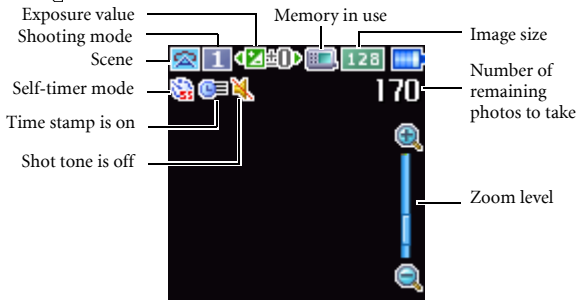





2. Press  (**Option**) to bring up the settings menu. For functions of various settings, see page 27, "Adjusting camera mode settings".

 The icons on the screen will be changed according to the settings you made. For description on each icon, see page 29, "Icons in camera mode".

3. When viewfinder appears, press the left or the right navigation key to adjust the exposure value; press the up or down navigation key to zoom in or out.



 The zoom function will be disabled when the image size is set as 1280 x 960 and 768 x 960.

4. To take a photo, press  or  at the side of the phone. The photo will be saved to the phone memory or to the microSD automatically according to the setting you made. For the options of adjusting settings, see page 27, "Adjusting camera mode settings". For the options of previewing photos, see page 31, "Attaching a voice annotation to your photo".

 To delete the newly saved photo, press  (**Delete**). To return to the viewfinder without deleting the one just taken and saved, press .

Adjusting camera mode settings









1. Press  (**Option**) to bring up the settings menu.

2. Press the up or down navigation key to scroll to the desired option and then press  to save the setting. If you do not want to adjust the setting, press  (**Back**) to return to the viewfinder.

Name	Functions
View Photos	Goes to the photos album
Set Self-Timer	Photo is taken a few seconds later. Choose between 5 or 10 seconds, or turn the option off.
Hide/Show Icons	Allows you to hide or show the icons displayed in the viewfinder.
Settings	Allows you to change the camera mode settings.

3. To view camera mode settings, select **Settings**. When the setup is done, press  (**Save**) to save the settings.

Options of camera mode settings are

Icon	Name	Functions
	Image Size	Allows you to set the desired image size.
	Scene	Enables you to load preset settings that best suit the environment you are in.
	Shooting Mode	Allows you to select between single shot and multishots. The options appear differently with different image size you choose.
	White Balance	Enables you to load preset settings for specific lighting conditions.
	Effect	Enables you to apply a tone or color to your photo to create an artistic effect.
	Quality	Sets the image quality (compression ratio).
	Time Stamp	Add a time stamp to your photo.
	Sound	Allows you to set the shot tone on or off.
	Save to	Allows you to change the default memory to phone memory or microSD.

 Some options may not be available depending on the image size you set.

Icons in camera mode

















The icons on the screen will be changed according to the settings you made. To hide or show the icons, press  (**Option**) and select **Hide Icons/Show Icons**.



Image size

Icon	Mode	Icon	Mode
	1280 x 960		320 x 240
	768 x 960		128 x 160
	640 x 480		96 x 64
	384 x 480		



Scene

Icon	Mode
	Auto
	People
	Landscape
	Sunny
	Sunset
	Night
	Snow
	Text



Self-Timer

Icon	Function
	5 Seconds
	10 Seconds



Shooting Mode

Icon	Function
	Single
	9 MultiShot

Save to



Icon	Function
	microSD
	Phone Memory

Attaching a voice annotation to your photo



1. After a photo is taken, press  (**Option**) and select **Record**.
2. Press  to start recording; the maximum length is 60 seconds.

3. Press  again to stop recording. The photo and the attached voice annotation will be played after the recording is stopped.

 The recorded voice annotation will be named identically with the photo that is to be attached to, with different extensions though. If the photo is renamed, the voice annotation has to be renamed to the same name so that it can be played with the corresponding photo at the same time.



To rename a photo, select the photo in **Entertainment > Camera > View Photos** or in **Media Center > Images > Camera Photos**, and press  (**Option**) to select **Rename**. To rename a voice annotation, go to **Media Center > Music > Recordings**, select the annotation and press  (**Option**) to select **Rename**.

Managing your photos

1. Press  (**Option**) to bring up the settings menu.
2. Go to **View Photos**. You will find a list or thumbnails of the photos taken depending on your setting.
3. Select  (**Option**) to view the setting menu. Scroll up or down to the following options.



Name	Options
Send	Allows you to send the photo by MMS or by Bluetooth.
Delete	Deletes the photo.
Set	Allows you to set the photo as Wallpaper, Image ID for a new/existing contact, or as a Group Image ID for a caller group.
Move	Allows you to move the photo to a folder, or to or from the microSD card.

Name	Options
Copy	Allows you to copy the photo to a folder, or to or from the microSD card.
Slideshow	Allows you to view photos you have taken in a slideshow.
Browsing Mode	Allows you to view the photos in a list or in thumbnails.
New Folder	Allows you to create new folders to store photos.
Protect	Protects the photo from deletion.
Unprotect	(Available when a photo is protected) Frees the protected photo.
Rename	Allows you to rename the photo.
Delete All	Deletes all the photos in the selected folder.
Details	Shows you the details of this photo such as name, resolution, and size.

4. Press  to select the desired option.
5. Press  to save the setting.
6. Press  (**Back**) to return to the viewfinder.

MP3 player

Your phone features an MP3 player which allows you to play your favorite music on the go. To access the MP3 player, go to **Entertainment > MP3 Player**.

-  You can upload music from a computer to your phone using Bluetooth or the supplied USB data cable. For details, see page 51, "Bluetooth and USB connection".
-  The MP3 player plays music files stored on the microSD card.
-  The MP3 player can only play audio files saved in the following formats: MP3 (MPEG1-LAYER3/MPEG2-LAYER3/OMA DRM v.1.0), AAC (ADTS Format, ADIF Format (LC Profile)/OMA DRM v.1.0), and WMA.

Playing music

Select and play one track from **Tracks** or from a playlist in **Playlists**, and all the tracks in the same folder or the same playlist will be played.

You can use the navigation keys to perform the functions indicated on the screen.



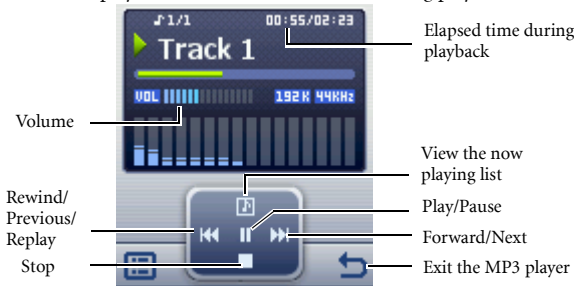





Below is the MP3 player screen when a music file is being played.



Function	Description
Volume	Press the volume key to adjust the playback volume.
Rewind/Previous/Replay	<ul style="list-style-type: none"> • During playback, long-press to rewind. • During playback, if elapsed time is less than or equal to 2 seconds, press to play the previous track. • If elapsed time exceeds 2 seconds, press to replay the current track.
Forward/Next	<ul style="list-style-type: none"> • During playback, long-press to forward. • Press to go to the next track.
Play/Pause	<ul style="list-style-type: none"> • Press to play the current track. • Press to pause the playback; press again to resume the playback.
Stop	Press to stop the playback.



☞ Tracks will be played in the sequence which they are saved in the now playing list. To play tracks at random order, press  to go to **Settings > Use Shuffle**.

Building a playlist

1. On the MP3 player screen, press  () and select **Playlists** to build your playlist.
2. Press  (**Option**) to select **Add**.
3. Name the playlist in Add Playlist screen, and press  to save.
4. When asked to add tracks to the new playlist, press  (**Yes**).
5. Scroll to the track you want to add, then press  to select the track. Repeat the step to include multiple tracks in the playlist.
6. Press  (**Done**) to exit the editing screen, or press  (**Back**) to return to the previous menu or the upper folder.

 Select **All** to select or deselect all tracks.

Viewing the Now Playing List



If you select a track and press  to play, the Now Playing List will display the tracks stored in the same playlist or folder. To view the now playing list, press  in MP3 player.

 If a file in the Now Playing List has been renamed or removed and thus can not be played, a question mark will display in front of it. For details, see page 90.

MP3 player settings

Press  to access available settings for the MP3 player.

Viewing all tracks

To view all tracks stored on the microSD card, press  and select **Tracks**. You can press  to start the playback.

Editing the playlist

Select **Playlists** and then press  (**Option**) to manage your playlists and music files.

Repeat

Go to **Settings > Set Repeat** to play one or all tracks repeatedly.

Play tracks randomly

Go to **Settings > Use Shuffle** to play tracks in a random order.

Showing lyrics

Go to **Settings > Show Lyrics** to have the lyrics displayed.

 The supported lyrics format is ID3v2.3.

Setting the EQ (Equalizer) mode

Go to **Settings > Set EQ** to choose your preferred EQ mode that will influence the sound during playback.

Using 3D sound



Go to **Settings > Use 3D Sound** to produce 3D sound effects during playback.

Setting the display mode

Go to **Settings > Display Mode** and set the display mode of the MP3 player.





Shortcuts

Allows you to assign 8 alphanumeric keys as shortcuts to commonly used functions or frequently dialed numbers.

  is assigned to voicemail dialing and you are not allowed to change it.

Setting shortcuts

Shortcuts allows you to set up quick access functions or phone numbers.

1. Scroll to the number key you wish to use as a shortcut key. You can also press the actual alphanumeric key to select it.
2. To add a function, press  (**Option**) and select **Add Function**. To add a phone number, press  (**Option**) to and select **Add Phone**. See step 3 if **Add Function** is selected. See step 4 if **Add Phone** is selected.
3. From the function shortcuts list, scroll to select an item. Press  to save the assigned shortcut.
4. From the contact list, scroll to select a contact. Press  to save the assigned shortcut.
5. Repeat the above step to add or modify function shortcuts.
6. To cancel a shortcut key and restore the key's original function, scroll to the shortcut key that you want to cancel, and then press  (**Option**). Select **Delete** to cancel the shortcut.

Using shortcuts

There are two ways to use shortcuts:

- In idle mode, long-press an alphanumeric key to access its assigned shortcut.



- Go to **Tools > Shortcuts**. You can then:
 - a. Scroll to the icon corresponding to the desired key. Then press  to access its assigned shortcut.
 - b. Press the corresponding alphanumeric key to access its assigned shortcut.

Messages

Your phone supports various messaging services including SMS (Short Messaging Service) and MMS (Multimedia Messaging service). SMS allows you to insert simple animations and ring tones into your text messages, while MMS enables you to send photos, colored images and music through your phone. You must have a subscription that supports MMS. Please contact your network operator for details.

SMS

Receiving a new message

1. When you receive a new message, the message icon  and a text message showing the number of messages received appear on the display.
2. To read the message, press . To manage the message, press  (**Option**). For details about managing received messages, see page 40, "Managing Inbox".

Creating a new message

1. To bring up the message editing screen, go to **SMS > New**. Use the alphanumeric keys to enter text.

 For information on the input method, see page 48, "Input methods".

2. To insert texts, images, melodies, vCard, or vCalendar into the message, press  (**Option**) and select **Insert**.





 You can also define your own text. See page 41, "Defining quick message templates".

3. To align texts, press  (**Option**) and select **Alignment**.

4. When you finish editing the message, press  to **Send Message**, **Save to Drafts**, **Save to Private Folder**, or **Discard** the message.



Managing Inbox

Your phone saves incoming messages in the Inbox. To manage Inbox messages, go to **SMS > Inbox**. A list of messages received appears. To view a message, scroll to it and press . Press  (**Option**) and select your desired function.



 Read messages saved on the phone or on the SIM will be marked by  or . Unread messages saved on the phone or on the SIM will be marked by  or .

 To decide where new messages will be saved to, go to **Message > SMS > Settings > Save Msg. To**.

Managing Outbox

Outbox stores failed messages. To manage Outbox messages, go to **SMS > Outbox**. To view a message, scroll to it and press . Press  (**Option**) and select your desired function.

Managing Sent Items

Sent folder stores messages that were successfully delivered. To manage Sent messages, go to **SMS > Sent**. To view a message, scroll to it and press . Press  (**Option**) and select your desired function.



Managing Drafts

Drafts folder contains messages that you chose to save. To manage drafts, go to **SMS > Drafts**. To edit a message, scroll to it and press .

Managing Private Folder

Go to **SMS > Private Folder**. The phone code is required to enter Private Folder.

Defining quick message templates

Templates folder contains a list of preset texts. To create your own text, go to **SMS > Templates**, then press  (**Option**) and select **Add** to edit. To save it press .

Cleaning up messages

To clean up messages, go to **SMS > Cleanup**. You can choose to delete message by category.

Settings

Your phone is already set up to send or receive messages. Contact your network operator for details.





MMS

In order to use MMS, you have to subscribe to both GPRS and MMS services provided by your operator. Contact your operator for details on MMS settings.

Downloading new messages

If you set **MMS > Settings > Deferred Download** on, the operator will send you a new message notification and the handset will not download the message. Press  if you wish to download the message.

Reading a message



Having successfully downloaded the MMS message, a text message showing the sender's name or address appears on the display, press  to start playing the MMS message page by page. Press  (**Stop**) to stop playing. Press  (**Option**) and select your desired function. If there are more than 2 MMS messages being downloaded, a text message displays showing the number of messages. Press  to enter Inbox.

Creating a new message

1. To write and send a new MMS message, go to **MMS > New**. To edit the message content, scroll to the **Content:** and then press .



Press  (**Option**) to execute the following tasks:

- **Insert:** Allows you to insert new photo, photos, images, melodies, text, vCard, vCalendar, or new pages.
- **Preview:** Plays all the pages in the message in sequence.
- **Remove Image:** Removes the image or photo inserted in the page.



- **Remove Melody:** Removes the ring tone inserted in the page.
 - **Remove Page:** Removes the current page.
 - **Previous/Next Page:** Go to previous or next page.
 - **Page Duration:** Sets the length of time that each page is displayed when playing the message.
 - **Spell:** Opens the spell check box to allow you to create your own word into the dictionary.
 - **Symbols:** Opens the symbol table.
 - **Input Methods:** To switch to another input method.
 - **Cases:** To switch to lower or upper cases, or to use Caps Lock.
 - **T9 Settings:** Enable **Choice List** to show the list of candidate words when you enter letters. Enable **Auto Completion** to complete the predicted word (if it was entered before), and use the scroll key to display alternative words.
2. After you finish creating the MMS message, press  to return to the main list.
- **To:** Enter the recipient's phone number or select a contact from your phone book by pressing  (**Browse**). To send your message, this field can not be left blank.
 - **Subject:** Allows you to enter text for the subject.
 - **Content:** Contains the message that you created.
 - **Cc:** Allows you to send the message as a carbon copy to others.
 - **Bcc:** Allows you to send the message as a confidential carbon copy to others.
 - **Priority:** Allows you to set the priority for this message.
 - **Receipt:** Allows you to set if a confirmation is to be sent back to you when the message has been delivered, read, or both.

3. Press  (**Option**) and select **Send Message** to send the message.



Managing Inbox

Your phone saves incoming messages in the Inbox. To manage Inbox messages, go to **MMS > Inbox**. A list of received messages appears. To view a message, scroll to it and press . Press  (**Option**) and select your desired function.

Managing Outbox

Outbox stores failed messages and messages to be sent until they are successfully delivered. To manage Outbox messages, go to **MMS > Outbox**. To view a message, scroll to it and press . Press  (**Option**) and select your desired function.

Managing Sent Items

Sent folder stores messages that were successfully delivered. To manage Sent messages, go to **MMS > Sent**. To view a message, scroll to it and press . Press  (**Option**) and select your desired function.

Managing Drafts

Drafts folder contains drafts of messages that you chose to save. To manage drafts, go to **MMS > Drafts**. To edit a message, scroll to it and press .

Managing Private Folder

Go to **MMS > Private Folder**. The phone code is required to enter Private Folder.

Templates

To use the preset MMS templates, go to **MMS > Templates**.

Cleaning up messages

To clean up messages, go to **MMS > Cleanup**. You can choose to delete message by category.

Settings

To set up advanced settings for MMS, go to **MMS > Settings**.

Filter

Your phone will reject all MMS messages from the senders listed here.

Expiry

Sets the length of time your outgoing MMS message stays on the server before it reaches the recipient successfully.

Reply Type

You can determine here whether you want to use an SMS message or MMS message in reply to an MMS message you have received.

Size Limit

Sets the maximum size for a message that the phone receives. If an incoming message exceeds this size, the phone will not be able to download that message.

Server Info

Activates the MMS server used for sending and receiving MMS messages.

Deferred Download

When set to On, the phone will only download the sender's details. You can then decide whether you want to download the whole message.

Delivery Report

Asks the recipient to return a confirmation after receiving your MMS message.

Read Report

Asks the recipient to return a confirmation after reading your message.

Voicemail

Get Voicemail

Dials the voicemail number provided by your network operator to access your voicemail box.

 In idle mode, long-press  to access your voicemail box.

Set Number

Allows you to save your voicemail phone number.

Cell Broadcast

Cell broadcast messages are messages that your network operator broadcasts to all phones within a particular area. These messages are broadcast in numbered channels. For example, channel 030 might be for local weather, 060 for traffic reports, 080 for information about local hospitals, taxis, pharmacies, and so forth. You can receive cell broadcast messages that your network operator broadcasts, and select your preferred topics and languages.



For more information about available channels and a list of the information they provide, contact your network operator.

Receive

To activate the cell broadcast feature, set this option to On.

Topics

The topics listed in the **Topics** list represent the broadcast information that you have selected to receive from your network operator.

Language



You can limit the cell broadcast information that you receive from your network operator to a specific language.

Memory Status



Shows the amount of used and available memories on the phone.

Input methods



When an editing screen is displayed, the current text input method is indicated in the upper right corner of the screen. Following are some of the input methods. To have more options to enter texts, go to **Settings** > **Input** to select the desired input methods.

	Multitap text input
	Numeric input
	T9 text input

Changing the input method

When an editing screen is displayed, repeatedly press   until your desired input method appears.





Shifting between upper and lower case letters

When an editing screen is displayed, long-press   to shift between lower and upper case letters.

Multitap text input

Entering text using multitap text input

- You must press the key corresponding to the desired letter the correct number of times in order to enter the letter you want. Display letters for entry according to the order shown on each key. Pressing a key once will display the first letter listed on the key, while pressing it twice will display the second letter, and so on.

- When you have entered a letter and wish to enter the next letter, either wait for two seconds until the cursor moves to the next text entry position, or immediately press the key for the next letter.
- Short press  to enter a space before beginning a new word. Long press  to feed a new line.
- While entering text, use the scroll key to move the cursor. Press  (Clear) once to delete a character; long-press  (Clear) to delete all entered text.

Options when using multitap text input







When entering text using multitap text input, you can access the following options by pressing  (Option).

- **Insert:** Allows you to insert texts, images, melodies, vCards, or vCalendars.
- **Alignment:** Allows you align text.
- **Symbols:** Opens the symbol table.
- **Input Methods:** To switch to another input method.
- **Cases:** To switch to lower or upper cases, or to use Caps Lock.

T9 text input

Entering text using T9 text input

- Press each key associated with the letter you want to enter only once. The letters you have entered appear on the display. The candidate words will change with each key you press.
- If the first highlighted word is not the word you want, scroll to highlight the desired word.

- If you do not find the word you want in the list of candidate words, that means the word you intend to enter is not a valid word in the dictionary. Press  (**Spell**) to open the spell check box, which allows you to create your own word into the dictionary. The next time you enter the word, it appears as one of the candidate word.
- Once the correct word is highlighted or is entered, press  to enter the word.
- Short press  to enter a space before beginning a new word. Long press  to feed a new line.
- While entering text, use scroll key to move the cursor. Press  (**Clear**) once to delete a character; long-press  (**Clear**) to delete all entered text.



Options when using T9 text input

When entering text using T9 text input, you can access the following options by pressing  (**Option**).



- **Insert:** Allows you to insert texts, images, melodies, vCards, or vCalendars.
- **Alignment:** Allows you align text.
- **Spell:** Opens the spell check box to allow you to create your own word into the dictionary.
- **Symbols:** Opens the symbol table.
- **Input Methods:** To switch to another input method.
- **Cases:** To switch to lower or upper cases, or to use Caps Lock.

- **T9 Settings:** Enable **Choice List** to show the list of candidate words when you enter letters. Enable **Auto Completion** to complete the predicted word (if it was entered before), and use the scroll key to display alternative words.

Numeric input

The numeric input method allows you to use the alphanumeric keys  to  to enter numbers.

Entering symbols



To open the symbol table, press . Press  again to open the next page. Scroll to highlight the desired symbol. Press  to place the symbol in the text.

Bluetooth and USB connection

Bluetooth





Your phone features Bluetooth technology which allows you to have a wireless connection between your phone and your Bluetooth devices.

Adding a Bluetooth device to your phone

1. If you go to **Tools > Bluetooth > Turn On** to turn on Bluetooth, you will be asked to search and to add Bluetooth devices. Press  (**Yes**) to begin searching.
2. Alternatively, you can go to **Tools > Bluetooth > Add Device**. The phone then begins searching.
3. When a list of available devices appear on the screen, select a device to connect to and press .

4. When a message appears asking for your permission to connect to this device, press  (Yes) to connect.
5. Enter the passkey for the device, both in the phone and in the device that you are connecting to.
6. When the passkey is accepted, the device is paired.

Establishing a connection with your Bluetooth headset

1. Go to **Tools > Bluetooth > Turn On** to turn on the Bluetooth.
2. You will be asked to search and to add Bluetooth devices, press  (Yes) to begin searching. Make sure that your Bluetooth headset is switched on and is in "pairable mode".
3. When a list of devices appear on the screen, select a device to connect to and press .
4. When a message pops up, press  (Yes) to connect.
5. Enter the Bluetooth headset passkey and press .

 Please check the user manual of your Bluetooth headset for this passkey.

6. When the passkey is accepted, the headset is paired. The Bluetooth connection is established automatically.

Sending an item using Bluetooth

You can send the items in your phone such as images, melodies, vCards (Phone Book records), or a vCalendars (Calendar events) to another Bluetooth device. When you select **By Bluetooth** as the **Send** method, a list of the once connected Bluetooth devices that can transfer data appears. Select an available device to connect to and press .

Managing your Bluetooth devices

Go to **Tools > Bluetooth > Devices**. Select a device from the list, and press  (**Option**) to access a list of options.

USB Connection

You can establish a USB connection to a computer using the USB data cable.

1. With the microSD card inserted, turn the phone on.
2. Connect the phone to the computer using the phone's data cable. Plug the cable's smaller end into the data cable jack on the bottom of the phone, and the bigger end into the computer's USB port.
3. The phone will display a USB Connection menu. Select the desired task from the following:

Mass Storage

To transfer files between the computer and the microSD card, select this option. With connection established and detected by your computer, the microSD card and the phone memory will function as a removable disk.

 On your computer, you can double-click on the **My Computer** icon to open the **My Computer** panel, where the icon of a removable disk is displayed, representing the storage capacity of the microSD card.

 When copying a file from your computer to the microSD card, you must place the file in the folder intended for the type of file. For example, an MP3 file must be placed in the **MP3** folder in order to be successfully used in the phone.

Modem/PC Sync

To synchronize the phone with your computer to transfer Phone Book data or Calendar memos, select this option. Besides, the phone can work as a modem to let you connect your computer to the Internet.

 Before activating the data synchronization or the modem function, make sure you have installed onto your computer the software tool designed for use with the phone.

MTP

MTP stands for Media Transfer Protocol, which standardizes the way computers with Windows installed transfer data to portable media devices.

To transfer files protected by Windows Microsoft Digital Rights Management (MS-DRM), you need to select **MTP** to activate Windows Media Player 10, which is used for transferring MS-DRM protected files from a computer to the phone.

 System requirements: (1) Windows XP, (2) Microsoft Service pack 2 and above, (3) Windows Media Player 10 (version 10.00.00.3990 is recommended).

1. After you select **MTP**, an MTP Media Player window pop ups on the computer. Select **Synchronize Media Files To This Device** to open up Windows Media Player.
2. The synchronization screen will display for you to copy files.

 On the right side of the synchronization screen, you can choose to copy files to **Flash** (phone memory) or to **SD Card** (microSD card).

Charger

Your phone can be charged through a USB connection with your computer. If this option is selected, the data transfer function will be disabled.

Menus

The phone features various functions and they are organized in the menus and sub-menus. The main menu consists of nine categories. Each category has related sub-menus.

For information about navigating menus, see page 14, "Menu navigation".



Phone Book

Find

Used to locate a contact in the Phone Book. Enter the first letter to view a list of contacts beginning with the letter. Scroll to the contact you want to find. See page 24, "Finding contacts in the Phone Book" for details about what to do after locating a contact.

Add

Used to add a new contact to the Phone Book. See page 21, "Adding contacts to the Phone Book" for details.

Edit

Used to edit a selected contact.

Copy

Used to copy contacts stored in the phone to SIM card, or copy contacts stored in the SIM card to phone. You can also select to copy individual contact.

Delete



Deletes a contact from the Phone Book. You can delete one contact at a time, or delete all contacts at once.

Caller Group

Caller groups are combinations of phone settings used to identify a particular group of contacts. Press  (**Option**) to select the ring or image that a particular caller group belongs, or to rename the caller group.



Privacy Manager

This option allows you create a list of calls that you wish to accept (**Accept List**) or a list of calls that you wish to reject (**Reject List**). Set this function to Off if necessary.

1. Scroll to highlight **Accept List** or **Reject List**, press  (**View**).
2. If the list is empty, press  (**Option**) and select **Add** to add contacts to the list.

Business Card

You can use this option to enter your own business card information.

1. Scroll to the data field you wish to edit, and then press  to enter text.
Press  to return to the previous screen when you finish editing.
2. Press  (**Option**) and select **Save** to save all the entered data, or select **Send vCard** to send this business card in a short message.

My Number

This option allows you to store your phone number and name.

Memory Status

Shows you the number of entries that have been stored and the maximum entries that can be stored, on the SIM and on the phone.



Messages

For the description of features available in the messages menu, see page 39, "Messages".



Calls

This menu includes a list of your missed calls, dialed calls, and received calls. Call costs and time are also recorded.

Missed

Shows your most recent missed calls.

See page 25, "Last missed, dialed, and received calls" for details.

Received

Shows your most recent received calls.

See page 25, "Last missed, dialed, and received calls" for details.

Dialed

Shows your most recent dialed calls.

See page 25, "Last missed, dialed, and received calls" for details.

Cleanup All

Deletes all of the call records.

Duration

 This feature is only accessible if supported by your network operator.

Last

Shows the duration of the last call.

All

Shows the total time for all calls.

Received

Shows the total time for all received calls.

Dialed

Shows the total time for all dialed calls.

Reset

Resets all call time records.

Cost

 The cost calculation requires the support of the network operator. In addition, the estimated value shown is for your reference only. The real cost of calling may vary depending on the service provider the call is made through.

Last

Shows the cost of your last call.

All

Shows the total cost of all calls.

Reset

Resets all call cost records.

 Requires entry of the PIN2 code.

Limit

Shows the current limit set for total call costs.

Settings

Allows you to set the unit price and a currency for calculating call costs.

 Requires entry of the PIN2 code.



Games

You can play the games embedded in the phone, or download Java applications directly through WAP to your phone.

All Games

Embedded games and downloaded Java games are stored in this menu. To find out how to play these games, please read their on-screen instructions.

Settings

Internet Setting

If the Java application activated requires the Internet connection, you need to select the appropriate network access point here. To configure network access point settings, go to **Services > NAP settings**. See page 72, "NAP Settings".

Java Version

Shows the phone's Java virtual machine version.

Memory Status

Shows the amount of used and available memories on the phone and on the microSD card for Java applications.



Entertainment

Camera

For information on using the camera, see page 26, "Camera".

MP3 Player

For information on using the MP3 player, see page 34, "MP3 player".

FM Radio

To listen to the FM radio, you must first connect the FM radio stereo headset to the phone. The headset acts as an antenna for the radio.

 The FM radio stereo headset is sold separately depending on regions. For accessories that are compatible with your phone, please contact your local BenQ Mobile office to inquire about availabilities and detailed information.

1. Go to **Entertainment** and select **FM Radio**.
2. Press  to turn on the radio.
3. Press the up navigation key to select a channel previously saved in the **Channels** list.
4. Press the left and right navigation keys to scan channels in sequential order.

5. Press and hold the left and right navigation keys to rapidly scan for channels with signals.

6. To adjust volume press the volume key .

7. Press  (**Option**) to access a list of options.

- **Save Channel:** Allows you to save the current channel in the Channels list.
- **Set Frequency:** Enter the frequency of a channel to access it directly.

Recorder

1. Press  (**Option**) and select **Save to** to decide whether recordings are to be saved on the microSD or in the phone memory.

2. Press  to record.

3. Press  to stop recording.

4. Press  to open up the Recordings list and select the recording to play.

5. Press  to start the playback.

6. Press  to stop playback.

7. To adjust volume press the volume key .

 To delete recordings, go to **Media Center > Music > Recordings**.



Media Center





Digital Rights Management

This phone features the Digital Rights Management (DRM) technology. DRM allows for copyright-protected audio/visual content transmissions for playback in computers, portable devices and network devices, while protecting them from unauthorized use.

Note that the phone supports playing OMA DRM v1.0 and MS DRM 10 only.

Images



Images stores photos you have taken or images saved in the phone or on the microSD card.

1. Select the desired location and scroll to the desired image.
2. Press  to display the selected image. Scroll up or down to display the next or previous image.
3. Press  (**Option**) to perform the following tasks with the image:
 - **Send:** Allows you to send this image by MMS or by Bluetooth.
 - **Delete:** Deletes the image.
 - **Set:** Allows you to set the photo as the wallpaper or an image caller ID.
 - **Move:** Allows you to move the image from phone to microSD, or from microSD to phone.
 - **Copy:** Allows you to copy the image from phone to microSD, or from microSD to phone.
 - **Slideshow:** Allows you to view the images you have taken in a slideshow format.

- **Browsing Mode:** Allows you to view the photos you have taken in a list or in thumbnails.
- **New Folder:** Allows you to create new folders to store photos.
- **Rename:** Allows you to rename the image.
- **Protect:** Allows you to protect the image from deletion.
- **Unprotect:** Frees the protected image.
- **Delete All:** Deletes all the photos in the selected folder.
- **Details:** Shows details of the image.

Music

Music stores audio files including MP3s, default ring tones, and recordings.

1. Select the desired folder and scroll to the desired audio file.
2. Press  to play the selected file.
3. Press  (**Option**) to perform the following:
 - **Send:** Allows you to send the picture by SMS, MMS or Bluetooth
 - **Delete:** Deletes the selected MP3 file.
 - **Set:** Allows you to set the MP3 for incoming calls or as a ring ID for a specified contact or a caller group, or as alarm tone.
 - **Move:** Allows you to move the file from phone to microSD, or from microSD to phone.
 - **Copy:** Allows you to copy the file from phone to microSD, or from microSD to phone.
 - **New Folder:** Allows you to create a new folder.
 - **Protect:** Allows you to protect the file from deletion.
 - **Unprotect:** Frees the protected file.

- **Rename:** Allows you to rename the file.
- **Delete All:** Deletes all files.
- **Details:** Shows details of the file.

Other

Other stores files whose formats are not supported by the phone.

Format microSD

This option will delete all the files stored on the microSD card. Phone code is required to execute this option.

Memory Status

Shows the amount of used and available memories on the phone and on the microSD card.



Tools

Alarm

To set an alarm, follow the steps below:

1. Select an alarm.
2. Press  to turn the status on and display the options.
3. Scroll to an option and change the setting as needed.

Frequency

Allows you to select the days you want the alarm to sound.

Time





Allows you enter the time for the alarm to sound.

Time Duration

Allows you to set the length of the alarm.

Alarm Tone

Allows you to set the ring tone of the alarm.





4. To save all your current alarm settings, press  (**Save**).
 5. When setting is saved,  will appear in the display's status bar.
-  Press  (**Snooze**) to stop the alarm. The alarm will ring again five minutes later. Press  to turn off the alarm. The alarm will not ring until the next scheduled time.

World Clocks

This feature displays current local time and date for major cities around the world.

-  To make use of the World Clocks feature you must set your phone's time and date correctly. To do this, go to **Settings > Date & Time**.

To decide which cities' time and date you want to display:

1. Press  (**Edit**) to bring up a list of cities.
2. Press  to mark the cities. To unselect a city, scroll to that city and press .
3. With desired cities selected, press  (**Done**).





Bluetooth

For information on using Bluetooth, see page 51, "Bluetooth".

Calendar

Calendar allows you keep track of upcoming events. You may set the alarm to ring when it comes to the date.





Creating a new memo

1. When you open the Calendar, the phone will show the calendar for the current date. Scroll to the date you want to write a memo on. You can also press  (**Option**) and select the **Go to Date**.
2. When the desired date is highlighted, press  (**Option**) and select **Add** to open the memo editor.
3. Edit the data fields in the memo editor as needed. Press  (**Save**) to save the memo.
4. To send a memo by SMS or by Bluetooth, select the preferred memo, then press  (**Option**) to select **Send vCal**.
5. To auto delete the memos, press  (**Option**) and select the **Delete After**. Select the timeframe you want the deletion to be auto executed.

To Do List

To do list allows you to keep track of a list of tasks.

Creating a new to do item

1. To add a new to do item, press  (**Option**) and select **Add**.
2. Write your memo. Press  to save the memo.
3. To edit a select to do item, press  (**Option**) and select **Edit**.
4. To auto delete the memos, press  (**Option**) and select **Auto Delete**.

Note











Note allows you to write down quick notes. You can set a password protection for the notes.

Shortcuts

For information on Shortcuts, see page 38, "Shortcuts".



Calculator

Allows you to use the phone as a calculator.

1. Enter numbers using alphanumeric keys.
2. Use the navigation keys to perform calculations. Press  to perform + (add); press  to perform - (subtract); press  to perform / (divide); press  to perform x (multiply); press  to get the result (equal).
3. Press  (C) to delete numbers and symbols entered. Press  or  or  to enter a decimal point. Press  (Back) to leave the calculator screen.

Currency Converter





Currency converter allows you to convert currencies and set the exchange rate.

1. To set the currencies for conversion, press  (Option) and select either **Currency 1** (to set the currency at the top of the screen) or **Currency 2** (to set the currency at the bottom of the screen).
2. To set the exchange rate, press  (Option) and select **Rate Setting**.

3. Enter the amount of currency, the result will appear in the other currency field.



Stopwatch

Stopwatch allows you to measure times.

1. Press  to start the stopwatch.
2. While the stopwatch is running, you can press  (**Split**) to save each elapsed time.
3. Press  to halt the stopwatch.
4. Scroll to view the list of elapsed times.
5. To reset the stopwatch, press  (**Reset**).

Countdown Timer

Countdown timer allows you to specify length of time to count down.

1. Enter the length of time you want to count down.
2. Press  and the timer starts counting down to zero.
3. Press  to halt the Countdown Timer.
4. To reset the Countdown Timer, press  (**Reset**).

USB Connection

For information on using USB connection, see page 53, "USB Connection".



Services

Your phone features a WAP browser, allowing you to use the phone for mobile Internet connectivity. You can browse the online services offered by the network operator or ISP, such as information on financial news, sports, travel, and entertainment. To use the phone to get online, necessary WAP and GPRS settings must be made.

 To activate the mobile Internet connectivity, consult your network operator for WAP and GPRS services. In general, the network operator will automatically transmit the needed settings to your phone. If not, you will need to manually configure necessary settings. For further details, contact your network operator.

ClubBenQ Online

Used to start up the WAP browser and connect to the official BenQ Website.

WAP Service

Start Browser

Starts up the browser and connects to the homepage.

Browsing a webpage

Referring to the soft key commands appear on the screen, press



to perform needed tasks while browsing a webpage. Scroll left or right to switch to different function menus; scroll up or down until the item you want was highlighted, and then press



to select it.

Ending the online session

While online, press  to close the browser and return to the previous menu.

WAP Messages

When you receive a new WAP message,  will be shown on the display. This option will start up the browser so you can read the WAP message.

Go to URL

Allows you to link to the URL you enter.

WAP Settings

Allows you to configure settings for different network operators' WAP servers, and then select the desired server to get online.



1. Scroll to the desired server and press  (**Option**).
2. Select **Add Profile** to establish settings for a new server, or select **Edit** to manually configure the server's settings as follows:
 - **Profile Name**
Gives the WAP server a name.
 - **Homepage**
Sets the homepage that the browser will link to when it is started up.
 - **IP Address**
Enter the IP address used for accessing the mobile Internet.
 - **Port**
Enter the connection port specified by the network operator.

- **NAP**

If you are using a GPRS network, choose to configure **GPRS NAP** settings or **CSD NAP** settings and select either type of settings to get online.

If you are using a dialup network, you are restricted to configuring only the **CSD NAP** settings to connect to the Internet.

 For detailed information on how to properly configure GPRS and CSD settings, contact your network operator.

3. Press  (**Save**) to save the settings.
4. Scroll to the server that you would like to use and press  (**OK**) to confirm your choice.

Clear Cache

Clears webpage content that the browser temporarily stores in memory.

NAP Settings

Used to configure GPRS or CSD settings according to the network type used by the phone.

Service Number

Provided by your network operator if the service is supported. For further details, please contact your network operator.

STK Menu

Shown only if it is provided by your SIM card. For further details, please contact your network operator.



Settings

Date & Time

Used to set the time and date, as well as the format that will be displayed on the screen.

Date

Allows you to set today's date.

Time

Allows you to set the current time.

Format

Allows you set the format in which the date and the time will be displayed.

Time Zone

Allows you to select a time zone where you are at.

Auto Time Zone

When turning this feature on, the time displayed on the phone will auto switch to the local time where you are at.

Auto Power On/Off

Allows you specify a time for the phone to be automatically turned on or off.



When on an airplane, be sure that you deactivate the Auto Power On/Off feature.

1. Select **Power On** or **Power Off**.

2. Scroll to turn the status on or off.
3. If status is set to **On**, specify a time.

Profiles

A profile is a group of settings that determine whether the phone will alert you to incoming calls through a ring tone or a vibrating alert, and how ring tones in general are used on the phone. These settings allow the phone's operations to best suit the environment you are in.

1. Scroll to the desired profile and then press  to activate this profile. You can choose from among the following profiles:

Normal

This is the default profile.

Meeting

The options in this profile have been preset to suit a meeting environment.

Outdoors

The options in this profile have been preset to suit an outdoor activity.

Silent

The options in this profile have been preset to suit an environment where silence is required.

Personal

Allows you to use this profile for a group of custom settings.

2. To customize settings, scroll to a profile, and then press  (**Edit**).

 You can not modify settings in Silent mode.

Vibrate

Decides whether the phone will vibrate when there is an incoming call.

Call Ring

Allows you to set the ring tone that will sound when there is an incoming call.

Message Tone

Allows you to set the ring tone that will sound when there is a new message.

Calendar Tone

Allows you to set the ring tone that will sound when your calendar event approaches.

Keypad Tone

Decides whether keypad will sound when keys are pressed.

Ring Volume

Allows you to adjust the ring volume.

Restore

Allows you to reset the profile to its default configuration.

Display**Theme**

You can change the appearance of the display. Select different themes to change the display color and background.

Wallpaper

Designates the wallpaper used for the idle screen.

Welcome Message

Allows you create a welcome message to be displayed when the phone is turned on.

Personal Banner



Allows you to enter text to be displayed on the idle screen.

Brightness

Allows you to adjust the brightness of the display to be appeared lighter or darker.

Backlight Duration

Allows you to specify how long the backlight remains on after last key is pressed.

 Alternatively, you can press  to turn the display on or off.

Audio

Call Ring

Allows you to set the ring that will sound when there is an incoming call.

Message Tone

Allows you to set the ring that will sound when there is a new message.

Calendar Tone

Allows you to set the ring that will sound when your calendar event approaches.

Keypad Tone

Decides whether keypad will sound when keys are pressed.

Ring Volume



Allows you to adjust the ring volume. Scroll up or down to adjust it.

Speech Volume

Allows you to adjust the speech volume. Scroll up or down to adjust it.

Key Assignment

Allows you to assign functions to the four navigation keys. When functions have been assigned, you can access the functions by pressing up/down/left/right in idle mode.

1. Scroll to a key and press .
2. Select one function from the list and press .
3. When you are ready to save the assignments, press  (Save).

Call Settings

Answer Mode

Flip Answer

Allows incoming calls to be answered by flipping open the phone.

Send Key

Allows incoming calls to be answered only by pressing .

Any Key

Allows any key except  to be used to answer an incoming call.

Automatic

(Available only when a handsfree is connected with the phone)
If the Automatic answer mode is activated, the phone will ring for 5 seconds, and then the incoming call will be automatically answered.

 For accessories that are compatible with your phone, please contact your local BenQ Mobile office to inquire about availabilities and detailed information.

Connect Alert

This feature allows the phone to ring, vibrate, or flash the backlighting when the recipient of a call has answered.

Minute Minder

If set the status On, the phone will beep per minute during a call.

Show Number

Decides whether your phone number will be displayed on the recipient's phone when you make a call. Select **Preset** to be determined by the default set by the network operator.

Call Divert

This feature allows you to divert calls to a designated phone number or voicemail box.

 Requires the support of the network operator.

Forward All

Diverts all incoming calls.

When Busy

Diverts incoming calls when you are in the middle of another call.

No Reply

Diverts incoming calls when you do not answer.

Not Reachable

Diverts incoming calls when your phone is turned off or outside network coverage.

Cancel All

Cancels all call divert options.

Call Barring

You can request that your network operator block the dialing or receiving of certain calls. To activate or cancel any of the options below, you must enter the network password provided by the network operator.

 Requires the support of the network operator.

All Outgoing

Blocks dialing of any calls from the phone.

Intl. Out

If this option is activated, no international calls can be made with your phone.

Intl. Except Home

If this option is activated, your phone can only be used to dial local calls and calls to your home country from abroad. Other international calls will be barred.

All Incoming

Rejects all incoming calls.

Incoming When Roaming

If you are in another country (using roaming), activating this option will cause the phone to reject all incoming calls.

Cancel All

Cancels all call barring settings. You must enter the network password in order to cancel these settings.

Change Password

You can change the network password, which can be obtained from the network operator.

Call Waiting

If there is an incoming call when you are in the middle of another call, the screen will display the number/name of the incoming call and call waiting message to alert you. You can activate, cancel, or view the status of this feature from this menu.

 Requires the support of the network operator.

Auto Redial

If there is no answer at a number you have dialed, the phone will automatically redial.

Fixed Dialing No.



After this feature is activated, the phone will only be able to dial numbers on the Fixed Dial Number list. If a number is not on the list, calls cannot be made to this number.

 To activate or cancel this feature, you must enter the PIN2 code.



If the PIN2 code is entered incorrectly three consecutive times, the PIN2 code will be locked down. You will need the PUK2 code to unlock the PIN2 code. Contact your network operator to obtain the PUK2 code.

To create a Fixed Dialing Number list,

1. Press  (**View**), then press  (**Option**) and select **Add**.
2. Enter the PIN2 code, and then add a new number to your Fixed Dial Number list.

Active Line

This feature allows you to use two different phone numbers on one phone. You can designate one number for dialing calls, while accepting incoming calls dialed to both numbers.

 Requires the support of the network operator.

User Group

User Group

Used to create a closed group of callers based on a service provided by the network operator. The members of a User Group can call each other, but cannot conduct calls with anyone outside the group unless special provisions are made.

Outside Access

When the User Group service is activated, enabling Outside Access will allow users in the group to make calls to numbers outside the group. However, incoming calls will still be restricted to calls within the group.

Network

Generally speaking, the network that your phone uses is configured automatically. When turned on, the phone will automatically connect to the network provided by your network operator, or will automatically connect to the roaming network when you are outside the coverage of your regular network. When outside the coverage of your regular network, you can manually select the local network system.

 Your network operator must be able to support network selection in order for you to use this feature.

Network Mode

Allows you to set the network searching automatic or manual.

Automatic

If this option is selected, when outside the coverage of your regular network, the phone will automatically scan for the available network.

Manual

If this option is selected, when outside the coverage of your regular network, the phone will list all the networks of telecom vendors and allow you to choose.

Available List

Allows you to manually select a network from the list.

Band Setting

Allows you to set an appropriate band in the GSM network system.

Connection

Allows you to set whether the phone will search for a GPRS network when it is turned on.

GPRS & GSM

When it is turned on, the phone will search for available GPRS and GSM networks.

GSM Only

When it is turned on, the phone will search only for a GSM network.

Security

You can use various codes and locks to prevent unauthorized use of the phone.

PIN Code

The PIN (Personal Identification Number) is the password provided by your network operator. You need this password in order to use the SIM card.



If you enter the PIN incorrectly three times in a row, the SIM card will be locked. You must now enter the PUK (Personal Unlocking Key) for that SIM card in order to unlock it. Please contact your network operator to obtain a PUK.

PIN1 Code

Used to activate, deactivate or change the PIN1 Code. To change the PIN1 Code, select **Set Status** and set to **On**. Enter PIN1.

PIN2 Code

Used to change the PIN2 code. The procedure is the same as for the PIN1 Code.

Phone Lock

Once the phone lock is activated, you will be required to enter the phone code when the phone is turned on. You must enter the correct code to unlock it (the default phone code is 1234). When the phone is locked, you will only be able to make emergency calls.

SIM Lock

When activating the SIM Lock, you must enter the previously set SIM Lock password (the default SIM Lock password is 1234). The password must be between 4 and 8 digits. Once the SIM Lock is activated, you will be required to enter the SIM Lock code to use another SIM card on your phone.

Power Saving Mode

Activating this mode will turn off the keypad backlighting and the brightness of the display backlighting will be reduced to conserve battery power.

Language

Allows you to select the language that the phone will use.

Input

Allows you to set the default input methods that will be used in the text input mode.

Flight Mode

When you are on a flight, select this option so that the phone will not link to any network, and the Bluetooth, and the FM radio will also be turned off. However, you can still use the entertainment features such as playing MP3 music or taking photos in this mode.

Restore

Restores all the settings to their factory default.



Requires entry of the phone code, which is 1234 by the default.

5 Care and maintenance

Take note of the points noted below to ensure that you are using the phone properly and to extend the lifespan of the phone.

- Store the phone and its accessories out of the reach of children.
- Keep the phone and accessories dry, and use the phone in environments where the temperature is between -10°C and 45°C. High or low temperatures outside this range may damage the phone.
- If possible, do not use or store the phone in excessively dusty or dirty environments.
- Do not remove the warranty seal on the phone yourself, nor allow an unauthorized dealer to do so.
- Do not use strong detergents or organic solvents to wipe or clean the phone.
- If your phone or its accessories are not operating normally, contact an authorized dealer immediately.
- Use only genuine accessories such as batteries, battery charger and hands-free kit to ensure the phone's normal operation and preserve battery life, as well as protect the safety of your person and belongings. Use of non-genuine accessories will not allow your phone to achieve optimal performance, and may cause the phone to malfunction. Any malfunctions or damage caused by the use of third-party accessories are not covered by the terms of the product warranty, and will void the product warranty.
- Avoid allowing objects that may discharge electricity to contact the charging socket on the bottom of the phone or the metal contacts on the battery, as this may cause short circuits and put you in danger.

Troubleshooting

If you encounter problems while using the phone, or if it performs erratically, you can consult the information in the chart below. If your particular problem cannot be resolved using the information in the chart, contact the dealer where you purchased the phone.

Problem	Possible cause	Solution
Poor reception	<ul style="list-style-type: none">• The network signal is too weak at your current location—for example, in a basement or near a tall building—because wireless transmissions can not effectively reach it.	Move to a location where the network signal can be properly received.
	<ul style="list-style-type: none">• The network is busy at the current time (for example, during peak times, there may be too much network traffic to handle additional calls).	Avoid using the phone at such times, or try again after waiting a short time.
	<ul style="list-style-type: none">• You are too far away from a base station for your network operator.	You can request a service area map from your network operator.
Echo or noise	<ul style="list-style-type: none">• Poor network trunk quality on the part of your network operator.	Hang up the phone and dial again. You may be switched to a better-quality network trunk or phone line.
	<ul style="list-style-type: none">• Poor local telephone line quality.	

Problem	Possible cause	Solution
Shortened standby time	<ul style="list-style-type: none"> The standby time is related to your network operator's system configuration. The same phone used with different network operators' systems will not provide exactly the same length of standby time. 	If you are located in an area where signaling is weak, temporarily shut off the phone.
	<ul style="list-style-type: none"> The battery is depleted. In high-temperature environments, battery life will be shortened. 	Use a new battery.
	<ul style="list-style-type: none"> If you are not able to connect to the network, the phone will continue to send out signals as it attempts to locate a base station. Doing so consumes battery power and will consequently shorten standby time. 	Change your location to one where the network is accessible, or temporarily turn off your phone.
You cannot switch your phone on.	<ul style="list-style-type: none"> Battery power has been depleted. 	Recharge the phone's battery.
SIM card error	<ul style="list-style-type: none"> SIM card malfunction or damage. 	Take the SIM card to your network operator for testing.
	<ul style="list-style-type: none"> SIM card inserted improperly. 	Insert the SIM card properly.
	<ul style="list-style-type: none"> Debris on the SIM card contacts. 	Use a soft, dry cloth to clean the SIM card contacts.

Problem	Possible cause	Solution
Unable to connect to the network.	• SIM card invalid.	Contact your network operator.
	• You are not within the network's service area.	Check the service area with your network operator.
	• Poor signal.	Move to an open space, or if you are inside a building, move closer to a window.
You cannot answer incoming calls.	• You have activated Accept List or Reject List in the Privacy Manager option.	Go to Phone Book > Privacy Manager and select Off in order to deactivate this option.
	• You have activated the Call Barring feature.	Go to Settings > Call Settings > Call Barring , and then select Cancel All .
You cannot make outgoing calls.	• You have activated the Call Barring feature.	Go to Settings > Call Settings > Call Barring , and then select Cancel All .
	• You have activated the Fixed Dialing Number feature.	Go to Settings > Call Settings > Fixed Dialing No. and select Off to turn this feature off.
PIN Code is blocked.	• You have entered an incorrect PIN code three consecutive times.	Contact your network operator. If the network operator provides the SIM card's PUK code, use the PUK code to unlock the SIM card.
Battery will not charge.	• The battery or battery charger is damaged.	Contact the dealer.
	• The phone's temperature is below 0°C or higher than 45°C.	Adjust the battery charging environment to avoid extremes of temperature.
	• Poor contact between the battery and charger.	Check all connectors to make sure all connections have been properly made.

Problem	Possible cause	Solution
Unable to enter information into the Phone Book.	<ul style="list-style-type: none"> The Phone Book's memory is already full. 	Delete unnecessary data from the Phone Book.
Unable to select certain features.	<ul style="list-style-type: none"> Your network operator does not support these features, or you have not applied for services that provide these features. 	Contact your network operator.
Unable to play tracks in MP3 Player .	<ul style="list-style-type: none"> If a music file has been renamed or removed in Media Center, the MP3 Player can not locate the file and thus can not play it. You have to update the playlist in MP3 Player. 	Remove the old MP3 file from the playlist, and add the track with the updated filename to the playlist again.
Unable to be searched by other Bluetooth devices	<ul style="list-style-type: none"> Your phone is set to be undiscoverable. In this case, you phone can pair with other Bluetooth but can't be found by them. 	Go to Tools > Bluetooth > Settings > Discoverable and set your phone to be discoverable by other devices.