



# FCC TEST REPORT

for

**47 CFR Part 22H, 24E**

**Equipment** : GSM850/DCS1800/PCS1900 Tri Band Mobile Phone  
**Trade Name** : BenQ-Siemens  
**Model No.** : E61  
**Marketing Name** : HERB2A  
**FCC ID** : JVPE61A  
**BenQ Ref. No.** : KH-6719  
**Tx Frequency Range** : GSM850 : 824.2~848.8MHz  
: PCS1900 : 1850.2~1909.8MHz  
**Max. ERP/EIRP Power** : GSM850 : 0.55W  
: PCS1900 : 0.40W  
**Emission Designator** : 300 KGXW  
**Applicant** : BenQ Corporation  
157 Shan-Ying Road, Gueishan Taoyuan 333, Taiwan

- The test result refers exclusively to the test presented test model / sample.
- Without written approval of SPORTON International Inc., the test report shall not be reproduced except in full.
- **Certificate or Test Report must not be used by the applicant to claim the product in this test report endorsement by NVLAP or any agency of U.S. government.**
- The data shown in this test report were carried out on Apr. 15, 2006 at **Sporton International Inc. LAB.**
- Report No.: FG641107, Report Version: Rev. 01.

Dr. Daniel Lee  
EMC/SAR Director

**SPORTON International Inc.**

6F, No.106, Sec. 1, Hsin Tai Wu Rd., Hsi Chih, Taipei Hsien, Taiwan, R.O.C.



# Table of Contents

**History of this test report.....ii**

**1. General Information ..... 1**

    1.1. Applicant .....1

    1.2. Manufacturer .....1

    1.3. Basic Description of Equipment under Test.....1

    1.4. Feature of Equipment under Test .....2

    1.5. Report Date.....2

**2 Test Configuration of Equipment under Test .....3**

    2.1 Test Manner .....3

    2.2 Test Mode .....3

    2.3 Connection Diagram of Test System .....3

    2.4 Ancillary Equipment List.....3

**3. General Information of Test Site .....4**

    3.1 Test Voltage .....4

    3.2 Test in Compliance with .....4

    3.3 Frequency Range Investigated .....4

    3.4 Test Distance .....4

**4. Test Data and Test Result.....5**

    4.1 List of Measurements and Examinations .....5

    4.2 RF Output Power .....6

    4.3 ERP / EIRP Measurement .....7

    4.4 Occupied Bandwidth and Band Edge Measurement .....10

    4.5 Conducted Emission .....19

    4.6 Field Strength of Spurious Radiation .....29

    4.7 Frequency Stability (Temperature Variation) .....47

    4.8 Frequency Stability (Voltage Variation).....49

**5 List of Measurement Equipments .....50**

**6 Uncertainty Evaluation.....51**

**Appendix A. Photographs of EUT External**

**Appendix B. Photographs of EUT Internal**

**Appendix C. Photographs of Setup**



### History of this test report

Report Issue Date: Apr. 25, 2006

Report No.	Description



## **1. General Information**

### **1.1. Applicant**

**BenQ Corporation**

157 Shan-Ying Road, Gueishan Taoyuan 333, Taiwan

### **1.2 Manufacturer**

**1. BenQ Corporation**

157 Shan-Ying Road, Gueishan Taoyuan 333, Taiwan

**2. BenQ (IT) Co., Ltd.**

No. 169, Zhujiang Road, New District, Suzhou, Jiangsu, P.R., China

**3. BenQ Mexicana S.A. de C.V.**

Calzada Venustiano Carranza No. 88 Col. Plutarco Elias Calles, Mexicali, B.C. Mexico, CP 21376

### **1.3 Basic Description of Equipment under Test**

Equipment : GSM850/DCS1800/PCS1900 Tri Band Mobile Phone  
Trade Name : BenQ-Siemens  
Model No. : E61  
Marketing Name : HERB2A  
FCC ID : JVPE61A  
Power Supply Type : Switching  
AC Power Cord : AC120V, Weave-shielded, Wall-mount, 1.7 meter, 2 pin  
Battery : BenQ-Siemens, 2C.2G0K0.XXX (X=0-9 or A-Z or Black)  
Adapter : BenQ-Siemens, JSP054070UU  
Earphone : 2C.43037.111  
Data Cable : 5K.G6501.001

**1.4 Feature of Equipment under Test**

<b>DUT Type :</b>	GSM850/DCS1800/PCS1900 Tri Band Mobile Phone
<b>Trade Name :</b>	BenQ-Siemens
<b>Model Name :</b>	E61
<b>Marketing Name :</b>	HERB2A
<b>FCC ID :</b>	JVPE61A
<b>Tx Frequency :</b>	GSM850 : 824 ~ 849 MHz PCS1900 : 1850 ~1910 MHz
<b>Rx Frequency :</b>	GSM850 : 869 ~ 894 MHz PCS1900 : 1930 ~ 1990 MHz
<b>Antenna Type :</b>	Fixed Internal
<b>IMEI Code :</b>	351910010000011
<b>Maximum Output Power to Antenna :</b>	GSM850 : 32.04 dBm PCS1900 : 30.34 dBm
<b>Maximum ERP/EIRP :</b>	GSM850 : 0.55 W ( 27.38 dBm) PCS1900 : 0.40 W (25.98 dBm)
<b>HW Version :</b>	LPR3
<b>SW Version :</b>	V0.02
<b>Power Rating (DC/AC , Voltage and Current of RF element or PA) :</b>	4.2V / 1.2A
<b>Digital Modulation Emission :</b>	GMSK
<b>Type of Emission :</b>	300 KGXW
<b>DUT Stage :</b>	Identical Prototype

**1.5 Report Date**

EUT Received : Jan. 16, 2006

Report Date : Apr. 25, 2006

## 2 Test Configuration of Equipment under Test

### 2.1 Test Manner

- a. The spurious emission measurements were carried out in semi-anechoic chamber with 3-meter test range.
- b. During all testings, EUT is in link mode with base station emulator at maximum power level. (PCL=5 for GSM 850 or PCL=0 for PCS 1900)
- c. Frequency range investigated: radiated emission 30 MHz to 9000 MHz for GSM850; 30MHz to 19000 MHz for PCS 1900.

### 2.2 Test Mode

Application	GSM 850	PCS 1900
Radiated Emission	<input checked="" type="checkbox"/> Mode 1: GSM 850 Link Mode_CH 189	<input checked="" type="checkbox"/> Mode 2: PCS 1900 Link Mode_CH 661
Conducted Measurement	<input checked="" type="checkbox"/> Mode 1: GSM 850 Link Mode_CH 189	<input checked="" type="checkbox"/> Mode 2: PCS 1900 Link Mode_CH 661

### 2.3 Connection Diagram of Test System

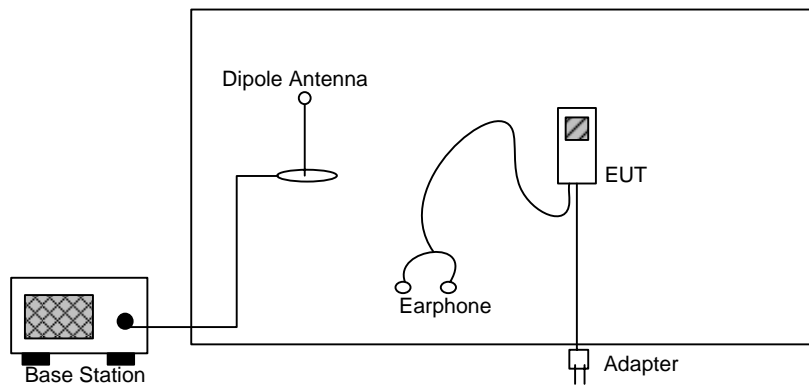

### 2.4 Ancillary Equipment List

Item	Equipment	Model No.	Serial No.
1.	Base Station(R&S)	CMU200	106656



### **3. General Information of Test Site**

Test Site Location : No. 52, Hwa Ya 1st Rd., Hwa Ya Technology Park,  
Kwei-Shan Hsiang, Tao Yuan Hsien, Taiwan, R.O.C.  
TEL : 886-3-327-3456  
FAX : 886-3-318-0055

Test Site No : 03CH06-HY

The chamber meets the characteristics of ANSI C63.4-2003. This site is on file with the FCC. The Industry Canada file number for this site is IC 4088.

#### **3.1 Test Voltage**

120V/ 60Hz

#### **3.2 Test in Compliance with**

47 CFR Part 22H, 24E and Part 2.

#### **3.3 Frequency Range Investigated**

- a. Radiation: from 30MHz to 9000MHz for GSM 850.
- b. Radiation: from 30 MHz to 19000 MHz for PCS 1900.

#### **3.4 Test Distance**

The test distance of radiated emission from antenna to EUT is 3 m.



## 4. Test Data and Test Result

### 4.1 List of Measurements and Examinations

FCC Rule	DESCRIPTION OF TEST	Result	Section
§2.1046	RF Output Power	Passed	4.2
§ 22.913 §24.232	ERP / EIRP	Passed	4.3
§2.1049, § 22.917, § 24.238(b)	Occupied Bandwidth & Band Edge Measurement	Passed	4.4
§2.1051	Conducted Emission	Passed	4.5
§2.1053	Field Strength of Spurious Radiation	Passed	4.6
§2.1055, § 22.355, §24.235	Frequency Stability vs. Temperature	Passed	4.7
§2.1055, §22.355, §24.235	Frequency Stability vs. Voltage	Passed	4.8



## 4.2 RF Output Power

### 4.2.1 Measurement Instruments :

As described in chapter 5 of this test report.

### 4.2.2 Test Procedure :

1. The transmitter output was connected to power meter and base station through power divider.
2. Set EUT at PCL=5 for GSM 850 and/or PCL=0 for PCS 1900 through base station.
3. Select lowest, middle, and highest channels for each band.

### 4.2.3 Test Setup Layout :

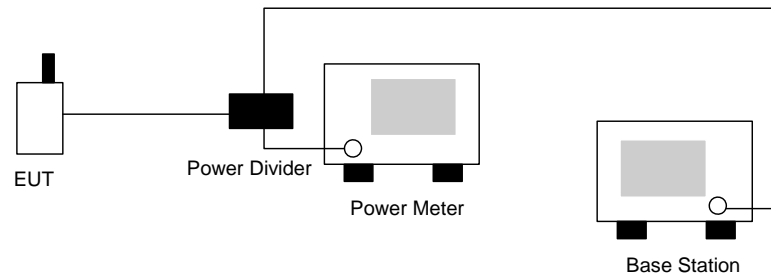

### 4.2.4 Test Result :

Bands	Channel	Frequency (MHz)	Conducted Power (dBm)	Conducted Power (Watts)
GSM 850	128	824.2 (Low)	32.04	1.600
	189	836.4 (Mid)	32.03	1.596
	251	848.8 (High)	31.97	1.574

Bands	Channel	Frequency (MHz)	Conducted Power (dBm)	Conducted Power (Watts)
PCS 1900	512	1850.2 (Low)	30.29	1.069
	661	1880.0 (Mid)	30.34	1.081
	810	1909.8 (High)	30.29	1.069



### 4.3 ERP / EIRP Measurement

Equivalent isotropic radiated power measurements by substitution method according to ANSI/TIA/EIA-603-A.

#### 4.3.1 Measurement Instruments

As described in chapter 5 of this test report.

#### 4.3.2 Test Procedure

1. The EUT was placed on a rotatable table with 1.0 meter height in an fully anechoic chamber.
2. The EUT was set 1.2 meters from the receiving antenna which was mounted on the antenna tower.
3. The table was rotated 360 degrees to determine the position of the highest radiated power.
4. The height of the receiving antenna is also kept at 1.0M height.
5. Taking the record of maximum ERP/EIRP.
6. A dipole antenna was substituted in place of the EUT and was driven by a signal generator.
7. The conducted power at the terminal of the dipole antenna is measured.
8. Repeat step 3 to step 5 to get the maximum ERP/EIRP of the substitution antenna.
9.  $ERP/EIRP = P_s + E_t - E_s + G_s = P_s + R_t - R_s + G_s$

$P_s$  (dBm) : Input power to substitution antenna.

$G_s$  (dBi or dBd) : Substitution antenna Gain.

$E_t = R_t + AF$

$E_s + R_s + AF$

$AF$  (dB/m) : Receive antenna factor

$R_t$  : The highest received signal in Spectrum Analyzer for EUT.

$R_s$  : The highest received signal in Spectrum Analyzer for substitution antenna.

4.3.3 Test Setup Layout of ERP/EIRP

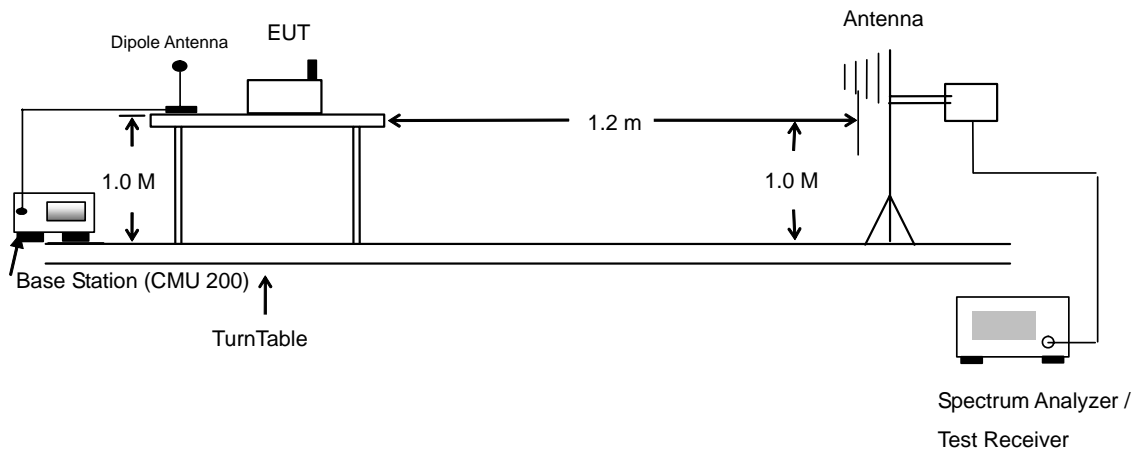



4.3.4 Test Result

<b>GSM850 Radiated Power ERP</b>						
Horizontal Polarization						
Frequency (MHz)	Rt (dBm)	Rs (dBm)	Ps (dBm)	Gs (dBd)	ERP (dBm)	ERP (W)
824.2	-30.10	-48.12	0	-1.08	16.94	0.05
836.4	-30.90	-48.28	0	-0.93	16.45	0.04
848.8	-31.84	-48.35	0	-0.76	15.75	0.04
Vertical Polarization						
Frequency (MHz)	Rt (dBm)	Rs (dBm)	Ps (dBm)	Gs (dBd)	ERP (dBm)	ERP (W)
824.2	-19.66	-47.97	0	-1.08	27.23	0.53
<b>836.4</b>	<b>-19.70</b>	<b>-48.01</b>	<b>0</b>	<b>-0.93</b>	<b>27.38</b>	<b>0.55</b>
848.8	-20.22	-48.05	0	-0.76	27.07	0.51

<b>PCS1900 Radiated Power EIRP</b>						
Horizontal Polarization						
Frequency (MHz)	Rt (dBm)	Rs (dBm)	Ps (dBm)	Gs (dBi)	EIRP (dBm)	EIRP (W)
1850.2	-29.66	-51.88	0	1.96	24.18	0.26
1880.0	-29.49	-52.99	0	2.00	25.50	0.35
<b>1909.8</b>	<b>-30.28</b>	<b>-54.28</b>	<b>0</b>	<b>1.98</b>	<b>25.98</b>	<b>0.40</b>
Vertical Polarization						
Frequency (MHz)	Rt (dBm)	Rs (dBm)	Ps (dBm)	Gs (dBi)	EIRP (dBm)	EIRP (W)
1850.2	-29.78	-52.13	0	1.96	24.31	0.27
1880.0	-30.15	-53.17	0	2.00	25.02	0.32
1909.8	-31.39	-54.13	0	1.98	24.72	0.30

## 4.4 Occupied Bandwidth and Band Edge Measurement

### 4.4.1 Measurement Instruments

As described in chapter 5 of this test report.

### 4.4.2 Test Procedure

1. The EUT was connected to Spectrum Analyzer and Base Station via power divider.
2. The occupied bandwidth of middle channel for the highest and lowest RF powers were measured.
3. The bandedge of low and high channels for the highest RF powers within the transmitting frequency band were measured. Setting RBW as roughly  $BW/100$ .

### 4.4.3 Test Setup Layout

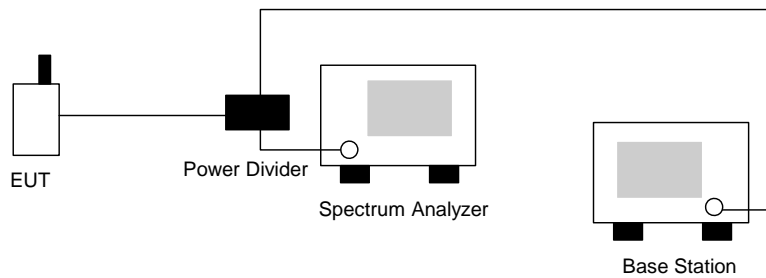



4.4.4 Test Result

- Test Mode : GSM 850 CH128 Lower Band Edge
- Power State : High

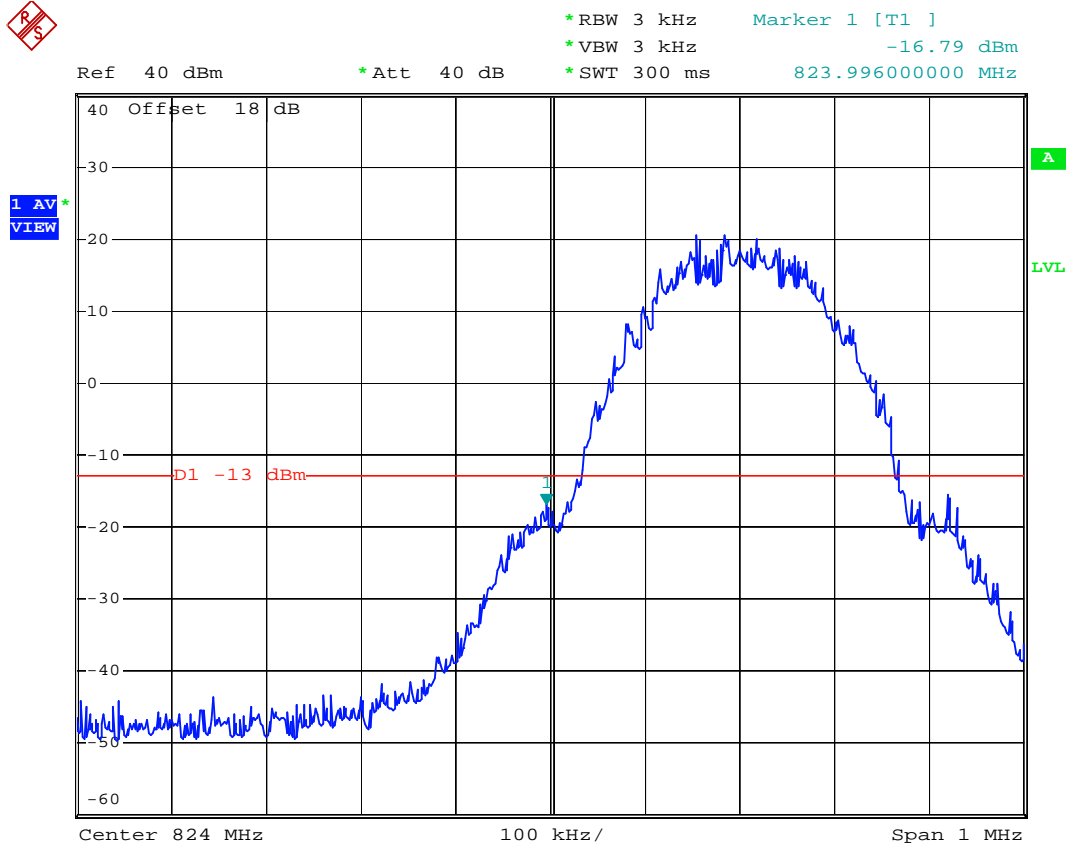

Date: 14.APR.2006 15:19:07



- Test Mode : GSM 850 CH189 99% Occupied Bandwidth
- Power State : Low

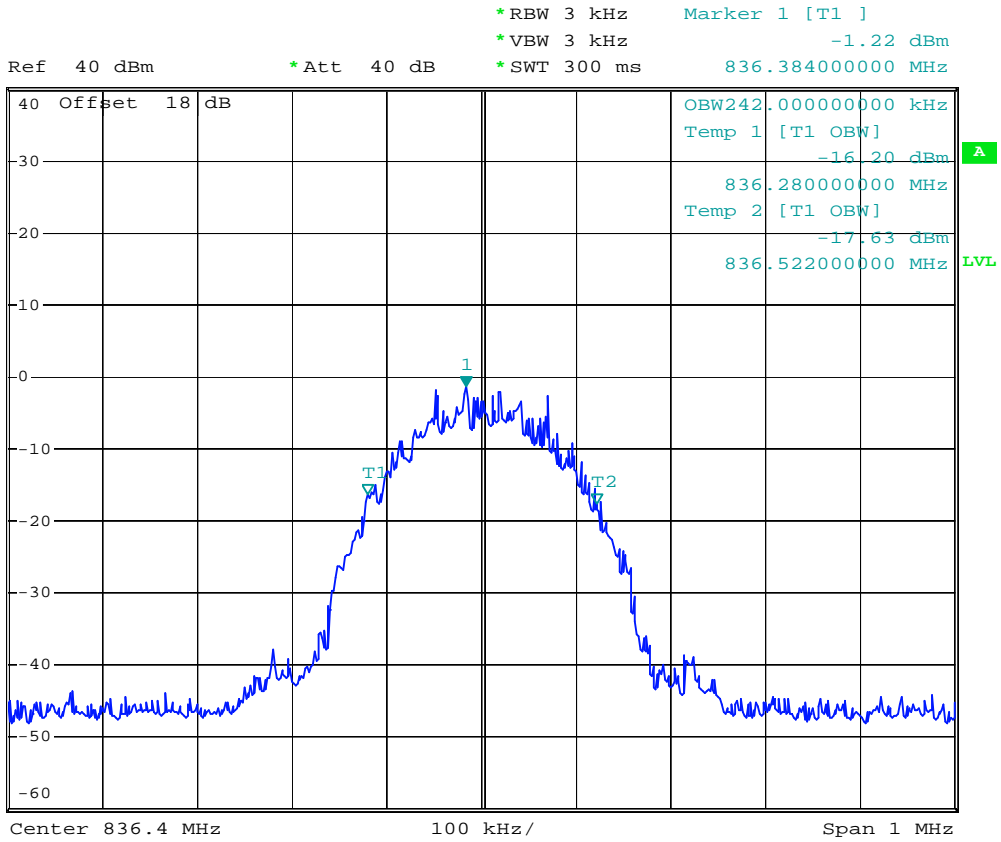

Date: 14.APR.2006 15:13:49



- Test Mode : GSM 850 CH189 99% Occupied Bandwidth
- Power State : High

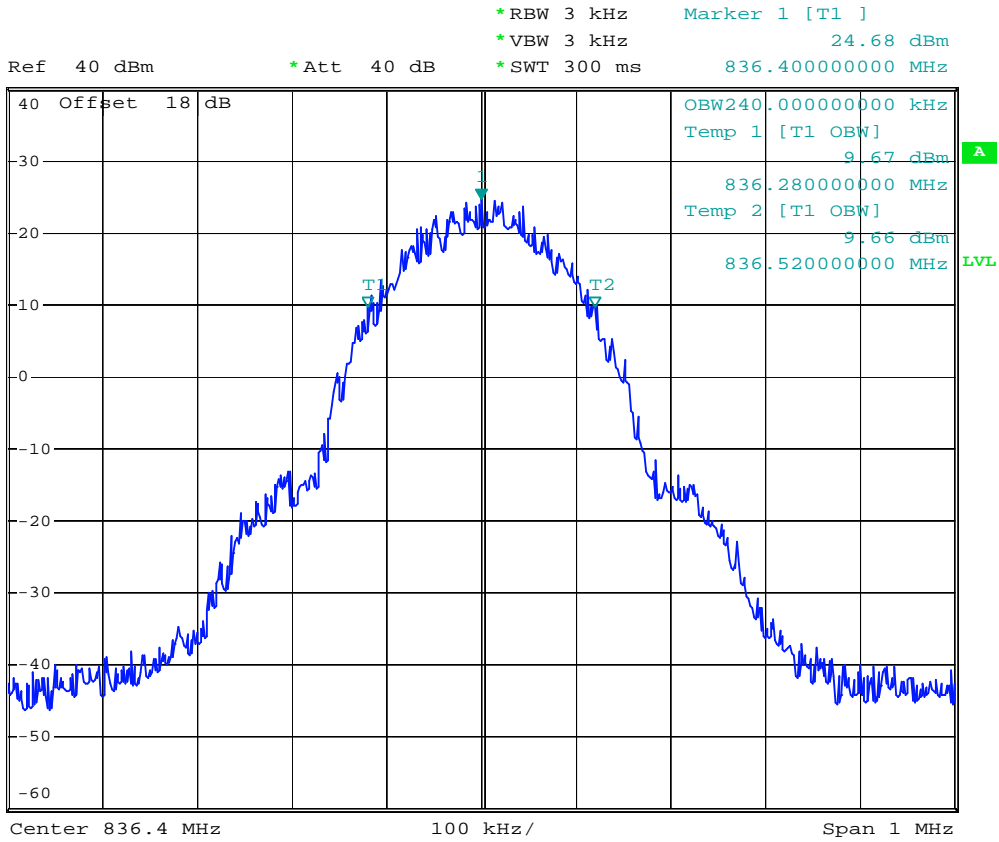

Date: 14.APR.2006 15:13:01





- Test Mode : GSM 850 CH251 Higher Band Edge
- Power State : High



Ref 40 dBm      \*Att 40 dB      \*RBW 3 kHz      Marker 1 [T1 ]  
\*VBW 3 kHz      -18.04 dBm  
\*SWT 300 ms      849.01800000 MHz

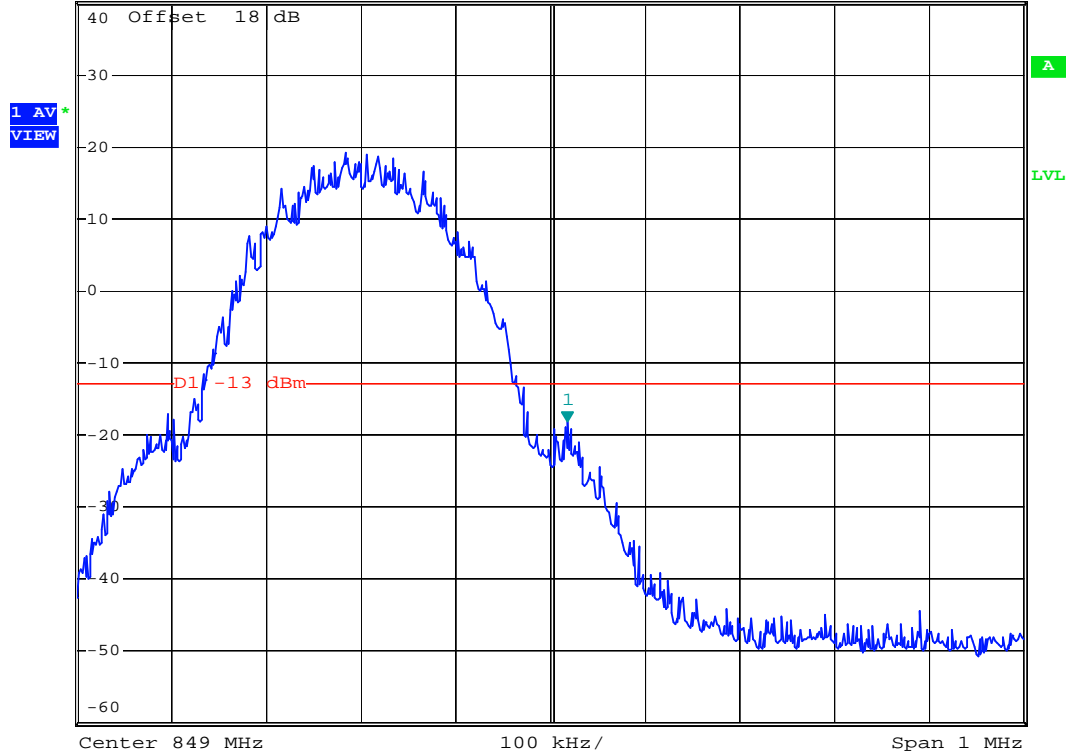

Date: 14.APR.2006 15:20:18



- Test Mode : PCS 1900 CH512 Lower Band Edge
- Power State : High

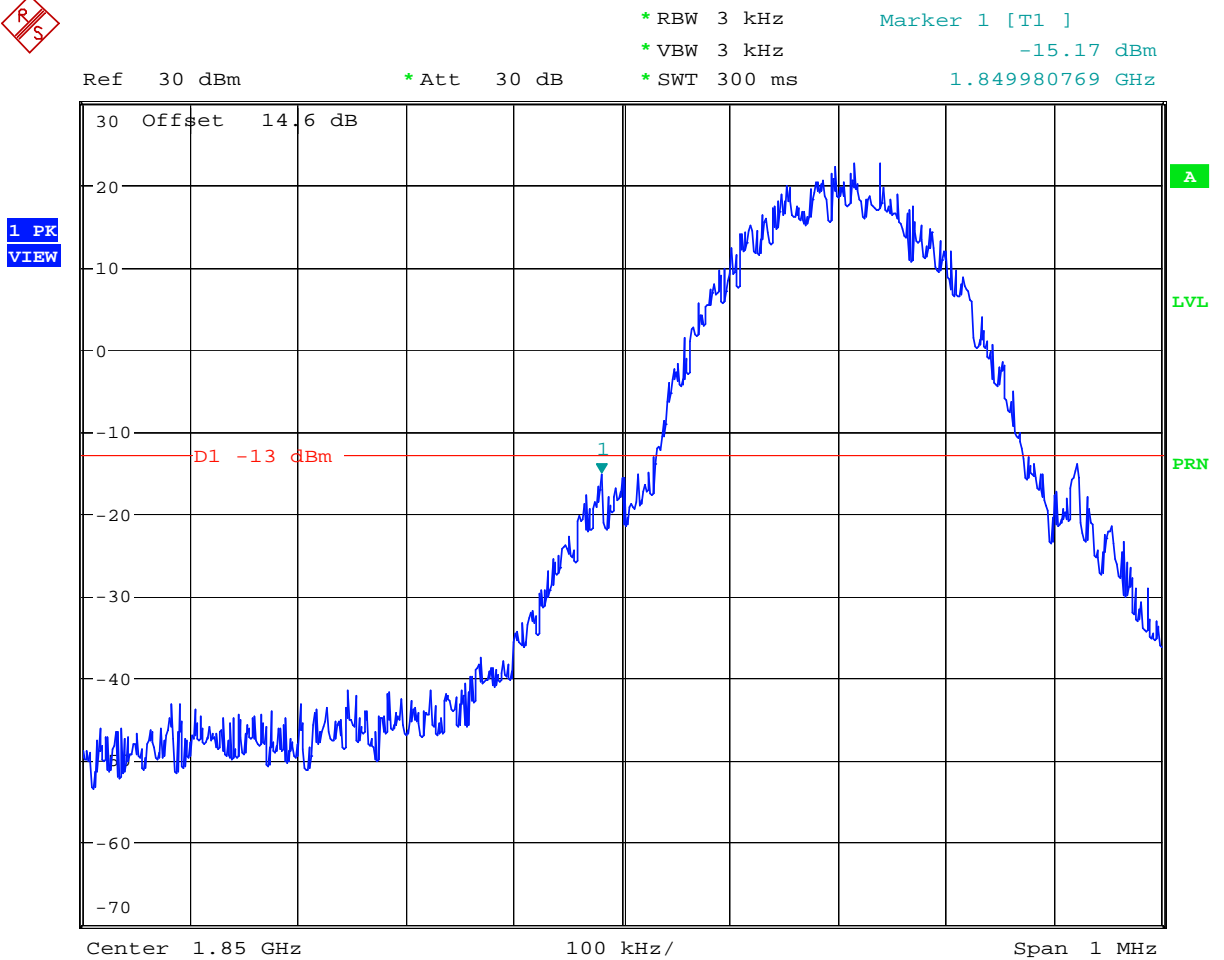

Date: 21.JAN.2006 20:15:17



- Test Mode : PCS 1900 CH661 99% Occupied Bandwidth
- Power State : Low

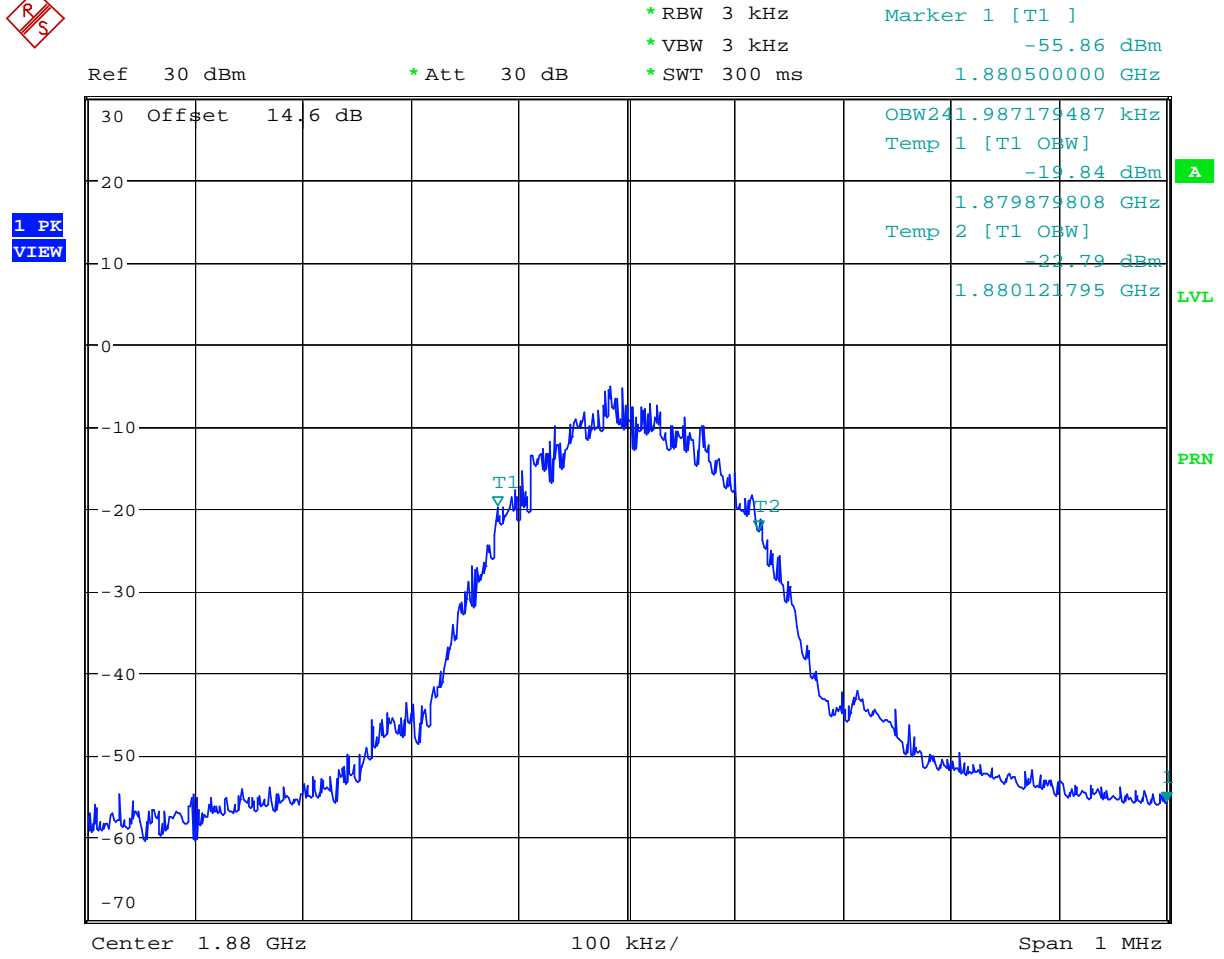

Date: 21.JAN.2006 20:14:21



- Test Mode : PCS 1900 CH661 99% Occupied Bandwidth
- Power State : High

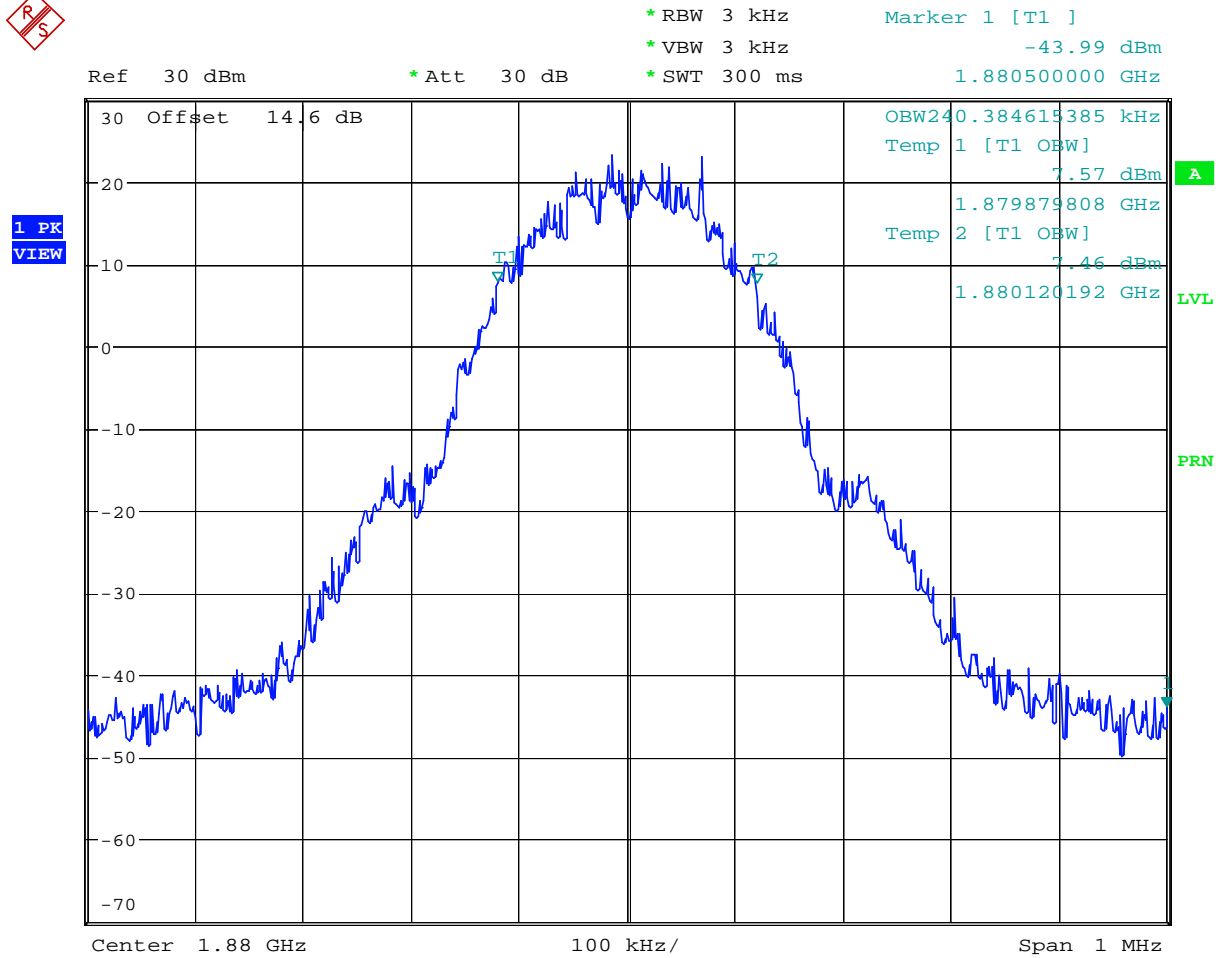

Date: 21.JAN.2006 20:12:12



- Test Mode : PCS 1900 CH810 Higher Band Edge
- Power State : High



Ref 30 dBm      \*Att 30 dB      \*RBW 3 kHz      Marker 1 [T1]      -13.97 dBm  
\*VBW 3 kHz      1.910017628 GHz  
\*SWT 300 ms

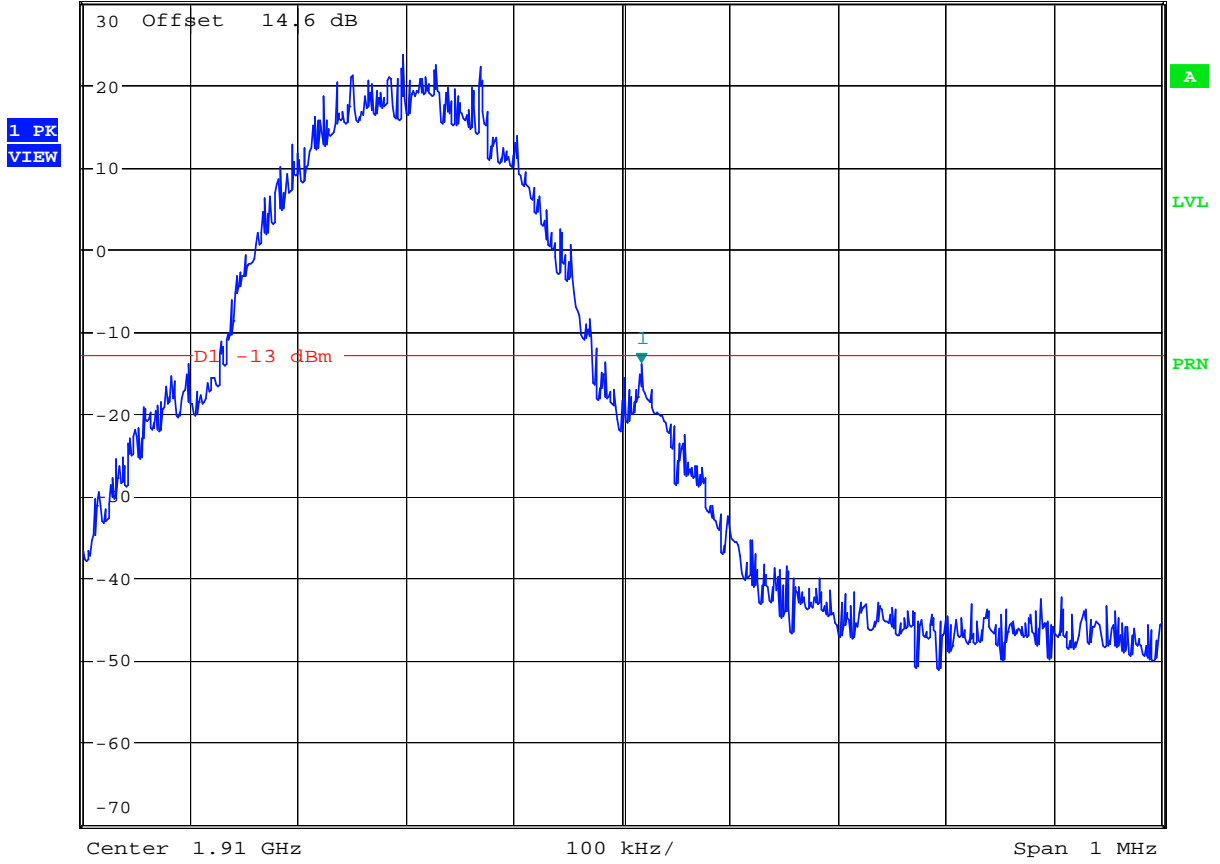

Date: 21.JAN.2006 20:16:14

## 4.5 Conducted Emission

### 4.5.1 Measurement Instruments

As described in chapter 5 of this test report.

### 4.5.2 Test Procedure

1. The EUT was connected to Spectrum Analyzer and Base Station via power divider.
2. The middle channel for the highest RF power within the transmitting frequency was measured.
3. The conducted spurious emission for the whole frequency range was taken.

### 4.5.3 Test Setup Layout

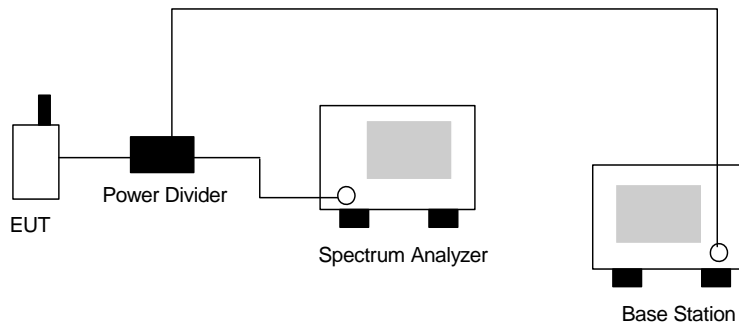



4.5.4 Test Result

- Test Mode : GSM 850 CH189
- Frequency Range : 30M-1G

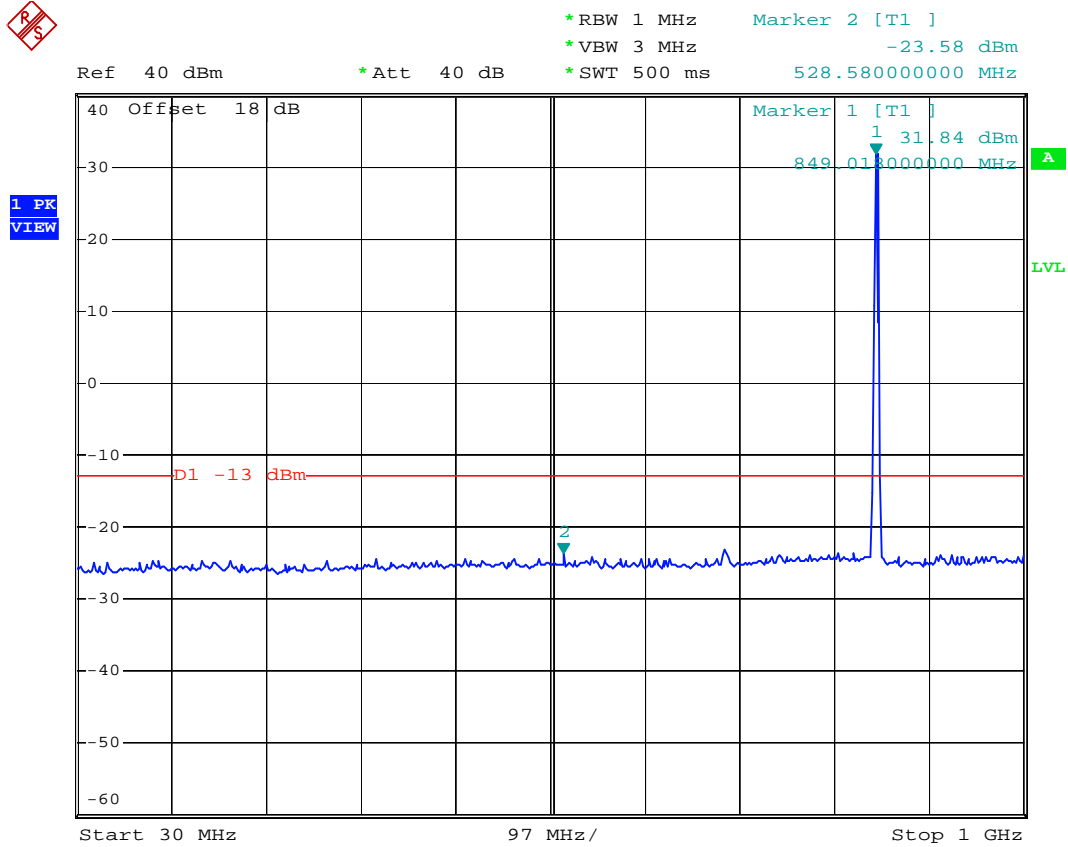

Date: 14.APR.2006 15:25:40



- Test Mode : GSM 850 CH189
- Frequency Range : 1G-3G

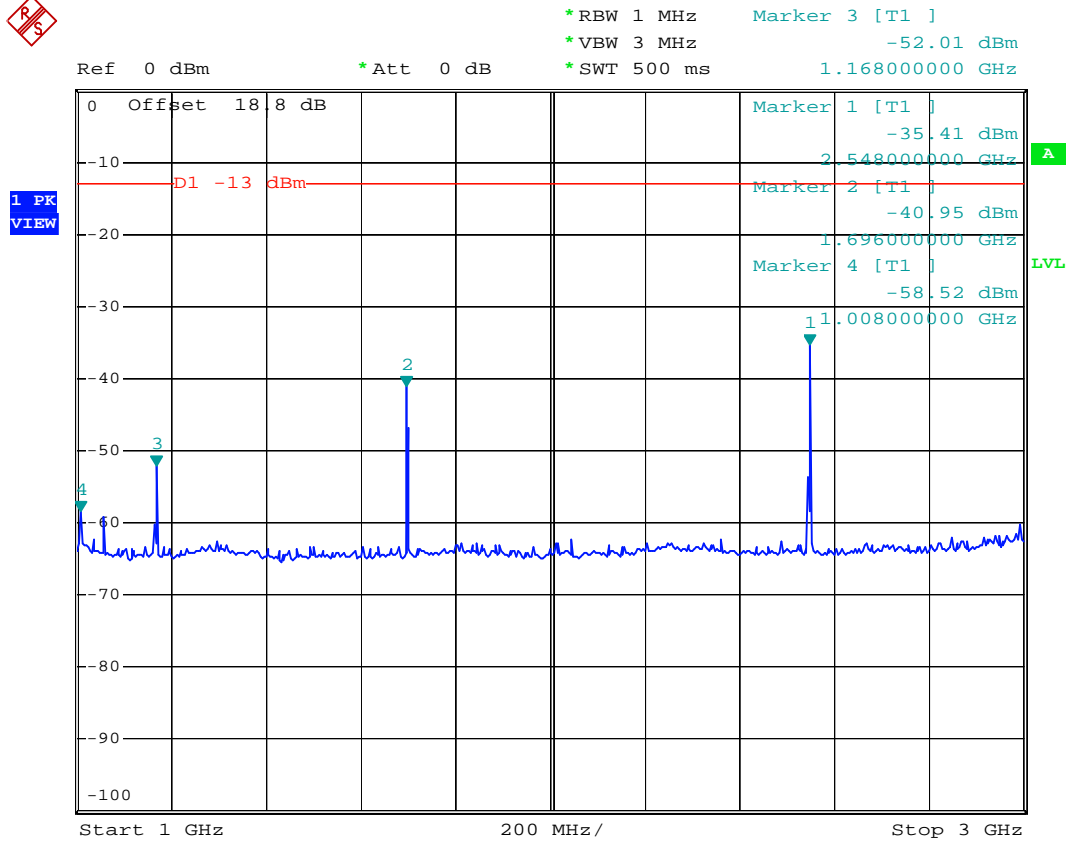

Date: 14.APR.2006 15:39:56





- Test Mode : GSM 850 CH189
- Frequency Range : 3G-7G

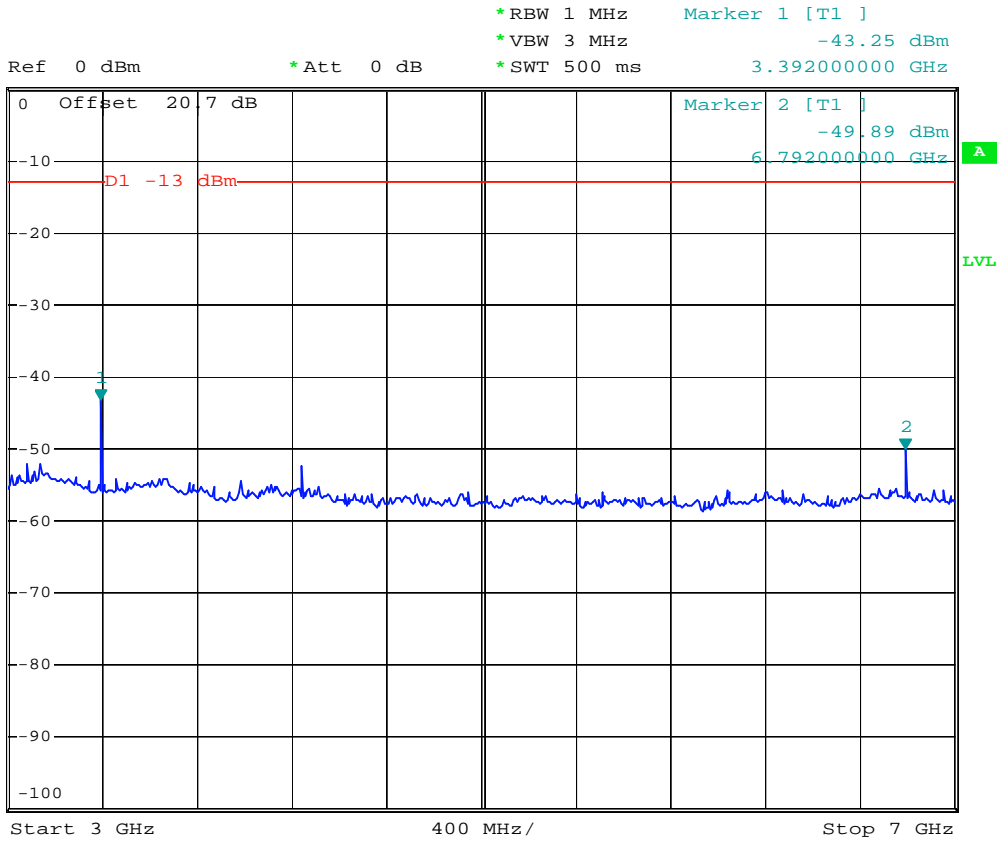

Date: 14.APR.2006 15:41:47



- Test Mode : GSM 850 CH189
- Frequency Range : 7G-9G

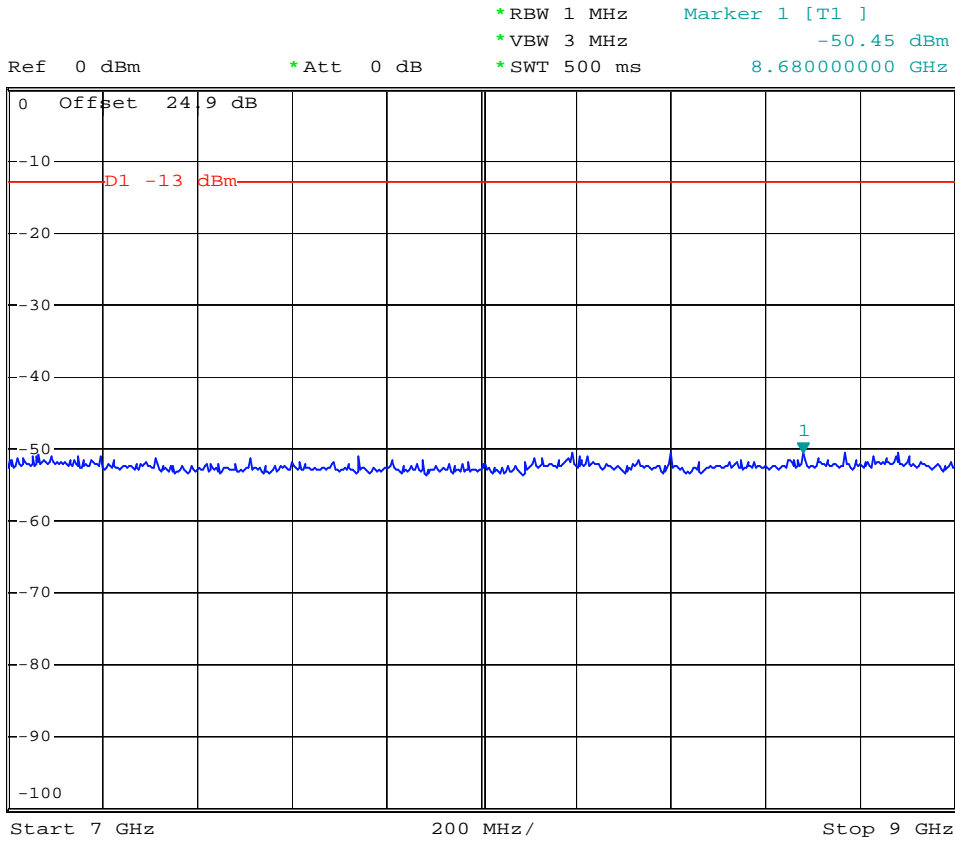

Date: 14.APR.2006 15:43:35



- Test Mode : PCS 1900 CH661
- Frequency Range : 30M-1G

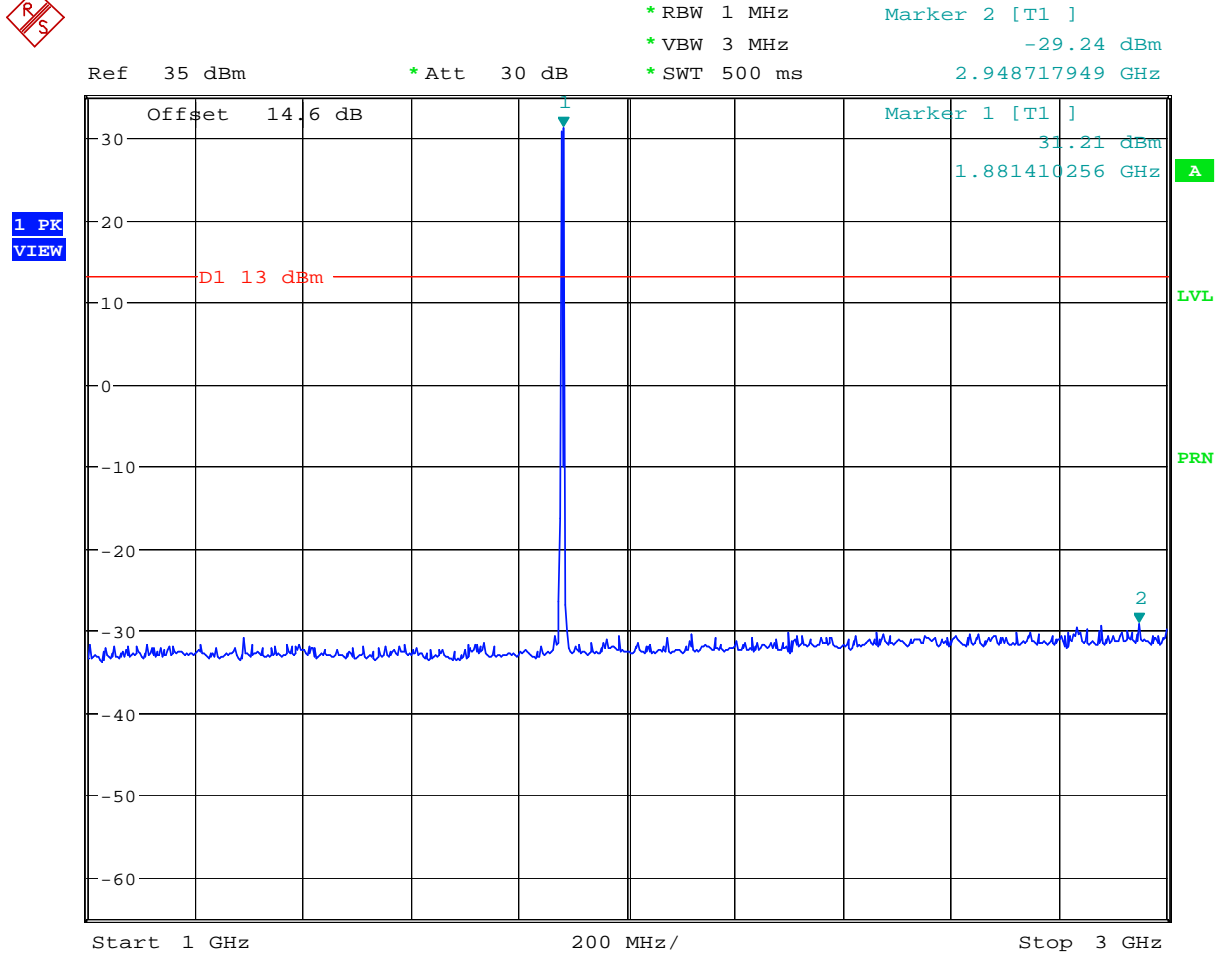

Date: 21.JAN.2006 20:21:35



- Test Mode : PCS 1900 CH661
- Frequency Range : 1G-3G

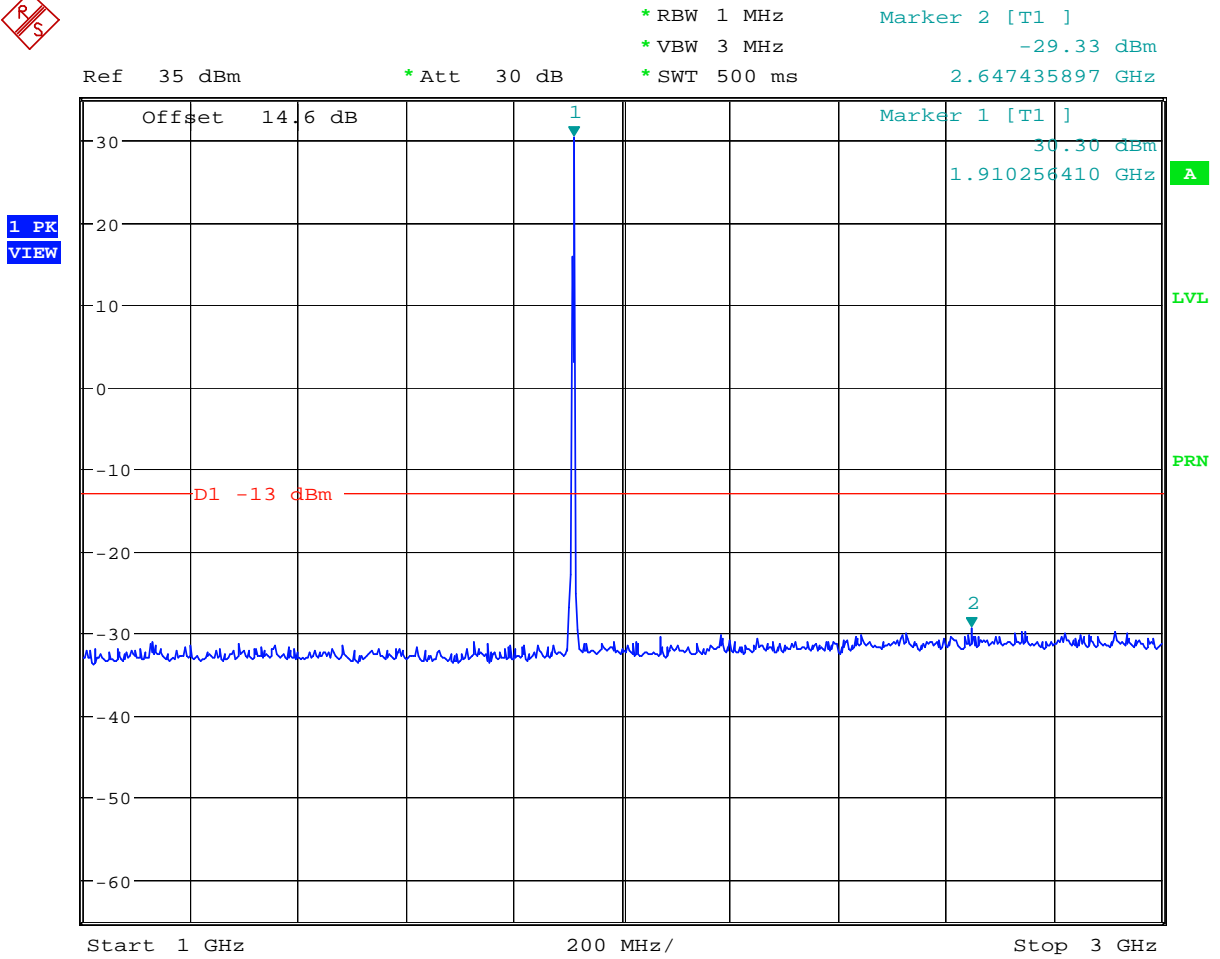

Date: 21.JAN.2006 21:21:46



- Test Mode : PCS 1900 CH661
- Frequency Range : 3G-7G

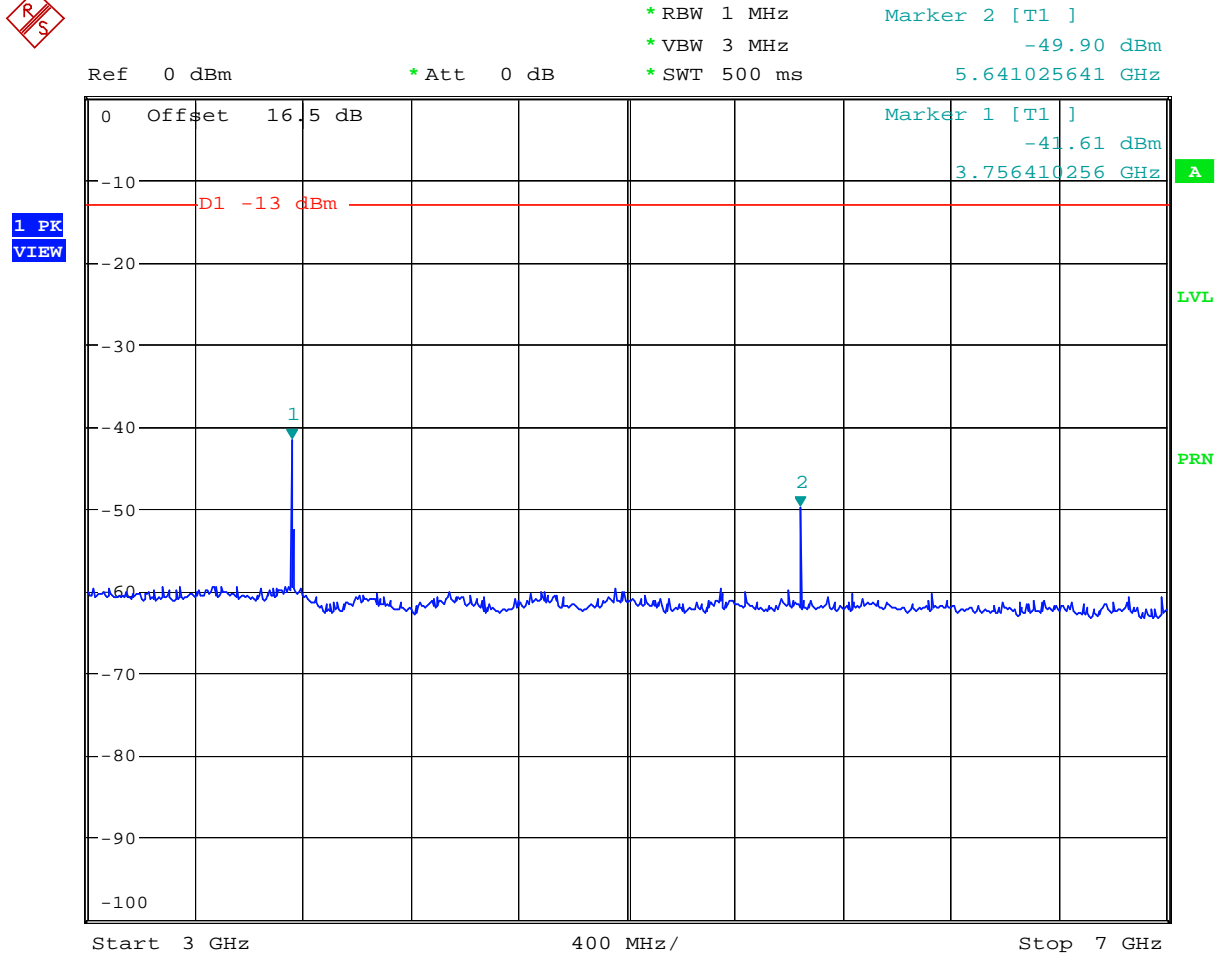

Date: 21.JAN.2006 20:23:37



- Test Mode : PCS 1900 CH661
- Frequency Range : 7G-13.6G

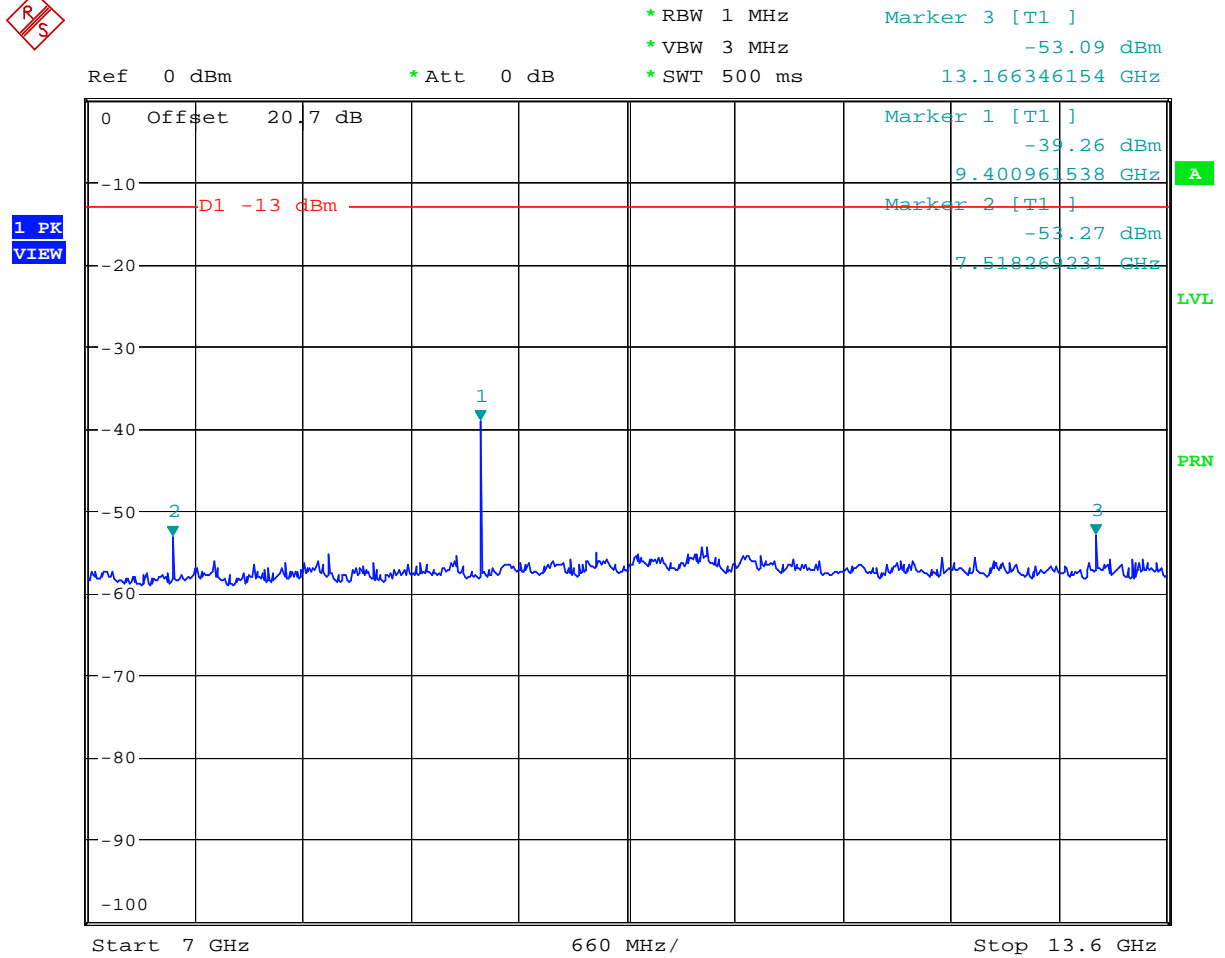

Date: 21.JAN.2006 20:25:20



- Test Mode : PCS 1900 CH661
- Frequency Range : 13.6G-19.1G

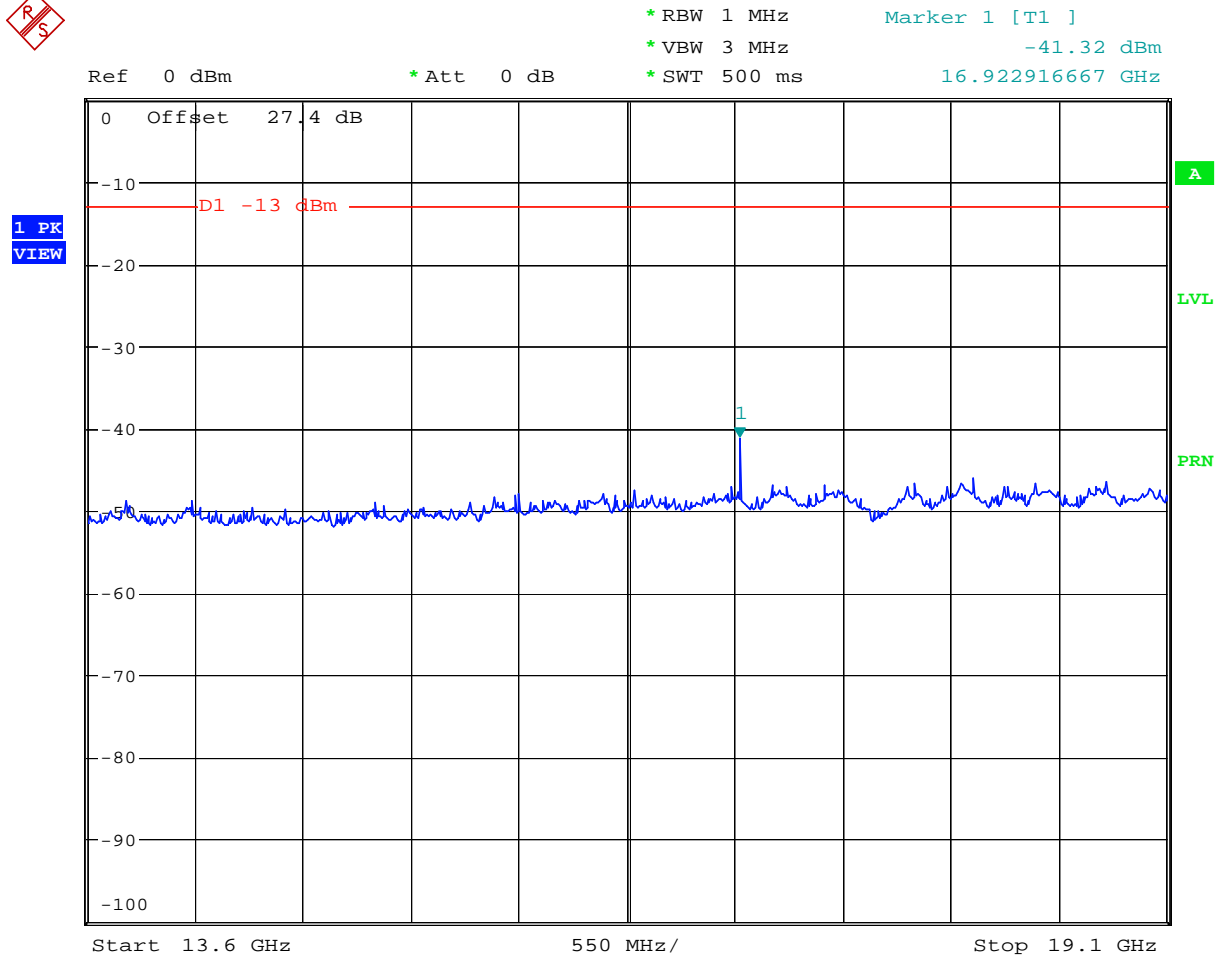

Date: 21.JAN.2006 20:26:31

## 4.6 Field Strength of Spurious Radiation

Equivalent isotropic radiated Power Measurements by substitution method according to ANSI/TIA/EIA-603-A.

### 4.6.1 Measurement Instruments

As described in chapter 5 of this test report.

### 4.6.2 Test Procedure

1. The EUT was placed on a rotatable wooden table with 0.8 meter about ground.
2. The EUT was set 3 meters from the receiving antenna which was mounted on the antenna tower.
3. The table was rotated 360 degrees to determine the position of the highest spurious emission.
4. The height of the receiving antenna is varied between one meter and four meters to reach the maximum spurious emission for both horizontal and vertical polarizations.
5. Taking the record of maximum spurious emission.
6. A Horn antenna was substituted in place of the EUT and was driven by a signal generator.
7. Tune the output power of signal generator to the same emission level with EUT maximum spurious emission.
8. Taking the record of output power at antenna port.
9. Repeat step 7 to step 8 for another polarization.
10. Emission level (dBm) = output power + substitution Gain.

### 4.6.3 Test Setup Layout

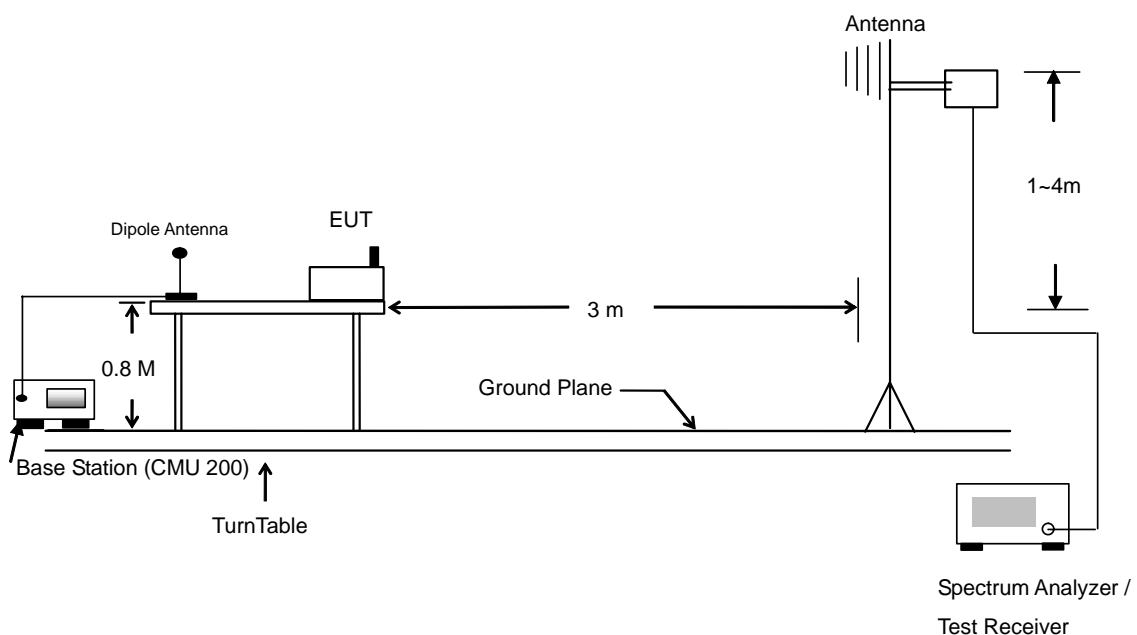





4.6.4 Test Result

- Test Mode : Mode 1

<b>GSM 850 Radiated Spurious ERP</b>							
H Polarization				V Polarization			
Frequency (MHz)	ERP (dBm)	Limit (dBm)	Margin (dB)	Frequency (MHz)	ERP (dBm)	Limit (dBm)	Margin (dB)
30.000	-55.99	-13	-42.99	63.480	-49.41	-13	-36.41
99.390	-53.17	-13	-40.17	98.580	-50.240	-13	-37.24
205.230	-56.49	-13	-43.49	158.790	-50.100	-13	-37.10
462.400	-56.72	-13	-43.72	449.800	-54.620	-13	-41.62
558.300	-55.81	-13	-42.81	463.800	-55.510	-13	-42.51
1194.000	-53.19	-13	-40.19	596.800	-54.490	-13	-41.49
1674.000	-48.26	-13	-35.26	1194.000	-58.220	-13	-45.22
2508.000	-48.63	-13	-35.63	<b>1674.000</b>	<b>-41.910</b>	<b>-13</b>	<b>-28.91</b>
3344.000	-55.99	-13	-42.99	2508.000	-51.290	-13	-38.29
6688.000	-45.29	-13	-32.29	6688.000	-44.450	-13	-31.45

- Test Mode : Mode 2

<b>PCS 1900 Radiated Spurious EIRP</b>							
H Polarization				V Polarization			
Frequency (MHz)	EIRP (dBm)	Limit (dBm)	Margin (dB)	Frequency (MHz)	EIRP (dBm)	Limit (dBm)	Margin (dB)
31.08	-54.11	-13	-41.11	32.43	-48.66	-13	-35.66
66.18	-54.15	-13	-41.15	71.58	-47.84	-13	-34.84
102.09	-54.38	-13	-41.38	84.54	-51.22	-13	-38.22
404.3	-67.81	-13	-54.81	596.8	-64.93	-13	-51.93
579.3	-66.91	-13	-53.91	857.9	-62.10	-13	-49.10
967.8	-63.89	-13	-50.89	971.3	-60.83	-13	-47.83
1718	-50.31	-13	-37.31	1718	-50.97	-13	-37.97
2038	-58.57	-13	-45.57	2038	-54.67	-13	-41.67
3758	-46.53	-13	-33.53	3758	-39.32	-13	-26.32
5638	-41.55	-13	-28.55	5638	-47.94	-13	-34.94
8688	-41.86	-13	-28.86	8908	-41.91	-13	-28.91
<b>9398</b>	<b>-35.38</b>	<b>-13</b>	<b>-22.38</b>	9398	-37.07	-13	-24.07
14828	-43.97	-13	-30.97				



4.6.5 Test Data

4.6.5.1 Mode 1

Horizontal Polarization

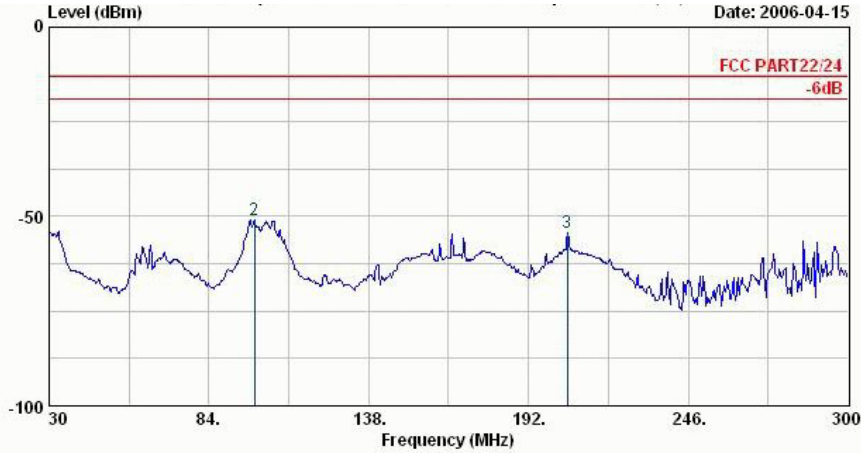

Site : 03CH06-HY  
 Condition : LF-SPURIOUS HORIZONTAL  
 EUT : GSM 850/1800/1900 Mobile Phone  
 Power : 120Vac/60Hz  
 Model : FG 641107  
 Memo : GSM850 Link Mode;Ch189+Earphone+Adapter  
 Plane : E1

	Freq MHz	Level dBm	Over Limit dB	Limit Line dBm	Read Level dBm	Factor dB	Remark
1 @	30.00	-53.84	-40.84	-13.00	-54.20	0.36	Peak
2 @	99.39	-51.02	-38.02	-13.00	-38.78	-12.24	Peak
3 @	205.23	-54.34	-41.34	-13.00	-41.15	-13.19	Peak

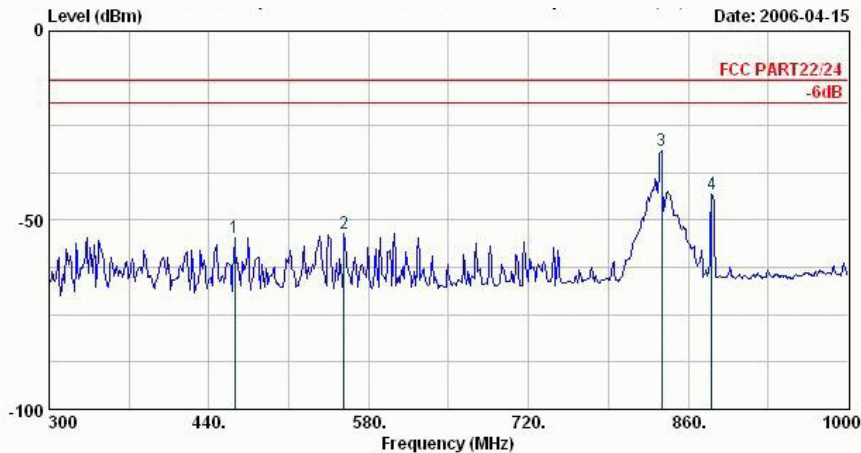

Site : 03CH06-HY  
 Condition : LF-SPURIOUS HORIZONTAL  
 EUT : GSM 850/1800/1900 Mobile Phone  
 Power : 120Vac/60Hz  
 Model : FG 641107  
 Memo : GSM850 Link Mode;Ch189+Earphone+Adapter  
 Plane : E1

	Freq MHz	Level dBm	Over Limit dB	Limit Line dBm	Read Level dBm	Factor dB	Remark
1 @	462.40	-54.57	-41.57	-13.00	-48.93	-5.63	Peak
2 @	558.30	-53.66	-40.66	-13.00	-49.35	-4.31	Peak
3 @	836.90	-31.64			-30.30	-1.33	Peak
4 @	880.30	-43.05			-42.14	-0.91	Peak

Remark:

- 1. #3: MS TCH Signal.
- 2. #4: BS TCH Signal.

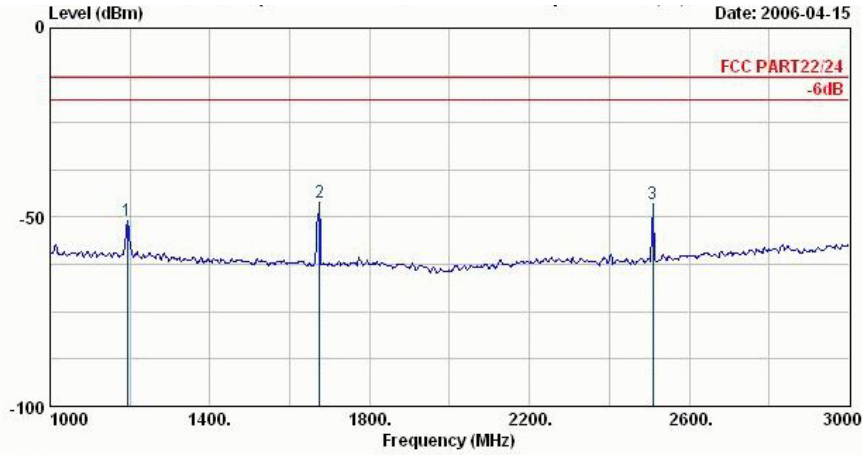

Site : 03CH06-HY  
 Condition : HF-SPURIOUS HORIZONTAL  
 EUT : GSM 850/1800/1900 Mobile Phone  
 Power : 120Vac/60Hz  
 Model : FG 641107  
 Memo : GSM850 Link Mode;Ch189+Earphone+Adapter  
 Plane : E1

	Freq	Level	Over	Limit	Read	Factor	Remark
	MHz	dBm	dB	dBm	dBm	dB	
1 @	1194.00	-51.04	-38.04	-13.00	-52.41	1.37	Peak
2 @	1674.00	-46.11	-33.11	-13.00	-46.33	0.22	Peak
3 @	2508.00	-46.48	-33.48	-13.00	-47.68	1.20	Peak

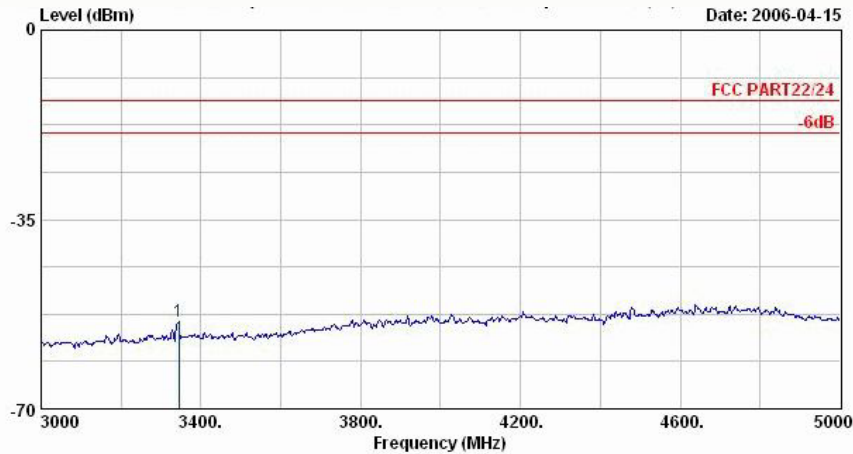

Site : 03CH06-HY  
 Condition : HF-SPURIOUS HORIZONTAL  
 EUT : GSM 850/1800/1900 Mobile Phone  
 Power : 120Vac/60Hz  
 Model : FG 641107  
 Memo : GSM850 Link Mode;Ch189+Earphone+Adapter  
 Plane : E1

	Freq	Level	Over	Limit	Read	Factor	Remark
	MHz	dBm	dB	dBm	dBm	dB	
1 @	3344.00	-53.84	-40.84	-13.00	-59.25	5.41	Peak

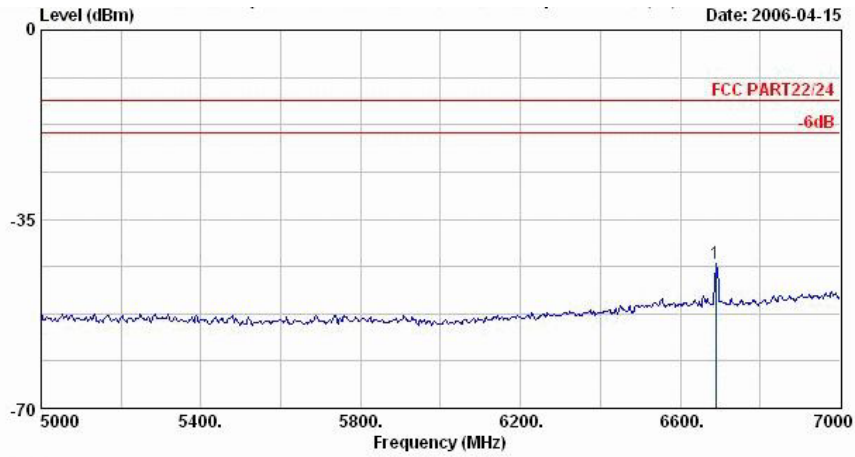

Site : 03CH06-HY  
 Condition : HF-SPURIOUS HORIZONTAL  
 EUT : GSM 850/1800/1900 Mobile Phone  
 Power : 120Vac/60Hz  
 Model : FG 641107  
 Memo : GSM850 Link Mode;Ch189+Earphone+Adapter  
 Plane : E1

	Freq	Level	Over	Limit	Read	Factor	Remark
	MHz	dBm	dB	dBm	dBm	dB	
1 @	6688.00	-43.14	-30.14	-13.00	-56.27	13.14	Peak

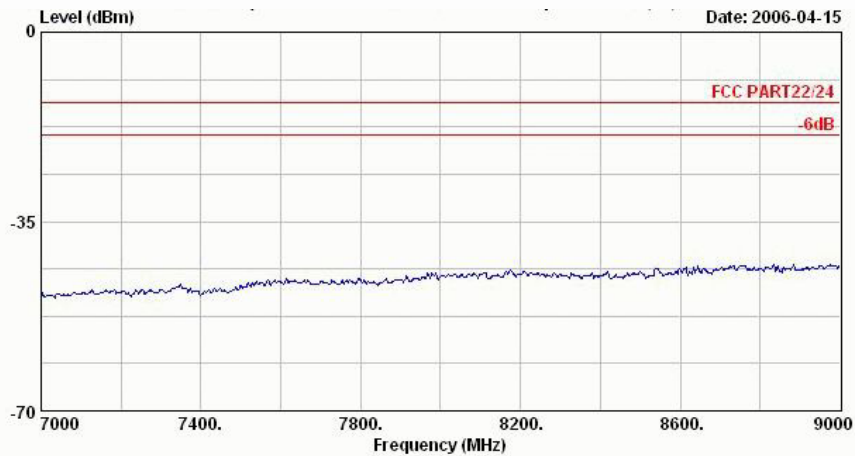

Site : 03CH06-HY  
 Condition : HF-SPURIOUS HORIZONTAL  
 EUT : GSM 850/1800/1900 Mobile Phone  
 Power : 120Vac/60Hz  
 Model : FG 641107  
 Memo : GSM850 Link Mode;Ch189+Earphone+Adapter  
 Plane : E1



Vertical Polarization

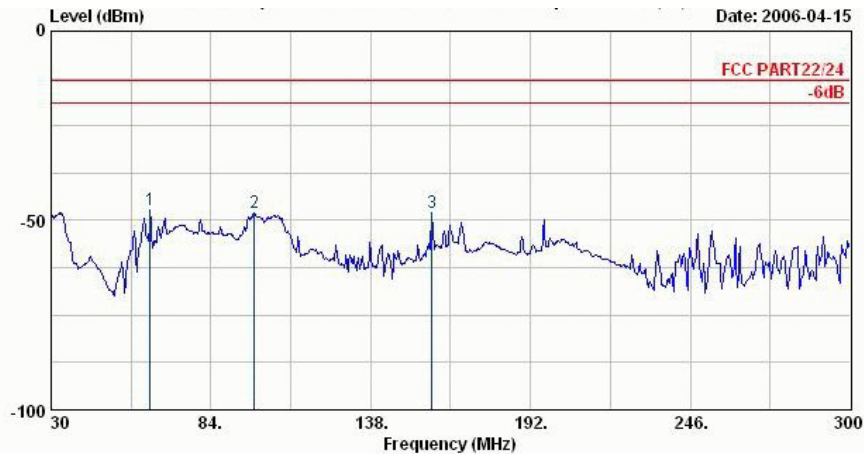

Site : 03CH06-HY  
 Condition : LF-SPURIOUS VERTICAL  
 EUT : GSM 850/1800/1900 Mobile Phone  
 Power : 120Vac/60Hz  
 Model : FG 641107  
 Memo : GSM850 Link Mode;Ch189+Earphone+Adapter  
 Plane : E1

	Freq	Level	Over	Limit	Read	
	MHz	dBm	dB	dBm	dBm	dB
1 @	63.48	-47.26	-34.26	-13.00	-34.40	-12.86 Peak
2 @	98.58	-48.09	-35.09	-13.00	-40.26	-7.83 Peak
3 @	158.79	-47.95	-34.95	-13.00	-39.73	-8.22 Peak

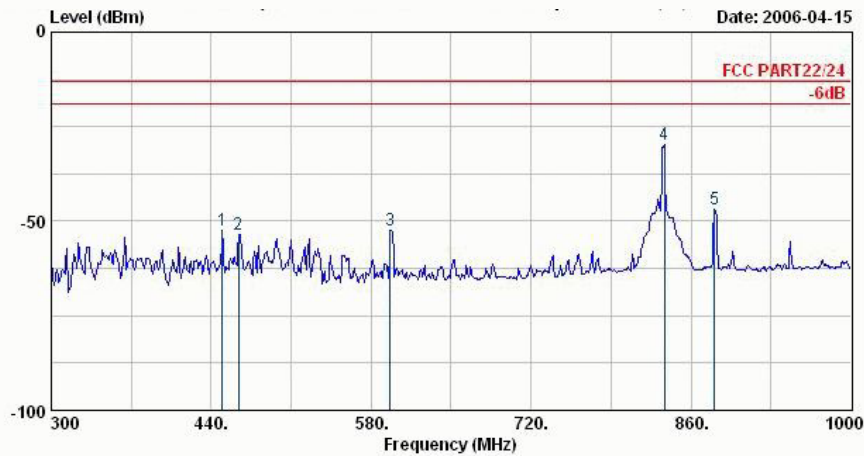

Site : 03CH06-HY  
 Condition : LF-SPURIOUS VERTICAL  
 EUT : GSM 850/1800/1900 Mobile Phone  
 Power : 120Vac/60Hz  
 Model : FG 641107  
 Memo : GSM850 Link Mode;Ch189+Earphone+Adapter  
 Plane : E1

	Freq	Level	Over	Limit	Read	
	MHz	dBm	dB	dBm	dBm	dB
1 @	449.80	-52.47	-39.47	-13.00	-48.74	-3.73 Peak
2 @	463.80	-53.36	-40.36	-13.00	-49.80	-3.56 Peak
3 @	596.80	-52.34	-39.34	-13.00	-50.36	-1.98 Peak
4 @	836.90	-29.87			-31.24	1.36 Peak
5 @	880.30	-46.77			-48.48	1.71 Peak

Remark:

- #4: MS TCH Signal.
- #5: BS TCH Signal.

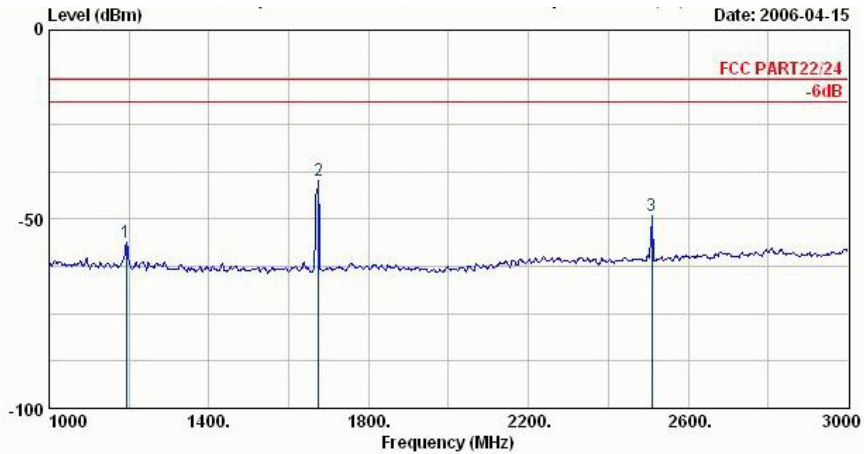

Site : 03CH06-HY  
 Condition : HF-SPURIOUS VERTICAL  
 EUT : GSM 850/1800/1900 Mobile Phone  
 Power : 120Vac/60Hz  
 Model : FG 641107  
 Memo : GSM850 Link Mode;Ch189+Earphone+Adapter  
 Plane : E1

	Freq	Level	Over	Limit	Read		
	MHz	dBm	dB	dBm	dBm	dB	Remark
1 @	1194.00	-56.07	-43.07	-13.00	-55.36	-0.72	Peak
2 @	1674.00	-39.76	-26.76	-13.00	-39.28	-0.48	Peak
3 @	2508.00	-49.14	-36.14	-13.00	-51.41	2.27	Peak

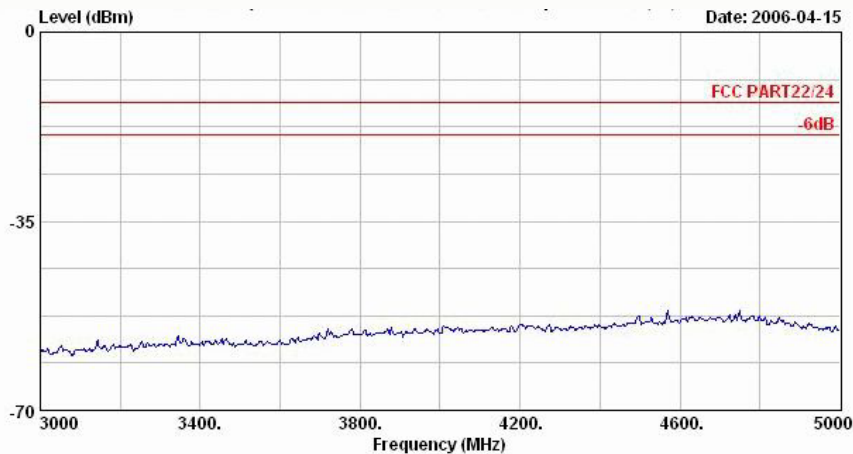

Site : 03CH06-HY  
 Condition : HF-SPURIOUS VERTICAL  
 EUT : GSM 850/1800/1900 Mobile Phone  
 Power : 120Vac/60Hz  
 Model : FG 641107  
 Memo : GSM850 Link Mode;Ch189+Earphone+Adapter  
 Plane : E1

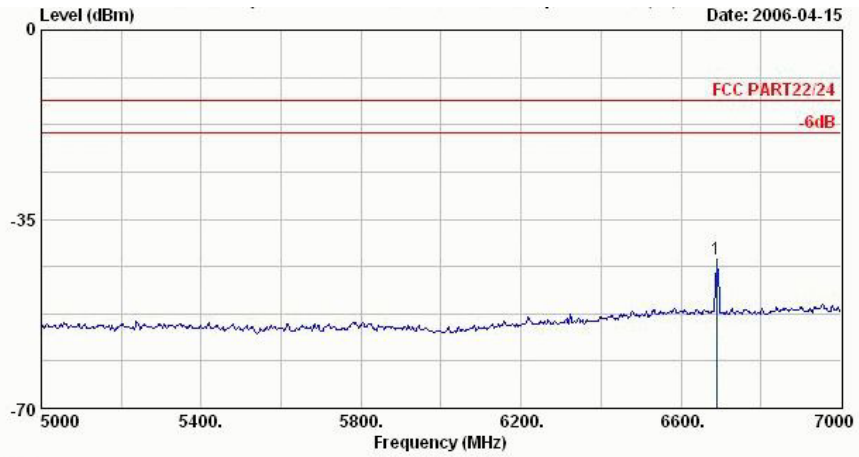

Site : 03CH06-HY  
 Condition : HF-SPURIOUS VERTICAL  
 EUT : GSM 850/1800/1900 Mobile Phone  
 Power : 120Vac/60Hz  
 Model : FG 641107  
 Memo : GSM850 Link Mode;Ch189+Earphone+Adapter  
 Plane : E1

	Freq	Level	Over	Limit	Read		
	MHz	dBm	dB	dBm	dBm	dB	Remark
1 @	6688.00	-42.30	-29.30	-13.00	-53.83	11.53	Peak

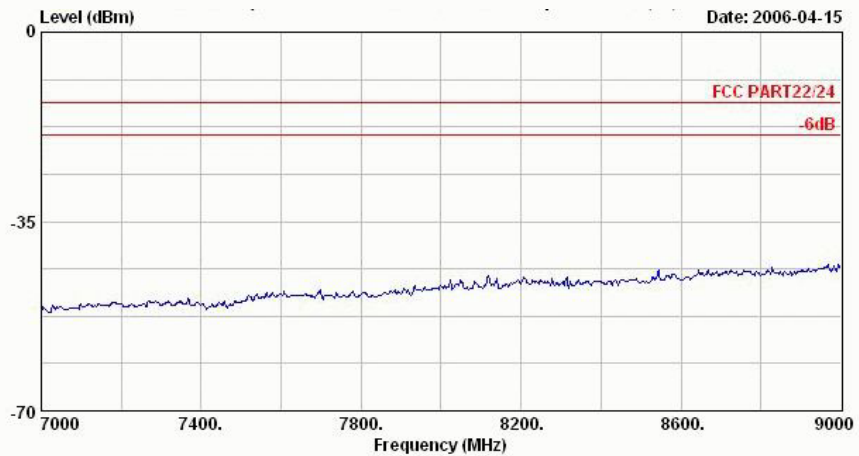

Site : 03CH06-HY  
 Condition : HF-SPURIOUS VERTICAL  
 EUT : GSM 850/1800/1900 Mobile Phone  
 Power : 120Vac/60Hz  
 Model : FG 641107  
 Memo : GSM850 Link Mode;Ch189+Earphone+Adapter  
 Plane : E1



4.6.5.2 Mode 2  
Horizontal Polarization

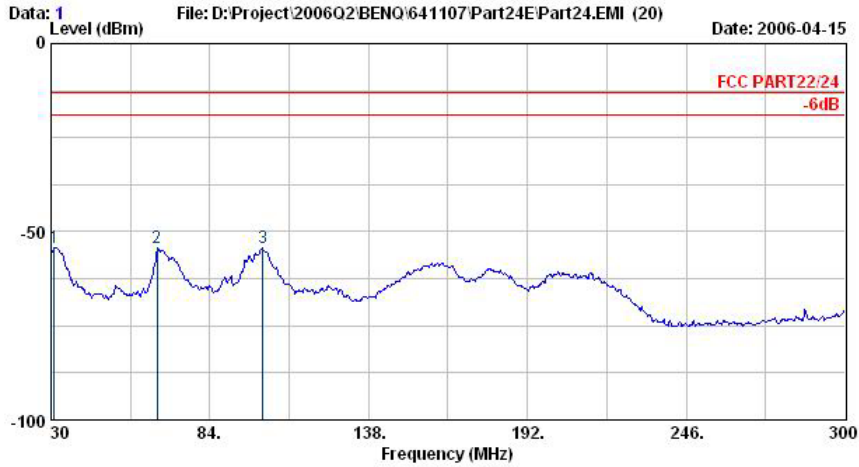

Site : 03CH06-HY  
 Condition : LF-SPURIOUS HORIZONTAL  
 EUT : GSM 850/1800/1900 Mobile Phone  
 Power : 120Vac/60Hz  
 Model : FG 641107  
 Memo : PCS1900 Link Mode;Ch189+Earphone+Adapter  
 Plane : E1

	Freq	Level	Over	Limit	Read		
	MHz	dBm	dB	dBm	dBm	dB	Remark
1 @	31.08	-54.11	-41.11	-13.00	-53.86	-0.25	Peak
2 @	66.18	-54.15	-41.15	-13.00	-41.77	-12.37	Peak
3 @	102.09	-54.38	-41.38	-13.00	-42.12	-12.26	Peak

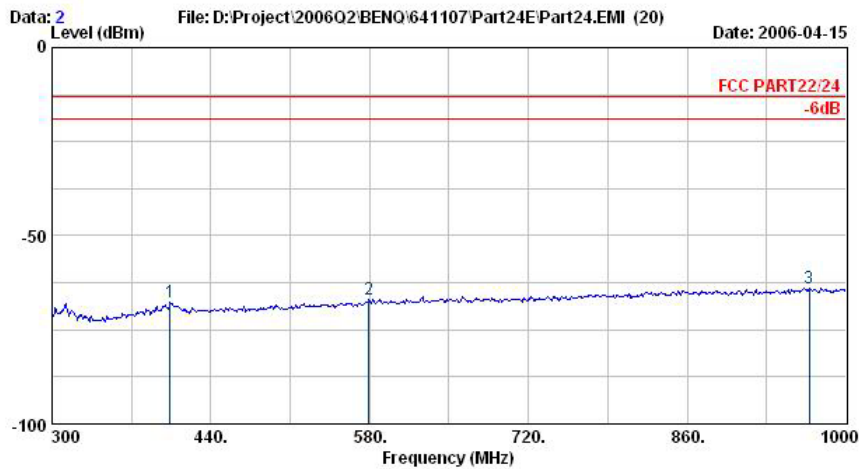

Site : 03CH06-HY  
 Condition : LF-SPURIOUS HORIZONTAL  
 EUT : GSM 850/1800/1900 Mobile Phone  
 Power : 120Vac/60Hz  
 Model : FG 641107  
 Memo : PCS1900 Link Mode;Ch189+Earphone+Adapter  
 Plane : E1

	Freq	Level	Over	Limit	Read		
	MHz	dBm	dB	dBm	dBm	dB	Remark
1 @	404.30	-67.81	-54.81	-13.00	-61.38	-6.43	Peak
2 @	579.30	-66.91	-53.91	-13.00	-62.88	-4.03	Peak
3 @	967.80	-63.89	-50.89	-13.00	-63.82	-0.07	Peak



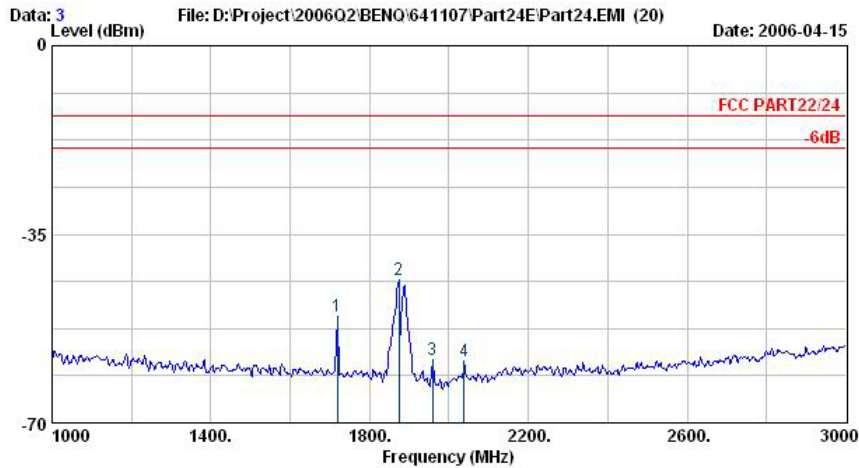

Site : 03CH06-HY  
 Condition : HF-SPURIOUS HORIZONTAL  
 EUT : GSM 850/1800/1900 Mobile Phone  
 Power : 120Vac/60Hz  
 Model : FG 641107  
 Memo : PCS1900 Link Mode;Ch189+Earphone+Adapter  
 Plane : E1

	Freq	Level	Over	Limit	Read		
	MHz	dBm	Limit	Line	Level	Factor	Remark
			dB	dBm	dBm	dB	
1 @	1718.00	-50.31	-37.31	-13.00	-50.39	0.08	Peak
2 @	1874.00	-43.59			-43.08	-0.51	Peak
3 @	1958.00	-58.18			-57.07	-1.11	Peak
4 @	2038.00	-58.57	-45.57	-13.00	-57.83	-0.73	Peak

Remark:

- #2: MS TCH Signal.
- #3: BS TCH Signal.

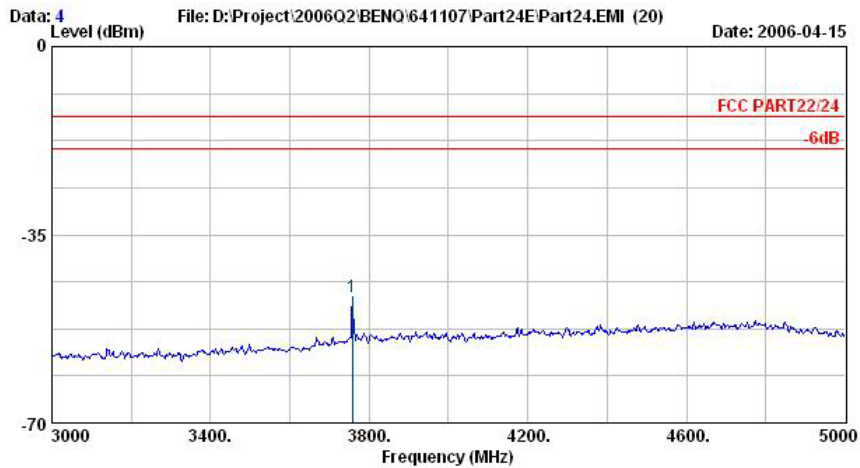

Site : 03CH06-HY  
 Condition : HF-SPURIOUS HORIZONTAL  
 EUT : GSM 850/1800/1900 Mobile Phone  
 Power : 120Vac/60Hz  
 Model : FG 641107  
 Memo : PCS1900 Link Mode;Ch189+Earphone+Adapter  
 Plane : E1

	Freq	Level	Over	Limit	Read		
	MHz	dBm	Limit	Line	Level	Factor	Remark
			dB	dBm	dBm	dB	
1 @	3758.00	-46.53	-33.53	-13.00	-54.45	7.92	Peak

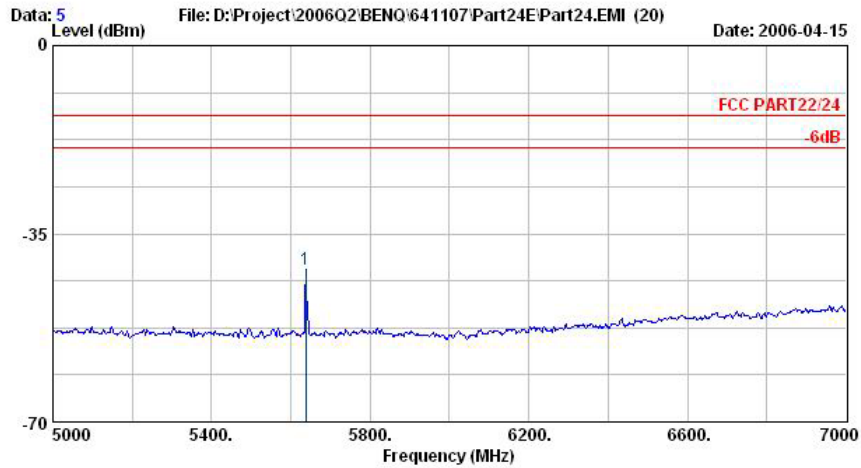

Site : 03CH06-HY  
 Condition : HF-SPURIOUS HORIZONTAL  
 EUT : GSM 850/1800/1900 Mobile Phone  
 Power : 120Vac/60Hz  
 Model : FG 641107  
 Memo : PCS1900 Link Mode;Ch189+Earphone+Adapter  
 Plane : E1

	Freq	Level	Over	Limit	Read		
	MHz	dBm	dB	dBm	dBm	dB	Remark
1 @	5638.00	-41.55	-28.55	-13.00	-51.52	9.97	Peak

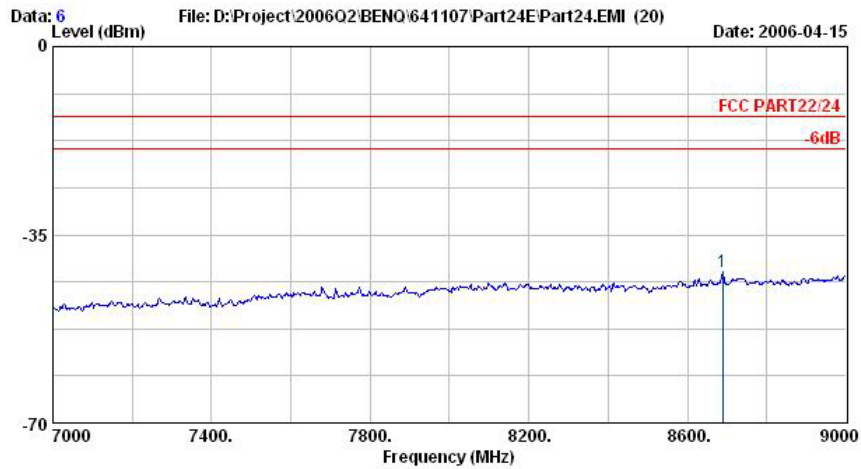

Site : 03CH06-HY  
 Condition : HF-SPURIOUS HORIZONTAL  
 EUT : GSM 850/1800/1900 Mobile Phone  
 Power : 120Vac/60Hz  
 Model : FG 641107  
 Memo : PCS1900 Link Mode;Ch189+Earphone+Adapter  
 Plane : E1

	Freq	Level	Over	Limit	Read		
	MHz	dBm	dB	dBm	dBm	dB	Remark
1 @	8688.00	-41.86	-28.86	-13.00	-61.11	19.25	Peak

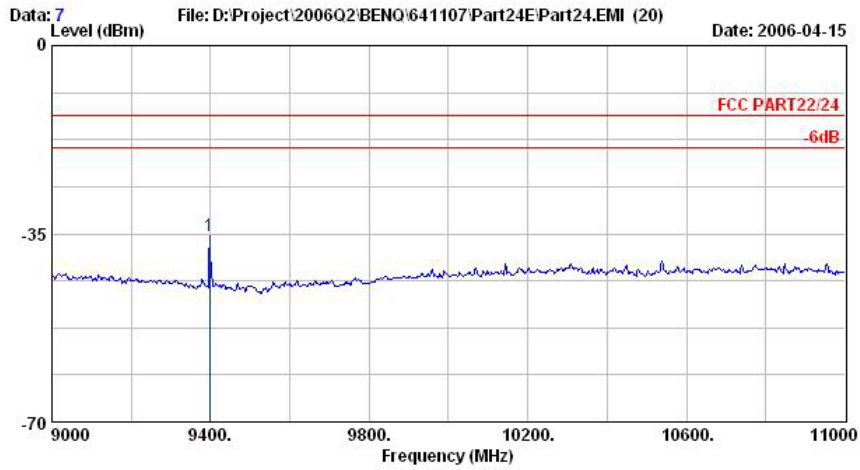

Site : 03CH06-HY  
 Condition : HF-SPURIOUS HORIZONTAL  
 EUT : GSM 850/1800/1900 Mobile Phone  
 Power : 120Vac/60Hz  
 Model : FG 641107  
 Memo : PCS1900 Link Mode;Ch189+Earphone+Adapter  
 Plane : E1

	Freq	Level	Over	Limit	Read		
	MHz	dBm	dB	dBm	dBm	dB	Remark
1 @	9398.00	-35.38	-22.38	-13.00	-53.60	18.22	Peak

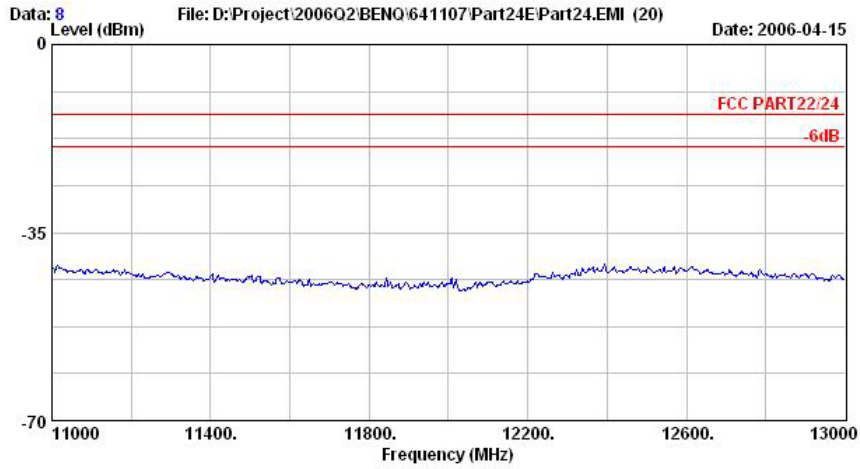

Site : 03CH06-HY  
 Condition : HF-SPURIOUS HORIZONTAL  
 EUT : GSM 850/1800/1900 Mobile Phone  
 Power : 120Vac/60Hz  
 Model : FG 641107  
 Memo : PCS1900 Link Mode;Ch189+Earphone+Adapter  
 Plane : E1

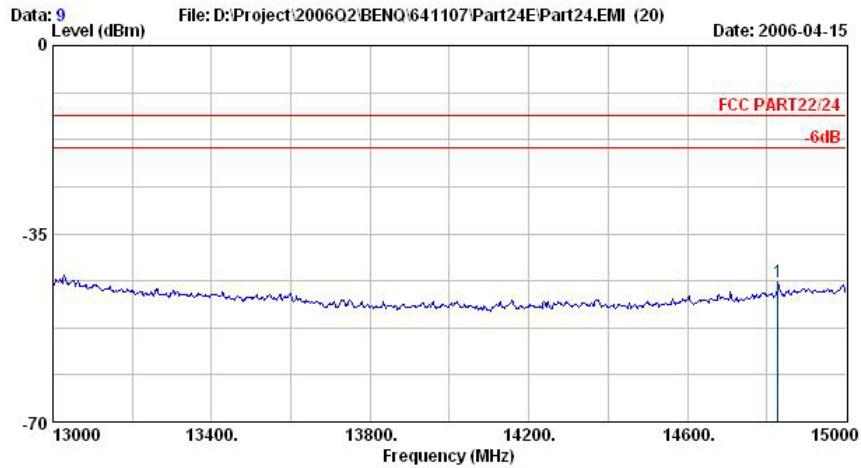

Site : 03CH06-HY  
 Condition : HF-SPURIOUS HORIZONTAL  
 EUT : GSM 850/1800/1900 Mobile Phone  
 Power : 120Vac/60Hz  
 Model : FG 641107  
 Memo : PCS1900 Link Mode;Ch189+Earphone+Adapter  
 Plane : E1

	Freq	Level	Over	Limit	Read		
	MHz	dBm	dB	dBm	dBm	dB	Remark
1 @	14828.00	-43.97	-30.97	-13.00	-61.16	17.19	Peak

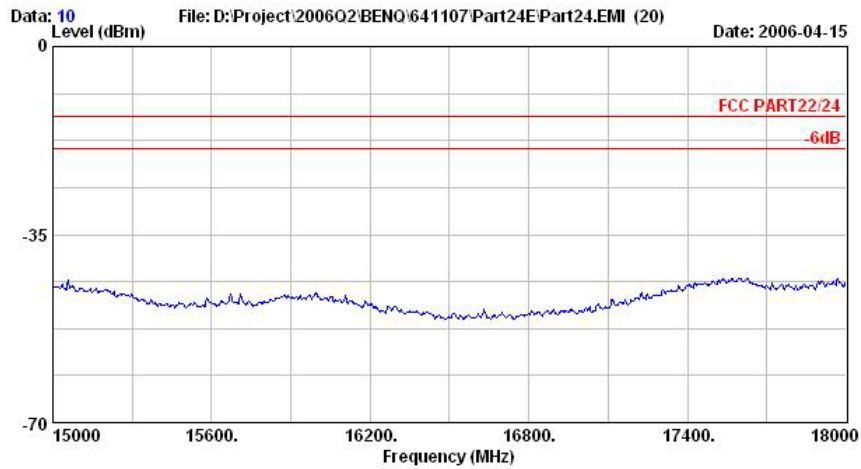

Site : 03CH06-HY  
 Condition : HF-SPURIOUS HORIZONTAL  
 EUT : GSM 850/1800/1900 Mobile Phone  
 Power : 120Vac/60Hz  
 Model : FG 641107  
 Memo : PCS1900 Link Mode;Ch189+Earphone+Adapter  
 Plane : E1



Vertical Polarization

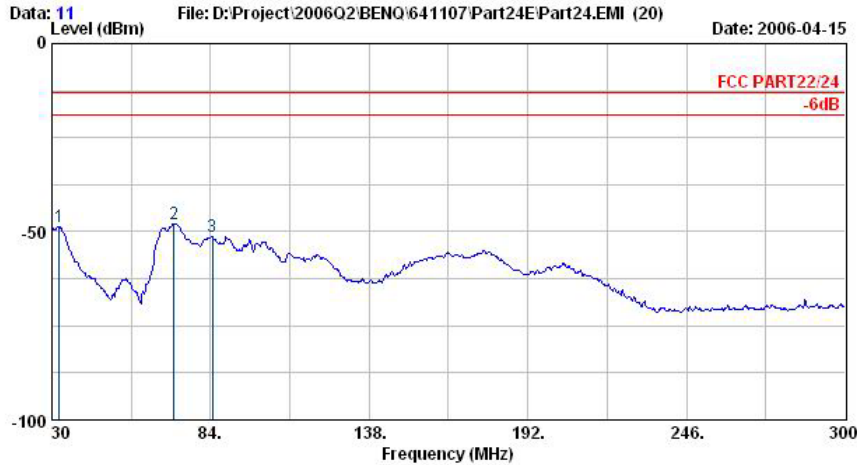

Site : 03CH06-HY  
 Condition : LF-SPURIOUS VERTICAL  
 EUT : GSM 850/1800/1900 Mobile Phone  
 Power : 120Vac/60Hz  
 Model : FG 641107  
 Memo : PCS1900 Link Mode;Ch189+Earphone+Adapter  
 Plane : E1

	Freq	Level	Over	Limit	Read	Factor	Remark
	MHz	dBm	dB	dBm	dBm	dB	
1 @	32.43	-48.66	-35.66	-13.00	-38.77	-9.89	Peak
2 @	71.58	-47.84	-34.84	-13.00	-36.09	-11.74	Peak
3 @	84.54	-51.22	-38.22	-13.00	-41.29	-9.93	Peak

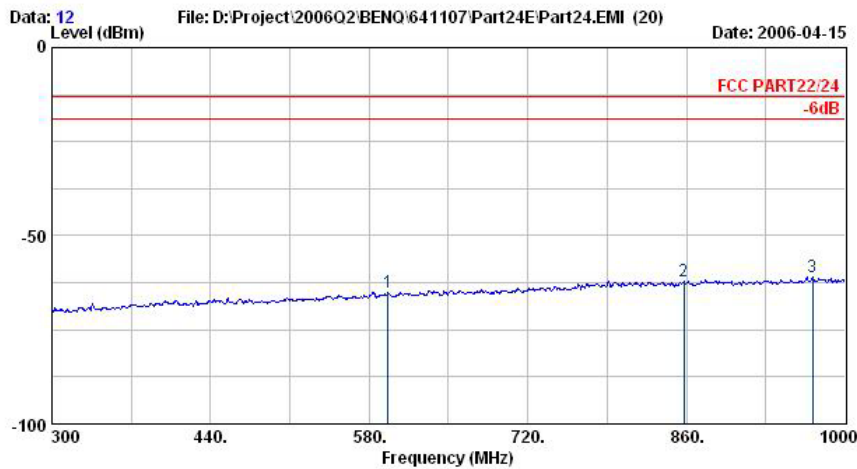

Site : 03CH06-HY  
 Condition : LF-SPURIOUS VERTICAL  
 EUT : GSM 850/1800/1900 Mobile Phone  
 Power : 120Vac/60Hz  
 Model : FG 641107  
 Memo : PCS1900 Link Mode;Ch189+Earphone+Adapter  
 Plane : E1

	Freq	Level	Over	Limit	Read	Factor	Remark
	MHz	dBm	dB	dBm	dBm	dB	
1 @	596.80	-64.93	-51.93	-13.00	-62.95	-1.98	Peak
2 @	857.90	-62.10	-49.10	-13.00	-63.63	1.53	Peak
3 @	971.30	-60.83	-47.83	-13.00	-63.26	2.43	Peak

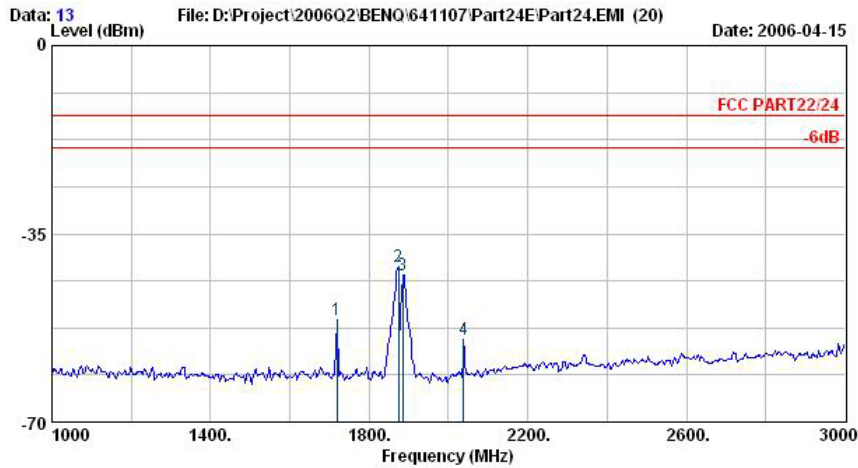

Site : 03CH06-HY  
 Condition : HF-SPURIOUS VERTICAL  
 EUT : GSM 850/1800/1900 Mobile Phone  
 Power : 120Vac/60Hz  
 Model : FG 641107  
 Memo : PCS1900 Link Mode;Ch189+Earphone+Adapter  
 Plane : E1

	Freq	Level	Over	Limit	Read		
	MHz	dBm	dB	dBm	dBm	dB	Remark
1 @	1718.00	-50.97	-37.97	-13.00	-50.55	-0.42	Peak
2 @	1874.00	-41.13			-40.73	-0.40	Peak
3 @	1884.00	-42.61			-42.11	-0.50	Peak
4 @	2038.00	-54.67	-41.67	-13.00	-54.63	-0.04	Peak

Remark:

- #2: MS TCH Signal.
- #3: BS TCH Signal.

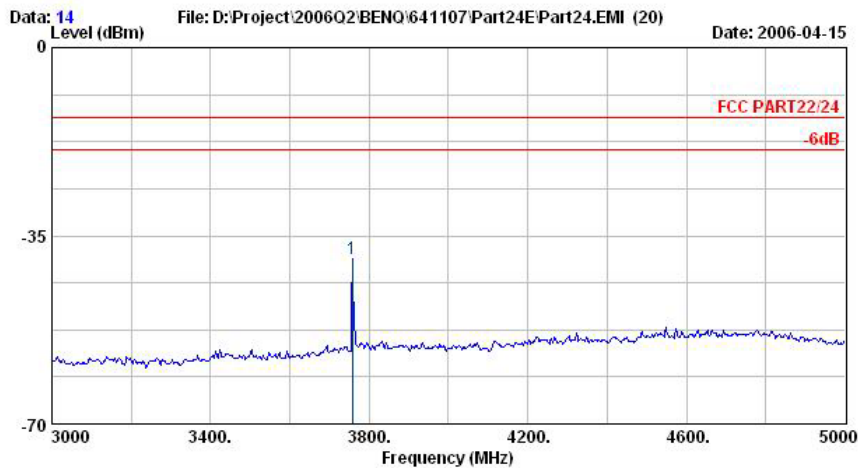

Site : 03CH06-HY  
 Condition : HF-SPURIOUS VERTICAL  
 EUT : GSM 850/1800/1900 Mobile Phone  
 Power : 120Vac/60Hz  
 Model : FG 641107  
 Memo : PCS1900 Link Mode;Ch189+Earphone+Adapter  
 Plane : E1

	Freq	Level	Over	Limit	Read		
	MHz	dBm	dB	dBm	dBm	dB	Remark
1 @	3758.00	-39.32	-26.32	-13.00	-45.95	6.64	Peak

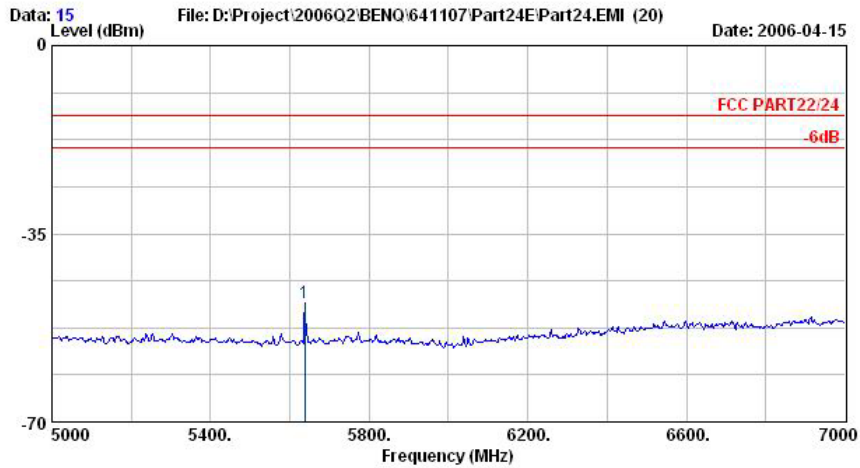

Site : 03CH06-HY  
 Condition : HF-SPURIOUS VERTICAL  
 EUT : GSM 850/1800/1900 Mobile Phone  
 Power : 120Vac/60Hz  
 Model : FG 641107  
 Memo : PCS1900 Link Mode,Ch189+Earphone+Adapter  
 Plane : E1

	Freq	Level	Over	Limit	Read	Factor	Remark
	MHz	dBm	dB	dBm	dBm	dB	
1 @	5638.00	-47.94	-34.94	-13.00	-56.60	8.65	Peak

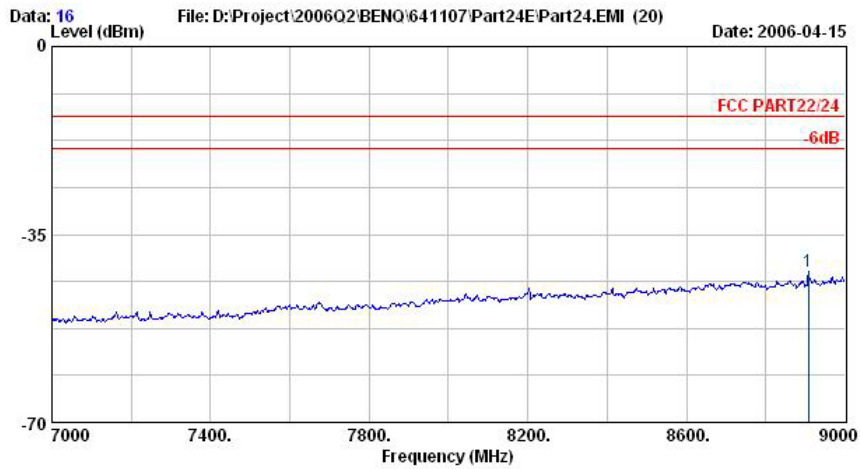

Site : 03CH06-HY  
 Condition : HF-SPURIOUS VERTICAL  
 EUT : GSM 850/1800/1900 Mobile Phone  
 Power : 120Vac/60Hz  
 Model : FG 641107  
 Memo : PCS1900 Link Mode,Ch189+Earphone+Adapter  
 Plane : E1

	Freq	Level	Over	Limit	Read	Factor	Remark
	MHz	dBm	dB	dBm	dBm	dB	
1 @	8908.00	-41.91	-28.91	-13.00	-61.10	19.19	Peak

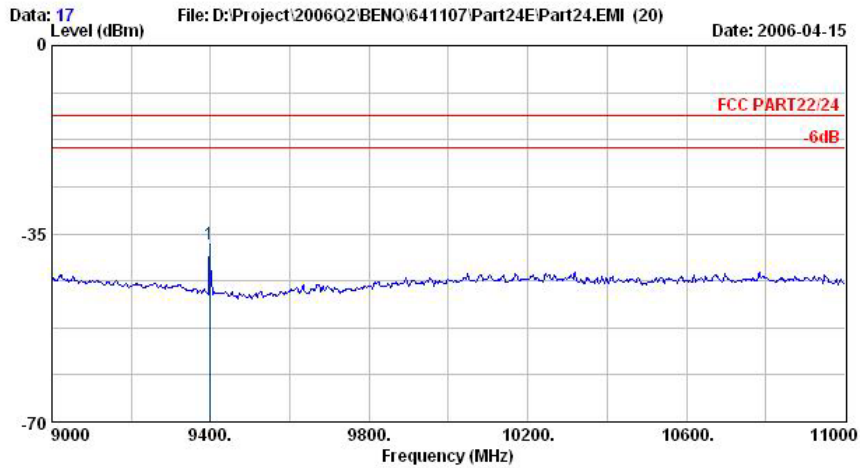

Site : 03CH06-HY  
 Condition : HF-SPURIOUS VERTICAL  
 EUT : GSM 850/1800/1900 Mobile Phone  
 Power : 120Vac/60Hz  
 Model : FG 641107  
 Memo : PCS1900 Link Mode;Ch189+Earphone+Adapter  
 Plane : E1

	Freq	Level	Over Limit	Limit Line	Read Level	Factor	Remark
	MHz	dBm	dB	dBm	dBm	dB	
1 @	9398.00	-37.07	-24.07	-13.00	-54.27	17.20	Peak

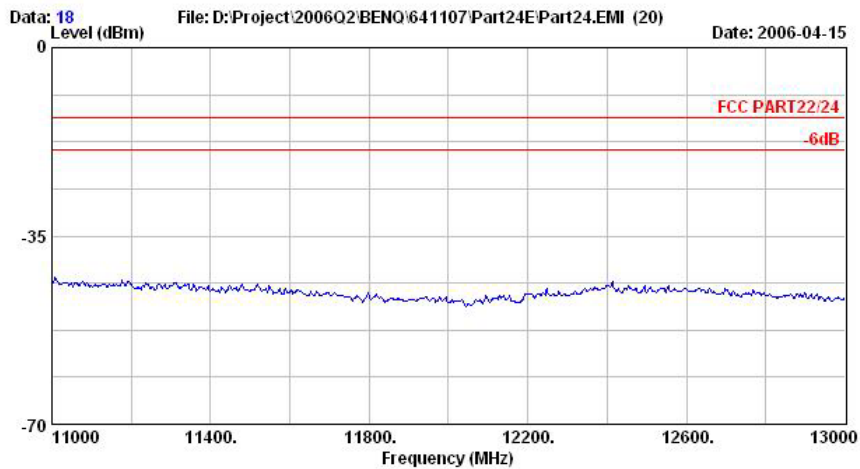

Site : 03CH06-HY  
 Condition : HF-SPURIOUS VERTICAL  
 EUT : GSM 850/1800/1900 Mobile Phone  
 Power : 120Vac/60Hz  
 Model : FG 641107  
 Memo : PCS1900 Link Mode;Ch189+Earphone+Adapter  
 Plane : E1



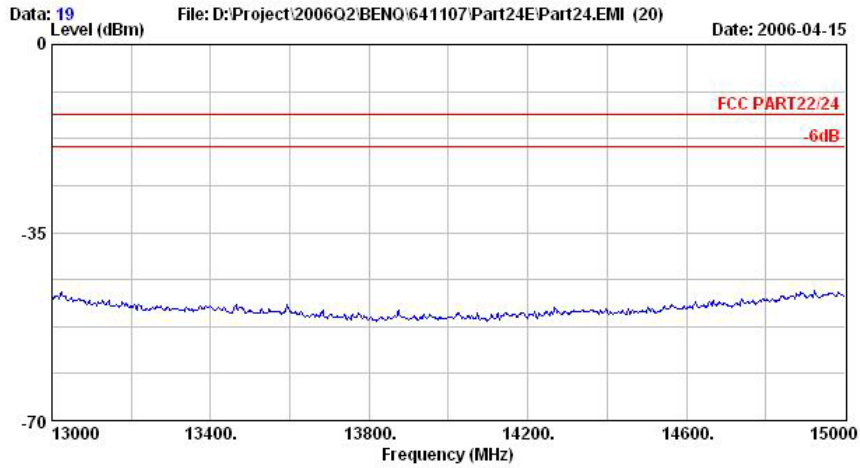

Site : 03CH06-HY  
Condition : HF-SPURIOUS VERTICAL  
EUT : GSM 850/1800/1900 Mobile Phone  
Power : 120Vac/60Hz  
Model : FG 641107  
Memo : PCS1900 Link Mode;Ch189+Earphone+Adapter  
Plane : E1

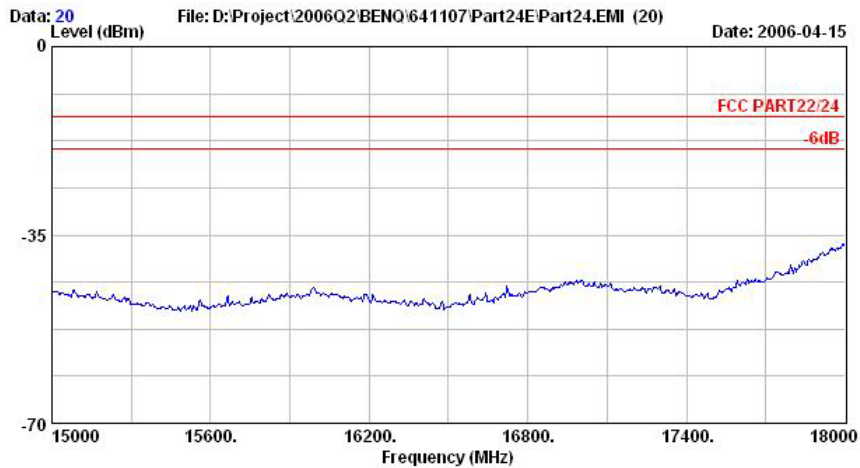

Site : 03CH06-HY  
Condition : HF-SPURIOUS VERTICAL  
EUT : GSM 850/1800/1900 Mobile Phone  
Power : 120Vac/60Hz  
Model : FG 641107  
Memo : PCS1900 Link Mode;Ch189+Earphone+Adapter  
Plane : E1

## 4.7 Frequency Stability (Temperature Variation)

### 4.7.1 Measurement Instrument

As described in chapter 5 of this test report.

### 4.7.2 Test Procedure

1. The EUT and test equipment were set up as shown on the following section.
2. With all power removed, the temperature was decreased to -30°C and permitted to stabilize for three hours. Power was applied and the maximum change in frequency was noted within one minute.
3. With power OFF, the temperature was raised in 10°C steps. The sample was permitted to stabilize at each step for at least one-half hour. Power was applied and the maximum frequency change was noted within one minute.
4. The temperature tests were performed for the worst case.
5. Test data was recorded.

### 4.7.3 Test Setup Layout

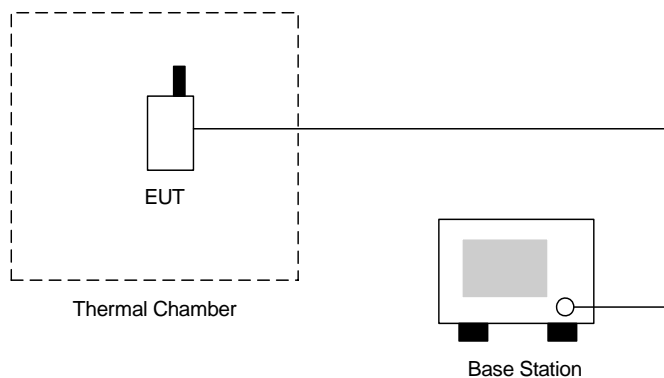



4.7.4 Test Result

▪ Test Mode : GSM 850 CH189

Temperature(°C)	Change (Hz)	Change (ppm)	Limit (ppm)	Result
-30	X	X	2.5	Passed
-20	64	0.03		
-10	58	0.03		
0	52	0.03		
10	50	0.03		
20	54	0.03		
30	60	0.03		
40	62	0.03		
50	66	0.03		

▪ Test Mode : PCS 1900 CH661

Temperature(°C)	Change (Hz)	Change (ppm)	Limit (ppm)	Result
-30	X	X	2.5	Passed
-20	188	0.10		
-10	172	0.09		
0	168	0.09		
10	148	0.08		
20	134	0.07		
30	120	0.06		
40	124	0.07		
50	129	0.07		

Remark: The EUT can not be turned on at temperature -30°C.

### 4.8 Frequency Stability (Voltage Variation)

#### 4.8.1 Measurement Instrument

As described in chapter 5 of this test report.

#### 4.8.2 Test Procedure

1. The EUT was placed in a temperature chamber at  $25\pm 5^{\circ}\text{C}$  and connected as the following section.
2. The power supply voltage to the EUT was varied from BEP to 115% of the nominal value measured at the input to the EUT.
3. The variation in frequency was measured for the worst case.

#### 4.8.3 Test Setup Layout

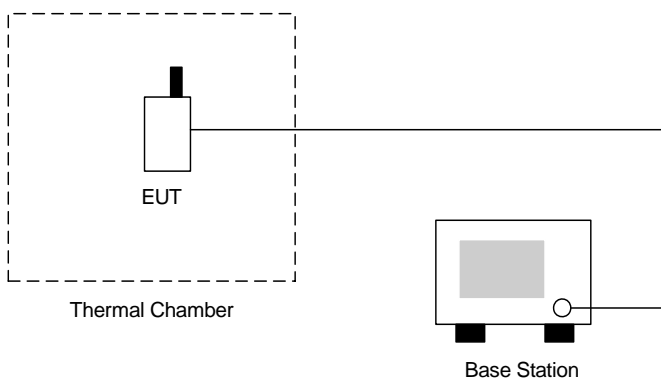

#### 4.8.4 Test Result

- Test Mode : GSM 850 CH189

Voltage(Volt)	Change (Hz)	Change (ppm)	Limit (ppm)	Result
3.7	56.0	0.03	2.5	Passed
BEP	51.0	0.03		
4.3	49.0	0.03		

- Test Mode : PCS 1900 CH661

Voltage(Volt)	Change (Hz)	Change (ppm)	Limit (ppm)	Result
3.7	84	0.04	2.5	Passed
BEP	78	0.04		
4.3	85	0.04		

Remark:

1. Normal Voltage=3.7V.
2. Battery End Point (BEP)=3.3V.



## 5 List of Measurement Equipments

Instrument	Manufacturer	Model No.	Serial No.	Characteristics	Calibration Date	Due Date	Remark
Spectrum analyzer	Agilent	E4408B	MY44211030	9KHz-26.5GHz	Jul. 25, 2005	Jul. 24, 2006	Radiation (03CH06-HY)
Receiver	R&S	ESCS30	100356	9KHz-2.75GHz	Jun. 28, 2005	Jun. 27, 2006	Radiation (03CH06-HY)
Controller	CT	SC100	N/A	N/A	N/A	N/A	Radiation (03CH06-HY)
Bilog Antenna	SCHAFFNER	CBL6112B	2885	30MHz -2GHz	Nov. 22, 2004	Nov. 22, 2006	Radiation (03CH06-HY)
Horn Antenna	Com-Power	AH118	071025	1G-18G	Feb. 22, 2006	Feb. 22, 2007	Radiation (03CH06-HY)
SHF-EHF Horn	SCHWARZBECK	BBHA 9170	9170-249	14G - 40G	Jul. 21, 2005	Jul. 20, 2006	Radiation (03CH06-HY)
HF Amplifier	MITEQ	AFS44	973248	0.1G - 26.5G	Dec. 17, 2004	Dec. 17, 2005	Radiation (03CH06-HY)
Amplifier	MITEQ	AMF-6F	997165	26G - 40G	Jul. 21, 2005	Jul. 20, 2006	Radiation (03CH06-HY)
Turn Table	HD	DS 420	420/650/00	0 ~ 360 degree	N/A	N/A	Radiation (03CH06-HY)
Antenna Mast	HD	MA 240	240/560/00	1 m - 4 m	N/A	N/A	Radiation (03CH06-HY)



## 6 Uncertainty Evaluation

### Uncertainty of Radiated Emission Measurement (30MHz ~ 1000MHz)

Contribution	Uncertainty of $x_i$		$u(x_i)$
	dB	Probability Distribution	
Receiver reading	0.41	Normal(k=2)	0.21
Antenna factor calibration	0.83	Normal(k=2)	0.42
Cable loss calibration	0.25	Normal(k=2)	0.13
Pre Amplifier Gain calibration	0.27	Normal(k=2)	0.14
RCV/SPA specification	2.50	Rectangular	0.72
Antenna Factor Interpolation for Frequency	1.00	Rectangular	0.29
Site imperfection	1.43	Rectangular	0.83
Mismatch	+0.39/-0.41	U-shaped	0.28
<b>combined standard uncertainty Uc(y)</b>	<b>1.27</b>		
<b>Measuring uncertainty for a level of confidence of 95% U=2Uc(y)</b>	<b>2.54</b>		

### Uncertainty of Radiated Emission Measurement (1GHz ~ 40GHz)

Contribution	Uncertainty of $x_i$		$u(x_i)$	$C_i$	$C_i * u(x_i)$
	dB	Probability Distribution			
Receiver reading	±0.10	Normal(k=1)	0.10	1	0.10
Antenna factor calibration	±1.70	Normal(k=2)	0.85	1	0.85
Cable loss calibration	±0.50	Normal(k=2)	0.25	1	0.25
Receiver Correction	±2.00	Rectangular	1.15	1	1.15
Antenna Factor Directional	±1.50	Rectangular	0.87	1	0.87
Site imperfection	±2.80	Triangular	1.14	1	1.14
Mismatch Receiver VSWR $\Gamma_1 = 0.197$ Antenna VSWR $\Gamma_2 = 0.194$ Uncertainty = $20 \log(1 - \Gamma_1 * \Gamma_2 * \Gamma_3)$	+0.34/-0.35	U-shaped	0.244	1	0.244
<b>Combined standard uncertainty Uc(y)</b>	<b>2.36</b>				
<b>Measuring uncertainty for a level of confidence of 95% U=2Ue(y)</b>	<b>4.72</b>				

END OF TEST REPORT