



FCC TEST REPORT

for

47 CFR Part 24E

Equipment : GSM900/DCS1800/PCS1900 Tri Band Mobile Phone
Trade Name : BenQ-Siemens
Model No. : E61
FCC ID : JVPE61
BenQ Ref. No. : KH-5823
Tx Frequency Range : PCS 1900: 1850.2~1909.8MHz
Max. EIRP Power : PCS 1900: 0.41W
Emission Designator : 300 KGXW
Applicant : BenQ Corporation
157 Shan-Ying Road, Gueishan Taoyuan 333, Taiwan

- The test result refers exclusively to the test presented test model / sample.
- Without written approval of SPORTON International Inc., the test report shall not be reproduced except in full.
- **Certificate or Test Report must not be used by the applicant to claim the product in this test report endorsed by NVLAP or any agency of U.S. government.**
- The data shown in this test report were carried out on Feb. 6, 2006 at **Sporton International Inc. LAB.**
- Report No.: FG611611, Report Version: Rev. 01

Dr. Daniel Lee
EMC/SAR Director

SPORTON International Inc.

6F, No.106, Sec. 1, Hsin Tai Wu Rd., Hsi Chih, Taipei Hsien, Taiwan, R.O.C.

SPORTON International Inc.

TEL : 886-2-2696-2468

FAX : 886-2-2696-2255

Report Version: Rev. 01



Table of Contents

History of this test report.....ii

1. General Information 1

 1.1. Applicant 1

 1.2. Manufacturer 1

 1.3. Basic Description of Equipment under Test 1

 1.2 Feature of Equipment under Test 2

 1.3 Report Date 2

2 Test Configuration of Equipment under Test 3

 2.1 Test Manner 3

 2.2 Test Mode 3

 2.3 Connection Diagram of Test System 3

 2.4 Ancillary Equipment List 3

3. General Information of Test Site 4

 3.1 Test Voltage 4

 3.2 Test in Compliance with 4

 3.3 Frequency Range Investigated 4

 3.4 Test Distance 4

4. Test Data and Test Result..... 5

 4.1 List of Measurements and Examinations 5

 4.2 RF Output Power 6

 4.3 ERP / EIRP Measurement 7

 4.4 Occupied Bandwidth and Band Edge Measurement 9

 4.5 Conducted Emission 14

 4.6 Field Strength of Spurious Radiation 20

 4.7 Frequency Stability (Temperature Variation) 32

 4.8 Frequency Stability (Voltage Variation) 34

5 List of Measurement Equipments 35

6 Uncertainty Evaluation 36

Appendix A. Photographs of EUT External

Appendix B. Photographs of EUT Internal

Appendix C. Photographs of Setup



1. General Information

1.1. Applicant

BenQ Corporation

157 Shan-Ying Road, Gueishan Taoyuan 333, Taiwan

1.2. Manufacturer

1. BenQ Corporation

157 Shan-Ying Road, Gueishan Taoyuan 333, Taiwan

2. BenQ (IT) Co., Ltd.

No. 169, Zhujiang Road, New District, Suzhou, Jiangsu, P.R., China

1.3. Basic Description of Equipment under Test

Equipment	: GSM900/DCS1800/PCS1900 Tri Band Mobile Phone
Trade Name	: BenQ-Siemens
Model No.	: E61
Power Supply Type	: Switching, From battery 3.7V
AC Power Cord	: AC 120V, Wall-mount, 1.8 meter, 2 pin
Battery	: BenQ-Siemens, 2C.2G0K0.XXX (X=0-9 or A-Z or Black)
Adapter	: BenQ-Siemens, JSP054070UU
Earphone	: 2C.43037.111
Date Cable	: 5K.G6501.001



1.2 Feature of Equipment under Test

DUT Type :	GSM900/DCS1800/PCS1900 Tri Band Mobile Phone
Trade Name :	BenQ-Siemens
Model Name :	E61
FCC ID :	JVPE61
Tx Frequency :	1850.2-1909.8 MHz.
Rx Frequency :	1930.2-1989.8 MHz
Antenna Type :	Fixed Internal
IMEI Code :	358580000002484
Maximum Output Power to Antenna :	PCS: 30.34 dBm
Maximum EIRP :	0.41 W (26.16 dBm)
HW Version :	LPR4
SW Version :	V0.11
Power Rating (DC/AC Voltage) :	3.7V / 174.1mA
Digital Modulation Emission :	GMSK
Type of Emission :	300 KGXW
DUT Stage :	Identical Prototype

1.3 Report Date

EUT Received : Jan. 16, 2006

Report Date : Feb. 22, 2006

2 Test Configuration of Equipment under Test

2.1 Test Manner

- a. The spurious emission measurements were carried out in semi-anechoic chamber with 3-meter test range.
- b. During all testings, EUT is in link mode with base station emulator at maximum power level. (PCL=0 for PCS 1900)
- c. Frequency range investigated: radiated emission 30MHz to 18000 MHz for PCS 1900.

2.2 Test Mode

Application	PCS 1900
Radiated Emission	<input checked="" type="checkbox"/> Mode 1: PCS 1900 Link Mode_CH 661
Conducted Measurement	<input checked="" type="checkbox"/> Mode 1: PCS 1900 Link Mode_CH 661

2.3 Connection Diagram of Test System

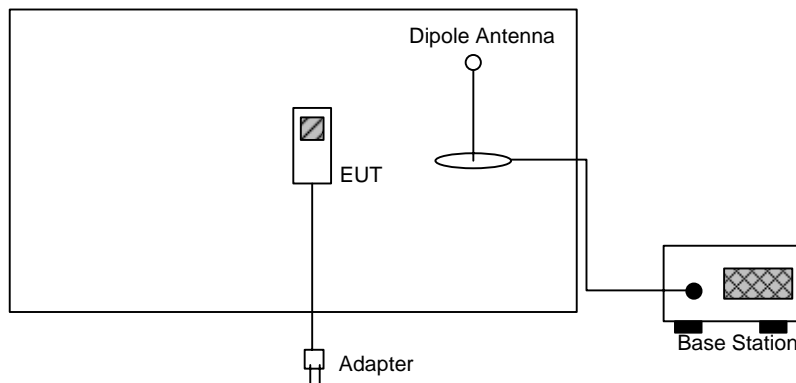

2.4 Ancillary Equipment List

Item	Equipment	Trade Name	Model No.	Power Cord
1.	Base Station	R & S	CMU200	N/A



3. General Information of Test Site

Test Site Location : No. 52, Hwa Ya 1st Rd., Hwa Ya Technology Park,
Kwei-Shan Hsiang, Tao Yuan Hsien, Taiwan, R.O.C.
TEL : 886-3-327-3456
FAX : 886-3-318-0055
Test Site No : 03CH06-HY

The chamber meets the characteristics of ANSI C63.4-2003. This site is on file with the FCC. The Industry Canada file number for this site is IC 4088.

3.1 Test Voltage

120V / 60Hz

3.2 Test in Compliance with

47 CFR Part 24E

3.3 Frequency Range Investigated

a. Radiation: from 30 MHz to 19000 MHz for PCS 1900.

3.4 Test Distance

The test distance of radiated emission from antenna to EUT is 3 m.



4. Test Data and Test Result

4.1 List of Measurements and Examinations

FCC Rule	DESCRIPTION OF TEST	Result	Section
§2.1046	RF Output Power	Passed	4.2
§24.232	ERP / EIRP	Passed	4.3
§2.1049, § 24.238(b)	Occupied Bandwidth & Band Edge Measurement	Passed	4.4
§2.1051	Conducted Emission	Passed	4.5
§2.1053	Field Strength of Spurious Radiation	Passed	4.6
§2.1055, §24.235	Frequency Stability vs. Temperature	Passed	4.7
§2.1055, §24.235	Frequency Stability vs. Voltage	Passed	4.8

4.2 RF Output Power

4.2.1 Measurement Instruments :

As described in chapter 5 of this test report.

4.2.2 Test Procedure :

1. The transmitter output was connected to power meter and base station through power divider.
2. Set EUT at PCL=0 for PCS 1900 through base station.
3. Select lowest, middle, and highest channels for each band.

4.2.3 Test Setup Layout :

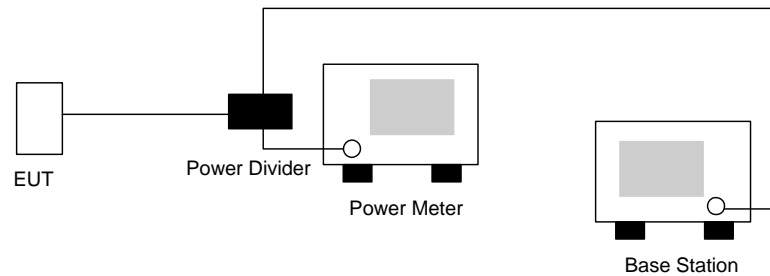

4.2.4 Test Result :

Bands	Channel	Frequency (MHz)	Conducted Power (dBm)	Conducted Power (Watts)
PCS 1900	512	1850.2 (Low)	30.29	1.069
	661	1880.0 (Mid)	30.34	1.081
	810	1909.8 (High)	30.29	1.069



4.3 ERP / EIRP Measurement

Equivalent isotropic radiated power measurements by substitution method according to ANSI/TIA/EIA-603-A.

4.3.1 Measurement Instruments

As described in chapter 5 of this test report.

4.3.2 Test Procedure

1. The EUT was placed on a rotatable table with 1.0 meter height in an fully anechoic chamber.
2. The EUT was set 1.2 meters from the receiving antenna which was mounted on the antenna tower.
3. The table was rotated 360 degrees to determine the position of the highest radiated power.
4. The height of the receiving antenna is also kept at 1.0M height.
5. Taking the record of maximum ERP/EIRP.
6. A dipole antenna was substituted in place of the EUT and was driven by a signal generator.
7. The conducted power at the terminal of the dipole antenna is measured.
8. Repeat step 3 to step 5 to get the maximum ERP/EIRP of the substitution antenna.
9. $ERP/EIRP = P_s + E_t - E_s + G_s = P_s + R_t - R_s + G_s$

P_s (dBm): Input power to substitution antenna.

G_s (dBi or dBd): Substitution antenna Gain.

$E_t = R_t + AF$

$E_s + R_s + AF$

AF (dB/m): Receive antenna factor

10. R_t : the highest received signal in Spectrum Analyzer for EUT.

4.3.3 Test Setup Layout of ERP/EIRP

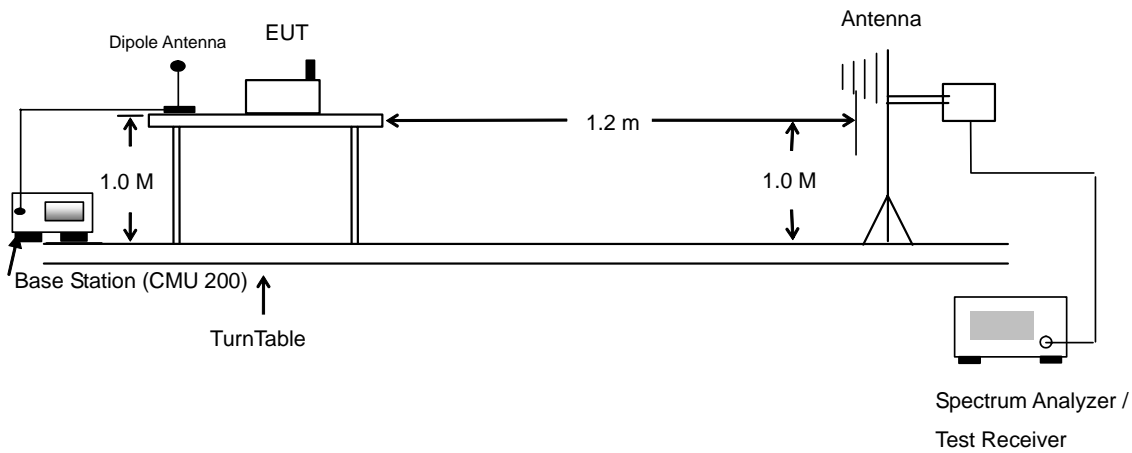

4.3.4 Test Result

PCS1900 Radiated Power EIRP					
H Polarization			V Polarization		
Frequency (MHz)	EIRP (dBm)	EIRP (Watts)	Frequency (MHz)	EIRP (dBm)	EIRP (Watts)
1850.20	24.57	0.29	1850.20	26.16	0.41
1880.00	24.32	0.27	1880.00	25.24	0.33
1909.80	22.45	0.18	1909.80	22.69	0.19

4.4 Occupied Bandwidth and Band Edge Measurement

4.4.1 Measurement Instruments

As described in chapter 5 of this test report.

4.4.2 Test Procedure

1. The EUT was connected to Spectrum Analyzer and Base Station via power divider.
2. The occupied bandwidth of middle channel for the highest and lowest RF powers were measured.
3. The bandedge of low and high channels for the highest RF powers within the transmitting frequency band were measured. Setting RBW as roughly $BW/100$.

4.4.3 Test Setup Layout

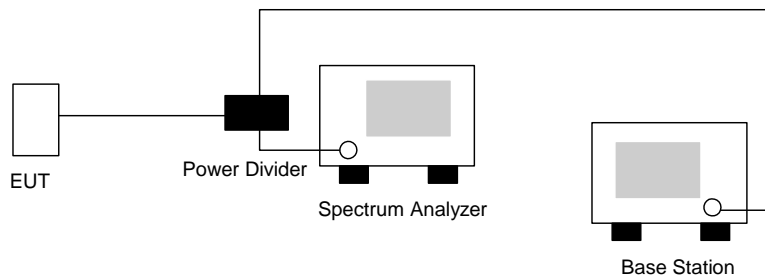



4.4.4 Test Result

- Test Mode : PCS 1900 CH512 Lower Band Edge
- Power State : High

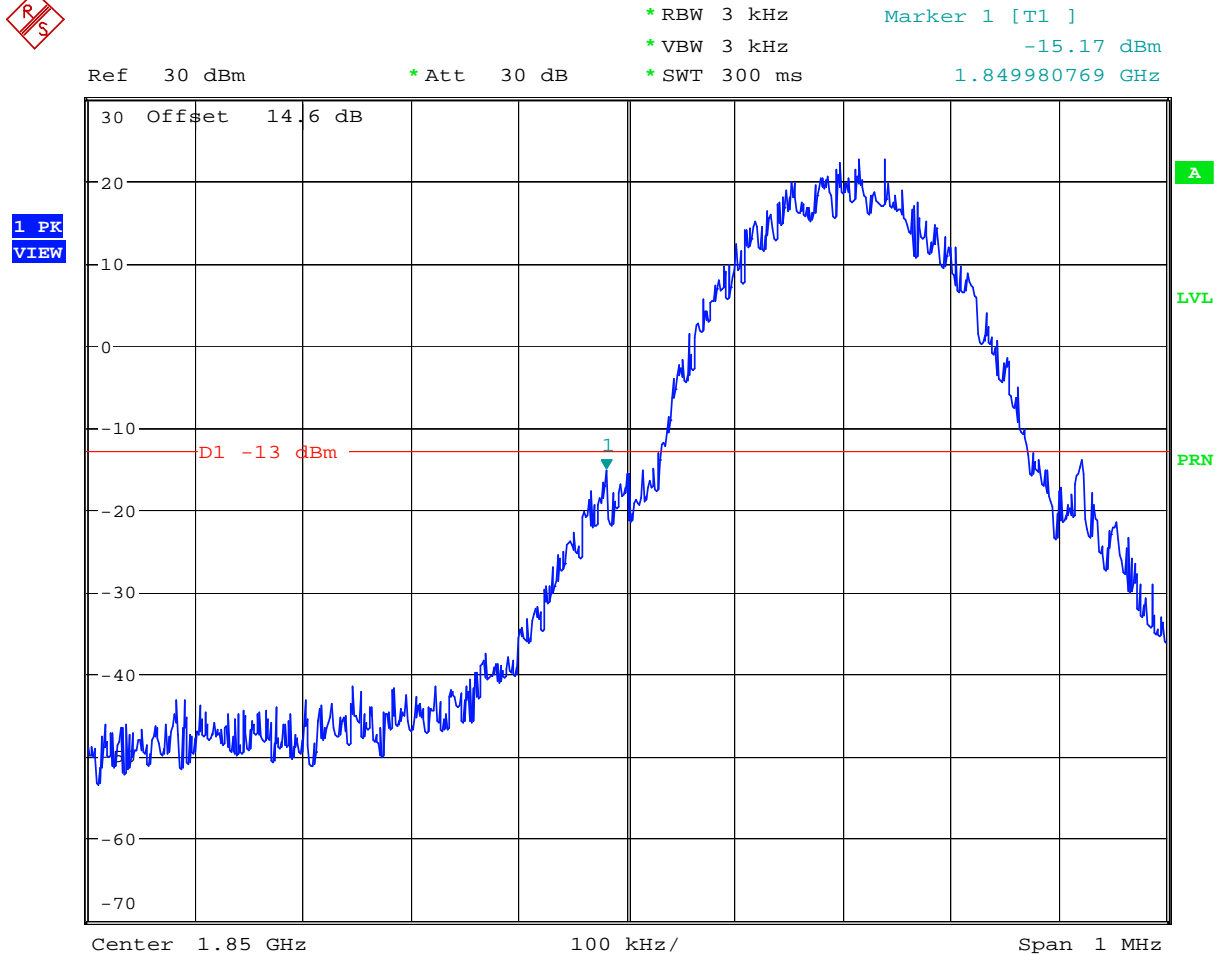

Date: 21.JAN.2006 20:15:17



- Test Mode : PCS 1900 CH661 99% Occupied Bandwidth
- Power State : Low

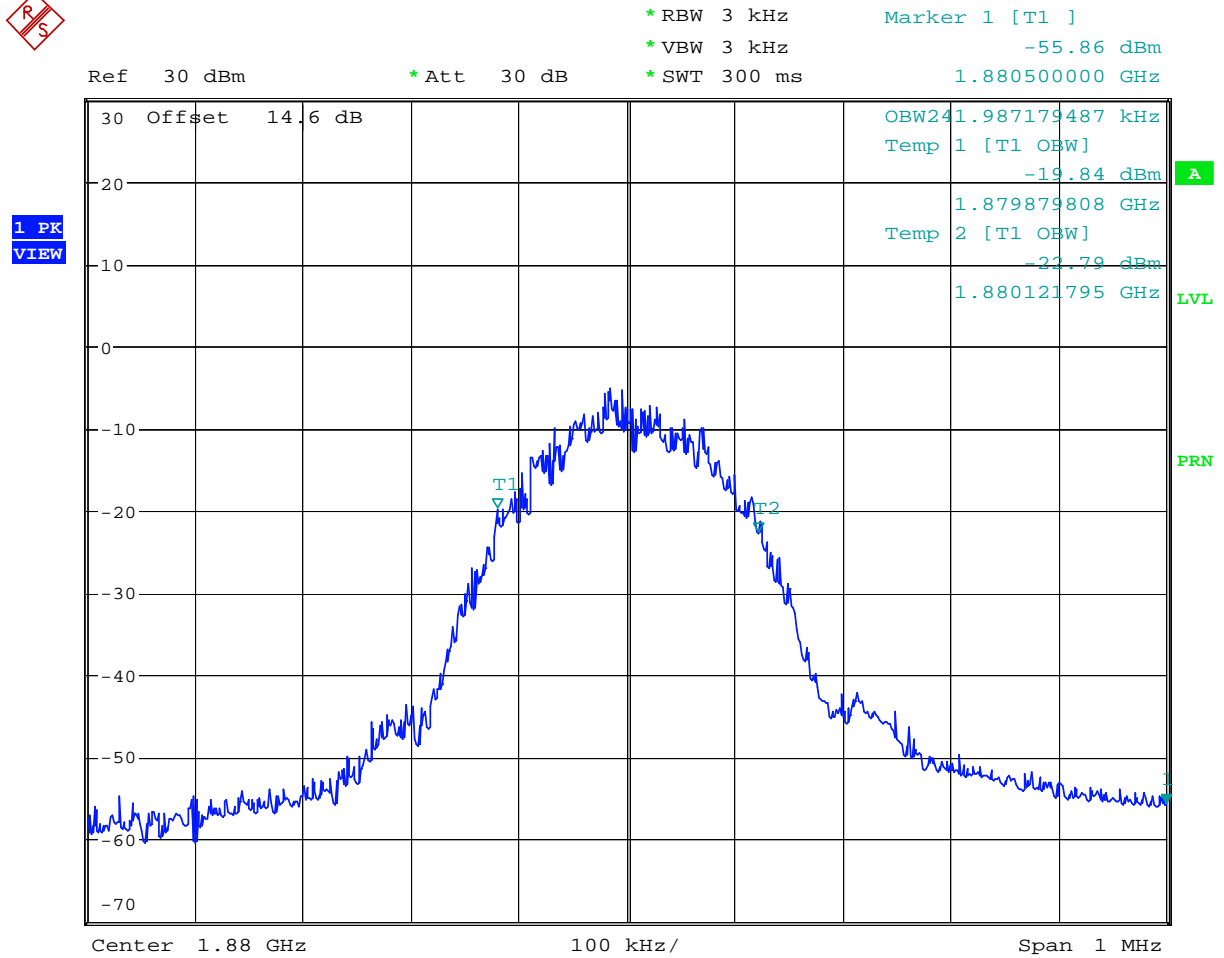

Date: 21.JAN.2006 20:14:21



- Test Mode : PCS 1900 CH661 99% Occupied Bandwidth
- Power State : High

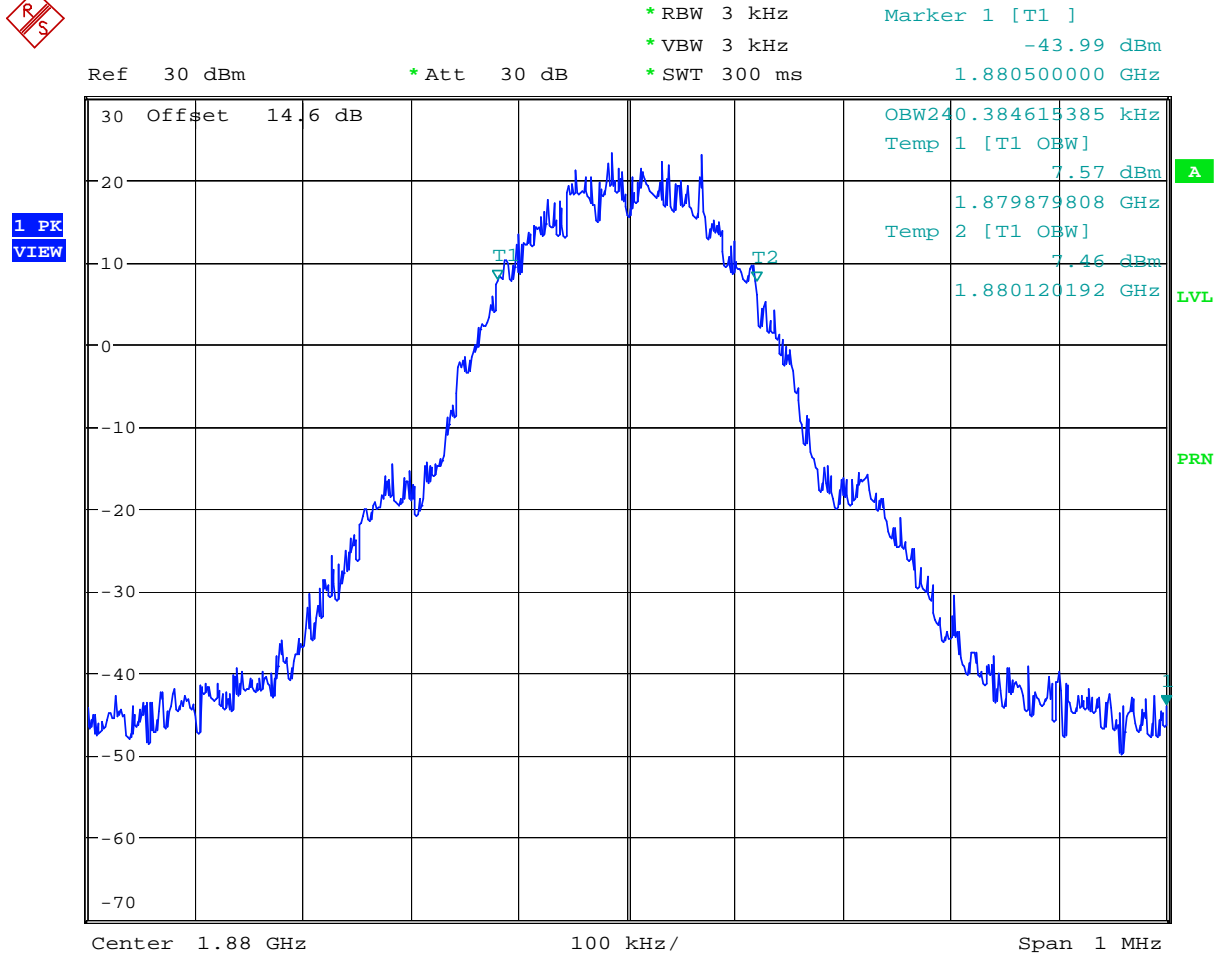

Date: 21.JAN.2006 20:12:12

4.5 Conducted Emission

4.5.1 Measurement Instruments

As described in chapter 5 of this test report.

4.5.2 Test Procedure

1. The EUT was connected to Spectrum Analyzer and Base Station via power divider.
2. The middle channel for the highest RF power within the transmitting frequency was measured.
3. The conducted spurious emission for the whole frequency range was taken.

4.5.3 Test Setup Layout

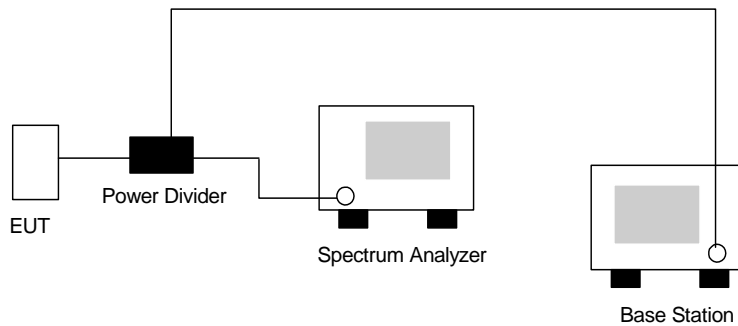



4.5.4 Test Result

- Test Mode : PCS 1900 CH661
- Frequency Range : 0.3G-1G



* RBW 1 MHz Marker 1 [T1]
 * VBW 3 MHz -23.20 dBm
 * SWT 500 ms 39.326923077 MHz

Ref 30 dBm * Att 30 dB

1 PK
VIEW

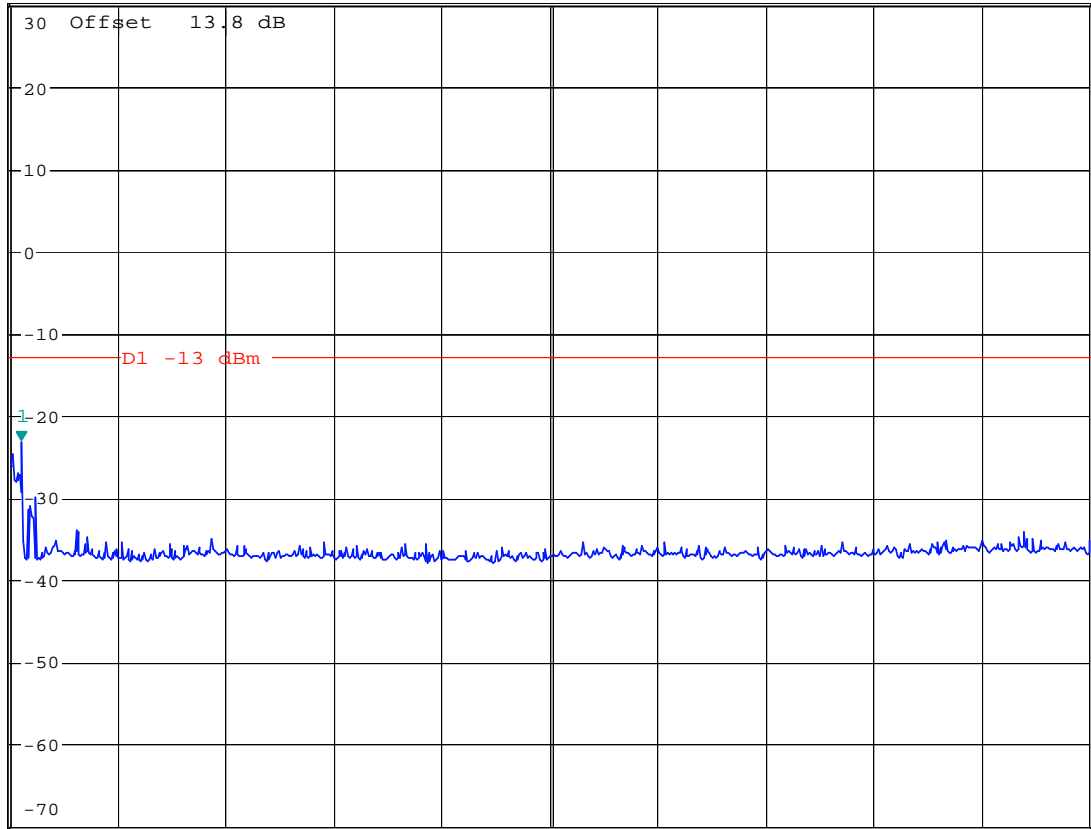

Start 30 MHz 97 MHz/ Stop 1 GHz

Date: 21.JAN.2006 20:20:18



- Test Mode : PCS 1900 CH661
- Frequency Range : 1G-3G

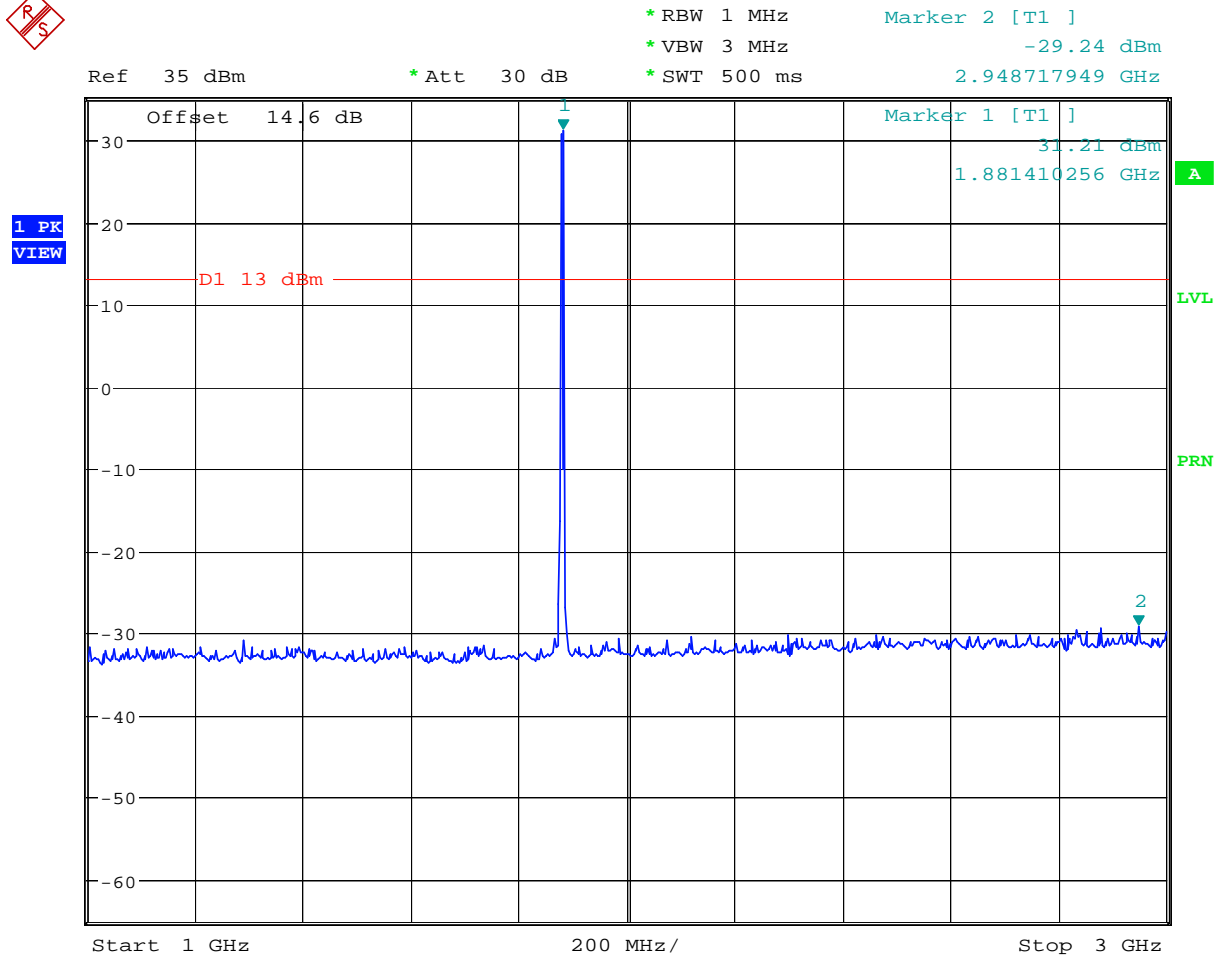

Date: 21.JAN.2006 20:21:35



- Test Mode : PCS 1900 CH661
- Frequency Range : 3G-7G

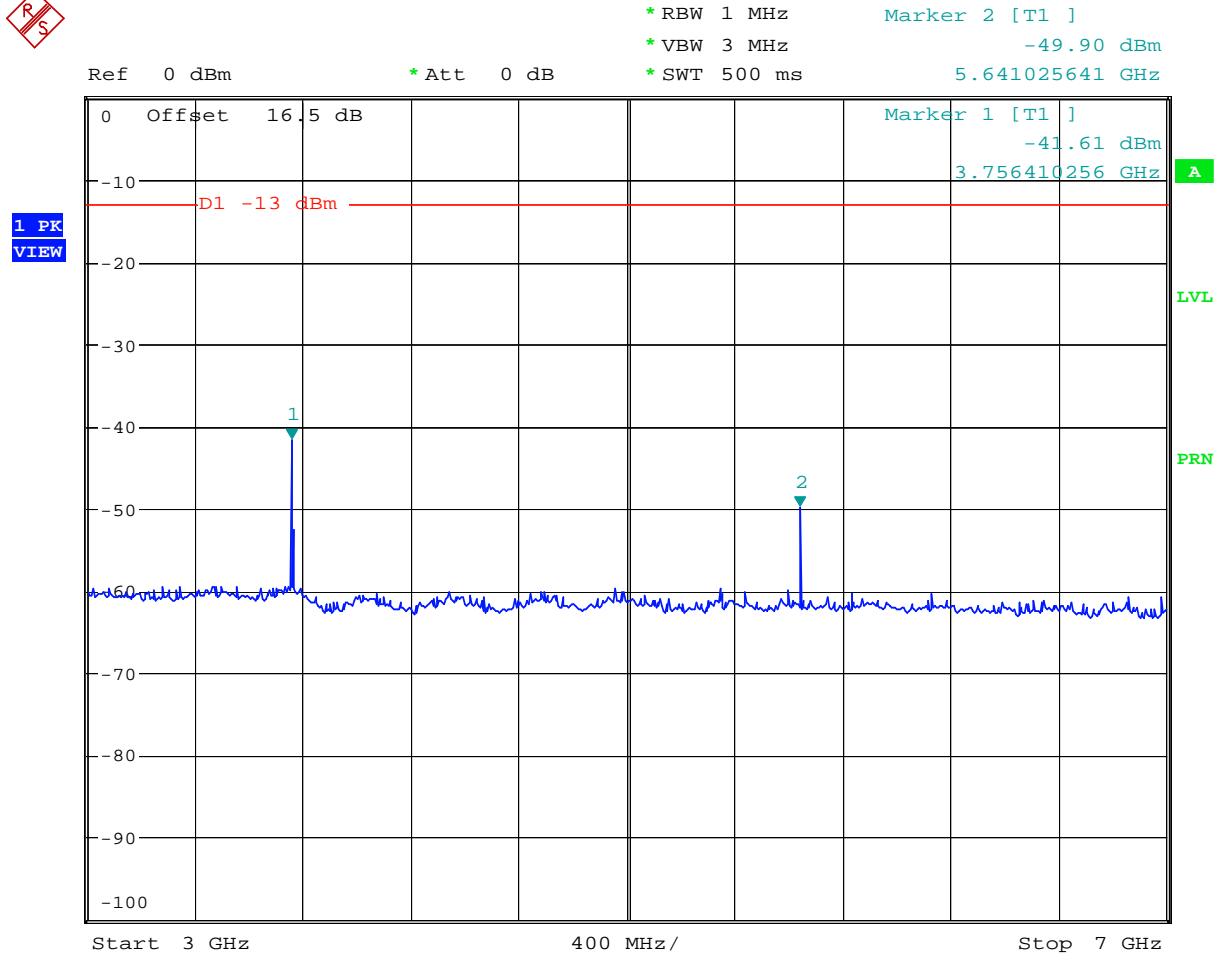

Date: 21.JAN.2006 20:23:37



- Test Mode : PCS 1900 CH661
- Frequency Range : 7G-13.6G

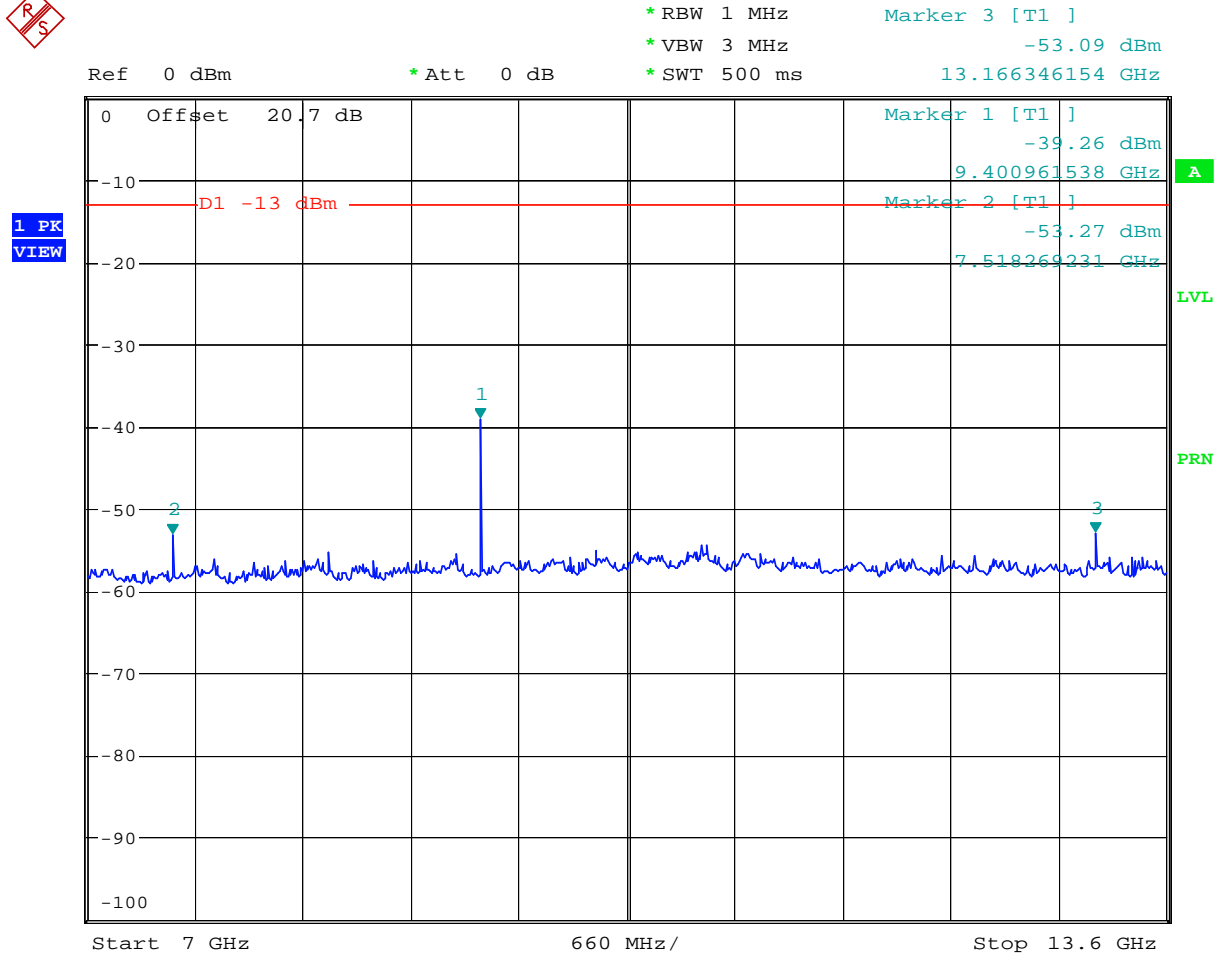

Date: 21.JAN.2006 20:25:20



- Test Mode : PCS 1900 CH661
- Frequency Range : 13.6G-19.1G



Ref 0 dBm *Att 0 dB *RBW 1 MHz Marker 1 [T1]
 *VBW 3 MHz -41.32 dBm
 *SWT 500 ms 16.922916667 GHz

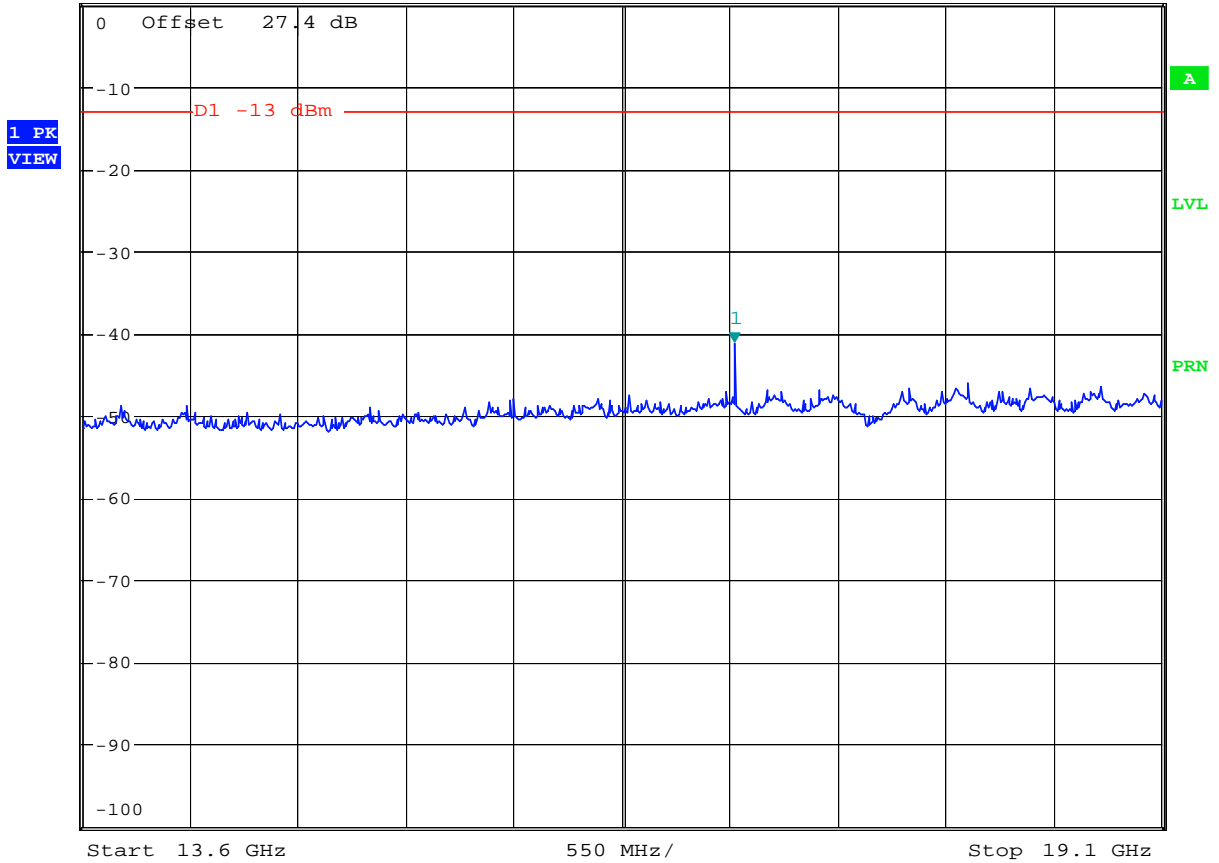

Date: 21.JAN.2006 20:26:31

4.6 Field Strength of Spurious Radiation

Equivalent isotropic radiated Power Measurements by substitution method according to ANSI/TIA/EIA-603-A.

4.6.1 Measurement Instruments

As described in chapter 5 of this test report.

4.6.2 Test Procedure

1. The EUT was placed on a rotatable wooden table with 0.8 meter about ground.
2. The EUT was set 3 meters from the receiving antenna which was mounted on the antenna tower.
3. The table was rotated 360 degrees to determine the position of the highest spurious emission.
4. The height of the receiving antenna is varied between one meter and four meters to reach the maximum spurious emission for both horizontal and vertical polarizations.
5. Taking the record of maximum spurious emission.
6. A Horn antenna was substituted in place of the EUT and was driven by a signal generator.
7. Tune the output power of signal generator to the same emission level with EUT maximum spurious emission.
8. Taking the record of output power at antenna port.
9. Repeat step 7 to step 8 for another polarization.
10. Emission level (dBm) = output power + substitution Gain.

4.6.3 Test Setup Layout

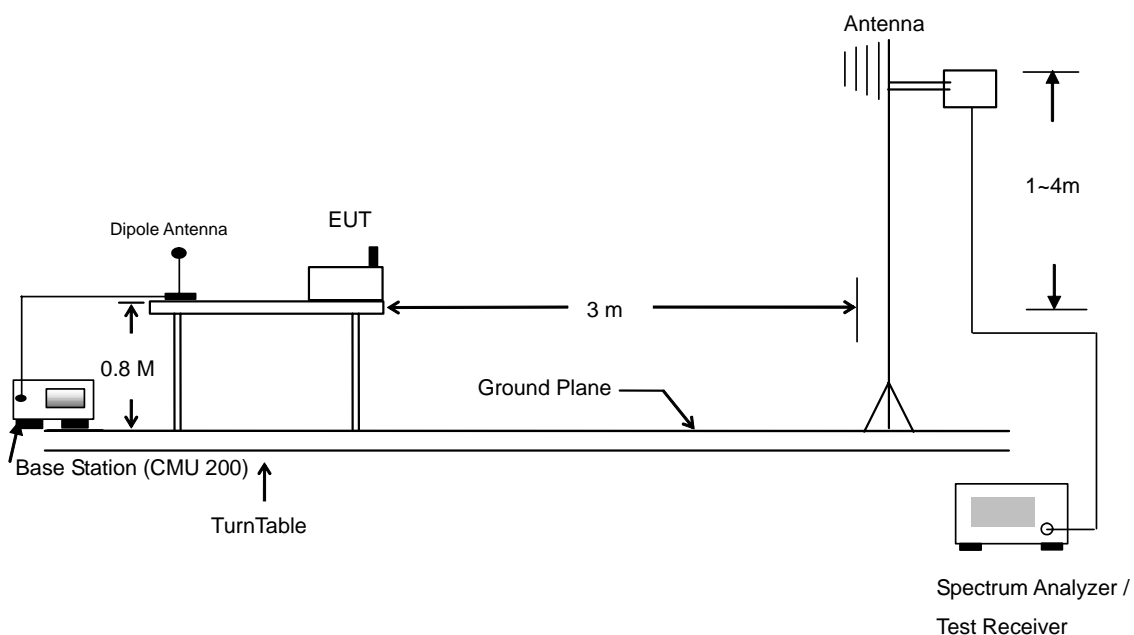



4.6.4 Test Result

- Test Mode : Mode 1

PCS1900 Radiated Spurious EIRP							
H Polarization				V Polarization			
Frequency (MHz)	EIRP (dBm)	Limit (dBm)	Margin (dB)	Frequency (MHz)	EIRP (dBm)	Limit (dBm)	Margin (dB)
98.580	-47.840	-13	-34.84	36.480	-44.250	-13	-31.25
129.090	-52.310	-13	-39.31	45.390	-46.690	-13	-33.69
185.790	-50.500	-13	-37.50	97.230	-45.330	-13	-32.33
843.900	-64.700	-13	-51.70	775.300	-62.390	-13	-49.39
896.400	-63.890	-13	-50.89	852.300	-61.670	-13	-48.67
987.400	-63.610	-13	-50.61	953.800	-61.060	-13	-48.06
1718.000	-53.290	-13	-40.29	1718.000	-56.150	-13	-43.15
2038.000	-59.090	-13	-46.09	2048.000	-60.270	-13	-47.27
3758.000	-14.920	-13	-1.92	3758.000	-18.840	-13	-5.84
5638.000	-37.320	-13	-24.32	5638.000	-41.570	-13	-28.57
7518.000	-44.020	-13	-31.02	9398.000	-38.290	-13	-25.29
9258.000	-41.680	-13	-28.68				
9398.000	-36.500	-13	-23.50				



4.6.5 Test Data

Mode 1
Horizontal Polarization

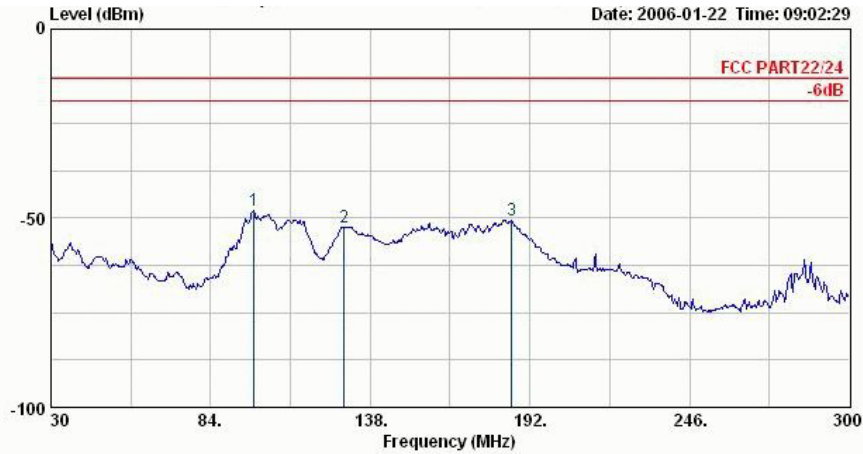

Site : 03CH06-HY
 Condition : LF-SPURIOUS HORIZONTAL
 EUT : GSM850/1800/1900 Mobile Phone
 Power : 120Vac/60Hz
 Model : FG611611
 Memo : PCS1900 Link Mode,CH661
 Plane : H

	Freq	Level	Over	Limit	Read	Factor	Remark
	MHz	dBm	dB	dBm	dBm	dB	
1 @	98.58	-47.84	-34.84	-13.00	-35.59	-12.24	Peak
2	129.09	-52.31	-39.31	-13.00	-39.73	-12.57	Peak
3	185.79	-50.50	-37.50	-13.00	-37.27	-13.23	Peak

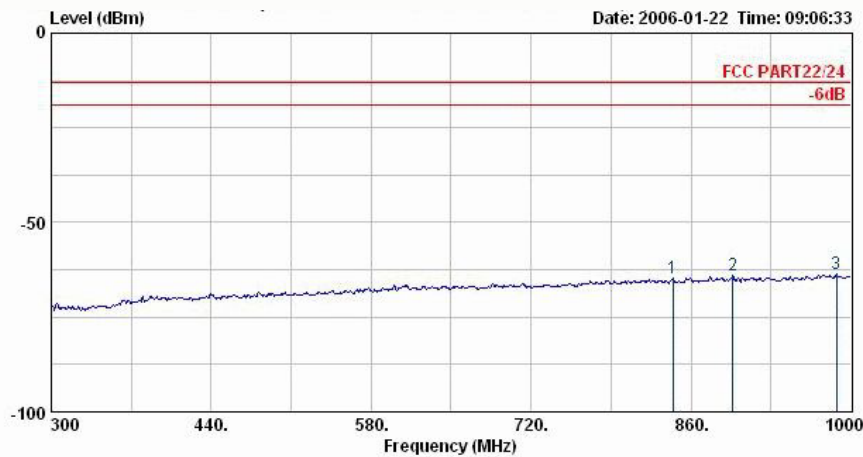

Site : 03CH06-HY
 Condition : LF-SPURIOUS HORIZONTAL
 EUT : GSM850/1800/1900 Mobile Phone
 Power : 120Vac/60Hz
 Model : FG611611
 Memo : PCS1900 Link Mode,CH661
 Plane : H

	Freq	Level	Over	Limit	Read	Factor	Remark
	MHz	dBm	dB	dBm	dBm	dB	
1	843.90	-64.70	-51.70	-13.00	-63.43	-1.27	Peak
2	896.40	-63.89	-50.89	-13.00	-63.13	-0.76	Peak
3	987.40	-63.61	-50.61	-13.00	-63.73	0.12	Peak

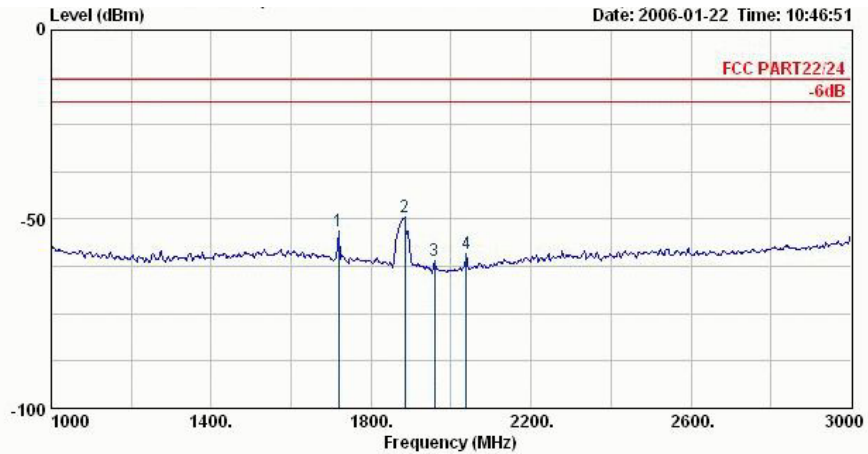

Site : 03CH06-HY
 Condition : HF-SPURIOUS HORIZONTAL
 EUT : GSM850/1800/1900 Mobile Phone
 Power : 120Vac/60Hz
 Model : FG611611
 Memo : PCS1900 Link Mode,CH661
 Plane : H

	Freq	Level	Over	Limit	Read		
	MHz	dBm	Limit	Line	Level	Factor	Remark
		dBm	dB	dBm	dBm	dB	
1	1718.00	-53.29	-40.29	-13.00	-53.37	0.08	Peak
2	1884.00	-49.45			-48.77	-0.68	Peak
3	1958.00	-60.90			-59.79	-1.11	Peak
4	2038.00	-59.09	-46.09	-13.00	-58.36	-0.73	Peak

Remark:

- #2: MS TCH Signal.
- #3: BS TCH Signal.

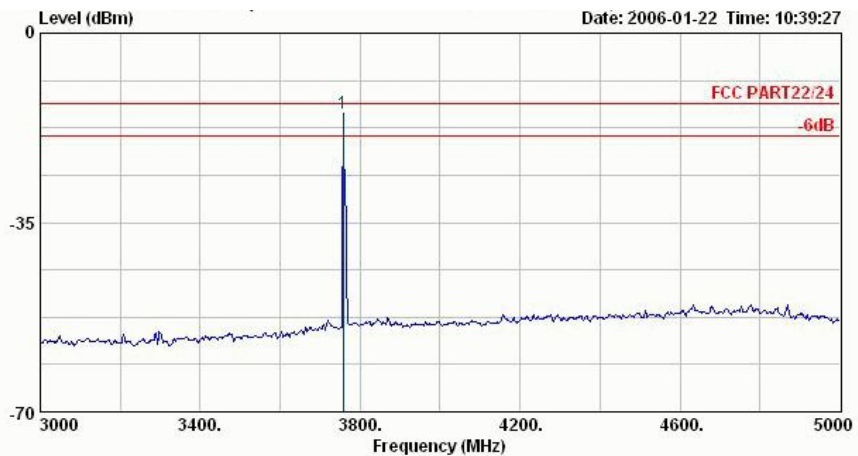

Site : 03CH06-HY
 Condition : HF-SPURIOUS HORIZONTAL
 EUT : GSM850/1800/1900 Mobile Phone
 Power : 120Vac/60Hz
 Model : FG611611
 Memo : PCS1900 Link Mode,CH661
 Plane : H

	Freq	Level	Over	Limit	Read		
	MHz	dBm	Limit	Line	Level	Factor	Remark
		dBm	dB	dBm	dBm	dB	
1 @	3758.00	-14.92	-1.92	-13.00	-22.85	7.92	Peak

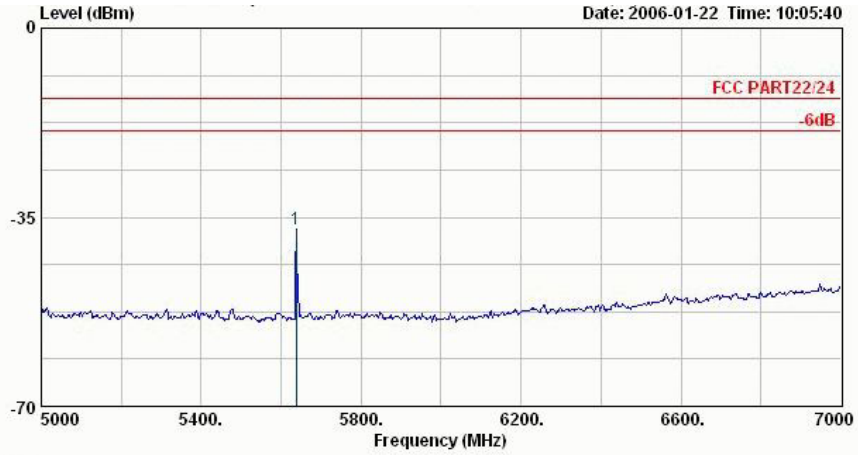

Site : 03CH06-HY
 Condition : HF-SPURIOUS HORIZONTAL
 EUT : GSM850/1800/1900 Mobile Phone
 Power : 120Vac/60Hz
 Model : FG611611
 Memo : PCS1900 Link Mode,CH661
 Plane : H

	Freq	Level	Over	Limit	Read		
	MHz	dBm	dB	dBm	dBm	dB	Remark
1 @	5638.00	-37.32	-24.32	-13.00	-47.29	9.97	Peak

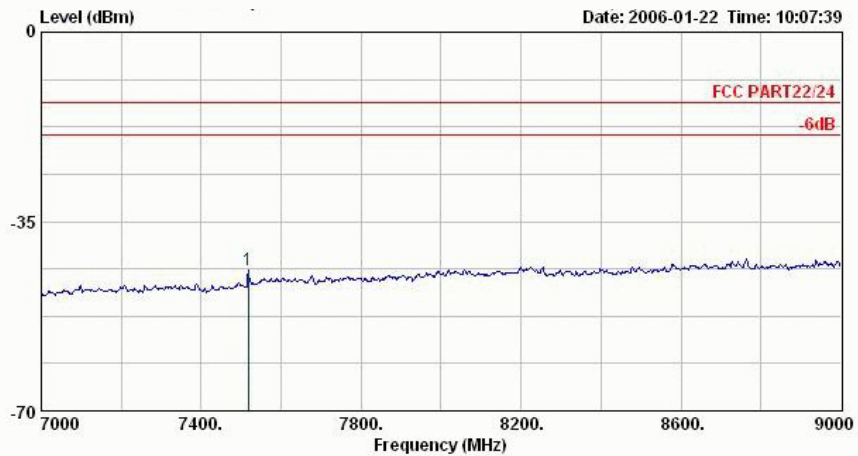

Site : 03CH06-HY
 Condition : HF-SPURIOUS HORIZONTAL
 EUT : GSM850/1800/1900 Mobile Phone
 Power : 120Vac/60Hz
 Model : FG611611
 Memo : PCS1900 Link Mode,CH661
 Plane : H

	Freq	Level	Over	Limit	Read		
	MHz	dBm	dB	dBm	dBm	dB	Remark
1 @	7518.00	-44.02	-31.02	-13.00	-59.83	15.80	Peak

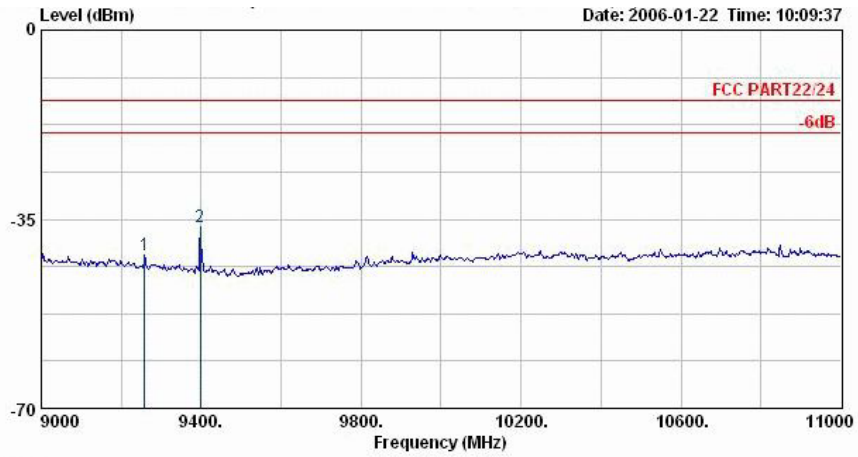

Site : 03CH06-HY
 Condition : HF-SPURIOUS HORIZONTAL
 EUT : GSM850/1800/1900 Mobile Phone
 Power : 120Vac/60Hz
 Model : FG611611
 Memo : PCS1900 Link Mode,CH661
 Plane : H

	Freq	Level	Over	Limit	Read	Level	Factor	Remark
	MHz	dBm	dB	dBm	dBm	dB		
1 @	9258.00	-41.68	-28.68	-13.00	-61.02	19.34		Peak
2 @	9398.00	-36.50	-23.50	-13.00	-54.72	18.22		Peak

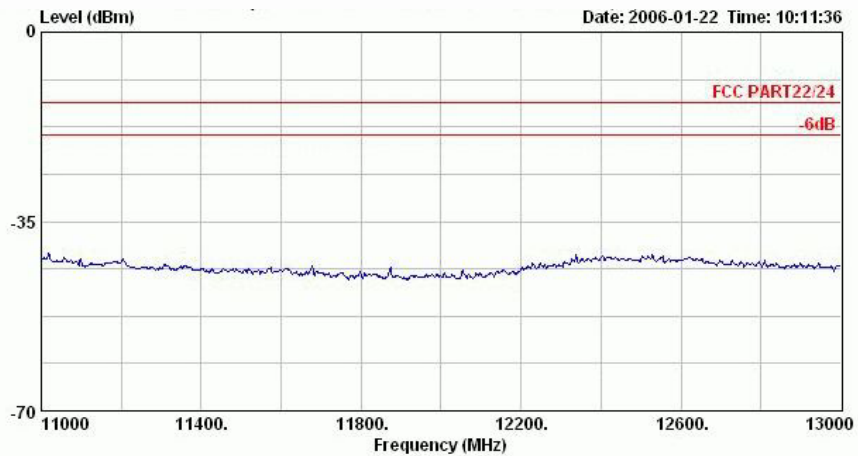

Site : 03CH06-HY
 Condition : HF-SPURIOUS HORIZONTAL
 EUT : GSM850/1800/1900 Mobile Phone
 Power : 120Vac/60Hz
 Model : FG611611
 Memo : PCS1900 Link Mode,CH661
 Plane : H

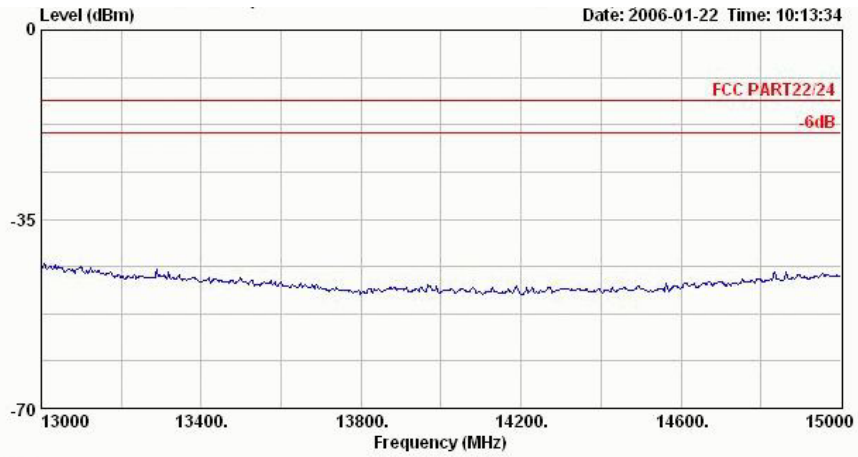

Site : 03CH06-HY
Condition : HF-SPURIOUS HORIZONTAL
EUT : GSM850/1800/1900 Mobile Phone
Power : 120Vac/60Hz
Model : FG611611
Memo : PCS1900 Link Mode,CH661
Plane : H

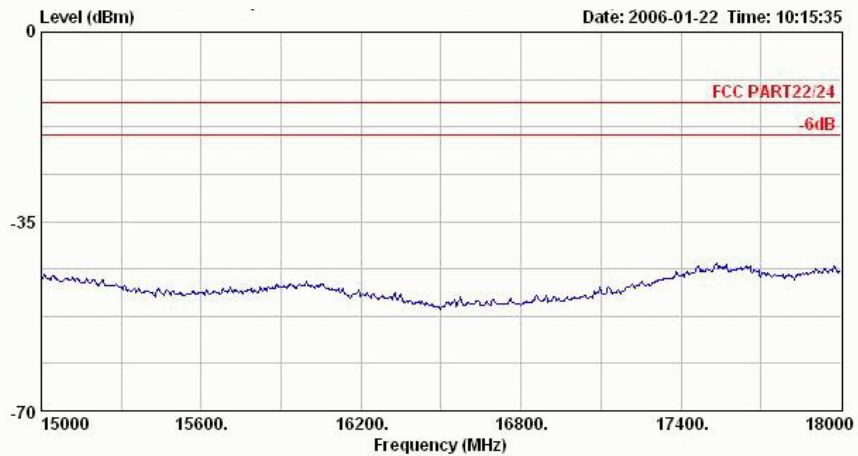

Site : 03CH06-HY
Condition : HF-SPURIOUS HORIZONTAL
EUT : GSM850/1800/1900 Mobile Phone
Power : 120Vac/60Hz
Model : FG611611
Memo : PCS1900 Link Mode,CH661
Plane : H



Vertical Polarization

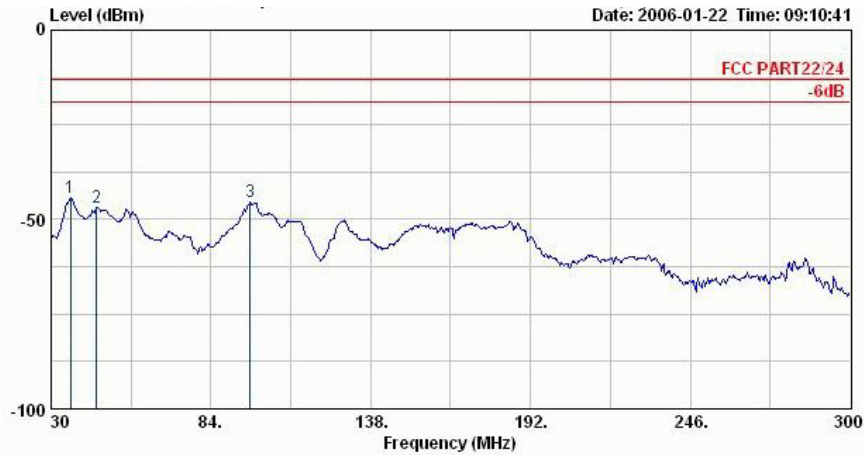

Site : 03CH06-HY
 Condition : LF-SPURIOUS VERTICAL
 EUT : GSM850/1800/1900 Mobile Phone
 Power : 120Vac/60Hz
 Model : FG611611
 Memo : PCS1900 Link Mode,CH661
 Plane : H

	Freq MHz	Level dBm	Over Limit dB	Limit Line dBm	Read Level dBm	Factor dB	Remark
1 @	36.48	-44.25	-31.25	-13.00	-33.27	-10.99	Peak
2 @	45.39	-46.69	-33.69	-13.00	-33.24	-13.45	Peak
3 @	97.23	-45.33	-32.33	-13.00	-37.22	-8.11	Peak

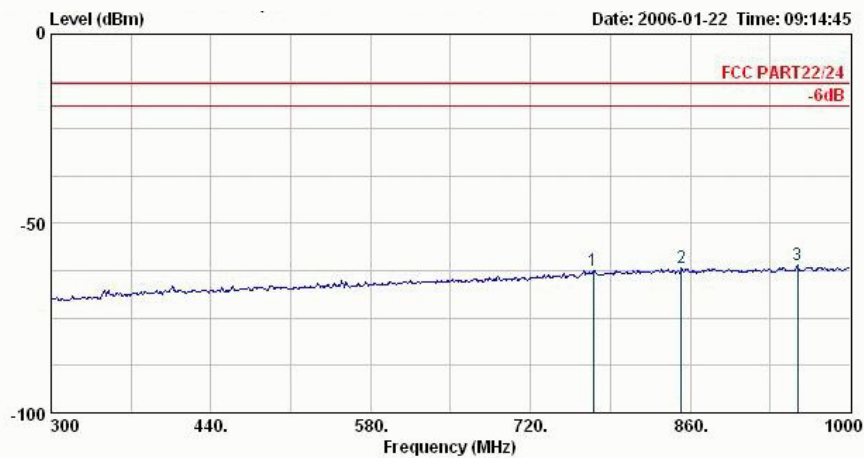

Site : 03CH06-HY
 Condition : LF-SPURIOUS VERTICAL
 EUT : GSM850/1800/1900 Mobile Phone
 Power : 120Vac/60Hz
 Model : FG611611
 Memo : PCS1900 Link Mode,CH661
 Plane : H

	Freq MHz	Level dBm	Over Limit dB	Limit Line dBm	Read Level dBm	Factor dB	Remark
1	775.30	-62.39	-49.39	-13.00	-63.08	0.69	Peak
2	852.30	-61.67	-48.67	-13.00	-63.16	1.49	Peak
3	953.80	-61.06	-48.06	-13.00	-63.35	2.29	Peak

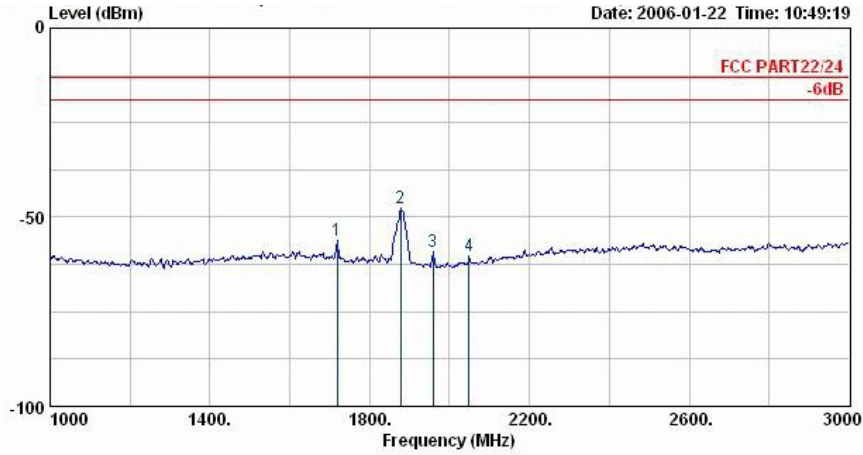

Site : 03CH06-HY
 Condition : HF-SPURIOUS VERTICAL
 EUT : GSM850/1800/1900 Mobile Phone
 Power : 120Vac/60Hz
 Model : FG611611
 Memo : PCS1900 Link Mode,CH661
 Plane : H

	Freq	Level	Over	Limit	Read	Factor	Remark
	MHz	dBm	dB	dBm	dBm	dB	
1	1718.00	-56.15	-43.15	-13.00	-55.73	-0.42	Peak
2 @	1878.00	-47.44			-47.04	-0.40	Peak
3	1958.00	-59.12			-58.53	-0.60	Peak
4	2048.00	-60.27	-47.27	-13.00	-60.23	-0.04	Peak

Remark:

- #2: MS TCH Signal.
- #3: BS TCH Signal.

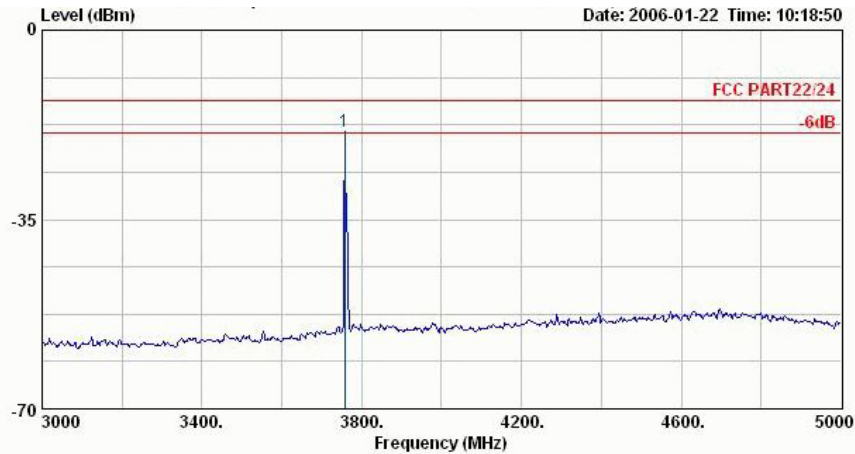

Site : 03CH06-HY
 Condition : HF-SPURIOUS VERTICAL
 EUT : GSM850/1800/1900 Mobile Phone
 Power : 120Vac/60Hz
 Model : FG611611
 Memo : PCS1900 Link Mode,CH661
 Plane : H

	Freq	Level	Over	Limit	Read	Factor	Remark
	MHz	dBm	dB	dBm	dBm	dB	
1 @	3758.00	-18.84	-5.84	-13.00	-25.48	6.64	Peak

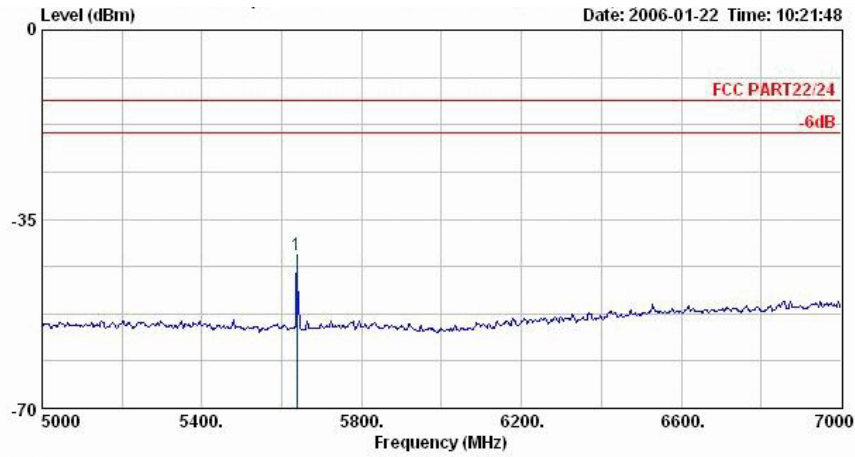

Site : 03CH06-HY
 Condition : HF-SPURIOUS VERTICAL
 EUT : GSM850/1800/1900 Mobile Phone
 Power : 120Vac/60Hz
 Model : FG611611
 Memo : PCS1900 Link Mode,CH661
 Plane : H

	Freq	Level	Over	Limit	Read		
	MHz	dBm	dB	dBm	dBm	dB	Remark
1 @	5638.00	-41.57	-28.57	-13.00	-50.23	8.65	Peak

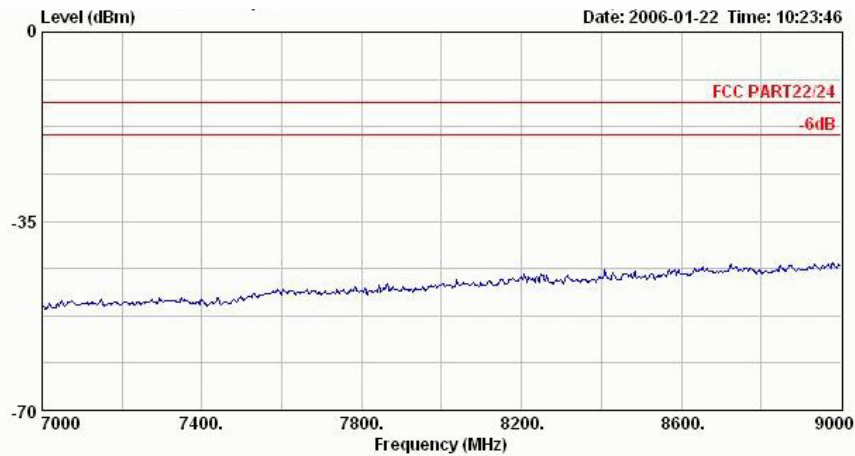

Site : 03CH06-HY
 Condition : HF-SPURIOUS VERTICAL
 EUT : GSM850/1800/1900 Mobile Phone
 Power : 120Vac/60Hz
 Model : FG611611
 Memo : PCS1900 Link Mode,CH661
 Plane : H

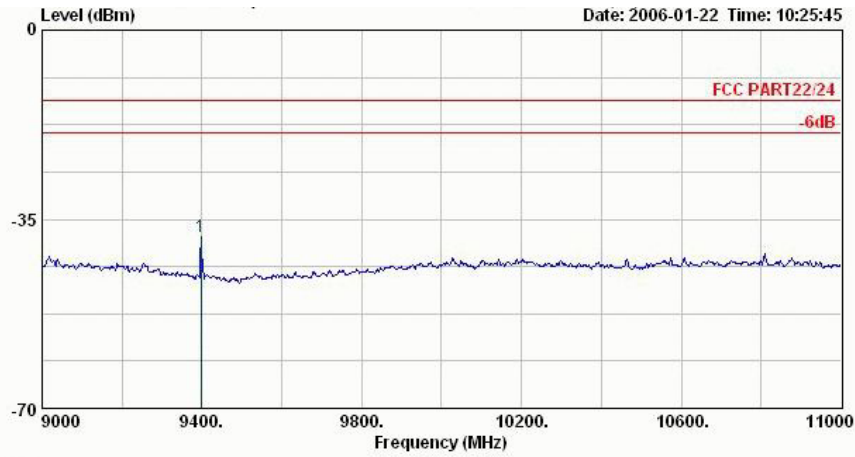

Site : 03CH06-HY
 Condition : HF-SPURIOUS VERTICAL
 EUT : GSM850/1800/1900 Mobile Phone
 Power : 120Vac/80Hz
 Model : FG611611
 Memo : PCS1900 Link Mode,CH661
 Plane : H

	Freq	Level	Over	Limit	Read		
	MHz	dBm	dB	dBm	dBm	dB	Remark
1 @	9398.00	-38.29	-25.29	-13.00	-55.49	17.20	Peak

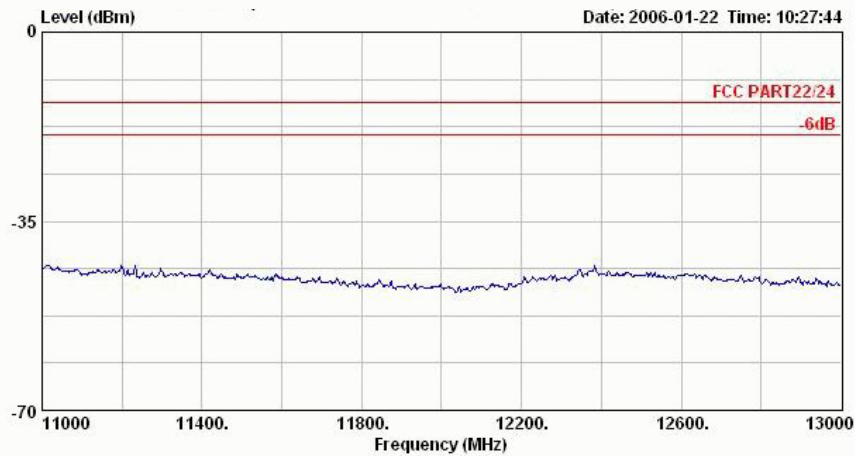

Site : 03CH06-HY
 Condition : HF-SPURIOUS VERTICAL
 EUT : GSM850/1800/1900 Mobile Phone
 Power : 120Vac/80Hz
 Model : FG611611
 Memo : PCS1900 Link Mode,CH661
 Plane : H

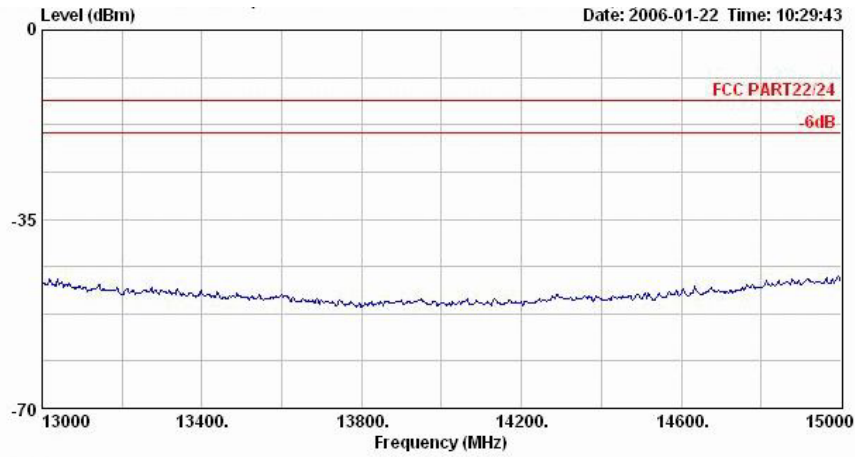

Site : 03CH06-HY
Condition : HF-SPURIOUS VERTICAL
EUT : GSM850/1800/1900 Mobile Phone
Power : 120Vac/60Hz
Model : FG611611
Memo : PCS1900 Link Mode,CH661
Plane : H

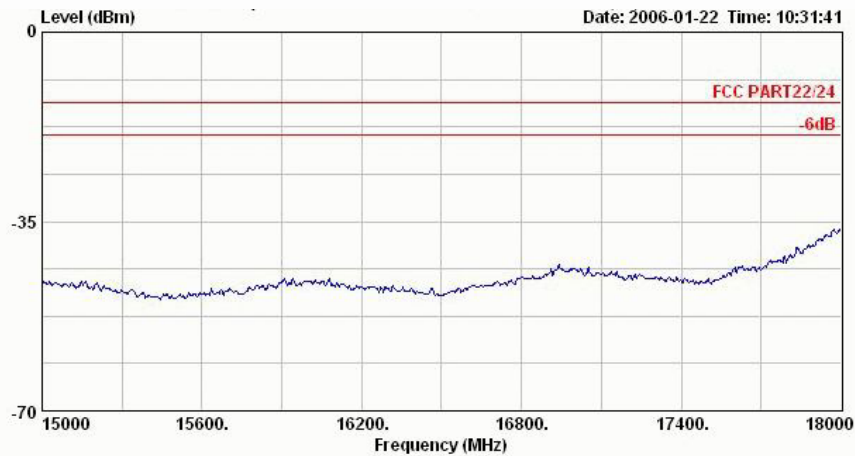

Site : 03CH06-HY
Condition : HF-SPURIOUS VERTICAL
EUT : GSM850/1800/1900 Mobile Phone
Power : 120Vac/60Hz
Model : FG611611
Memo : PCS1900 Link Mode,CH661
Plane : H

4.7 Frequency Stability (Temperature Variation)

4.7.1 Measurement Instrument

As described in chapter 5 of this test report.

4.7.2 Test Procedure

1. The EUT and test equipment were set up as shown on the following section.
2. With all power removed, the temperature was decreased to -30°C and permitted to stabilize for three hours. Power was applied and the maximum change in frequency was noted within one minute.
3. With power OFF, the temperature was raised in 10°C steps. The sample was permitted to stabilize at each step for at least one-half hour. Power was applied and the maximum frequency change was noted within one minute.
4. The temperature tests were performed for the worst case.
5. Test data was recorded.

4.7.3 Test Setup Layout

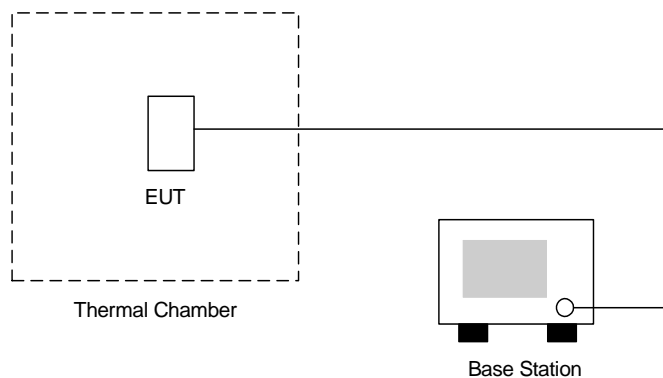



4.7.4 Test Result

▪ Test Mode : PCS 1900 CH661

Temperature(°C)	Change (Hz)	Change (ppm)	Limit (ppm)	Result
-20	36	0.02	2.5	Passed
-10	39	0.02		
0	-42	-0.02		
10	35	0.02		
20	92	0.05		
30	100	0.05		
40	102	0.05		
50	120	0.06		

4.8 Frequency Stability (Voltage Variation)

4.8.1 Measurement Instrument

As described in chapter 5 of this test report.

4.8.2 Test Procedure

1. The EUT was placed in a temperature chamber at $25\pm 5^{\circ}\text{C}$ and connected as the following section.
2. The power supply voltage to the EUT was varied from BEP to 115% of the nominal value measured at the input to the EUT.
3. The variation in frequency was measured for the worst case.

4.8.3 Test Setup Layout

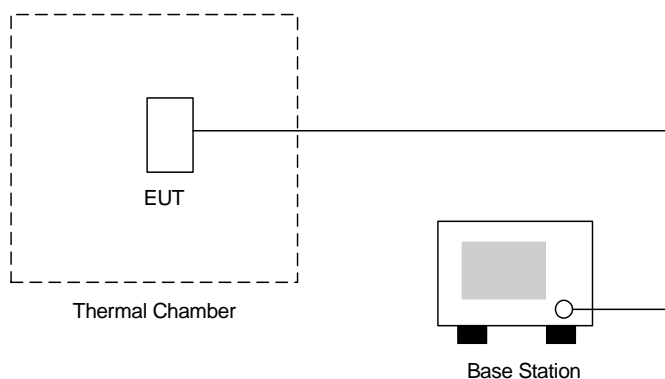

4.8.4 Test Result

- Test Mode : PCS 1900 CH661

Voltage(Volt)	Change (Hz)	Change (ppm)	Limit (ppm)	Result
3.7	89	0.05	2.5	Passed
BEP	86	0.05		
4.3	35	0.02		

Remark:

1. Normal Voltage=3.7V
2. Battery End Point (BEP)=3.2 V



5 List of Measurement Equipments

Instrument	Manufacturer	Model No.	Serial No.	Characteristics	Calibration Date	Due Date	Remark
Spectrum analyzer	Agilent	E4408B	MY44211030	9KHz-26.5GHz	Jul. 25, 2005	Jul. 24, 2006	Radiation (03CH06-HY)
Receiver	R&S	ESCS30	100356	9KHz-2.75GHz	Jun. 28, 2005	Jun. 27, 2006	Radiation (03CH06-HY)
Controller	CT	SC100	N/A	N/A	N/A	N/A	Radiation (03CH06-HY)
Bilog Antenna	SCHAFFNER	CBL6112B	2885	30MHz -2GHz	Nov. 22, 2004	Nov. 22, 2006	Radiation (03CH06-HY)
Horn Antenna	Com-Power	AH118	071025	1G-18G	Feb. 22, 2005	Feb. 22, 2006	Radiation (03CH06-HY)
SHF-EHF Horn	SCHWARZBECK	BBHA 9170	9170-249	14G - 40G	Jul. 21, 2005	Jul. 20, 2006	Radiation (03CH06-HY)
Amplifier	MITEQ	AMF-6F	997165	26G - 40G	Jul. 21, 2005	Jul. 20, 2006	Radiation (03CH06-HY)
Turn Table	HD	DS 420	420/650/00	0 ~ 360 degree	N/A	N/A	Radiation (03CH06-HY)
Antenna Mast	HD	MA 240	240/560/00	1 m - 4 m	N/A	N/A	Radiation (03CH06-HY)



6 Uncertainty Evaluation

Uncertainty of Radiated Emission Measurement (30MHz ~ 1000MHz)

Contribution	Uncertainty of x_i		$u(x_i)$
	dB	Probability Distribution	
Receiver reading	0.41	Normal(k=2)	0.21
Antenna factor calibration	0.83	Normal(k=2)	0.42
Cable loss calibration	0.25	Normal(k=2)	0.13
Pre Amplifier Gain calibration	0.27	Normal(k=2)	0.14
RCV/SPA specification	2.50	Rectangular	0.72
Antenna Factor Interpolation for Frequency	1.00	Rectangular	0.29
Site imperfection	1.43	Rectangular	0.83
Mismatch	+0.39/-0.41	U-shaped	0.28
combined standard uncertainty $U_c(y)$	1.27		
Measuring uncertainty for a level of confidence of 95% $U=2U_c(y)$	2.54		

Uncertainty of Radiated Emission Measurement (1GHz ~ 40GHz)

Contribution	Uncertainty of x_i		$u(x_i)$	C_i	$C_i * u(x_i)$
	dB	Probability Distribution			
Receiver reading	±0.10	Normal(k=1)	0.10	1	0.10
Antenna factor calibration	±1.70	Normal(k=2)	0.85	1	0.85
Cable loss calibration	±0.50	Normal(k=2)	0.25	1	0.25
Receiver Correction	±2.00	Rectangular	1.15	1	1.15
Antenna Factor Directional	±1.50	Rectangular	0.87	1	0.87
Site imperfection	±2.80	Triangular	1.14	1	1.14
Mismatch Receiver VSWR $\Gamma_1= 0.197$ Antenna VSWR $\Gamma_2= 0.194$ Uncertainty= $20\log(1-\Gamma_1*\Gamma_2*\Gamma_3)$	+0.34/-0.35	U-shaped	0.244	1	0.244
Combined standard uncertainty $U_c(y)$	2.36				
Measuring uncertainty for a level of confidence of 95% $U=2U_e(y)$	4.72				

END OF TEST REPORT