

MEASUREMENT REPORT of *Wireless LAN USB Stick*

Applicant : BenQ Corporation
Model No. : AWL-400
EUT : Wireless LAN USB Stick
FCC ID : JVPAWL400
Report No. : B2215836

Tested by :

Training Research Co., Ltd.

TEL : 886-2-26935155

FAX : 886-2-26934440

No. 255, Nanyang Street, Shijr, Taipei Hsien 221, Taiwan, R.O.C.

CERTIFICATION

We here by verify that:

The test data, data evaluation, test procedures and equipment configurations shown in this report were made mainly in accordance with the procedures given in ANSI C63.4 (1992) as a reference. All test were conducted by *Training Research Co., Ltd.*, 255 Nanyang Street, Shijr, Taipei Hsien 221, Taiwan, R.O.C. Also, we attest to the accuracy of each.

We further submit that the energy emitted by the sample EUT tested as described in the report is in compliance with the technical requirements set forth in the FCC Rules Part 15 Subpart C Section 15.247.

Applicant : BenQ Corporation
Applicant address : 18, Jihu Rd., Neihu Dist., Taipei 114, Taiwan, R.O.C.
EUT : Wireless LAN USB Stick
Model No. : AWL-400
FCC ID : JVPAWL400
Report No. : B2215836
Test Date : September 25, 2002

Prepared by:

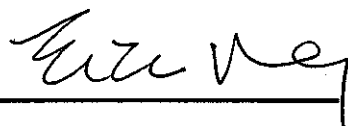

Eric Wong

Approved by:

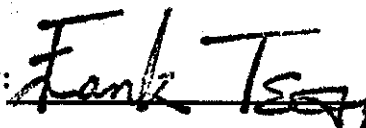

Frank Tsai

Tested by :

Training Research Co., Ltd.

TEL: 886-2-26935155 FAX: 886-2-26934440

255 Nanyang Street, Shijr, Taipei Hsien 221, Taiwan, R.O.C.

Report No.: B2215836

Training Research Co., Ltd., TEL: 886-2-26935155, Fax: 886-2-26934440

Tables of Contents

| | |
|---|----|
| I. GENERAL | 5 |
| 1.1 Introduction | 5 |
| 1.2 Description of EUT | 5 |
| 1.3 Description of Support Equipment | 6 |
| 1.4 Test method | 6 |
| 1.5 Configuration of System Under Test | 7 |
| 1.6 Verify the Frequency and Channel | 9 |
| 1.7 Test Procedure | 10 |
| 1.8 Location of the Test Site | 10 |
| 1.9 General Test Condition | 10 |
| | |
| II. Section 15.101(a) : Equipment Authorization of Unintentional Radiators | 11 |
| | |
| III. Section 15.203 : Antenna Requirement | 12 |
| | |
| IV. Section 15.207 : Power Line Conducted Emissions for AC Powered Units | 13 |
| 4.1 Test Condition & Setup | 13 |
| 4.2 List of Test Instruments | 13 |
| 4.3 Test Result of Conducted Emissions | 14 |
| | |
| V. Section 15.247(a) : Technical Description of the EUT | 15 |
| | |
| VI. Section 15.247(a)(2) : Bandwidth for Direct Sequence System | 16 |
| 6.1 Test Condition & Setup | 16 |
| 6.2 Test Instruments Configuration | 16 |
| 6.3 List of Test Instruments | 16 |
| 6.4 Test Result of Bandwidth | 17 |
| Channel 01 | 18 |
| Channel 06 | 19 |
| Channel 11 | 20 |

VII. Section 15.247(b) : Power Output 21

 7.1 Test Condition & Setup 21

 7.2 List of Test Instruments 21

 7.3 Test Result 21

VIII. Section 15.247(c) : Spurious Emissions (Radiated) 22

 8.1 Test Condition & Setup 22

 8.2 List of Test Instruments 23

 8.3 Test Result of Spurious Radiated Emissions 24

 Table 1 Radiated emissions of Horizontal for 30MHz to 1GHz 24

 Table 2 Radiated emissions of Vertical for 30MHz to 1GHz 25

 Table 3 Above 1GHz radiated emissions of Horizontal of CH1 26

 Table 4 Above 1GHz radiated emissions of Vertical of CH1 26

 Table 5 Above 1GHz radiated emissions of Horizontal of CH6 27

 Table 6 Above 1GHz radiated emissions of Vertical of CH6 27

 Table 7 Above 1GHz radiated emissions of Horizontal of CH11 28

 Table 8 Above 1GHz radiated emissions of Vertical of CH11 28

 8.4 Test Result of Bandedge 29

 Channel 01 30

 Channel 11 31

IX. Section 15.247(d) : Power Spectral Density 32

 9.1 Test Condition & Setup 32

 9.2 Test Instruments Configuration 32

 9.3 List of Test Instruments 32

 9.4 Test Result of Power Spectral Density 32

 Channel 01 33

 Channel 06 34

 Channel 11 35

. GENERAL

1.1 Introduction

The following measurement report is submitted on behalf of applicant in support that the *cable gateway* certification in accordance with Part 2 Subpart J and Part 15 Subpart A and C of the Commission's Rules and Regulations.

1.2 Description of EUT

EUT : Wireless LAN USB Stick
Model No. : AWL-400
Granted FCC ID : JVPAWL400
Frequency Range : 2.412 GHz ~ 2.462GHz
Support Channel : 11 Channel
Modulation Skill : DBPSK, DQPSK, CCK
Power Type : By the USB interface of computer
Style Interface : USB (A-type)

1.3 Description of Support Equipment

In order to construct the minimum testing, following equipment were used as the support units.

Notebook : **IBM Think Pad X20**
Type No. : 2662-11T
Serial No. : FX-11922 00/09
FCC ID : Doc Approved
檢磁 : 3892B565
AC Adaptor : **IBM**
Model No. : PA2450U
Serial No. : 02K6654
FCC ID : Doc Approved
Power Core : Non-shielded, 180cm long, Plastic hoods, with ferrite bead
Power type : 100 ~ 240VAC, 50 ~ 60Hz, 0.5A ~ 1.2A / 16Vdc, 4.5A

Report No.: B2215836

Training Research Co., Ltd., TEL: 886-2-26935155, Fax: 886-2-26934440

Printer : **HP**
Model No. : C6464A
Serial No. : TH16LEB5PK
FCC ID : N/A, DoC Approved
檢磁 : 3892H381
Power type : Switching adaptor
Power cord : Non-shielded, 173cm long, No ferrite core
(between adaptor and AC source)
Non-shielded, 180cm long, with ferrite core
(between printer and adaptor)
Data cable : Shielded, 1.70m long, No ferrite core

Modem : **AcerCM**
Model No. : 56K SurfStar
Serial No. : 24834153812236

USB Mouse : **Logitech Inc.**
Model No. : M-BE58
Serial No. : LZE14370953
FCC ID : DoC Approved
檢磁 : 3892B471
Power type : By Computer
Data Cable : Shielded, 1.90m long, Plastic, No ferrite core

1.4 Test method

1. Insert the EUT into the USB port of the Notebook Computer
2. Using the Notebook Computer and software provided by the manufacturer to control and link wireless access point, then making access to the mode of continuous transmission. The software is operated under the Windows to control the EUT in the continuous transmission mode.
3. Then making access to the mode of continuous transmission and set testing channel.
4. *The testing configuration of test setup is showing in the next page.*

1.5 Configuration of System Under Test

(Conducted and Radiated for unintentional)

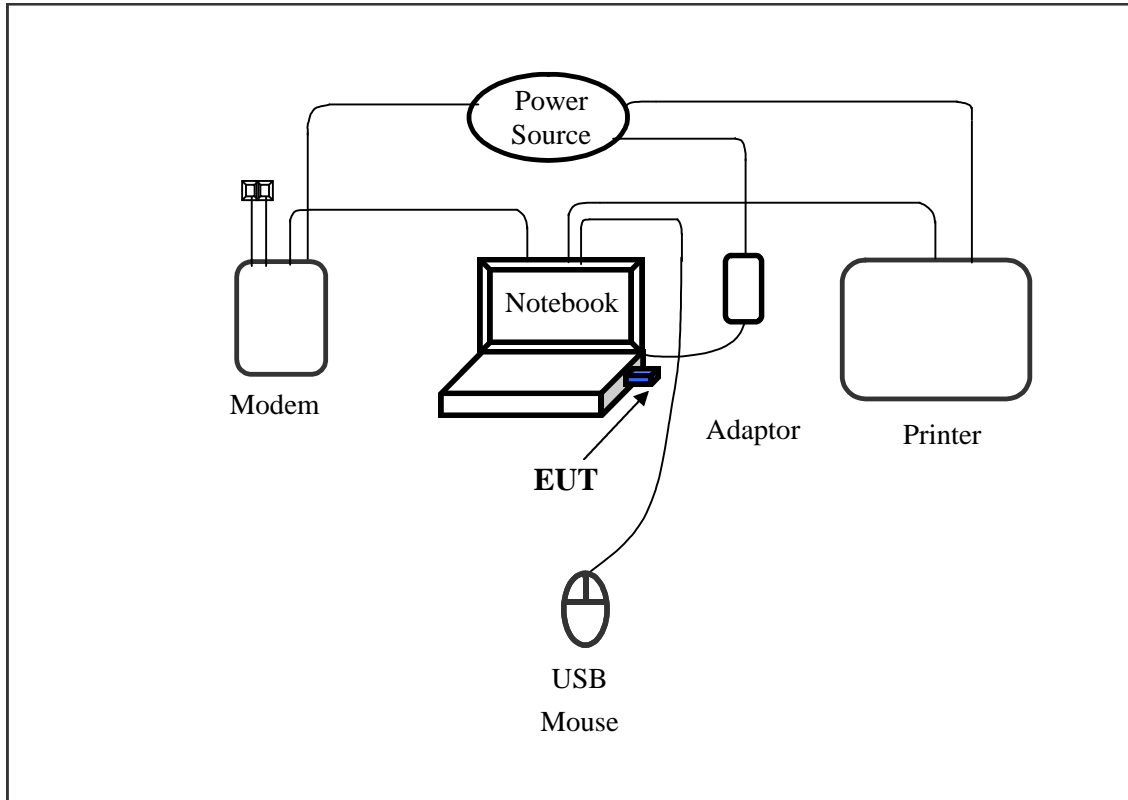

Connections of Equipment

Notebook:

- *Parallel Port --- a Printer
- *RS232 Port --- an external modem
- *USB A Port --- **EUT**
- *USB B Port --- a USB mouse

EUT:

- *USB Connector --- Plug the connector in the USB port of notebook computer

(Radiated of intentional)

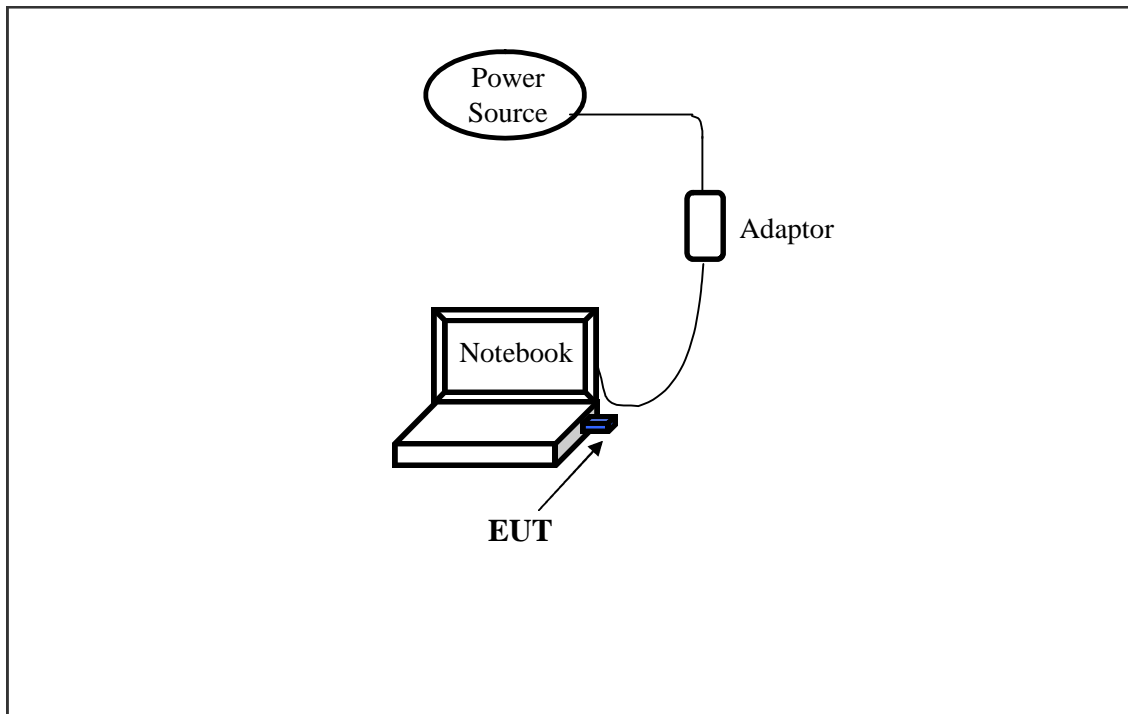

Connections of Equipment

EUT:

*USB Connector --- Plug the connector in the USB port of notebook computer

1.6 Verify the Frequency and Channel

| Channel | Frequency (GHz) |
|---------|-----------------|
| 1 | 2.412 |
| 2 | 2.417 |
| 3 | 2.422 |
| 4 | 2.427 |
| 5 | 2.432 |
| 6 | 2.437 |
| 7 | 2.442 |
| 8 | 2.447 |
| 9 | 2.452 |
| 10 | 2.457 |
| 11 | 2.462 |

Note:

- 1.This is for confirming that all frequencies are in 2.412GHz to 2.462GHz.
- 2.Section 15.31(m): Measurements on intentional radiators or receivers shall be performed at three frequencies for operating frequency range over 10 MHz.
(The locations of these frequencies one near the top, one near the middle and one near the bottom.)
- 3.After test, the EUT operating frequencies are in 2.412GHz to 2.462GHz. So all the items as followed in testing report are need to test these three frequencies:
Top: Channel – 1; Middle: Channel – 6; Bottom: Channel – 11.

1.7 Test Procedure

All measurements contained in this report were performed mainly according to the techniques described in ANSI C63.4 (1992) and the pre-setup was written on Appendix A, the detail setup was written on each test item.

1.8 Location of the Test Site

The radiated emissions measurements required by the rules were performed on the **three-meter, Anechoic Chamber (Registration Number: 93906)** maintained by *Training Research Co., Ltd.* 1F, No. 255 Nanyang Street, Shijr, Taipei Hsien 221, Taiwan, R.O.C. Complete description and measurement data have been placed on file with the commission. The conducted power line emissions tests and other test items were performed in a anechoic chamber also located at Training Research Co., Ltd.

No. 255 Nanyang Street, Shijr, Taipei Hsien 221, Taiwan, R.O.C. *Training Research Co., Ltd.* is listed by the FCC as a facility available to do measurement work for others on a contract basis.

1.9 General Test Condition

The conditions under which the EUT operates were varied to determine their effect on the equipment's emission characteristics. The final configuration of the test system and the mode of operation used during these tests were chosen as that which produced the highest emission levels. However, only those conditions, which the EUT was considered likely to encounter in normal use were investigated.

In test, they were set in high power and continuously transmitting mode that controlled by computer. The ch01, ch06 and ch11 of EUT were all tested. The setting up procedure is recorded on Appendix A.

II. Section 15.101(a): Equipment authorization of unintentional radiators

The EUT equipped with a USB bus interface and should be operated with the computer. It was categorized to *Class B personal computers and peripherals* as cannot be operated stand-alone. The authorization requires Certification and the items required such as Sect.15.107 (Conducted limits) and Sect.15.109 (Radiated emission limits) is same as Sect.15.207 and 15.247(C) we'd performed respectively. We dropped this part, as the result will be repeated as the part we mentioned above.

Report No.: B2215836

Training Research Co., Ltd., TEL: 886-2-26935155, Fax: 886-2-26934440

III. Section 15.203: Antenna requirement

The EUT has an integrated antenna permanently attached on the PCB. In addition, there is no external antenna or connector employed. The antenna requirement stated in Sect.15.203 is inapplicable to this EUT.

IV. Section 15.207: Power Line Conducted Emissions for AC Powered Units

4.1 Test Condition & Setup

The power line conducted emission measurements were performed in an anechoic chamber. The EUT was assembled on a wooden table, which is 80 centimeters high, was placed 40 centimeters from the backwall and at least 1 meter from the sidewall.

Power was fed to the EUT from the public utility power grid through a line filter and Line Impedance Stabilization Networks (LISNs). The LISN housing, measuring instrumentation case, ground plane, etc., were electrically bonded together at the same RF potential. The Spectrum analyzer (or EMI receiver) was connected to the AC line through an isolation transformer. The 50-ohm output of the LISN was connected to the spectrum analyzer directly. Conducted emission levels were in the CISPER quasi-peak detection mode. The analyzer's 6 dB bandwidth was set to 9 KHz. No post-detector video filter was used.

The spectrum was scanned from 450 KHz to 30 MHz. The physical arrangement of the test system and associated cabling was varied (within the scope of arrangements likely to be encountered in actual use) to determine the effect on the unit's emanations in amplitude and frequency. All spurious emission frequencies were observed. The highest emission amplitudes relative to the appropriate limit were measured and have been recorded in paragraph 2.4.

There is a test condition apply in this test item, the test procedure description as the following:

EUT transmit only:

Plug the EUT in the USB port of notebook computer and software to control the EUT. Then making access to the mode of continuous transmission and setting the testing channel. Three channels were tested, one in the top (CH01), one in the middle (CH06) and the other in bottom (CH11).

4.2 List of Test Instruments

| <u>Instrument Name</u> | <u>Model No.</u> | <u>Brand</u> | <u>Serial No.</u> | <u>Last time</u> | <u>Next time</u> |
|----------------------------------|------------------|--------------|-------------------|------------------|------------------|
| EMI Receiver | 8546A | H P | 3520A00242 | 06/28/02 | 06/28/03 |
| RF Filter Section | 85460A | H P | 3448A00217 | 06/28/02 | 06/28/03 |
| LISN (EUT) | LISN-01 | TRC | 9912-03,04 | 12/09/01 | 12/09/02 |
| LISN (Support E.) | LISN-01 | TRC | 9912-05 | 07/15/02 | 07/15/03 |
| Switch/Control Unit (< 30MHz) | 3488A | HP | N/A | 11/20/01 | 11/20/02 |
| Auto Switch Box (< 30MHz) | ASB-01 | TRC | 9904-01 | 11/20/01 | 11/20/02 |

The level of confidence of 95%, the uncertainty of measurement of conducted emission is ± 2.02 dB.

Report No.: B2215836

Training Research Co., Ltd., TEL: 886-2-26935155, Fax: 886-2-26934440

4.3 Test Result of Power Line Conducted Emissions

EUT station transmit only

The following table shows a summary of the highest emissions of power line conducted emissions on the LIVE and NETURAL conductors of the EUT power cord. The worst case to show as follows.

Test Conditions: Testing room : Temperature : 26 °C Humidity : 53 % RH

| <i>Power Connected Emissions</i> | | | | <i>FCC Class B</i> | |
|----------------------------------|------------------------|------------------------------|----------------------------|---------------------|--------------------|
| <i>Conductor</i> | <i>Frequency (KHz)</i> | <i>Peak Amplitude (dBmV)</i> | <i>QP Amplitude (dBmV)</i> | <i>Limit (dBmV)</i> | <i>Margin (dB)</i> |
| Line 1 | 480.000 | 39.28 | --- | 48.00 | -8.72 |
| | 640.000 | 37.63 | --- | 48.00 | -10.37 |
| | 810.000 | 38.09 | --- | 48.00 | -9.91 |
| | 910.000 | 37.82 | --- | 48.00 | -10.18 |
| | 1210.000 | 38.81 | --- | 48.00 | -9.19 |
| | 1460.000 | 38.77 | --- | 48.00 | -9.23 |
| | 2100.000 | 38.48 | --- | 48.00 | -9.52 |
| | 4900.000 | 36.49 | --- | 48.00 | -11.51 |
| | 6300.000 | 31.90 | --- | 48.00 | -16.10 |
| | 11100.000 | 28.24 | --- | 48.00 | -19.76 |
| Line 2 | 480.000 | 39.54 | --- | 48.00 | -8.46 |
| | 640.000 | 38.35 | --- | 48.00 | -9.65 |
| | 790.000 | 38.23 | --- | 48.00 | -9.77 |
| | 920.000 | 38.86 | --- | 48.00 | -9.14 |
| | 1210.000 | 39.05 | --- | 48.00 | -8.95 |
| | 1460.000 | 39.26 | --- | 48.00 | -8.74 |
| | 2030.000 | 39.45 | --- | 48.00 | -8.55 |
| | 3860.000 | 36.62 | --- | 48.00 | -11.38 |
| | 5070.000 | 35.49 | --- | 48.00 | -12.51 |
| | 13120.000 | 29.64 | --- | 48.00 | -18.36 |

NOTE:

- (1)Margin = Peak Amplitude – Limit, ***The reading amplitudes are all under limit.***
- (2)A "+" sign in the margin column means the emission is OVER the Class B Limit and "-" sign of means UNDER the Class B limit

Report No.: B2215836

Training Research Co., Ltd., TEL: 886-2-26935155, Fax: 886-2-26934440

V. Section 15.247 (a): Technical description of the EUT

Based on the Section 2.1, *Direct Sequence System* is a spread spectrum system in which the carrier has been modulated by a high speed spreading code and an information data stream. The high speed code sequence dominates the “modulating function” and is the direct cause of the wide spreading of the transmitted signal. In the Exhibit H, operational description demonstrates the operation principles of the Baseband processor employed by the EUT, shows that which is a complete DSSS baseband processor and meets the definition of the Direct sequence spread spectrum system.

VI. Section 15.247(a)(2): Bandwidth for Direct Sequence System.

6.1 Test Condition & Setup

The transmitter bandwidth measurements were performed by the contact manner. The EUT was set to transmit continuously, also various channels were investigated to find the maximum occupied bandwidth.. The output of the EUT was connected to the spectrum analyzer. The bandwidth of the fundamental frequency is observed by the spectrum analyzer with 100kHz RBW and 100kHz VBW.

6.2 Test Instruments Configuration

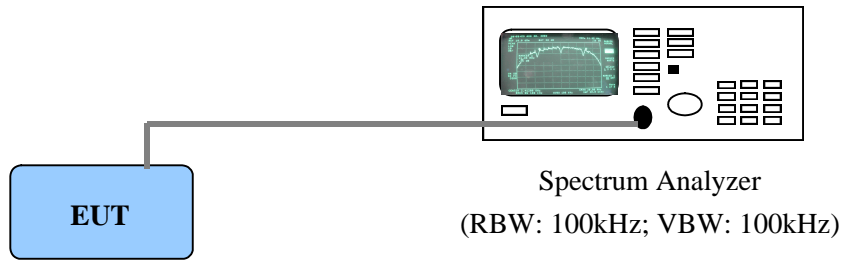

Test Configuration of Bandwidth for Direct Sequence System

P.S.: Notebook computer to control the EUT at maximal power output and channel Number and set antenna kit

6.3 List of Test Instruments

| <u>Instrument Name</u> | <u>Model No.</u> | <u>Brand</u> | <u>Serial No.</u> | <u>Last time</u> | <u>Next time</u> |
|------------------------|------------------|--------------|-------------------|------------------|------------------|
| Spectrum Analyzer | 8592A | H P | 3003AD1401 | 01/02/02 | 01/01/03 |

6.4 Test Result of Bandwidth

Bandwidth of Channel 1

Bandwidth : 11.05 MHz
The min. 6 dB BW at least : 500 KHz

Bandwidth of Channel 6

Bandwidth : 11.10 MHz
The min. 6 dB BW at least : 500 KHz

Bandwidth of Channel 11

Bandwidth : 11.10 MHz
The min. 6 dB BW at least : 500 KHz

Note:

1. The data in the above table are summarizing the following attachment spectrum analyzer hard copy. According to the guidance, we'd made the measurement with the spectrum analyzer's resolution bandwidth (RBW)= $300kHz$ and set the $span \gg RBW$. The results show the measured 6dB bandwidth comply with the minimum 500kHz requirement.
2. The attachments show these on the following pages.

Bandwidth of Channel 1: 10.30 MHz

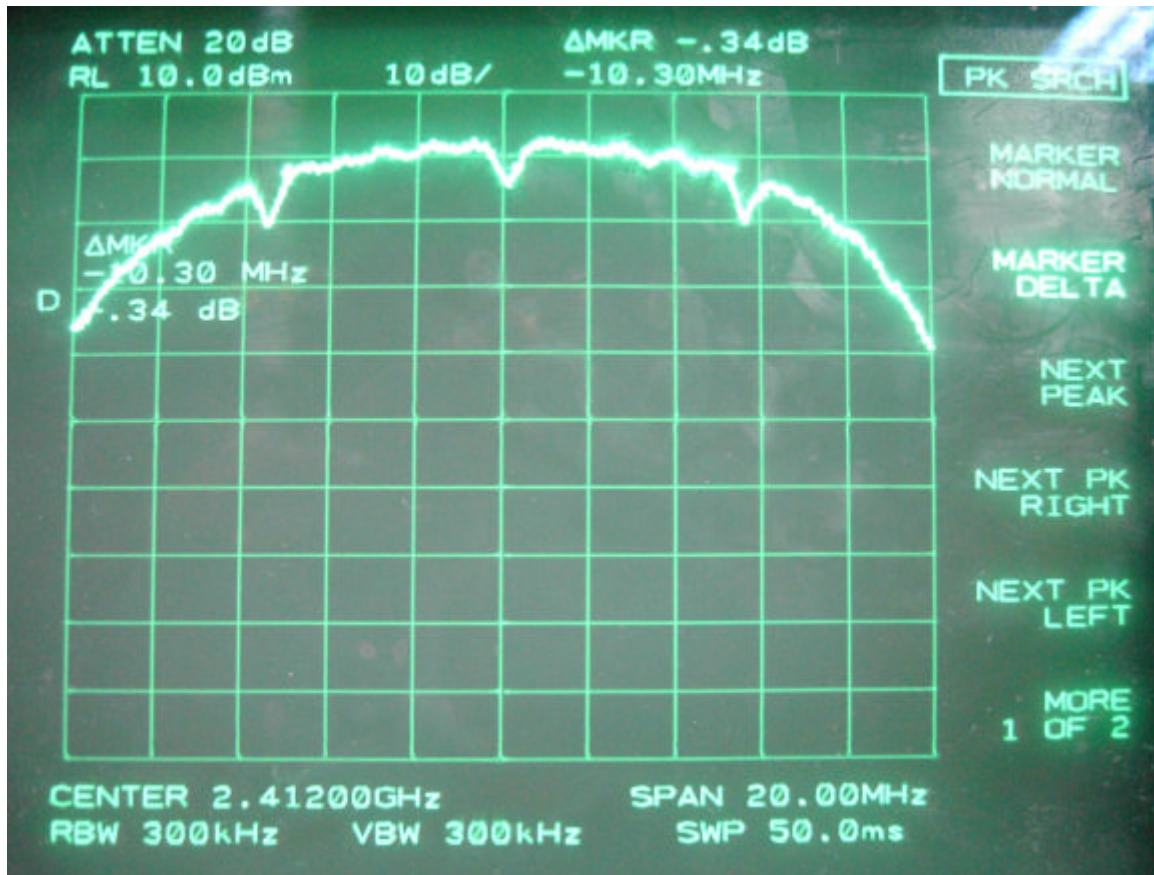

Report No.: B2215836

Training Research Co., Ltd., TEL: 886-2-26935155, Fax: 886-2-26934440

Bandwidth of Channel 6: 10.30 MHz

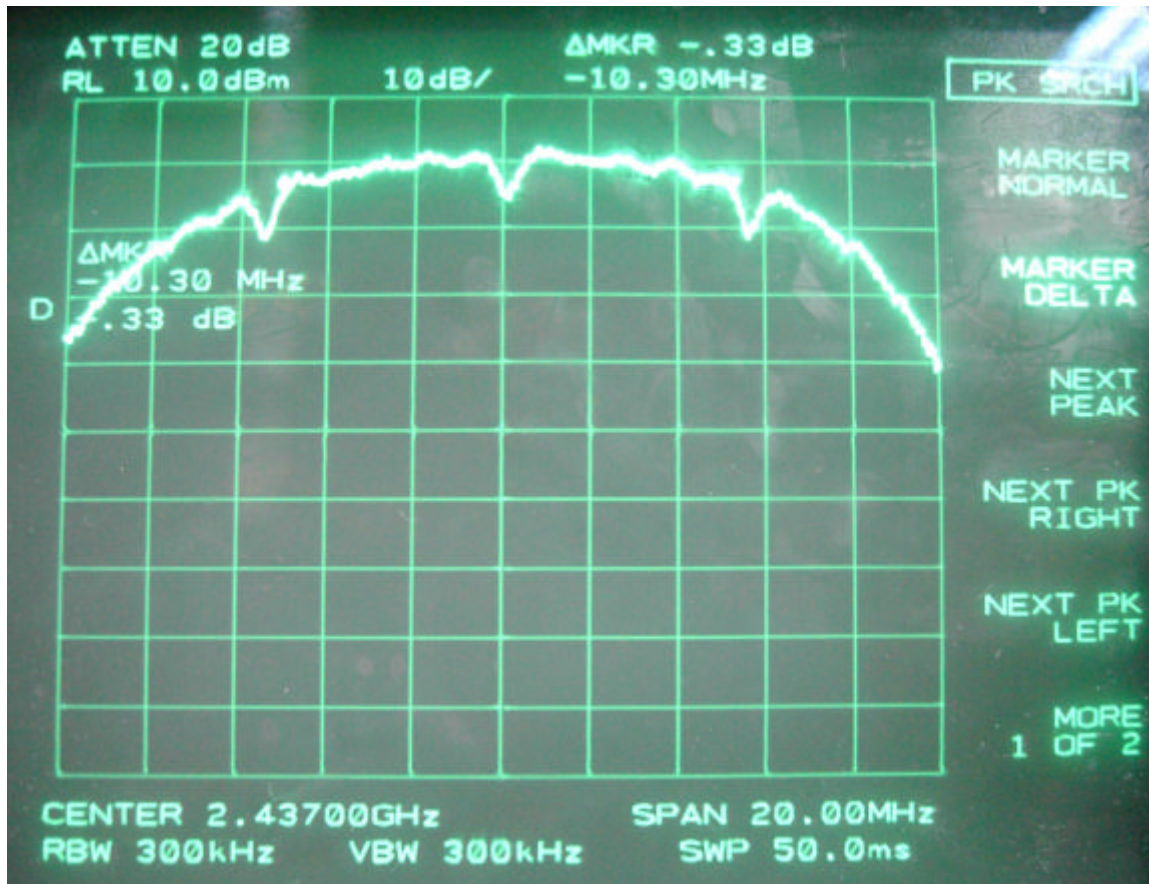

Report No.: B2215836

Training Research Co., Ltd., TEL: 886-2-26935155, Fax: 886-2-26934440

Bandwidth of Channel 11: 10.23 MHz



Report No.: B2215836

Training Research Co., Ltd., TEL: 886-2-26935155, Fax: 886-2-26934440

VII. Section 15.247(b): Power Output

7.1 Test Condition & Setup

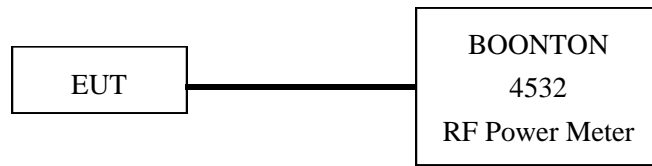

1. The output of the transmitter is connected to the BOONTON RF Power Meter.
2. The calibration is performed before every tests. The values of the output power of the EUT will shown in the dBm directly are the transmitter output peak power. Recording as follows.

7.2 List of Test Instruments

| Instrument Name | Model No. | Brand | Serial No. |
|-----------------|-----------|---------|------------|
| RF Power Meter | 4532 | BOONTON | 117501 |

7.3 Test Result

Formula:
 Signal generator + |Cable loss| = Output peak power

| Channel | Signal Generator | Cable Loss | Limit | Output peak power | |
|---------|------------------|------------|-------|-------------------|--------|
| | dBm | dBm | (DTS) | dBm | mW |
| CH 1 | 15.79 | 0.3 | 100mW | 16.09 | 40.644 |
| CH 6 | 14.56 | 0.3 | 100mW | 14.86 | 30.620 |
| CH 11 | 13.73 | 0.3 | 100mW | 14.03 | 25.293 |

Note:

The limit is vary according to the equipment class, listed below:

1. Digital Transmission System (DTS): 100mW
2. Spread Spectrum Transmitter (DSS): 1W

VIII. Section 15.247 (C): Spurious Emissions (Radiated)

8.1 Test Condition & Setup

We'd performed the test by the *radiated emission* skill: The EUT was placed in an anechoic chamber, and set the EUT transmitting continuously and scanned at 3-meter distance to determine its emission characteristics. The physical arrangement of the EUT was varied (within the scope of arrangements likely to be encountered in actual use) to determine the effect on the unit's emanations in amplitude, directivity, and frequency. The exact system configuration, which produced the highest emissions was noted so it could be reproduced later during the final tests. For the measurement above 1GHz, according to the guidance we'd set the spectrum analyzer's 6dB bandwidth RBW to 1MHz.

This was done to ensure that the final measurements would demonstrate the worst-case interference potential of the EUT.

Final radiation measurements were made on a three-meter, anechoic chamber. The EUT system was placed on a nonconductive turntable, which is 0.8 meters height, top surface 1.0 x 1.5 meter.

The spectrum was examined from 30 MHz to 1000 MHz using an Hewlett Packard 85460A EMI Receiver, Schaffner whole range Bi-Log antenna (Model No.: CBL6141A) is used to measure frequency from 30 MHz to 1GHz. The final test is used the spectrum HP 85460A and spectrum was examined from 1GHz to 18GHz using an Hewlett Packard 8564E Spectrum Analyzer, EMCO Horn Antenna (Model 3115) for 1G ~ 18GHz.

At each frequency, the EUT was rotated 360 degrees, and the antenna was raised and lowered from one to four meters to find the maximum emission levels. Measurements were taken using both horizontal and vertical antenna polarization.

Appropriate preamplifiers were used for improving sensitivity and precautions were taken to avoid overloading or desensitizing the spectrum analyzer. There are two spectrum analyzers use on this testing, HP 85460A for frequency 30MHz to 1000MHz, and 8564E for frequency 1GHz to 18GHz. No post-detector video filters were used in the test. The spectrum analyzer's 6dB bandwidth was set to 120KHz (spectrum was examined from 30 MHz to 1000 MHz), the spectrum analyzer's 6 dB bandwidth was set to 1 MHz (spectrum was examined from 1GHz to 18GHz) and the analyzer was operated in the maximum hold mode. There is a test condition apply in this test item, the test procedure description as the following:

Making access to the mode of continuous transmission by the software in the computer via the USB port. Three channels were tested, one in the top (CH01), one in the middle (CH06) and the other in bottom (CH11).

With the transmitter operating from a AC source and using the internal of EUT, radiates spurious emissions falling within the restricted bands of 15.209 were measured at operating frequencies corresponding to upper, middle and bottom channels in the 2400 ~ 2483.5 MHz band.

The actual field intensity in decibels referenced to 1 microvolt per meter (dB μ V/m) is determined by algebraically adding the measured reading in dB μ V, the antenna factor (dB), and cable loss (dB) at the appropriate frequency. Since the EUT was set to transmit continuously, no *duty cycle* is present.

For frequency between 30MHz to 1000MHz

$$F_{Ia} \text{ (dB}\mu\text{V/m)} = F_{Ir} \text{ (dB}\mu\text{V)} + \text{Correction Factors}$$

F_{Ia} : Actual Field Intensity

F_{Ir} : Reading of the Field Intensity

$$\text{Correction Factors} = \text{Antenna Factor} + \text{Cable Loss} - \text{Amplifier Gain}$$

For frequency between 1 GHz to 18 GHz

$$F_{Ia} \text{ (dB}\mu\text{V/m)} = F_{Ir} \text{ (dB}\mu\text{V)} + \text{Correction Factor}$$

F_{Ia} : Actual Field Intensity

F_{Ir} : Reading of the Field Intensity

$$\text{Correction Factors} = \text{Antenna Factor} + \text{Cable Loss} - \text{Amplifier Gain}$$

The setting up procedure is recorded on Appendix A.

8.2 List of Test Instruments

| <u>Instrument Name</u> | <u>Model No.</u> | <u>Brand</u> | <u>Serial No.</u> | <u>Last time</u> | <u>Next time</u> |
|--|------------------|--------------|-------------------|------------------|------------------|
| Spectrum analyzer | 8591EM | H P | 3710A01203 | 05/29/02 | 05/29/03 |
| Pre-selector (>30MHz) | AMP-01 | TRC | REP-001 | 10/02/02 | 10/02/03 |
| Spectrum analyzer | 8568B | H P | 3004A18617 | 06/19/02 | 06/19/03 |
| Quasi-peak Adapter | 85650A | H P | 2521A00984 | 06/20/02 | 06/20/03 |
| RF Pre-selector | 85685A | H P | 2947A01011 | 06/20/02 | 06/20/03 |
| RF Pre-selector | AMP-01 | TRC | REP-002 | 10/02/02 | 10/02/03 |
| Bi-log Antenna | VULB9160 | M. E. | 3064 | 07/09/02 | 07/09/03 |
| Antenna (30M-2GHz) | 3142 | EMCO | 9610-1094 | 10/02/02 | 10/02/03 |
| Open test side (Antenna, Amplify, cable calibrated together) | | | | 05/20/02 | 05/20/03 |
| Spectrum Analyzer | 8564E | HP | US36433002 | 08/01/02 | 08/01/03 |
| Microwave Preamplifier | 83051A | HP | 3232A00347 | 08/01/02 | 08/01/03 |
| Horn Antenna | 3115 | EMCO | 9704 – 5178 | 08/01/02 | 08/01/03 |

The level of confidence of 95% , the uncertainty of measurement of radiated emission is ± 3.44 dB.

Report No.: B2215836

Training Research Co., Ltd., TEL: 886-2-26935155, Fax: 886-2-26934440

8.3 Test Result of Spurious Radiated Emissions

EUT's transmit only

The highest peak values of radiated emissions from the EUT at various antenna heights, antenna polarizations, EUT orientation, etc. are recorded on the following.

Test Conditions:

Testing room : Temperature : 26 ° C Humidity : 44 % RH

Table 1 Radiated Emissions for 30MHz 1GHz [Horizontal]

| Radiated Emission | | | | Correction Factors | Corrected Amplitude | FCC Class B (3 m) | |
|--------------------------|-------------------------|--------------------|--------------------|---------------------------|----------------------------|----------------------------|--------------------|
| Frequency (MHz) | Amplitude (dBmV) | Ant. H. (m) | Table (°) | | | Limit (dBmV/m) | Margin (dB) |
| 144.01 | 12.23 | 2.50 | 297 | 17.94 | 30.17 | 43.50 | -13.33 |
| 240.02 | 12.65 | 1.00 | 132 | 18.53 | 31.18 | 46.00 | -14.82 |
| 279.07 | 10.06 | 1.00 | 83 | 20.66 | 30.72 | 46.00 | -15.28 |
| 333.12 | 10.70 | 1.00 | 338 | 22.21 | 32.91 | 46.00 | -13.09 |
| 433.16 | 8.49 | 1.00 | 119 | 25.42 | 33.91 | 46.00 | -12.09 |
| 748.00 | 5.66 | 1.00 | 330 | 33.70 | 39.36 | 46.00 | -6.64 |

Note:

1. Margin = Amplitude – limit, *if margin is minus means under limit.*
2. Corrected Amplitude = Reading Amplitude + Correction Factors
3. Correction factor = Antenna factor + (Cable Loss – Amplitude gain)

Table 2 Radiated Emissions For 30MHz 1GHz [Vertical]

| Radiated Emission | | | | Correction Factors | Corrected Amplitude | FCC Class B (3 m) | |
|--------------------------|-------------------------|--------------------|--------------------|---------------------------|----------------------------|----------------------------|--------------------|
| Frequency (MHz) | Amplitude (dBmV) | Ant. H. (m) | Table (°) | | | Limit (dBmV/m) | Margin (dB) |
| 144.02 | 7.51 | 1.00 | 267 | 17.94 | 25.45 | 43.50 | -18.05 |
| 192.02 | 8.08 | 1.00 | 240 | 16.91 | 24.99 | 43.50 | -18.51 |
| 398.60 | 6.70 | 1.00 | 308 | 25.25 | 31.95 | 46.00 | -14.05 |
| 432.05 | 6.93 | 1.00 | 148 | 25.42 | 32.35 | 46.00 | -13.65 |
| 498.02 | 5.71 | 1.00 | 343 | 27.98 | 33.69 | 46.00 | -12.31 |
| 748.00 | 4.76 | 1.00 | 84 | 33.70 | 38.46 | 46.00 | -7.54 |

Report No.: B2215836

Training Research Co., Ltd., TEL: 886-2-26935155, Fax: 886-2-26934440

Table 3 Open Field Radiated Emissions For 1GHz 18GHz [Horizontal] [CH 1]

| Radiated Emission | | | | Corrected Amplitude | | FCC Class B (3m) | | |
|-------------------|-------------|-------------|-------------------------|---------------------|---------|--------------------|-------|-------------|
| Frequency (MHz) | Ant. H. (m) | Table (°) | Correction Factors (dB) | (dBµV/m) | | Limit (dBµV/m) | | Margin (dB) |
| | | | | Peak | Average | Peak | Ave. | |
| 4825.14 | 1.00 | 305 | 3.76 | 40.70 | --- | 74.00 | 54.00 | -13.30 |
| | | | | | | | | |
| | | | | | | | | |
| | | | | | | | | |

Table 4 Open Field Radiated Emissions For 1GHz 18GHz [Vertical] [CH 1]

| Radiated Emission | | | | Corrected Amplitude | | FCC Class B (3m) | | |
|-------------------|-------------|-------------|-------------------------|---------------------|---------|--------------------|-------|-------------|
| Frequency (MHz) | Ant. H. (m) | Table (°) | Correction Factors (dB) | (dBµV/m) | | Limit (dBµV/m) | | Margin (dB) |
| | | | | Peak | Average | Peak | Ave. | |
| 2038.01 | 1.00 | 121 | 3.30 | 53.82 | 52.71 | 74.00 | 54.00 | -1.29 |
| 4825.14 | 1.00 | 22 | 3.76 | 46.54 | --- | 74.00 | 54.00 | -7.46 |
| | | | | | | | | |
| | | | | | | | | |

Note:

1. Margin = Corrected - Limit.
2. The EUT utilizes a *permanently attached antenna*. In addition the spurious RF conducted emissions levels do comply with the *20dBc limit* both at its bandedges and other spurious emissions.
- 3.As stated in Section 15.35(b), for any frequencies above 1000MHz, radiated limits shown are based upon the use of measurement instrumentation employing an average detector function. As the results of our test, the peak amplitudes are already below the FCC limit. Thus the average amplitudes of the rest are omitted.

Table 5 Open Field Radiated Emissions For 1GHz 18GHz [Horizontal] [CH 6]

| Radiated Emission | | | | Corrected Amplitude | | FCC Class B (3m) | | |
|-------------------|-------------|-------------|-------------------------|---------------------|---------|--------------------|-------|-------------|
| Frequency (MHz) | Ant. H. (m) | Table (°) | Correction Factors (dB) | (dBµV/m) | | Limit (dBµV/m) | | Margin (dB) |
| | | | | Peak | Average | Peak | Ave. | |
| 4873.47 | 1.00 | 2 | 3.95 | 46.06 | --- | 74.00 | 54.00 | -7.94 |
| | | | | | | | | |
| | | | | | | | | |
| | | | | | | | | |

Table 6 Open Field Radiated Emissions For 1GHz 18GHz [Vertical] [CH 6]

| Radiated Emission | | | | Corrected Amplitude | | FCC Class B (3m) | | |
|-------------------|-------------|-------------|-------------------------|---------------------|---------|--------------------|-------|-------------|
| Frequency (MHz) | Ant. H. (m) | Table (°) | Correction Factors (dB) | (dBµV/m) | | Limit (dBµV/m) | | Margin (dB) |
| | | | | Peak | Average | Peak | Ave. | |
| 2063.02 | 1.00 | 56 | 3.24 | 53.58 | 52.98 | 74.00 | 54.00 | -1.02 |
| 4873.47 | 1.00 | 177 | 3.95 | 48.73 | --- | 74.00 | 54.00 | -5.27 |
| | | | | | | | | |
| | | | | | | | | |

Note:

1. Margin = Corrected - Limit.
2. The EUT utilizes a *permanently attached antenna*. In addition the spurious RF conducted emissions levels do comply with the *20dBc limit* both at its bandedges and other spurious emissions.
3. As stated in Section 15.35(b), for any frequencies above 1000MHz, radiated limits shown are based upon the use of measurement instrumentation employing an average detector function. As the results of our test, the peak amplitudes are already below the FCC limit. Thus the average amplitudes of the rest are omitted.

Report No.: B2215836

Training Research Co., Ltd., TEL: 886-2-26935155, Fax: 886-2-26934440

Table 7 Open Field Radiated Emissions For 1GHz 18GHz [Horizontal] [CH 11]

| Radiated Emission | | | | Corrected Amplitude | | FCC Class B (3m) | | |
|-------------------|-------------|-------------|-------------------------|---------------------|---------|--------------------|-------|-------------|
| Frequency (MHz) | Ant. H. (m) | Table (°) | Correction Factors (dB) | (dBµV/m) | | Limit (dBµV/m) | | Margin (dB) |
| | | | | Peak | Average | Peak | Ave. | |
| 4925.84 | 1.00 | 149 | 4.13 | 42.90 | --- | 74.00 | 54.00 | -11.10 |
| | | | | | | | | |
| | | | | | | | | |
| | | | | | | | | |

Table 8 Open Field Radiated Emissions For 1GHz 18GHz [Vertical] [CH 11]

| Radiated Emission | | | | Corrected Amplitude | | FCC Class B (3m) | | |
|-------------------|-------------|-------------|-------------------------|---------------------|---------|--------------------|-------|-------------|
| Frequency (MHz) | Ant. H. (m) | Table (°) | Correction Factors (dB) | (dBµV/m) | | Limit (dBµV/m) | | Margin (dB) |
| | | | | Peak | Average | Peak | Ave. | |
| 2088.02 | 1.00 | 45 | 3.17 | 53.88 | 53.09 | 74.00 | 54.00 | -0.91 |
| 4925.84 | 1.00 | 289 | 4.13 | 45.24 | --- | 74.00 | 54.00 | -8.76 |
| | | | | | | | | |
| | | | | | | | | |

Note:

1. Margin = Corrected - Limit.
2. The EUT utilizes a *permanently attached antenna*. In addition the spurious RF conducted emissions levels do comply with the *20dBc limit* both at its bandedges and other spurious emissions.
- 3.As stated in Section 15.35(b), for any frequencies above 1000MHz, radiated limits shown are based upon the use of measurement instrumentation employing an average detector function. As the results of our test, the peak amplitudes are already below the FCC limit. Thus the average amplitudes of the rest are omitted.

8.4 Test Result of the Bandedge

If any 100 kHz bandwidth outside these frequency bands, the radio frequency power that is produced by the modulation products of the spreading sequence, the information sequence and the carrier frequency shall be either *at least 20 dB below that in any 100 kHz bandwidth within the band that contains the highest level of the desired power or shall not exceed the general levels specified in § 15.209(a)*,

We perform this section by the *conducted* manner, the RBW is set to 100kHz and VBW>RBW. We'd made the observation *up to 10th harmonics and the criterion is all the harmonic/spurious emissions must be 20dB below the highest emission level measured*. If the emissions fall in the restricted bands stated in the Part15.205(a) must also *comply with the radiated emission limits specified in Part15.209(a)*.

The following pages show our observations referring to the channel 1 and 11 respectively.

Test Condition & Setup: same as 3.1

Channel 1

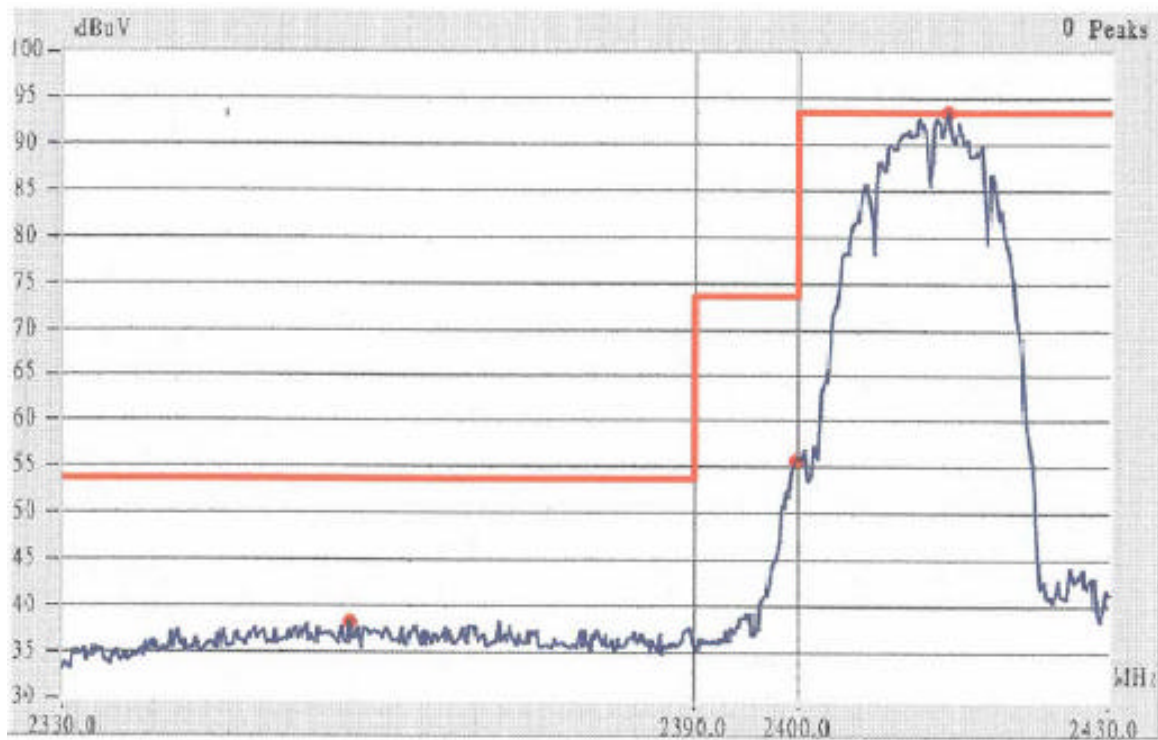

This is the hard copy of our bandedge measurement generated by our bandedge testing program. The picture shown above is the bandedge of channel 1.

1. The lobe right by the fundamental side is already 20dB below the highest emission level.
2. The emissions recorded in the restricted band (<2400MHz) is do comply with the Part 15.209(a) – under the limited line marked in red color.

Report No.: B2215836

Training Research Co., Ltd., TEL: 886-2-26935155, Fax: 886-2-26934440

Channel 11

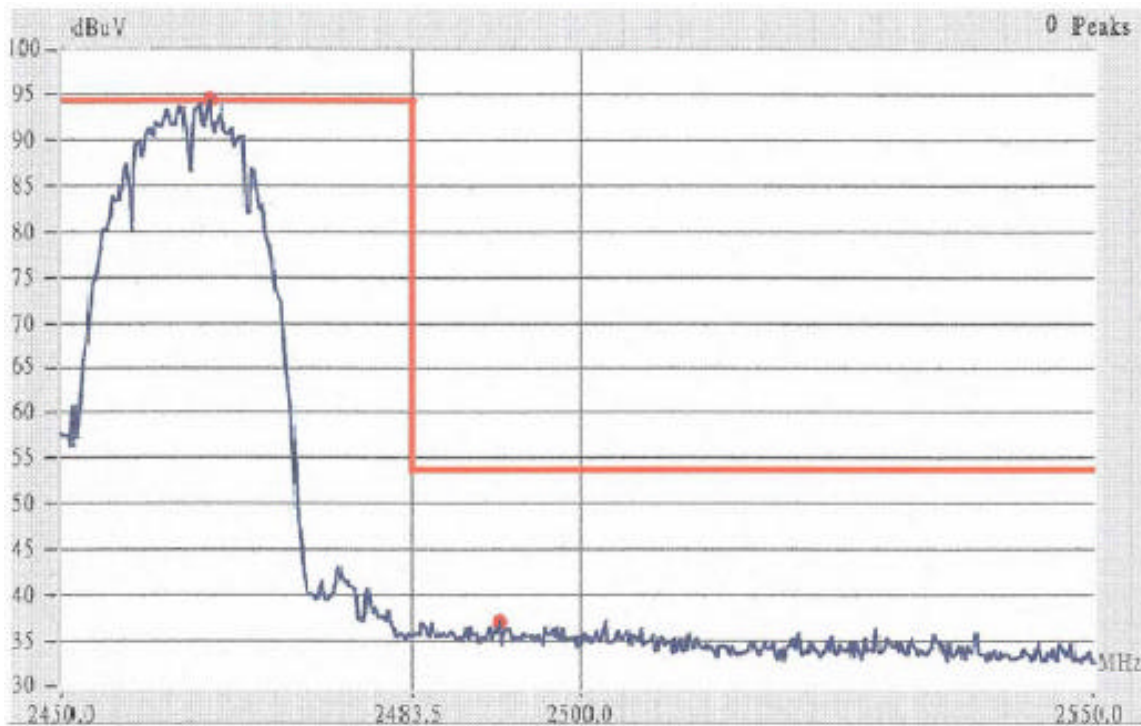

This is the hard copy of our bandedge measurement generated by our bandedge testing program. The picture shown above is the bandedge of channel 11.

1. The lobe right by the fundamental side is already 20dB below the highest emission level.
2. The emissions recorded in the restricted band (>2483.5MHz) is do comply with the Part 15.209(a) – under the limited line marked in red color.

Report No.: B2215836

Training Research Co., Ltd., TEL: 886-2-26935155, Fax: 886-2-26934440

IX. Section 15.247(d): Power Spectral Density

9.1 Test Condition & Setup

The tests below are running with the EUT transmitter set at high power in TDD mode . The EUT is needed to force selection of output power level and channel number. While testing, the EUT was set to transmit continuously and to be tested by the contact manner with the spectrum analyzer.

The attachments below show our observation.

9.2 Test Instruments Configuration

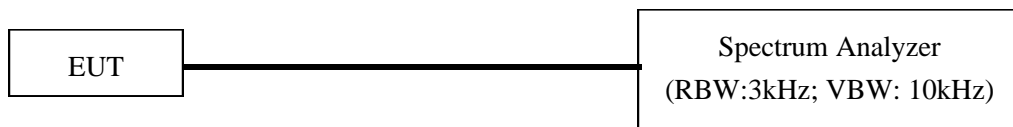

P.S.: Notebook computer to control the EUT at maximal power output and channel Number and set antenna kit

9.3 List of Test Instruments

| Instrument Name | Model No. | Brand | Serial No. | Last time | Next time |
|-------------------|-----------|-------|------------|-----------|-----------|
| Spectrum Analyzer | 8592A | H P | 3003AD1401 | 01/02/02 | 01/01/03 |

9.4 Test Result of Power spectral density

The following table shows a summary of the test results of the Power Spectral Density.

| Channel | Frequency (GHz) | Ppr (dBm) | Cable Loss (dB) | Ppq (dBm) | Limit (dB) | Margin (dB) |
|---------|-----------------|-----------|-----------------|-----------|------------|-------------|
| CH 01 | 2.412 | -13.33 | 1.80 | -11.53 | 8.00 | -19.53 |
| CH 06 | 2.437 | -14.00 | 1.85 | -12.15 | 8.00 | -20.15 |
| CH 11 | 2.462 | -15.33 | 1.93 | -13.40 | 8.00 | -21.40 |

Note:

- 1.The following pages show the results of spectrum reading.
- 2.Ppr: spectrum read power density (using peak search mode),
Ppq: actual peak power density in the spread spectrum band.
- 3.Ppq = Ppr + |Cable Loss|

Report No.: B2215836

Training Research Co., Ltd., TEL: 886-2-26935155, Fax: 886-2-26934440

Channel 01

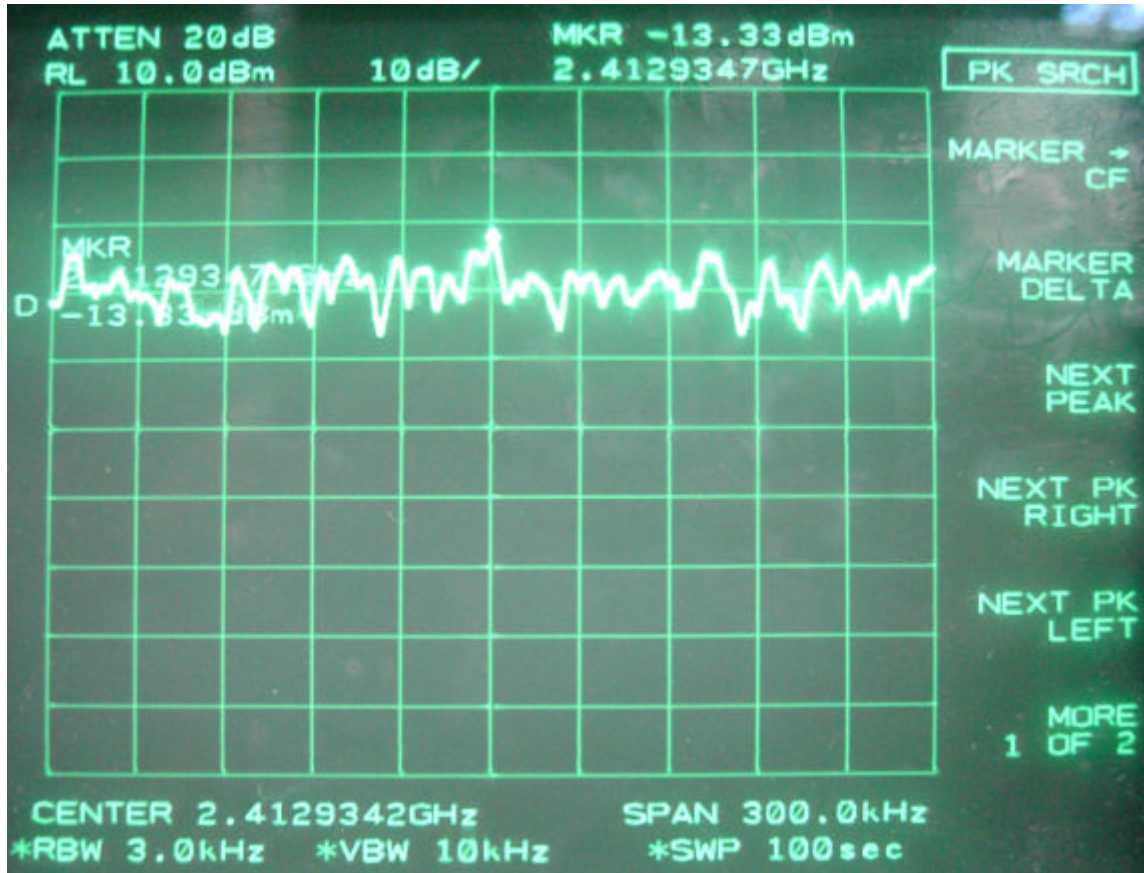

Report No.: B2215836

Training Research Co., Ltd., TEL: 886-2-26935155, Fax: 886-2-26934440

Channel 06

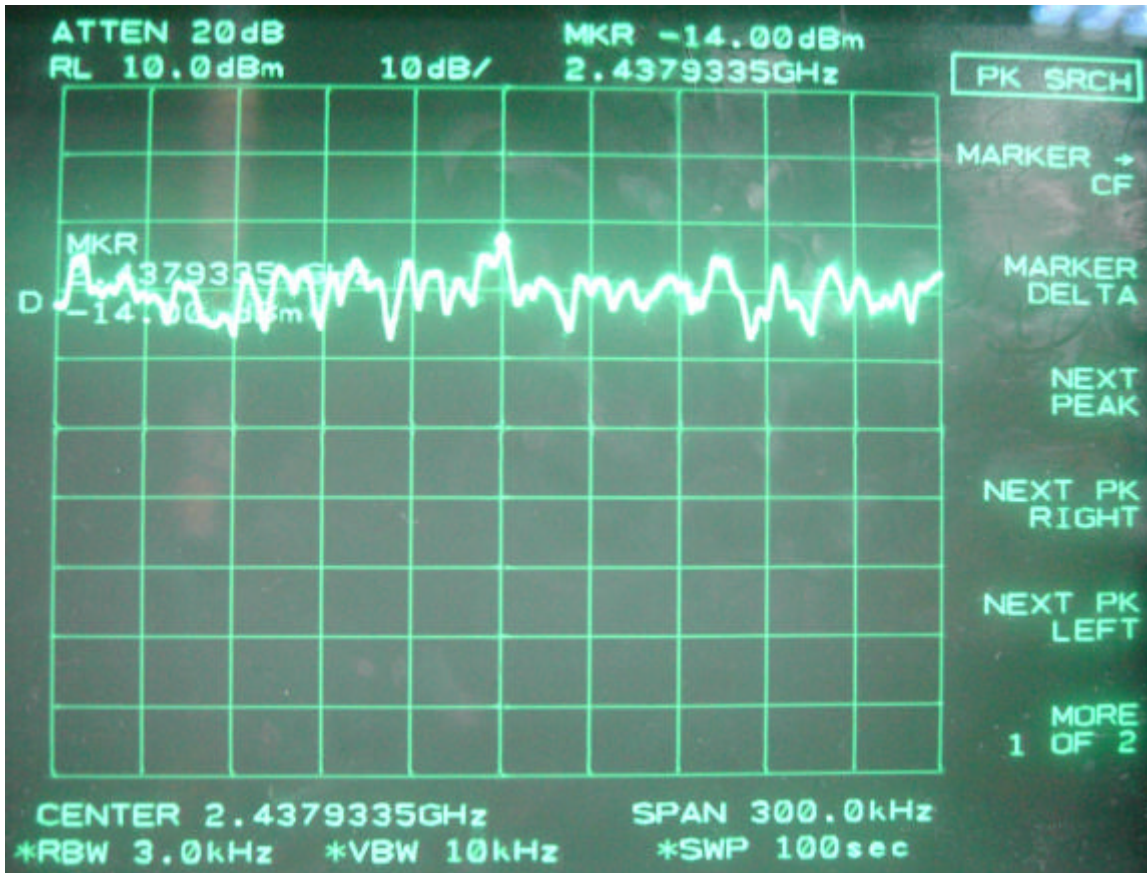

Report No.: B2215836

Training Research Co., Ltd., TEL: 886-2-26935155, Fax: 886-2-26934440

Channel 11

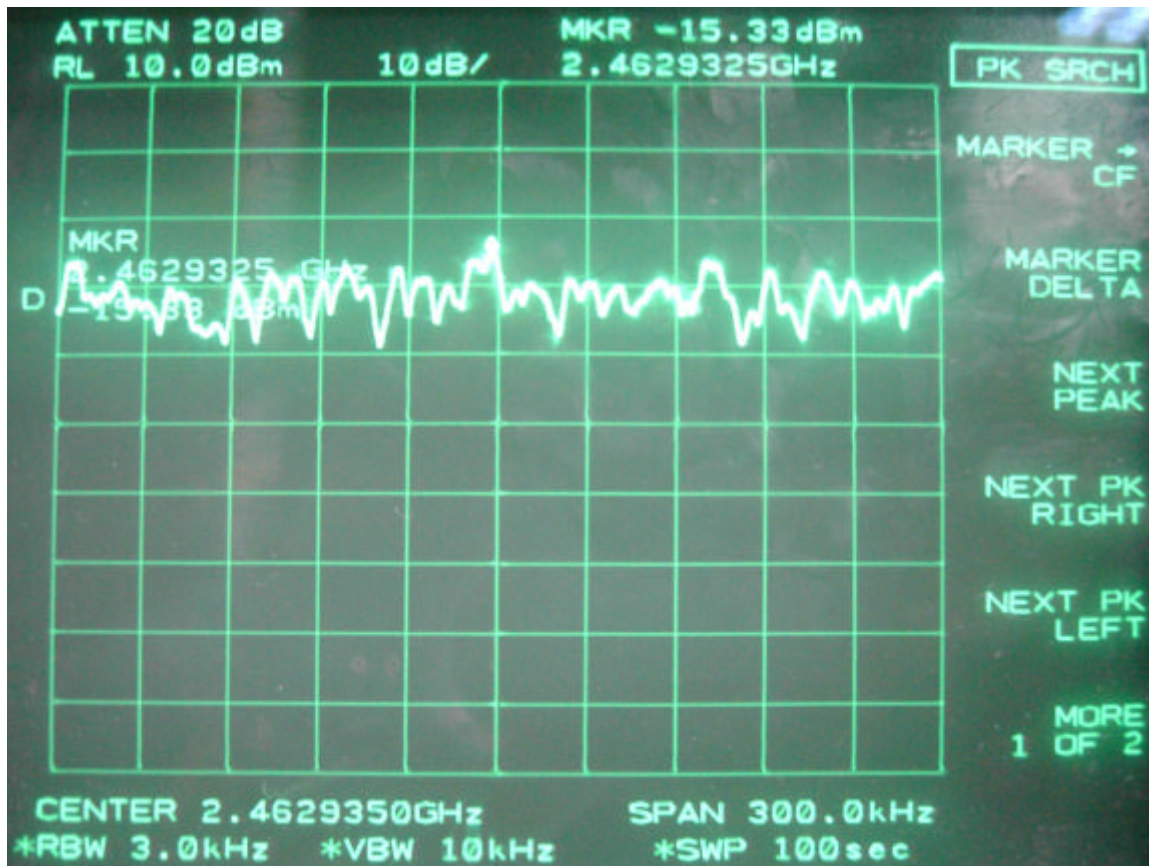

Report No.: B2215836

Training Research Co., Ltd., TEL: 886-2-26935155, Fax: 886-2-26934440