



FCC TEST REPORT

for

47 CFR Part 15 Subpart C

Equipment : GSM850/DCS1800/PCS1900 Tri Band Mobile Phone
Trade Name : Siemens
Model No. : AP75a
FCC ID : JVPAP75A
BenQ Ref. No. : KH-6306
Filing Type : Certification
Applicant : **BenQ Corporation**
157 Shan-Ying Road, Gueishan Taoyuan 333, Taiwan

- The test result refers exclusively to the test presented test model / sample.
- Without written approval of SPORTON International Inc., the test report shall not be reproduced except in full.
- **Certificate or Test Report must not be used by the applicant to claim the product in this test report endorsement by NVLAP or any agency of U.S. government.**
- The data shown in this test report were carried out on Jan. 26, 2006 at **Sporton International Inc. LAB.**
- Report No.: FR611612, Report Version: Rev. 01.

Dr. Daniel Lee
EMC/SAR Director

SPORTON International Inc.

6F, No.106, Sec. 1, Hsin Tai Wu Rd., Hsi Chih, Taipei Hsien, Taiwan, R.O.C.

SPORTON International Inc.

TEL : 886-2-2696-2468

FAX : 886-2-2696-2255

Report Version: Rev. 01



Table of Contents

History of this test report.....ii

1. General Description of Equipment under Test.....1

 1.1.Applicant.....1

 1.2.Manufacturer1

 1.3.Basic Description of Equipment under Test.....1

 1.4.Feature of Equipment under Test1

2. Test Configuration of Equipment under Test2

 2.1.Test Manner2

 2.2.Test Mode2

 2.3.Connection Diagram of Test System2

 2.4.Ancillary Equipment List.....2

3. RF Utility3

4. General Information of Test.....4

 4.1.Test Voltage4

 4.2.Standard for Methods of Measurement.....4

 4.3.Test in Compliance with4

 4.4.Frequency Range Investigated4

 4.5.Test Distance4

5. Report of Measurements and Examinations5

 5.1.List of Measurements and Examinations5

 5.2.Hopping Channel Separation6

 5.3.Number of Hopping Frequency10

 5.5 Dwell Time of Each Frequency within a 30 Seconds Period16

 5.6 Output Power36

 5.7 100kHz Bandwidth of Frequency Band Edges40

 5.8 Conducted Emission44

 5.9 Radiated Emission Measurement49

 5.10 Antenna Requirements.....54

6. List of Measuring Equipments Used55

7. Uncertainty Evaluation.....56

Appendix A. External Product Photograph

Appendix B. Internal Photograph

Appendix C. Setup Photograph



History of this test report

Report Issue Date: Jan. 26, 2006

Report No.	Description



1. General Description of Equipment under Test

1.1. Applicant

BenQ Corporation
157 Shan-Ying Road, Gueishan Taoyuan 333, Taiwan

1.2. Manufacturer

- 1. **BenQ Corporation**
157 Shan-Ying Road, Gueishan Taoyuan 333, Taiwan
- 2. **BenQ Electronics (Suzhou) Co., Ltd.**
No. 169, Zhujiang Road, New District, Suzhou, Jiangsu, P.R., China

1.3. Basic Description of Equipment under Test

Equipment : GSM850/DCS1800/PCS1900 Tri Band Mobile Phone
 Trade Name : Siemens
 Model No. : AP75a
 FCC ID : JVPAP75A
 Power Supply Type : Switching
 AC Power Cord : AC 120V, Weave-Shielded, Wall-mount, 1.6 meter, 2 pin
 Battery : BenQ, 23.20107.402
 Adapter : BenQ, MP21
 Earpiece : 23.43026.XXX (X=0~9, A~Z, or Blank)

1.4. Feature of Equipment under Test

Product Feature & Specification	
1. Modulation Type/Data Rate	GFSK
2. Frequency Range.	2400 MHz ~ 2483.5 MHz
Number of Channels	79
3. Carrier Frequency of each channel	2402+ n*1 MHz, n= 0~78
4. Channel Spacing	1 MHz
5. Maximum Output Power to Antenna (Normal condition)	-0.93 dBm
6. Type of Antenna Connector	N/A
7. Antenna Type	Fixed Internal
8. Antenna Gain	0 dBi
9. HW Version	LPR3
10. SW Version	V0.02
11. Function Type	Transmitter Transceiver V
12. Power Rating (DC/AC , Voltage and Current of RF element or PA)	2.8V / 40mA
13. DUT Stage	Identical Prototype

2. Test Configuration of Equipment under Test

2.1. Test Manner

- a. The EUT has been associated with peripherals pursuant to ANSI C63.4-2003 and configuration operated in a manner tended to maximize its emission characteristics in a typical application.
- b. For spurious emission below 1GHz, only one channel of each application was tested because it is not related to channel selection.
- c. The EUT is programmed to transmit signal continuously for all testings.
- d. Frequency range investigated: conduction 150 kHz to 30 MHz, radiation 30 MHz to 25000MHz.

2.2. Test Mode

Application	Bluetooth
Radiated Emission and conducted test items	Mode 1: Tx_CH00_2402 MHz Mode 2: Tx_CH39_2441 MHz Mode 3: Tx_CH78_2480 MHz
Conducted Emission	Mode 1: PCS Idle Mode + Camera Mode 2: PCS Idle Mode + Bluetooth On

2.3. Connection Diagram of Test System

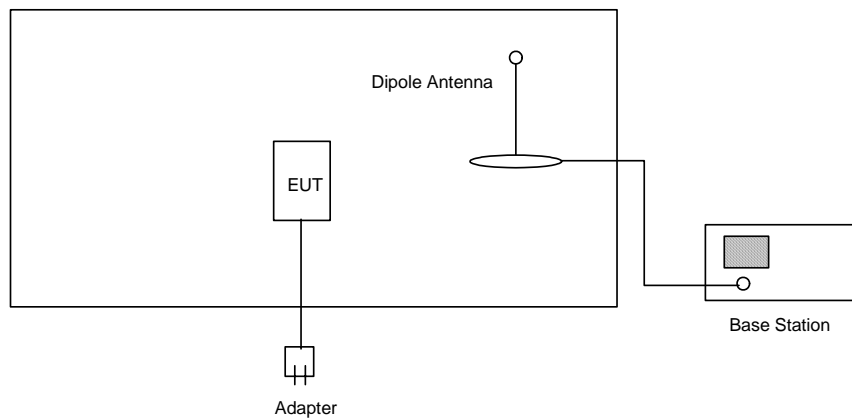

2.4. Ancillary Equipment List

Item	Equipment	Model No.	Power Cord
1.	Base Station (R&S)	CMU200	N/A
2.	Dipole Antenna (Sporton)	N/A	N/A



3. RF Utility

The EUT is connected with Base station, CMU200, to send transmitting signal for all testing.



4. General Information of Test

Test Site Location : No. 52, Hwa Ya 1st Rd., Hwa Ya Technology Park,
Kwei-Shan Hsiang, Tao Yuan Hsien, Taiwan, R.O.C.
TEL : 886-3-327-3456
FAX : 886-3-318-0055
Test Site No : CO01-HY, 03CH06-HY

4.1. Test Voltage

AC 120V

4.2. Standard for Methods of Measurement

ANSI C63.4-2003

4.3. Test in Compliance with

47 CFR Part 15 Subpart C

4.4. Frequency Range Investigated

Conduction: from 150 kHz to 30 MHz
Radiation: from 30 MHz to 25000MHz

4.5. Test Distance

The test distance of radiated emission from antenna to EUT is 3 m.



5. Report of Measurements and Examinations

5.1. List of Measurements and Examinations

FCC Rule	Description of Test	Result	Section
15.247(a)(1)	Hopping Channel Separation	Pass	5.2
15.247(a)(1)(iii)	Number of Hopping Frequency Used	Pass	5.3
15.247(a)(1)	Hopping Channel Bandwidth	Pass	5.4
15.247(a)(1)(iii)	Dwell Time of Each Frequency	Pass	5.5
15.247(b)(1)	Output Power	Pass	5.6
15.247(c)	100kHz Bandwidth of Frequency Band Edges	Pass	5.7
15.207	Conducted Emission	Pass	5.8
15.209	Radiated Emission	Pass	5.9
15.203	Antenna Requirement	Pass	5.10

5.2. Hopping Channel Separation

5.2.1. Measuring Instruments :

As described in chapter 6 of this test report.

5.2.2. Test Procedure :

1. The transmitter output was connected to the spectrum analyzer directly.
2. Set RBW of spectrum analyzer to 30kHz and VBW to 100kHz.
3. The Hopping Channel Separation is defined as the channel is separated with the next channel.

5.2.3. Test Setup Layout :

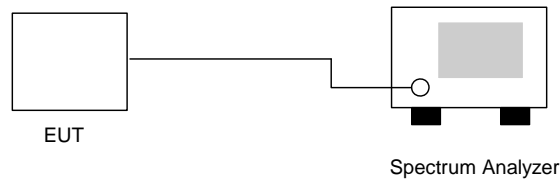

5.2.4. Test Result : The spectrum analyzer plots are attached as below

- Temperature: 26°C
- Relative Humidity: 53%
- Test Engineer : Jay

Channel	Frequency (MHz)	Hopping Channel Separation (MHz)	Limits (MHz)	Plot Ref. No.
00	2402	1.0	0.868	Mode 1
39	2441	1.0	0.872	Mode 2
78	2480	1.0	0.872	Mode 3

Remark: Limit is the greater one of 25kHz or the 20dB bandwidth of the hopping channel.



5.2.5 Hopping Channel Separation

Mode 1: CH00 (2402MHz)

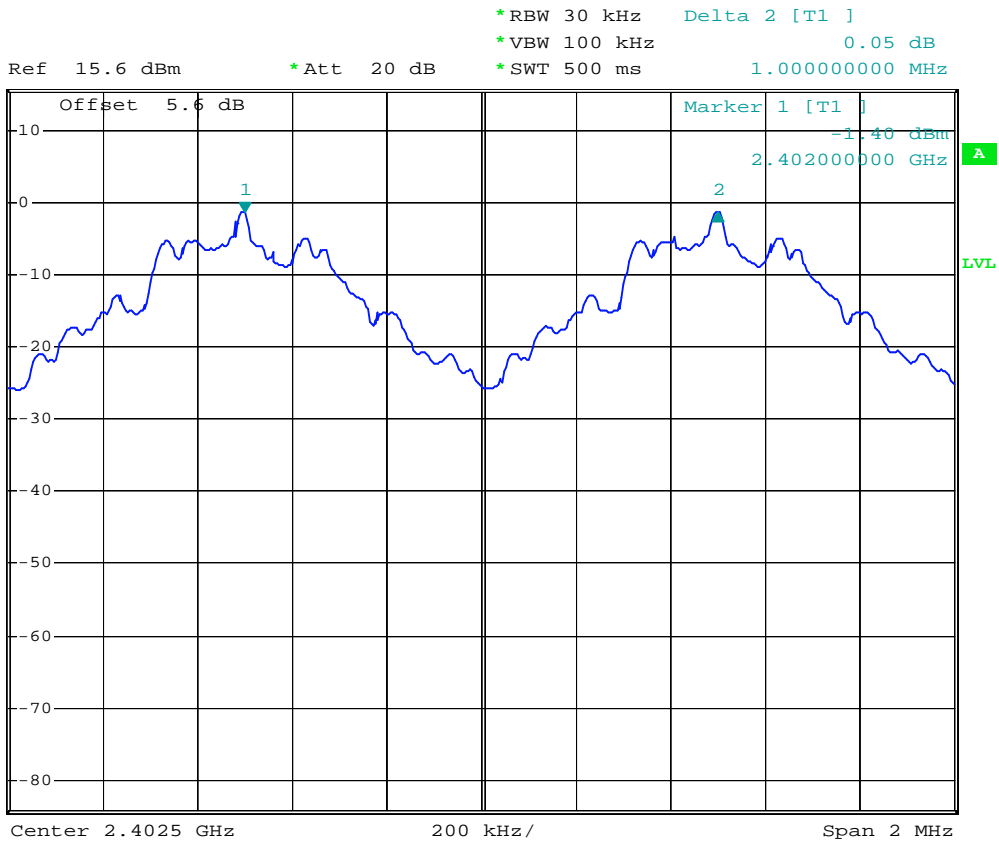



Mode 2: CH39 (2441MHz)



Ref 15.6 dBm *Att 20 dB *RBW 30 kHz Delta 2 [T1]
*VBW 100 kHz 0.01 dB
*SWT 500 ms 1.000000000 MHz

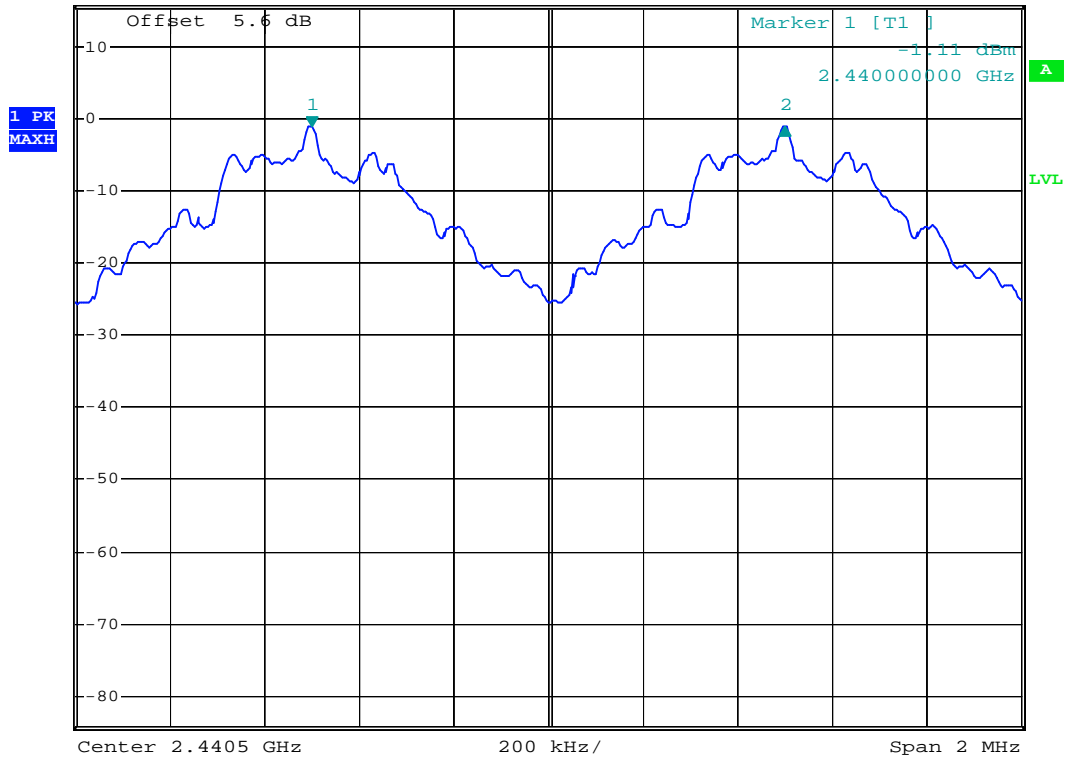



Mode 3: CH78 (2480MHz)



Ref 15.6 dBm *Att 20 dB *RBW 30 kHz Delta 2 [T1]
 *VBW 100 kHz 0.01 dB
 *SWT 500 ms 1.000000000 MHz

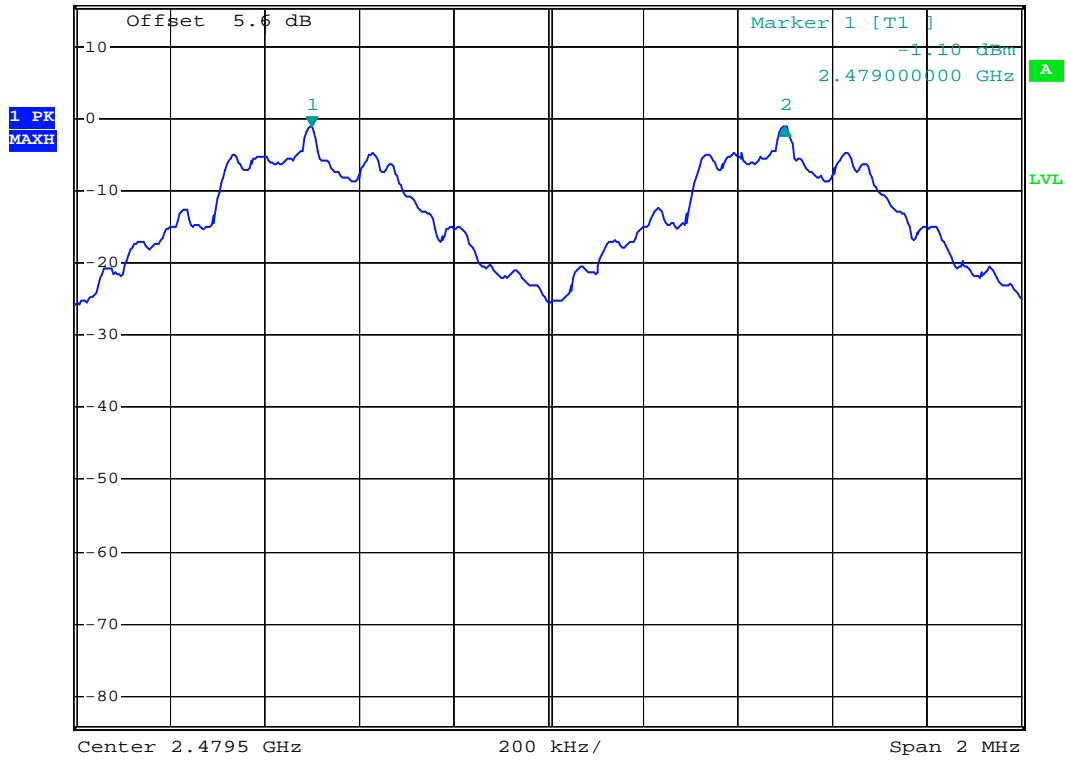

5.3. Number of Hopping Frequency

5.3.1. Measuring Instruments :

As described in chapter 6 of this test report.

5.3.2. Test Procedure :

1. The transmitter output was connected to the spectrum analyzer directly.
2. Set RBW of spectrum analyzer to 100kHz and VBW to 100kHz.
3. The number of hopping frequency used is defined as the device has the numbers of total channel.

5.3.3. Test Setup Layout :

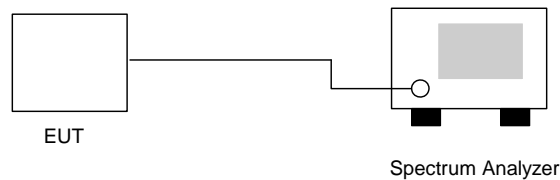

5.3.4. Test Result : See spectrum analyzer plots below

- Temperature: 26°C
- Relative Humidity: 53%
- Test Engineer : Jay

Number of Hopping Frequency (Channel)	Limits (Channel)
79	15



5.3.5 Number of Hopping Frequency

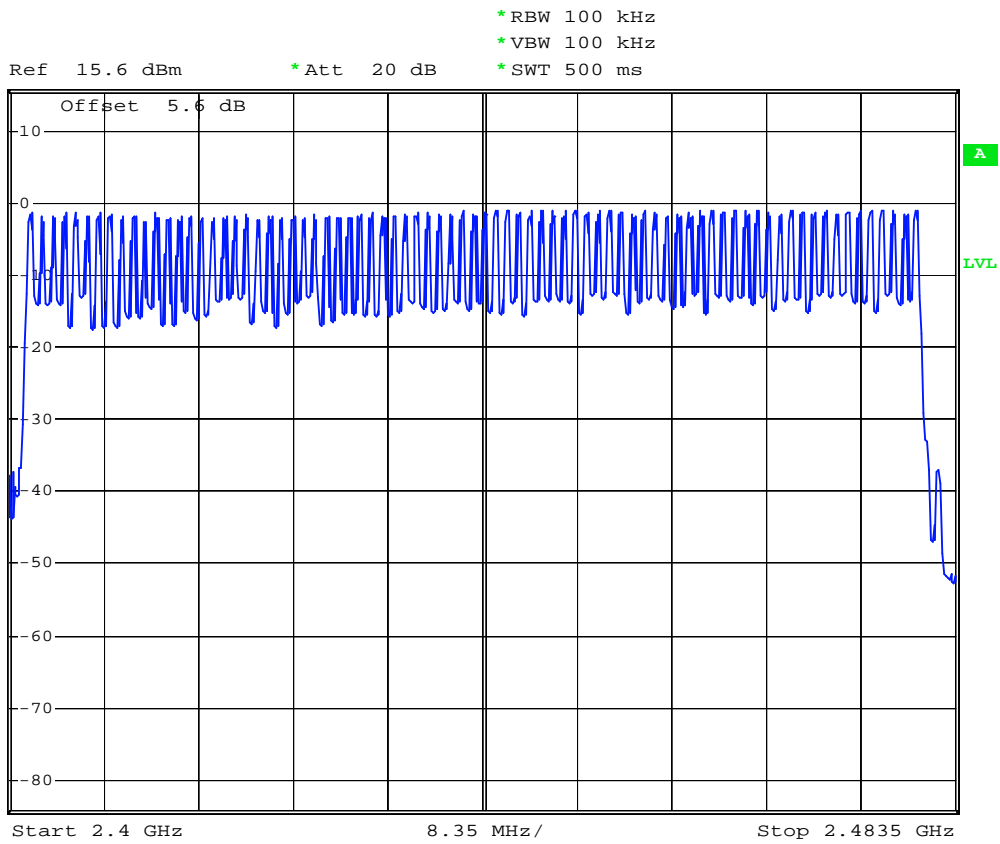

5.4 Hopping Channel Bandwidth

5.4.1 Measuring Instruments :

As described in chapter 6 of this test report.

5.4.2 Test Procedure :

1. The transmitter output was connected to the spectrum analyzer directly.
2. Set RBW of spectrum analyzer to 30kHz and VBW to 300kHz.
3. The Hopping Channel bandwidth is defined as the frequency range where the power is higher than peak power minus 20dB.

5.4.3 Test Setup Layout :

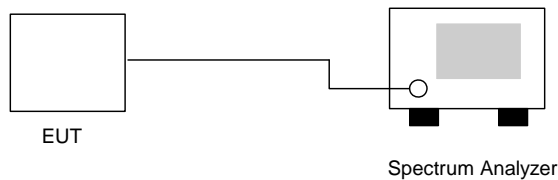

5.4.4 Test Result : See spectrum analyzer plots below

- Temperature: 26°C
- Relative Humidity: 53%
- Test Engineer : Jay

Channel	Frequency (MHz)	Hopping Channel Bandwidth (MHz)	Limits (MHz)	Plot Ref. No.
00	2402	0.868	1.0	Mode 1
39	2441	0.872	1.0	Mode 2
78	2480	0.872	1.0	Mode 3



5.4.5 Hopping Channel Bandwidth

Mode 1: CH00 (2402MHz)



Ref 15.6 dBm *Att 20 dB *RBW 30 kHz Delta 2 [T1]
 *VBW 300 kHz 0.11 dB
 *SWT 500 ms 868.00000000 kHz

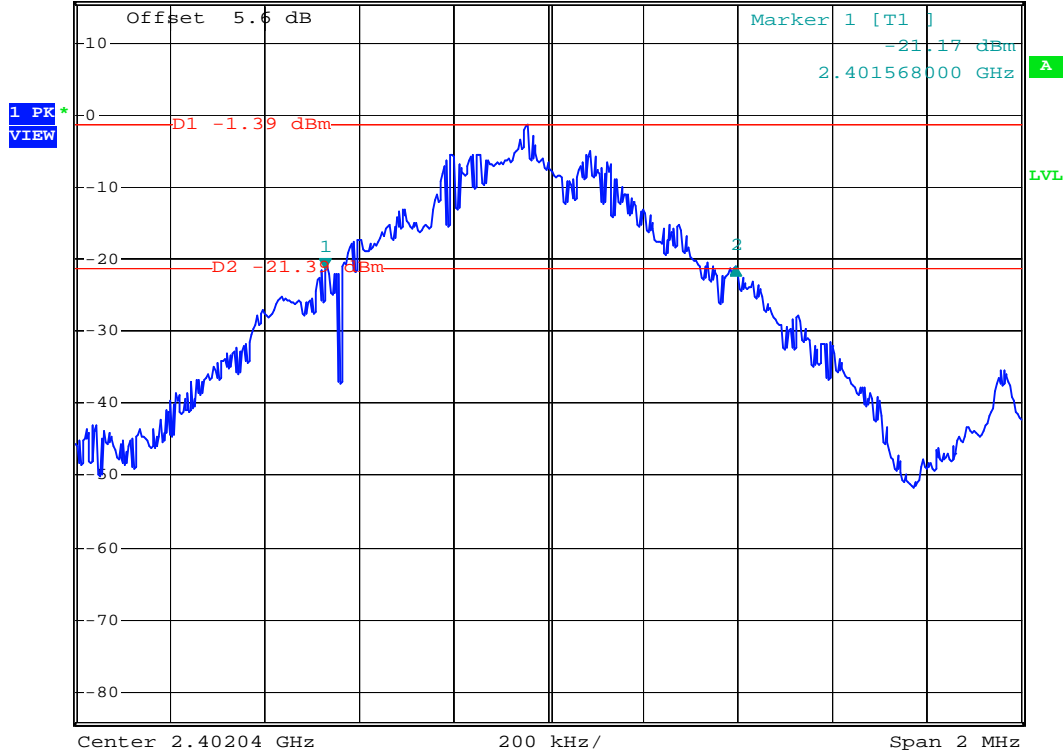



Mode 2: CH39 (2441MHz)



*RBW 30 kHz Delta 2 [T1]
 *VBW 300 kHz -0.19 dB
 *SWT 500 ms 872.000000000 kHz

Ref 15.6 dBm

*Att 20 dB

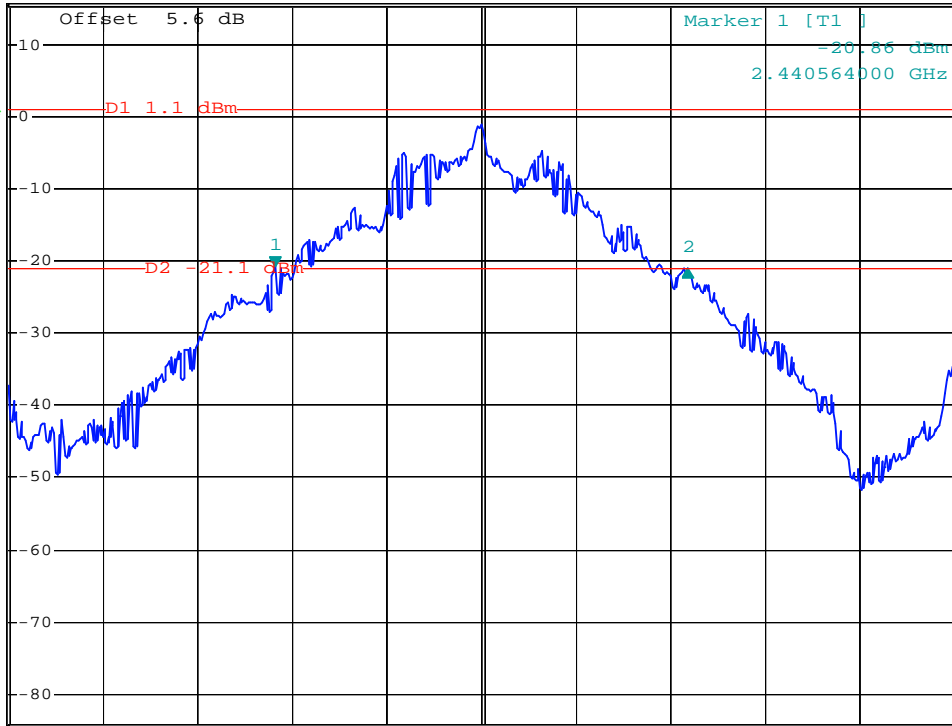

Center 2.441 GHz 200 kHz/ Span 2 MHz



Mode 3: CH78 (2480MHz)



*RBW 30 kHz Delta 2 [T1]
 *VBW 300 kHz -0.17 dB
 *SWT 500 ms 872.000000000 kHz

Ref 15.6 dBm

*Att 20 dB

1 PK*
VIEW

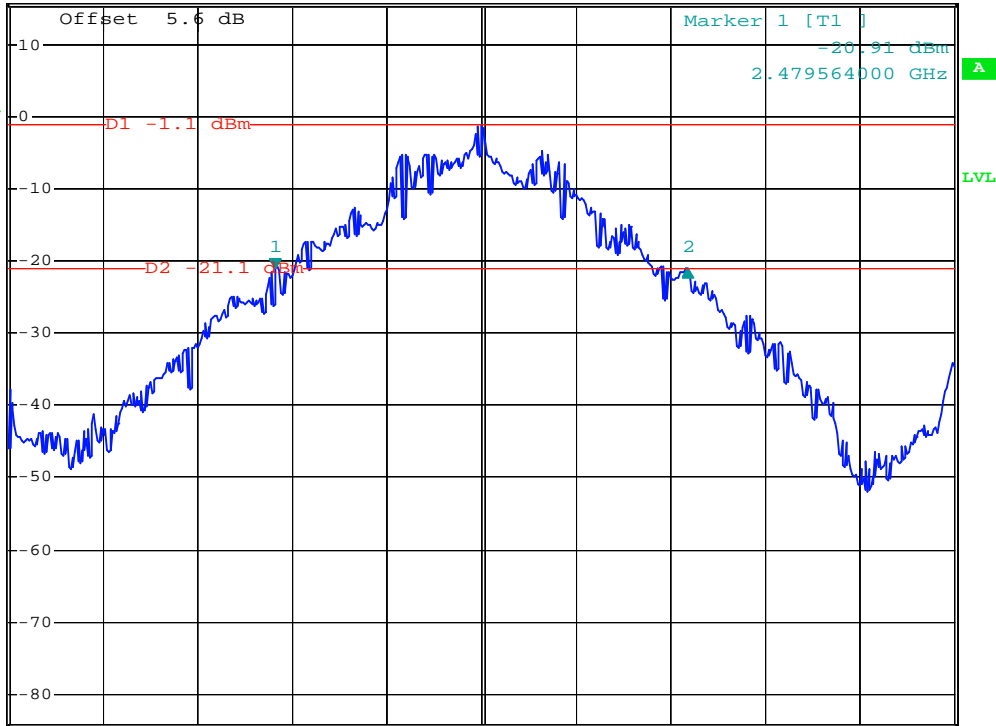

Center 2.48 GHz 200 kHz/ Span 2 MHz

5.5 Dwell Time of Each Frequency within a 30 Seconds Period

5.5.1 Measuring Instruments :

As described in chapter 6 of this test report.

5.5.2 Test Procedure :

1. The transmitter output was connected to the spectrum analyzer directly.
2. Set RBW of spectrum analyzer to 1MHz and VBW to 1MHz.
3. Set the center frequency on any frequency would be measured and set the frequency span to zero span.
4. The equation = $0.4 \cdot 79 \cdot (1600/79) \cdot t$ (t = the time duration of one single pulse)

5.5.3 Test Setup Layout :

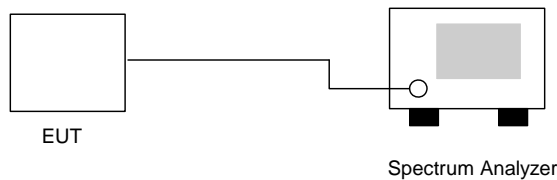

5.5.4 Test Result : See spectrum analyzer plots below

- Temperature: 26°C
- Relative Humidity: 53%
- Test Engineer : Jay

Ch00

Package Mode	Average Hopping Channel	Package Transfer Time (us)	Dwell Time (s)	Limit (s)
DH1	9.2	544	0.16	0.4
DH3	4.3	1810	0.25	0.4
DH5	3.8	3080	0.37	0.4



CH39

Package Mode	Average Hopping Channel	Package Transfer Time (us)	Dwell Time (s)	Limit (s)
DH1	9.1	544	0.16	0.4
DH3	4.7	1810	0.27	0.4
DH5	3.7	3080	0.36	0.4

CH78

Package Mode	Average Hopping Channel	Package Transfer Time (us)	Dwell Time (s)	Limit (s)
DH1	9.1	544	0.16	0.4
DH3	5.5	1810	0.31	0.4
DH5	4.1	3080	0.40	0.4

Remark:

1. Dwell Time=79(channels) x 0.4(s) x average hopping channel x package transfer time
2. 79channels come from the Hopping Channel number.
3. Average Hopping Channel = hops/sweep time
4. t: Package Transfer Time(us)



5.5.5 Dwell Time

DH1 (CH00)



RBW 1 MHz Delta 3 [T1]
*VBW 1 MHz 0.88 dB
Ref 15.6 dBm *Att 20 dB SWT 2 ms 1.260000 ms

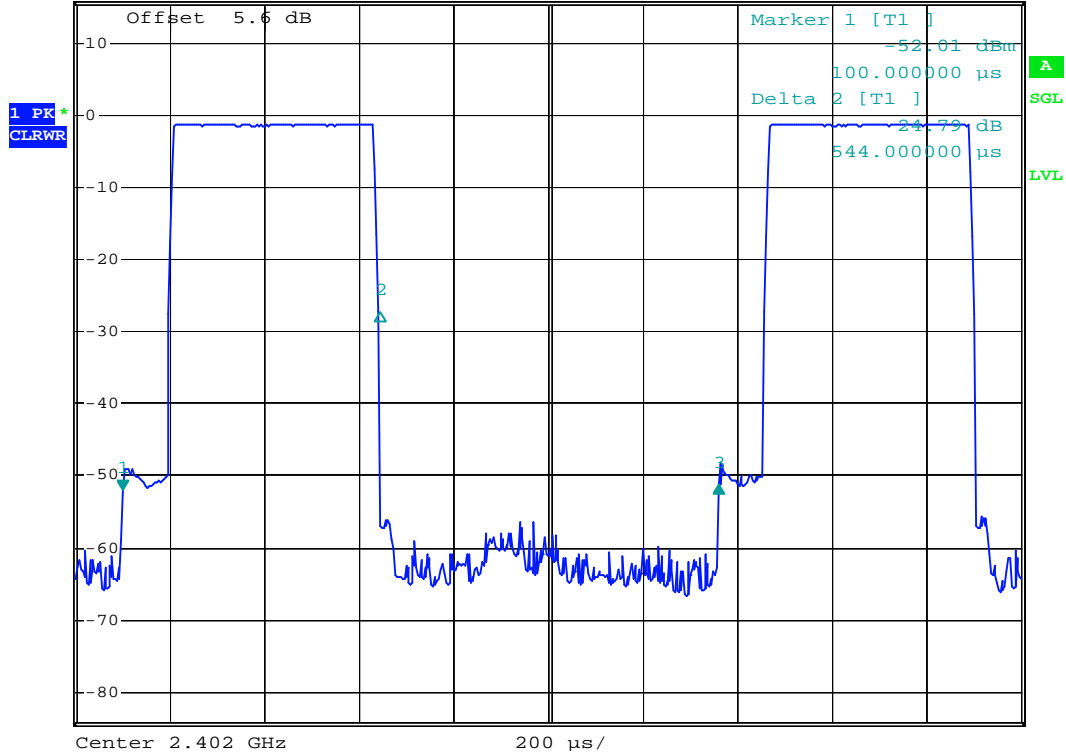



Ref 15.6 dBm *Att 20 dB RBW 1 MHz
*VBW 1 MHz SWT 10 s

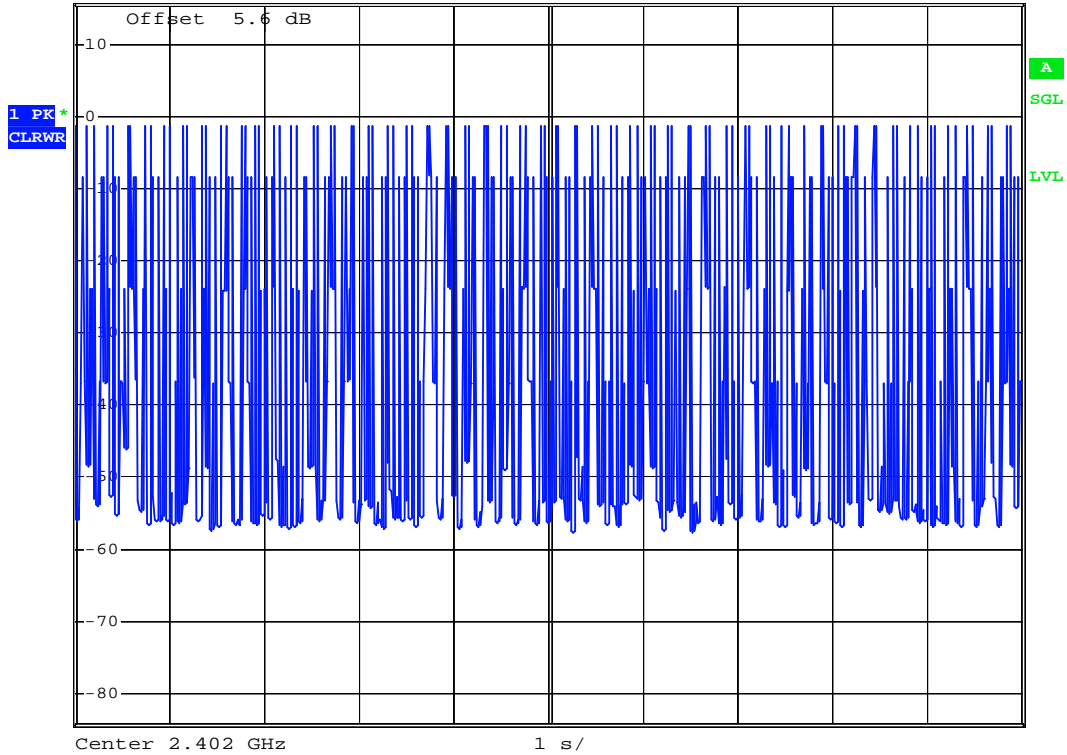



DH1 (CH39)



RBW 1 MHz Delta 3 [T1]
 *VBW 1 MHz -0.33 dB
 Ref 15.6 dBm *Att 20 dB SWT 2 ms 1.260000 ms

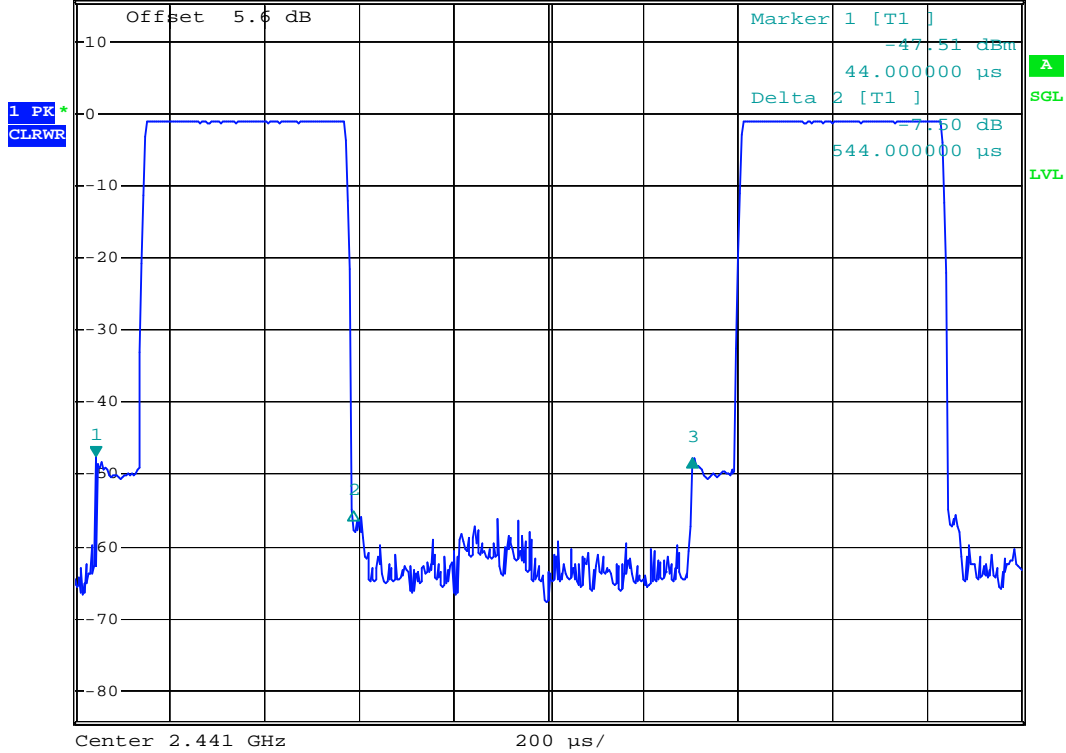

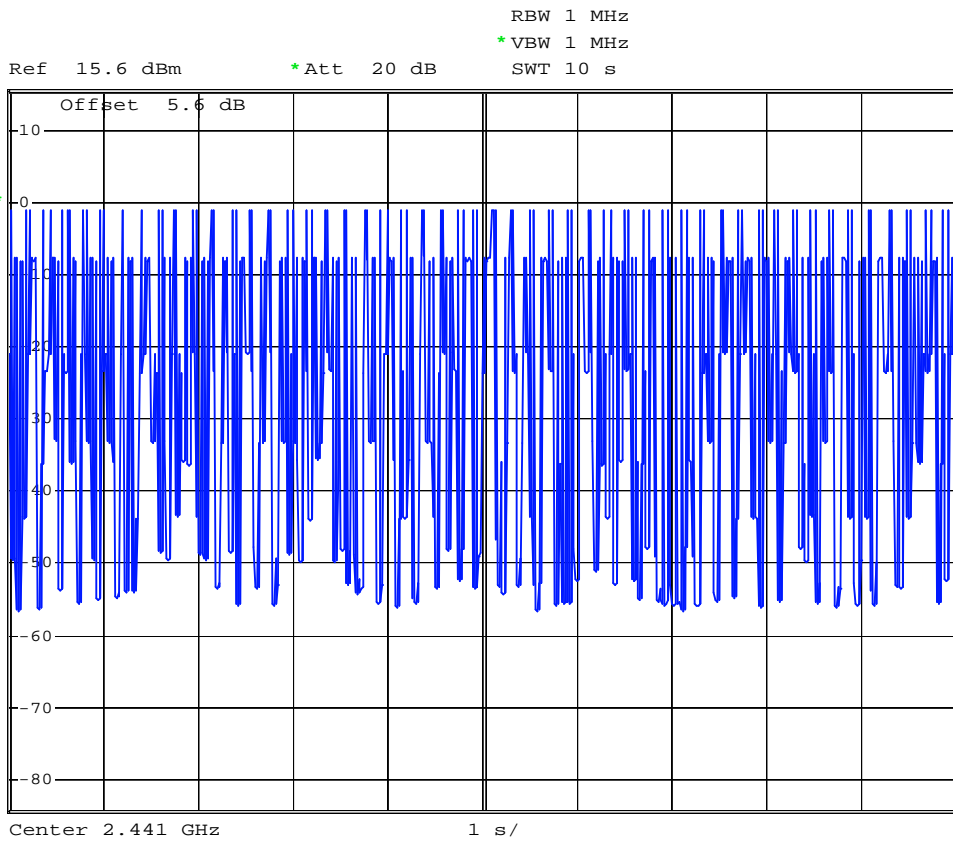



DH1 (CH78)



RBW 1 MHz Delta 3 [T1]
*VBW 1 MHz -0.72 dB
Ref 15.6 dBm *Att 20 dB SWT 2 ms 1.260000 ms

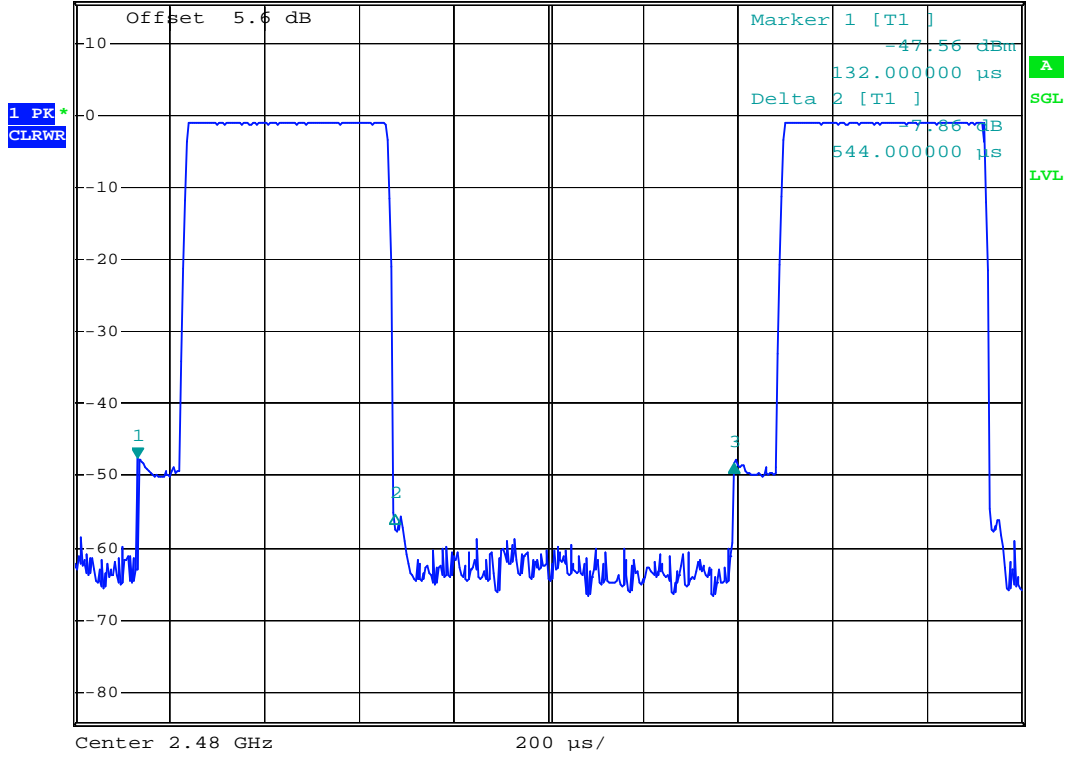



Ref 15.6 dBm *Att 20 dB RBW 1 MHz
*VBW 1 MHz SWT 10 s

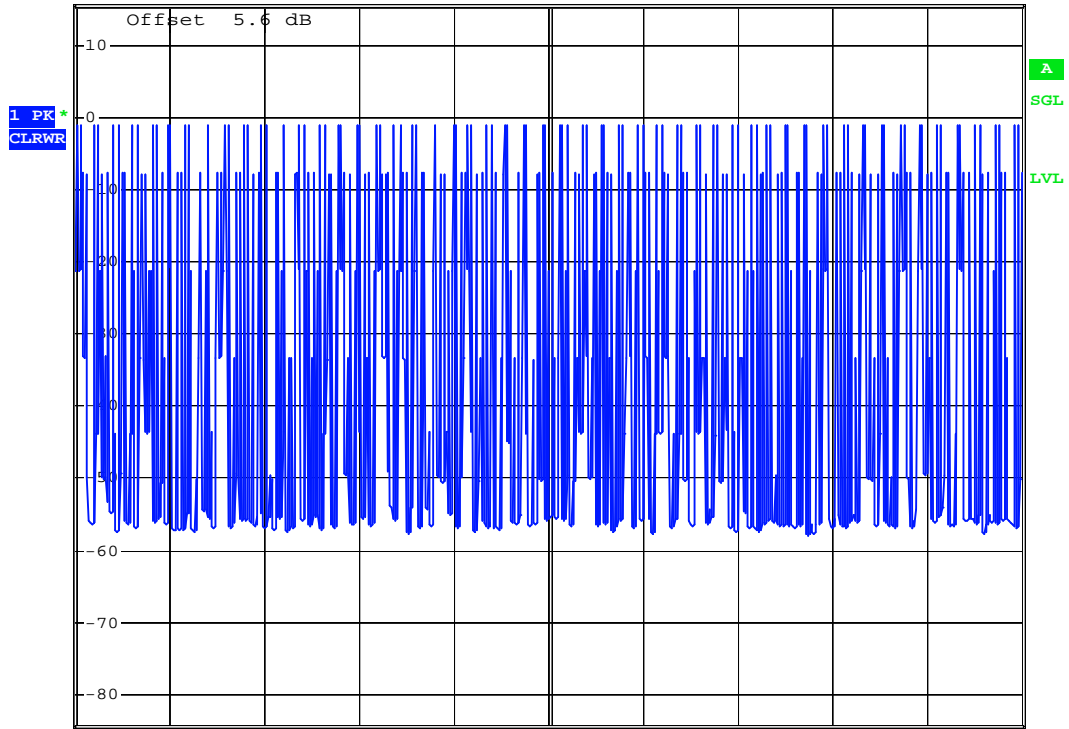



DH3 (CH00)



RBW 1 MHz Delta 3 [T1]
*VBW 1 MHz -0.37 dB
Ref 15.6 dBm *Att 20 dB SWT 5 ms 2.510000 ms

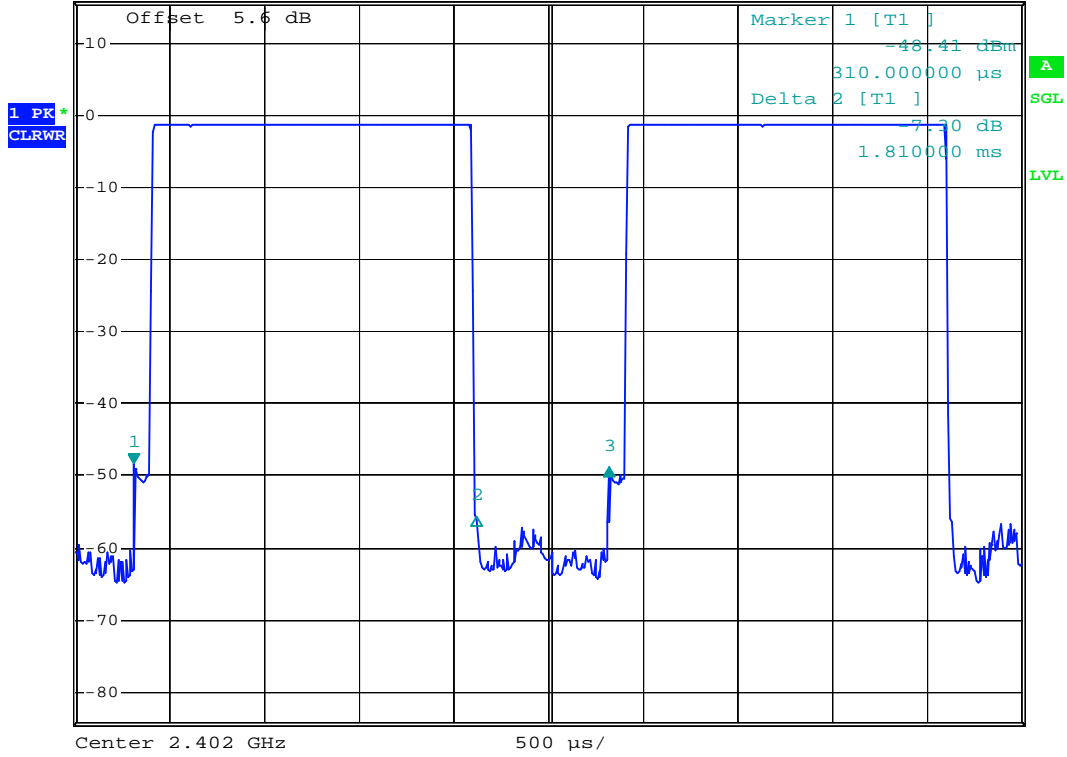



Ref 15.6 dBm *Att 20 dB RBW 1 MHz
*VBW 1 MHz SWT 10 s

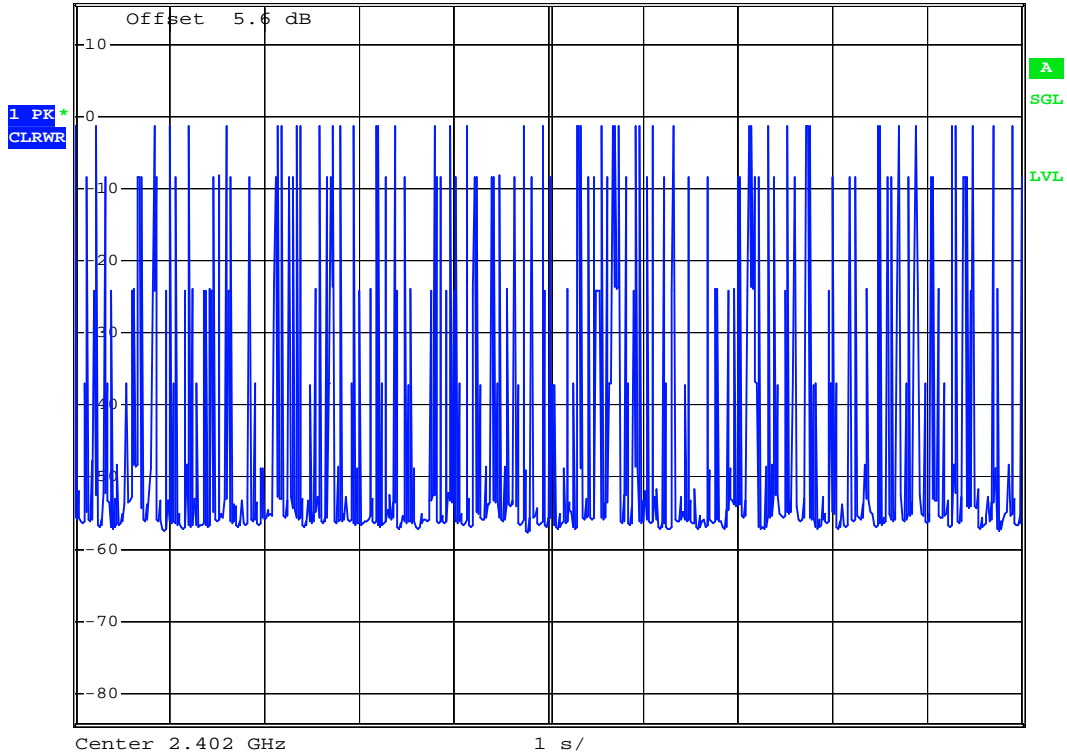



DH3 (CH39)



RBW 1 MHz Delta 3 [T1]
 *VBW 1 MHz 0.29 dB
 Ref 15.6 dBm *Att 20 dB SWT 5 ms 2.510000 ms

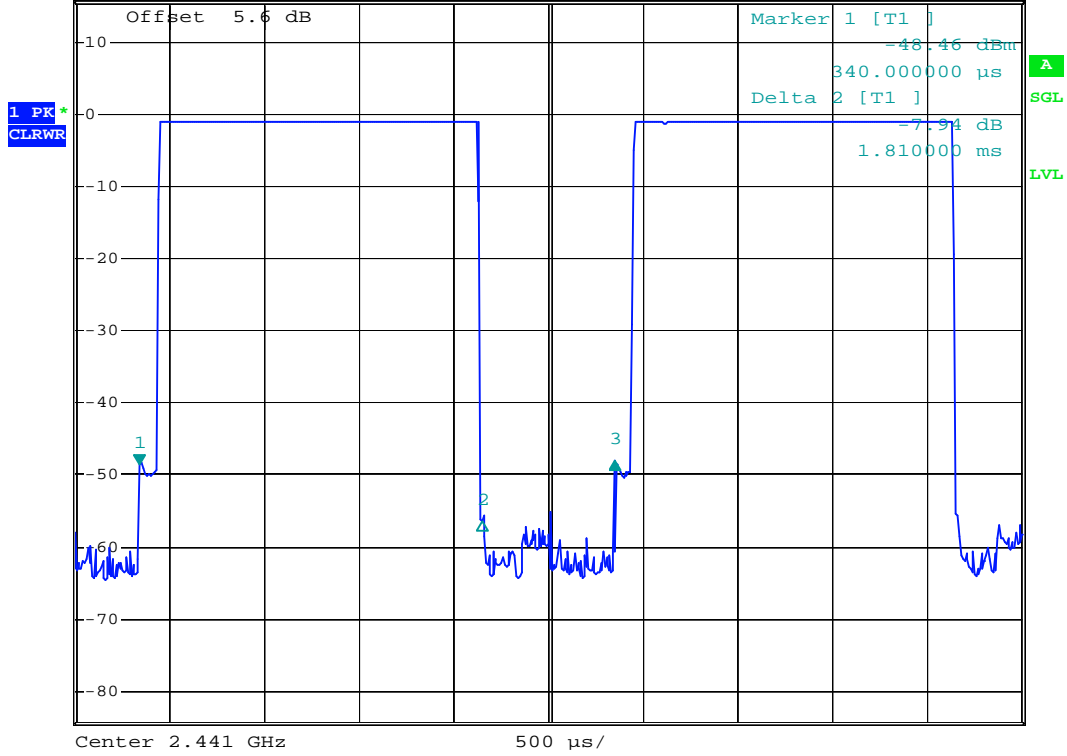

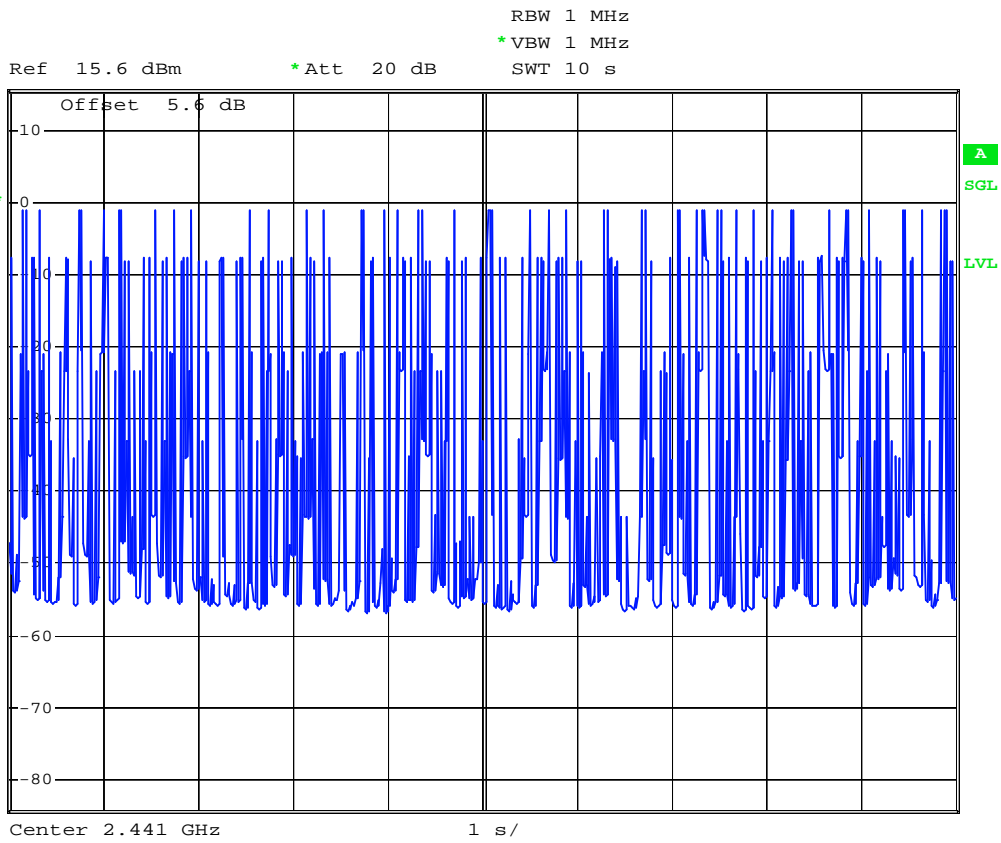



DH3 (CH78)



RBW 1 MHz Delta 3 [T1]
 *VBW 1 MHz 1.75 dB
 Ref 15.6 dBm *Att 20 dB SWT 5 ms 2.510000 ms

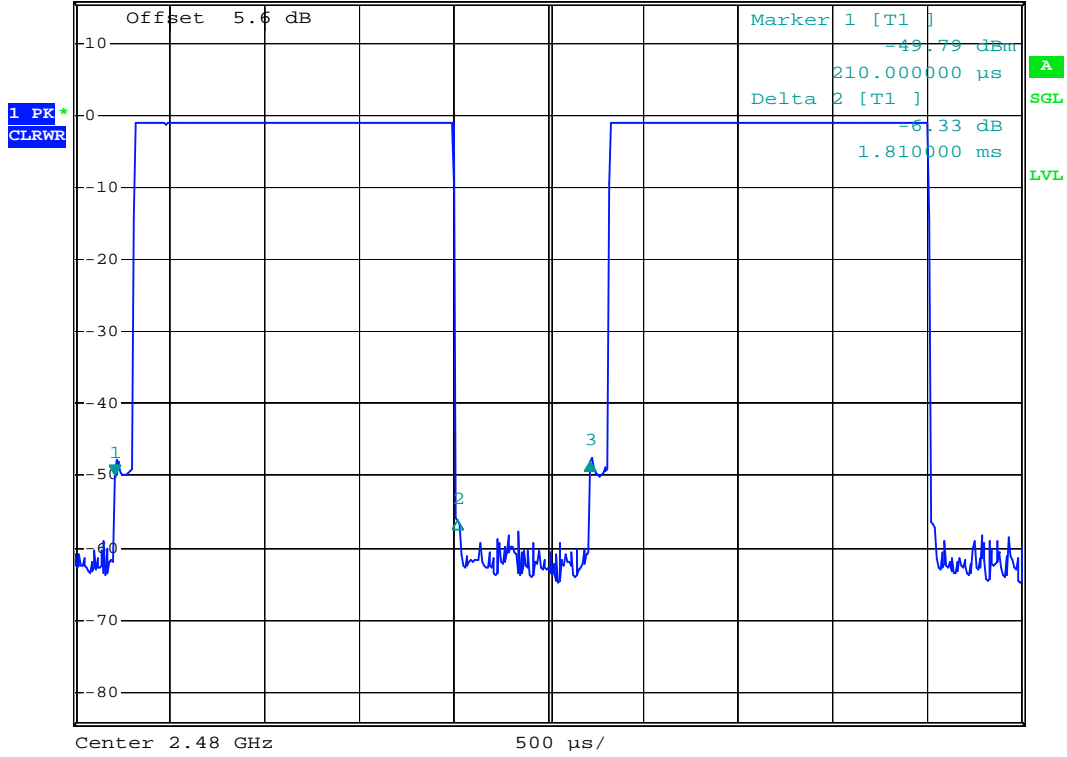



Ref 15.6 dBm *Att 20 dB RBW 1 MHz
*VBW 1 MHz SWT 10 s

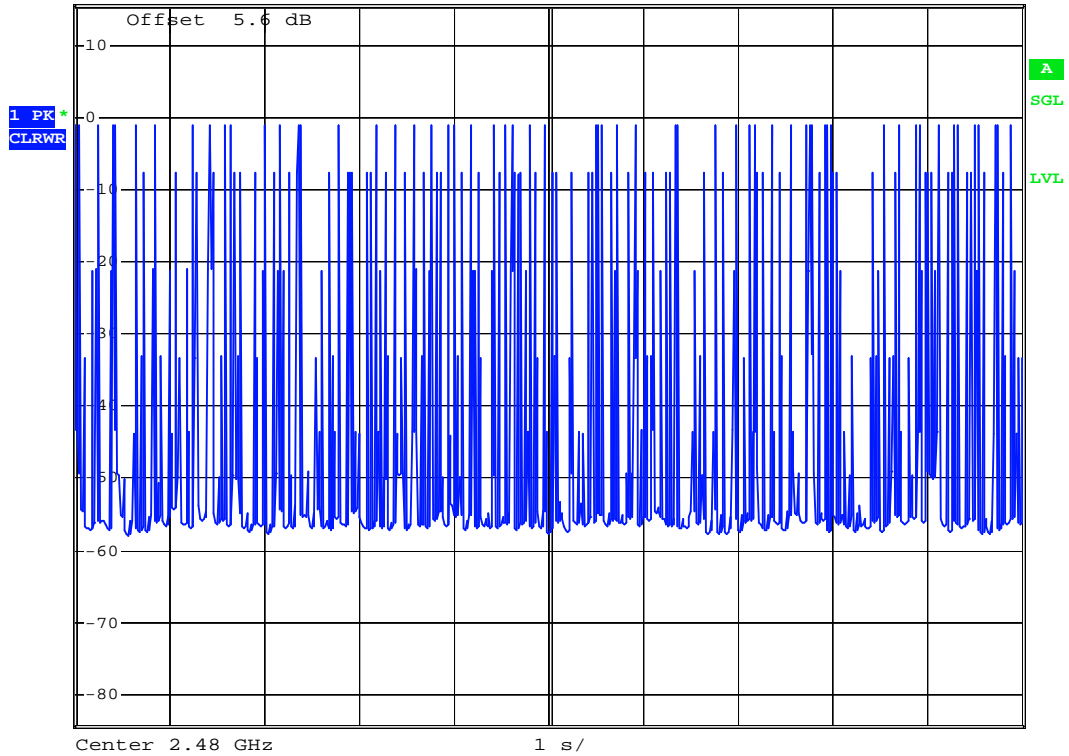



DH5 (CH00)

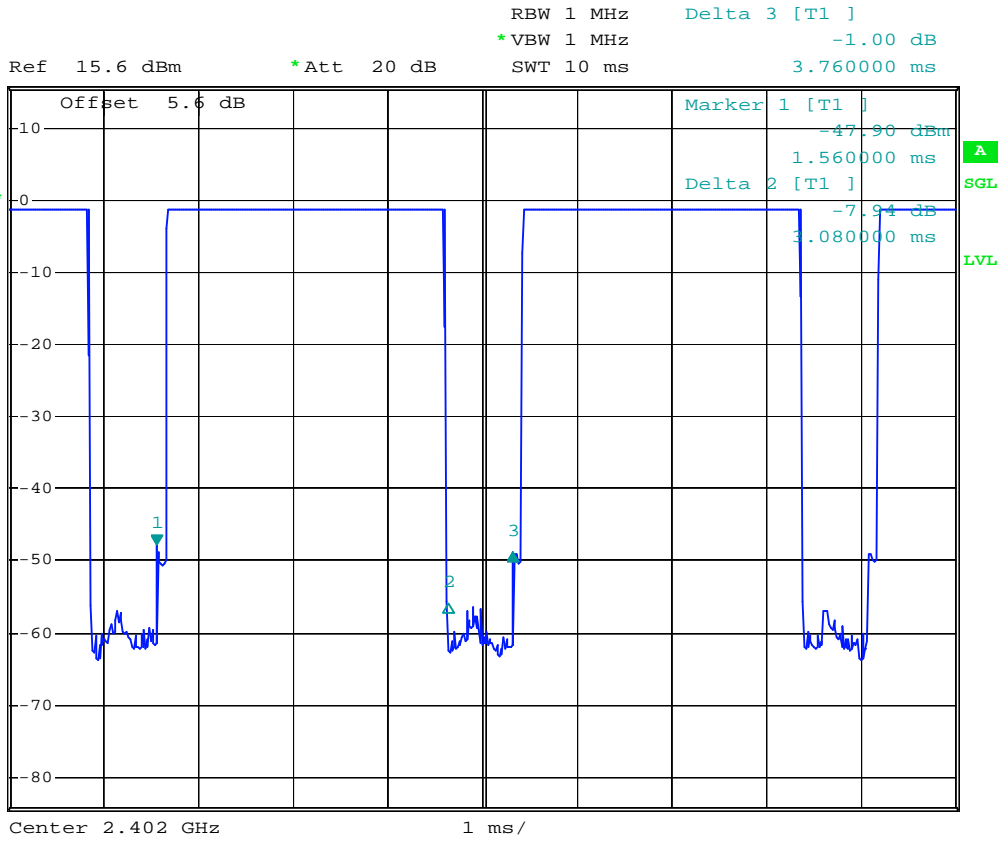



Ref 15.6 dBm *Att 20 dB RBW 1 MHz
*VBW 1 MHz SWT 10 s

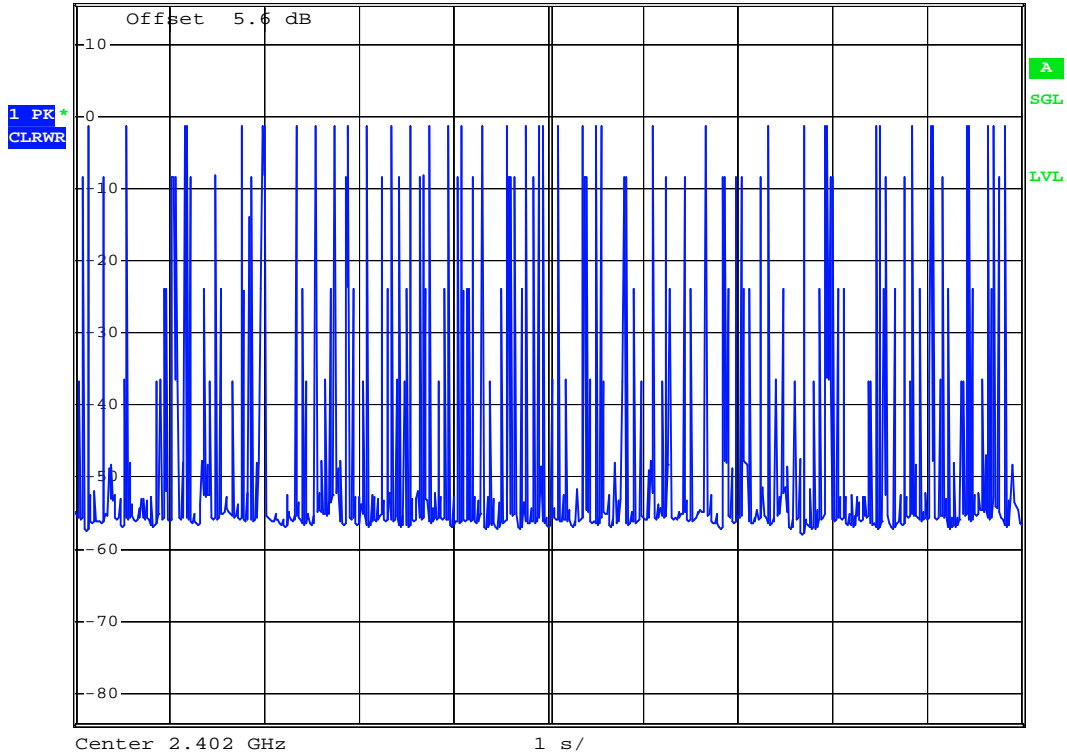



DH5 (CH39)



RBW 1 MHz Delta 3 [T1]
 *VBW 1 MHz -0.67 dB
 Ref 15.6 dBm *Att 20 dB SWT 10 ms 3.760000 ms

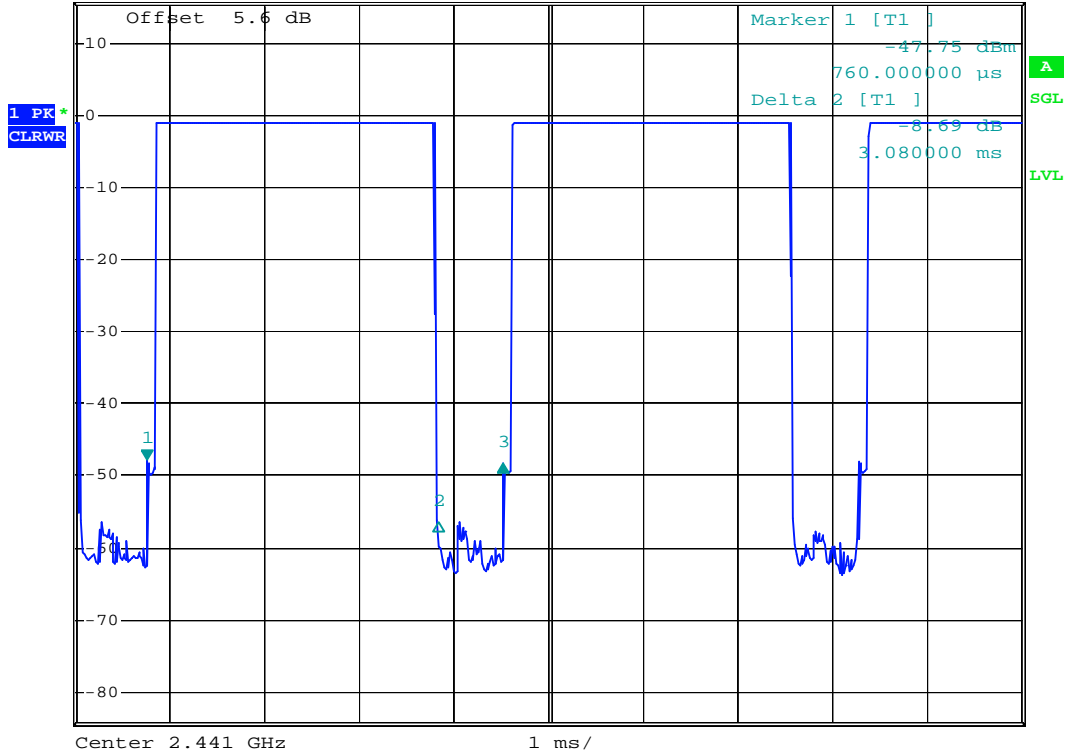



Ref 15.6 dBm *Att 20 dB RBW 1 MHz
*VBW 1 MHz SWT 10 s

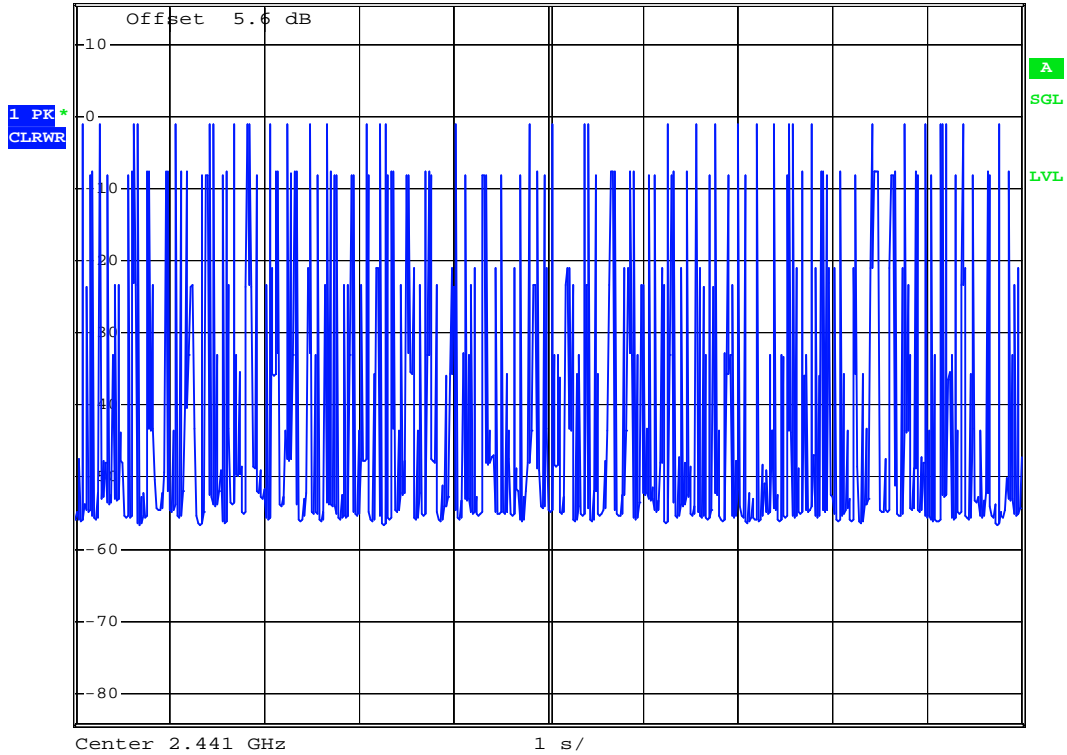



DH5 (CH78)



RBW 1 MHz Delta 3 [T1]
 *VBW 1 MHz -0.37 dB
 Ref 15.6 dBm *Att 20 dB SWT 10 ms 3.760000 ms

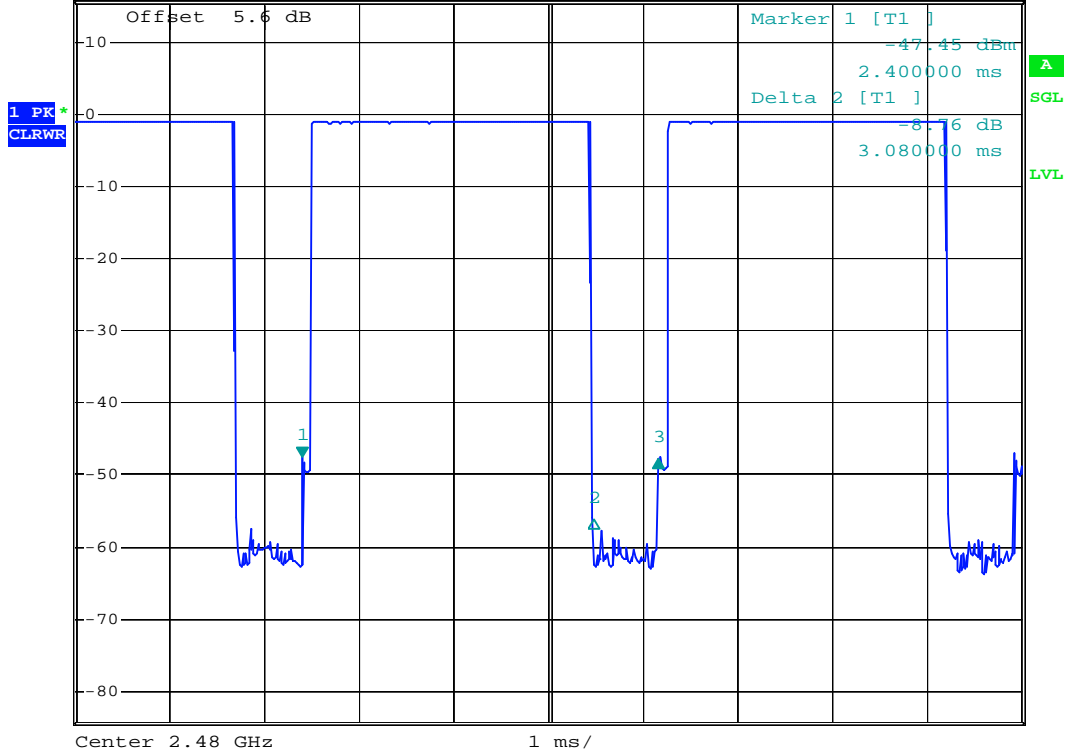



Ref 15.6 dBm *Att 20 dB RBW 1 MHz
*VBW 1 MHz SWT 10 s

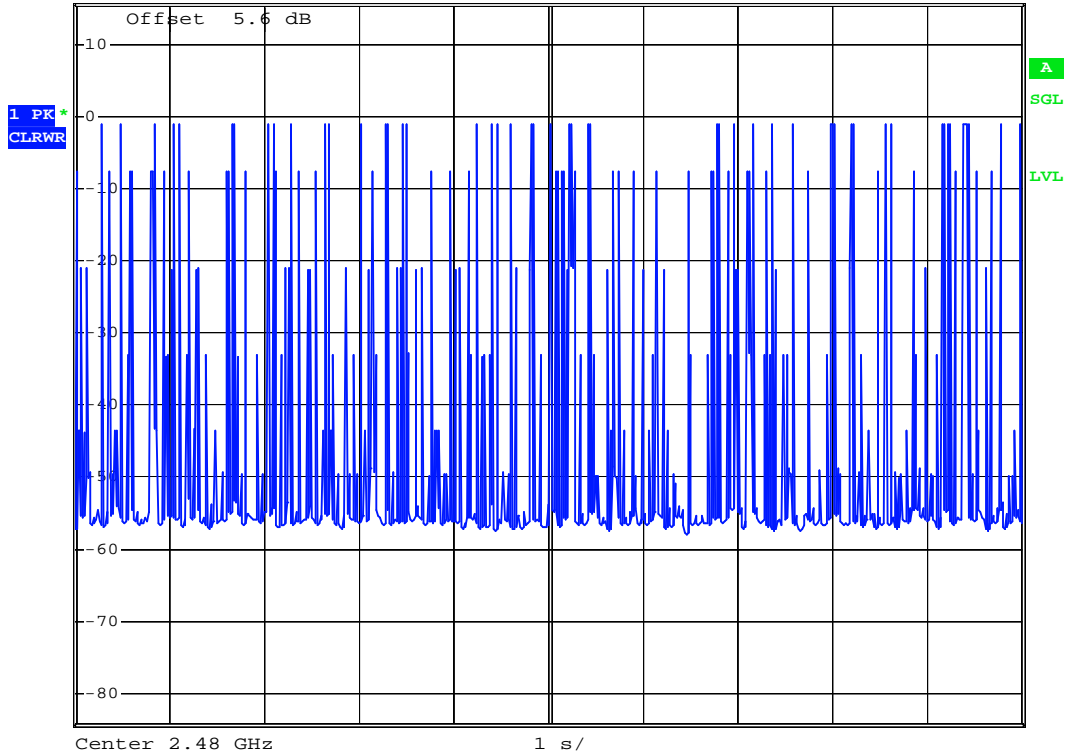

5.6 Output Power

5.6.1 Measuring Instruments :

As described in chapter 6 of this test report.

5.6.2 Test Procedure :

1. The transmitter output was connected to the spectrum analyzer directly.
2. The center frequency of the spectrum analyzer was set to the fundamental frequency and set RBW to 3MHz and VBW to 3MHz.

5.6.3 Test Setup Layout :

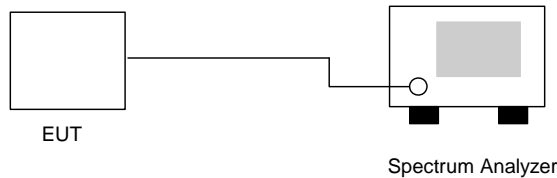

5.6.4 Test Result : See spectrum analyzer plots below

- Temperature: 26°C
- Relative Humidity: 53%
- Test Engineer : Jay

Channel	Frequency (MHz)	Measured Output Power (dBm)	Limits (Watt/dBm)	Plot Ref. No.
00	2402	-1.18	1W/30 dBm	Mode 1
39	2441	-0.93	1W/30 dBm	Mode 2
78	2480	-0.95	1W/30 dBm	Mode 3



5.6.5 Output Power

Mode 1: CH00 (2402MHz)



Ref 15.6 dBm *Att 20 dB *RBW 3 MHz Marker 1 [T1] -1.18 dBm
*VBW 3 MHz *SWT 500 ms 2.401860000 GHz

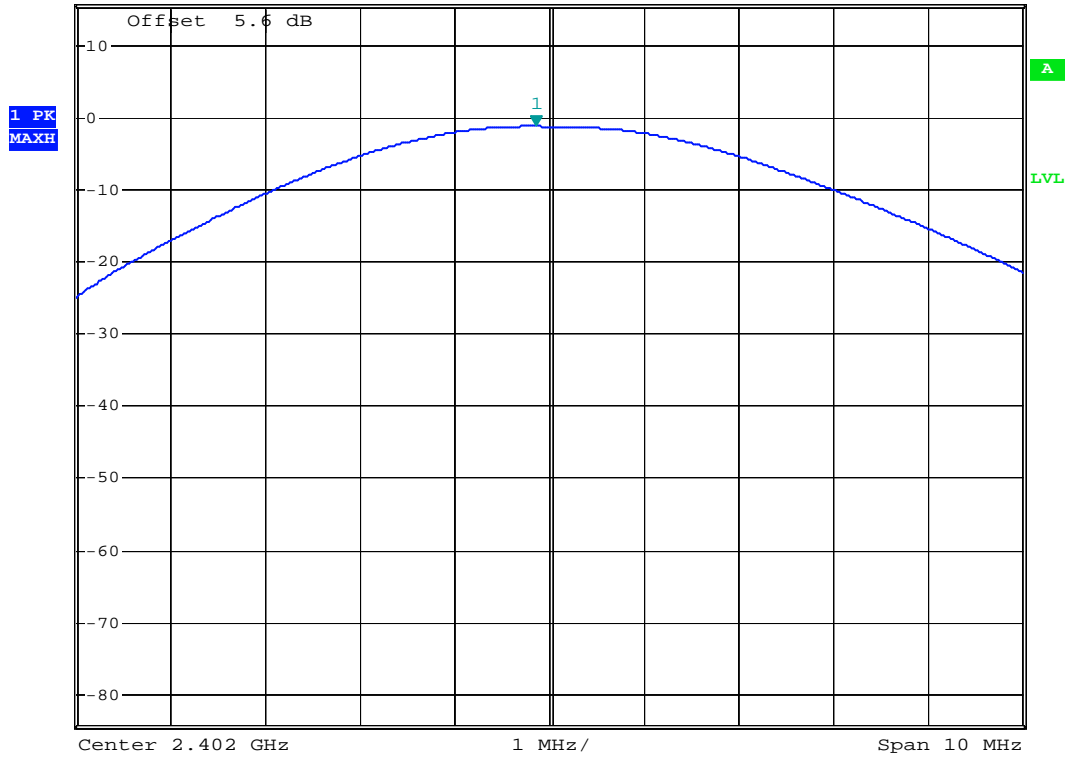



Mode 2: CH39 (2441MHz)



*RBW 3 MHz Marker 1 [T1]
*VBW 3 MHz -0.93 dBm
*SWT 500 ms 2.440780000 GHz

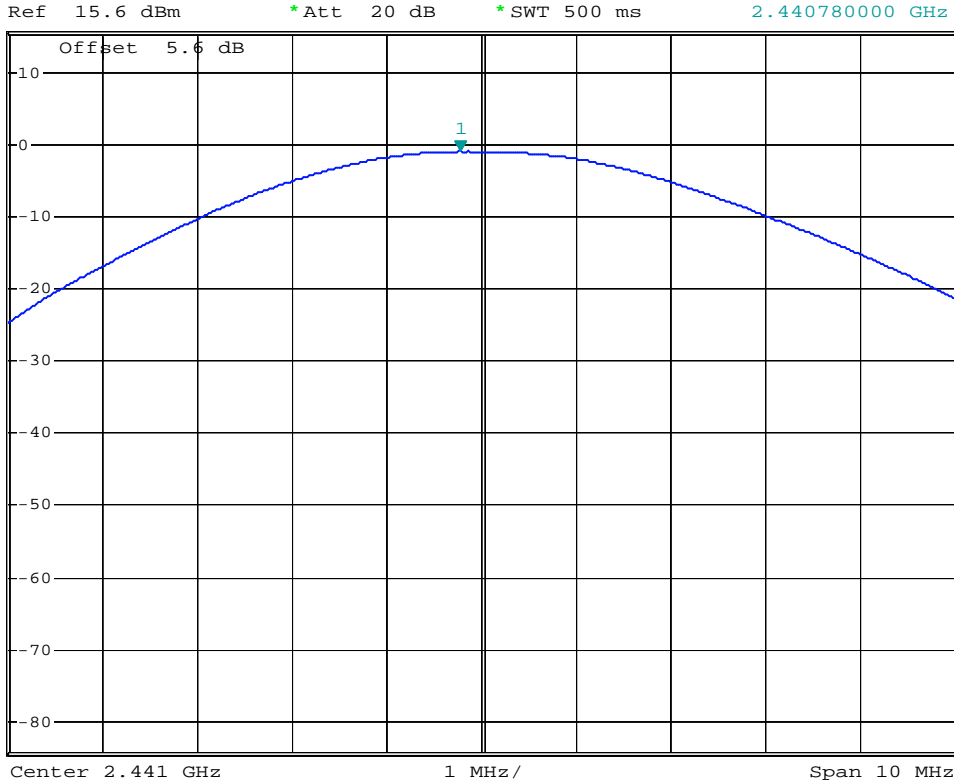



Mode 3: CH78 (2480MHz)



*RBW 3 MHz Marker 1 [T1]
*VBW 3 MHz -0.95 dBm
*SWT 500 ms 2.479780000 GHz

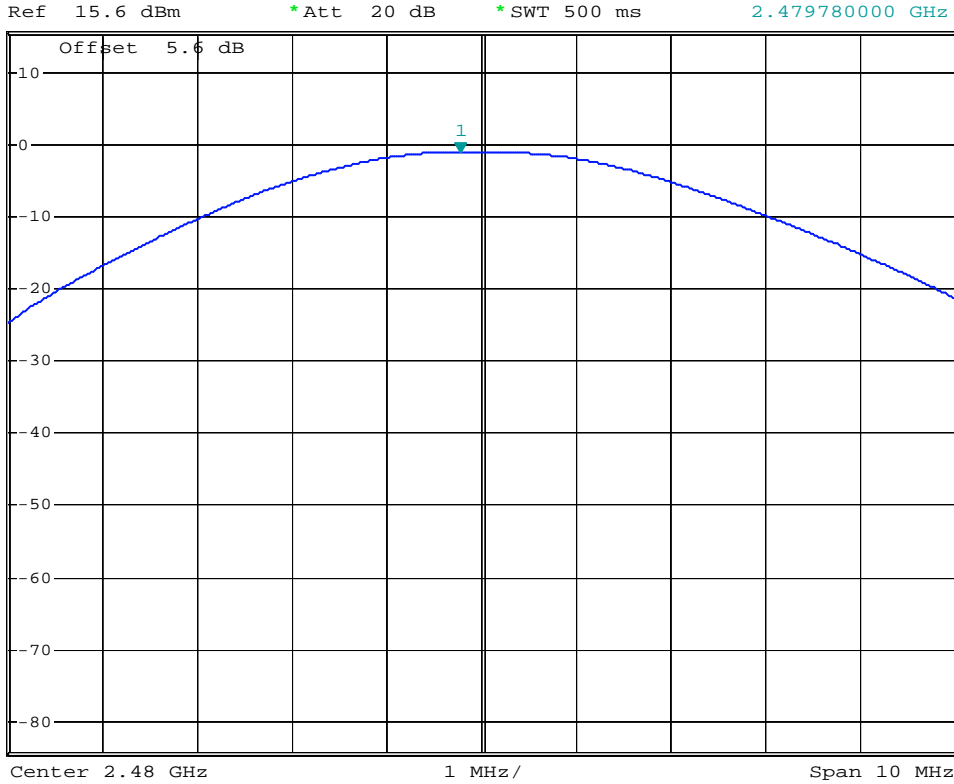



5.7 100kHz Bandwidth of Frequency Band Edges

5.7.1 Measuring Instruments :

As described in chapter 6 of this test report.

5.7.2 Test Procedure :

1. The transmitter output was connected to the spectrum analyzer via a low lose cable.
2. Set both RBW and VBW of spectrum analyzer to 100kHz with suitable frequency span for the conducted measurement, and RBW/VBW=1MHz/1MHz for peak measurement and RBW/VBW=1MHz/300Hz for average measurement in the radiated measurement.
3. The band edges was measured and recorded.

5.7.3 Test Result :

- Temperature: 26°C
- Relative Humidity: 53%
- Test Engineer : Jay

Test Result in lower band (Channel 00) : PASS

Test Result in higher band(Channel 78) : PASS

5.7.4 Note on Band edge Emission

CH00 (Horizontal)

Frequency (MHz)	Level (dBuV/m)	Over Limit (dB)	Limit Line (dBuV/m)	Read Level (dBuV)	Antenna Factor (dB)	Preamp Factor (dB)	Cable Loss (dB)	Detect Mode
2334.00	54.93	-19.07	74.00	55.15	30.54	35.10	4.34	Peak
2334.00	43.30	-10.70	54.00	43.52	30.54	35.10	4.34	Average

CH00 (Vertical)

Frequency (MHz)	Level (dBuV/m)	Over Limit (dB)	Limit Line (dBuV/m)	Read Level (dBuV)	Antenna Factor (dB)	Preamp Factor (dB)	Cable Loss (dB)	Detect Mode
2338.00	55.01	-18.99	74.00	55.25	30.52	35.10	4.43	Peak
2338.00	43.38	-10.62	54.00	43.61	30.52	35.10	4.43	Average



CH78 (Horizontal)

Frequency (MHz)	Level (dBuV/m)	Over Limit (dB)	Limit Line (dBuV/m)	Read Level (dBuV)	Antenna Factor (dB)	Preamp Factor (dB)	Cable Loss (dB)	Detect Mode
2483.50	72.61	-1.39	74.00	72.86	30.41	35.19	4.52	Peak
2483.50	53.50	-0.50	54.00	53.75	30.41	35.19	4.52	Average

CH78 (Vertical)

Frequency (MHz)	Level (dBuV/m)	Over Limit (dB)	Limit Line (dBuV/m)	Read Level (dBuV)	Antenna Factor (dB)	Preamp Factor (dB)	Cable Loss (dB)	Detect Mode
2483.50	73.51	-0.49	74.00	73.76	30.41	35.19	4.52	Peak
2483.50	52.89	-1.11	5400	53.14	30.41	35.19	4.52	Average



5.7.5 Frequency Band Edge

Mode 1: CH00 (2402 MHz)

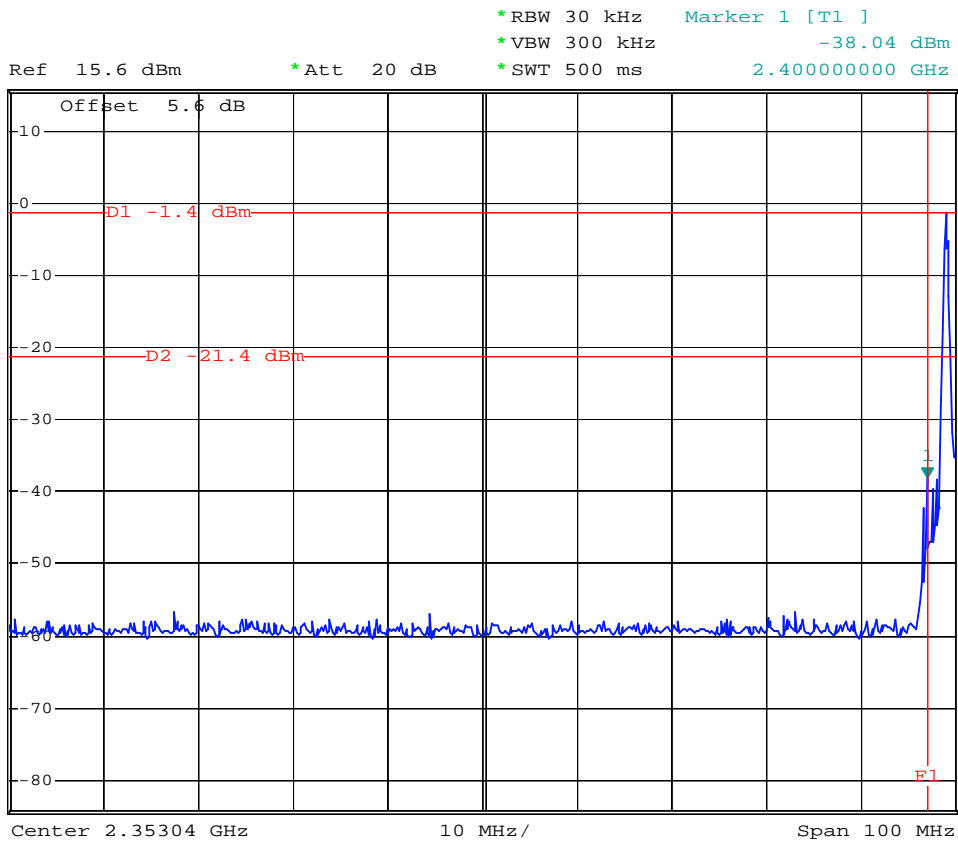



Mode 3: CH78 (2480 MHz)



*RBW 100 kHz Marker 1 [T1]
*VBW 100 kHz -49.15 dBm
*SWT 500 ms 2.484300000 GHz

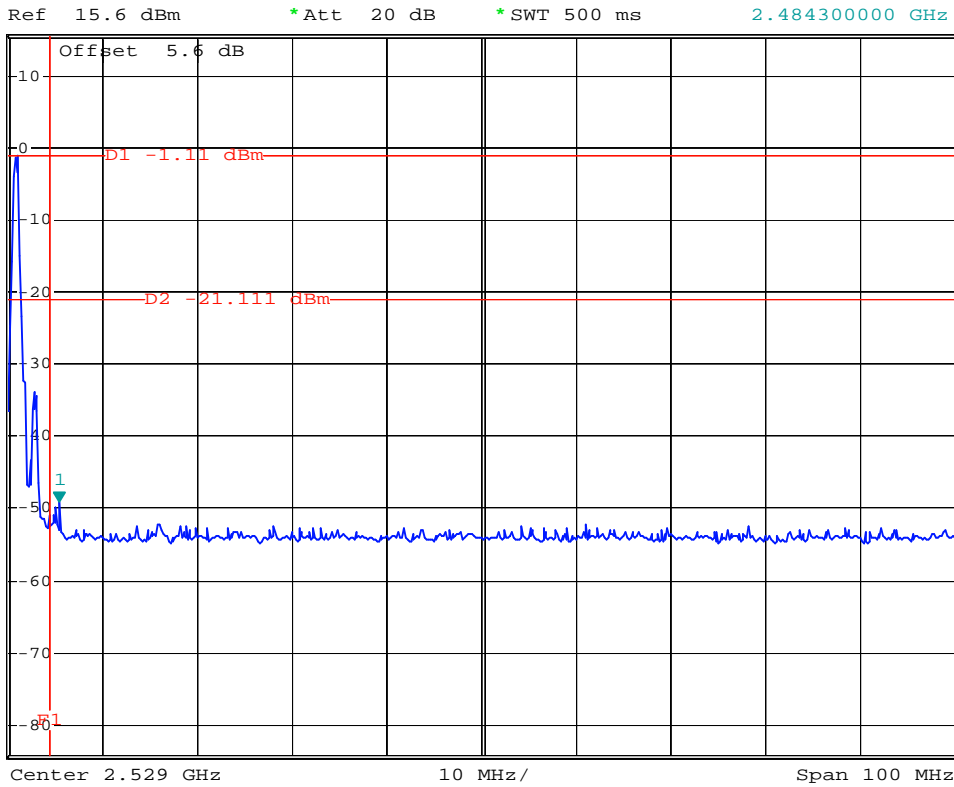



5.8 Conducted Emission

5.8.1 Measuring Instruments

As described in chapter 6 of this test Report.

5.8.2 Test Procedures :

- a. The EUT was placed 0.4 meter from the conducting wall of the shielding room was kept at least 80 centimeters from any other grounded conducting surface.
- b. Connect EUT to the power port of a line impedance stabilization network (LISN).
- c. All the support units are connected to the other LISN.
- d. The LISN provides 50 ohm coupling impedance for the measuring instrument.
- e. The FCC states that a 50 ohm, 50 microhenry LISN should be used.
- f. Both sides of AC line were checked for maximum conducted interference.
- g. The frequency range from 150 kHz to 30 MHz was searched.
- h. Set the test-receiver system to Peak Detect Function and specified bandwidth with Maximum Hold Mode.



5.8.3 Test Data Test Mode 1

- Temperature: 26°C
- Relative Humidity: 53%
- Test Engineer : Jay
- Test Mode : Mode 1

The test that passed at minimum margin was marked by the frame in the following table.

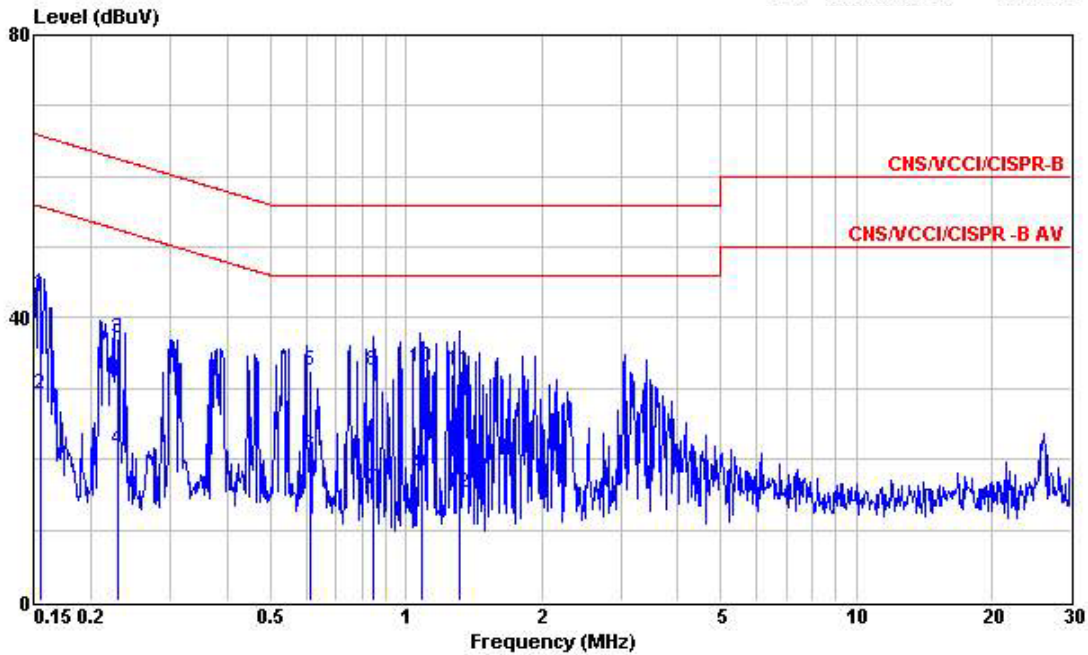

Site : CO01-HY
 Condition : CNS/VCCI/CISPR-B 2003 2001/008 LINE
 EUT : GSM Tri Band Mobile Phone
 Power : 120Vac/60Hz
 Model :
 Memo : PCS Idle Mode + Camera

	Freq	Level	Over Limit	Limit Line	Read Level	Probe Factor	Cable Loss	Remark
	MHz	dBuV	dB	dBuV	dBuV	dB	dB	
1	0.154	43.44	-22.34	65.78	43.31	0.10	0.03	QP
2	0.154	29.28	-26.50	55.78	29.15	0.10	0.03	Average
3	0.229	36.98	-25.52	62.50	36.85	0.10	0.03	QP
4	0.229	21.34	-31.16	52.50	21.21	0.10	0.03	Average
5	0.613	32.43	-23.57	56.00	32.29	0.10	0.04	QP
6	0.613	20.50	-25.50	46.00	20.36	0.10	0.04	Average
7	0.844	15.82	-30.18	46.00	15.67	0.10	0.05	Average
8	0.844	32.60	-23.40	56.00	32.45	0.10	0.05	QP
9	1.080	18.11	-27.89	46.00	17.95	0.10	0.06	Average
10	1.080	32.97	-23.03	56.00	32.81	0.10	0.06	QP
11	1.310	32.52	-23.48	56.00	32.36	0.10	0.06	QP
12	1.310	15.35	-30.65	46.00	15.19	0.10	0.06	Average

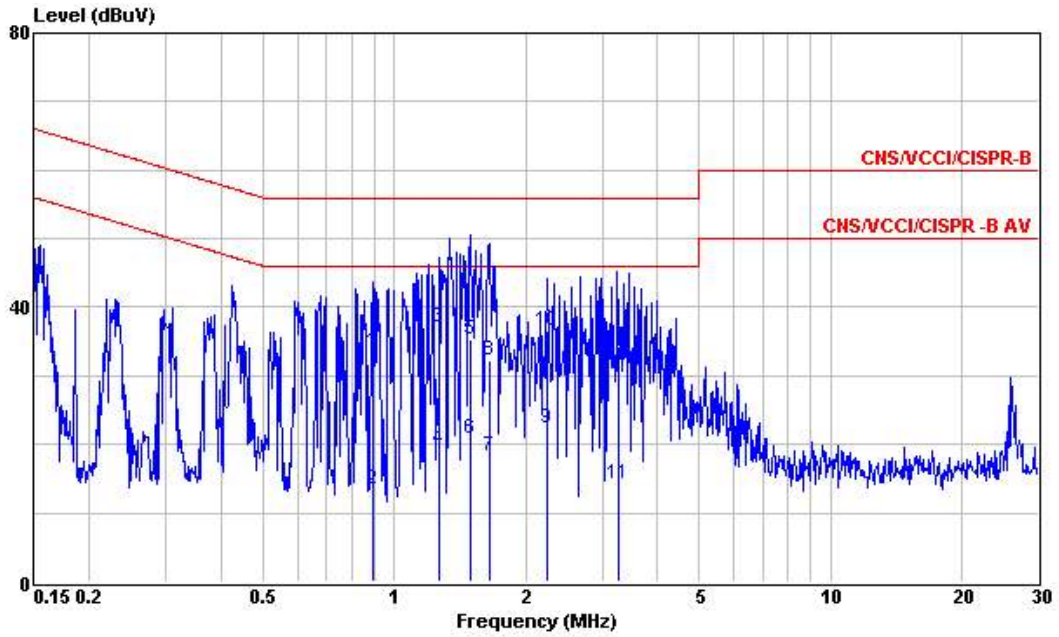

Site : CO01-HV
 Condition : CNS/VCCI/CISPR-B 2003 2001/008 NEUTRAL
 EUT : GSM Tri Band Mobile Phone
 Power : 120Vac/60Hz
 Model :
 Memo : PCS Idle Mode + Camera

	Over	Limit	Limit	Read	Probe	Cable	
Freq	Level	Limit	Line	Level	Factor	Loss	Remark
MHz	dBuV	dB	dBuV	dBuV	dB	dB	
1	0.894	33.63	-22.37	56.00	33.47	0.10	0.06 QP
2	0.894	13.51	-32.49	46.00	13.35	0.10	0.06 Average
3	1.270	37.05	-18.95	56.00	36.89	0.10	0.06 QP
4	1.270	19.26	-26.74	46.00	19.10	0.10	0.06 Average
5	1.490	35.39	-20.61	56.00	35.22	0.10	0.07 QP
6	1.490	20.85	-25.15	46.00	20.68	0.10	0.07 Average
7	1.650	18.17	-27.83	46.00	18.00	0.10	0.07 Average
8	1.650	32.25	-23.75	56.00	32.08	0.10	0.07 QP
9	2.250	22.37	-23.63	46.00	22.18	0.12	0.07 Average
10	2.250	36.49	-19.51	56.00	36.30	0.12	0.07 QP
11	3.263	14.24	-31.76	46.00	13.99	0.17	0.08 Average
12	3.263	34.22	-21.78	56.00	33.97	0.17	0.08 QP



5.8.4 Test Data Test Mode 2

- Temperature: 26°C
- Relative Humidity: 53%
- Test Engineer : Jay
- Test Mode : Mode 1

The test that passed at minimum margin was marked by the frame in the following table.

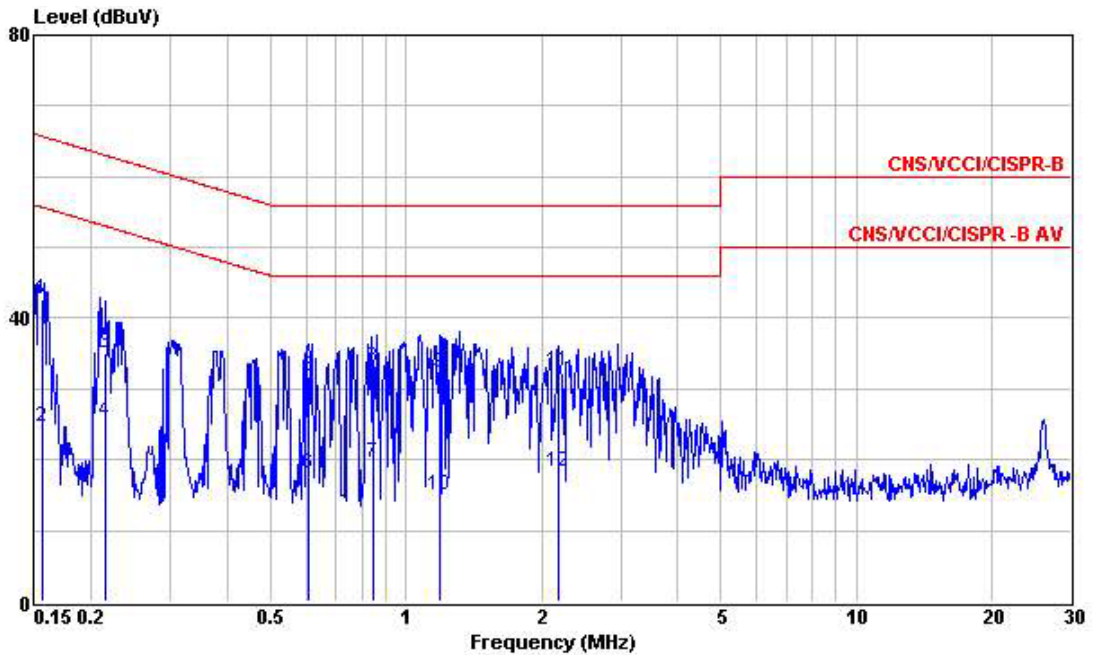

Site : CO01-HY
 Condition : CNS/VCCI/CISPR-B 2003 2001/008 LINE
 EUT : GSM Tri Band Mobile Phone
 Power : 120Vac/60Hz
 Model :
 Memo : PCS Idle Mode + Bluetooth ON

	Over	Limit	Read	Probe	Cable		
Freq	Level	Limit	Line	Level	Factor	Loss	Remark
MHz	dBuV	dB	dBuV	dBuV	dB	dB	
1	0.155	42.55	-23.18	65.73	42.42	0.10	0.03 QP
2	0.155	24.64	-31.09	55.73	24.51	0.10	0.03 Average
3	0.214	35.10	-27.95	63.05	34.97	0.10	0.03 QP
4	0.214	25.40	-27.65	53.05	25.27	0.10	0.03 Average
5	0.608	31.66	-24.34	56.00	31.52	0.10	0.04 QP
6	0.608	17.99	-28.01	46.00	17.85	0.10	0.04 Average
7	0.849	19.61	-26.39	46.00	19.46	0.10	0.05 Average
8	0.849	32.93	-23.07	56.00	32.78	0.10	0.05 QP
9	1.190	32.15	-23.85	56.00	31.99	0.10	0.06 QP
10	1.190	15.09	-30.91	46.00	14.93	0.10	0.06 Average
11	2.177	32.52	-23.48	56.00	32.35	0.10	0.07 QP
12	2.177	18.27	-27.73	46.00	18.10	0.10	0.07 Average

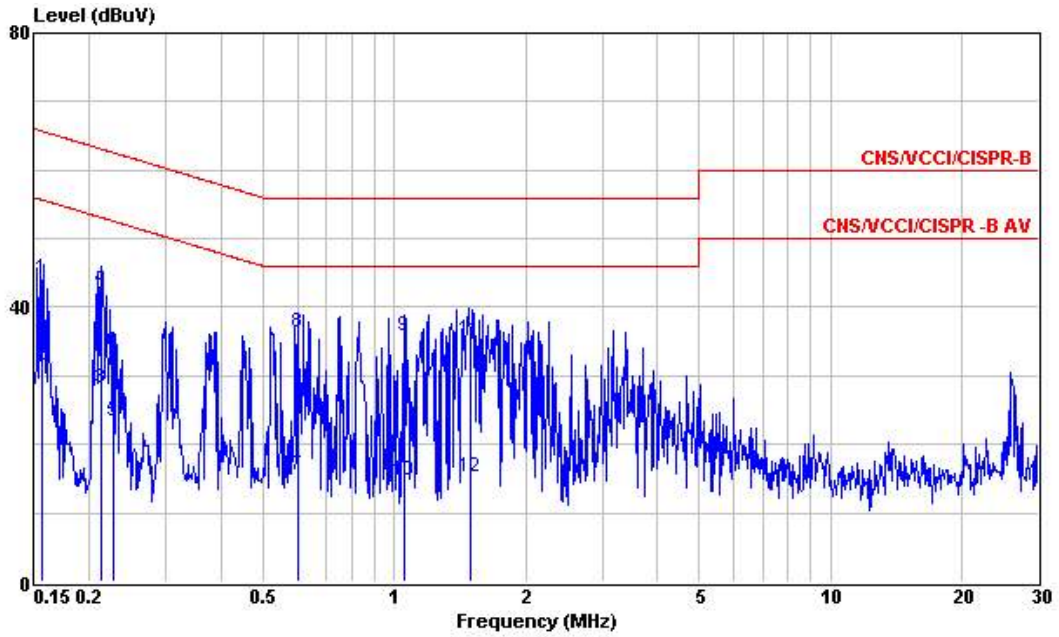

Site : CO01-HV
 Condition : CNS/VCCI/CISPR-B 2003 2001/008 NEUTRAL
 EUT : GSM Tri Band Mobile Phone
 Power : 120Vac/60Hz
 Model :
 Memo : PCS Idle Mode + Bluetooth ON

	Freq	Level	Over Limit	Limit Line	Read Level	Probe Factor	Cable Loss	Remark
	MHz	dBuV	dB	dBuV	dBuV	dB	dB	
1	0.155	44.16	-21.57	65.73	44.03	0.10	0.03	QP
2	0.155	31.46	-24.27	55.73	31.33	0.10	0.03	Average
3	0.213	28.30	-24.79	53.09	28.17	0.10	0.03	Average
4	0.213	42.60	-20.49	63.09	42.47	0.10	0.03	QP
5	0.226	23.24	-29.35	52.59	23.11	0.10	0.03	Average
6	0.226	33.45	-29.14	62.59	33.32	0.10	0.03	QP
7	0.600	15.46	-30.54	46.00	15.32	0.10	0.04	Average
8	0.600	36.33	-19.67	56.00	36.19	0.10	0.04	QP
9	1.050	35.85	-20.15	56.00	35.69	0.10	0.06	QP
10	1.050	14.84	-31.16	46.00	14.68	0.10	0.06	Average
11	1.490	35.29	-20.71	56.00	35.12	0.10	0.07	QP
12	1.490	15.25	-30.75	46.00	15.08	0.10	0.07	Average

5.9 Radiated Emission Measurement

5.9.1 Measuring Instruments

As described in chapter 6 of this Report.

5.9.2 Test Procedures

1. The EUT was placed on a rotatable table top 0.8 meter above ground.
2. The EUT was set 3 meters from the interference receiving antenna which was mounted on the top of a variable height antenna tower.
3. The table was rotated 360 degrees to determine the position of the highest radiation.
4. The antenna is a broadband antenna and its height is varied between one meter and four meters above ground to find the maximum value of the field strength for both horizontal polarization and vertical polarization of the antenna.
5. For each suspected emission, the EUT was arranged to its worst case and then tune the antenna tower (from 1 m to 4 m) and turntable (from 0 degree to 360 degrees) to find the maximum reading.
6. Set the test-receiver system to Peak or CISPR quasi-peak Detect Function and specified bandwidth with Maximum Hold Mode.
7. For testing below 1GHz, If the emission level of the EUT in peak mode was 3 dB lower than the limit specified, then testing will be stopped and peak values of EUT will be reported, otherwise, the emissions will be repeated one by one using the quasi-peak method and reported.
8. For testing above 1GHz, the emission level of the EUT in peak mode was 20dB lower than average limit (that means the emission level in average mode also complies with the limit in average mode), then testing will be stopped and peak values of EUT will be reported, otherwise, the emissions will be measured in average mode again and reported.

5.9.3 Typical Test Setup Layout of Radiated Emission

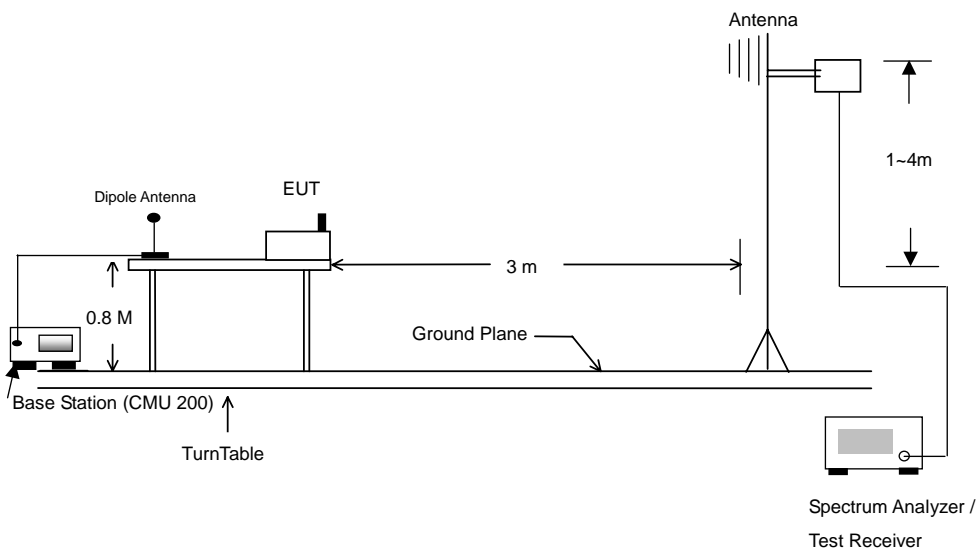



5.9.4 Test Data

- Temperature : 23 °C
- Relating Humidity : 58 %
- Test Engineer : Jay
- Test Mode : Mode 1
- Polarization : Horizontal

The test that passed at the minimum margin was marked by the frame in the following test record

	Freq	Level	Over Limit	Limit Line	ReadAntenna Level	Antenna Factor	Cable Loss	Preamp Factor	Ant Pos	Table Pos	Remark
	MHz	dBuV/m	dB	dBuV/m	dBuV	dB/m	dB	dB	cm	deg	
1	2334.00	54.93	-19.07	74.00	55.15	30.54	4.34	35.10	---	---	Peak
2	2334.00	43.30	-10.70	54.00	43.52	30.54	4.34	35.10	197	162	Average
3 X	2402.00	95.65			95.88	30.48	4.43	35.14	---	---	Peak
4 @	2402.00	81.36			81.59	30.48	4.43	35.14	197	162	Average
5	2488.00	54.41	-19.59	74.00	54.67	30.40	4.52	35.19	---	---	Peak
6	2488.00	43.12	-10.88	54.00	43.39	30.40	4.52	35.19	197	162	Average

Remark: #3 and #4 Fundamental Signal

	Freq	Level	Over Limit	Limit Line	ReadAntenna Level	Antenna Factor	Preamp Factor	Cable Loss	Remark	Ant Pos	Table Pos
	MHz	dBuV/m	dB	dBuV/m	dBuV	dB/m	dB	dB		cm	deg
1 @	4804.00	55.05	-18.95	74.00	50.35	33.16	35.09	6.63	Peak	---	---
2 @	4804.00	46.98	-7.02	54.00	42.28	33.16	35.09	6.63	Average	100	338

- Test Mode : Mode 1
- Polarization : Vertical

The test that passed at minimum margin was marked by the frame in the following table.

	Freq	Level	Over Limit	Limit Line	ReadAntenna Level	Antenna Factor	Cable Loss	Preamp Factor	Ant Pos	Table Pos	Remark
	MHz	dBuV/m	dB	dBuV/m	dBuV	dB/m	dB	dB	cm	deg	
1	2338.00	55.01	-18.99	74.00	55.25	30.52	4.34	35.10	---	---	Peak
2	2338.00	43.38	-10.62	54.00	43.61	30.52	4.34	35.10	100	211	Average
3 X	2402.00	96.33			96.56	30.48	4.43	35.14	---	---	Peak
4 @	2402.00	81.06			81.29	30.48	4.43	35.14	100	211	Average
5	2488.00	54.64	-19.36	74.00	54.91	30.40	4.52	35.19	---	---	Peak
6	2488.00	43.19	-10.81	54.00	43.46	30.40	4.52	35.19	100	211	Average

Remark: #4 and #5 Fundamental Signal

	Freq	Level	Over Limit	Limit Line	ReadAntenna Level	Antenna Factor	Preamp Factor	Cable Loss	Remark	Ant Pos	Table Pos
	MHz	dBuV/m	dB	dBuV/m	dBuV	dB/m	dB	dB		cm	deg
1 @	4804.00	51.12	-22.88	74.00	46.43	33.16	35.09	6.63	Peak	---	---
2 @	4804.00	43.68	-10.32	54.00	38.98	33.16	35.09	6.63	Average	100	193



- Test Mode : Mode 2
- Polarization : Horizontal

The test that passed at minimum margin was marked by the frame in the following table.

	Freq	Level	Over Limit	Limit Line	ReadAntenna Level	Antenna Factor	Preamp Factor	Cable Loss	Remark	Ant Pos	Table Pos
	MHz	dBuV/m	dB	dBuV/m	dBuV	dB/m	dB	dB		cm	deg
1 @	30.00	18.46	-21.54	40.00	31.16	18.73	32.12	0.70	Peak	---	---
2 @	156.63	17.72	-25.78	43.50	38.38	9.93	32.18	1.59	Peak	---	---
3 @	272.73	22.23	-23.77	46.00	39.03	12.91	31.95	2.24	Peak	---	---

	Freq	Level	Over Limit	Limit Line	ReadAntenna Level	Antenna Factor	Preamp Factor	Cable Loss	Remark	Ant Pos	Table Pos
	MHz	dBuV/m	dB	dBuV/m	dBuV	dB/m	dB	dB		cm	deg
1 @	600.30	34.82	-11.18	46.00	44.45	17.94	31.30	3.72	Peak	---	---
2 @	799.80	32.05	-13.95	46.00	37.12	21.90	31.46	4.48	Peak	---	---
3 @	848.80	32.95	-13.05	46.00	38.83	20.95	31.70	4.86	Peak	---	---

	Freq	Level	Over Limit	Limit Line	ReadAntenna Level	Antenna Factor	Preamp Factor	Cable Loss	Remark	Ant Pos	Table Pos
	MHz	dBuV/m	dB	dBuV/m	dBuV	dB/m	dB	dB		cm	deg
1 @	2318.00	54.87	-19.13	74.00	55.09	30.54	35.10	4.34	Peak	---	---
2 @	2318.00	42.82	-11.18	54.00	43.04	30.54	35.10	4.34	Average	194	157
3 @	2438.00	96.37			96.62	30.44	35.16	4.46	Peak	---	---
4 @	2438.00	81.60			81.86	30.44	35.16	4.46	Average	194	157
5 @	2498.00	54.72	-19.28	74.00	54.97	30.40	35.20	4.55	Peak	---	---
6 @	2498.00	43.24	-10.76	54.00	43.49	30.40	35.20	4.55	Average	194	157

Remark: #3 and #4 Fundamental Signal

	Freq	Level	Over Limit	Limit Line	ReadAntenna Level	Antenna Factor	Preamp Factor	Cable Loss	Remark	Ant Pos	Table Pos
	MHz	dBuV/m	dB	dBuV/m	dBuV	dB/m	dB	dB		cm	deg
1 @	4878.00	53.06	-20.94	74.00	48.19	33.39	35.09	6.57	Peak	---	---
2 @	4878.00	46.99	-7.01	54.00	42.12	33.39	35.09	6.57	Average	100	337



- Test Mode : Mode 2
- Polarization : Vertical

The test that passed at minimum margin was marked by the frame in the following table.

	Freq	Level	Over Limit	Limit Line	ReadAntenna Level	Antenna Factor	Preamp Factor	Cable Loss	Remark	Ant Pos	Table Pos
	MHz	dBuV/m	dB	dBuV/m	dBuV	dB/m	dB	dB		cm	deg
1 @	51.33	23.73	-16.27	40.00	45.69	9.59	32.44	0.89	Peak	---	---
2 @	156.09	20.82	-22.68	43.50	41.63	9.78	32.19	1.59	Peak	---	---
3 @	270.03	20.14	-25.86	46.00	36.94	12.91	31.94	2.23	Peak	---	---

	Freq	Level	Over Limit	Limit Line	ReadAntenna Level	Antenna Factor	Preamp Factor	Cable Loss	Remark	Ant Pos	Table Pos
	MHz	dBuV/m	dB	dBuV/m	dBuV	dB/m	dB	dB		cm	deg
1 @	600.30	35.35	-10.65	46.00	44.98	17.94	31.30	3.72	Peak	---	---
2 @	700.40	31.70	-14.30	46.00	40.05	19.04	31.45	4.06	Peak	---	---
3 @	799.80	33.06	-12.94	46.00	38.14	21.90	31.46	4.48	Peak	---	---

	Freq	Level	Over Limit	Limit Line	ReadAntenna Level	Antenna Factor	Preamp Factor	Cable Loss	Remark	Ant Pos	Table Pos
	MHz	dBuV/m	dB	dBuV/m	dBuV	dB/m	dB	dB		cm	deg
1 @	2344.00	54.77	-19.23	74.00	54.99	30.52	35.12	4.37	Peak	---	---
2 @	2344.00	43.22	-10.78	54.00	43.44	30.52	35.12	4.37	Average	100	275
3 @	2438.00	96.74			97.00	30.44	35.16	4.46	Peak	---	---
4 @	2438.00	81.57			81.83	30.44	35.16	4.46	Average	100	275
5 @	2488.00	54.60	-19.40	74.00	54.86	30.40	35.19	4.52	Peak	---	---
6 @	2488.00	43.00	-11.00	54.00	43.27	30.40	35.19	4.52	Average	100	275

Remark: #3 and #4 Fundamental Signal

	Freq	Level	Over Limit	Limit Line	ReadAntenna Level	Antenna Factor	Preamp Factor	Cable Loss	Remark	Ant Pos	Table Pos
	MHz	dBuV/m	dB	dBuV/m	dBuV	dB/m	dB	dB		cm	deg
1 @	4884.00	52.14	-21.86	74.00	47.27	33.39	35.09	6.57	Peak	---	---
2 @	4884.00	43.73	-10.27	54.00	38.86	33.39	35.09	6.57	Average	100	212



- Test Mode : Mode 3
- Polarization : Horizontal

The test that passed at minimum margin was marked by the frame in the following table.

	Freq	Level	Over Limit	Limit Line	Read Level	Antenna Factor	Preamp Factor	Cable Loss	Remark	Ant Pos	Table Pos
	MHz	dBuV/m	dB	dBuV/m	dBuV	dB/m	dB	dB		cm	deg
1 @	2328.00	54.94	-19.06	74.00	55.17	30.54	35.10	4.34	Peak	---	---
2 @	2328.00	43.23	-10.77	54.00	43.45	30.54	35.10	4.34	Average	181	162
3 @	2478.00	92.53			92.78	30.41	35.19	4.52	Peak	---	---
4 @	2478.00	80.06			80.31	30.41	35.19	4.52	Average	181	162
5 @	2483.50	72.61	-1.39	74.00	72.86	30.41	35.19	4.52	Peak	---	---
6 @	2483.50	53.50	-0.50	54.00	53.75	30.41	35.19	4.52	Average	181	162

Remark: #3 and #4 Fundamental Signal.

	Freq	Level	Over Limit	Limit Line	Read Level	Antenna Factor	Preamp Factor	Cable Loss	Remark	Ant Pos	Table Pos
	MHz	dBuV/m	dB	dBuV/m	dBuV	dB/m	dB	dB		cm	deg
1 @	4958.00	54.84	-19.16	74.00	49.73	33.68	35.08	6.50	Peak	---	---
2 @	4958.00	47.39	-6.61	54.00	42.29	33.68	35.08	6.50	Average	100	335

- Test Mode : Mode 3
- Polarization : Vertical

The test that passed at minimum margin was marked by the frame in the following table.

	Freq	Level	Over Limit	Limit Line	Read Level	Antenna Factor	Preamp Factor	Cable Loss	Remark	Ant Pos	Table Pos
	MHz	dBuV/m	dB	dBuV/m	dBuV	dB/m	dB	dB		cm	deg
1 @	2328.00	55.89	-18.11	74.00	56.11	30.54	35.10	4.34	Peak	---	---
2 @	2328.00	43.21	-10.79	54.00	43.43	30.54	35.10	4.34	Average	100	276
3 @	2478.00	95.35			95.60	30.41	35.19	4.52	Peak	---	---
4 @	2478.00	80.69			80.94	30.41	35.19	4.52	Average	100	276
5 @	2483.50	73.51	-0.49	74.00	73.76	30.41	35.19	4.52	Peak	---	---
6 @	2483.50	52.89	-1.11	54.00	53.14	30.41	35.19	4.52	Average	100	276

Remark: #3 and #4 Fundamental Signal

	Freq	Level	Over Limit	Limit Line	Read Level	Antenna Factor	Preamp Factor	Cable Loss	Remark	Ant Pos	Table Pos
	MHz	dBuV/m	dB	dBuV/m	dBuV	dB/m	dB	dB		cm	deg
1 @	4958.00	52.24	-21.76	74.00	47.13	33.68	35.08	6.50	Peak	---	---
2 @	4958.00	44.14	-9.86	54.00	39.04	33.68	35.08	6.50	Average	100	201

Remark: There is no more obvious emission except the listings above.



5.10 Antenna Requirements

5.10.1 Standard Applicable

For intentional device, according to FCC 47 CFR Section 15.203, an intentional radiator shall be designed to ensure that no other antenna except assembled by the responsible party shall be used with the device.

And according to FCC 47 CFR Section 15.247 (b), if directional gain of transmitting antennas is greater than 6dBi, the power shall be reduced by the same level in dB comparing to gain minus 6dBi.

5.10.2 Antenna Connected Construction

The antenna used in this product is a chip antenna without connector and it is considered to meet antenna requirement of FCC.

5.10.3 Antenna Gain

The antenna gain of EUT is less than 6dBi. Therefore, it is not necessary to reduce maximum peak output power limit.



6. List of Measuring Equipments Used

Instrument	Manufacturer	Model No.	Serial No.	Characteristics	Calibration Date	Due Date	Remark
EMC Receiver	R&S	ESCS 30	100174	9kHz – 2.75GHz	Oct. 19, 2005	Oct. 19, 2006	Conduction (CO01-HY)
LISN	MessTec	NNB-2/16Z	2001/009	9kHz – 30MHz	Apr. 26, 2005	Apr. 26, 2006	Conduction (CO01-HY)
LISN (Support Unit)	MessTec	NNB-2/16Z	2001/004	9kHz – 30MHz	Apr. 20, 2005	Apr. 20, 2006	Conduction (CO01-HY)
EMI Filter	LINDGREN	LRE-2060	1004	< 450Hz	N/A	N/A	Conduction (CO01-HY)
EMI Filter	LINDGREN	N6006	201052	0 – 60Hz	N/A	N/A	Conduction (CO01-HY)
RF Cable-CON	Suhner Switzerland	RG223/U	CB029	9kHz – 30MHz	Dec. 22, 2005	Dec. 22, 2006	Conduction (CO01-HY)
Spectrum analyzer	Agilent	E4408B	MY44211030	9KHz-26.5GHz	Jul. 25, 2005	Jul. 24, 2006	Radiation (03CH06-HY)
Receiver	R&S	ESCS30	100356	9KHz-2.75GHz	Jun. 28, 2005	Jun. 27, 2006	Radiation (03CH06-HY)
Controller	CT	SC100	N/A	N/A	N/A	N/A	Radiation (03CH06-HY)
Bilog Antenna	SCHAFFNER	CBL6112B	2885	30MHz -2GHz	Nov. 22, 2004	Nov. 22, 2006	Radiation (03CH06-HY)
Horn Antenna	Com-Power	AH118	071025	1G-18G	Feb. 22, 2005	Feb. 22, 2006	Radiation (03CH06-HY)
SHF-EHF Horn	SCHWARZBECK	BBHA 9170	9170-249	14G - 40G	Jul. 21, 2005	Jul. 20, 2006	Radiation (03CH06-HY)
HF Amplifier	MITEQ	AFS44	973248	0.1G - 26.5G	Nov. 23, 2005	Nov. 22, 2006	Radiation (03CH06-HY)
Amplifier	MITEQ	AMF-6F	997165	26G - 40G	Jul. 21, 2005	Jul. 20, 2006	Radiation (03CH06-HY)
Turn Table	HD	DS 420	420/650/00	0 ~ 360 degree	N/A	N/A	Radiation (03CH06-HY)
Antenna Mast	HD	MA 240	240/560/00	1 m - 4 m	N/A	N/A	Radiation (03CH06-HY)

7. Uncertainty Evaluation

Uncertainty of Conducted Emission Measurement (150kHz ~ 30MHz)

Contribution	Uncertainty of x_i		$u(x_i)$
	dB	Probability Distribution	
Receiver reading	0.10	Normal(k=2)	0.05
Cable loss	0.10	Normal(k=2)	0.05
AMN insertion loss	2.50	Rectangular	0.63
Receiver Spec	1.50	Rectangular	0.43
Site imperfection	1.39	Rectangular	0.80
Mismatch	+0.34/-0.35	U-shape	0.24
combined standard uncertainty Uc(y)	1.13		
Measuring uncertainty for a level of confidence of 95% U=2Uc(y)	2.26		

Uncertainty of Radiated Emission Measurement (30MHz ~ 1000MHz)

Contribution	Uncertainty of x_i		$u(x_i)$
	dB	Probability Distribution	
Receiver reading	0.41	Normal(k=2)	0.21
Antenna factor calibration	0.83	Normal(k=2)	0.42
Cable loss calibration	0.25	Normal(k=2)	0.13
Pre Amplifier Gain calibration	0.27	Normal(k=2)	0.14
RCV/SPA specification	2.50	Rectangular	0.72
Antenna Factor Interpolation for Frequency	1.00	Rectangular	0.29
Site imperfection	1.43	Rectangular	0.83
Mismatch	+0.39/-0.41	U-shaped	0.28
combined standard uncertainty Uc(y)	1.27		
Measuring uncertainty for a level of confidence of 95% U=2Uc(y)	2.54		



Uncertainty of Radiated Emission Measurement (1GHz ~ 40GHz)

Contribution	Uncertainty of x_i		$u(x_i)$	C_i	$C_i * u(x_i)$
	dB	Probability Distribution			
Receiver reading	±0.10	Normal(k=1)	0.10	1	0.10
Antenna factor calibration	±1.70	Normal(k=2)	0.85	1	0.85
Cable loss calibration	±0.50	Normal(k=2)	0.25	1	0.25
Receiver Correction	±2.00	Rectangular	1.15	1	1.15
Antenna Factor Directional	±1.50	Rectangular	0.87	1	0.87
Site imperfection	±2.80	Triangular	1.14	1	1.14
Mismatch Receiver VSWR $\Gamma_1 = 0.197$ Antenna VSWR $\Gamma_2 = 0.194$ Uncertainty = $20 \log(1 - \Gamma_1 * \Gamma_2 * \Gamma_3)$	+0.34/-0.35	U-shaped	0.244	1	0.244
Combined standard uncertainty $U_c(y)$	2.36				
Measuring uncertainty for a level of confidence of 95% $U = 2U_c(y)$	4.72				