

FCC TEST REPORT

for

47 CFR Part 22H, 24E

Equipment : PDA Phone
Trade Name : BenQ
Model No. : P50(57P50)
FCC ID : JVP57P50
Tx Frequency Range : GSM 850: 824.2~848.8MHz
PCS 1900: 1850.2~1909.8MHz
Max. RF Output Power : GSM 850: 0.45W
PCS 1900: 0.25W
Emission Designator : 300 KGXW
Applicant : BenQ Corporation
157 Shan-Ying Road, Gueishan, Taoyuan 333,
Taiwan, R.O.C.

- The test result refers exclusively to the test presented test model / sample.
- Without written approval of SPORTON International Inc., the test report shall not be reproduced except in full.
- Certificate or Test Report must not be used by the applicant to claim the product in this test report endorsement by NVLAP or any agency of U.S. government.
- The data shown in this test report were carried out on Nov. 24, 2004 at Sporton International Inc. LAB.

Daniel Lee 2/23/2005

Dr. Daniel Lee
EMC/SAR Manager

SPORTON International Inc.

6F, No.106, Sec. 1, Hsin Tai Wu Rd., Hsi Chih, Taipei Hsien, Taiwan, R.O.C.

SPORTON International Inc.

TEL : 886-2-2696-2468

FAX : 886-2-2696-2255



Table of Contents

History of this test report.....ii

1. General Information 1

 1.1. Applicant1

 1.2. Manufacturer1

 1.3. Basic Description of Equipment under Test1

 1.4. Feature of Equipment under Test2

 1.5. Report Date2

2 Test Configuration of Equipment under Test3

 2.1 Test Manner3

 2.2 Test Mode3

 2.3 Connection Diagram of Test System4

 2.4 Ancillary Equipment List4

3. General Information of Test Site5

 3.1 Test Voltage5

 3.2 Test in Compliance with5

 3.3 Frequency Range Investigated5

 3.4 Test Distance5

4. Test Data and Test Result.....6

 4.1 List of Measurements and Examinations6

 4.2 RF Output Power7

 4.3 ERP / EIRP Measurement8

 4.4 Occupied Bandwidth and Band Edge Measurement11

 4.5 Conducted Emission20

 4.6 Field Strength of Spurious Radiation30

 4.7 Frequency Stability (Temperature Variation)37

 4.8 Frequency Stability (Voltage Variation).....39

5 List of Measurement Equipments40

6 Uncertainty Evaluation.....41

Appendix A. Photographs of EUT External

Appendix B. Photographs of EUT Internal

Appendix C. Photographs of Setup



1. General Information

1.1. Applicant

BenQ Corporation

157 Shan-Ying Road, Gueishan, Taoyuan 333, Taiwan, R.O.C.

1.2 Manufacturer

BenQ Corporation

157 Shan-Ying Road, Gueishan, Taoyuan 333, Taiwan, R.O.C.

1.3 Basic Description of Equipment under Test

Equipment	: PDA Phone
Trade Name	: BenQ
Model No.	: P50(57P50)
FCC ID	: JVP57P50
Earphone	: EMC147-X043 57P30
Charger	: NAC060240U807-1
Battery	: BAT LI-I 3.7V 1240MA 57P50
Data Cable	: CABLE USB WITH CORE 1500MM P30



1.4 Feature of Equipment under Test

DUT Type :	PDA Phone
Trade Name :	BenQ
Model Name :	P50(57P50)
FCC ID :	JVP57P50
Tx Frequency :	GSM 850: 824.2~848.8MHz PCS 1900: 1850.2~1909.8MHz
Rx Frequency :	GSM 850: 869.2~893.8 PCS 1900: 1930.2~1989.8MHz
Antenna Type :	Fixed Internal
Maximum Output Power to Antenna :	GSM 850: 1.854 W (32.68 dBm) PCS 1900: 0.830 W (29.19 dBm)
Maximum EIRP :	GSM 850: 0.45 W (26.510 dBm) PCS 1900: 0.25 W (23.948 dBm)
IMEI :	354768000000001
HW Version :	LPR4-1
SW Version :	SW0.02ww
Digital Modulation Emission :	GMSK
Type of Emission :	300 KGXW
DUT Stage :	Identical Prototype

1.5 Report Date

EUT Received : Oct. 12, 2004

Report Date : Feb. 22, 2005



2 Test Configuration of Equipment under Test

2.1 Test Manner

- a. The spurious emission measurements were carried out in semi-anechoic chamber with 3-meter test range.
- b. During all testings, EUT is in link mode with base station emulator at maximum power level. (PCL=5 for GSM 850 or PCL=0 for PCS 1900)
- c. Frequency range investigated: radiated emission 30 MHz to 9000 MHz for GSM850; 30MHz to 19000 MHz fro PCS 1900.

2.2 Test Mode

Application	GSM 850	PCS 1900
Radiated Emission	<input checked="" type="checkbox"/> Mode 1: CH 189	<input checked="" type="checkbox"/> Mode 2: CH 661
Conducted Measurement	<input checked="" type="checkbox"/> Mode 1: CH 189	<input checked="" type="checkbox"/> Mode 2: CH 661

2.3 Connection Diagram of Test System

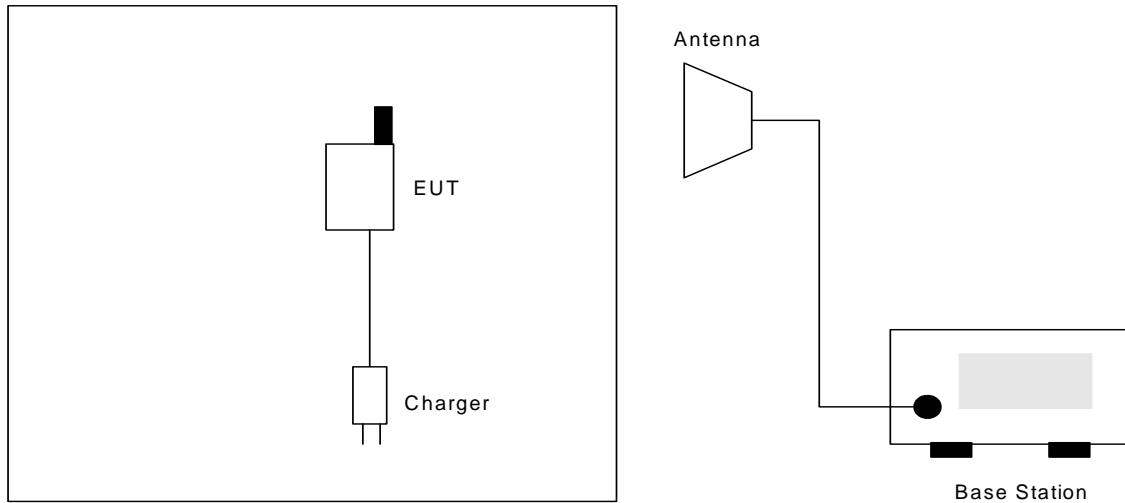

2.4 Ancillary Equipment List

Item	Equipment	Model No.	Serial No.
1.	Base Station	CMU200	105934
2.	Base Station	E5515C	GB43460754



3. General Information of Test Site

Test Site Location : No. 52, Hwa Ya 1st Rd., Hwa Ya Technology Park,
Kwei-Shan Hsiang, Tao Yuan Hsien, Taiwan, R.O.C.
TEL : 886-3-327-3456
FAX : 886-3-318-0055

Test Site No : 03CH06-HY

The chamber meets the characteristics of ANSI C63.4-2003. This site is on file with the FCC. The Industry Canada file number for this site is IC 4088.

3.1 Test Voltage

120V/ 60Hz

3.2 Test in Compliance with

47 CFR Part 22H, 24E and Part 2.

3.3 Frequency Range Investigated

- a. Radiation: from 30MHz to 9000MHz for GSM 850.
- b. Radiation: from 30 MHz to 19000 MHz for PCS 1900.

3.4 Test Distance

The test distance of radiated emission from antenna to EUT is 3 m.



4. Test Data and Test Result

4.1 List of Measurements and Examinations

FCC Rule	IC RULE	DESCRIPTION OF TEST	Result	Section
§2.1046	RSS-128 § 7.1 RSS-133 § 6.2	RF Output Power	Passed	4.2
§ 22.913 §24.232	RSS-128 § 7.1 RSS-133 § 6.2	ERP / EIRP	Passed	4.3
§2.1049, § 22.917, § 24.238(b)	RSS-128 § 7.4 RSS-133 § 6.3	Occupied Bandwidth & Band Edge Measurement	Passed	4.4
§2.1051	RSS-128 § 7.4 RSS-133 § 6.3	Conducted Emission	Passed	4.5
§2.1053	RSS-128 § 7.4 RSS-133 § 6.3	Field Strength of Spurious Radiation	Passed	4.6
§2.1055, § 22.355, §24.235	RSS-128 § 9 RSS-133 § 7	Frequency Stability vs. Temperature	Passed	4.7
§2.1055, §22.355, §24.235	RSS-128 § 9 RSS-133 § 7	Frequency Stability vs. Voltage	Passed	4.8

4.2 RF Output Power

4.2.1 Measurement Instruments :

As described in chapter 5 of this test report.

4.2.2 Test Procedure :

1. The transmitter output was connected to power meter and base station through power divider.
2. Set EUT at PCL=5 for GSM 850 and/or PCL=0 for PCS 1900 through base station.
3. Select lowest, middle, and highest channels for each band.

4.2.3 Test Setup Layout :

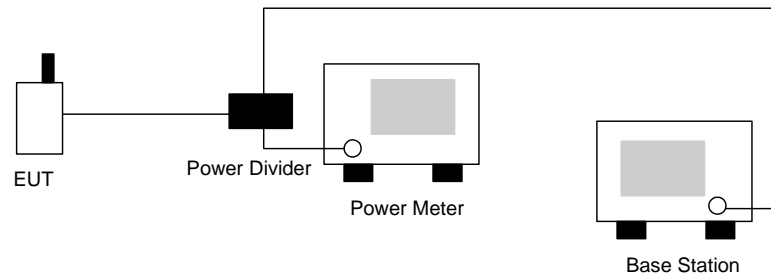

4.2.4 Test Result :

Bands	Channel	Frequency (MHz)	Conducted Power (dBm)	Conducted Power (Watts)
GSM 850	128	824.2 (Low)	32.68	1.854
	189	836.4 (Mid)	32.54	1.795
	251	848.8 (High)	32.49	1.774

Bands	Channel	Frequency (MHz)	Conducted Power (dBm)	Conducted Power (Watts)
PCS 1900	512	1850.2 (Low)	29.19	0.830
	661	1880.0 (Mid)	29.14	0.820
	810	1909.8 (High)	29.18	0.828



4.3 ERP / EIRP Measurement

Equivalent isotropic radiated power measurements by substitution method according to ANSI/TIA/EIA-603-A.

4.3.1 Measurement Instruments

As described in chapter 5 of this test report.

4.3.2 Test Procedure

1. The EUT was placed on a rotatable wooden table with 0.8 meter about ground.
2. The EUT was set 3 meters from the receiving antenna which was mounted on the antenna tower.
3. The table was rotated 360 degrees to determine the position of the highest radiated power.
4. The height of the receiving antenna is varied between one meter and four meters to reach the maximum radiated power for both horizontal and vertical polarizations.
5. Taking the record of maximum ERP/EIRP.
6. A Horn antenna was substituted in place of the EUT and was driven by a signal generator.
7. The conducted power at the terminal of the Horn antenna is measured.
8. Repeat step 3 to step 5 to get the maximum ERP/EIRP of the substitution antenna.

9. $ERP/EIRP = P_s + E_t - E_s + G_s = P_s + R_t - R_s + G_s$

P_s (dBm): Input power to substitution antenna.

G_s (dBi or dBd): Substitution antenna Gain.

$$E_t = R_t + AF$$

$$E_s + R_s + AF$$

AF (dB/m): Receive antenna factor

10. R_t : the highest received signal in Spectrum Analyzer for EUT.

4.3.3 Test Setup Layout of ERP/EIRP

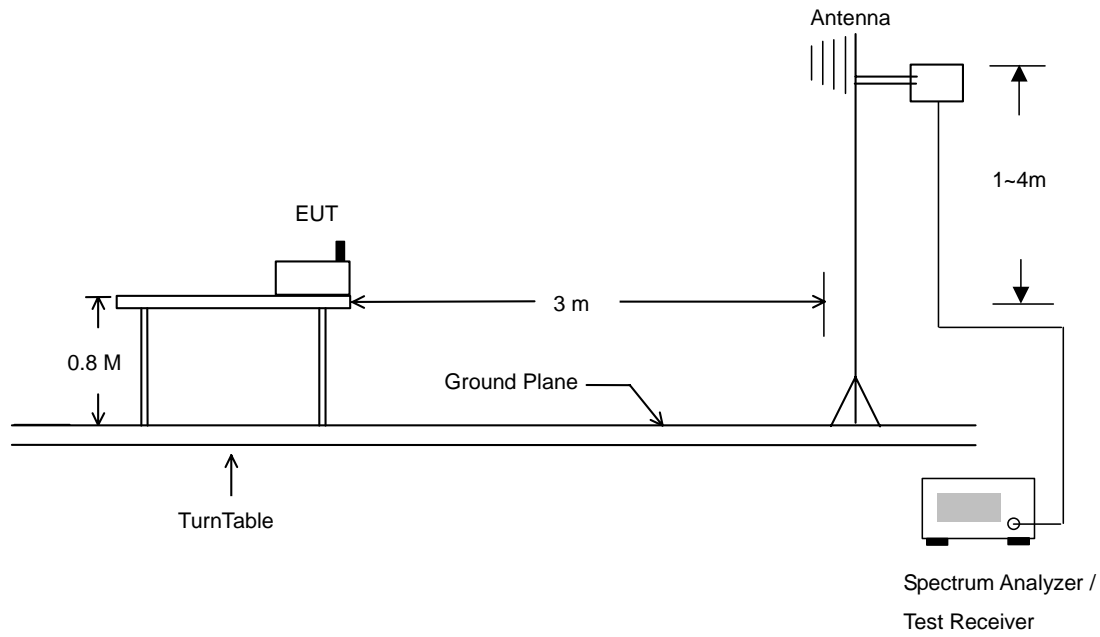



4.3.4 Test Result

GSM 850 Radiated Power ERP					
H Polarization			V Polarization		
Frequency (MHz)	ERP (dBm)	ERP (Watts)	Frequency (MHz)	ERP (dBm)	ERP (Watts)
824.240	25.860	0.39	824.220	26.130	0.41
836.390	26.510	0.45	836.320	25.200	0.33
848.770	25.050	0.32	848.870	24.760	0.30

PCS1900 Radiated Power EIRP					
H Polarization			V Polarization		
Frequency (MHz)	EIRP (dBm)	EIRP (Watts)	Frequency (MHz)	EIRP (dBm)	EIRP (Watts)
1850.170	23.948	0.25	1850.220	20.837	0.12
1880.070	22.721	0.19	1879.940	19.534	0.09
1909.740	21.608	0.14	1909.720	19.653	0.09

4.4 Occupied Bandwidth and Band Edge Measurement

4.4.1 Measurement Instruments

As described in chapter 5 of this test report.

4.4.2 Test Procedure

1. The EUT was connected to Spectrum Analyzer and Base Station via power divider.
2. The occupied bandwidth of middle channel for the highest and lowest RF powers were measured.
3. The bandedge of low and high channels for the highest RF powers within the transmitting frequency band were measured. Setting RBW as roughly $BW/10$.

4.4.3 Test Setup Layout

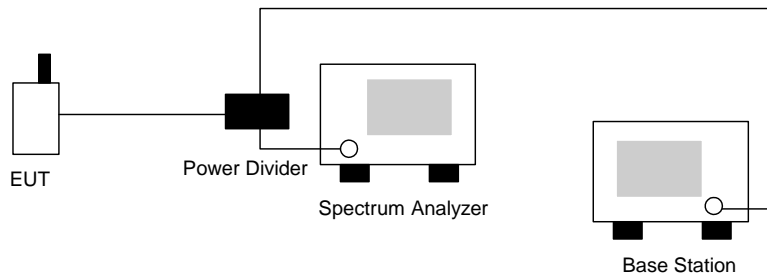



4.4.4 Test Result

- Test Mode : GSM 850 CH128 Lower Band Edge
- Power State : High

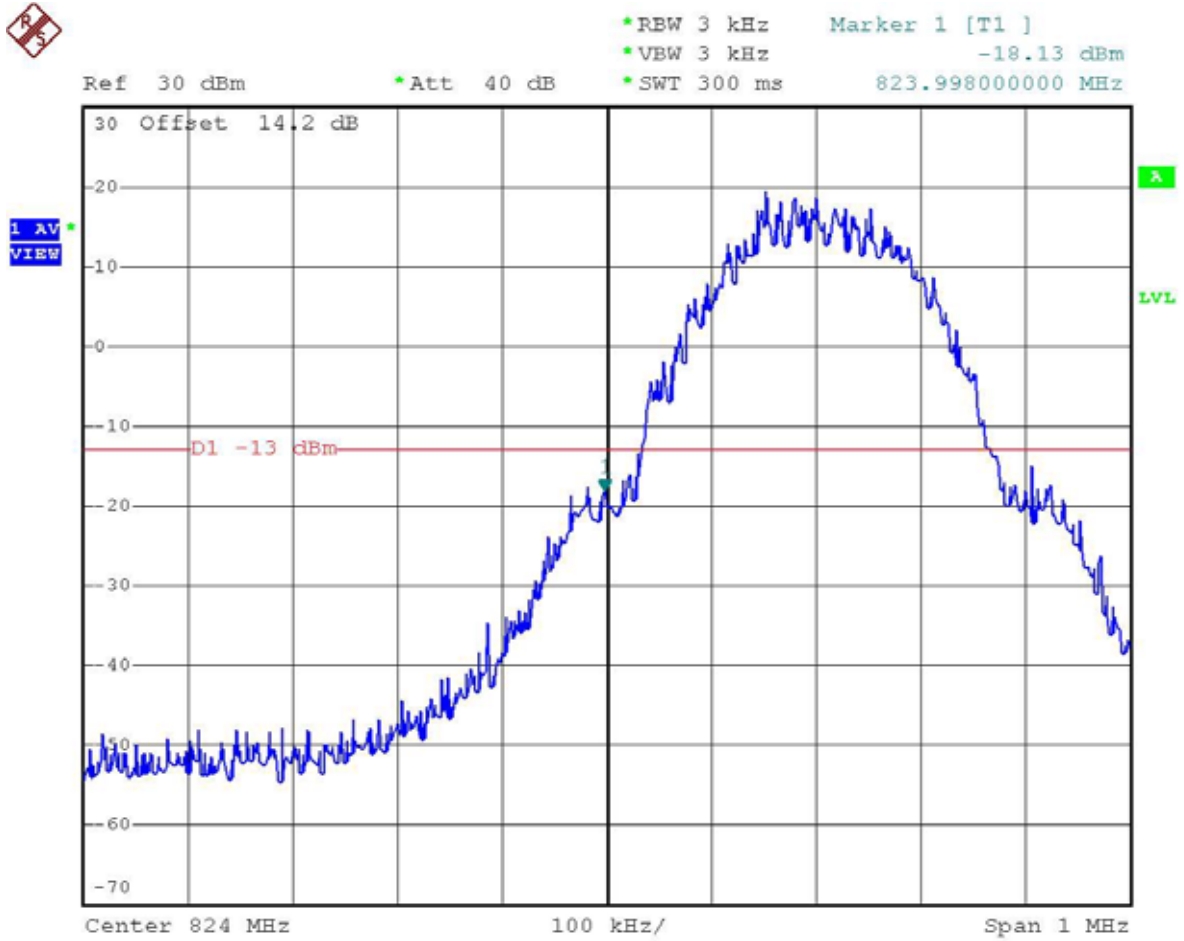



- Test Mode : GSM 850 CH189 99% Occupied Bandwidth
- Power State : High

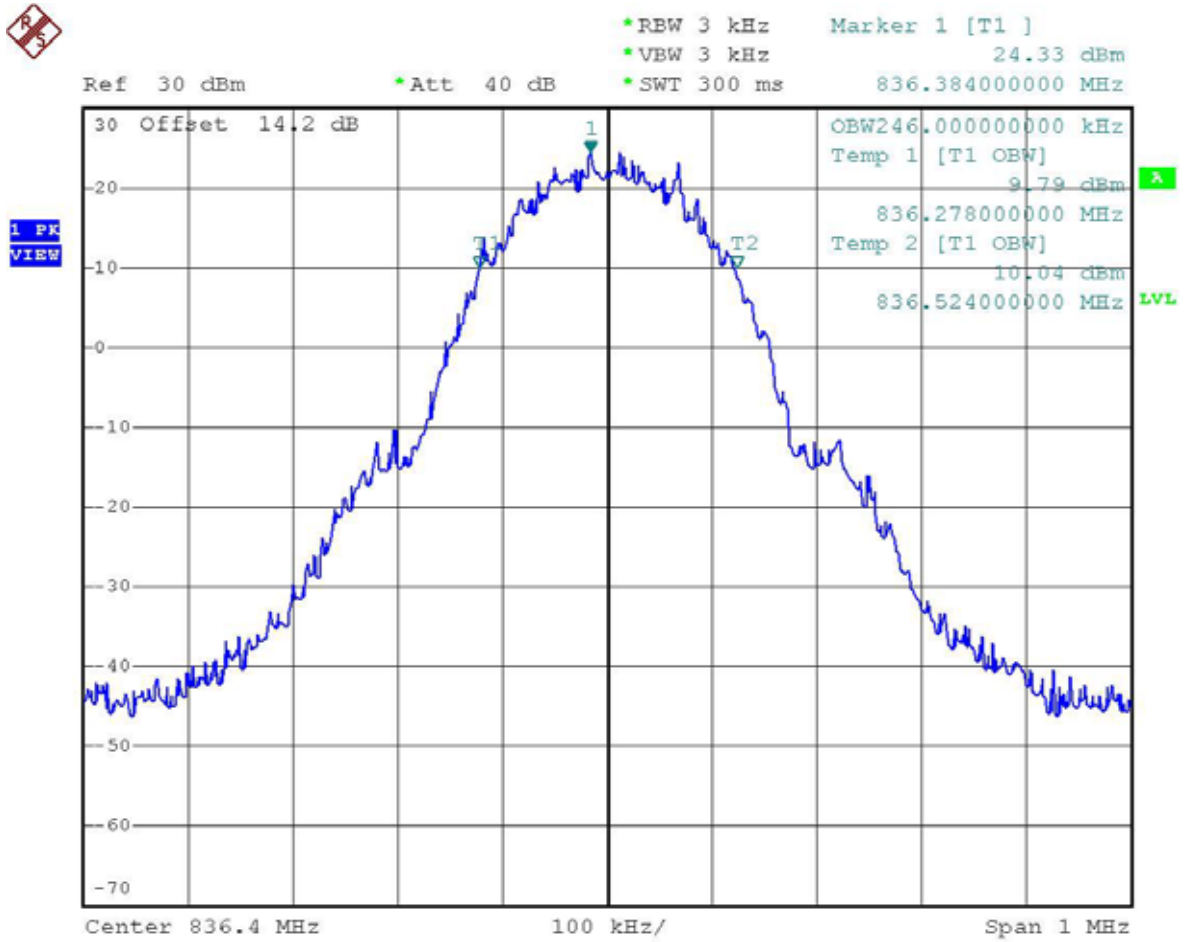



- Test Mode : GSM 850 CH251 Higher Band Edge
- Power State : High

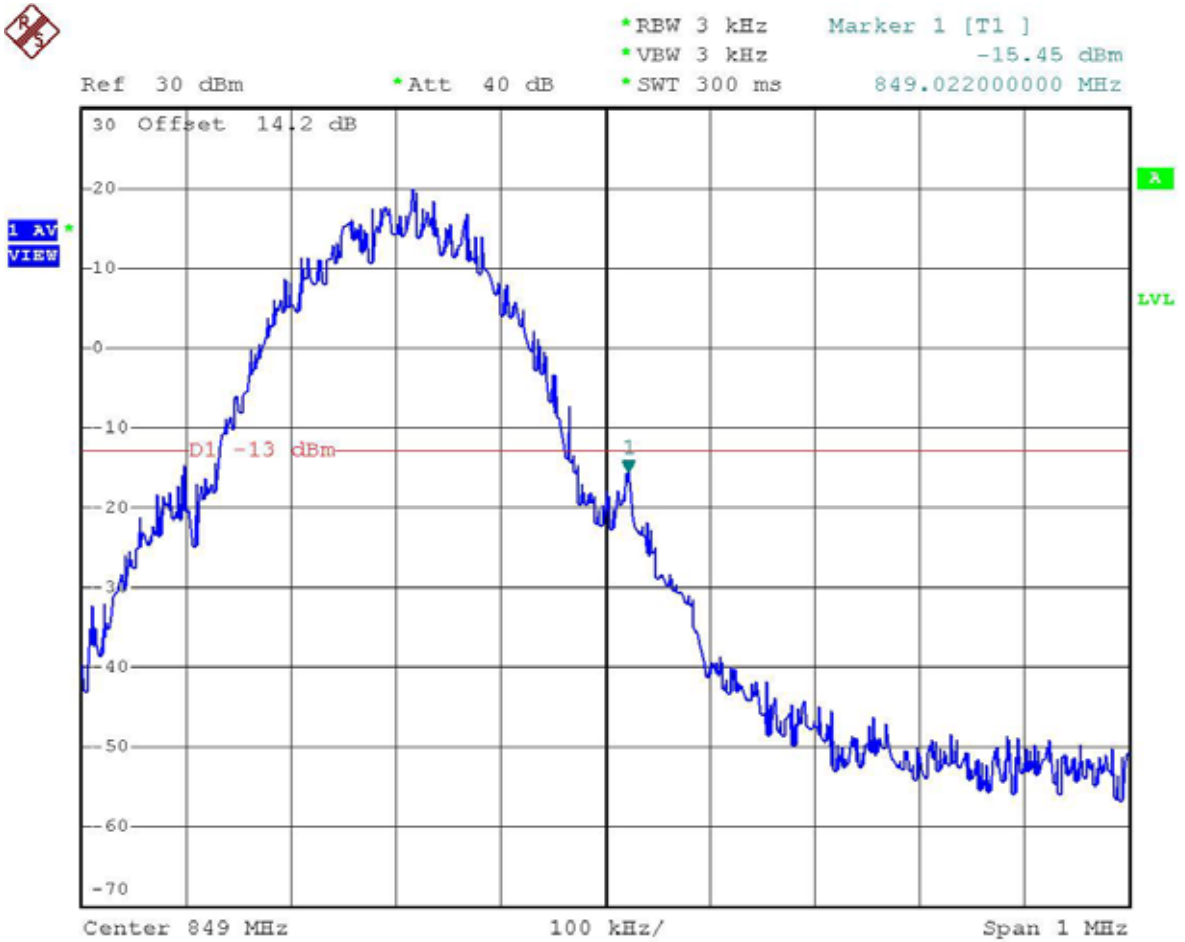



- Test Mode : PCS 1900 CH512 Lower Band Edge
- Power State : High

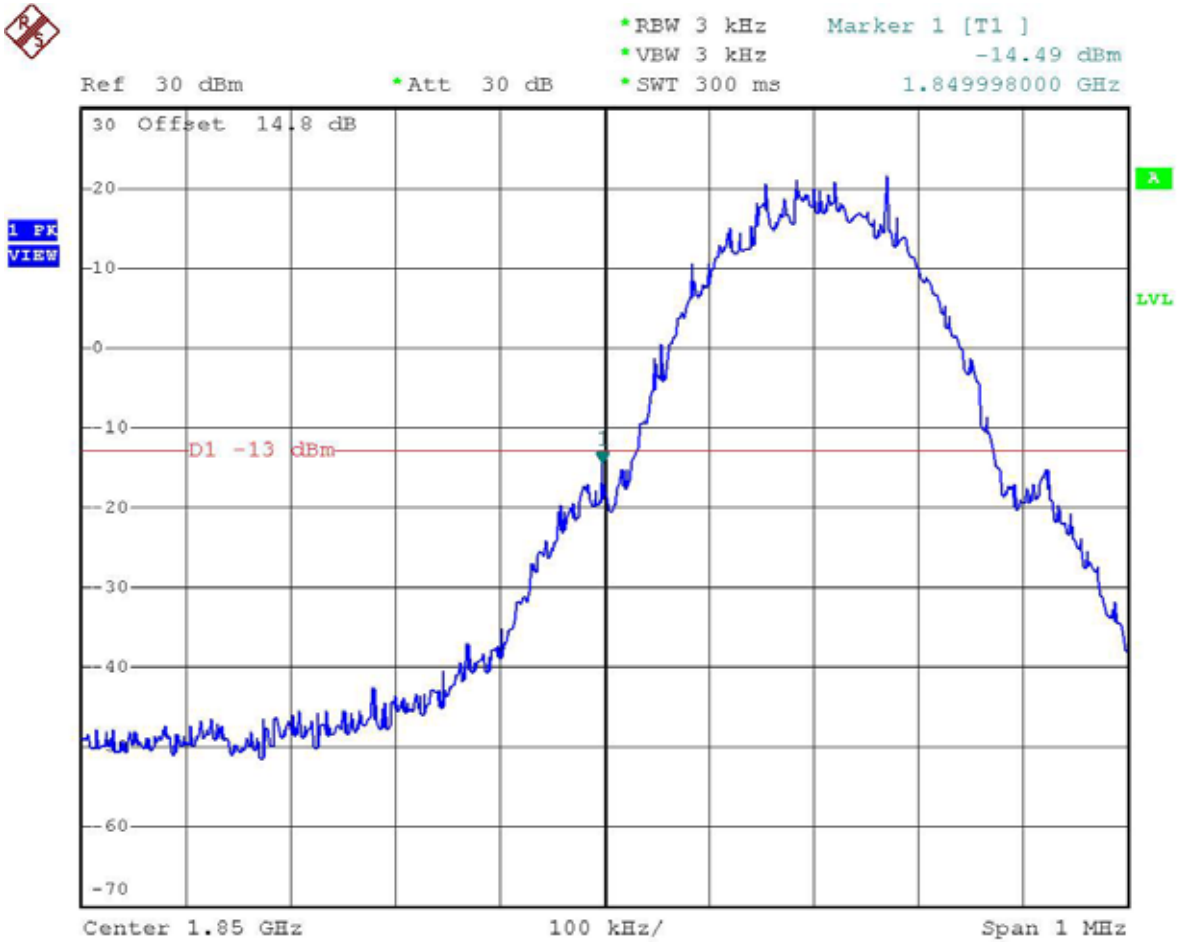



- Test Mode : PCS 1900 CH661 99% Occupied Bandwidth
- Power State : Low

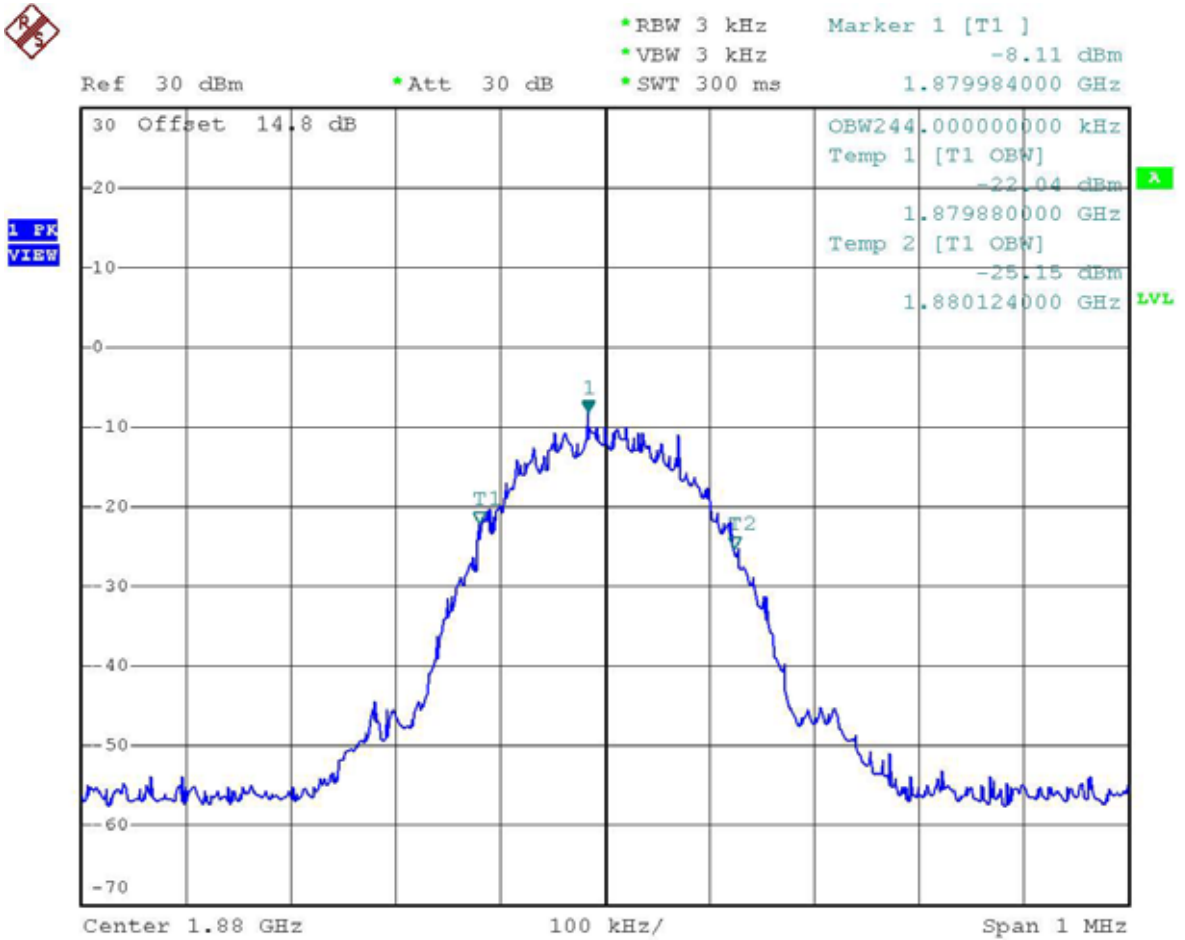



- Test Mode : PCS 1900 CH661 99% Occupied Bandwidth
- Power State : High

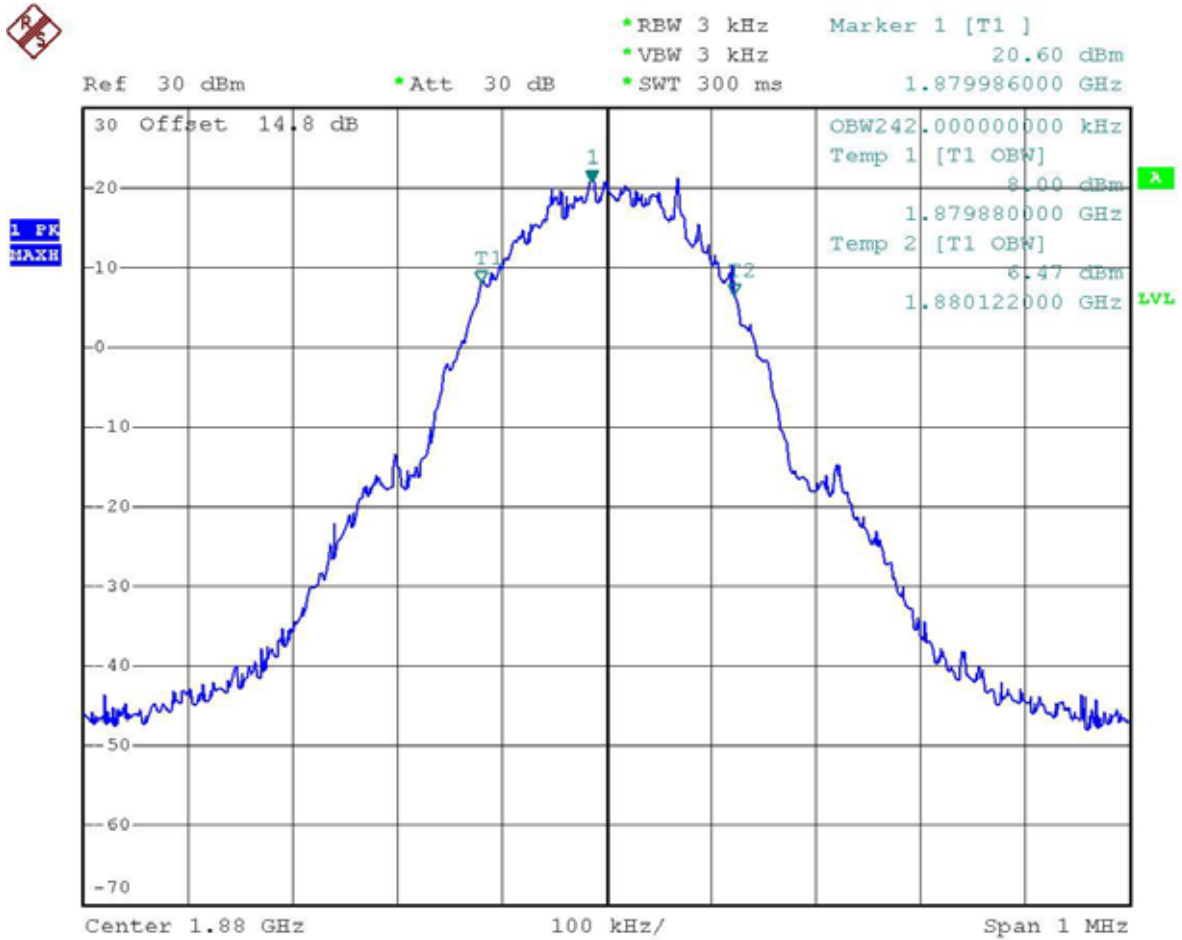



- Test Mode : PCS 1900 CH810 Higher Band Edge
- Power State : High

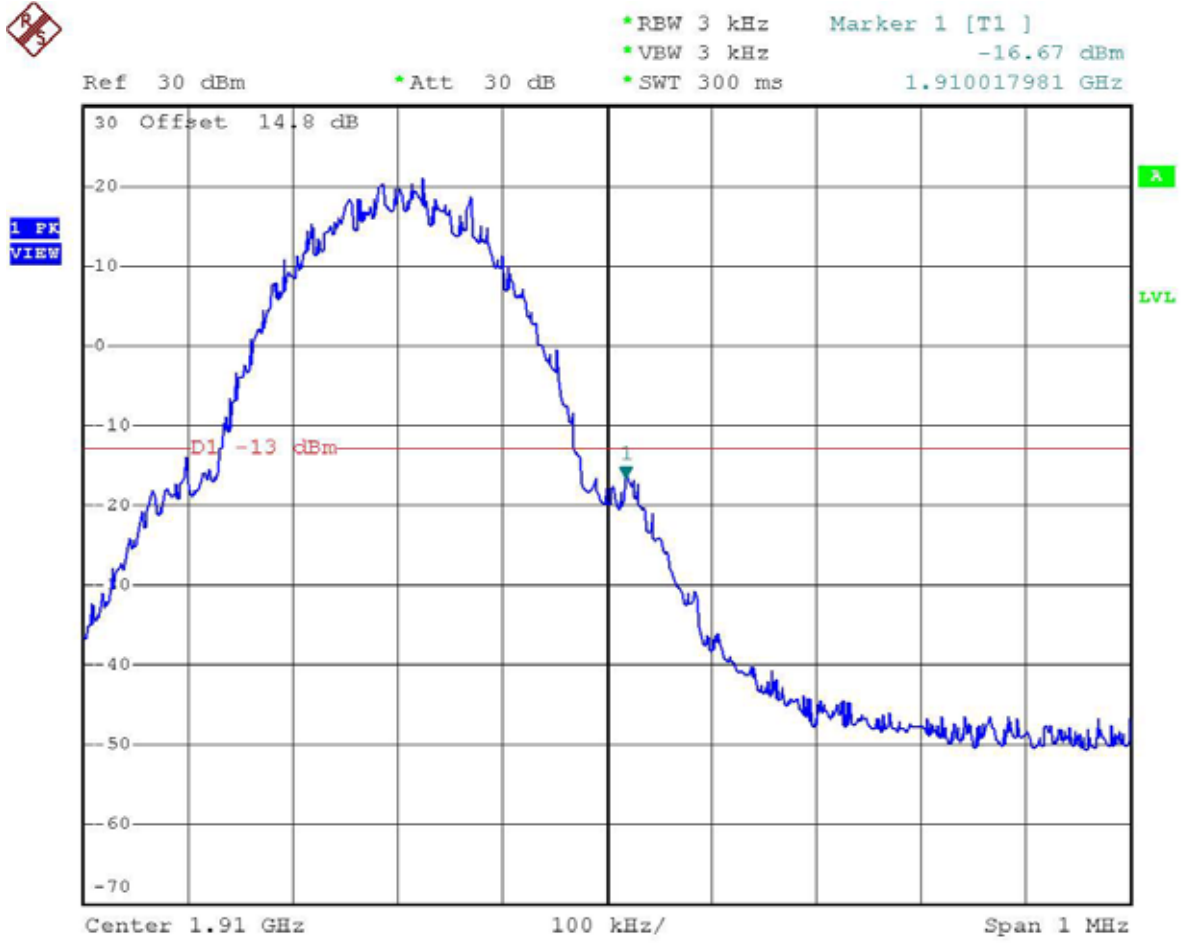

4.5 Conducted Emission

4.5.1 Measurement Instruments

As described in chapter 5 of this test report.

4.5.2 Test Procedure

1. The EUT was connected to Spectrum Analyzer and Base Station via power divider.
2. The middle channel for the highest RF power within the transmitting frequency was measured.
3. The conducted spurious emission for the whole frequency range was taken.

4.5.3 Test Setup Layout

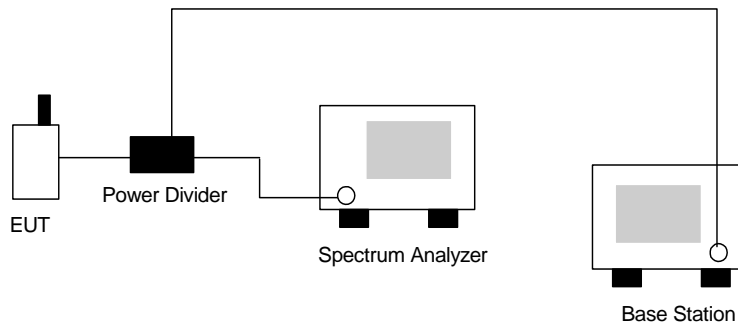



4.5.4 Test Result

- Test Mode : GSM 850 CH189
- Frequency Range : 30M-1G

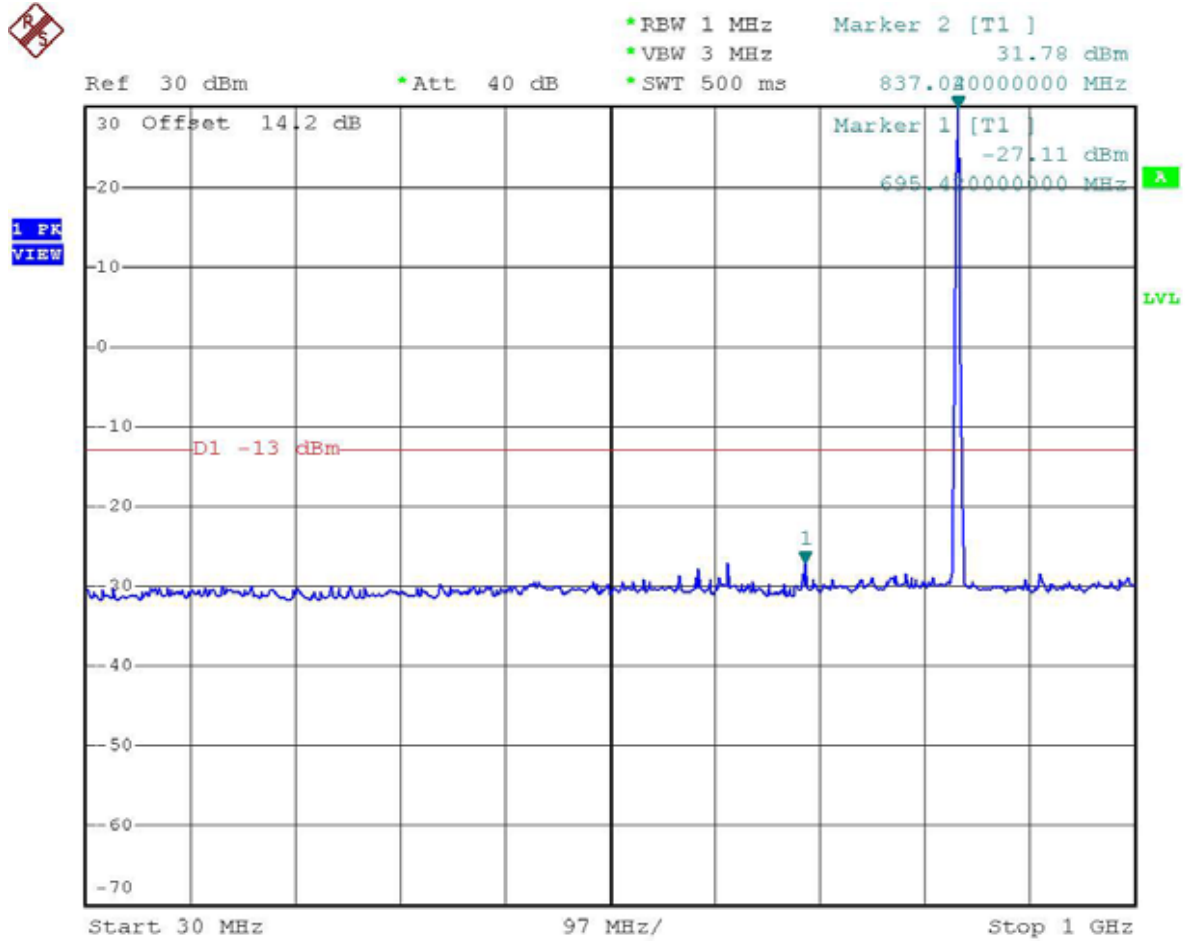



- Test Mode : GSM 850 CH189
- Frequency Range : 1G-3G

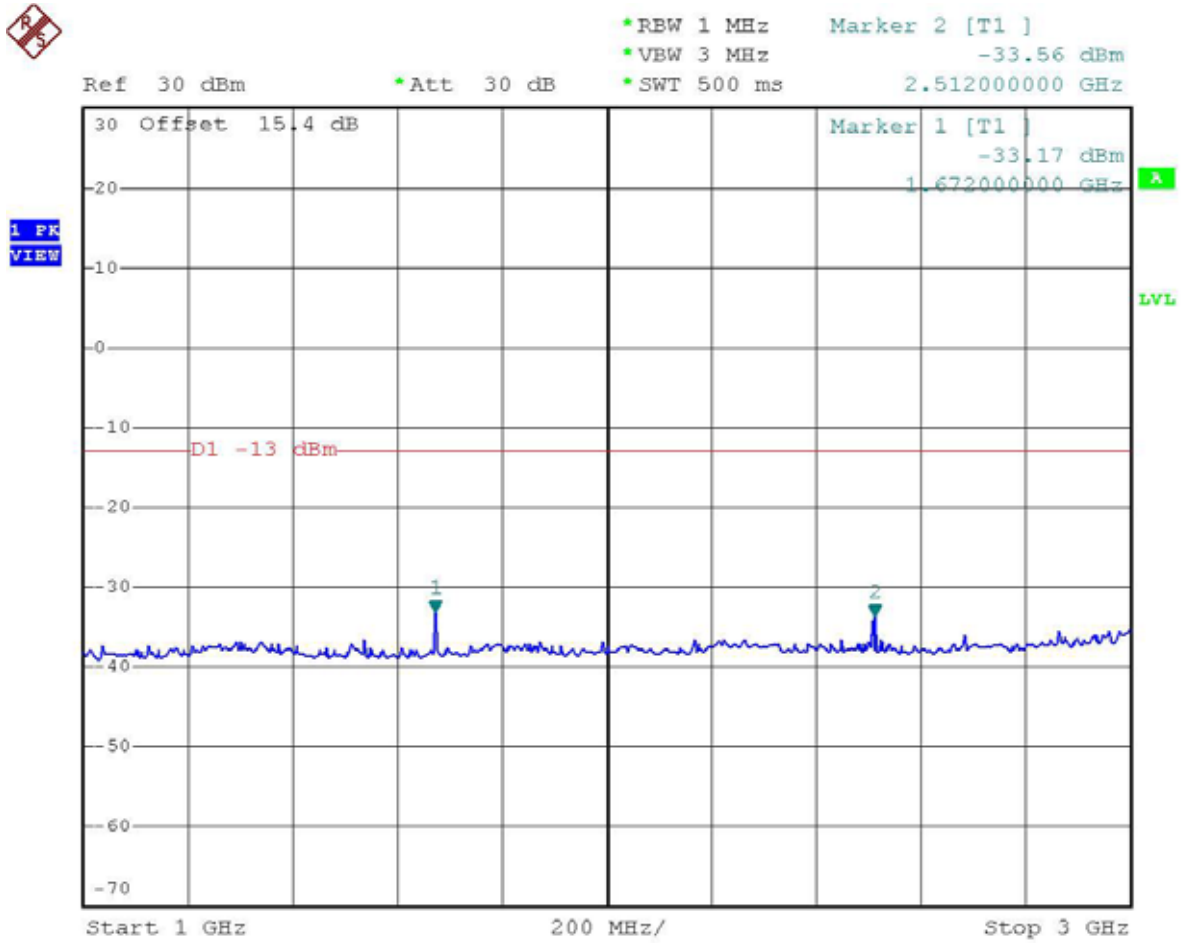



- Test Mode : GSM 850 CH189
- Frequency Range : 3G-6G

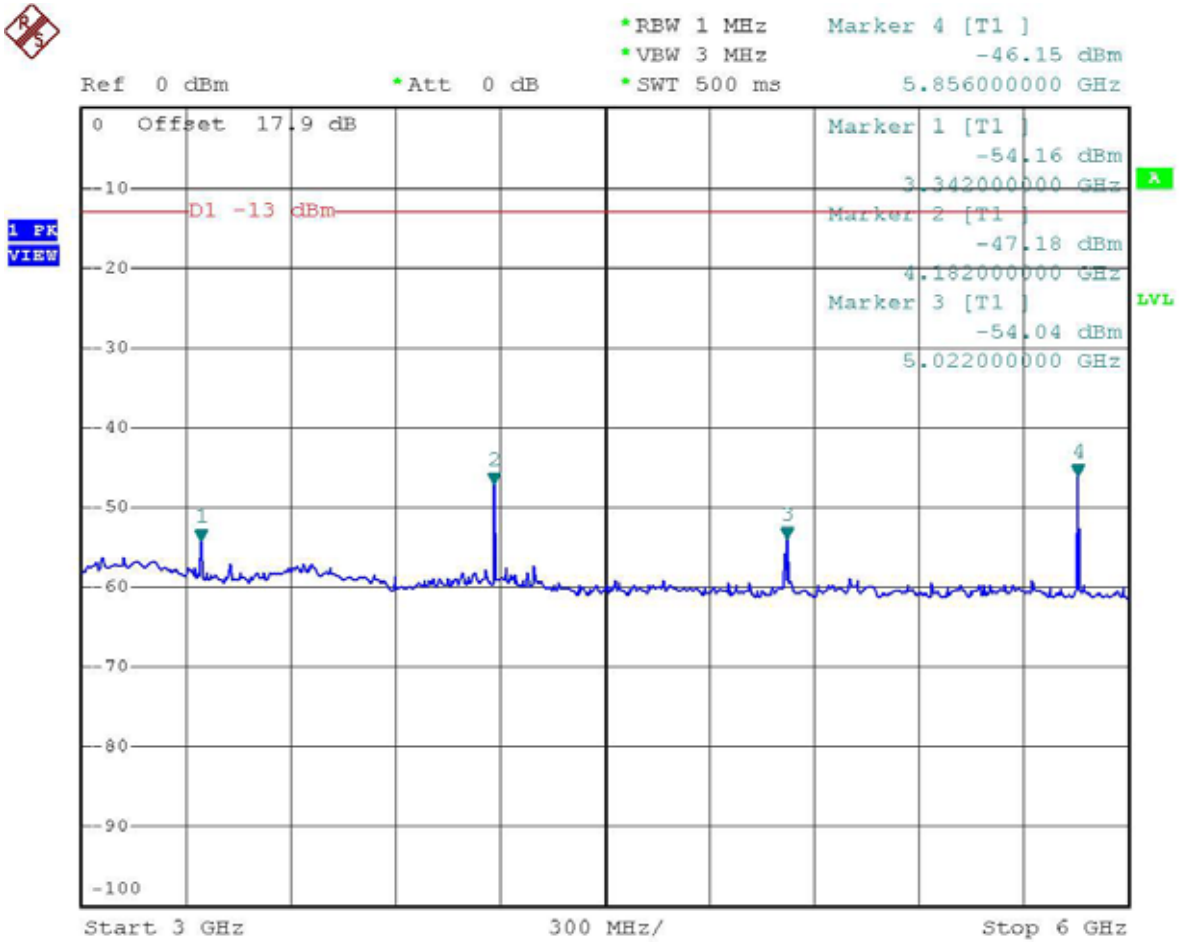



- Test Mode : GSM 850 CH189
- Frequency Range : 6G-9G

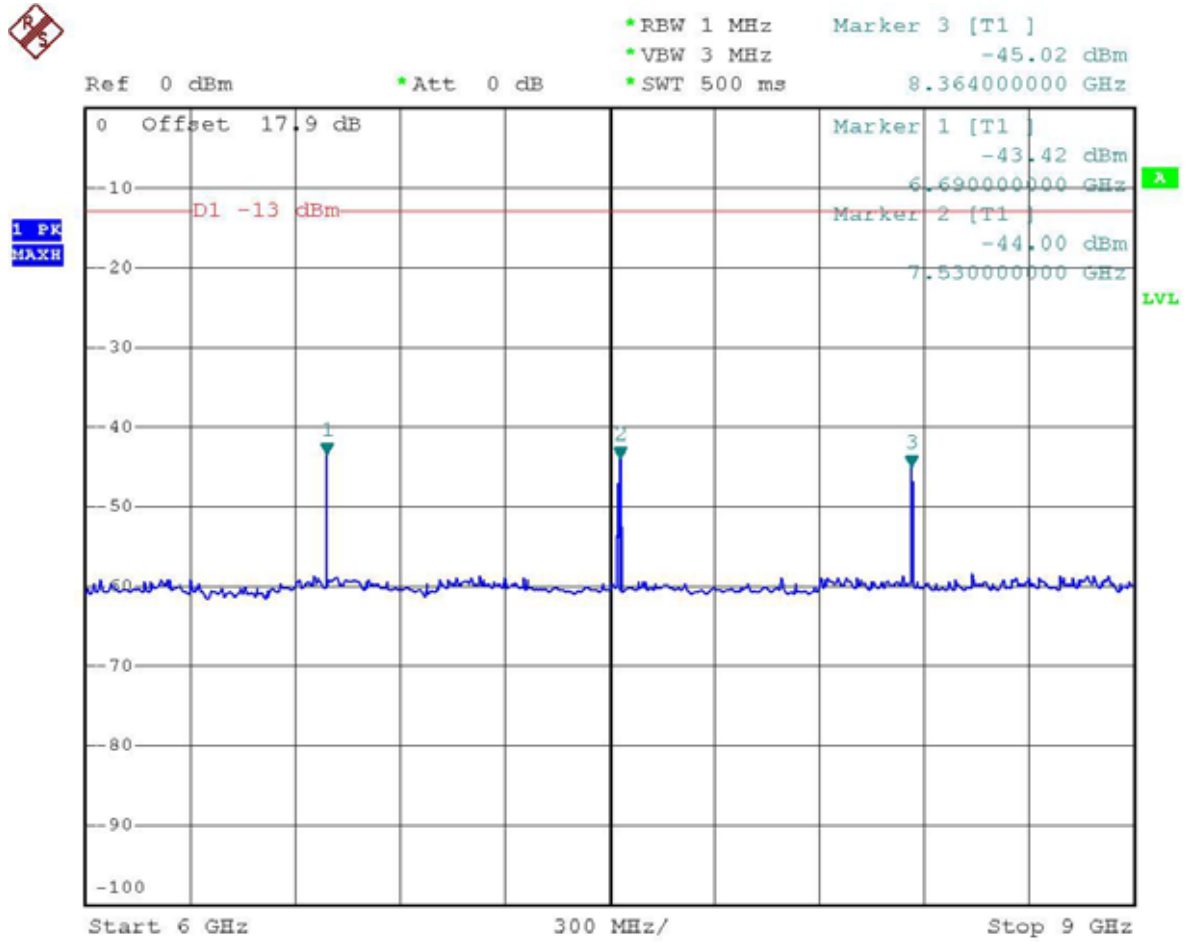



- Test Mode : PCS 1900 CH661
- Frequency Range : 0.3G-1G

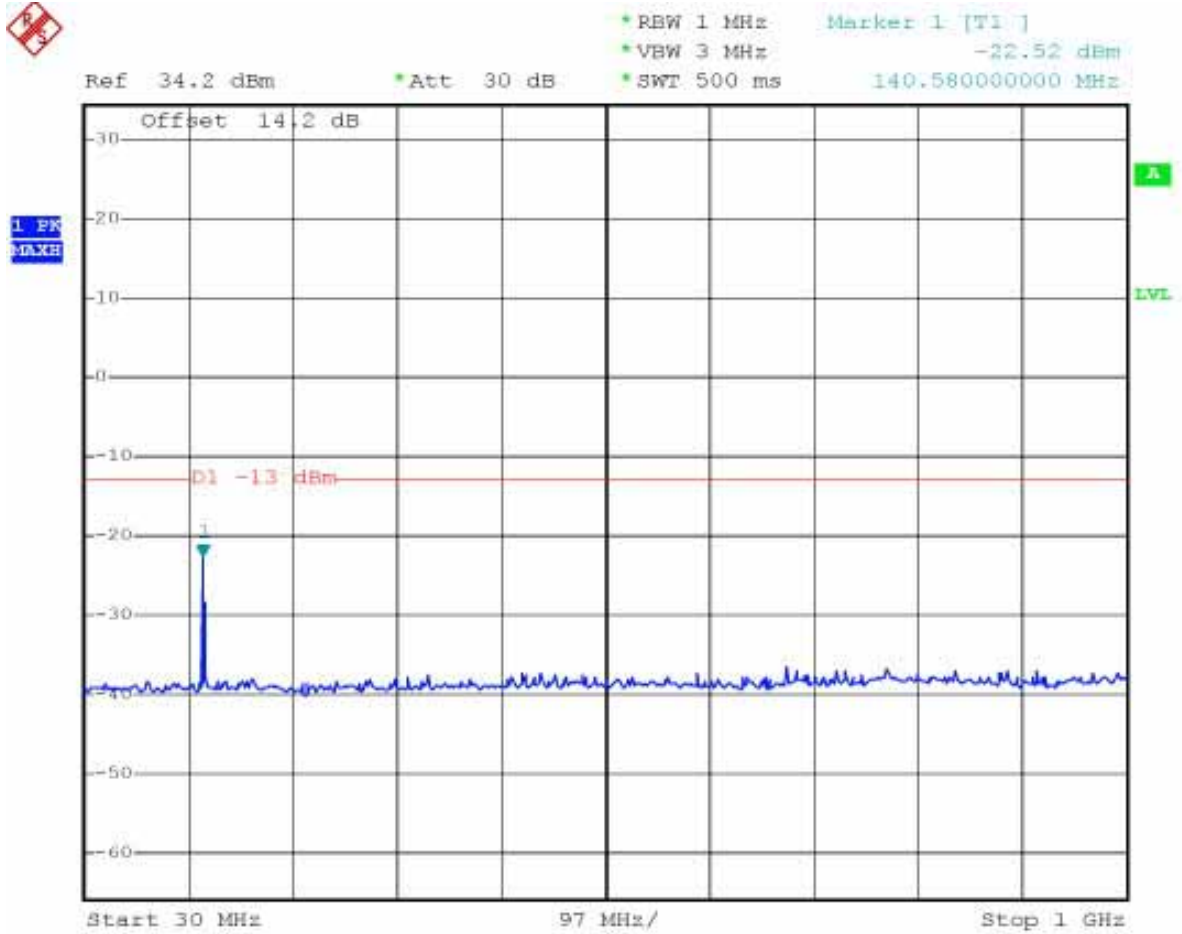



- Test Mode : PCS 1900 CH661
- Frequency Range : 1G-3G

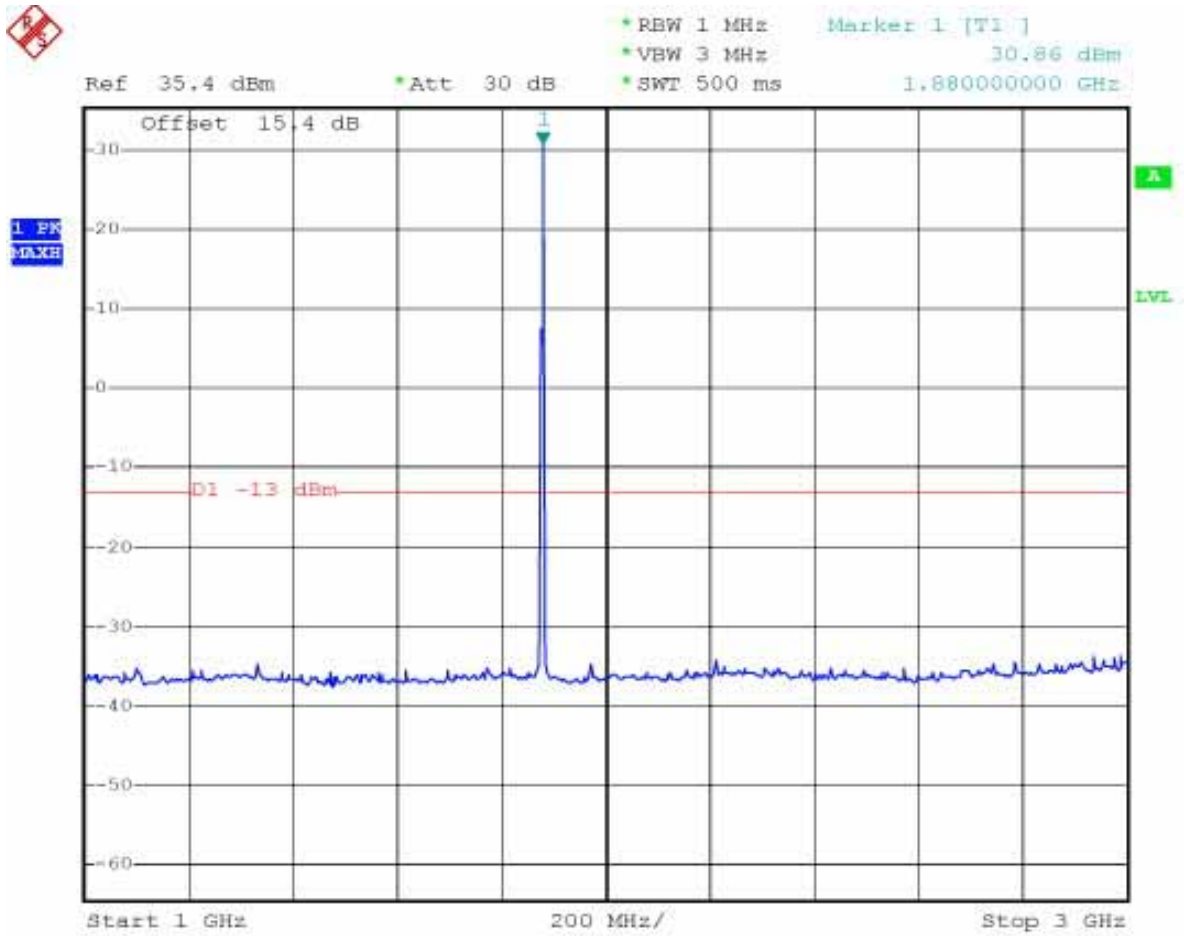



- Test Mode : PCS 1900 CH661
- Frequency Range : 3G-7G

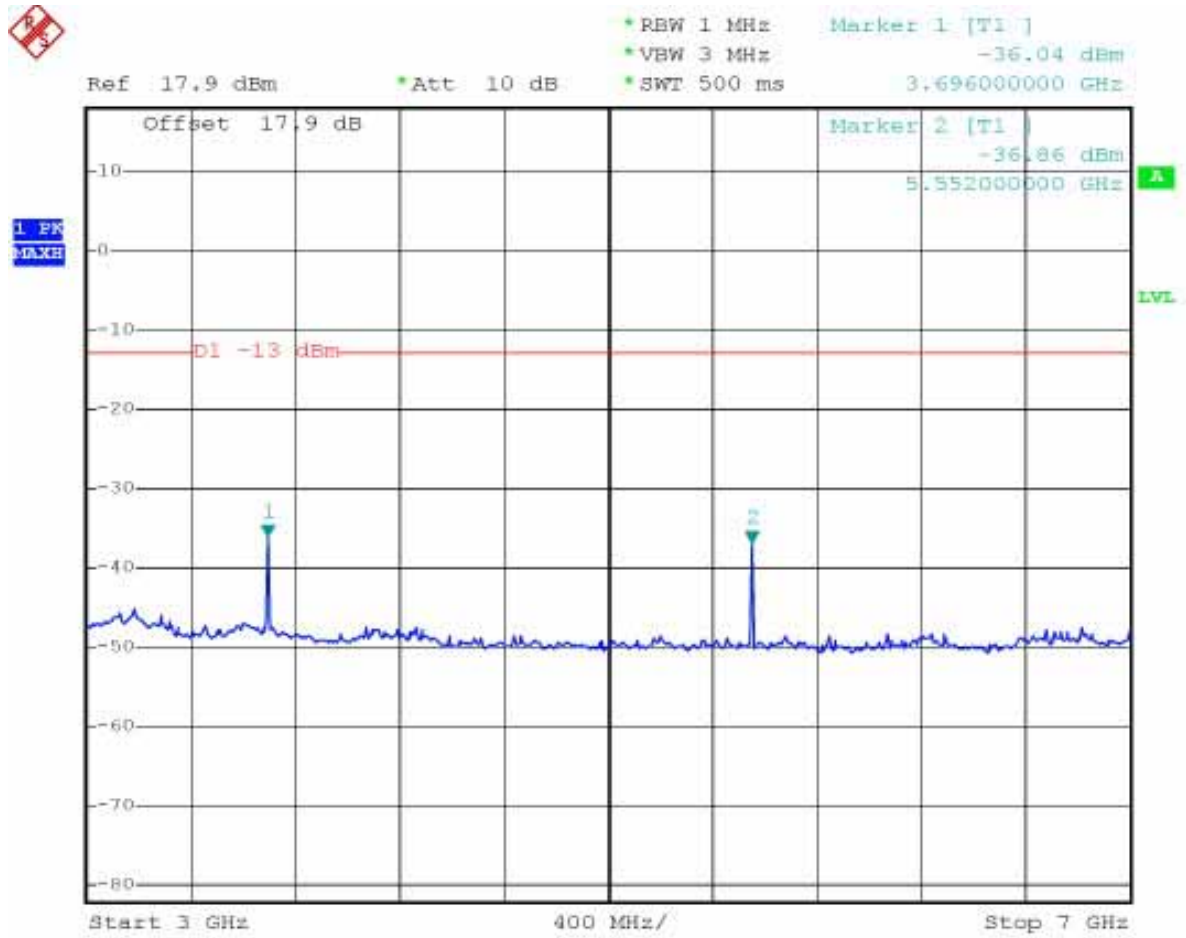



- Test Mode : PCS 1900 CH661
- Frequency Range : 7G-13.6G

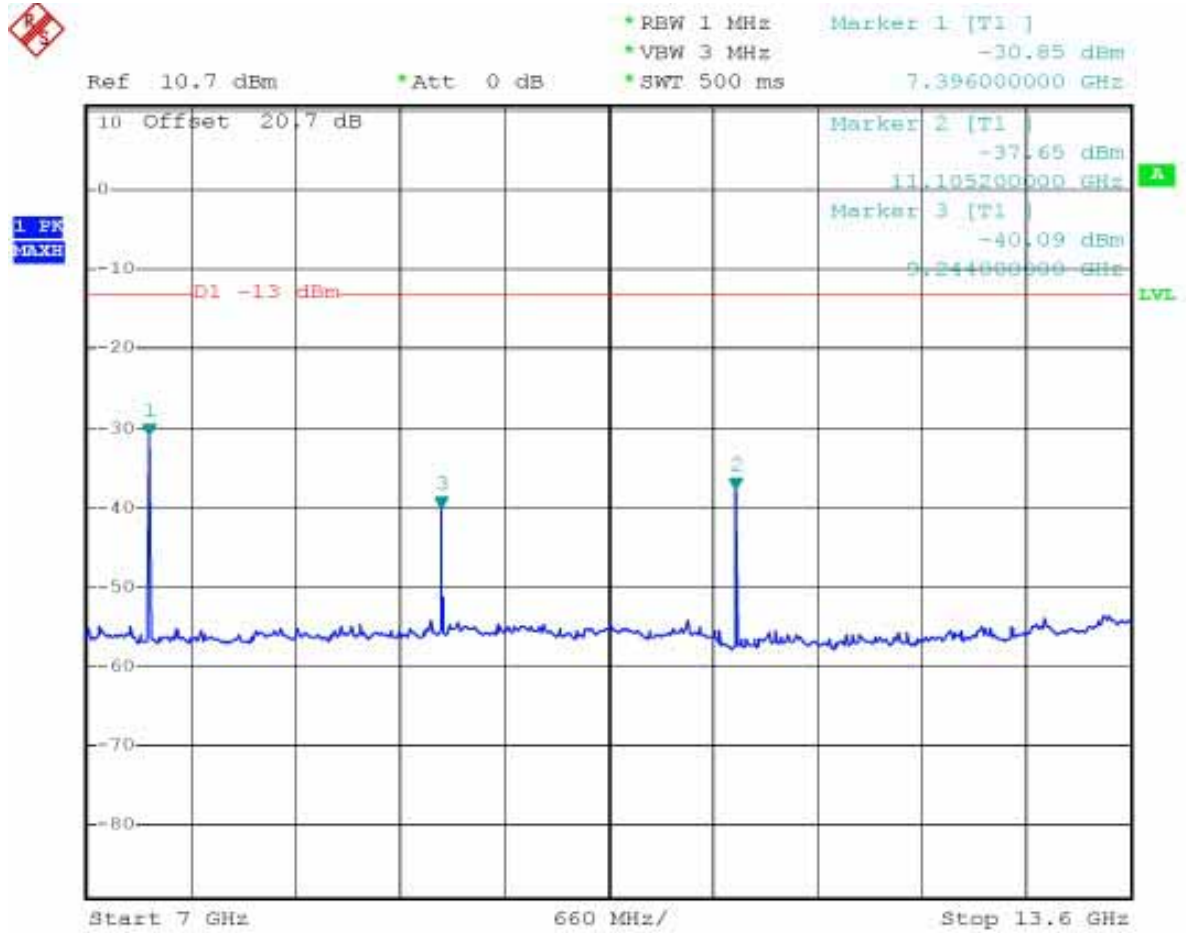



- Test Mode : PCS 1900 CH661
- Frequency Range : 13.6G-19.1G

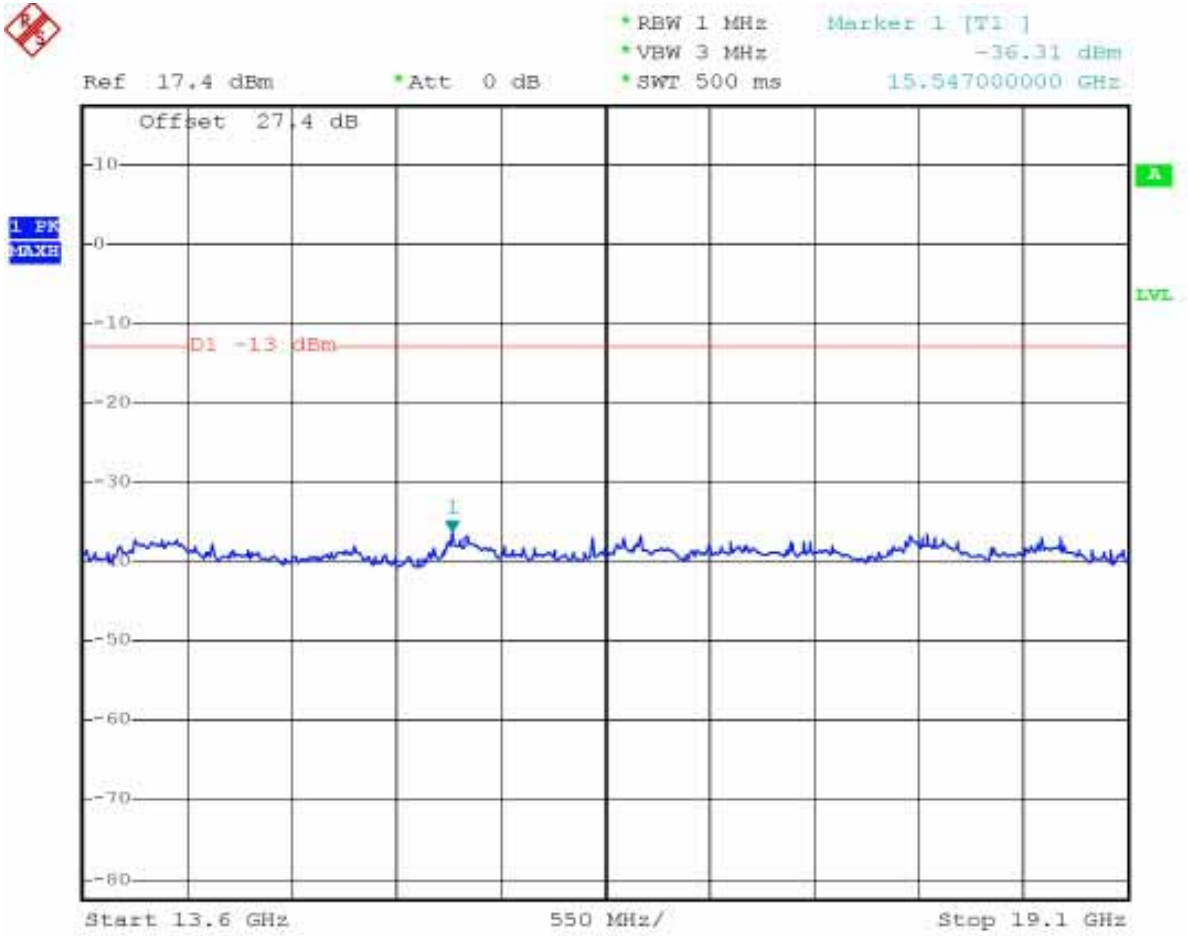



4.6 Field Strength of Spurious Radiation

Equivalent isotropic radiated Power Measurements by substitution method according to ANSI/TIA/EIA-603-A.

4.6.1 Measurement Instruments

As described in chapter 5 of this test report.

4.6.2 Test Procedure

1. The EUT was placed on a rotatable wooden table with 0.8 meter about ground.
2. The EUT was set 3 meters from the receiving antenna which was mounted on the antenna tower.
3. The table was rotated 360 degrees to determine the position of the highest spurious emission.
4. The height of the receiving antenna is varied between one meter and four meters to reach the maximum spurious emission for both horizontal and vertical polarizations.
5. Taking the record of maximum spurious emission.
6. A Horn antenna was substituted in place of the EUT and was driven by a signal generator.
7. Tune the output power of signal generator to the same emission level with EUT maximum spurious emission.
8. Taking the recored of output power at antenna port.
9. Repeat step 7 to step 8 for another polariztion.
10. Emission level (dBm) = output power + substituion Gain.

4.6.3 Test Setup Layout

As the setup in section 4.3.3.



4.6.4 Test Result

- Test Mode : GSM 850 CH 189

GSM850 Radiated Spurious ERP							
H Polarization				V Polarization			
Frequency (MHz)	ERP (dBm)	Limit (dBm)	Margin (dB)	Frequency (MHz)	ERP (dBm)	Limit (dBm)	Margin (dB)
58.890	-53.98	-13	-40.98	174.180	-57.57	-13	-44.57
390.300	-59.57	-13	-46.57	449.800	-57.55	-13	-44.55
1674.000	-47.3	-13	-34.3	1674.000	-49.34	-13	-36.34
2508.000	-54.77	-13	-41.77	2508.000	-54.49	-13	-41.49
4178.000	-50.22	-13	-37.22	3148.000	-46.51	-13	-33.51
5018.000	-40.4	-13	-27.4	5018.000	-43.47	-13	-30.47
5854.000	-47.89	-13	-34.89	5854.000	-47.21	-13	-34.21
6688.000	-43.17	-13	-30.17				



- Test Mode : PCS 1900 CH 661

PCS1900 Radiated Spurious EIRP							
H Polarization				V Polarization			
Frequency (MHz)	EIRP (dBm)	Limit (dBm)	Margin (dB)	Frequency (MHz)	EIRP (dBm)	Limit (dBm)	Margin (dB)
100.740	-61.510	-13	-48.51	57.540	-62.220	-13	-49.22
386.800	-76.510	-13	-63.51	386.800	-67.370	-13	-54.37
3758.000	-37.010	-13	-24.01	3758.000	-39.370	-13	-26.37
5638.000	-40.440	-13	-27.44	5638.000	-39.590	-13	-26.59
7518.000	-38.710	-13	-25.71	7518.000	-41.340	-13	-28.34
9398.000	-34.060	-13	-21.06	9398.000	-35.540	-13	-22.54
				11278.000	-37.400	-13	-24.40



4.6.5 Test Data

Test Mode: GSM 850 CH 189

Horizontal Polarization

	Freq	Level	Over Limit	Limit Line	ReadAntenna Level	Antenna Factor	Preamp Factor	Cable Loss	Remark	Ant Pos	Table Pos
	MHz	dBm	dB	dBm	dBm	dB	dB	dB		cm	deg
1 @	58.89	-51.83	-38.83	-13.00	-39.44	-12.40	0.00	0.00	Peak	---	---
	Freq	Level	Over Limit	Limit Line	ReadAntenna Level	Antenna Factor	Preamp Factor	Cable Loss	Remark	Ant Pos	Table Pos
	MHz	dBm	dB	dBm	dBm	dB	dB	dB		cm	deg
1 @	390.30	-57.42	-44.42	-13.00	-50.58	-6.83	0.00	0.00	Peak	---	---
2 @	836.90	-24.68			-23.34	-1.33	0.00	0.00	Peak	---	---
3 @	868.40	-36.49			-35.45	-1.03	0.00	0.00	Peak	---	---
4 @	880.30	-37.96			-37.04	-0.91	0.00	0.00	Peak	---	---

Remark: #2. MS TCH Signal
 #3. BS BCCH Signal
 #4. BS TCG Signal

	Freq	Level	Over Limit	Limit Line	ReadAntenna Level	Antenna Factor	Preamp Factor	Cable Loss	Remark	Ant Pos	Table Pos
	MHz	dBm	dB	dBm	dBm	dB	dB	dB		cm	deg
1 @	1674.00	-45.15	-32.15	-13.00	-44.41	-0.75	0.00	0.00	Peak	---	---
2 @	2508.00	-52.62	-39.62	-13.00	-54.64	2.02	0.00	0.00	Peak	---	---
	Freq	Level	Over Limit	Limit Line	ReadAntenna Level	Antenna Factor	Preamp Factor	Cable Loss	Remark	Ant Pos	Table Pos
	MHz	dBm	dB	dBm	dBm	dB	dB	dB		cm	deg
1 @	4178.00	-48.07	-35.07	-13.00	-59.49	11.42	0.00	0.00	Peak	---	---
	Freq	Level	Over Limit	Limit Line	ReadAntenna Level	Antenna Factor	Preamp Factor	Cable Loss	Remark	Ant Pos	Table Pos
	MHz	dBm	dB	dBm	dBm	dB	dB	dB		cm	deg
1 @	5018.00	-38.25	-25.25	-13.00	-50.67	12.42	0.00	0.00	Peak	---	---
2 @	5854.00	-45.74	-32.74	-13.00	-59.61	13.87	0.00	0.00	Peak	---	---
3 @	6688.00	-41.02	-28.02	-13.00	-57.89	16.87	0.00	0.00	Peak	---	---



Vertical Polarization

	Freq	Level	Over Limit	Limit Line	ReadAntenna Level	Preamp Factor	Cable Loss	Remark	Ant Pos	Table Pos
	MHz	dBm	dB	dBm	dBm	dB	dB		cm	deg
1 @	174.18	-55.42	-42.42	-13.00	-47.06	-8.36	0.00	0.00 Peak	---	---

	Freq	Level	Over Limit	Limit Line	ReadAntenna Level	Preamp Factor	Cable Loss	Remark	Ant Pos	Table Pos
	MHz	dBm	dB	dBm	dBm	dB	dB		cm	deg
1 @	449.80	-55.40	-42.40	-13.00	-51.68	-3.73	0.00	0.00 Peak	---	---
2 @	836.90	-20.04			-21.41	1.36	0.00	0.00 Peak	---	---
3 @	868.40	-25.42			-27.03	1.61	0.00	0.00 Peak	---	---
4 @	882.40	-25.90			-27.62	1.73	0.00	0.00 Peak	---	---

Remark: #2. MS TCH Signal
 #3. BS BCCH Signal
 #4. BS TCG Signal

	Freq	Level	Over Limit	Limit Line	ReadAntenna Level	Preamp Factor	Cable Loss	Remark	Ant Pos	Table Pos
	MHz	dBm	dB	dBm	dBm	dB	dB		cm	deg
1 @	1674.00	-47.19	-34.19	-13.00	-45.80	-1.38	0.00	0.00 Peak	---	---
2 @	2508.00	-52.34	-39.34	-13.00	-55.37	3.02	0.00	0.00 Peak	---	---

	Freq	Level	Over Limit	Limit Line	ReadAntenna Level	Preamp Factor	Cable Loss	Remark	Ant Pos	Table Pos
	MHz	dBm	dB	dBm	dBm	dB	dB		cm	deg
1 @	3148.00	-44.36	-31.36	-13.00	-49.16	4.80	0.00	0.00 Peak	---	---

	Freq	Level	Over Limit	Limit Line	ReadAntenna Level	Preamp Factor	Cable Loss	Remark	Ant Pos	Table Pos
	MHz	dBm	dB	dBm	dBm	dB	dB		cm	deg
1 @	5018.00	-41.32	-28.32	-13.00	-52.34	11.03	0.00	0.00 Peak	---	---
2 @	5854.00	-45.06	-32.06	-13.00	-57.51	12.45	0.00	0.00 Peak	---	---



Test Mode: PCS 1900 CH 661
Horizontal Polarization

	Freq	Level	Over Limit	Limit Line	ReadAntenna Level	Antenna Factor	Preamp Factor	Cable Loss	Remark	Ant Pos	Table Pos
	MHz	dBm	dB	dBm	dBm	dB	dB	dB		cm	deg
1	100.74	-61.51	-48.51	-13.00	-49.25	-12.25	0.00	0.00	Peak	---	---
1	386.80	-76.51	-63.51	-13.00	-69.58	-6.93	0.00	0.00	Peak	---	---
1	1878.00	-55.97			-55.62	-0.35	0.00	0.00	Peak	---	---
2	1958.00	-43.47			-43.25	-0.22	0.00	0.00	Peak	---	---

Remark: #1 MS TCH Signal
#2 BS TCH Signal

	Freq	Level	Over Limit	Limit Line	ReadAntenna Level	Antenna Factor	Preamp Factor	Cable Loss	Remark	Ant Pos	Table Pos
	MHz	dBm	dB	dBm	dBm	dB	dB	dB		cm	deg
1 @	3758.00	-37.01	-24.01	-13.00	-46.46	9.46	0.00	0.00	Peak	---	---
1	5638.00	-40.44	-27.44	-13.00	-54.01	13.56	0.00	0.00	Peak	---	---
1	7518.00	-38.71	-25.71	-13.00	-58.16	19.45	0.00	0.00	Peak	---	---
1 @	9398.00	-34.06	-21.06	-13.00	-54.58	20.52	0.00	0.00	Peak	---	---



Vertical Polarization

	Freq	Level	Over Limit	Limit Line	ReadAntenna Level	Antenna Factor	Preamp Factor	Cable Loss	Remark	Ant Pos	Table Pos
	MHz	dBm	dB	dBm	dBm	dB	dB	dB		cm	deg
1	57.54	-62.22	-49.22	-13.00	-48.38	-13.84	0.00	0.00	Peak	---	---
1	386.80	-67.37	-54.37	-13.00	-62.77	-4.60	0.00	0.00	Peak	---	---
1	1878.00	-57.26			-57.09	-0.17	0.00	0.00	Peak	---	---
2	1958.00	-40.00			-40.23	0.23	0.00	0.00	Peak	---	---
Remark: #1 MS TCH Signal											
#2 BS TCH Signal											
1	3758.00	-39.37	-26.37	-13.00	-47.54	8.17	0.00	0.00	Peak	---	---
1	5638.00	-39.59	-26.59	-13.00	-51.85	12.25	0.00	0.00	Peak	---	---
1	7518.00	-41.34	-28.34	-13.00	-58.34	17.00	0.00	0.00	Peak	---	---
1 @	9398.00	-35.54	-22.54	-13.00	-55.02	19.48	0.00	0.00	Peak	---	---
1 @	11278.00	-37.40	-24.40	-13.00	-58.17	20.77	0.00	0.00	Peak	---	---

4.7 Frequency Stability (Temperature Variation)

4.7.1 Measurement Instrument

As described in chapter 5 of this test report.

4.7.2 Test Procedure

1. The EUT and test equipment were set up as shown on the following section.
2. With all power removed, the temperature was decreased to -30°C and permitted to stabilize for three hours. Power was applied and the maximum change in frequency was noted within one minute.
3. With power OFF, the temperature was raised in 10°C steps. The sample was permitted to stabilize at each step for at least one-half hour. Power was applied and the maximum frequency change was noted within one minute.
4. The temperature tests were performed for the worst case.
5. Test data was recorded.

4.7.3 Test Setup Layout

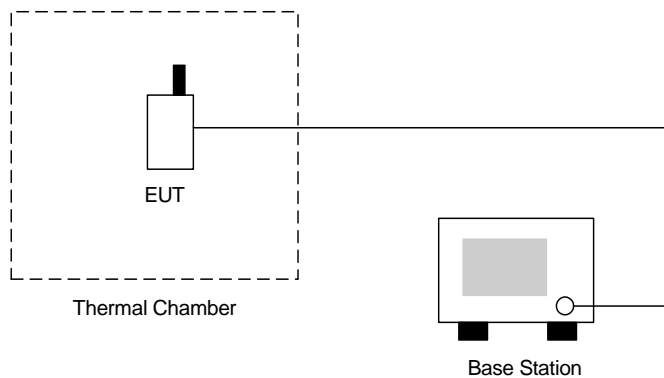

4.7.4 Test Result

- Test Mode : GSM 850 CH189

Temperature(°C)	Change (Hz)	Change (ppm)	Limit (ppm)	Result
-30	-34	-0.02	2.5	Passed
-20	-28	-0.01		
-10	28	0.01		
0	25	0.01		
10	34	0.02		
20	33	0.02		
30	30	0.02		
40	36	0.02		
50	38	0.02		



▪ Test Mode : PCS 1900 CH661

Temperature(°C)	Change (Hz)	Change (ppm)	Limit (ppm)	Result
-30	46	0.02	2.5	Passed
-20	43	0.02		
-10	37	0.02		
0	36	0.02		
10	35	0.02		
20	31	0.02		
30	29	0.02		
40	29	0.02		
50	30	0.02		

4.8 Frequency Stability (Voltage Variation)

4.8.1 Measurement Instrument

As described in chapter 5 of this test report.

4.8.2 Test Procedure

1. The EUT was placed in a temperature chamber at $25 \pm 5^\circ\text{C}$ and connected as the following section.
2. The power supply voltage to the EUT was varied from BEP to 115% of the nominal value measured at the input to the EUT.
3. The variation in frequency was measured for the worst case.

4.8.3 Test Setup Layout

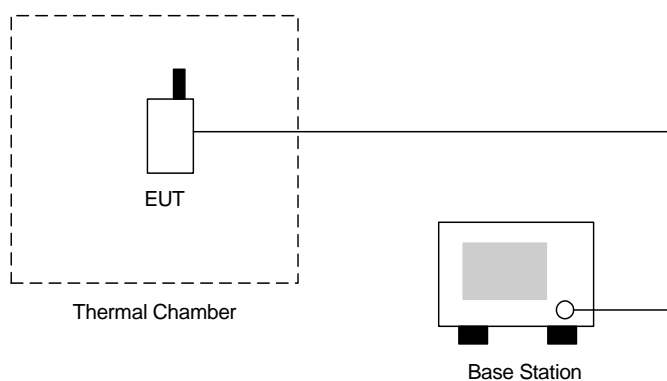

4.8.4 Test Result

- Test Mode : GSM 850 CH189

Voltage(Volt)	Change (Hz)	Change (ppm)	Limit (ppm)	Result
4.2	33	0.02	2.5	Passed
BEP	24	0.01		
4.8	38	0.02		

Remark:

1. Normal Voltage=4.2V
2. Battery End Point (BEP)=3.4V

- Test Mode : PCS 1900 CH661

Voltage(Volt)	Change (Hz)	Change (ppm)	Limit (ppm)	Result
4.2	31	0.02	2.5	Passed
BEP	28.5	0.02		
4.8	24	0.01		

Remark:

1. Normal Voltage=4.2V
2. Battery End Point (BEP)=3.4 V



5 List of Measurement Equipments

Instrument	Manufacturer	Model No.	Serial No.	Characteristics	Calibration Date	Due Date	Remark
Spectrum analyzer	Agilent	E4408B	MY44211030	9KHz-26.5GHz	Jul. 27, 2004	Jul. 26, 2005	Radiation (03CH06-HY)
Receiver	R&S	ESCS30	100356	9KHz-2.75GHz	Jul,09,2004	Jul, 10,2005	Radiation (03CH06-HY)
Controller	CT	SC100	N/A	N/A	N/A	N/A	Radiation (03CH06-HY)
Bilog Antenna	SCHAFFNER	CBL6112B	2885	30MHz -2GHz	Nov. 22, 2004	Nov. 21, 2005	Radiation (03CH06-HY)
Horn Antenna	Com-Power	AH118	071025	1G-18G	Feb. 11, 2004	Feb. 11, 2005	Radiation (03CH06-HY)
SHF-EHF Horn	SCHWARZBECK	BBHA 9170	9170-249	14G - 40G	Jun. 22, 2004	Jun. 22, 2005	Radiation (03CH06-HY)
PreAmplifier	Com-Power	PA-103	161055	1MHz - 1000MHz	Apr. 26, 2004	Apr. 26, 2005	Radiation (03CH06-HY)
HF Amplifier	MITEQ	AFS44	973248	0.1G - 26.5G	May. 20, 2004	May. 20, 2005	Radiation (03CH06-HY)
Amplifier	MITEQ	AMF-6F	997165	26G - 40G	Jun. 24, 2004	Jun. 24, 2005	Radiation (03CH06-HY)
Turn Table	HD	DS 420	420/650/00	0 ~ 360 degree	N/A	N/A	Radiation (03CH06-HY)
Antenna Mast	HD	MA 240	240/560/00	1 m - 4 m	N/A	N/A	Radiation (03CH06-HY)
Base Station Emulator	Agilent	E5515C	GB43460754	N/A	Jan. 12, 2004	Jan. 12, 2006	Base Station
Radio Communication	R&S	CMU200	105934	N/A	Aug. 24, 2004	Aug. 24, 2006	Base Station
Thermal Chamber	Ten Billion	TTH-D35P	N/A	N/A	NCR	NCR	EMS Chamber



6 Uncertainty Evaluation

Uncertainty of Conducted Emission Evaluation (30kHz ~ 1000MHz) (03CH03)

Contribution	Uncertainty of x_i		$u(x_i)$
	dB	Probability Distribution	
Receiver reading	0.41	Normal(k=2)	0.21
Antenna factor calibration	0.83	Normal(k=2)	0.42
Cable loss calibration	0.25	Normal(k=2)	0.13
Pre Amplifier Gain calibration	0.27	Normal(k=2)	0.14
RCV/SPA specification	2.50	Rectangular	0.72
Antenna Factor Interpolation for Frequency	1.00	Rectangular	0.29
Site imperfection	1.43	Rectangular	0.83
Mismatch Receiver VSWR $\Gamma_1 = 0.20$ Antenna VSWR $\Gamma_2 = 0.23$ Uncertainty = $20\log(1-\Gamma_1*\Gamma_2)$	+0.39/-0.41	U-shaped	0.28
combined standard uncertainty $U_c(y)$	1.27		
Measuring uncertainty for a level of confidence of 95% $U=2U_c(y)$	2.54		

Uncertainty of Radiated Emission Evaluation (1GHz ~ 40GHz) (03CH03)

Contribution	Uncertainty of x_i		$u(x_i)$	C_i	$C_i * u(x_i)$
	dB	Probability Distribution			
Receiver reading	±0.10	Normal(k=1)	0.10	1	0.10
Antenna factor calibration	±1.70	Normal(k=2)	0.85	1	0.85
Cable loss calibration	±0.50	Normal(k=2)	0.25	1	0.25
Receiver Correction	±2.00	Rectangular	1.15	1	1.15
Antenna Factor Directional	±1.50	Rectangular	0.87	1	0.87
Site imperfection	±2.80	Triangular	1.14	1	1.14
Mismatch Receiver VSWR $\Gamma_1 = 0.197$ Antenna VSWR $\Gamma_2 = 0.194$ Uncertainty = $20\log(1-\Gamma_1*\Gamma_2*\Gamma_3)$	+0.34/-0.35	U-shaped	0.244	1	0.244
Combined standard uncertainty $U_c(y)$	2.36				
Measuring uncertainty for a level of confidence of 95% $U=2U_c(y)$	4.72				

$$U = \{(1/2)^2 + (0.3/2)^2 + (2^2 + 0.5^2 + 2^2 + 0.25^2 + 2^2)/3 + (0.54)^2/2\} = 2.2 \text{ for 10m test distance}$$

$$U = \{(1/2)^2 + (0.3/2)^2 + (2^2 + 3^2 + 2^2 + 0.25^2 + 2^2)/3 + (0.54)^2/2\} = 2.7 \text{ for 3m test distance}$$

END OF TEST REPORT

SPORTON International Inc.

TEL : 886-2-2696-2468

FAX : 886-2-2696-2255

FCC ID : JVP57P50

Page No. : 41 of 41

Issued Date : Feb. 22, 2005

Rev. 02