

TEST REPORT FOR CERTIFICATION

On Behalf of

BENQ Corporation

Tri-Band Smartphone

Model : P30(57P30)

FCC ID : JVP57P30

Product Name : BenQ P30

Brand : BenQ

Ref No. NL-3515

Prepared for : BENQ Corporation
157, Shan-Ying Road, Gueishan,
Taoyuan 333, Taiwan, R.O.C.

Prepared by : Audix Corporation
No. 53-11, Tin-Fu Tsun, Lin-Kou,
Taipei Hsien, Taiwan, R.O.C.

Tel : (02) 2609-9301, 2609-2133
Fax: (02) 2609-9303

File Number : EM930167
Report Number : EM-F930069
Date of Test : Apr. 15 ~ 22, 2004
Date of Report : Apr. 22, 2004

TABLE OF CONTENTS

Description	Page
TEST REPORT FOR CERTIFICATION.....	3
1. GENERAL INFORMATION.....	5
1.1. Description of Device (EUT).....	5
1.2. Tested Supporting System Details	6
1.3. Description of Test Facility.....	8
1.4. Measurement Uncertainty	8
2. CONDUCTED EMISSION MEASUREMENT.....	9
2.1. Test Equipment	9
2.2. Block Diagram of Test Setup.....	9
2.3. Conducted Limits (§15.207, §15.107 Class B).....	10
2.4. Operating Condition of EUT.....	10
2.5. Test Procedure.....	10
2.6. Conducted Emission Measurement Results	11
3. RADIATED EMISSION MEASUREMENT	15
3.1. Test Equipment	15
3.2. Test Setup.....	15
3.3. Radiated Emission Limits (§15.209, §15.109 Class B)	16
3.4. Operating Condition of EUT.....	16
3.5. Test Procedure.....	17
3.6. Radiated Emission Measurement Results	18
4. CARRIER FREQUENCY SEPARATION MEASUREMENT	31
4.1. Test Equipment	31
4.2. Block Diagram of Test Setup.....	31
4.3. Specification Limits (§15.247(a)(1)).....	31
4.4. Test Procedure.....	31
4.5. Test Results	31
5. 20dB BANDWIDTH MEASUREMENT	33
5.1. Test Equipment	33
5.2. Block Diagram of Test Setup.....	33
5.3. Specification Limits (§15.247(a)(1)).....	33
5.4. Test Procedure.....	33
5.5. Test Results	33
6. TIME OF OCCUPANCY	36
6.1. Test Equipment	36
6.2. Block Diagram of Test Setup.....	36
6.3. Specification Limits (§15.247(a)(1)(iii)).....	36
6.4. Test Procedure.....	36
6.5. Test Results	37
7. NUMBER OF HOPPING CHAMMELS	40
7.1. Test Equipment	40
7.2. Block Diagram of Test Setup.....	40
7.3. Specification Limits (§15.247(a)(1)(iii)).....	40
7.4. Test Procedure.....	40
7.5. Test Results	40
8. MAXIMUM PEAK OUTPUT POWER MEASUREMENT	42
8.1. Test Equipment	42
8.2. Block Diagram of Test Setup.....	42
8.3. Specification Limits (§15.247(b)-(1)).....	42
8.4. Test Procedure.....	42
8.5. Test Results	42

- 9. EMISSION LIMITATIONS MEASUREMENT 45**
 - 9.1. Test Equipment45
 - 9.2. Block Diagram of Test Setup.....45
 - 9.3. Specification Limits (§15.247(c))45
 - 9.4. Test Procedure.....45
 - 9.5. Test Results46
- 10. BAND EDGES MEASUREMENT 49**
 - 10.1. Test Equipment49
 - 10.2. Block Diagram of Test Setup.....49
 - 10.3. Specification Limits (§15.247(c))49
 - 10.4. Test Procedure.....49
 - 10.5. Test Results49
- 11. POWER SPECTRAL DENSITY MEASUREMENT 51**
 - 11.1. Test Equipment51
 - 11.2. Block Diagram of Test Setup.....51
 - 11.3. Specification Limits (§15.247(d)).....51
 - 11.4. Test Procedure.....51
 - 11.5. Test Results51
- 12. DEVIATION TO TEST SPECIFICATIONS..... 54**
- 13. PHOTOGRAPHS..... 55**
 - 13.1. Photos of Conducted Emission Measurement.....55
 - 13.2. Photos of Radiated Measurement at Semi-Anechoic Chamber56
 - 13.3. Photos of Measurement for Section 4 ~ 1159

TEST REPORT FOR CERTIFICATION

Applicant : BENQ Corporation
 Manufacturer #1 : BENQ Corporation
 Manufacturer #2 : BENQ China Co., Ltd.
 Manufacturer #3 : BENQ Optronics (Suzhou) Co., Ltd.
 Manufacturer #4 : BENQ Electronics (Suzhou) Co., Ltd.
 EUT Description : Tri-Band Smartphone (Bluetooth Band)
 FCC ID : JVP57P30
 (1) Model Number : P30(57P30)
 (2) Product Name : BenQ P30
 (3) Brand : BenQ
 (4) Ref. No. : NL-3515
 (5) Power Supply : DC 3.8V
 (6) Test Voltage : AC 120V/60z Via AC/DC Adapter

Measurement Procedure Used:

FCC RULES AND REGULATIONS PART 15 SUBPART B & C, DEC. 2003
 AND FCC / ANSI C63.4-2001
 (Transmitter Unit with FCC CFR 47 Part 15C, §15.205, §15.207, §15.209 and §15.247)
 (Receiver Unit with FCC CFR 47 Part 15B, §15.107, §15.109)

The device described above was tested by Audix Corporation to determine the maximum emission levels emanating from the device. The maximum emission levels were compared to the FCC Part 15 subpart C & B limits both radiated and conducted emissions, and FCC Part 15 subpart C requirements.

The measurement results are contained in this test report and Audix Corporation is assumed full responsibility for the accuracy and completeness of these measurements. Also, this report shows that the EUT to be technically compliant with the FCC official limits and requirement.

This report applies to above tested sample only. This report shall not be reproduced in part without written approval of Audix Corporation.

Date of Test : Apr. 15 ~ 22, 2004

Prepared by : Cherry Wang Apr. 22, 2004
 (Cherry Wang/Assistant Manager)

Test Engineer : Ben Cheng Apr. 22, 2004
 (Ben Cheng/Assistant Manager)

Approve & Authorized Signer : Leon Liu Apr. 22 2004
 (Leon Liu/Assistant General Manager)

1. GENERAL INFORMATION

1.1. Description of Device (EUT)

Description	:	Tri-Band Smartphone (Bluetooth Band)
FCC ID	:	JVP57P30
Product Name	:	BenQ P30
Model Number	:	P30(57P30)
Brand	:	BenQ
Ref. No.	:	NL-3515
Applicant	:	BENQ Corporation 157, Shan-Ying Road, Gueishan, Taoyuan 333, Taiwan, R.O.C.
Manufacturer #1	:	BENQ Corporation 157, Shan-Ying Road, Gueishan, Taoyuan 333, Taiwan.
Manufacturer #2	:	BENQ China Co., Ltd.
Manufacturer #3	:	BENQ Optronics (Suzhou) Co. Ltd.
Manufacturer #4	:	BENQ Electronics (Suzhou) Co. Ltd. No. 169, Zhujiang Road, New District, Suzhou, Jiangsu, P.R., China
Radio Technology	:	FHSS Modulation
Fundamental Range	:	2400MHz ~ 2483.5MHz
Channel Number	:	79
Antenna Gain	:	2.5dBi
Battery Pack	:	BenQ, P/N 60.G4703.001 DC 3.8V, 1050mAh
Handsfree Fixture (Earphone/Microphone)	:	BenQ, Cable: Non-Shielded, Detached, 1.5m

AC/DC Adapter (2-Pin) : BenQ, M/N MP20
 Input: 100-240V~, 50-60Hz, 0.3A
 Output: 3-9VDC, 1-0.5A, 5W
 6.0V, 500mA
 Cord: Non-Shielded, Undetachable, 1.8m

USB Cable : Shielded, Detached, 1.6m

Date of Receipt of Sample : Apr. 14, 2004

Date of Test : Apr. 15 ~ 22, 2004

Remark:

- (1) The EUT is Tri-Band Smartphone with Bluetooth Band, which is transmitter and receiver in the same device.
- (2) The EUT's I/O ports include a DC power jack, a phone jack and a USB port.
- (3) Antenna requirement: The bluetooth antenna of EUT is an integral part of the transmitter, no gain and inform to user that any change and modify is prohibited, complied with §15.203.

1.2. Tested Supporting System Details

【FOR CONDUCTED · RADIATED EMISSION MEASUREMENT】

1.2.1. UNIVERSAL RADIO COMMUNICATION TESTER

Model Number : CMU200
 Serial Number : 102280
 Manufacturer : Rhode & Schwartz
 Power Cord : Non-Shielded, Detachable, 1.8m
 Calibrated Date : Nov. 07, 2003

1.2.2. HORN ANTENNA

Model Number : 3115
 Serial Number : 9112-3775
 Manufacturer : EMCO
 Data Cable : Shielded, Detachable, 2.0m
 Calibrated Date : Apr. 21, 2003

1.2.3. NOTEBOOK PC

Model Number : PP2130
 Serial Number : 5Y32KSQZ40ME
 FCC ID : By DoC
 BSMI ID Number : 3912A556
 Brand : Compaq Computer Corporation
 Manufacturer : LG Electronics Ltd.
 AC Adapter : Compaq, M/N PPP009L
 (LITE-ON, M/N PA-1650-02C)
 Non-Shielded, Undetachable, 1.8m,
 Power Cord : Non-Shielded, Detachable, 1.8m

1.2.4. 15" LCD MONITOR

Model Number : D5063
 Serial Number : CN206A6568
 FCC ID : By DoC
 BSMI ID : R33037
 Manufacturer : Top Victory Electronics (Fujian) Co., Ltd.
 Data Cable (D-Sub) : Shielded, Detachable, 1.8m
 Bonded two ferrite cores
 Audio Cable(*2EA) : Non-Shielded, Detachable, 1.2m
 AC Adapter : Delta, M/N ADP-40TB
 BSMI ID 3892D142
 Cord: Shielded, Undetachable, 1.8m
 Bonded a ferrite core
 Power Cord : Non-Shielded, Detachable, 1.8m

1.2.5. DOT MATRIX PRINTER

Model Number : KX-P2135
 Serial Number : 8DMCN02139
 FCC ID : ACJ5Z6KX-P2135
 BSMI ID : 3872A371
 Manufacturer : Matsushita (Brand: Panasonic)
 Data Cable : Shielded, Detachable, 1.5m
 Power Cord : Non-Shielded, Detachable, 1.8m

1.3. Description of Test Facility

Name of Firm : Audix Corporation
 Technical Division EMC Department

Location : No. 53-11, Tin-Fu Tsun, Lin-Kou Hsiang,
 Taipei Hsien 24443, Taiwan, R.O.C.

Test Facility : **No. 2 Shielding Room**
 No. 53-11, Tin-Fu Tsun, Lin-Kou,
 Taipei Hsien, Taiwan, R.O.C.

Semi-Anechoic Chamber
 No. 67-4, Tin-Fu Tsun, Lin-Kou,
 Taipei Hsien, Taiwan, R.O.C.

May 16, 2003 Re-File on
 Federal Communication Commission
 Registration Number: 90993

NVLAP Lab. Code : 200077-0
 (NVLAP is a NATA accredited body under Mutual Recognition Agreement)

DAR-Registration No. : DAT-P-145/03-01

1.4. Measurement Uncertainty

Test Item	Frequency Range	Uncertainty (dB)
Conduction Test	150kHz~30MHz	±2.66dB
Radiation Test (Distance: 3m)	30MHz~300MHz	+4.26dB / -4.22dB
	300MHz~1000MHz	+5.28dB / -4.0dB

Remark : Uncertainty = $ku_c(y)$

2. CONDUCTED EMISSION MEASUREMENT

2.1. Test Equipment

The following test equipment are used during the power line conducted tests :

Item	Type	Manufacturer	Model No.	Serial No.	Last Cal.	Next Cal.
1.	Test Receiver	R & S	ESH3	893044/015	Jul. 05, 03'	Jul. 04, 04'
2.	L.I.S.N. # 1	Kyoritsu	KNW-407	8-1539-2	Nov.15, 03'	Nov.14, 04'
3.	L.I.S.N. #2	Kyoritsu	KNW-407	8-1539-3	Nov.15, 03'	Nov.14, 04'
4.	Pulse Limiter	R & S	ESH3-Z2	003	Jun. 18, 03'	Jun. 17, 04'

2.2. Block Diagram of Test Setup

2.2.1. Test Mode: Transmitting & Receiving Modes, Bluetooth Band

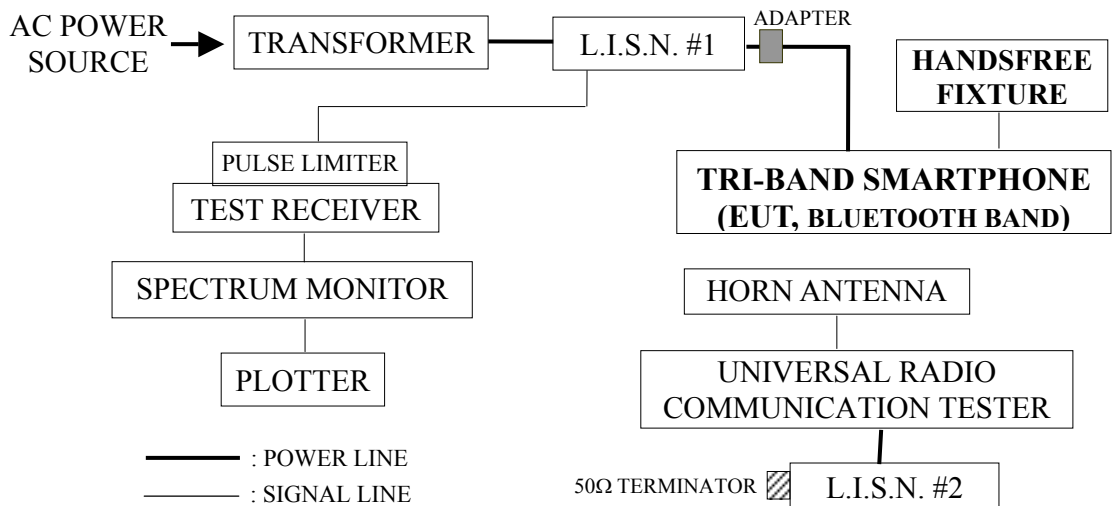

2.2.2. Test Mode: USB Link to PC, Upload & Download

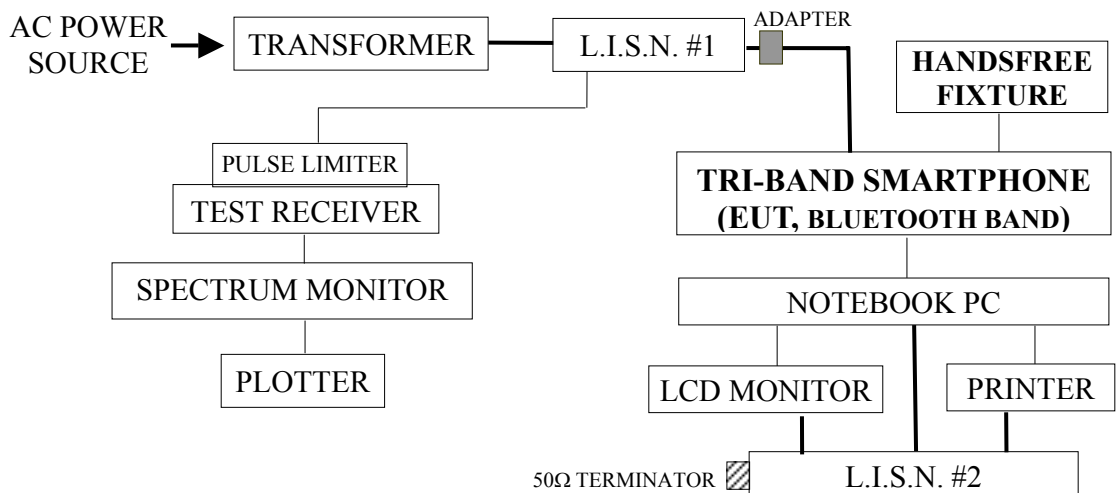

2.3. Conducted Limits (§15.207, §15.107 Class B)

Frequency	Maximum RF Line Voltage (dBµV)	
	Quasi-Peak Level	Average Level
150kHz ~ 500kHz	66 ~ 56 dBµV*	56 ~ 46 dBµV*
500kHz ~ 5MHz	56 dBµV	46 dBµV
5MHz ~ 30MHz	60 dBµV	50 dBµV

- Remark:
1. * Decreases with the logarithm of the frequency.
 2. If the average limit is met when using a Quasi-Peak detector, the EUT shall be deemed to meet both limits and measurement with the average detector is unnecessary.

2.4. Operating Condition of EUT

- 2.4.1. Setup the EUT and simulator as shown on 2.2.
- 2.4.2. Turned on the power of all equipment.
- 2.4.3. Transmitting & Receiving Mode: The EUT transmitted data to the Universal Radio Communication Tester and received data from Radio Communication Tester through Bluetooth Band during all testing. (EUT’s battery was charging status during the testing).
- 2.4.4. USB Link PC Mode: The EUT upload & download data to the Notebook PC via USB port during all testing.

2.5. Test Procedure

The EUT was put on table which was above the ground by 80cm and its AC/DC Adapter connected to the power mains through a line impedance stabilization network (L.I.S.N. #1) and the other peripheral devices power cord were connected to the power mains through a line impedance stabilization network (L.I.S.N. #2) This provided a 50 ohm coupling impedance for the measuring equipment. (Please refer to the block diagram of the test setup and photographs.)

Both sides of A.C. line were checked for maximum conducted interference. In order to find the maximum emission, the relative positions of equipment and all of the interface cables were changed according to FCC ANSI C63.4-2001 on conducted measurement.

The bandwidth of R&S Test Receiver ESH3 was set at 10kHz.

The frequency range from 150kHz to 30MHz was checked.

EUT with following test modes and with 120V/60Hz (via AC/DC Adapter) supplying voltage were performed during conducted measurement, all the test results are attached in section 2.6.

Mode	Operation Mode	Type of Network	Frequency
1.	Transmitting & Receiving	Bluetooth (FHSS)	Channel 78: 2480MHz
2.	USB Link to PC (Upload & Download)	None	None

2.6. Conducted Emission Measurement Results

PASSED. All emissions not reported below are too low against the prescribed limits.

Date of Test : Apr. 21, 2004 Temperature : 24°C

EUT : Tri-Band Smartphone Humidity : 65%

Test Mode : Transmitting & Receiving Mode
Bluetooth Band, Channel 78: 2480MHz

Frequency (MHz)	Factor dB	Reading (dBμV)		Measurement (dBμV)		Limits (dBμV)		Margin dB	
		Phase Line (VA)							
		Q.P.	Average	Q.P.	Average	Q.P.	Average	Q.P.	Average
0.1789	0.4	43.0	*	43.4	*	64.5	54.5	21.1	*
0.2655	0.4	34.6	*	35.0	*	61.2	51.2	26.2	*
0.7890	0.5	28.4	*	28.9	*	56.0	46.0	27.1	*
1.5619	0.5	39.0	*	39.5	*	56.0	46.0	16.5	*
2.7810	0.5	34.8	*	35.3	*	56.0	46.0	20.7	*
3.8444	0.5	37.2	*	37.7	*	56.0	46.0	18.3	*

Frequency (MHz)	Factor dB	Reading (dBμV)		Measurement (dBμV)		Limits (dBμV)		Margin dB	
		Phase Neutral (VB)							
		Q.P.	Average	Q.P.	Average	Q.P.	Average	Q.P.	Average
0.1800	0.4	42.8	*	43.2	*	64.4	54.4	21.2	*
0.3480	0.4	25.4	*	25.8	*	59.0	49.0	33.2	*
1.2861	0.5	32.6	*	33.1	*	56.0	46.0	22.9	*
1.7263	0.5	38.8	*	39.3	*	56.0	46.0	16.7	*
2.4289	0.5	37.4	*	37.9	*	56.0	46.0	18.1	*
3.5822	0.5	34.6	*	35.1	*	56.0	46.0	20.9	*

- Remark :
1. All readings are Quasi-Peak and Average values.
 2. Measurement = Factor (Insertion Loss + Cable Loss) + Reading.
 3. Margin = Limits – Measurement.
 4. The “*” means above Q.P. values have met both limits, they are not necessary to measure with average detector.
 5. The worst emission was detected at 1.5619MHz with corrected signal level of 39.5dBμV (limit is 56.0dBμV) when the VA side of the EUT’s power was connected to L.I.S.N.

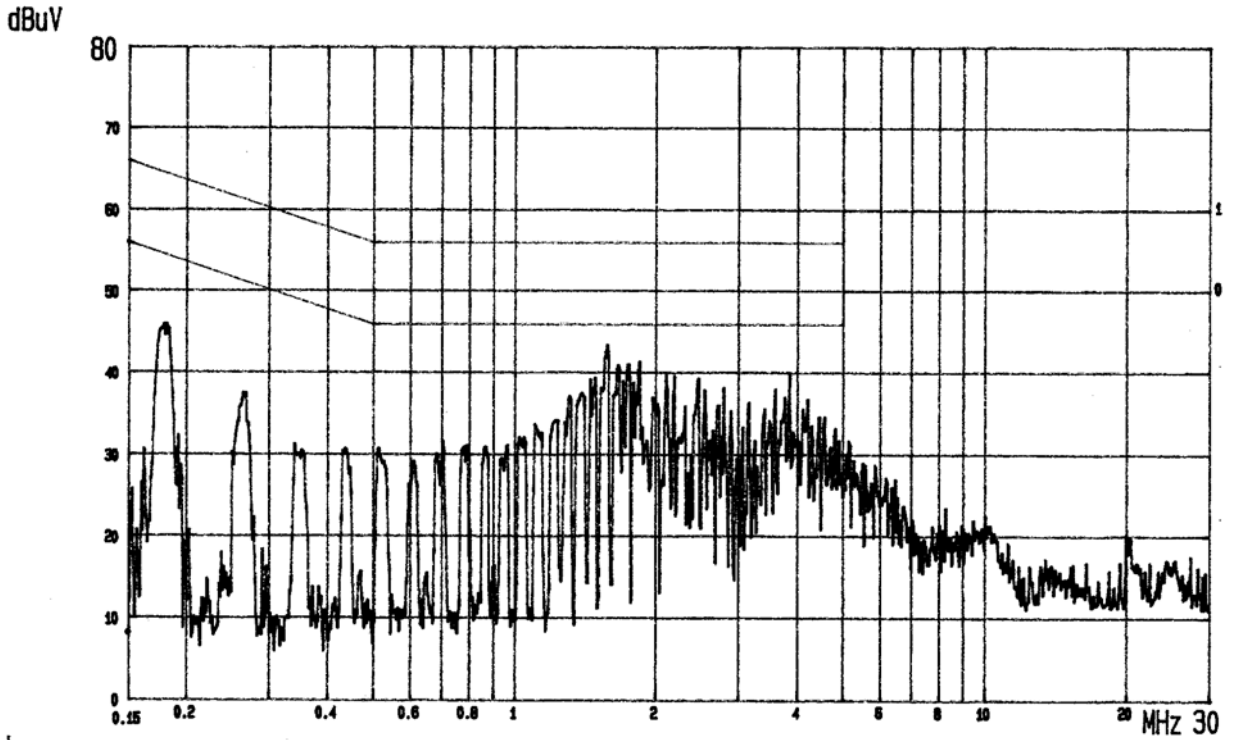

LINE: L1

EUT: TRI-BAND SMARTPHONE
MEMO: BLUETOOTH

M/N: P30

120V/60Hz PAGE: 01
(PEAK VALUE) AUDIX

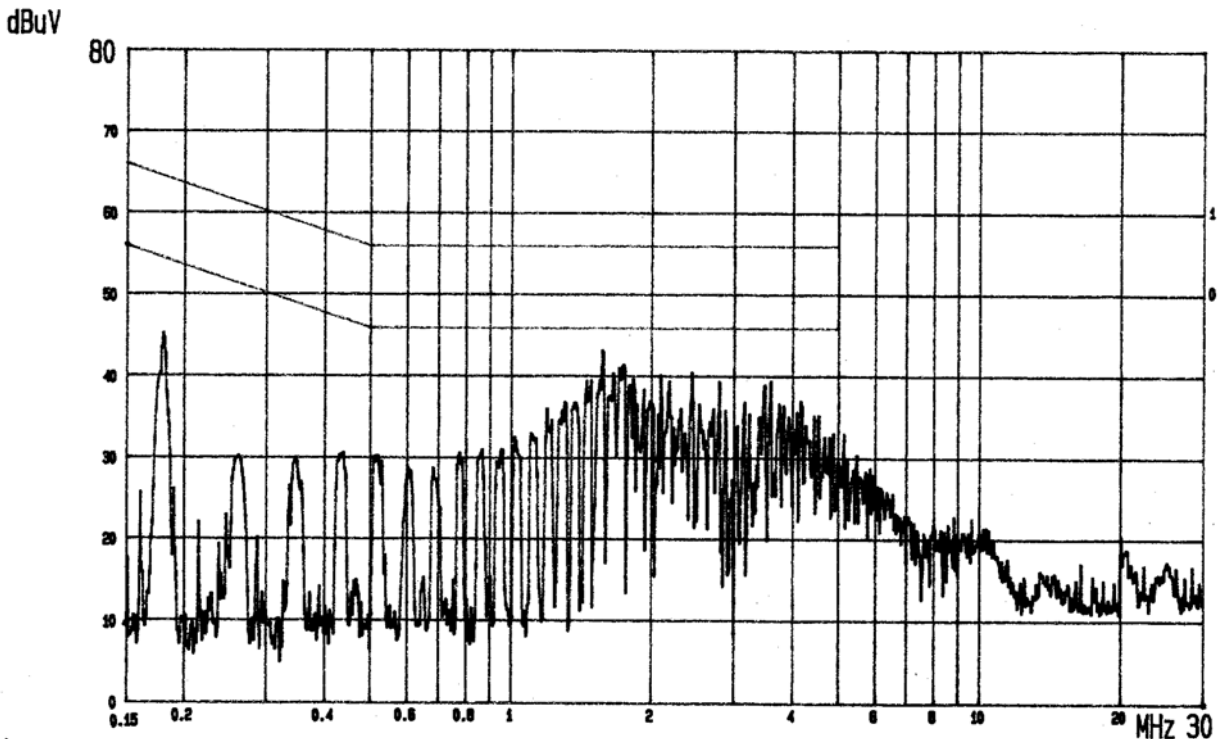

LINE: N

EUT: TRI-BAND SMARTPHONE
MEMO: BLUETOOTH

M/N: P30

120V/60Hz PAGE: 02
(PEAK VALUE) AUDIX

Date of Test : Apr. 22, 2004 Temperature : 24°C
 EUT : Tri-Band Smartphone Humidity : 61%
 Test Mode : USB Link to PC, Upload & Download

Frequency (MHz)	Factor dB	Reading (dBμV)		Measurement (dBμV)		Limits (dBμV)		Margin dB	
		Phase Line (VA)							
		Q.P.	Average	Q.P.	Average	Q.P.	Average	Q.P.	Average
0.1779	0.4	40.3	*	40.7	*	64.6	54.3	23.9	*
1.4726	0.5	40.2	*	40.7	*	56.0	46.0	15.3	*
1.5619	0.5	41.8	*	42.3	*	56.0	46.0	13.7	*
2.4289	0.5	36.9	*	37.4	*	56.0	46.0	18.6	*
3.7329	0.5	39.2	*	39.7	*	56.0	46.0	16.3	*
20.5821	1.1	27.0	*	28.1	*	60.0	50.0	31.9	*

Frequency (MHz)	Factor dB	Reading (dBμV)		Measurement (dBμV)		Limits (dBμV)		Margin dB	
		Phase Neutral (VB)							
		Q.P.	Average	Q.P.	Average	Q.P.	Average	Q.P.	Average
0.1768	0.4	42.6	*	43.0	*	64.4	54.4	21.4	*
1.1984	0.5	40.2	*	40.7	*	56.0	46.0	15.3	*
1.4553	0.5	43.4	*	43.9	*	56.0	46.0	12.1	*
1.6180	0.5	46.7	37.5	47.2	38.0	56.0	46.0	8.8	18.0
3.5822	0.5	40.4	*	40.9	*	56.0	46.0	15.1	*
20.1032	1.1	26.0	*	27.1	*	60.0	50.0	32.9	*

- Remark :
1. All readings are Quasi-Peak and Average values.
 2. Measurement = Factor (Insertion Loss + Cable Loss) + Reading.
 3. Margin = Limits – Measurement.
 4. The “*” means above Q.P. values have met both limits, they are not necessary to measure with average detector.
 5. The worst emission was detected at 1.6180MHz with corrected signal level of 47.20dBμV (limit is 56.0dBμV) when the VB side of the EUT’s power was connected to L.I.S.N.

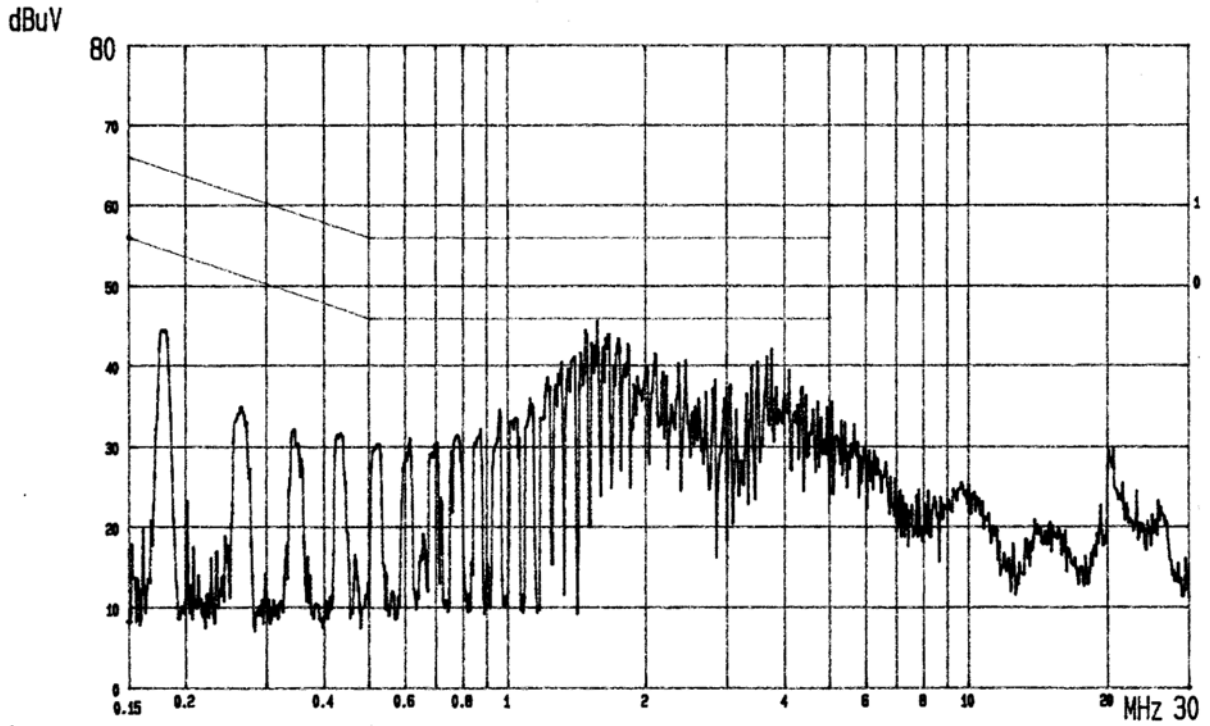

BENG
LINE: L1

EUT: TRI-BAND SMARTPHONE
MEMO: LINK PC

M/N: P30

120V/60Hz PAGE: 01
(PEAK VALUE) AUDIX

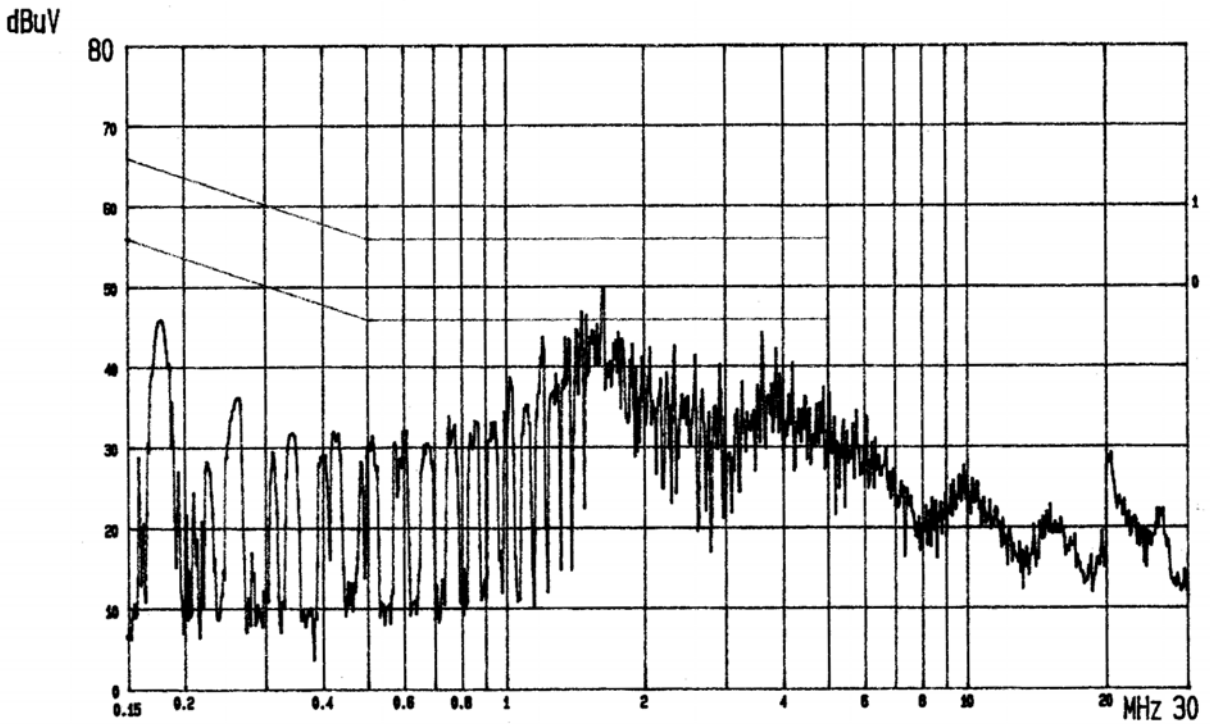

BENG
LINE: N

EUT: TRI-BAND SMARTPHONE
MEMO: LINK PC

M/N: P30

120V/60Hz PAGE: 02
(PEAK VALUE) AUDIX

3. RADIATED EMISSION MEASUREMENT

3.1. Test Equipment

The following test equipment are used during the radiated emission tests :

3.1.1. 30MHz~1000MHz Frequency

Item	Type	Manufacturer	Model No.	Serial No.	Last Cal.	Next Cal.
1.	Spectrum Analyzer	HP	8593EM	3826A00248	Sep.24, 03'	Sep.23, 04'
2.	Test Receiver	R & S	ESVP	879691/036	Jul.16, 03'	Jul.15, 04'
3.	Pre-Amplifier	HP	8447D	2944A06305	Mar.18, 04'	Mar.17, 05'
1	Broadband Antenna	Schwarzbeck	BBA 9106	A3L	Feb.21, 04'	Feb.20, 05'
4.	Broadband Antenna	Schwarzbeck	UHALP9108-A	0138	Feb.21, 04'	Feb.20, 05'

3.1.2. Above 1GHz frequency

Item	Type	Manufacturer	Model No.	Serial No.	Last Cal.	Next Cal.
1.	Spectrum Analyzer	HP	8593EM	3826A00248	Sep.24, 03'	Sep.23, 04'
2.	Amplifier (1GHz ~26.5GHz)	HP	8449B	3008A00529	Jan. 29, 04'	Jan. 28, 05'
3.	Horn Antenna (1GHz ~ 18GHz)	EMCO	3115	9609-4927	Jul. 04, 03'	Jul. 03, 04'
4.	High Pass Filter	HP	84300-80038	005	Dec.04, 03'	Dec.03, 04'

3.2. Test Setup

3.2.1. Block Diagram of connection between EUT and simulators

3.2.1.1. Test Mode: Transmitting & Receiving Modes, Bluetooth Band

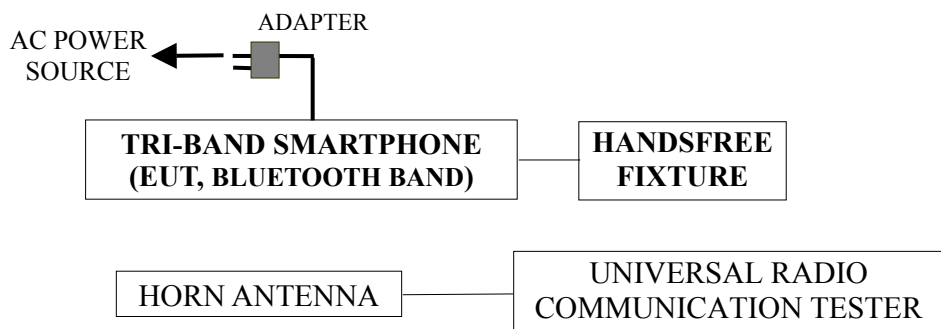

3.2.1.2. Test Mode: USB Link to PC, Upload & Download

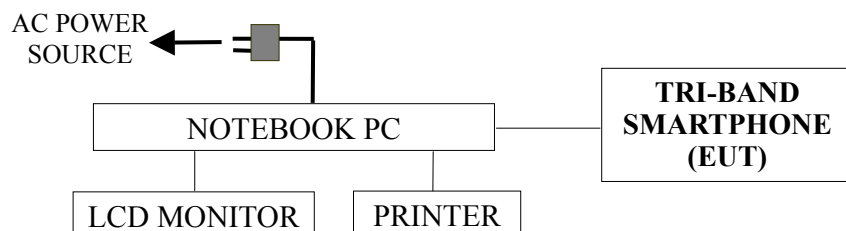

3.2.2. Semi-Anechoic Chamber (3m) Setup Diagram

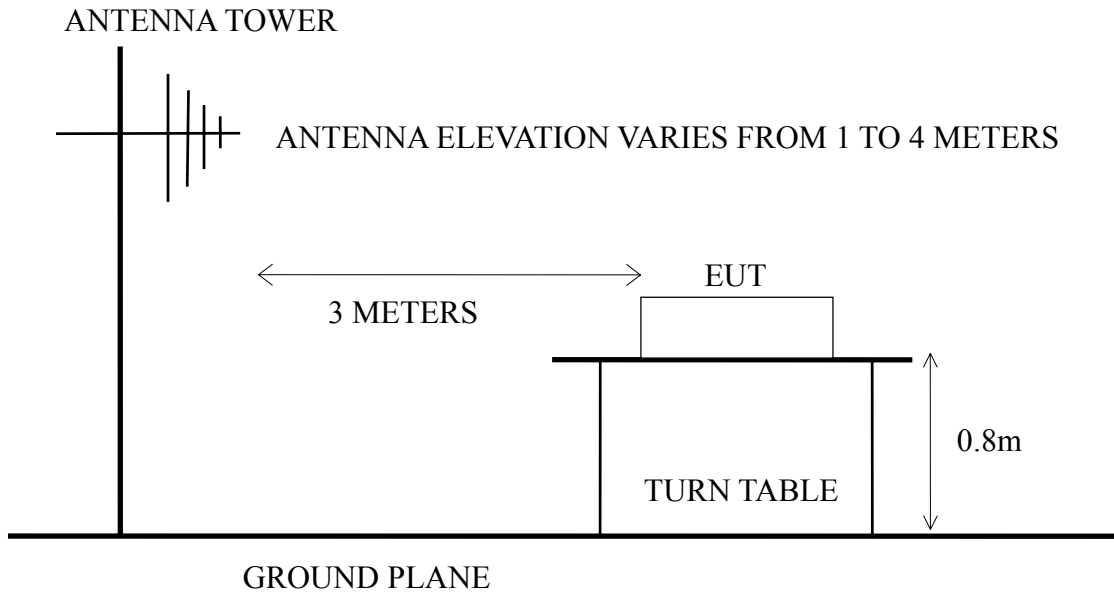

3.3. Radiated Emission Limits (§15.209, §15.109 Class B)

FREQUENCY MHz	DISTANCE Meters	FIELD STRENGTHS LIMITS	
		$\mu\text{V/m}$	$\text{dB}\mu\text{V/m}$
30 ~ 88	3	100	40.0
88 ~ 216	3	150	43.5
216 ~ 960	3	200	46.0
Above 960	3	500	54.0
Above 1000 ^{*(5)}	3	74.0 $\text{dB}\mu\text{V/m}$ (Peak) 54.0 $\text{dB}\mu\text{V/m}$ (Average)	

- Remark :
- (1) Emission level ($\text{dB}\mu\text{V/m}$) = $20 \log$ Emission level ($\mu\text{V/m}$)
 - (2) The tighter limit applies at the edge between two frequency bands.
 - (3) Distance refers to the distance in meters between the measuring instrument antenna and the closed point of any part of the device or system.
 - (4) The limits in this table are based on CFR 47 Part 15.205(a)(b) and Part 15.209 (a).
 - (5) The over 1GHz limit, FCC limit is used based on CFR 47 Part 15.35 (b) and Part 15.205(b) & Part 15.209(e) and Part 15.207(c).

3.4. Operating Condition of EUT

The configuration of EUT and its simulators were the same as those used in conducted measurement. Please refer to 2.4.

3.5. Test Procedure

The EUT and its simulators were placed on a turn table which was 0.8 meter above the ground. The turn table rotated 360 degrees to determine the position of the maximum emission level. EUT was set 3 meters away from the receiving antenna which was mounted on a antenna tower. The antenna moved up and down between 1 to 4 meters to find out the maximum emission level. Broadband antenna such as calibrated biconical and log- periodical antenna or horn antenna were used as a receiving antenna. Both horizontal and vertical polarization of the antenna were set on measurement. In order to find the maximum emission, all of the interface cables were manipulated according to FCC ANSI C63.4-2001 regulation.

The bandwidth of the R&S Test Receiver ESVP was set at 120kHz.
 The bandwidth of the HP Spectrum Analyzer 8593EM was set at 1MHz.

The frequency range from 30MHz to 18GHz was checked.

The EUT with test voltage of AC 120V/60Hz and with following test mode were done during 30MHz~1000MHz frequency range and all the test results are listed in section 3.6.1. The above 1GHz frequency range test results are listed in section 3.6.2.

Mode	Operation Mode	Type of Network	Frequency
1.	Transmitting	Bluetooth (FHSS)	Channel 0: 2402MHz
2.			Channel 39: 2441MHz
3.			Channel 78: 2480MHz
4.	Receiving	Bluetooth (FHSS)	Channel 78: 2480MHz
5.	USB Link to PC (Upload & Download)	None	None

The EUT with following test mode were done during restricted bands and all the test results are listed in section 3.6.3. (The restricted bands defined in part 15.205(a))

Mode	Operation Mode	Type of Network	Frequency
1.	Transmitting	Bluetooth (FHSS)	Channel 0: 2402MHz
2.			Channel 78:2480MHz

3.6. Radiated Emission Measurement Results

PASSED. All the emissions not reported below are too low against the official limits.

3.6.1. 30MHz to 1000MHz Frequency Range Measurement Results

Date of Test : Apr. 16, 2004 Temperature : 21°C
 EUT : Tri-Band Smartphone Humidity : 48%
 Test Mode : Transmitting Mode, Bluetooth Band, Channel 0: 2402MHz

Emission Frequency MHz	Antenna Factor dB/m	Cable Loss dB	Reading Horizontal dBμV	Emission Level Horizontal dBμV/m	Limits dBμV/m	Margin dB
61.040	13.60	1.60	5.49	20.69	40.00	19.31
94.990	15.91	2.00	3.59	21.50	43.50	22.00
211.390	22.45	3.20	2.34	27.99	43.50	15.51
401.510	16.84	4.80	6.98	28.62	46.00	17.38
501.420	18.30	6.52	1.78	26.60	46.00	19.40
536.340	18.70	7.07	0.64	26.41	46.00	19.59
624.610	19.70	6.20	1.03	26.93	46.00	19.07
700.270	21.10	6.50	3.25	30.85	46.00	15.15
823.460	22.30	7.00	1.20	30.50	46.00	15.50
935.980	22.83	7.50	1.19	31.52	46.00	14.48

Emission Frequency MHz	Antenna Factor dB/m	Cable Loss dB	Reading Vertical dBμV	Emission Level Vertical dBμV/m	Limits dBμV/m	Margin dB
37.760	20.64	1.20	2.66	24.50	40.00	15.50
60.070	14.86	1.60	5.59	22.06	40.00	17.95
209.450	22.96	3.16	1.86	27.98	43.50	15.52
400.540	16.45	4.80	4.94	26.19	46.00	19.81
481.050	17.40	6.10	0.91	24.41	46.00	21.59
546.040	18.60	7.00	1.75	27.35	46.00	18.65
700.270	20.95	6.50	4.29	31.73	46.00	14.27
730.340	21.26	6.60	2.88	30.74	46.00	15.26
882.630	22.16	7.30	0.44	29.90	46.00	16.10
958.290	23.82	7.60	-0.03	31.39	46.00	14.61

Remark : 1. All reading are Quasi-Peak values.
 2. Emission Level = Antenna Factor + Cable Loss + Meter Reading.

Date of Test : Apr. 16, 2004 Temperature : 21°C
 EUT : Tri-Band Smartphone Humidity : 48%
 Test Mode : Transmitting Mode, Bluetooth Band, Channel 39: 2441MHz

Emission Frequency MHz	Antenna Factor dB/m	Cable Loss dB	Reading Horizontal dBμV	Emission Level Horizontal dBμV/m	Limits dBμV/m	Margin dB
47.460	18.00	1.40	3.15	22.55	40.00	17.45
119.240	18.83	2.30	3.46	24.59	43.50	18.91
216.240	22.74	3.20	1.32	27.26	46.00	18.74
298.690	26.80	3.90	1.00	31.70	46.00	14.30
329.730	14.80	4.14	5.43	24.37	46.00	21.63
400.540	16.85	4.80	7.32	28.97	46.00	17.03
501.420	18.30	6.52	1.78	26.60	46.00	19.40
588.720	19.20	6.30	2.15	27.65	46.00	18.36
700.270	21.10	6.50	3.25	30.85	46.00	15.15
894.270	22.73	7.30	1.56	31.59	46.00	14.41

Emission Frequency MHz	Antenna Factor dB/m	Cable Loss dB	Reading Vertical dBμV	Emission Level Vertical dBμV/m	Limits dBμV/m	Margin dB
37.760	20.64	1.20	2.66	24.50	40.00	15.50
60.070	14.86	1.60	5.59	22.06	40.00	17.95
219.150	22.83	3.21	2.59	28.63	46.00	17.37
258.920	25.47	3.50	1.45	30.42	46.00	15.58
400.540	16.45	4.80	4.94	26.19	46.00	19.81
480.080	17.40	6.05	1.61	25.06	46.00	20.94
700.270	20.95	6.50	4.29	31.73	46.00	14.27
733.250	21.20	6.70	2.59	30.49	46.00	15.51
882.630	22.16	7.30	0.44	29.90	46.00	16.10
961.200	23.70	7.60	-0.14	31.16	54.00	22.84

Remark : 1. All reading are Quasi-Peak values.
 2. Emission Level = Antenna Factor + Cable Loss + Meter Reading.

Date of Test : Apr. 16, 2004 Temperature : 21°C
 EUT : Tri-Band Smartphone Humidity : 48%
 Test Mode : Transmitting Mode, Bluetooth Band, Channel 78: 2480MHz

Emission Frequency MHz	Antenna Factor dB/m	Cable Loss dB	Reading Horizontal dBμV	Emission Level Horizontal dBμV/m	Limits dBμV/m	Margin dB
61.040	12.55	1.60	32.91	20.69	40.00	19.31
119.240	19.02	2.30	29.44	24.59	43.50	18.91
280.260	25.30	3.80	27.28	30.66	46.00	15.34
362.710	16.38	4.50	32.83	27.40	46.00	18.60
400.540	17.66	4.80	36.12	31.97	46.00	14.03
501.420	18.95	6.52	27.95	26.60	46.00	19.40
624.610	21.31	6.20	26.68	26.93	46.00	19.07
700.270	23.46	6.50	28.28	30.85	46.00	15.15
739.070	22.32	6.60	28.14	29.70	46.00	16.30
905.910	24.88	7.40	25.15	30.47	46.00	15.53

Emission Frequency MHz	Antenna Factor dB/m	Cable Loss dB	Reading Vertical dBμV	Emission Level Vertical dBμV/m	Limits dBμV/m	Margin dB
36.790	21.74	1.20	28.15	24.63	40.00	15.37
85.290	14.98	1.90	32.47	23.03	40.00	16.97
209.450	22.37	3.16	28.66	28.40	43.50	15.10
290.930	25.96	3.90	25.81	29.96	46.00	16.04
400.540	17.58	4.80	30.42	26.19	46.00	19.81
441.280	17.40	5.30	29.40	25.41	46.00	20.59
555.740	21.93	6.80	24.34	26.03	46.00	19.97
700.270	22.64	6.50	29.98	31.73	46.00	14.27
730.340	22.60	6.60	28.91	30.74	46.00	15.26
957.320	27.16	7.60	23.91	31.86	46.00	14.14

Remark : 1. All reading are Quasi-Peak values.
 2. Emission Level = Antenna Factor + Cable Loss + Meter Reading.

Date of Test : Apr. 16, 2004 Temperature : 21°C
 EUT : Tri-Band Smartphone Humidity : 48%
 Test Mode : Receiving Mode, Bluetooth Band, Channel 78: 2480MHz

Emission Frequency MHz	Antenna Factor dB/m	Cable Loss dB	Reading Horizontal dBμV	Emission Level Horizontal dBμV/m	Limits dBμV/m	Margin dB
96.690	15.99	2.00	19.31	37.30	43.50	6.20
144.480	20.60	2.60	12.53	35.73	43.50	7.77
160.140	21.20	2.70	13.50	37.40	43.50	6.10
191.730	21.90	3.00	10.15	35.05	43.50	8.45
431.600	17.20	5.20	17.70	40.10	46.00	5.90
501.600	18.30	6.52	12.22	37.04	46.00	8.96
563.900	19.10	6.61	14.86	40.57	46.00	5.43
600.300	19.50	6.30	14.78	40.58	46.00	5.42
633.900	19.80	6.30	11.56	37.66	46.00	8.34

Emission Frequency MHz	Antenna Factor dB/m	Cable Loss dB	Reading Vertical dBμV	Emission Level Vertical dBμV/m	Limits dBμV/m	Margin dB
31.890	22.46	1.10	9.34	32.90	40.00	7.10
160.140	21.20	2.70	10.79	34.69	43.50	8.81
213.330	22.91	3.10	11.53	37.54	43.50	5.96
241.680	25.16	3.40	10.03	38.60	46.00	7.40
497.400	17.84	6.40	14.76	39.00	46.00	7.00
696.900	20.80	6.50	10.37	37.67	46.00	8.33
799.800	21.60	6.90	8.35	36.85	46.00	9.15
898.500	23.04	7.30	9.63	39.96	46.00	6.04

Remark : 1. All reading are Quasi-Peak values.
 2. Emission Level = Antenna Factor + Cable Loss + Meter Reading.

Date of Test : Apr. 16, 2004 Temperature : 21°C
 EUT : Tri-Band Smartphone Humidity : 48%
 Test Mode : USB Link to PC, Upload & Down Load

Emission Frequency MHz	Antenna Factor dB/m	Cable Loss dB	Reading Horizontal dBμV	Emission Level Horizontal dBμV/m	Limits dBμV/m	Margin dB
112.080	18.36	2.20	35.56	29.91	43.50	13.59
133.410	19.89	2.40	37.35	33.55	43.50	9.95
195.240	21.77	3.00	34.91	33.86	43.50	9.64
233.040	22.36	3.30	34.10	34.00	46.00	12.00
351.800	15.55	4.30	43.38	37.01	46.00	8.99
400.100	17.66	4.80	40.05	35.90	46.00	10.10
666.100	22.78	6.40	32.46	34.30	46.00	11.70
703.900	23.56	6.60	30.11	32.88	46.00	13.12

Emission Frequency MHz	Antenna Factor dB/m	Cable Loss dB	Reading Vertical dBμV	Emission Level Vertical dBμV/m	Limits dBμV/m	Margin dB
39.720	20.74	1.20	7.13	29.08	40.00	10.92
109.380	17.95	2.20	9.51	29.66	43.50	13.84
133.410	19.23	2.40	6.66	28.28	43.50	15.22
239.790	24.36	3.40	3.60	31.35	46.00	14.65
351.800	15.78	4.30	11.84	31.91	46.00	14.09
400.800	17.58	4.80	10.32	32.69	46.00	13.31
666.800	22.49	6.40	5.71	34.60	46.00	11.40
703.900	22.29	6.60	6.18	35.07	46.00	10.93
798.400	24.92	6.90	-0.90	30.92	46.00	15.08

Remark : 1. All reading are Quasi-Peak values.
 2. Emission Level = Antenna Factor + Cable Loss + Meter Reading.

3.6.2. Above 1GHz Frequency Range Measurement Results

Date of Test : Apr. 16, 2004 Temperature : 21°C
 EUT : Tri-Band Smartphone Humidity : 48%
 Test Mode : Transmitting Mode, Bluetooth Band, Channel 0: 2402MHz

	Emission Frequency MHz	Antenna Factor dB/m	Cable Loss dB	Reading Horizontal dBμV	Emission Level Horizontal dBμV/m	Limits dBμV/m	Margin dB
Peak	* 2769.270	29.93	6.89	8.98	45.80	74.00	28.20
	4433.660	32.81	8.66	5.34	46.81	74.00	27.19
	* 4804.000	33.62	9.14	1.78	44.54	74.00	29.46
Average	* 2769.270	29.93	6.89	0.28	37.10	54.00	16.90
	4433.660	32.81	8.66	0.20	41.67	54.00	12.33
	* 4804.000	33.62	9.14	-3.77	38.99	54.00	15.01

	Emission Frequency MHz	Antenna Factor dB/m	Cable Loss dB	Reading Vertical dBμV	Emission Level Vertical dBμV/m	Limits dBμV/m	Margin dB
Peak	* 4622.670	33.15	8.92	5.60	47.67	74.00	26.33
	* 4804.000	33.62	9.14	3.48	46.24	74.00	27.76
	5322.280	34.50	9.60	5.31	49.41	74.00	24.59
Average	* 4622.670	33.15	8.92	4.97	47.04	54.00	6.96
	* 4804.000	33.62	9.14	0.91	43.67	54.00	10.33
	5322.280	34.50	9.60	2.28	46.38	54.00	7.62

- Remark : 1. Emission Level = Antenna Factor + Cable Loss + Meter Reading.
 2. Measurement was up to 18GHz, but the emissions level were too low against the official limit and not report.
 3. '*' The field strength of emission appearing within Part 15.205(a)(b) shall not exceed the limits shown in section 15.209.

Date of Test : Apr. 16, 2004 Temperature : 21°C
 EUT : Tri-Band Smartphone Humidity : 48%
 Test Mode : Transmitting Mode, Bluetooth Band, Channel 39: 2441MHz

	Emission Frequency MHz	Antenna Factor dB/m	Cable Loss dB	Reading Horizontal dBμV	Emission Level Horizontal dBμV/m	Limits dBμV/m	Margin dB
Peak *	2741.060	29.83	6.85	9.96	46.64	74.00	27.36
*	4882.000	33.82	9.16	3.21	46.19	74.00	27.81
	5265.860	34.43	9.55	4.94	48.92	74.00	25.08
Average *	2741.060	29.83	6.85	5.95	42.63	54.00	11.37
*	4882.000	33.82	9.16	-0.97	42.01	54.00	11.99
	5265.860	34.43	9.55	0.54	44.52	54.00	9.48

	Emission Frequency MHz	Antenna Factor dB/m	Cable Loss dB	Reading Vertical dBμV	Emission Level Vertical dBμV/m	Limits dBμV/m	Margin dB
Peak *	4292.610	32.84	8.60	5.91	47.35	74.00	26.65
*	4566.250	33.00	8.82	5.75	47.57	74.00	26.43
*	4882.000	33.82	9.16	3.57	46.55	74.00	27.45
Average *	4292.610	32.84	8.60	3.19	44.63	54.00	9.37
*	4566.250	33.00	8.82	0.97	42.79	54.00	11.21
*	4882.000	33.82	9.16	-1.24	41.74	54.00	12.26

- Remark : 1. Emission Level = Antenna Factor + Cable Loss + Meter Reading.
 2. Measurement was up to 18GHz, but the emissions level were too low against the official limit and not report.
 3. '*' The field strength of emission appearing within Part 15.205(a)(b) shall not exceed the limits shown in section 15.209.

Date of Test : Apr. 16, 2004 Temperature : 21°C
 EUT : Tri-Band Smartphone Humidity : 48%
 Test Mode : Transmitting Mode, Bluetooth Band, Channel 78: 2480MHz

	Emission Frequency MHz	Antenna Factor dB/m	Cable Loss dB	Reading Horizontal dBμV	Emission Level Horizontal dBμV/m	Limits dBμV/m	Margin dB
Peak *	4608.560	33.12	8.89	5.84	47.85	74.00	26.15
*	4960.000	34.02	9.12	2.30	45.44	74.00	28.56
*	5110.700	34.24	9.41	4.97	48.62	74.00	25.38
Average *	4608.560	33.12	8.89	1.51	43.52	54.00	10.48
*	4960.000	34.02	9.12	-1.51	41.63	54.00	12.37
*	5110.700	34.24	9.41	0.98	44.63	54.00	9.37

	Emission Frequency MHz	Antenna Factor dB/m	Cable Loss dB	Reading Vertical dBμV	Emission Level Vertical dBμV/m	Limits dBμV/m	Margin dB
Peak *	4608.560	33.12	8.89	5.98	47.99	74.00	26.01
*	4960.000	34.02	9.12	2.58	45.72	74.00	28.28
	5229.180	34.39	9.51	5.38	49.28	74.00	24.72
Average *	4608.560	33.12	8.89	2.31	44.32	54.00	9.68
*	4960.000	34.02	9.12	-0.81	42.33	54.00	11.67
	5229.180	34.39	9.51	2.07	45.97	54.00	8.03

- Remark : 1. Emission Level = Antenna Factor + Cable Loss + Meter Reading.
 2. Measurement was up to 18GHz, but the emissions level were too low against the official limit and not report.
 3. '*' The field strength of emission appearing within Part 15.205(a)(b) shall not exceed the limits shown in section 15.209.

Date of Test : Apr. 16, 2004 Temperature : 21°C
 EUT : Tri-Band Smartphone Humidity : 48%
 Test Mode : Receiving Mode, Bluetooth Band, Channel 78: 2480MHz

	Emission Frequency MHz	Antenna Factor dB/m	Cable Loss dB	Reading Horizontal dBμV	Emission Level Horizontal dBμV/m	Limits dBμV/m	Margin dB
Peak *	1045.306	25.22	4.28	18.50	48.00	74.00	26.00
	* 1149.342	25.27	4.49	16.87	46.63	74.00	27.37
	1298.684	25.33	4.83	16.26	46.42	74.00	27.58
Average *	1045.306	25.22	4.28	14.37	43.87	54.00	10.13
	* 1149.342	25.27	4.49	12.97	42.73	54.00	11.27
	1298.684	25.33	4.83	13.59	43.75	54.00	10.25

	Emission Frequency MHz	Antenna Factor dB/m	Cable Loss dB	Reading Vertical dBμV	Emission Level Vertical dBμV/m	Limits dBμV/m	Margin dB
Peak *	1062.086	25.23	4.31	21.34	50.88	74.00	23.12
	1255.056	25.31	4.69	18.69	48.69	74.00	25.31
Average *	1062.086	25.23	4.31	17.34	46.88	54.00	7.12
	1255.056	25.31	4.69	15.69	45.69	54.00	8.31

- Remark :
1. Emission Level = Antenna Factor + Cable Loss + Meter Reading.
 2. Measurement was up to 18GHz, but the emissions level were too low against the official limit and not report.
 3. '*' The field strength of emission appearing within Part 15.205(a)(b) shall not exceed the limits shown in section 15.209.

3.6.3. Restricted Bands Measurement Results

Date of Test : Apr. 16, 2004 Temperature : 21°C
 EUT : Tri-Band Smartphone Humidity : 48%
 Test Mode : Transmitting Mode, Bluetooth Band, Channel 0: 2402MHz

	Emission Frequency MHz	Antenna Factor dB/m	Cable Loss dB	Reading Horizontal dBμV	Emission Level Horizontal dBμV/m	Limits dBμV/m	Margin dB
Peak *	2386.860	28.60	6.34	7.26	42.20	74.00	31.80
	2390.000	28.60	6.34	6.68	41.62	74.00	32.38
Average *	2338.280	28.51	6.28	-5.46	29.33	54.00	24.67
	2390.000	28.60	6.34	-6.13	28.81	54.00	25.19

- Remark : 1. Emission Level = Antenna Factor + Cable Loss + Meter Reading.
 2. Low frequency section (spurious in the restricted band 2310-2390MHz).
 3. '*' The field strength of emission appearing within Part 15.205(a)(b) shall not exceed the limits shown in section 15.209.

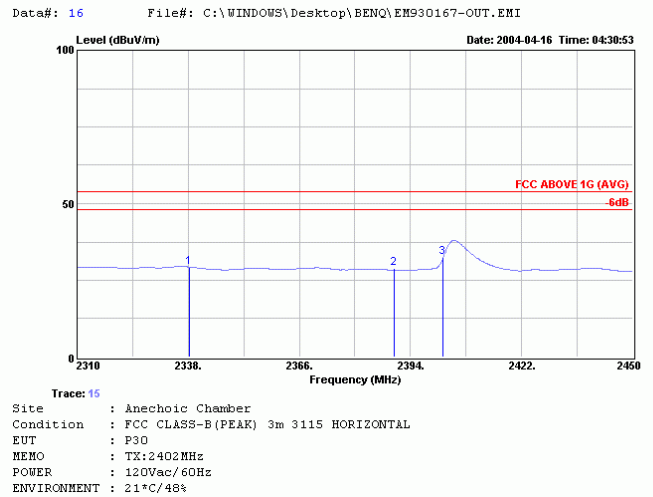
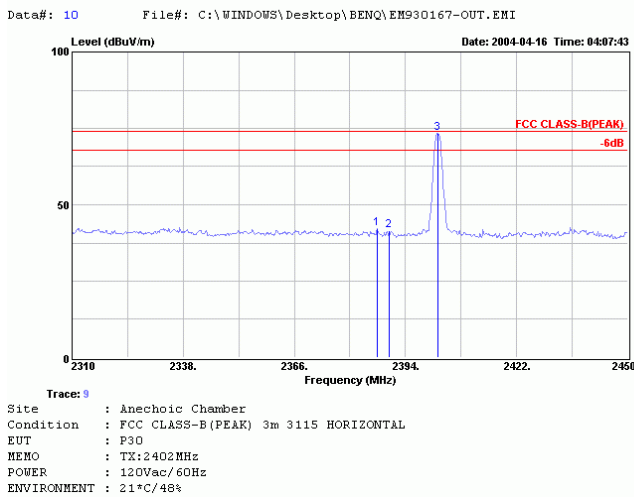

Date of Test : Apr. 16, 2004 Temperature : 21°C
 EUT : Tri-Band Smartphone Humidity : 48%
 Test Mode : Transmitting Mode, Bluetooth Band, Channel 0: 2402MHz

	Emission Frequency MHz	Antenna Factor dB/m	Cable Loss dB	Reading Vertical dBμV	Emission Level Vertical dBμV/m	Limits dBμV/m	Margin dB
Peak *	2331.560	28.49	6.27	7.89	42.65	74.00	31.35
	2390.000	28.60	6.34	6.68	41.62	74.00	32.38
Average *	2336.040	28.50	6.28	-5.36	29.42	54.00	24.58
	2390.000	28.60	6.34	-6.20	28.74	54.00	25.26

- Remark :
1. Emission Level = Antenna Factor + Cable Loss + Meter Reading.
 2. Low frequency section (spurious in the restricted band 2310-2390MHz).
 3. ‘*’ The field strength of emission appearing within Part 15.205(a)(b) shall not exceed the limits shown in section 15.209.

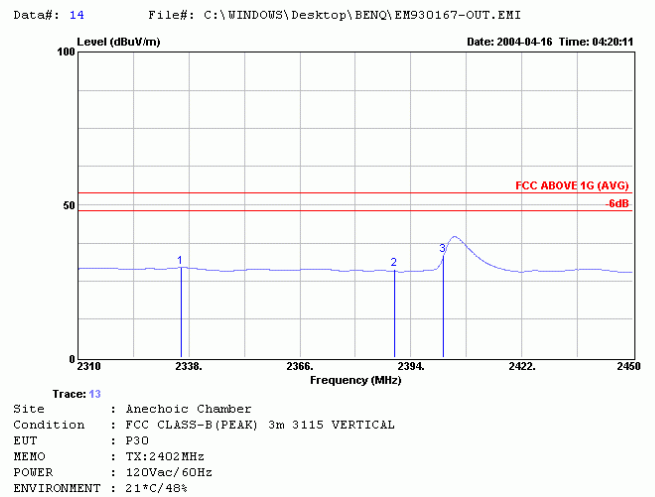
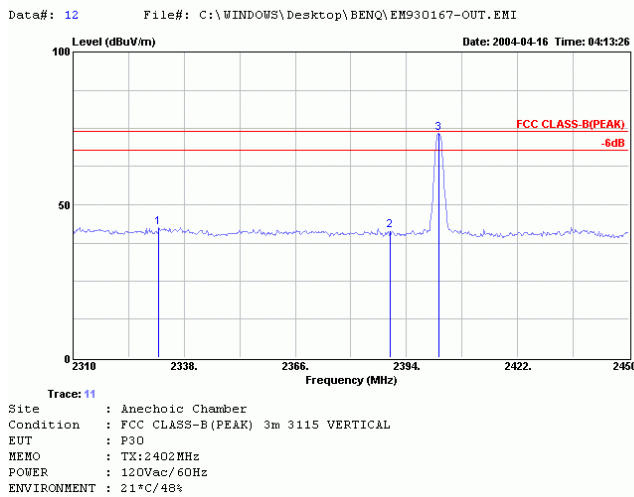

Date of Test : Apr. 16, 2004 Temperature : 21°C

EUT : Tri-Band Smartphone Humidity : 48%

Test Mode : Transmitting Mode, Bluetooth Band, Channel 78: 2480MHz

	Emission Frequency MHz	Antenna Factor dB/m	Cable Loss dB	Reading Horizontal dBμV	Emission Level Horizontal dBμV/m	Limits dBμV/m	Margin dB
Peak *	2483.600	28.78	6.45	4.58	39.81	74.00	34.19
*	2489.360	28.79	6.46	6.20	41.45	74.00	32.55
Average *	2483.600	28.78	6.45	7.02	42.25	54.00	11.75
*	2483.610	28.78	6.45	6.87	42.10	54.00	11.90

- Remark :
1. Emission Level = Antenna Factor + Cable Loss + Meter Reading.
 2. High frequency section (spurious in the restricted band 2483.5-2500MHz).
 3. '*' The field strength of emission appearing within Part 15.205(a)(b) shall not exceed the limits shown in section 15.209.

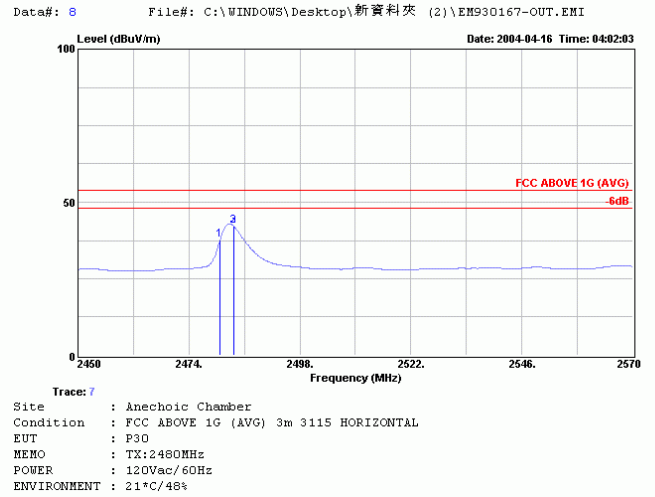
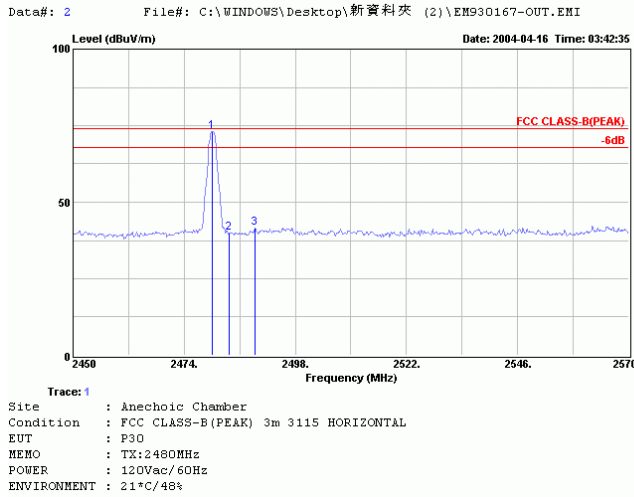

Date of Test : Apr. 16, 2004 Temperature : 21°C

EUT : Tri-Band Smartphone Humidity : 48%

Test Mode : Transmitting Mode, Bluetooth Band, Channel 78: 2480MHz

	Emission Frequency MHz	Antenna Factor dB/m	Cable Loss dB	Reading Vertical dBμV	Emission Level Vertical dBμV/m	Limits dBμV/m	Margin dB
Peak *	2483.600	28.78	6.45	4.49	39.72	74.00	34.28
*	2492.480	28.79	6.46	5.77	41.02	74.00	32.98
Average *	2483.600	28.78	6.45	6.99	42.22	54.00	11.78
*	2483.610	28.78	6.45	6.87	42.10	54.00	11.90

- Remark :
1. Emission Level = Antenna Factor + Cable Loss + Meter Reading.
 2. High frequency section (spurious in the restricted band 2483.5-2500MHz).
 3. '*' The field strength of emission appearing within Part 15.205(a)(b) shall not exceed the limits shown in section 15.209.

Data#: 4 File#: C:\WINDOWS\Desktop\新資料夾 (2)\EM930167-OUT.EMI

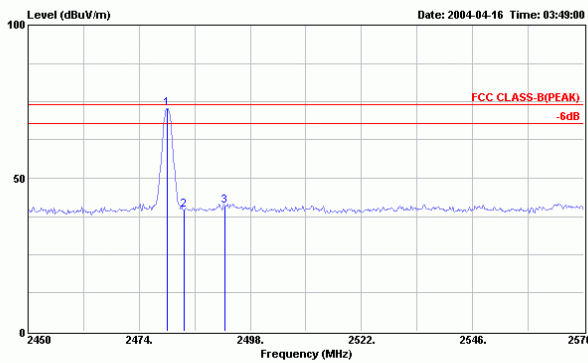

Trace: 3
 Site : Anechoic Chamber
 Condition : FCC CLASS-B (PEAK) 3m 3115 VERTICAL
 EUT : P30
 MEMO : TX:2480MHz
 POWER : 120Vac/60Hz
 ENVIRONMENT : 21°C/48%

Data#: 6 File#: C:\WINDOWS\Desktop\新資料夾 (2)\EM930167-OUT.EMI

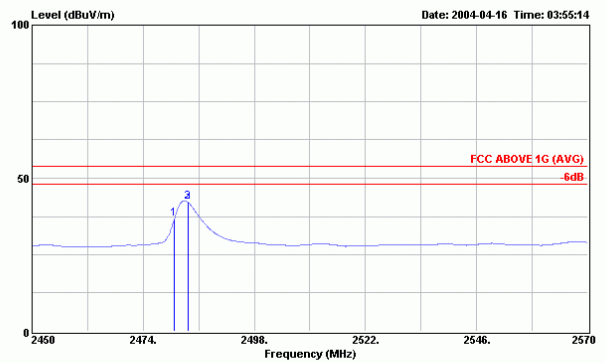

Trace: 5
 Site : Anechoic Chamber
 Condition : FCC CLASS-B (PEAK) 3m 3115 VERTICAL
 EUT : P30
 MEMO : TX:2480
 POWER : 120Vac/60Hz
 ENVIRONMENT : 21°C/48%

4. CARRIER FREQUENCY SEPARATION MEASUREMENT

4.1. Test Equipment

The following test equipment were used during the carrier frequency test :

Item	Type	Manufacturer	Model No.	Serial No.	Last Cal.	Next Cal.
1.	Spectrum Analyzer	Agilent	8564EC	3946A00249	Aug. 27, 03'	Aug. 26. 04'
2.	Directional Coupler	A/R	DC7144	304087	Mar. 26, 04'	Mar. 25. 05'
3.	Communication Tester	R & S	CMU200	102280	Nov. 07, 03'	Nov.06, 04'

4.2. Block Diagram of Test Setup

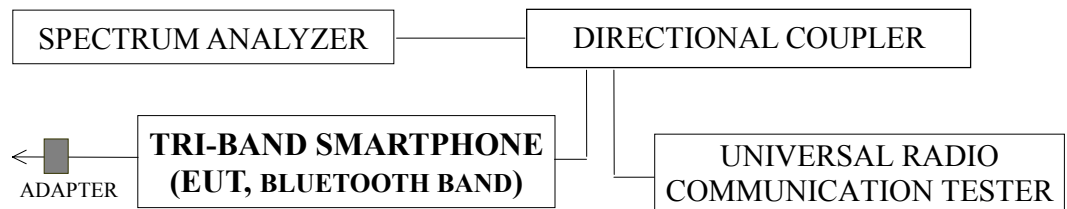

4.3. Specification Limits (§15.247(a)(1))

Frequency hopping systems shall have hopping channel carrier frequencies separated by a minimum of 25kHz or the 20dB bandwidth of the hopping channel, whichever is greater.

4.4. Test Procedure

The transmitter output was connected to the spectrum analyzer. The bandwidth of the center frequency (2441MHz) was measure by spectrum analyzer with 30kHz RBW and 100kHz VBW. The video bandwidth not to be smaller than resolution bandwidth, the peak was mark on adjacent bandwidth, the between of peak is carrier frequency separation.

4.5. Test Results

PASSED. The testing data was attached in the next pages.

(Test Date: Apr. 15, 2004, Temperature: 23°C, Humidity: 51%)

- 2441MHz adjacent channel of right carrier frequency separation: 1.005MHz ◦
(Refer to Figure 1)
- 2441MHz adjacent channel of left carrier frequency separation: 1.005MHz ◦
(Refer to Figure 2.)

Figure 1. (Adjacent Channel of Right Carrier Frequency Separation, 2441MHz)

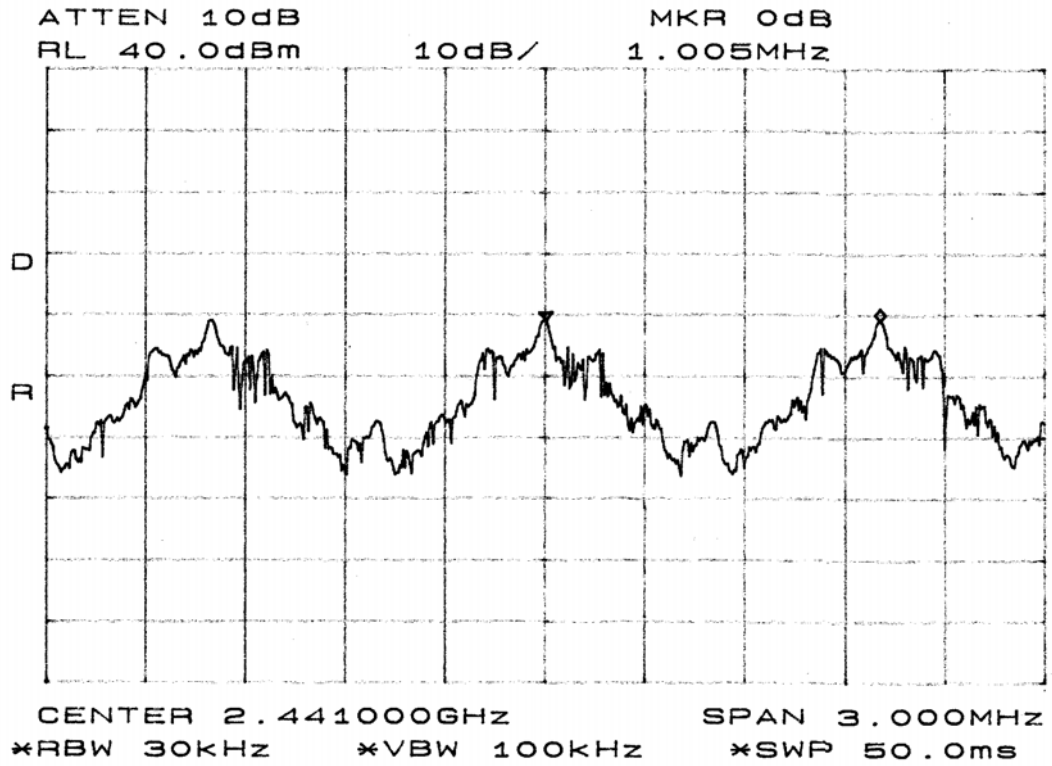
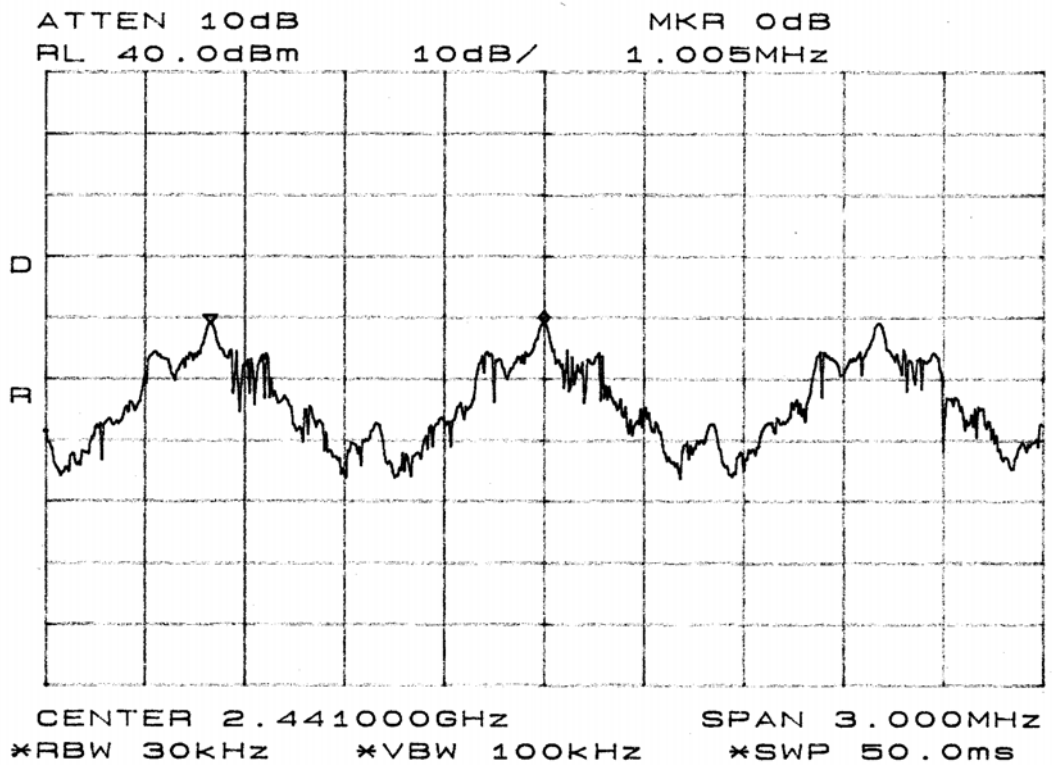

Figure 2. (Adjacent Channel of Left Carrier Frequency Separation, 2441MHz)



5. 20dB BANDWIDTH MEASUREMENT

5.1. Test Equipment

The following test equipment were used during the bandwidth test :

Item	Type	Manufacturer	Model No.	Serial No.	Last Cal.	Next Cal.
1.	Spectrum Analyzer	Agilent	8564EC	3946A00249	Aug. 27, 03'	Aug. 26. 04'
2.	Directional Coupler	A/R	DC7144	304087	Mar. 26, 04'	Mar. 25. 05'
3.	Communication Tester	R & S	CMU200	102280	Nov. 07, 03'	Nov.06, 04'

5.2. Block Diagram of Test Setup

The same as section.4.2.

5.3. Specification Limits (§15.247(a)(1))

Frequency hopping systems shall have hopping channel carrier frequencies separated by a minimum of 25kHz or the 20dB bandwidth of the hopping channel, whichever is greater.

5.4. Test Procedure

The transmitter output was connected to the spectrum analyzer. The bandwidth of the fundamental frequency was measure by spectrum analyzer with 10kHz RBW and 10kHz VBW. The 20dB bandwidth is defined as the total spectrum the power of which is higher than peak power minus 20dB.

5.5. Test Results

PASSED. The testing data was attached in the next pages.

(Test Date: Apr. 16, 2004, Temperature: 24°C, Humidity: 62%)

Channel	Frequency	20dB Bandwidth	Refer to Figure
0	2402MHz	820kHz	Figure 3.
39	2441MHz	825kHz	Figure 4.
78	2480MHz	830kHz	Figure 5.

The maximum 20dB bandwidth shall be at maximum 1000kHz

Figure 5. (20dB Bandwidth, Test Channel 78: 2480MHz)

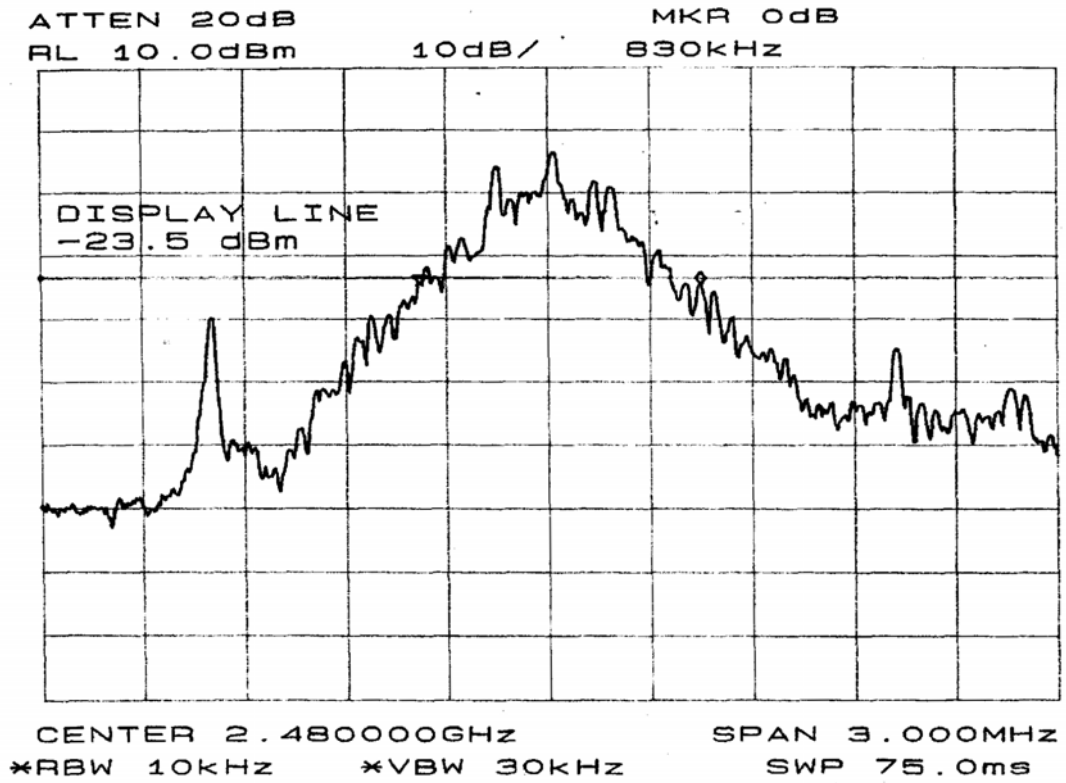

6. TIME OF OCCUPANCY

6.1. Test Equipment

The following test equipment were used during the dwell time test :

Item	Type	Manufacturer	Model No.	Serial No.	Last Cal.	Next Cal.
1.	Spectrum Analyzer	Agilent	8564EC	3946A00249	Aug. 27, 03'	Aug. 26. 04'
2.	Directional Coupler	A/R	DC7144	304087	Mar. 26, 04'	Mar. 25. 05'
3.	Communication Tester	R & S	CMU200	102280	Nov. 07, 03'	Nov.06, 04'

6.2. Block Diagram of Test Setup

The same as section.4.2.

6.3. Specification Limits (§15.247(a)(1)(iii))

Frequency hopping systems in the 2400-2483.5MHz shall use at least 15 non-overlapping channels. The average time of occupancy on any channel shall not be greater than 0.4 seconds within a period of 0.4 seconds multiplied by number of hopping channels employed.

6.4. Test Procedure

The transmitter output was connected to the spectrum analyzer. The bandwidth of the fundamental frequency was measure by spectrum analyzer with 1MHz RBW and 1MHz VBW. $VBW \geq RBW$; Span=zero span.

Centered on a hopping channel sweep=as necessary to capture the entire dwell time per hopping channel ; Detector function=peak ; Trace=Max hold

6.5. Test Results

PASSED. The testing data was attached in the next pages.

(Test Date: Apr. 16, 2004, Temperature: 24°C, Humidity: 62%)

Duty cycle: 79 channels*0.4 seconds = 31.6 seconds

DH1 : The system makes worst case 1600 hops per second or 1 time slot has a length of 625us with 79 channels. A DH1 packet need 1 time slot for transmitting and 1 time slot for receiving. Then the system makes worst case 800 hops per second with 79 channels. So you have each channel 10.13 time per second and so for 31.6 seconds you have 320 time of appearance.

Each Tx-time per appearance is 408.3us.

$10.13 \text{ time} * 31.6 \text{ seconds} * 0.4083 \text{ms} = 130.70 \text{ms} (<400 \text{ms})$

(Refer to Figure 6)

DH3 : The system makes worst case 1600 hops per second or 1 time slot has a length of 625us with 79 channels. A DH3 packet need 3 time slot for transmitting and 1 time slot for receiving. Then the system makes worst case 400 hops per second with 79 channels. So you have each channel 5.1 time per second and so for 31.6 seconds you have 161 time of appearance.

Each Tx-time per appearance is 1666.7us.

$5.1 \text{ time} * 31.6 \text{ seconds} * 1.6667 \text{ms} = 268.60 \text{ms} (<400 \text{ms})$

(Refer to Figure 7)

DH5 : The system makes worst case 1600 hops per second or 1 time slot has a length of 625us with 79 channels. A DH5 packet need 1 time slot for transmitting and 1 time slot for receiving. Then the system makes worst case 266.7 hops per second with 79 channels. So you have each channel 3.37 time per second and so for 31.6 seconds you have 106 time of appearance.

Each Tx-time per appearance is 2916.7us.

$3.37 \text{ time} * 31.6 \text{ seconds} * 2.9 \text{ms} = 308.83 \text{ms} (<400 \text{ms})$

(Refer to Figure 8)

Figure 6. (Time of Occupancy, DH1)

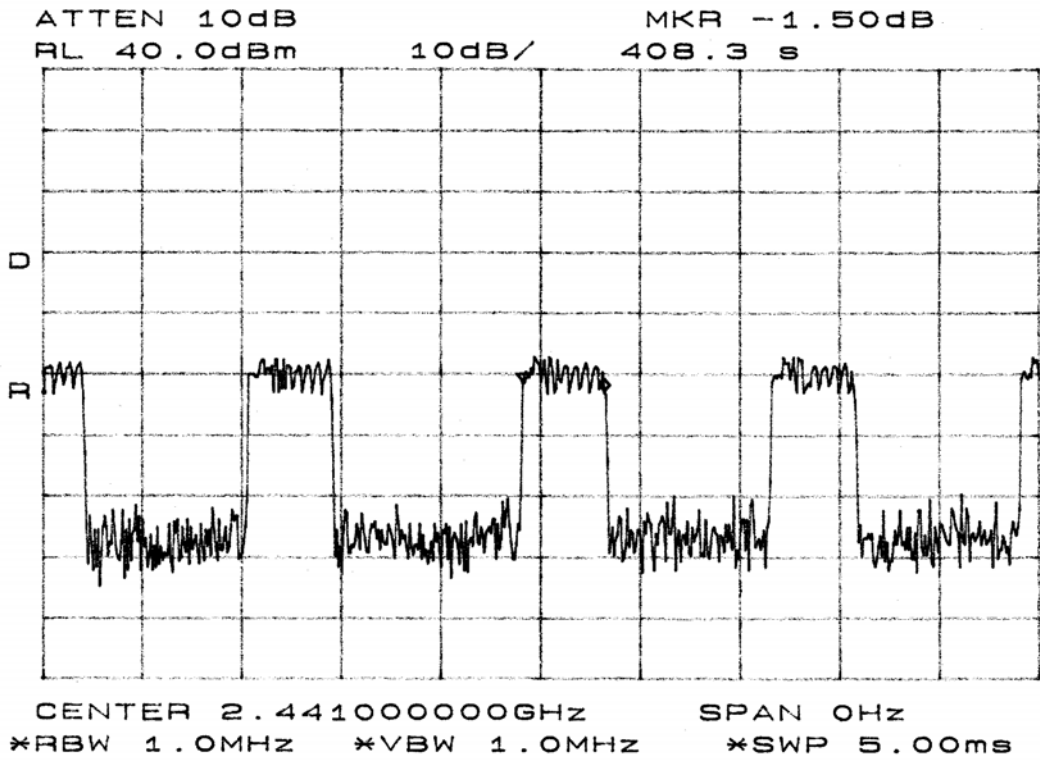

Figure 7. (Time of Occupancy, DH3)

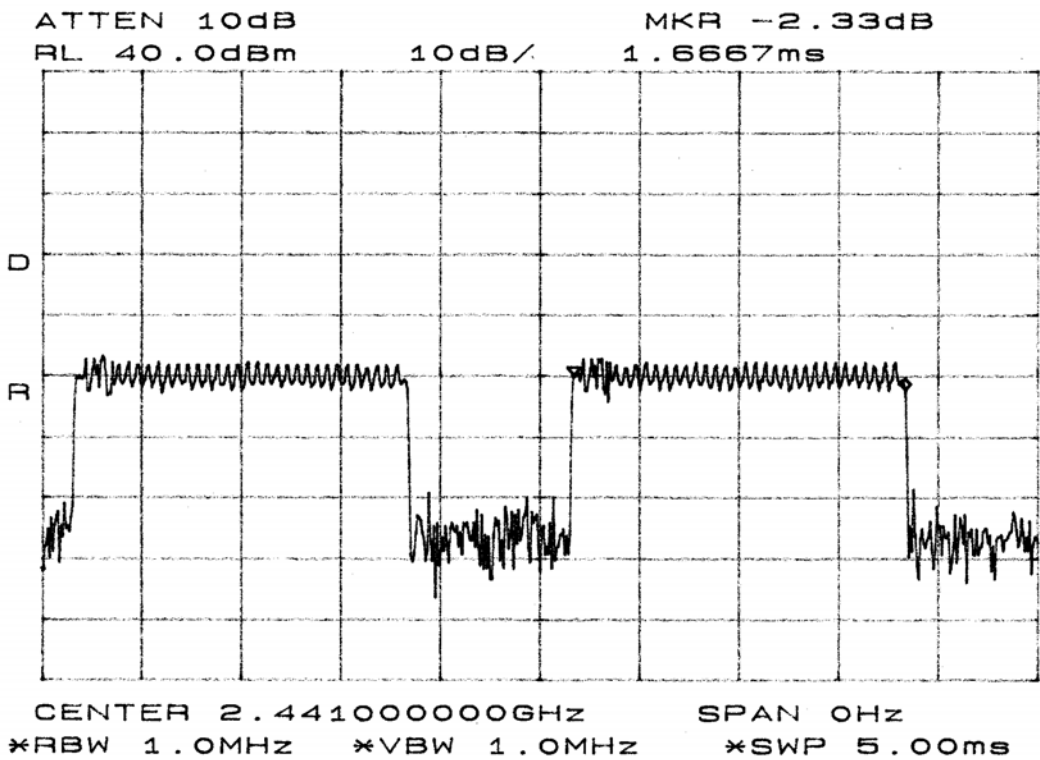
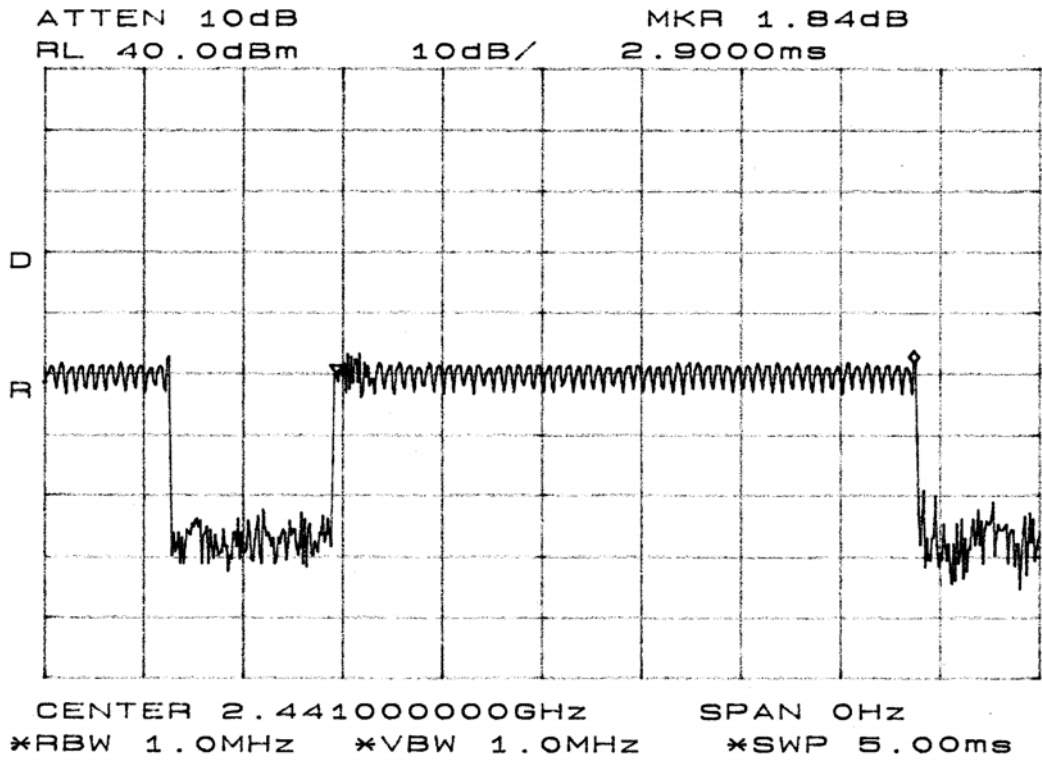

Figure 8. (Time of Occupancy, DH5)



7. NUMBER OF HOPPING CHAMMELS

7.1. Test Equipment

The following test equipment were used during the number of hopping channels test :

Item	Type	Manufacturer	Model No.	Serial No.	Last Cal.	Next Cal.
1.	Spectrum Analyzer	Agilent	8564EC	3946A00249	Aug. 27, 03'	Aug. 26. 04'
2.	Directional Coupler	A/R	DC7144	304087	Mar. 26, 04'	Mar. 25. 05'
3.	Communication Tester	R & S	CMU200	102280	Nov. 07, 03'	Nov.06, 04'

7.2. Block Diagram of Test Setup

The same as section.4.2.

7.3. Specification Limits (§15.247(a)(1)(iii))

Frequency hopping systems which use fewer than 75 hopping frequencies may employ intelligent hopping techniques to avoid interference to other transmissions. Frequency hopping systems may avoid or suppress transmissions on a particular hopping frequency provided that a minimum of 15 non-overlapping channels.

7.4. Test Procedure

The transmitter output was connected to the spectrum analyzer. The bandwidth of the fundamental frequency was measure by spectrum analyzer with 100kHz RBW and 100kHz VBW. Sweep=Auto ; Detector function=peak ; Trace=Max hold

7.5. Test Results

PASSED. The testing data was attached in the next pages.

(Test Date: Apr. 15, 2004, Temperature: 23°C, Humidity: 51%)

The number hopping channel is 79. (Refer to Figure 9)

Figure 9. (Number of Hopping Channel)

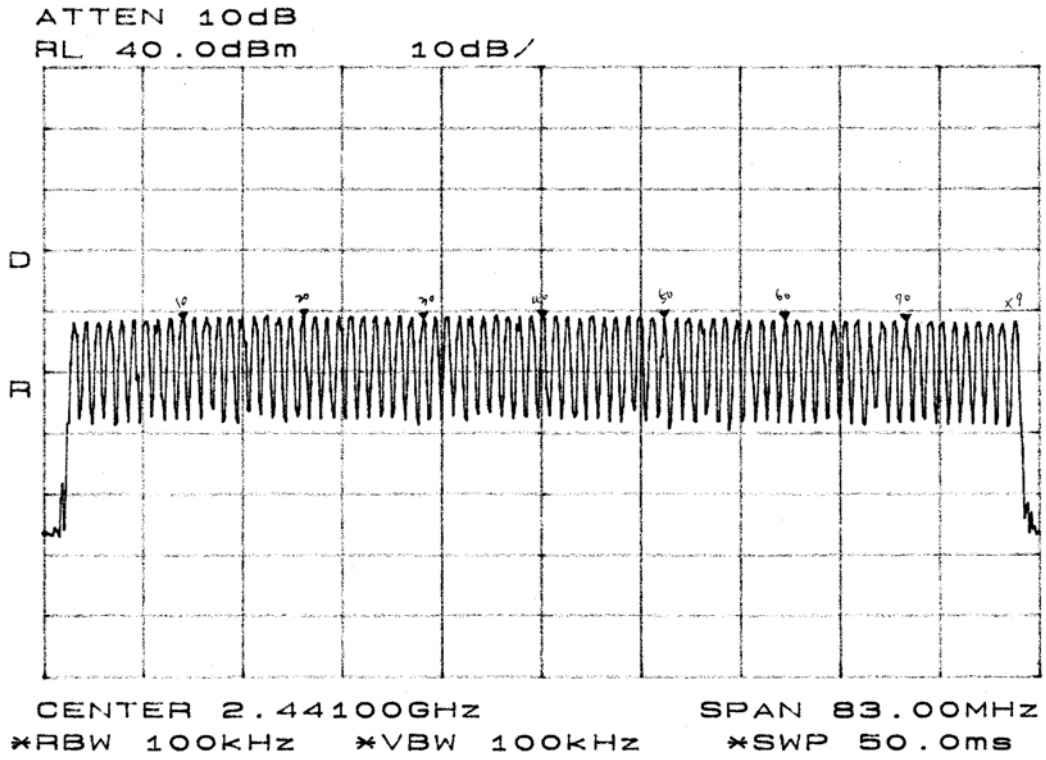

8. MAXIMUM PEAK OUTPUT POWER MEASUREMENT

8.1. Test Equipment

The following test equipment were used during the peak output power test :

Item	Type	Manufacturer	Model No.	Serial No.	Last Cal.	Next Cal.
1.	Spectrum Analyzer	Agilent	8564EC	3946A00249	Aug. 27, 03'	Aug. 26. 04'
2.	Directional Coupler	A/R	DC7144	304087	Mar. 26, 04'	Mar. 25. 05'
3.	Communication Tester	R & S	CMU200	102280	Nov. 07, 03'	Nov.06, 04'

8.2. Block Diagram of Test Setup

The same as section.4.2.

8.3. Specification Limits (§15.247(b)-(1))

The Limits of maximum Peak Output Power for frequency hopping systems in 2400-2483.5MHz is: 1Watt. (30dBm)

8.4. Test Procedure

The transmitter output was connected to the spectrum analyzer.
 Span= approximately 5 times the 20dB bandwidth, centered on a hopping channel.
 RBW > the 20dB bandwidth of the emission being measured.
 VBW ≥ RBW ; Sweep=auto; Detector function=peak ; Trace=Max hold

8.5. Test Results

PASSED. The testing data was attached in the next pages.

(Test Date: Apr. 16, 2004, Temperature: 24°C, Humidity: 62%)

Channel	Frequency	Peak Output Power	Limit	Refer to Figure
1	2402MHz	-1.83dBm	30dBm	Figure 10.
39	2441MHz	-1.00dBm	30dBm	Figure 11.
78	2480MHz	-2.00dBm	30dBm	Figure 12.

Figure 10. (Peak Output Power, Channel 0: 2402MHz)

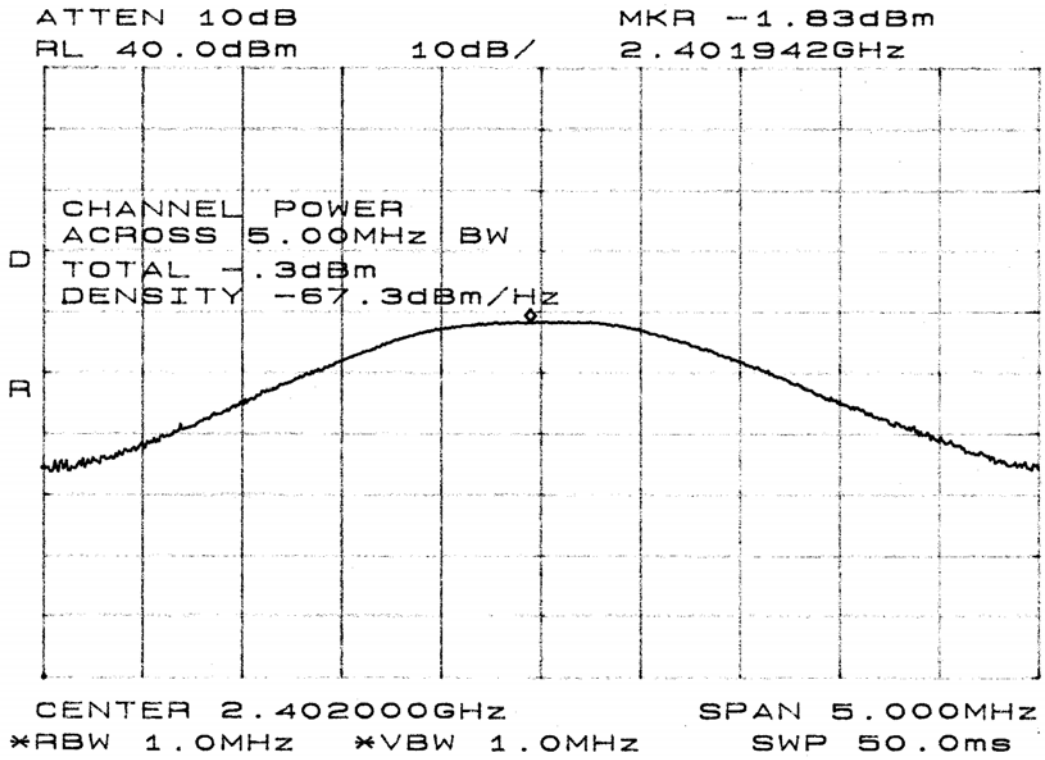

Figure 11. (Peak Output Power, Test Channel 39: 2441MHz)

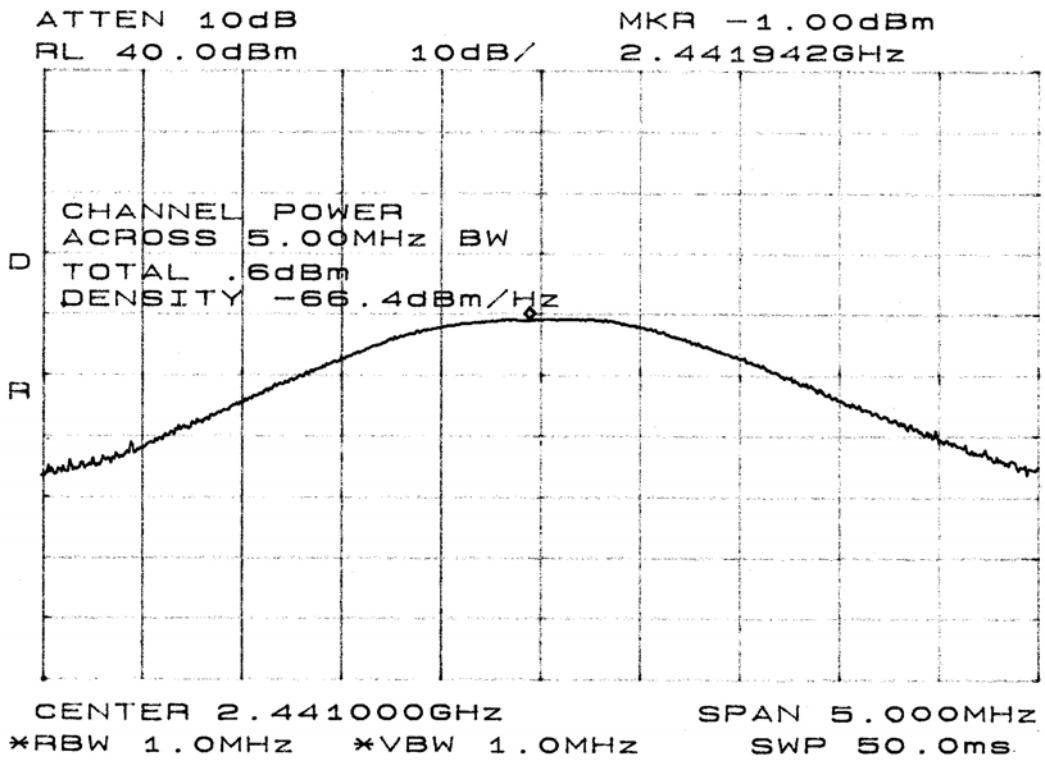
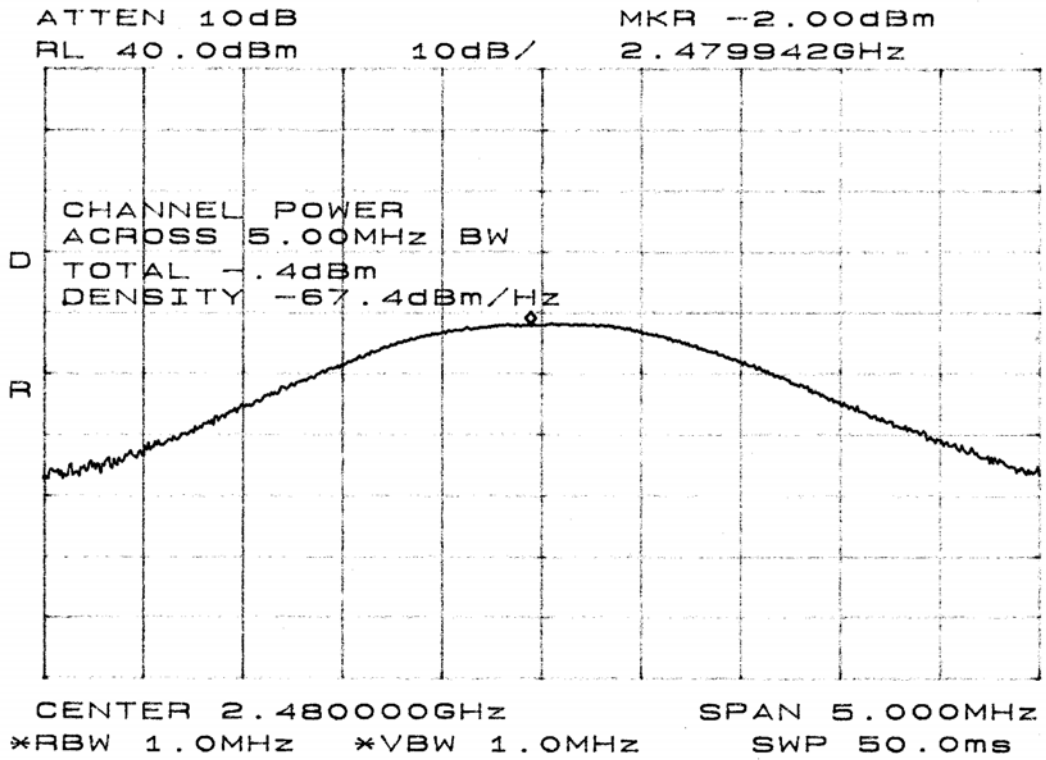

Figure 12. (Peak Output Power, Test Channel 78: 2480MHz)



9. EMISSION LIMITATIONS MEASUREMENT

9.1. Test Equipment

The following test equipment were used during the emission limitations test :

Item	Type	Manufacturer	Model No.	Serial No.	Last Cal.	Next Cal.
1.	Spectrum Analyzer	Agilent	8564EC	3946A00249	Aug. 27, 03'	Aug. 26. 04'
2.	Directional Coupler	A/R	DC7144	304087	Mar. 26, 04'	Mar. 25. 05'
3.	Communication Tester	R & S	CMU200	102280	Nov. 07, 03'	Nov.06, 04'

9.2. Block Diagram of Test Setup

The same as section.4.2.

9.3. Specification Limits (§15.247(c))

In any 100kHz bandwidth outside the frequency band in which the spread spectrum or digitally modulated intentional radiator is operating, the radio frequency power that is produced by the intentional radiator shall be at least 20dB below that in the 100kHz bandwidth within the band that contains the highest level of the desired power, based on either an RF conducted or a radiated measurement. Attenuation below the general limits specified in Section 15.209(a) is not required. In addition, radiated emissions which fall in restricted bands, as defined in Section 15.205(a), must also comply with the radiated emission limits specified in Section 15.209(a) (See Section 15.205(c)).(※ This test result attaching to §3.6.3)

9.4. Test Procedure

The transmitter output was connected to the spectrum analyzer. Set both RBW and VBW of spectrum analyzer to 100kHz with suitable frequency span including 100kHz bandwidth from band edge.

9.5. Test Results

PASSED. The testing data was attached in the next pages.

(Test Date: Apr. 15, 2004, Temperature: 23°C, Humidity: 51%)

1. 2402MHz: During 30MHz~25GHz bandwidth. In the 2.4GHz, the -27.50dBm is max value that is lower than 20dB of primary channel.
(Refer to figure 13.)
2. 2441MHz: During 30MHz~25GHz bandwidth. In the 2.4GHz, the -27.17dBm is max value that is lower than 20dB of primary channel.
(Refer to figure 14)
3. 2480MHz: During 30MHz~25GHz bandwidth. In the 2.4GHz, the -25.83dBm is max value that is lower than 20dB of primary channel.
(Refer to figure 15)

Note: The peak above the limit line is the carrier frequency.

Figure 15. (Emission Limitations, Test Channel 78: 2480MHz)

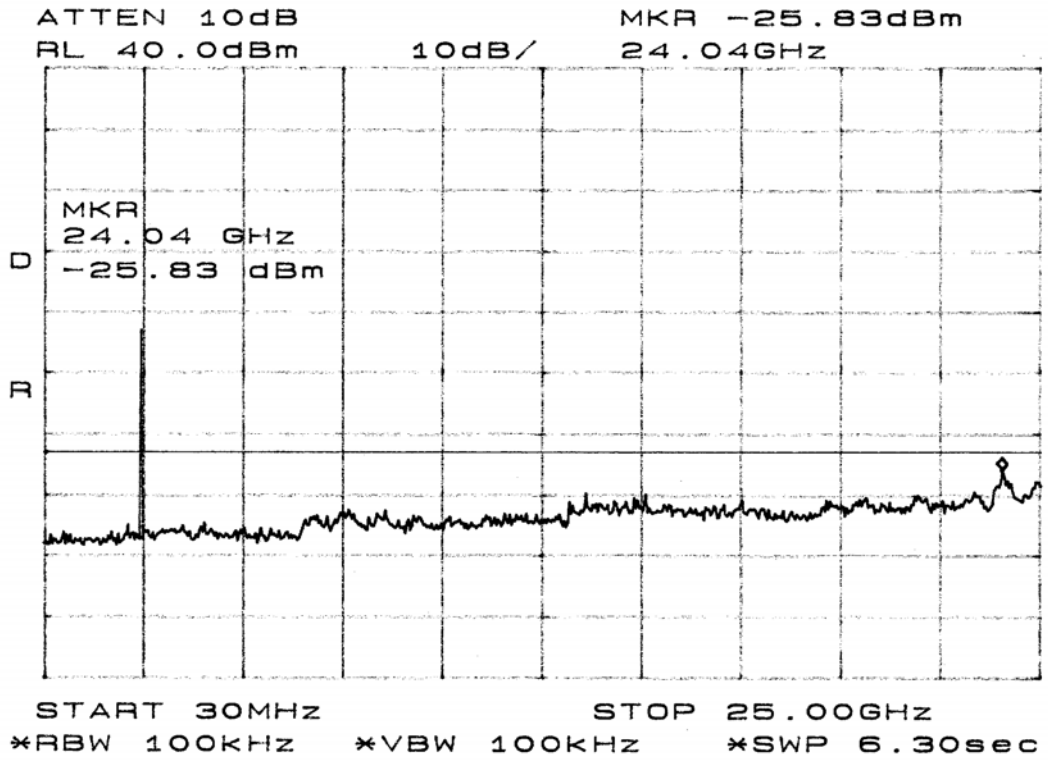

10. BAND EDGES MEASUREMENT

10.1. Test Equipment

The following test equipment were used during the band edges test :

Item	Type	Manufacturer	Model No.	Serial No.	Last Cal.	Next Cal.
1.	Spectrum Analyzer	Agilent	8564EC	3946A00249	Aug. 27, 03'	Aug. 26. 04'
2.	Directional Coupler	A/R	DC7144	304087	Mar. 26, 04'	Mar. 25. 05'
3.	Communication Tester	R & S	CMU200	102280	Nov. 07, 03'	Nov.06, 04'

10.2. Block Diagram of Test Setup

The same as section.4.2.

10.3. Specification Limits (§15.247(c))

In any 100kHz bandwidth outside the frequency band in which the spread spectrum or digitally modulated intentional radiator is operating, the radio frequency power that is produced by the intentional radiator shall be at least 20dB below that in the 100kHz bandwidth within the band that contains the highest level of the desired power, based on either an RF conducted or a radiated measurement. Attenuation below the general limits specified in Section 15.209(a) is not required. In addition, radiated emissions which fall in restricted bands, as defined in Section 15.205(a), must also comply with the radiated emission limits specified in Section 15.209(a) (See Section 15.205(c)). (※ This test result attaching to §3.6.3)

10.4. Test Procedure

The transmitter output was connected to the spectrum analyzer. Set both RBW and VBW of spectrum analyzer to 100kHz with suitable frequency span including 100kHz bandwidth from band edge.

10.5. Test Results

PASSED. The testing data was attached in the next pages.

(Test Date: Apr. 16, 2004, Temperature: 24°C, Humidity: 62%)

1. Upper Band edge : The highest emission level is – 33.83dBm on 2.39983GHz ◦
(Refer to Figure 16.)
2. Below Band edge: The highest emission level is – 35.17dBm on 2.4835GHz ◦
(Refer to Figure 17.)

Figure 16. (Band Edges, Upper Band Edges)

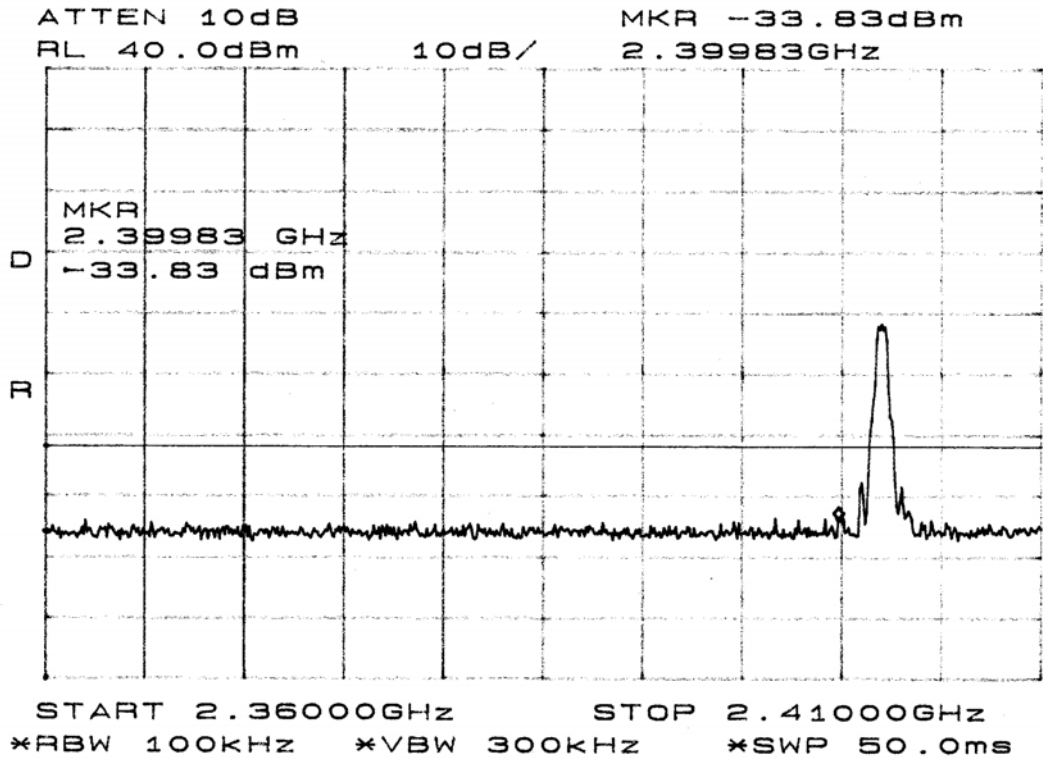
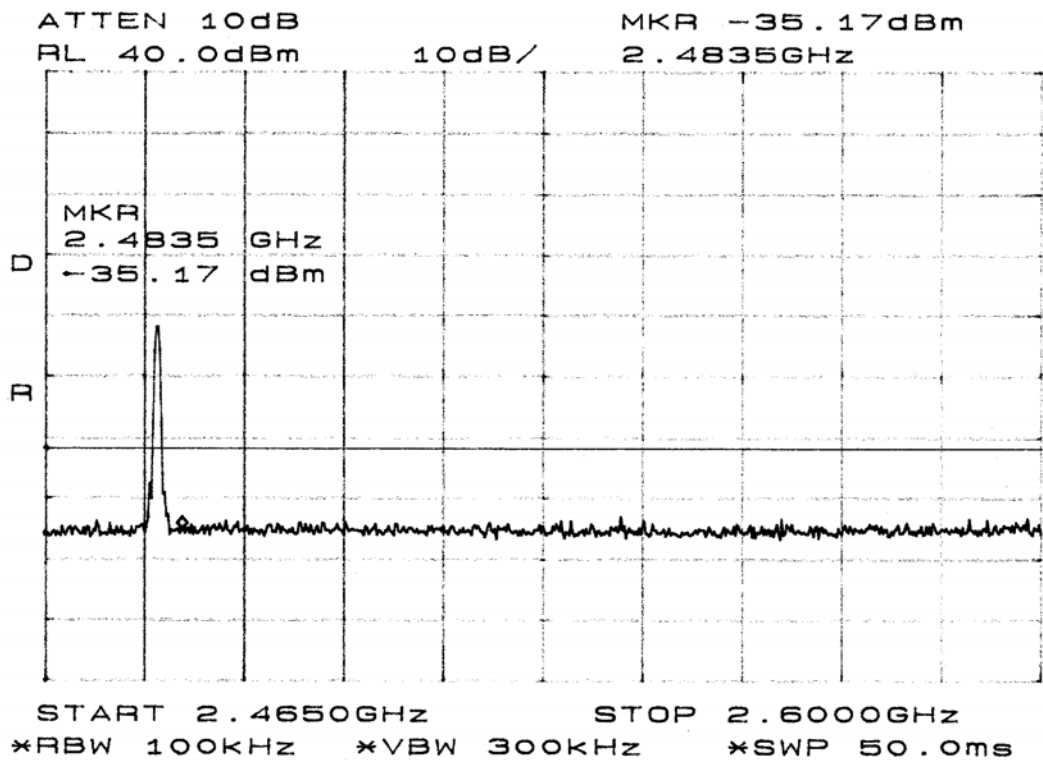

Figure 17. (Band Edges, Below Band Edges)



11. POWER SPECTRAL DENSITY MEASUREMENT

11.1. Test Equipment

The following test equipment were used during the power spectral density test :

Item	Type	Manufacturer	Model No.	Serial No.	Last Cal.	Next Cal.
1.	Spectrum Analyzer	Agilent	8564EC	3946A00249	Aug. 27, 03'	Aug. 26. 04'
2.	Directional Coupler	A/R	DC7144	304087	Mar. 26, 04'	Mar. 25. 05'
3.	Communication Tester	R & S	CMU200	102280	Nov. 07, 03'	Nov.06, 04'

11.2. Block Diagram of Test Setup

The same as section.4.2.

11.3. Specification Limits (§15.247(d))

The peak power spectral density conducted from the intentional radiator to the antenna shall not be greater than 8dBm in any 3kHz band.

11.4. Test Procedure

The transmitter output was connected to the spectrum analyzer. The bandwidth of the fundamental frequency was measured with the spectrum analyzer using 3kHz RBW and 3kHz VBW, set sweep time = span/3kHz.

11.5. Test Results

PASSED. The testing data was attached in the next pages.

(Test Date: Apr. 16, 2004, Temperature: 24°C, Humidity: 62%)

Channel	Frequency	Power Spectral Density	Limit	Refer to Figure
0	2402MHz	-4.17dBm	8dBm	Figure 18.
39	2441MHz	-3.33dBm	8dBm	Figure 19.
78	2480MHz	-4.17dBm	8dBm	Figure 20.

Figure 20. (Power Spectral Density, Test Channel 78: 2480MHz)

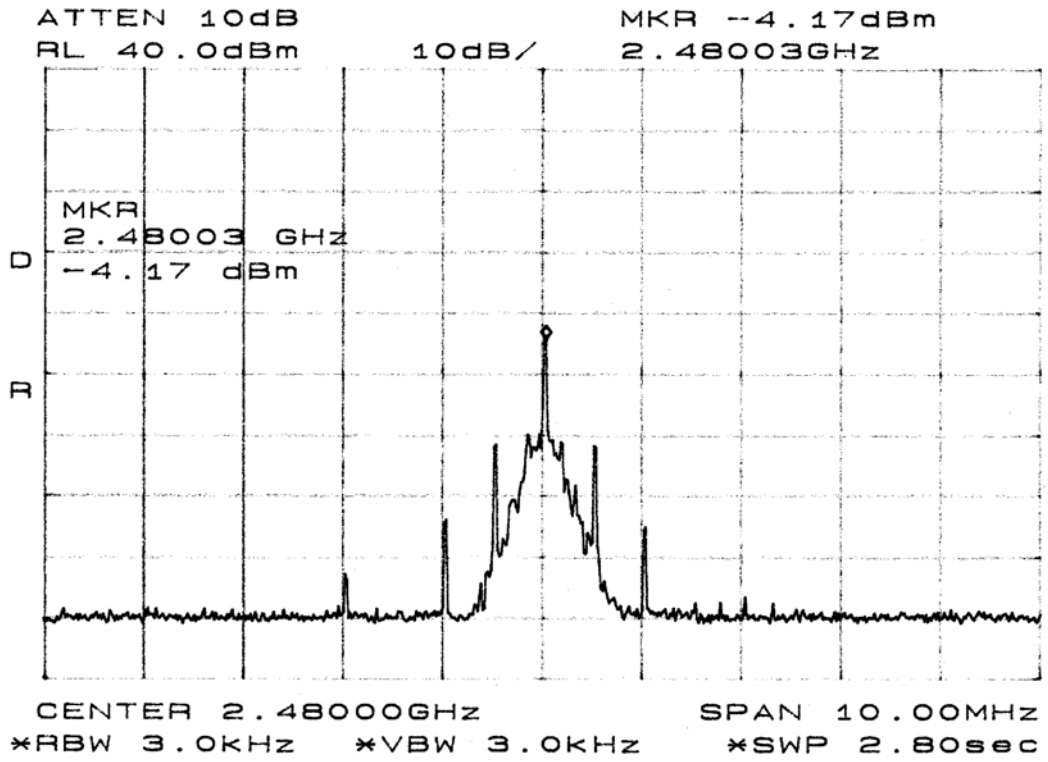

12.DEVIATION TO TEST SPECIFICATIONS

【NONE】

13.PHOTOGRAPHS

13.1.Photos of Conducted Emission Measurement



FRONT VIEW OF CONDUCTED MEASUREMENT



BACK VIEW OF CONDUCTED MEASUREMENT

13.2.Photos of Radiated Measurement at Semi-Anechoic Chamber

13.2.1. 30-1000MHz Frequency Range (Transmitting & Receiving Mode)

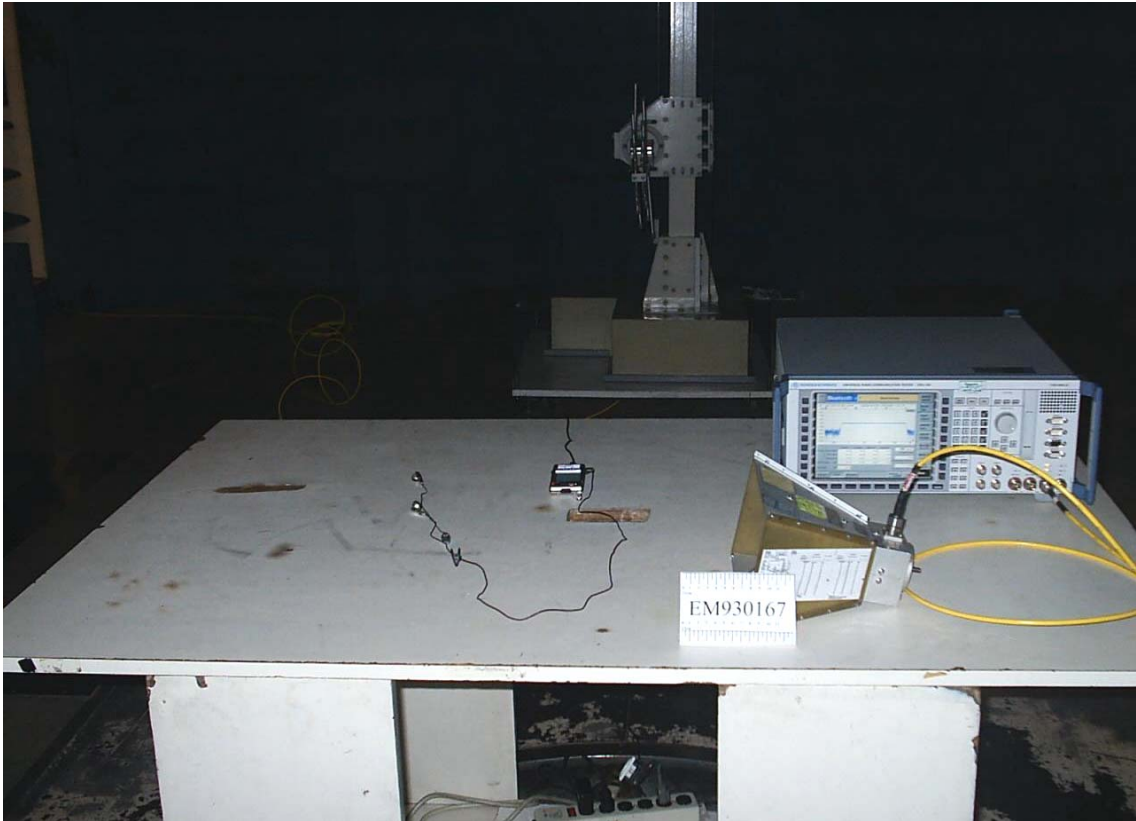

FRONT VIEW OF RADIATED MEASUREMENT

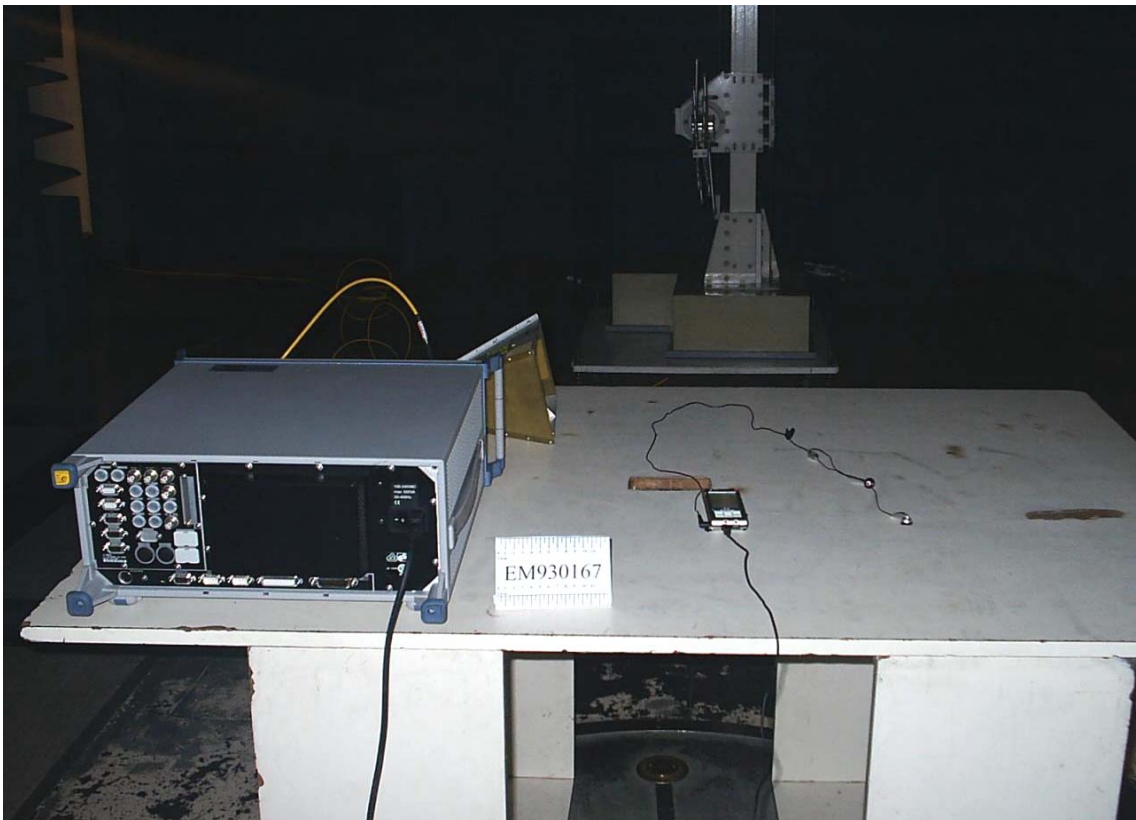

BACK VIEW OF RADIATED MEASUREMENT

13.2.2. 1-18GHz Frequency Range (Transmitting & Receiving Mode)



FRONT VIEW OF RADIATED MEASUREMENT

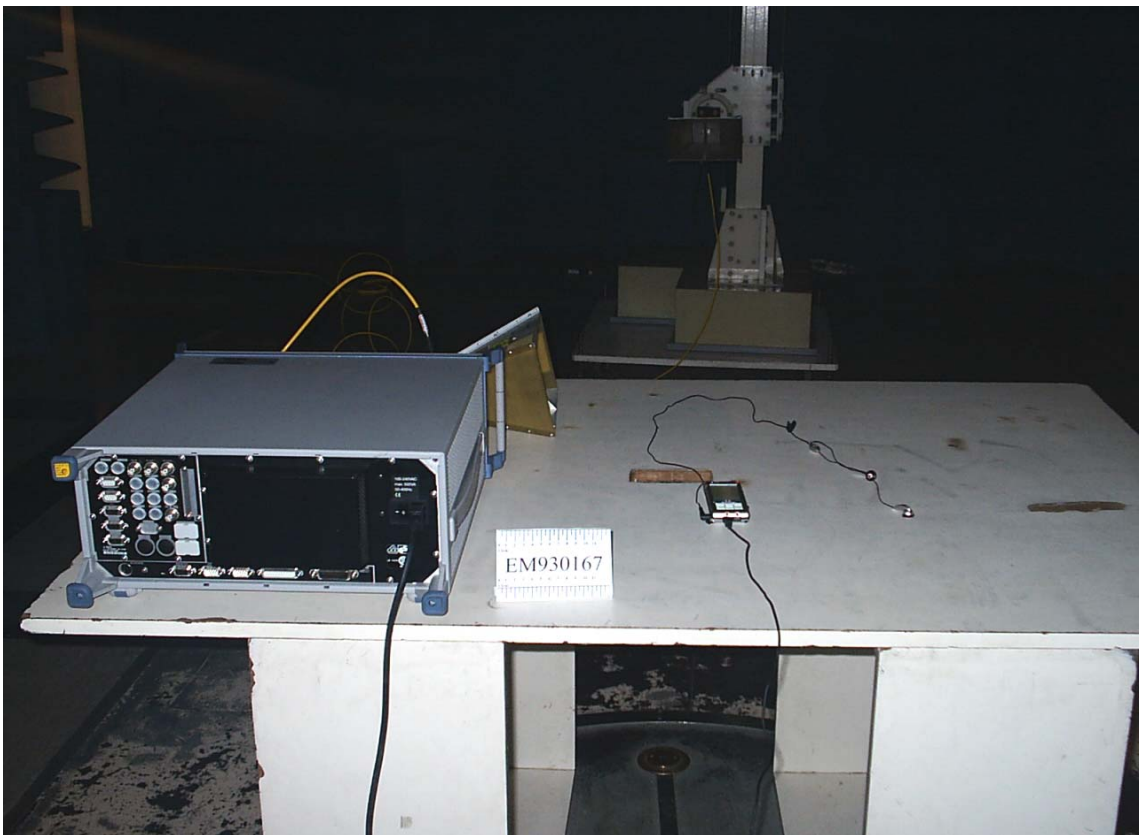

BACK VIEW OF RADIATED MEASUREMENT

13.2.3. 30-1000MHz Frequency Range (USB Link to PC)



FRONT VIEW OF RADIATED MEASUREMENT



BACK VIEW OF RADIATED MEASUREMENT

13.3.Photos of Measurement for Section 4 ~ 11

