

SUPPLEMENTARY: FCC ID JVP56W10

APPLICATION FOR CERTIFICATION

On Behalf of

BENQ Corporation

GPRS with Wireless LAN PC Card

Model : 56W10 (W10)

Brand : BenQ

Prepared for : BENQ Corporation
157, Shan-Ying Road, Gueishan,
Taoyuan 333, Taiwan, R.O.C.

Prepared by : Audix Corporation
No. 53-11, Tin-Fu Tsun, Lin-Kou,
Taipei Hsien, Taiwan, R.O.C.

Tel : (02) 2609-9301, 2609-2133
Fax: (02) 2609-9303

File Number : EM-G920336
Report Number : TTEMC-F92213
Date of Test : Apr. 10 ~ Nov. 11, 2003
Date of Report : Nov. 20, 2003

TABLE OF CONTENTS

Description	Page
TEST REPORT CERTIFICATION	3
1. GENERAL INFORMATION	4
1.1. Description of Device (EUT).....	4
1.2. Tested Supporting System Details.....	5
1.3. Description of Test Facility.....	6
1.4. Measurement Uncertainty.....	6
2. CONDUCTED EMISSION TEST	7
2.1. Test Equipment.....	7
2.2. Block Diagram of Test Setup.....	7
2.3. Conducted Emission Limits (§15.207).....	7
2.4. Operating Condition of EUT.....	8
2.5. Test Procedure.....	8
2.6. Test Results.....	9
3. RADIATED EMISSION MEASUREMENT	13
3.1. Test Equipment.....	13
3.2. Test Setup.....	13
3.3. Radiated Emission Limits (§15.209).....	14
3.4. Operating Condition of EUT.....	14
3.5. Test Procedure.....	15
3.6. Test Results.....	16
4. 6dB BANDWIDTH MEASUREMENT	21
4.1. Test Equipment.....	21
4.2. Block Diagram of Test Setup.....	21
4.3. Specification Limits (§15.247(a)(2)).....	21
4.4. Operating Condition of EUT.....	21
4.5. Test Procedure.....	21
4.6. Test Results.....	21
5. MAXIMUM PEAK OUTPUT POWER MEASUREMENT	24
5.1. Test Equipment.....	24
5.2. Block Diagram of Test Setup.....	24
5.3. Specification Limits (§15.247(b)-(3)).....	24
5.4. Operating Condition of EUT.....	24
5.5. Test Procedure.....	24
5.6. Test Results.....	25
6. BAND EDGES MEASUREMENT	26
6.1. Test Equipment.....	26
6.2. Block Diagram of Test Setup.....	26
6.3. Specification Limits (§15.247(c)).....	26
6.4. Operating Condition of EUT.....	26
6.5. Test Procedure.....	26
6.6. Test Results.....	26
7. POWER SPECTRAL DENSITY MEASUREMENT	28
7.1. Test Equipment.....	28
7.2. Block Diagram of Test Setup.....	28
7.3. Specification Limits (§15.247(d)).....	28
7.4. Operating Condition of EUT.....	28
7.5. Test Procedure.....	28
7.6. Test Results.....	28
8. DEVIATION TO TEST SPECIFICATIONS	31
9. PHOTOGRAPHS	32
9.1. Photos of Conducted Emission Measurement.....	32
9.2. Photos of Radiated Measurement at Semi-Anechoic Chamber.....	33
9.3. Photos of Measurement for Section 4, 6 ~ 7.....	35

TEST REPORT CERTIFICATION

Applicant : BENQ Corporation
 Manufacturer #1 : BENQ Corporation
 Manufacturer #2 : BENQ Electronics (Suzhou) Co. Ltd.
 EUT Description : GPRS with Wireless LAN PC Card
 (A) PRODUCT NAME. : 56W10
 (B) MODEL NO. : 56W10 (W10)
 (C) SERIAL NO. : N/A
 (D) POWER SUPPLY : DC 5V (via Notebook)

Measurement Procedure Used:

FCC RULES AND REGULATIONS PART 15 SUBPART C, MAY 2002
 AND ANSI C63.4/1992
 (FCC CFR 47 Part 15C, §15.207 , §15.209 and §15.247)

The device described above was tested by Audix Corporation to determine the maximum emission levels emanating from the device. The maximum emission levels were compared to the FCC Part 15 subpart C limits both radiated and conducted emissions.

The measurement results are contained in this test report and Audix Corporation is assumed full responsibility for the accuracy and completeness of these measurements. Also, this report shows that the EUT to be technically compliant with the FCC official limits.

This report applies to above tested sample only. This report shall not be reproduced in part without written approval of Audix Corporation.

Date of Test : Apr. 10 ~ Nov. 11, 2003

Prepared by : Monica Chang Nov. 20, 2003
 (Monica Chang/Assistant)

Test Engineer : Ben Cheng Nov. 20, 2003
 (Ben Cheng/Assistant Manager)

Approve & Authorized Signer : Leon Liu Nov. 20 2003
 (Leon Liu/Manager)

1. GENERAL INFORMATION

1.1. Description of Device (EUT)

Description : GPRS with Wireless LAN PC Card

Product Name : 56W10

Model Number : 56W10 (W10)

Applicant : BENQ Corporation
157, Shan-Ying Road, Gueishan, Taoyuan 333,
Taiwan, R.O.C.

Manufacturer #1 : BENQ Corporation
157, Shan-Ying Road, Gueishan, Taoyuan 333,
Taiwan.

Manufacturer #2 : BENQ Electronics (Suzhou) Co. Ltd.
No. 169, Zhujiang Road, New District, Suzhou,
Jiangsu, P.R., China

Radio Technology : DSSS

Fundamental Range : 2412MHz ~ 2462MHz

Number of Channel : 11

Channel	Frequency	Channel	Frequency
1	2412 MHz	8	2447 MHz
2	2417 MHz	9	2452 MHz
3	2422 MHz	10	2457 MHz
4	2427 MHz	11	2462 MHz
5	2432 MHz		
6	2437 MHz		
7	2442 MHz		

Bandwidth of Each Channel : 5MHz

Transfer Rate : 1/2/5.5/11Mbps

Power Supply : DC 5V (Via Notebook)

Antenna Gain : 1.3dBi

Date of Receipt of Sample : Apr. 10, 2003

Date of Test : Apr. 10 ~ Nov. 11, 2003

Remark:

Antenna requirement: This EUT's transmitter antenna is design in soldered to a printed circuit board, comply with §15.203 and inform to user that any change and modify is prohibited.

1.2. Tested Supporting System Details

1.2.1. NOTEBOOK PC

Model Number : L1400 Series

Serial Number : 2309620042

FCC ID : By DoC

BSMI ID : 41015024

Brand : ASUS

EUT : BENQ Corporation, M/N 56W10 (W10)

Adapter : Delta, M/N ADP-50SB, S/N K0W0203008390
BSMI ID 3882A525
Non-Shielded, Undetachable, 1.8m

Power Cord : Non-Shielded, Detachable, 1.8m

1.2.2. PRINTER

Model Number : KX-P2135

Serial Number : 8DMCN02139

FCC ID : ACJ5Z6KX-P2135

BSMI ID : 3872A371

Manufacturer : Matsushita

Data Cable : Shielded, Detachable, 1.2m

Power Cord : Non-Shielded, Detachable, 1.8m

1.2.3. USB KEYBOARD

Model Number : KU-8933

Serial Number : 8H17800115

FCC ID : By DoC

Manufacturer : Chicony Electronics Co., Ltd.

Data Cable : Shielded, Undetachable, 1.8m

1.2.4.USB MOUSE

Model Number : MINI 801 USB
 Serial Number : CE2300400429
 FCC ID : By DoC
 BSMI ID : 3892B623
 Manufacturer : Lemel
 Data Cable : Shielded, Undetachable, 1.0m

1.2.5.HANDSFREE

Model Number : SQ-10911-12
 Manufacturer : Phihong
 Data Cable : Non-shielded, Detachable, 1.2m

1.3.Description of Test Facility

Semi-Anechoic Chamber : May 16, 2000 Re-file on
 Description Federal Communication Commission
 Registration Number: 90993

Name of Firm : Audix Corporation

Site Location #1 : No. 53-11, Tin-Fu Tsun, Lin-Kou,
 Taipei Hsien, Taiwan, R.O.C.

Site Location #2 : No. 67-4, Tin-Fu Tsun, Lin-Kou,
 Taipei Hsien, Taiwan, R.O.C.

NVLAP Lab Code : 200077-0

1.4.Measurement Uncertainty

Test Item	Frequency Range	Uncertainty (dB)
Conduction Test	150kHz~30MHz	±2.66dB
Radiation Test (Distance: 3m)	30MHz~300MHz	+4.26dB / -4.22dB
	300MHz~1000MHz	+5.28dB / -4.0dB

Remark : Uncertainty = $ku_c(y)$

2. CONDUCTED EMISSION TEST

2.1. Test Equipment

The following test equipment was used during the conducted emission measurement :

Item	Type	Manufacturer	Model No.	Serial No.	Last Cal.	Next Cal.
1.	Test Receiver	Rohde & Schwarz	ESH3	893044/015	Jul. 08, 02'	Jul. 07, 03'
2.	L.I.S.N. # 1	Kyoritsu	KNW-407	8-881-13	Apr. 25, 02'	Apr. 24, 03'
3.	L.I.S.N. # 2	Kyoritsu	KNW-407	8-855-9	Apr. 25, 02'	Apr. 24, 03'
4.	Pulse Limiter	Rohde & Schwarz	ESH3-Z2	002	Aug. 21, 02'	Aug. 20, 03'

2.2. Block Diagram of Test Setup

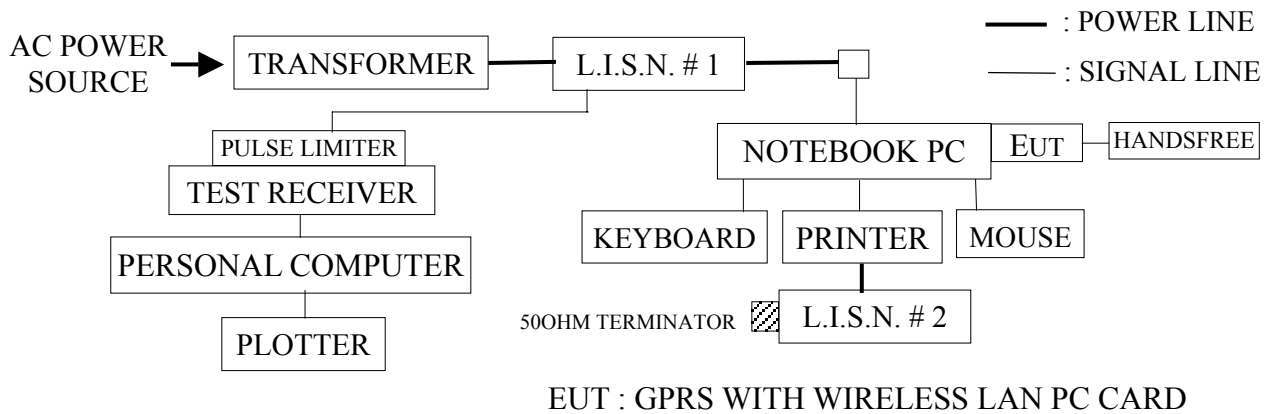

2.3. Conducted Emission Limits (§15.207)

Frequency	Maximum RF Line Voltage	
	Quasi-Peak Level	Average Level
150KHz ~ 500KHz	66 ~ 56 dB μ V	56 ~ 46 dB μ V
500KHz ~ 5MHz	56 dB μ V	46 dB μ V
5MHz ~ 30MHz	60 dB μ V	50 dB μ V

2.4. Operating Condition of EUT

- 2.4.1. Setup the EUT and simulator as shown on 2.2.
- 2.4.2. Turned on the power of all equipment.
- 2.4.3. The software (test program: ZD Config) was used to enable the EUT to transmit and receive data at different channel frequency individually.

2.5. Test Procedure

The Notebook PC's power cord was connected to the power mains through a line impedance stabilization network (L.I.S.N. #1) and the other peripheral devices power cord were connected to the power mains through a line impedance stabilization network (L.I.S.N. #2) This provided a 50 ohm coupling impedance for the measuring equipment. (Please refer to the block diagram of the test setup and photographs.) Both sides of A.C. line were checked for maximum conducted interference. In order to find the maximum emission, the relative positions of equipment and all of the interface cables were changed according to FCC ANSI C63.4-1992 on conducted measurement.

The bandwidth of R&S Test Receiver ESH3 was set at 10kHz.

The frequency range from 150KHz to 30MHz was checked.

The Channel 1, 7 & 11 were done on conducted test, then selected the worst case (Channel 1) to read the Q.P. & Average value, all the test results are attached in section 2.6.

2.6. Test Results

PASSED. All emissions not reported below are too low against the prescribed limits.

Date of Test : Apr. 10, 2003 Temperature : 21°C

EUT : GPRS with Wireless LAN PC Card Humidity : 68%

Test Mode : Channel 1, Testing Voltage: AC 120V/60Hz

Frequency (MHz)	Factor dB	Reading (dBμV)		Measurement (dBμV)		Limits (dBμV)		Margin dB	
		Neutral				Q.P.	Average	Q.P.	Average
		Q.P.	Average	Q.P.	Average				
0.2098	0.4	42.7	*	43.1	*	63.2	53.2	20.1	*
0.2718	0.4	35.9	*	36.3	*	61.0	51.0	24.7	*
0.3379	0.4	27.6	*	28.0	*	59.2	49.2	31.2	*
0.4727	0.5	29.8	*	30.3	*	56.4	46.4	26.1	*
0.6016	0.5	26.4	*	26.9	*	56.0	46.0	29.1	*
1.0043	0.5	27.4	*	27.9	*	56.0	46.0	28.1	*

Frequency (MHz)	Factor dB	Reading (dBμV)		Measurement (dBμV)		Limits (dBμV)		Margin dB	
		Line				Q.P.	Average	Q.P.	Average
		Q.P.	Average	Q.P.	Average				
0.2085	0.4	43.7	*	44.1	*	63.2	53.2	19.1	*
0.2718	0.4	35.4	*	35.8	*	61.0	51.0	25.2	*
0.3399	0.4	34.8	*	35.2	*	59.2	49.2	24.0	*
0.4727	0.5	32.9	*	33.4	*	56.4	46.4	23.0	*
0.6735	0.5	30.4	*	30.9	*	56.0	46.0	25.1	*
1.0043	0.5	31.5	*	32.0	*	56.0	46.0	24.0	*

- Remark :
1. All readings are Quasi-Peak and Average values.
 2. Factor = Insertion Loss + Cable Loss
 3. Measurement = Factor + Reading
 4. "*" Above Q.P. values have met both limits, it's not necessary to measure with average detector.

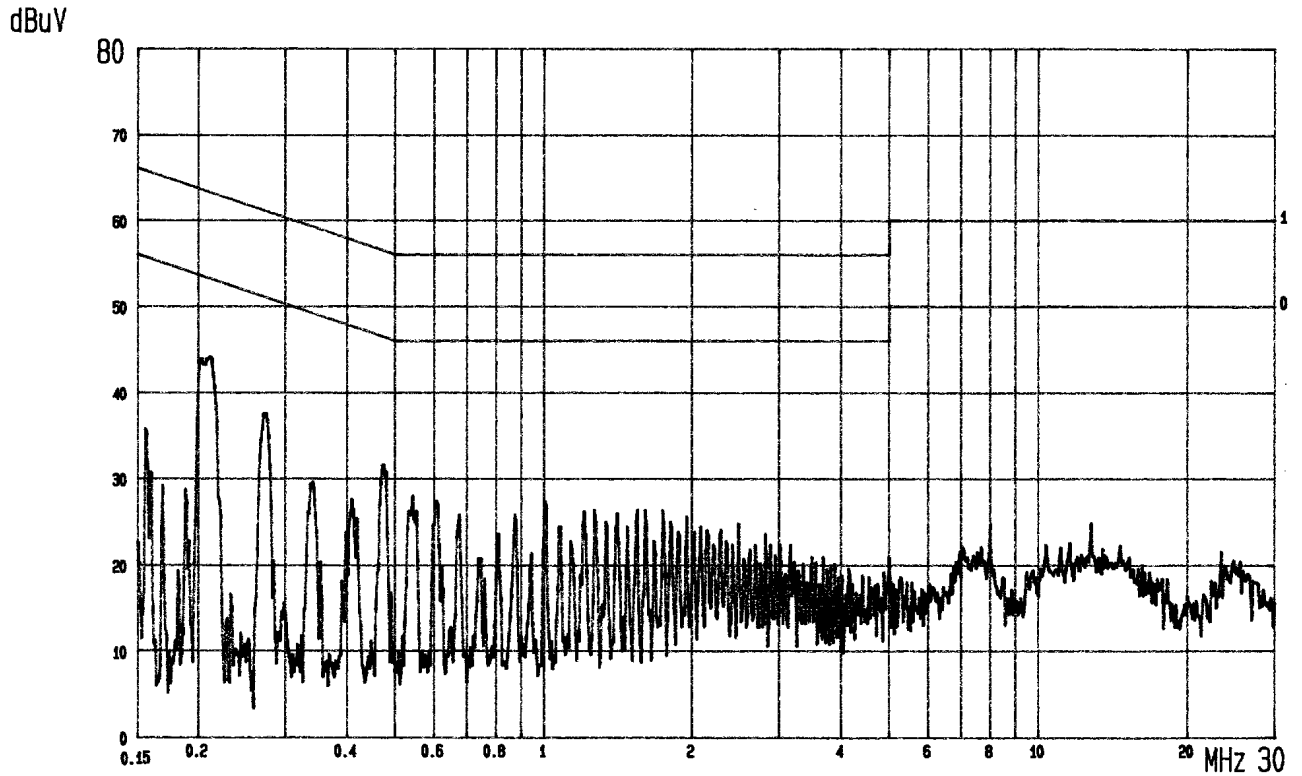

BENG
 LINE: Va
 EUT: GPRS WITH WIRELESS LAN PC CARD
 MEMO: CH: 1 (TX/RX)
 M/N: 56W10
 120V/60Hz PAGE: 01
 (PEAK VALUE) AUDIX

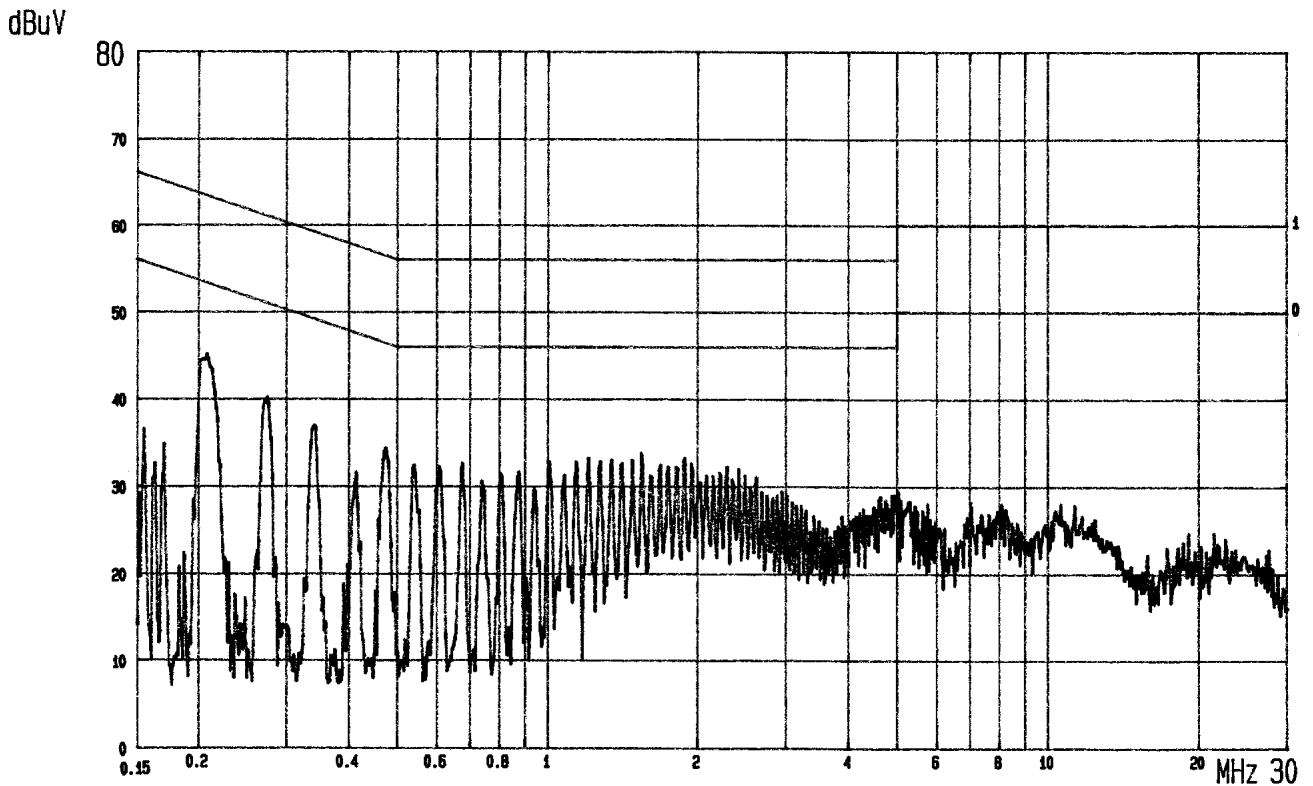

BENG
 LINE: Vb
 EUT: GPRS WITH WIRELESS LAN PC CARD
 MEMO: CH: 1 (TX/RX)
 M/N: 56W10
 120V/60Hz PAGE: 02
 (PEAK VALUE) AUDIX

dBuV

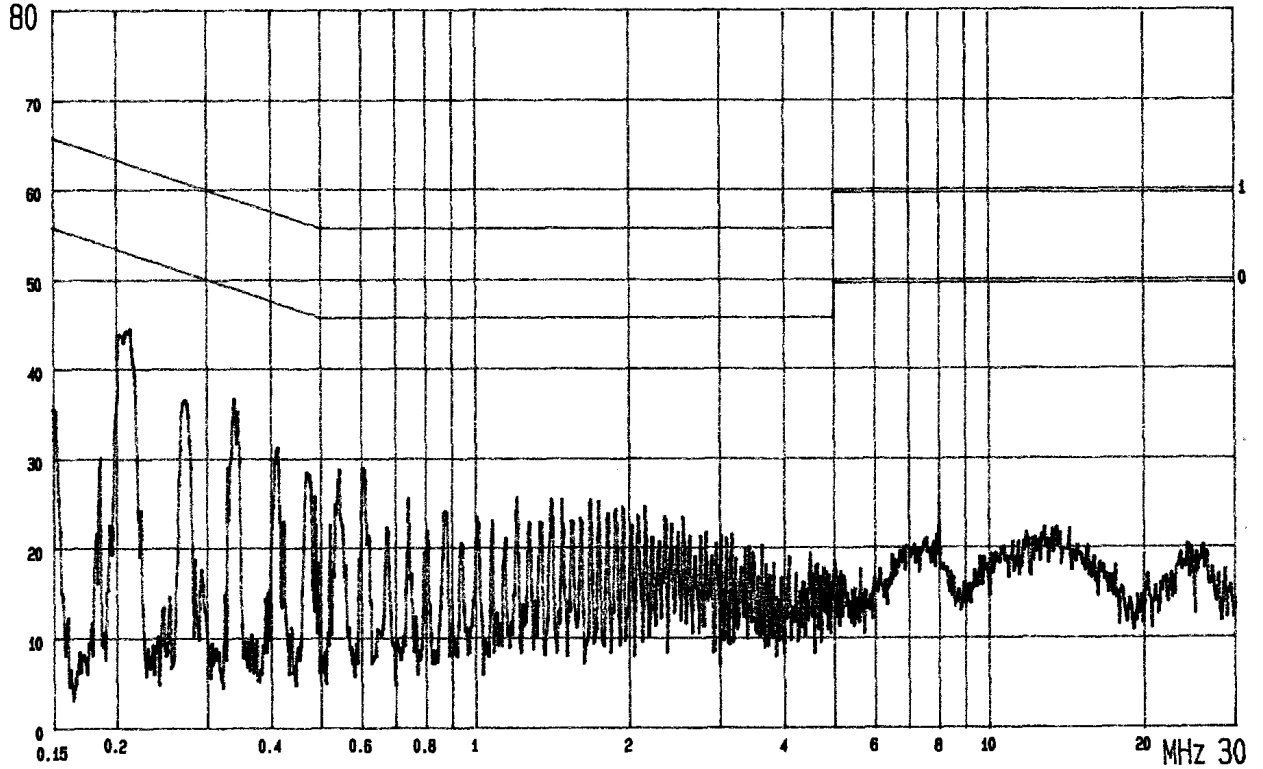

BENQ
LINE: Va

EUT: GPRS WITH WIRELESS LAN PC CARD
MEMO: CH: 7 (TX/RX)

M/N: 56W10

120V/60Hz PAGE: 01
(PEAK VALUE) AUDIX

dBuV

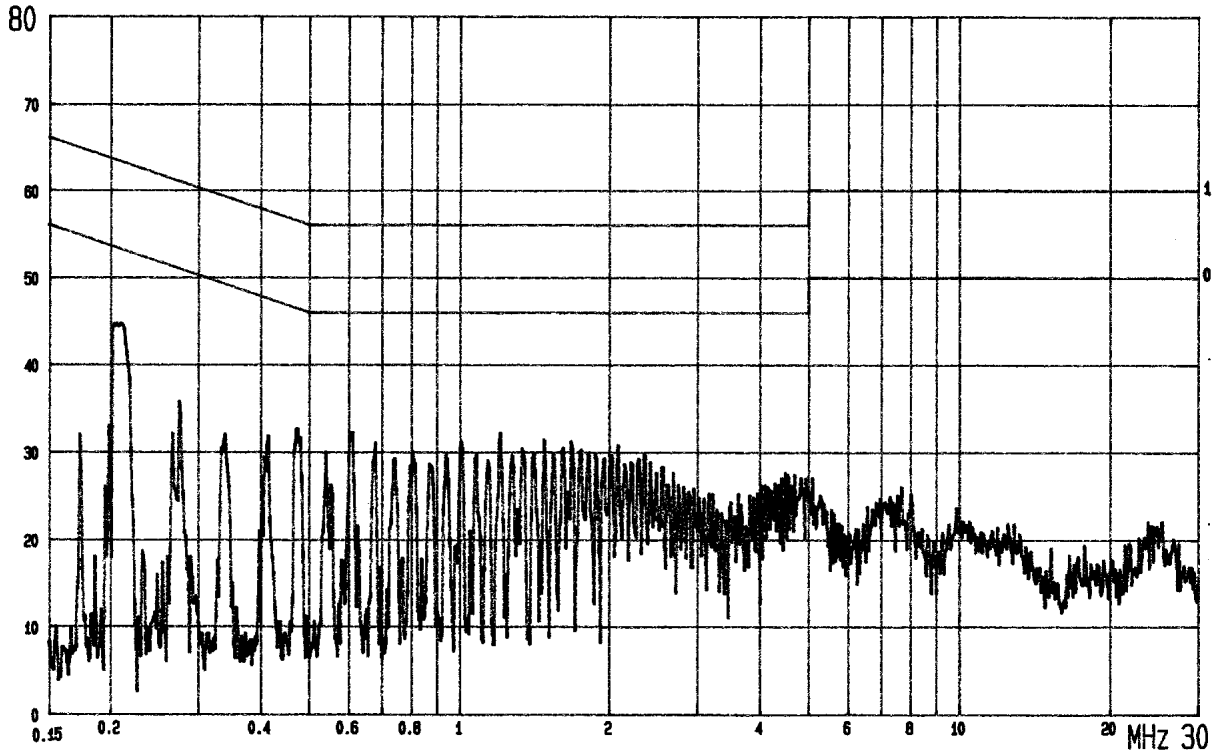

BENQ
LINE: Vb

EUT: GPRS WITH WIRELESS LAN PC CARD
MEMO: CH: 7 (TX/RX)

M/N: 56W10

120V/60Hz PAGE: 02
(PEAK VALUE) AUDIX

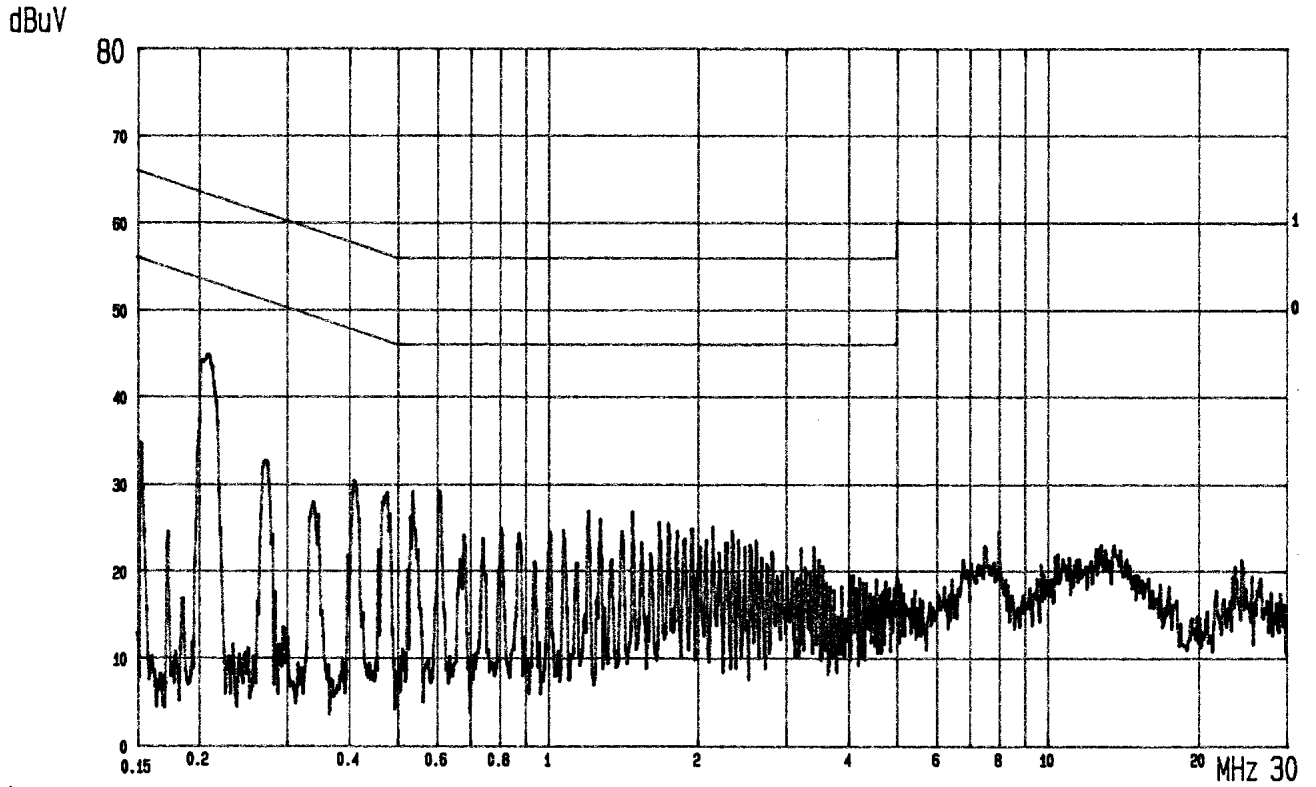

BENG
LINE: Va EUT: GPRS WITH WIRELESS LAN PC CARD M/N: 56W10 120V/60Hz PAGE: 01
MEMO: CH: 11 (TX/RX) (PEAK VALUE) AUDIX

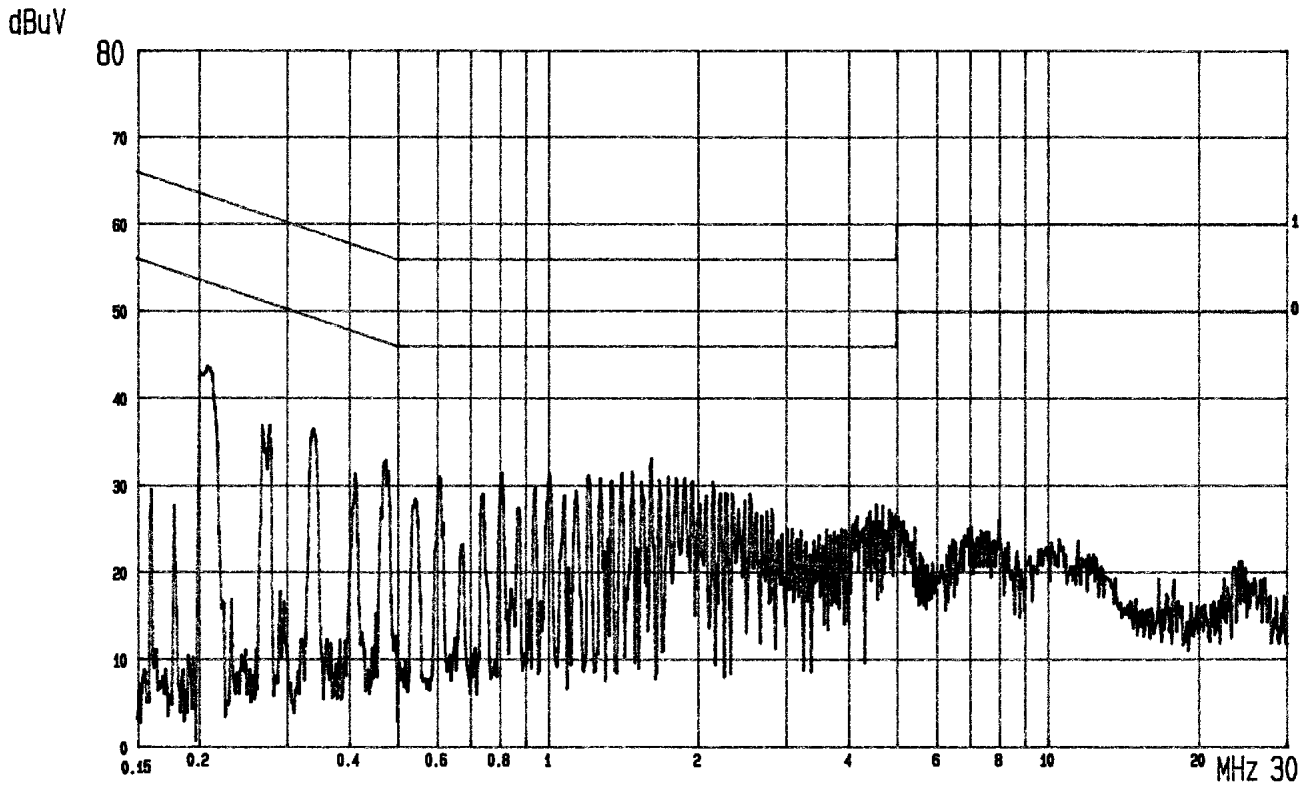

BENG
LINE: Vb EUT: GPRS WITH WIRELESS LAN PC CARD M/N: 56W10 120V/60Hz PAGE: 02
MEMO: CH: 11 (TX/RX) (PEAK VALUE) AUDIX

3. RADIATED EMISSION MEASUREMENT

3.1. Test Equipment

The following test equipment was used during the radiated emission measurement :

3.1.1.1. For 30MHz~1000MHz Frequency (at Semi-Anechoic Chamber)

Item	Type	Manufacturer	Model No.	Serial No.	Last Cal.	Next Cal.
1.	Spectrum Analyzer	HP	8593EM	3826A00248	Sep. 24, 03'	Sep. 23, 04'
2.	Test Receiver	R&S	ESVP	893202/001	Jul. 09, 03'	Jul. 08, 04'
3.	Pre-Amplifier	HP	8447D	2944A06305	Mar. 13, 03'	Mar. 12, 04'
4.	Broadband Antenna	Schwarzbeck	BBA 9106	A3L	Feb. 23, 03 ^c	Feb. 22, 04 ^c
5.	Broadband Antenna	Schwarzbeck	UHALP9108-A	0138	Feb. 23, 03 ^c	Feb. 22, 04 ^c

3.1.1.2. For Above 1GHz frequency (at Semi-Anechoic Chamber)

Item	Type	Manufacturer	Model No.	Serial No.	Last Cal.	Next Cal.
1.	Spectrum Analyzer	HP	8564EC	3946A00249	Aug. 27, 03'	Aug. 26, 04'
2.	Amplifier	HP	8449B	3008A00529	Jan. 04, 03'	Jan. 03, 04'
3.	Horn Antenna	EMCO	3115	9112-3775	Apr. 21, 03'	Apr. 20, 04'
4.	Horn Antenna	EMCO	3116	2653	Oct. 28, 03'	Oct. 27, 04'

3.2. Test Setup

3.2.1. Block Diagram of connection between EUT and simulators

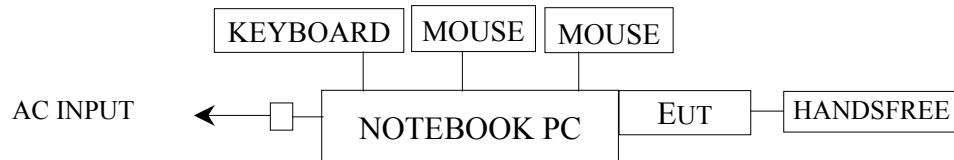

EUT : GPRS WITH WIRELESS LAN PC CARD

3.2.2.Semi-Anechoic Chamber (3m) Setup Diagram

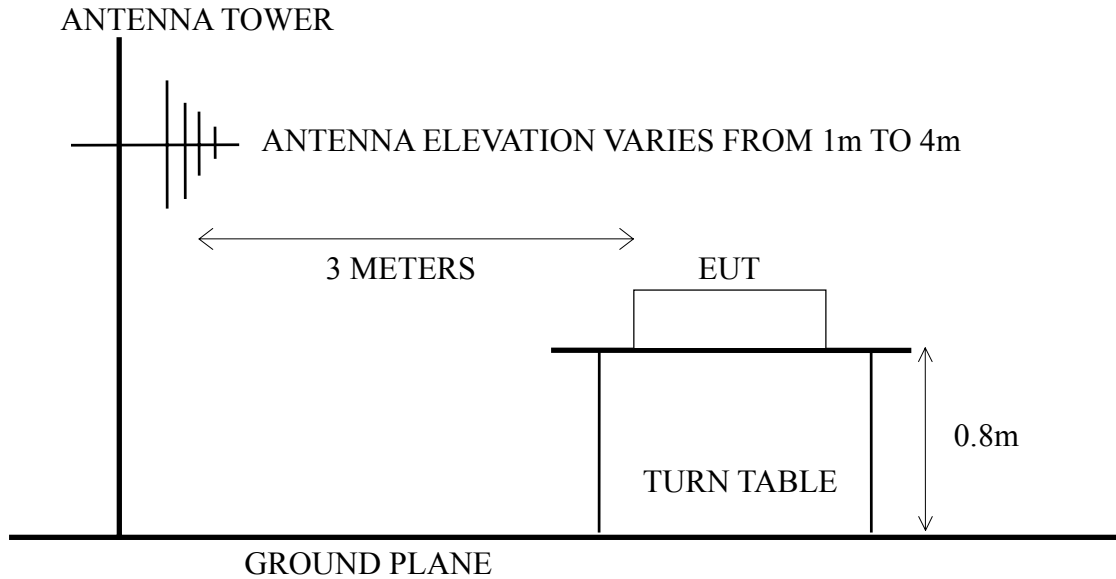

3.3.Radiated Emission Limits (§15.209)

FREQUENCY MHz	DISTANCE Meters	FIELD STRENGTHS LIMITS	
		$\mu\text{V/m}$	$\text{dB}\mu\text{V/m}$
30 ~ 88	3	100	40.0
88 ~ 216	3	150	43.5
216 ~ 960	3	200	46.0
Above 960	3	500	54.0
Above 1000	3	74.0 $\text{dB}\mu\text{V/m}$ (Peak) 54.0 $\text{dB}\mu\text{V/m}$ (Average)	

- Remark :
- (1) Emission level ($\text{dB}\mu\text{V/m}$) = $20 \log$ Emission level ($\mu\text{V/m}$)
 - (2) The tighter limit applies at the edge between two frequency bands.
 - (3) Distance refers to the distance in meters between the measuring instrument antenna and the closed point of any part of the device or system.

3.4.Operating Condition of EUT

Same as conducted measurement which is listed in Section 2.4.

3.5. Test Procedure

The EUT and its simulators were placed on a turn table which was 0.8 meter above the ground. The turn table rotated 360 degrees to determine the position of the maximum emission level. EUT was set 3 meters away from the receiving antenna which was mounted on a antenna tower. The antenna moved up and down between 1 to 4 meters to find out the maximum emission level. Broadband antenna such as calibrated biconical and log- periodical antenna or horn antenna were used as a receiving antenna. Both horizontal and vertical polarization of the antenna were set on measurement. In order to find the maximum emission, all of the interface cables were manipulated according to FCC ANSI C63.4-1992 regulation.

The bandwidth of the R&S Test Receiver ESVP was set at 120kHz.

The bandwidth of the HP Spectrum Analyzer 8564EC was set at 1MHz.

The Channel 1, 7 & 11 were done on radiated test for 30MHz ~ 1GHz, , all the test results are attached in section 3.6.1. The Channel 1, 7 & 11 were done on radiated test for above 1GHz, all the test results are listed in section 3.6.2.

3.6. Test Results

PASSED. All the emissions not reported below are too low against the official limits.

3.6.1. 30MHz to 1000MHz frequency.

Date of Test : Oct. 30, 2003 Temperature : 23°C

EUT : GPRS with Wireless LAN PC Card Humidity : 65%

Test Mode : Channel 1, Testing Voltage: AC 120V/60Hz

Emission Frequency MHz	Antenna Factor dB/m	Cable Loss dB	Meter Reading Horizontal dBμV	Emission Level Horizontal dBμV/m	Limits dBμV/m	Margin dB
133.410	19.50	2.40	13.83	35.73	43.50	7.77
233.040	23.98	3.30	7.66	34.94	46.00	11.06
297.840	26.78	3.98	1.77	32.53	46.00	13.47
366.500	16.70	4.50	17.89	39.09	46.00	6.91
393.800	16.90	4.70	13.29	34.89	46.00	11.11
917.400	23.10	7.40	5.29	35.79	46.00	10.21

Emission Frequency MHz	Antenna Factor dB/m	Cable Loss dB	Meter Reading Vertical dBμV	Emission Level Vertical dBμV/m	Limits dBμV/m	Margin dB
74.280	13.58	1.80	13.09	28.47	40.00	11.53
133.680	18.80	2.40	8.14	29.34	43.50	14.16
393.100	16.34	4.70	15.07	36.11	46.00	9.89
432.300	16.60	5.20	11.62	33.42	46.00	12.58
584.900	19.72	6.40	4.39	30.51	46.00	15.49
917.400	23.22	7.40	5.70	36.32	46.00	9.68

- Remark :
1. All readings are Quasi-Peak values.
 2. Emission Level= Antenna Factor + Cable Loss + Meter Reading.

Date of Test : Oct. 30, 2003 Temperature : 23°C
 EUT : GPRS with Wireless LAN PC Card Humidity : 65%
 Test Mode : Channel 7, Testing Voltage: AC 120V/60Hz

Emission Frequency MHz	Antenna Factor dB/m	Cable Loss dB	Meter Reading	Emission Level		Margin dB
			Horizontal dBμV	Horizontal dBμV/m	Limits dBμV/m	
133.680	19.50	2.40	11.58	33.48	43.50	10.02
297.840	26.78	3.98	5.94	36.70	46.00	9.30
367.200	16.70	4.42	15.45	36.57	46.00	9.43
397.300	16.84	4.79	14.22	35.85	46.00	10.15
432.300	17.20	5.20	14.32	36.72	46.00	9.28
911.100	23.10	7.40	4.51	35.01	46.00	10.99

Emission Frequency MHz	Antenna Factor dB/m	Cable Loss dB	Meter Reading	Emission Level		Margin dB
			Vertical dBμV	Vertical dBμV/m	Limits dBμV/m	
83.190	14.25	1.90	9.36	25.51	40.00	14.49
133.680	18.80	2.40	9.88	31.08	43.50	12.42
210.090	22.96	3.16	4.48	30.60	43.50	12.90
339.900	14.62	4.29	11.42	30.33	46.00	15.67
392.400	16.36	4.70	17.21	38.27	46.00	7.73
432.300	16.60	5.20	8.74	30.54	46.00	15.46

- Remark :
1. All readings are Quasi-Peak values.
 2. Emission Level= Antenna Factor + Cable Loss + Meter Reading.

Date of Test : Oct. 30, 2003 Temperature : 23°C
 EUT : GPRS with Wireless LAN PC Card Humidity : 65%
 Test Mode : Channel 11, Testing Voltage: AC 120V/60Hz

Emission Frequency MHz	Antenna Factor dB/m	Cable Loss dB	Meter Reading	Emission Level		Margin dB
			Horizontal dBμV	Horizontal dBμV/m	Limits dBμV/m	
133.410	19.50	2.40	11.59	33.49	43.50	10.01
297.300	26.70	4.00	1.82	32.52	46.00	13.48
367.900	16.70	4.46	17.24	38.40	46.00	7.60
393.800	16.90	4.70	15.31	36.91	46.00	9.09
432.300	17.20	5.20	12.42	34.82	46.00	11.18
917.400	23.10	7.40	4.80	35.30	46.00	10.70

Emission Frequency MHz	Antenna Factor dB/m	Cable Loss dB	Meter Reading	Emission Level		Margin dB
			Vertical dBμV	Vertical dBμV/m	Limits dBμV/m	
74.280	13.58	1.80	12.49	27.87	40.00	12.13
133.680	18.80	2.40	8.71	29.91	43.50	13.59
392.400	16.36	4.70	14.83	35.89	46.00	10.11
460.300	17.00	5.70	12.14	34.84	46.00	11.16
584.900	19.72	6.40	4.29	30.41	46.00	15.59
917.400	23.22	7.40	7.04	37.66	46.00	8.34

- Remark :
1. All readings are Quasi-Peak values.
 2. Emission Level= Antenna Factor + Cable Loss + Meter Reading.

3.6.2.Above 1GHz frequency

Date of Test : Apr. 16, 2003 Temperature : 22°C

EUT : GPRS with Wireless LAN PC Card Humidity : 68%

	Emission Frequency MHz	Antenna Factor dB/m	Cable Loss dB	Meter Reading Horizontal dBµV	Emission Level Horizontal dBµV/m	Limits dBµV/m	Margin dB

Channel 1 : TX: 2412MHz, RX: 2038MHz							
Peak	4824.581	33.61	9.14	2.97	45.72	74.00	28.28
	7236.870	36.75	11.25	2.04	50.04	74.00	23.96
Average	4824.581	33.61	9.14	-9.46	33.29	54.00	20.71
	7236.870	36.75	11.25	-13.24	34.76	54.00	19.24

Channel 7 : TX: 2442MHz, RX: 2068MHz							
Peak	4884.717	33.78	9.15	2.19	45.12	74.00	28.88
	7326.790	37.00	11.44	2.99	51.43	74.00	22.57
Average	4884.717	33.78	9.15	-9.62	33.31	54.00	20.69
	7326.790	37.00	11.44	-9.02	39.42	54.00	14.58

- Remark : 1. Emission Level = Antenna Factor + Cable Loss + Meter Reading.
 2. Measurement for TX/RX was up to 10th harmonics, but the emissions level were too low against the official limit and not report.
 3. Test Voltage: AC 120V/60Hz

Date of Test : Oct. 30, 2003 Temperature : 23°C

EUT : GPRS with Wireless LAN PC Card Humidity : 65%

	Emission Frequency MHz	Antenna Factor dB/m	Cable Loss dB	Meter Reading Horizontal dBµV	Emission Level Horizontal dBµV/m	Limits dBµV/m	Margin dB

Channel 11 : TX: 2462MHz, RX: 2088MHz							
Peak	4935.800	33.92	9.13	0.20	43.25	74.00	30.75
	7387.500	37.10	11.51	3.49	52.10	74.00	21.90
Average	4935.800	33.92	9.13	-6.28	36.77	54.00	17.23
	7387.500	37.10	11.51	-2.41	46.20	54.00	7.80

- Remark : 1. Emission Level = Antenna Factor + Cable Loss + Meter Reading.
 4. Measurement for TX/RX was up to 10th harmonics, but the emissions level were too low against the official limit and not report.
 5. Test Voltage: AC 120V/60Hz

Date of Test : Apr. 16, 2003 Temperature : 22°C

EUT : GPRS with Wireless LAN PC Card Humidity : 68%

	Emission Frequency MHz	Antenna Factor dB/m	Cable Loss dB	Meter Reading Vertical dBµV	Emission Level Vertical dBµV/m	Limits dBµV/m	Margin dB

Channel 1 : TX: 2412MHz, RX: 2038MHz							
Peak	4824.581	33.61	9.14	6.10	48.85	74.00	25.15
	7236.870	36.75	11.25	3.08	51.08	74.00	22.92
Average	4824.581	33.61	9.14	-6.86	35.89	54.00	18.11
	7236.870	36.75	11.25	-9.37	38.63	54.00	15.37

Channel 7 : TX: 2442MHz, RX: 2068MHz

Peak	4884.717	33.78	9.15	5.23	48.16	74.00	25.84
	7326.790	37.00	11.44	2.16	50.60	74.00	23.40
Average	4884.717	33.78	9.15	-8.38	34.55	54.00	19.45
	7326.790	37.00	11.44	-8.66	39.78	54.00	14.22

-
- Remark : 1. Emission Level = Antenna Factor + Cable Loss + Meter Reading.
 2. Measurement for TX/RX was up to 10th harmonics, but the emissions level were too low against the official limit and not report.
 3. Test Voltage: AC 120V/60Hz

Date of Test : Oct. 30, 2003 Temperature : 23°C

EUT : GPRS with Wireless LAN PC Card Humidity : 65%

	Emission Frequency MHz	Antenna Factor dB/m	Cable Loss dB	Meter Reading Vertical dBµV	Emission Level Vertical dBµV/m	Limits dBµV/m	Margin dB

Channel 11 : TX: 2462MHz, RX: 2088MHz							
Peak	4930.158	33.92	9.13	1.56	44.61	74.00	29.39
	7387.500	37.10	11.51	0.59	49.20	74.00	24.80
Average	4930.158	33.92	9.13	-4.88	38.17	54.00	15.83
	7387.500	37.10	11.51	-6.53	42.08	54.00	11.92

-
- Remark : 1. Emission Level = Antenna Factor + Cable Loss + Meter Reading.
 2. Measurement for TX/RX was up to 10th harmonics, but the emissions level were too low against the official limit and not report.
 3. Test Voltage: AC 120V/60Hz

4. 6dB BANDWIDTH MEASUREMENT

4.1. Test Equipment

The following test equipment was used during the Emission Bandwidth test :

Item	Type	Manufacturer	Model No.	Serial No.	Last Cal.	Next Cal.
1.	Spectrum Analyzer	HP	8564EC	3946A00249	Aug. 27, 03'	Aug. 26. 04'

4.2. Block Diagram of Test Setup



EUT : GPRS WITH WIRELESS LAN PC CARD

4.3. Specification Limits (§15.247(a)(2))

The minimum 6dB bandwidth shall be at least 500kHz.

4.4. Operating Condition of EUT

The software (ZD Config) was used to enable the EUT to transmit and receive data at different channel frequency individually.

4.5. Test Procedure

The transmitter output was connected to the spectrum analyzer. The bandwidth of the fundamental frequency was measure by spectrum analyzer with 100kHz RBW and 100kHz VBW. The 6dB bandwidth is defined as the total spectrum the power of which is higher than peak power minus 6dB.

4.6. Test Results

PASSED. The testing data was attached in the next pages.

(Test Date : Oct. 30, 2003 Temperature : 23°C Humidity : 64 %)

Channel	Frequency	6dB Bandwidth
1	2412MHz	8.80MHz
7	2442MHz	8.73MHz
11	2462MHz	9.13MHz

Channel : 1

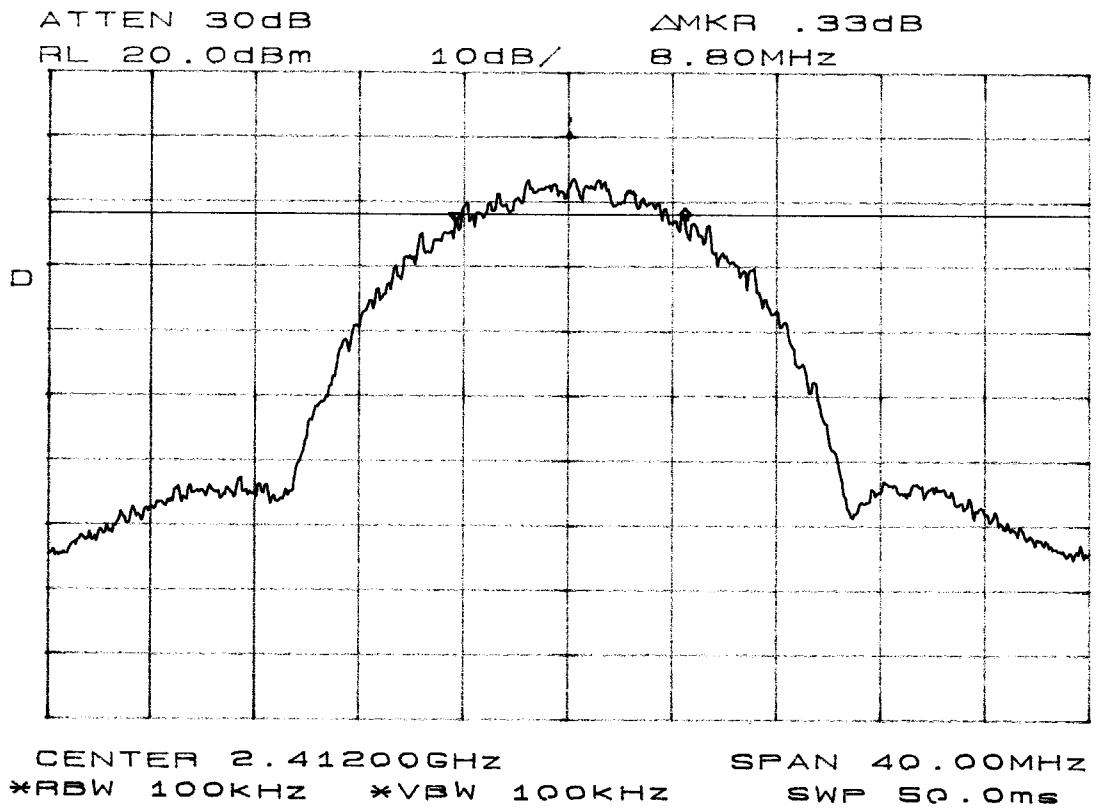

Channel : 7

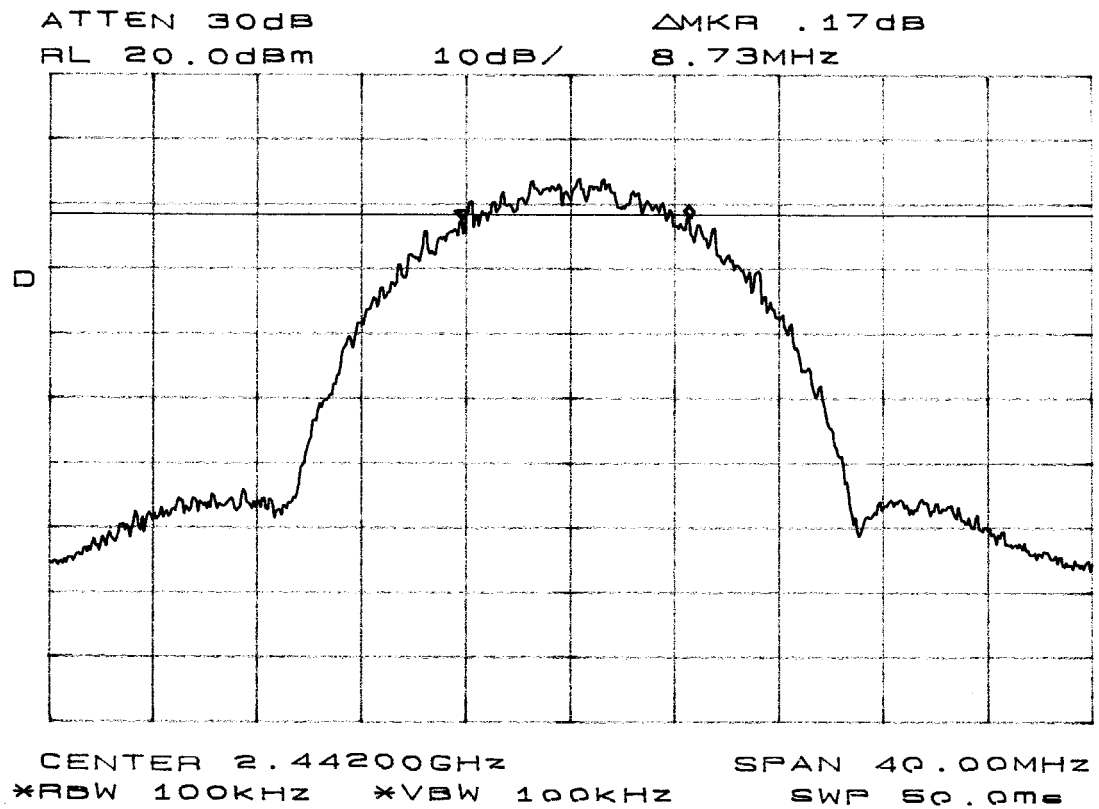

Channel : 11

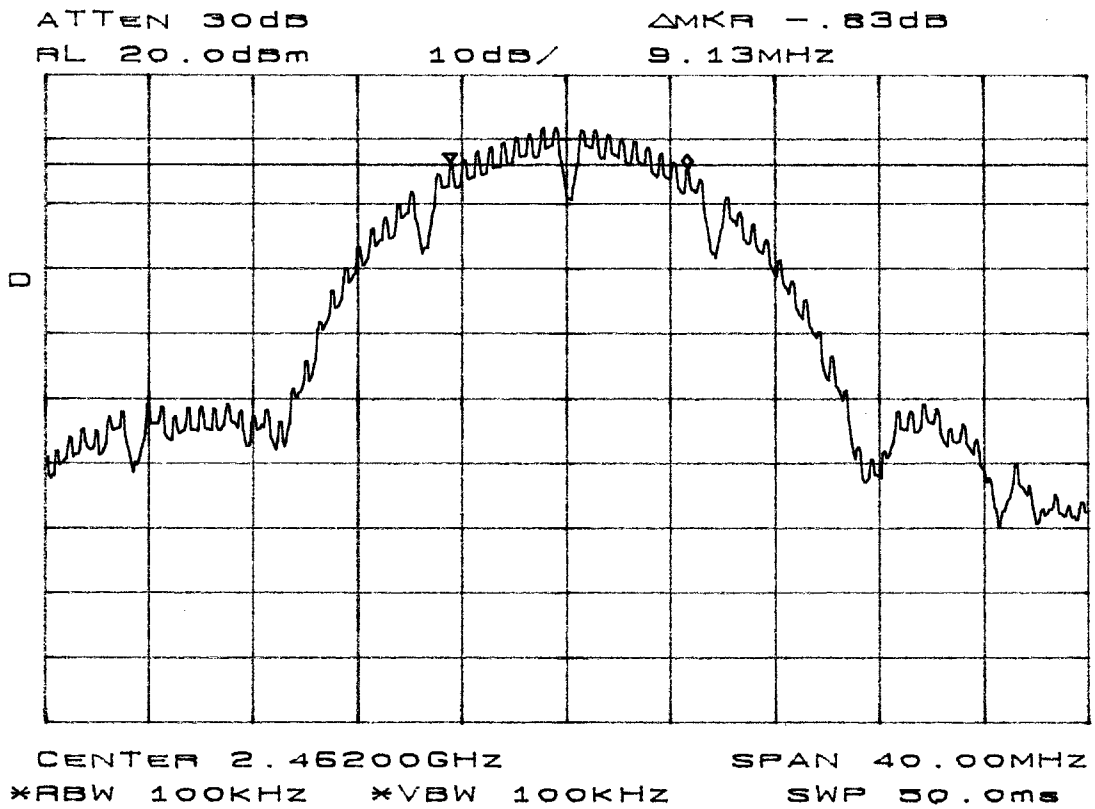

5. MAXIMUM PEAK OUTPUT POWER MEASUREMENT

5.1. Test Equipment

The following test equipment was used during the Emission Bandwidth test :

Item	Type	Manufacturer	Model No.	Serial No.	Last Cal.	Next Cal.
1.	Power Meter	Anritsu	ML2488A	3946A00249	Nov. 03, 03'	Nov. 02, 04'
2.	Power Sensor	Anritsu	MA2491A	030541	Nov. 03, 03'	Nov. 02, 04'
3.	Attenuator	Anritsu	41KC-10	N/A	N/A	N/A

5.2. Block Diagram of Test Setup



EUT : GPRS WITH WIRELESS LAN PC CARD

5.3. Specification Limits (§15.247(b)-(3))

The Limits of maximum Peak Output Power for digital modulation in 2400-2483.5MHz is : 1Watt. (30dBm)

5.4. Operating Condition of EUT

The software (ZD Config) was used to enable the EUT to transmit and receive data at different channel frequency individually.

5.5. Test Procedure

The transmitter output was connected to the power meter that was designed to detect peak value automatically.

5.6. Test Results

PASSED. The testing data was attached in the next pages.

(Test Date : Nov. 11, 2003 Temperature : 21°C Humidity : 64 %)

Channel	Frequency	Peak Output Power	Limit
1	2412MHz	23.45dBm	30dBm
7	2442MHz	22.56dBm	30dBm
11	2462MHz	22.85dBm	30dBm

6. BAND EDGES MEASUREMENT

6.1. Test Equipment

The following test equipment was used during the Emission Bandwidth test :

Item	Type	Manufacturer	Model No.	Serial No.	Last Cal.	Next Cal.
1.	Spectrum Analyzer	HP	8564EC	3946A00249	Aug. 27, 03'	Aug. 26. 04'

6.2. Block Diagram of Test Setup



EUT : GPRS WITH WIRELESS LAN PC CARD

6.3. Specification Limits (§15.247(c))

The highest level should be at least 20 dB below that in the 100kHz bandwidth.

6.4. Operating Condition of EUT

The software (ZD Config) was used to enable the EUT to transmit and receive data at different channel frequency individually.

6.5. Test Procedure

The transmitter output was connected to the spectrum analyzer. Set both RBW and VBW of spectrum analyzer to 100kHz with suitable frequency span including 100kHz bandwidth from band edge.

6.6. Test Results

PASSED. The testing data was attached in the next pages.

(Test Date : Oct. 30, 2003 Temperature : 23°C Humidity : 64 %)

1. Below Band edge: The highest emission level is – 54.33dBm on 2.48350GHz ◦
2. Upper Band edge : The highest emission level is – 41.33dBm on 2.40020GHz ◦

ATTEN 30dB MKR -54.33dBm
 RL 20.0dBm 10dB/ 2.48350GHz

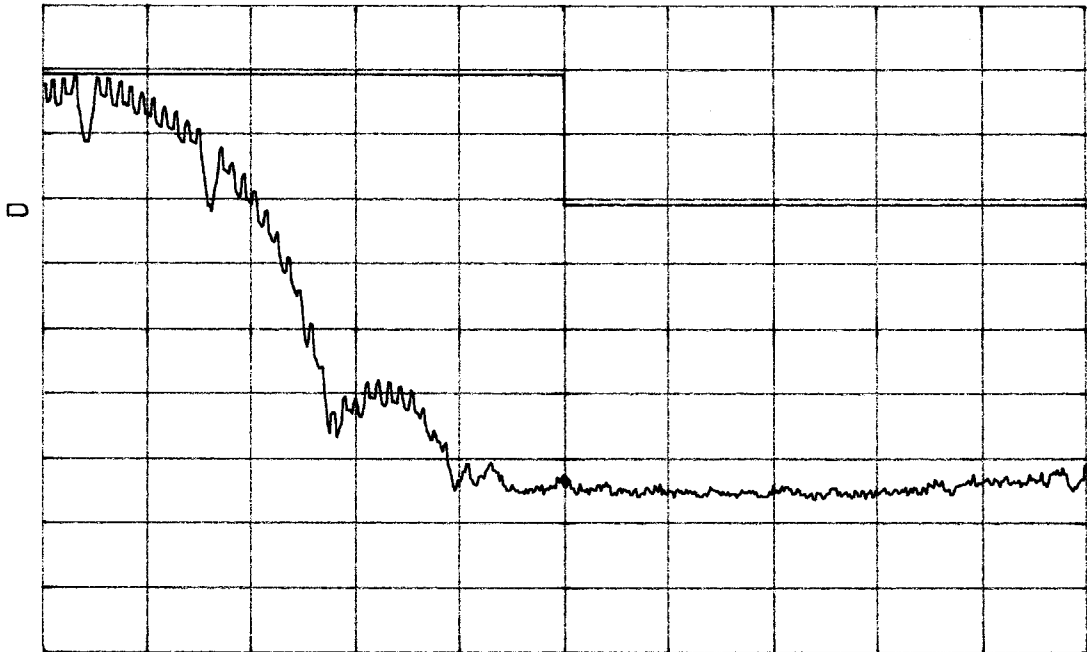

CENTER 2.48350GHz SPAN 46.95MHz
 *RBW 100kHz *VBW 100kHz SWP 50.0ms

ATTEN 30dB MKR -41.33dBm
 RL 20.0dBm 10dB/ 2.40020GHz

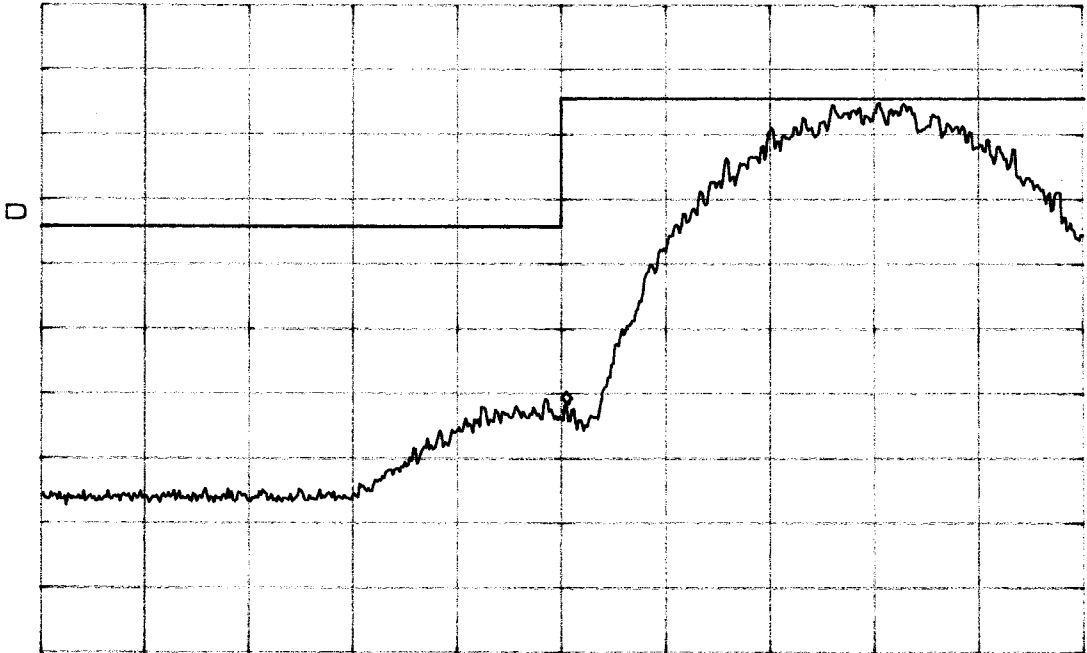

CENTER 2.40000GHz SPAN 40.00MHz
 *RBW 100kHz *VBW 100kHz SWP 50.0ms

7. POWER SPECTRAL DENSITY MEASUREMENT

7.1. Test Equipment

The following test equipment was used during the Emission Bandwidth test :

Item	Type	Manufacturer	Model No.	Serial No.	Last Cal.	Next Cal.
1.	Spectrum Analyzer	HP	8564EC	3946A00249	Aug. 27, 03'	Aug. 26. 04'

7.2. Block Diagram of Test Setup



EUT : GPRS WITH WIRELESS LAN PC CARD

7.3. Specification Limits (§15.247(d))

The peak power spectral density conducted from the intentional radiator to the antenna shall not be greater than 8dBm in any 3kHz band.

7.4. Operating Condition of EUT

The software (ZD Config) was used to enable the EUT to transmit and receive data at different channel frequency individually.

7.5. Test Procedure

The transmitter output was connected to the spectrum analyzer. The bandwidth of the fundamental frequency was measured with the spectrum analyzer using 3kHz RBW and 30kHz VBW, set sweep time = span/3kHz.

7.6. Test Results

PASSED. The testing data was attached in the next pages.

(Test Date : Oct. 30, 2003 Temperature : 23°C Humidity : 64 %)

Channel	Frequency	Power Spectral Density	Limit
1	2412MHz	-10.00dBm	8dBm
7	2442MHz	-10.17dBm	8dBm
11	2462MHz	-11.00dBm	8dBm

Channel : 11

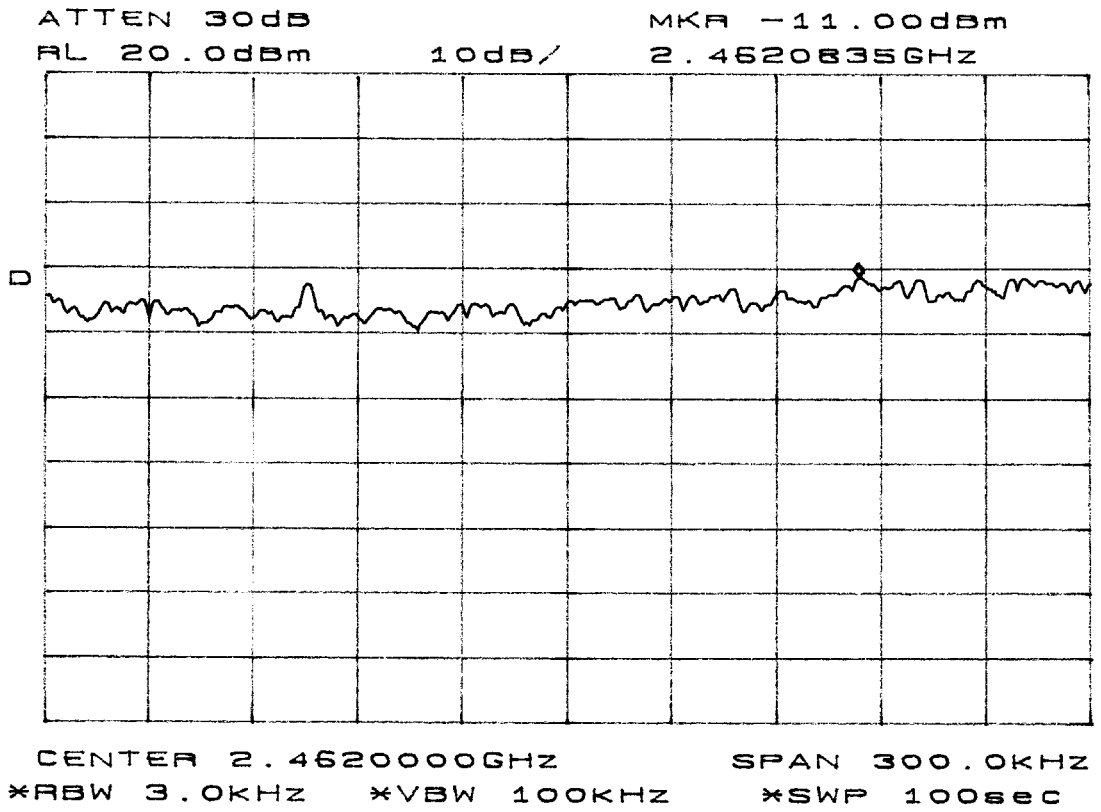

8. DEVIATION TO TEST SPECIFICATIONS

【NONE】

9. PHOTOGRAPHS

9.1.Photos of Conducted Emission Measurement



FRONT VIEW OF CONDUCTED TEST

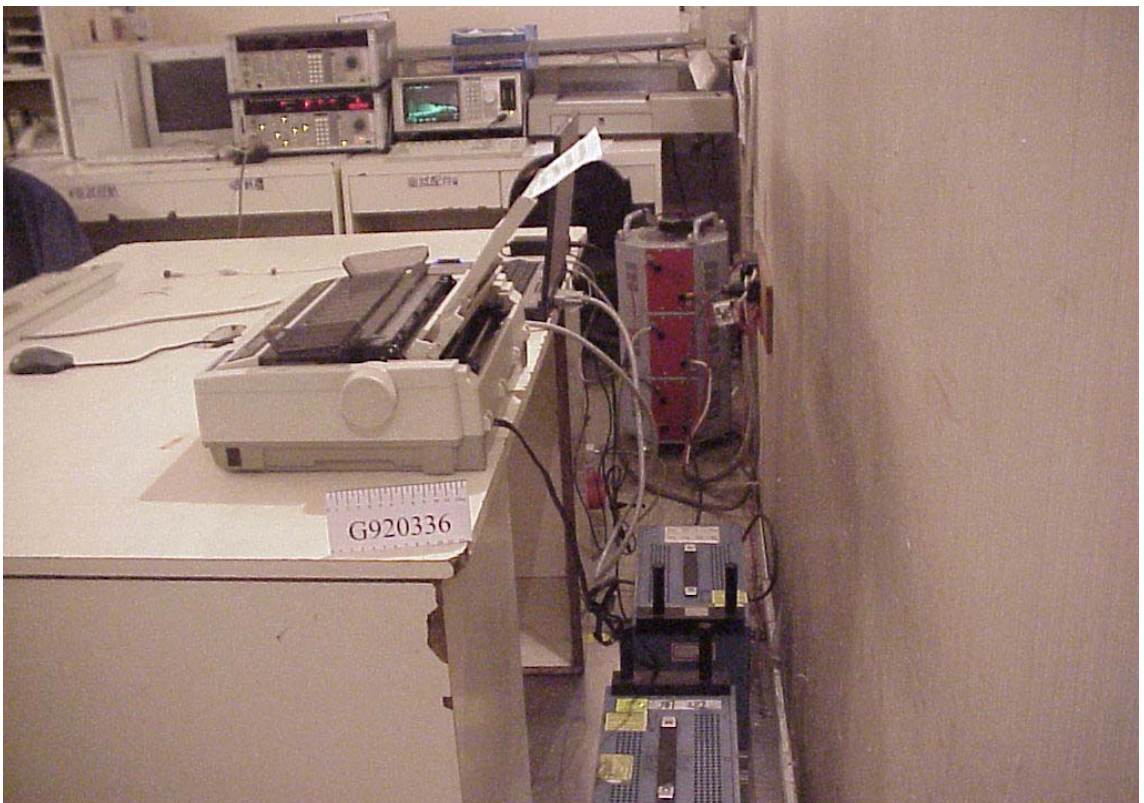

BACK VIEW OF CONDUCTED TEST

9.2.Photos of Radiated Measurement at Semi-Anechoic Chamber

9.2.1.30MHz to 1GHz frequency

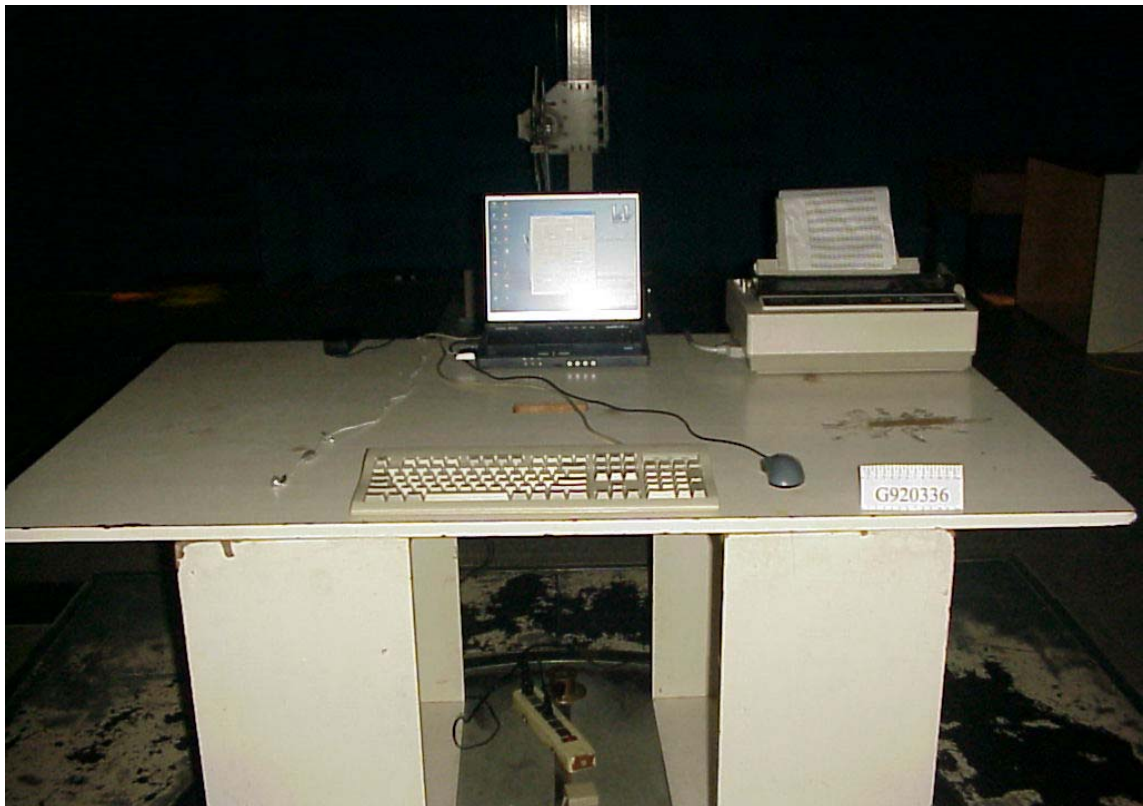

FRONT VIEW OF RADIATED TEST

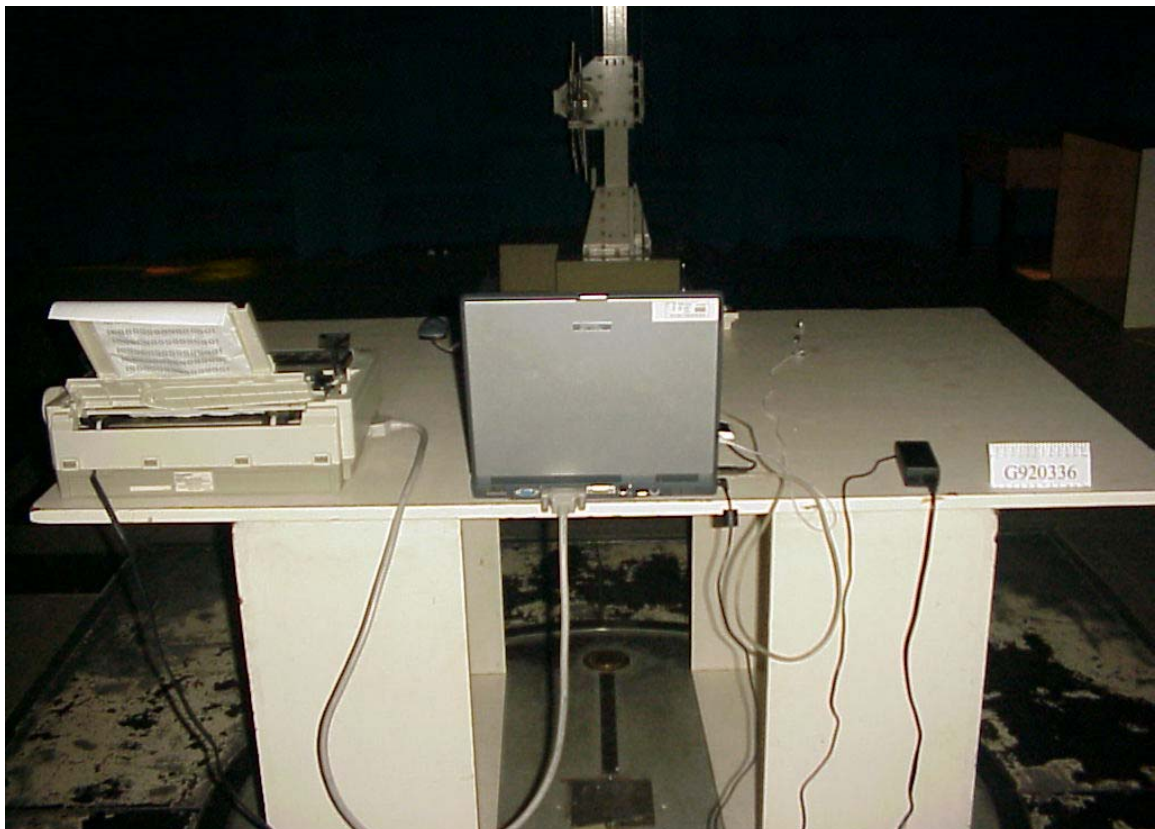

BACK VIEW OF RADIATED TEST

9.2.2.Above 1GHz frequency



FRONT VIEW OF RADIATED TEST

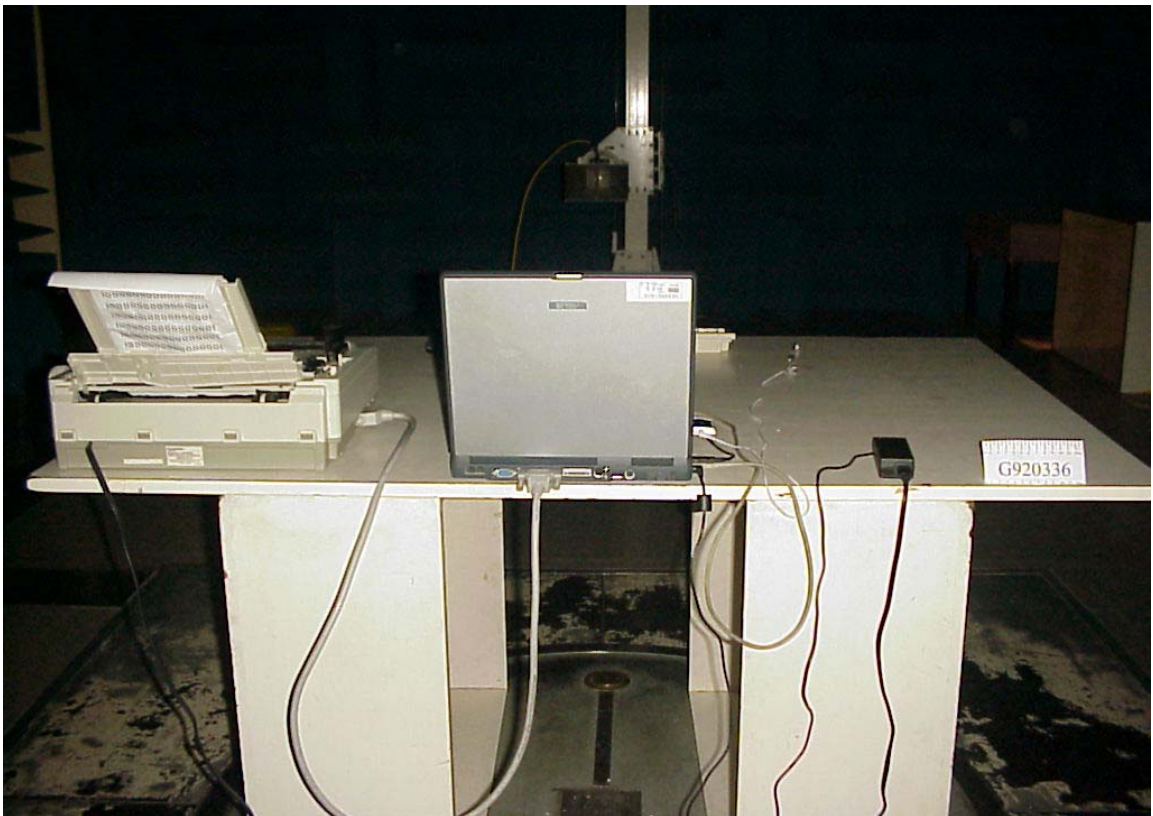

BACK VIEW OF RADIATED TEST

9.3.Photos of Measurement for Section 4, 6 ~ 7

