



Test Report

Product Name : GSM900/DCS1800 / PCS1900
GSM/GPRS Mobile Phone
Model No : 56E21(M350)
FCC ID : JVP56E21

Applicant : BenQ Corporation

Address : 157 Shan-Ying Road, Gueishan Taoyuan 333, Taiwan,
R.O.C.

Date of Receipt : 2005/02/24
Issued Date : 2005/03/17
Report No. : 052L113FI
Reference No. : KH-4570

The test results relate only to the samples tested.
The test report shall not be reproduced except in full without the written approval of Quietek Corporation.
This report must not be used to claim product endorsement by NVLAP any agency of the U.S. Government

Test Report Certification

Issued Date : 2005/03/17

Report No. : 052L113FI



Accredited by NIST (NVLAP)

NVLAP Lab Code: 200533-0

Product Name : GSM900/DCS1800 / PCS1900 GSM/GPRS Mobile Phone
Applicant : BenQ Corporation
Address : 157 Shan-Ying Road, Gueishan Taoyuan 333, Taiwan, R.O.C.
Manufacturer (1) : BenQ Corporation
Manufacturer (2) : BenQ China Co., Ltd.
Model No. : 56E21(M350)
Rated Voltage : AC 120V/60Hz
EUT Voltage : DC 3.7V (Battery)
Trade Name : BenQ
Measurement Standard : FCC CFR Title 47 Part 2 Part24
Measurement Reference : TIA/EIA 603-A
Test Result : Complied

Test results relate only to the samples tested.

The test report shall not be reproduced except in full without the written approval of Quietek Corporation.

This report must not be used to claim product endorsement by NVLAP any agency of the U.S. Government

Documented By : Rita Huang
(Rita Huang)

Tested By : Hsiu Ho
(Hsiu Ho)

Approved By : Gene Chang
(Gene Chang)

TABLE OF CONTENTS

Description	Page
1. GENERAL INFORMATION	4
1.1. EUT Description	4
1.2. Operational Description.....	4
1.3. Configuration of tested System	5
1.4. EUT Setup Procedures	5
1.5. Test Facility	6
1.6. Type of Emission	6
1.7. DC voltages and DC currents	6
2. Peak Power Output	7
2.1. Test Equipment.....	7
2.2. Test Setup	7
2.3. Limits	8
2.4. Test Procedure.....	8
2.5. Test Specification	8
2.6. Test Result of Peak Power Output	9
3. Modulation Characteristics	11
3.1. Test Equipment.....	11
3.2. Test Setup	11
3.3. Modulation Description.....	11
3.4. Test Specification	12
3.5. Test Result of Modulation	13
4. Occupied Bandwidth.....	14
4.1. Test Equipment.....	14
4.2. Test Setup	14
4.3. Test Procedure.....	14
4.4. Test Specification	15
4.5. Test Result of Occupied Bandwidth	16
5. Spurious Emission At Antenna Terminals (+/-1MHz)	19
5.1. Test Equipment.....	19
5.2. Setup	19
5.3. Limits	20
5.4. Test Procedure.....	20
5.5. Test Specification	20
5.6. Spurious Emission At Antenna Terminals (+/-1MHz)	21
6. Spurious Emission	23
6.1. Test Equipment.....	23
6.2. Test Setup	23
6.3. Limits	24
6.4. Test Procedure.....	24
6.5. Test Specification	25
6.6. Test Result of Spurious Emission	26
7. Frequency Stability Under Temperature & Voltage Variations	29
7.1. Test Equipment.....	29
7.2. Test Setup	29
7.3. Limits	29
7.4. Test Procedure.....	30
7.5. Test Specification	30
7.6. Test Result of Frequency Stability Under Temperature Variations	31
8. EMI Reduction Method During Compliance Testing	32
Attachment 1: EUT Test Photographs	
Attachment 2: EUT Detailed Photographs	

1. GENERAL INFORMATION

1.1. EUT Description

Product Name	GSM900/DCS1800 / PCS1900 GSM/GPRS Mobile Phone
Trade Name	BenQ
Model No.	56E21(M350)
IMEI No.	355594-00-0002009
Antenna Type	Internal
TX Frequency	1850MHz ~ 1910MHz(PCS1900)
Rx Frequency	1930MHz ~ 1990MHz(PCS1900)
Hardware version	LPR3-3-A
Software version	0.010
Battery Pack	P/N: 23.2G940.001 3.7V 740mAh
USB Cable	P/N: 50.G5301.011
Power Adapter	MFR: BenQ M/N: MP20 DATE CODE:0449 AC Input: 100-240V~50-60Hz 300mA Output: 6V-500mA 3W Cable in: Non-Shielded,1.8m

1.2. Operational Description

The information contained within this report is intended to show verification of compliance of the 1900MHz Mobile Phone to the requirements of 47CFR2 and CFR 24.

The EUT operates from a 120Vac/60Hz adapter where GSM is Power Class 1, operating with a maximum output power of 1 watt and GPRS is Multislot Class 10.

Quietek has verified the construction and function in typical operation. All the test modes were carried out with the EUT in normal operation, which was shown in this test report and defined as:

Test Mode:	PCS1900 GSM
	PCS1900 GPRS

1.3. Configuration of tested System

(a) Configuration of Radiated measurement

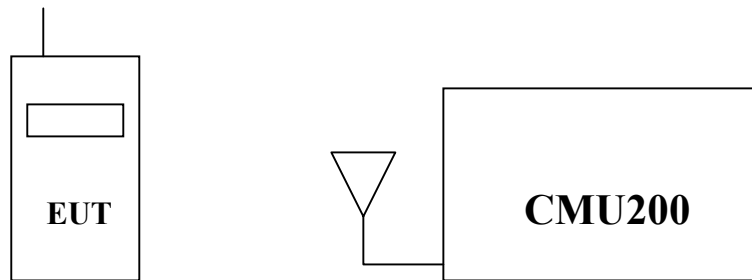

(b) Configuration of Conducted measurement

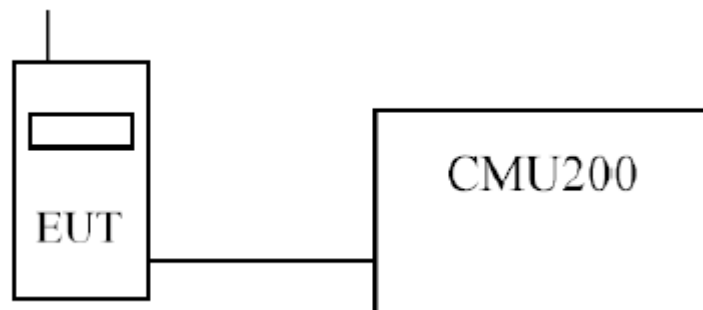

1.4. EUT Setup Procedures

- (1) Setup the EUT and simulators as shown on 1.3
- (2) Turn on the power of all equipments.
- (3) The EUT was set to communicate with CMU200.
- (4) Repeat the above procedure (3).

1.5. Test Facility

Ambient conditions in the laboratory:

Items	Required (IEC 68-1)	Actual
Temperature (°C)	15-35	20-35
Humidity (%RH)	25-75	50-65
Barometric pressure (mbar)	860-1060	950-1000

Site Description: June 22, 2001 File on
 Federal Communications Commission
 FCC Engineering Laboratory
 7435 Oakland Mills Road
 Columbia, MD 21046
 Reference 31040/SIT1300F2



July 03, 2001 Accreditation on NVLAP
 NVLAP Lab Code: 200533-0

Site Name: Quietek Corporation

Site Address: No. 5-22, Ruei-Shu Valley, Ruei-Ping Tsuen,
 Lin-Kou Shiang, Taipei,
 Taiwan, R.O.C.
 TEL: 886-2-8601-3788 / FAX : 886-2-8601-3789
 E-Mail : service@quietek.com

1.6. Type of Emission

300KGXW

1.7. DC voltages and DC currents

EUT Transmitting (in maximum power) :
 DC voltage : 3.7V , DC current : 0.21A

EUT Standby :
 DC voltage : 3.7V , DC current : 0.10A

2. Peak Power Output

2.1. Test Equipment

The following test equipments are used during the radiated emission test:

Test Site	Equipment	Manufacturer	Model No./Serial No.	Last Cal.
☒OATS 3	Test Receiver	R & S	ESCS 30 / 100122	Feb., 2005
	Universal Radio Communication Tester	R & S	CMU200 / 104846	May, 2004
	Spectrum Analyzer	Advantest	R3162 / 120300652	Feb., 2005
	Pre-Amplifier	QTK	QTK-AMP-03 / 0003	May, 2004
	Bilog Antenna	SCHAFFNER	CBL6112B / 2697	May, 2004
	Horn Antenna	ETS	3115 / 0005-6160	Jul., 2004
	Pre-Amplifier	QTK	QTK-AMP-01 / 0001	Jul., 2004

- Note: 1. All equipments that need to be calibrated are with calibration period of 1 year.
 2. Mark "X" test instruments are used to measure the final test results.

2.2. Test Setup

Radiated Power Measurement

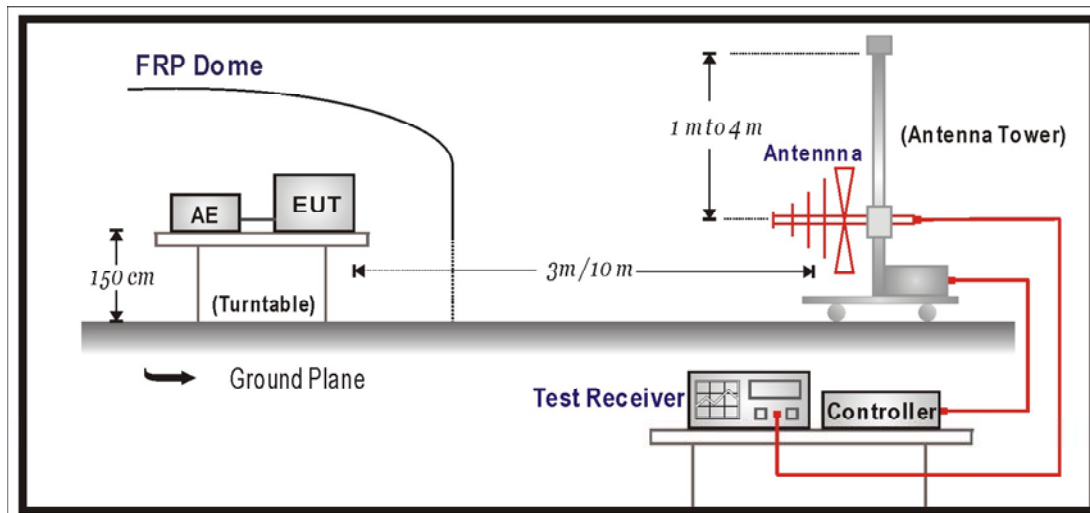

Conducted Power Measurement

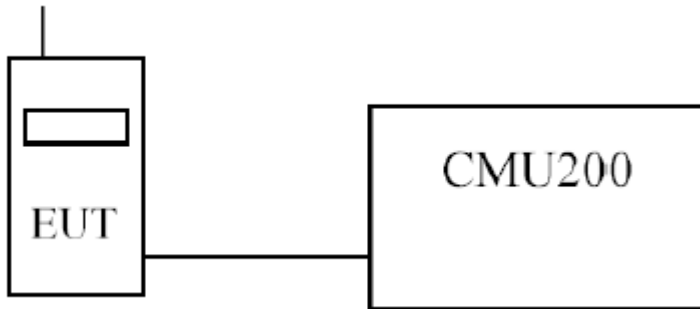

2.3. Limits

Limit	<2W or +33dBm
-------	---------------

2.4. Test Procedure

➤RF Out Power (Radiated)

The Spectrum Analyzer was tuned to the test frequency. The device was put into Transmit mode then rotated through 360 degrees until the highest power level was observed in both horizontal and vertical polarization. The device was then replaced with a substitution antenna, which input signal was adjusted until the received level matched that of the previously detected emission.

➤RF Out Power (Conducted)

Using a spectrum analyser and attenuator(s), the output power of the EUT was measured at the antenna terminals. The EUT supports both GSM and GPRS. The device is a class 0 module. The carrier was modulated by it's normal GMSK modulation and measurements performed with Timeslot 3(TS3) active.

2.5. Test Specification

According to Part 2.1046, 24.232.

2.6. Test Result of Peak Power Output

Product	GSM900/DCS1800 / PCS1900 GSM/GPRS Mobile Phone		
Test Mode	RF Output Power (Conducted)		
Date of Test	2005/03/01	Test Site	CB5
Test Condition	PCS1900 GSM/GPRS		

Maximum Power-GSM

Frequency (MHz)	Output Power (dBm)	Path Loss (dB)	Result (dBm)	Result (W)
1850.2	29.4	0.4	29.8	0.954
1880.0	29.6	0.4	30.0	1
1909.8	29.7	0.4	30.1	1.023

Maximum Power-GPRS

Frequency (MHz)	Output Power (dBm)	Path Loss (dB)	Result (dBm)	Result (W)
1850.2	29.3	0.4	29.7	0.933
1880.0	29.6	0.4	30.0	1
1909.8	29.7	0.4	30.1	1.023

Note:

1. EUT complies with CFR 47.2.1046 and 24.232(b). The EUT does not exceed 2W or +33dBm at the measured frequencies.

Product	GSM900/DCS1800 / PCS1900 GSM/GPRS Mobile Phone		
Test Mode	RF Output Power (Radiated)		
Date of Test	2005/02/15	Test Site	CB5
Test Condition	PCS1900 GSM/GPRS		

Maximum Power-GSM

Frequency (MHz)	Raw Result (dBm)	Substitution Level (dBm)	Substitution Antenna Gain (dB)	Cable Loss (dB)	Result EIRP (dBm)	Result EIRP (W)
1850.2	21.9	20.56	10.4	1.02	29.94	0.986
1880.0	22.18	20.84	10.4	1.02	30.22	1.051
1909.8	22.34	21.00	10.4	1.02	30.38	1.091

Maximum Power-GPRS

Frequency (MHz)	Raw Result (dBm)	Substitution Level (dBm)	Substitution Antenna Gain (dB)	Cable Loss (dB)	Result EIRP (dBm)	Result EIRP (W)
1850.2	21.73	20.39	10.4	1.02	29.77	0.948
1880.0	22.16	20.82	10.4	1.02	30.20	1.047
1909.8	22.32	20.98	10.4	1.02	30.36	1.086

Note:

1. The EUT meets the requirements of FCC CFR 47: Part 24, Section 24.232(b) for Effective Radiated Power.

3. Modulation Characteristics

3.1. Test Equipment

The following test equipment are used during the modulation characteristics test:

Equipment	Manufacturer	Model No./Serial No.	Last Cal.
Spectrum Analyzer	Advantest	R3182 / 100803470	May, 2004
Universal Radio Communication Tester	R & S	CMU200 / 104846	May, 2004
Directional couple	Agilent	87300C/3239A01864	N/A

Note: All equipments that need to be calibrated are with calibration period of 1 year.

3.2. Test Setup

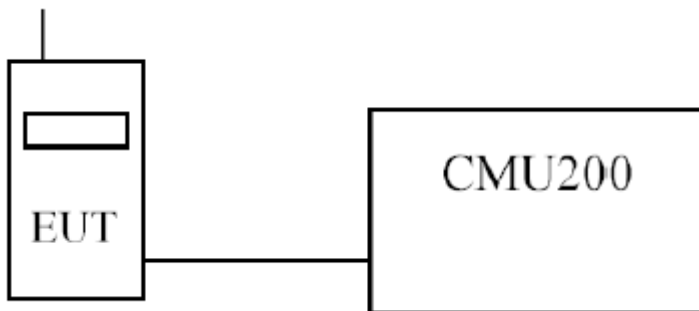

3.3. Modulation Description

GMSK is a form of binary signaling schemes which represent digital states as a shift between discrete sinusoidal frequencies called Frequency Shift Keying (FSK). Minimum Shift Keying (MSK) is continuous phase FSK with the smallest possible modulation index h . Modulation index is defined as:

$$h = 2 \cdot F \cdot T_b$$

where F = Peak frequency deviation in Hz and T_b = Bit period in seconds

Two discrete frequencies, representing two distinct digital states, with equal phases at switch time $t = 0$ requires a minimum value of $h = 0.5$. The Gaussian part of GMSK describes the fact that the digital pulses are filtered in the time domain. This results in bits which are sinusoidal rather than square. The effective spectrum is then compressed with the average carrier frequency in the center of the passband. This is a great advantage because of the significantly reduced bandwidth. GMSK is utilized because of these bandwidth conservation properties.

The bandwidth for GSM is a 60 MHz up-link at 1850-1910 MHz and down-link at 1930-1990 MHz. The 65 MHz is divided into 299 channels, each of which is 200 kHz wide. Slight spectral spillage is allowed into neighboring channels (which is minimized by GMSK). This separated transmit/receive frequencies scheme under GSM enables easier duplex filtering.

Within the bandwidth, individual channels are subdivided into multiframe (made of 26 frames), frames (made of 8 time slots), and time slots (made of 8 fields). The time slots are 0.57 ms long allowing 156.25 bits of information including overhead.

The modulation used in GPRS is the same used in GSM. A GSM channel contains eight timeslots, each timeslot is dedicated to one circuit switched call. For GPRS the timeslots are assigned on an as needed basis, and more than one timeslot can be assigned for a particular transmission depending on the network and the device.

3.4. Test Specification

According to Part 2.1047(d)

3.5. Test Result of Modulation

Product	GSM900/DCS1800 / PCS1900 GSM/GPRS Mobile Phone		
Test Mode	Modulation		
Date of Test	2005/03/01	Test Site	CB5
Test Condition	PCS1900 GSM/GPRS		

Circuit Switched (GSM)

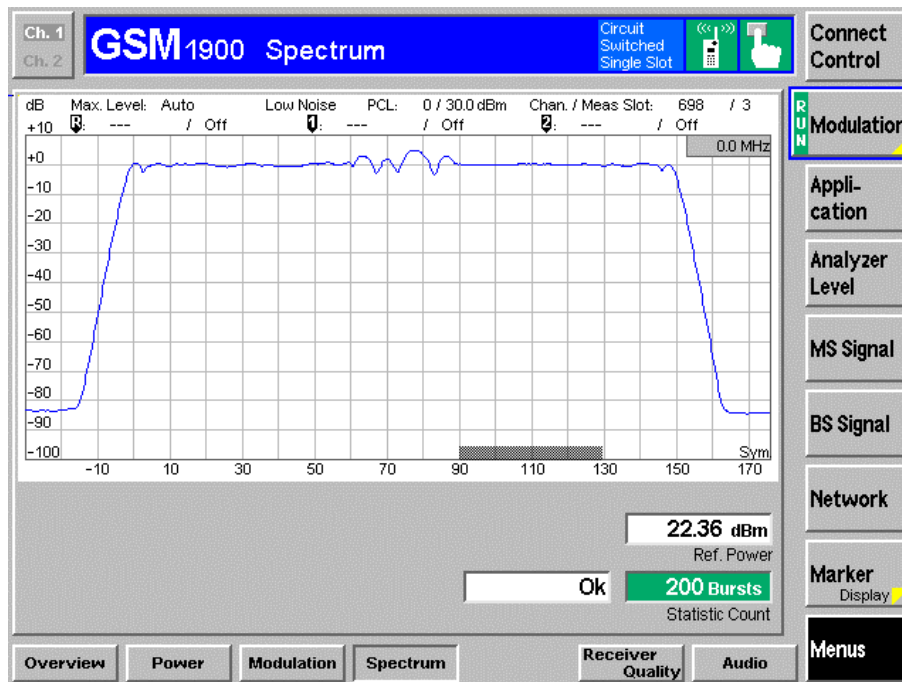

Circuit Switched (GPRS)

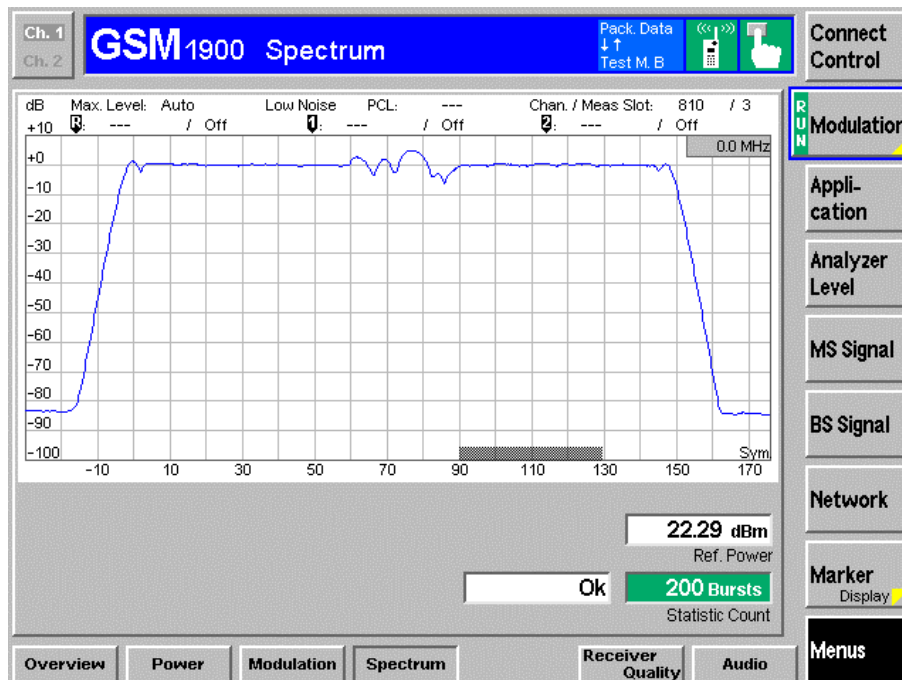

4. Occupied Bandwidth

4.1. Test Equipment

The following test equipments are used during the occupied bandwidth tests:

Equipment	Manufacturer	Model No./Serial No.	Last Cal.
Spectrum Analyzer	Advantest	R3182 / 100803470	May, 2004
Universal Radio Communication Tester	R & S	CMU200 / 104846	May, 2004
Directional coupler	Agilent	87300C/3239A01864	N/A

Note: All equipments upon which need to be calibrated are with calibration period of 1 year.

4.2. Test Setup

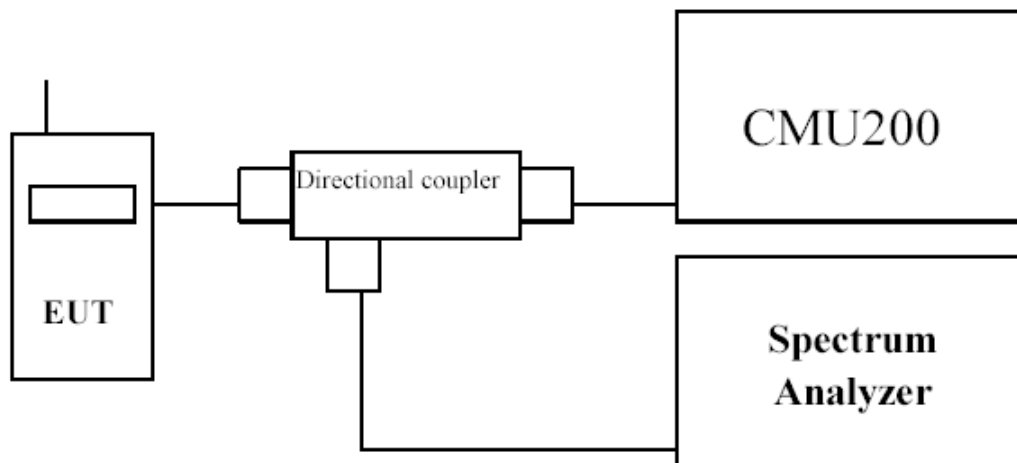

4.3. Test Procedure

➤ GSM

The EUT was set to transmit on maximum power and measurements were made on Timeslot 3.

➤ GPRS

The EUT was set to transmit on maximum power, (timeslots 3 and 4 active), and measurements were made on Timeslot 3.

Using a resolution bandwidth of 30kHz and a video bandwidth of 100kHz, the -26dBc points were established and the emission bandwidth determined.

The plots below show the resultant display from the Spectrum Analyzer.

4.4. Test Specification

According to Part 2.1049, 24.238(b).

4.5. Test Result of Occupied Bandwidth

Product	GSM900/DCS1800 / PCS1900 GSM/GPRS Mobile Phone		
Test Mode	Occupied Bandwidth		
Date of Test	2005/03/01	Test Site	CB5
Test Condition	PCS1900 GSM/GPRS		

Circuit Switched (GSM Mode CH512)

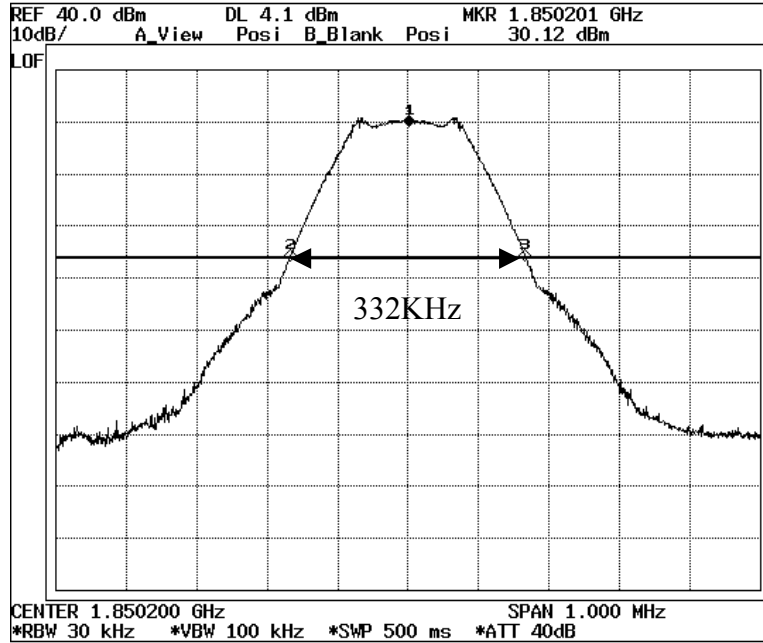

Packet Switched (GPRS Mode CH512)

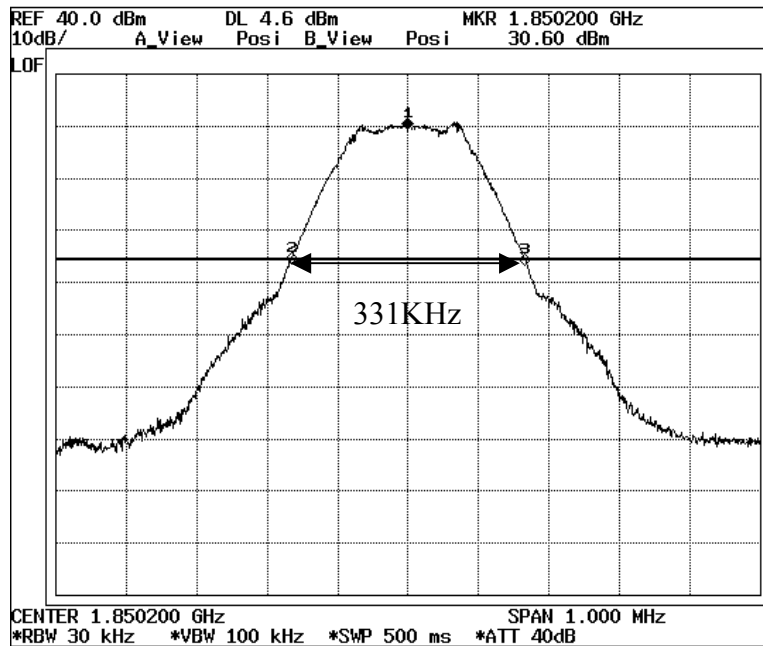

Product	GSM900/DCS1800 / PCS1900 GSM/GPRS Mobile Phone		
Test Mode	Occupied Bandwidth		
Date of Test	2005/03/01	Test Site	CB5
Test Condition	PCS1900 GSM/GPRS		

Circuit Switched (GSM Mode CH661)

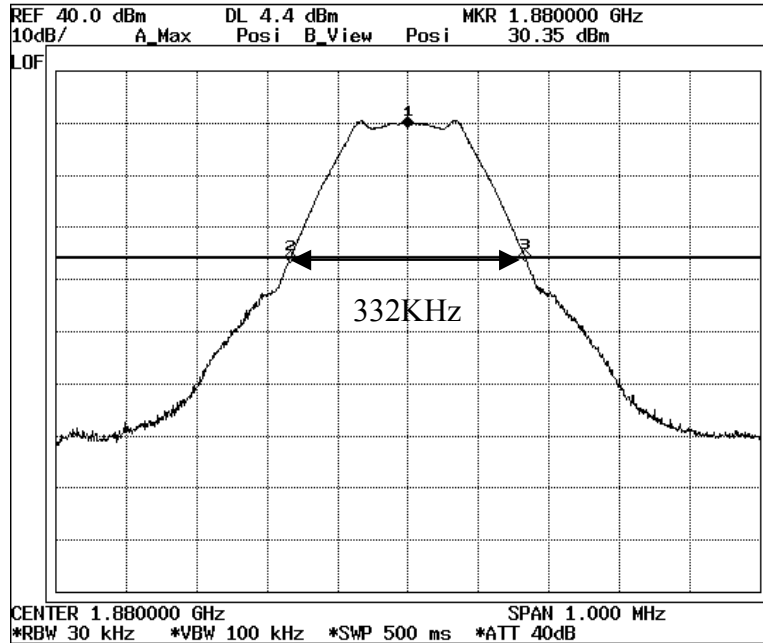

Packet Switched (GPRS Mode CH661)

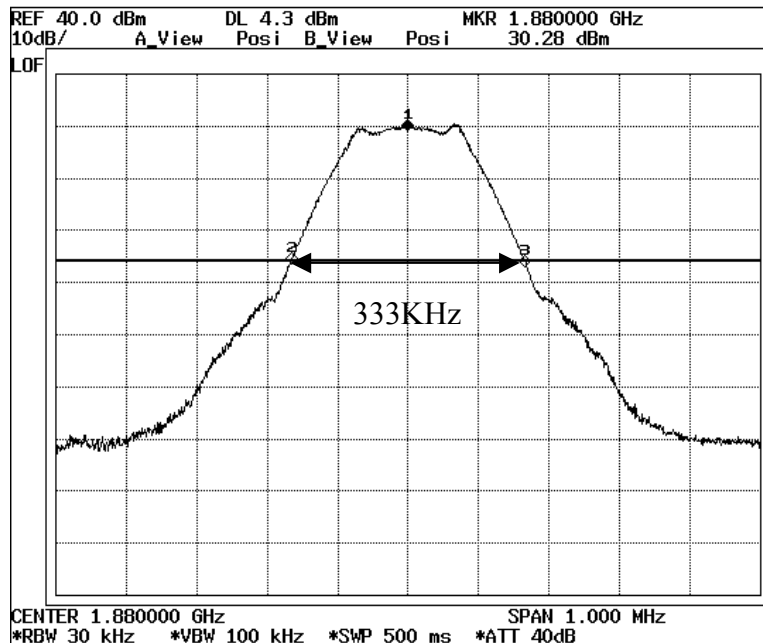

Product	GSM900/DCS1800 / PCS1900 GSM/GPRS Mobile Phone		
Test Mode	Occupied Bandwidth		
Date of Test	2005/03/01	Test Site	CB5
Test Condition	PCS1900 GSM/GPRS		

Circuit Switched (GSM Mode CH810)

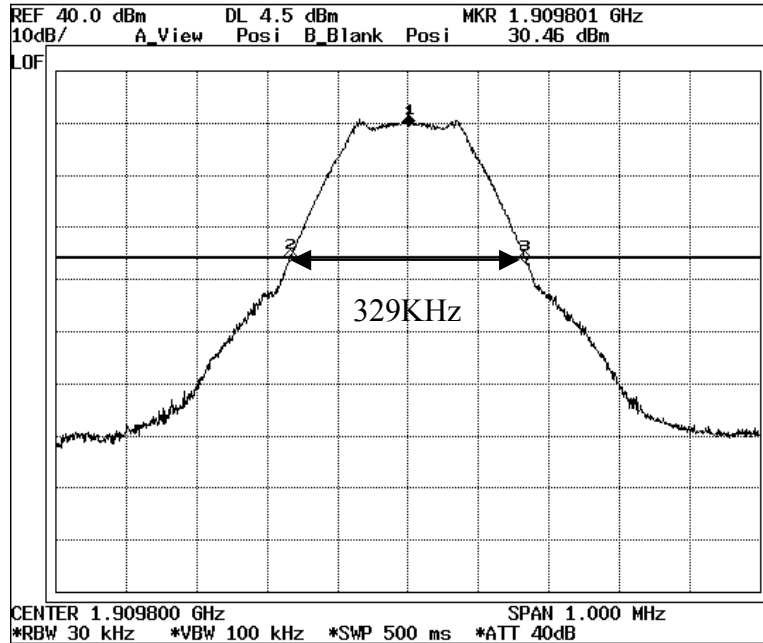

Packet Switched (GPRS Mode CH810)

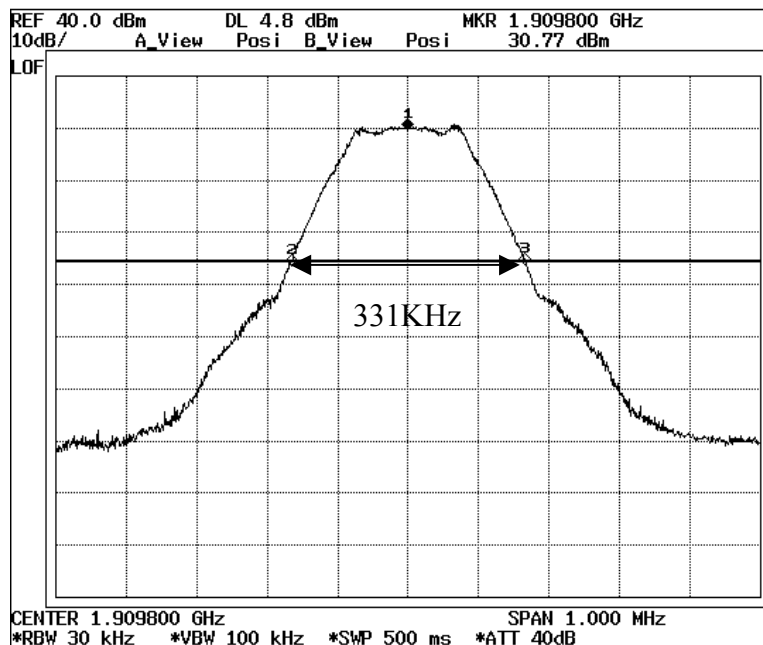

5. Spurious Emission At Antenna Terminals (+/-1MHz)

5.1. Test Equipment

The following test equipments are used during the spurious emission test

Equipment	Manufacturer	Model No./Serial No.	Last Cal.
Spectrum Analyzer	Advantest	R3182 / 100803470	May, 2004
Universal Radio Communication Tester	R & S	CMU200 / 104846	May, 2004
Directional coupler	Agilent	87300C/3239A01864	N/A

Note: All equipments upon which need to be calibrated are with calibration period of 1 year.

5.2. Setup

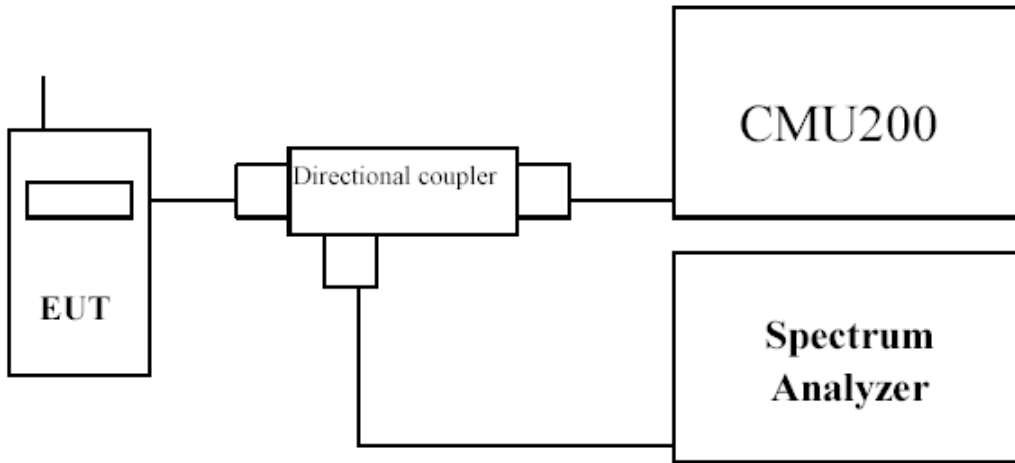

5.3. Limits

Transmitter limits for narrowband spurious emission

Lower Block Edge Test Channels/Frequencies	Upper Block Edge Test Channels/Frequencies
Block A Channel : 512 Frequency : 1850.2 MHz	Block C Channel : 810 Frequency : 1909.8 MHz

5.4. Test Procedure

In accordance with Part 24.238, at least 1% of the emission bandwidth was used for the resolution and video bandwidths up to 1MHz away from the Block Edge. At greater than 1MHz, the resolution and video bandwidth were increased to 1MHz.

The reference power and path losses of all channels used for testing in each frequency block were measured.

5.5. Test Specification

According to Part 2.1049, 24.238.

5.6. Spurious Emission At Antenna Terminals (+/-1MHz)

Product	GSM900/DCS1800 / PCS1900 GSM/GPRS Mobile Phone		
Test Mode	Spurious Emission At Antenna Terminals (+/-1MHz)		
Date of Test	2005/03/01	Test Site	CB5
Test Condition	Block Edge Test (GSM)		

GSM Lower Channel 512 (1850.2MHz)

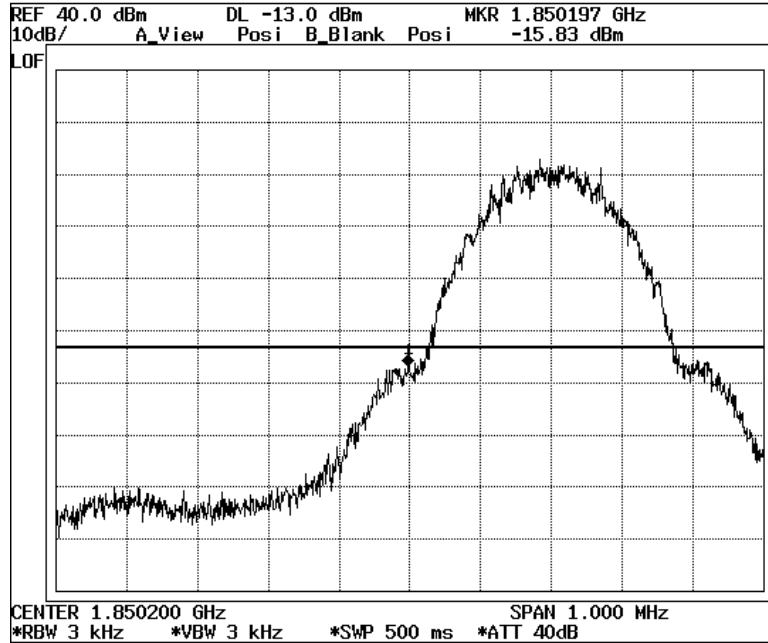

GSM Upper Channel 810(1910.0MHz)

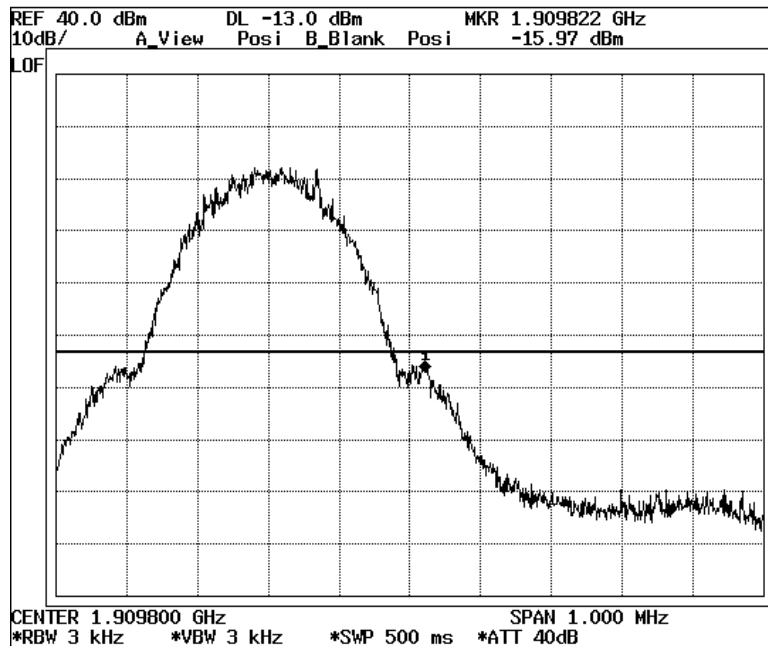

Product	GSM900/DCS1800 / PCS1900 GSM/GPRS Mobile Phone		
Test Mode	Spurious Emission At Antenna Terminals (+/-1MHz)		
Date of Test	2005/03/01	Test Site	CB5
Test Condition	Block Edge Test (GPRS)		

GPRS Lower Channel 512 (1850.2MHz)

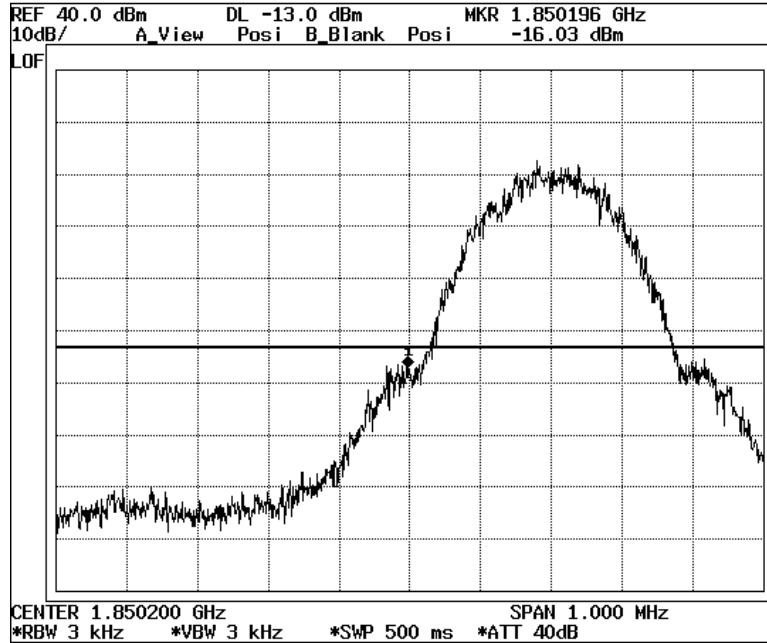

GPRS Upper Channel 810(1910.0MHz)

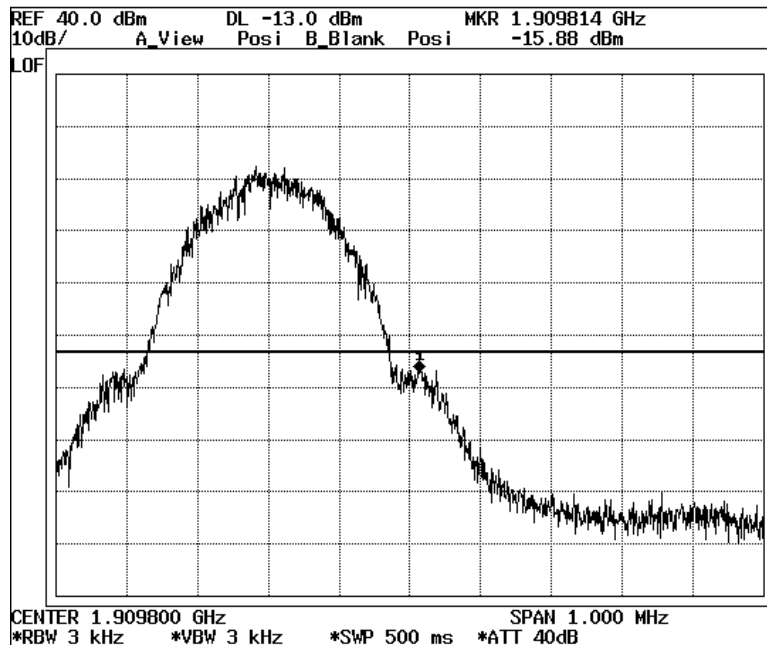

6. Spurious Emission

6.1. Test Equipment

The following test equipments are used during the radiated emission test:

Test Site	Equipment	Manufacturer	Model No./Serial No.	Last Cal.
☒OATS 3	Test Receiver	R & S	ESCS 30 / 100122	Feb., 2005
	Universal Radio Communication Tester	R & S	CMU200 / 104846	May, 2004
	Spectrum Analyzer	Advantest	R3162 / 120300652	Feb., 2005
	Pre-Amplifier	QTK	QTK-AMP-03 / 0003	May, 2004
	Bilog Antenna	SCHAFFNER	CBL6112B / 2697	May, 2004
	Horn Antenna	ETS	3115 / 0005-6160	Jul., 2004
	Pre-Amplifier	QTK	QTK-AMP-01 / 0001	Jul., 2004

Note: 1. All equipments that need to be calibrated are with calibration period of 1 year.
 2. Mark "X" test instruments are used to measure the final test results.

6.2. Test Setup

(a) **Spurious emissions at antenna terminals.**

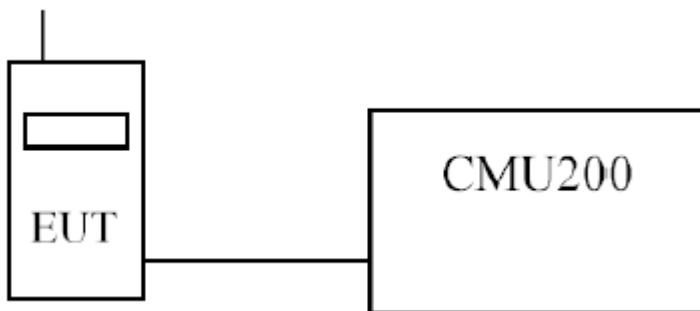

(b) Field strength of spurious radiation.

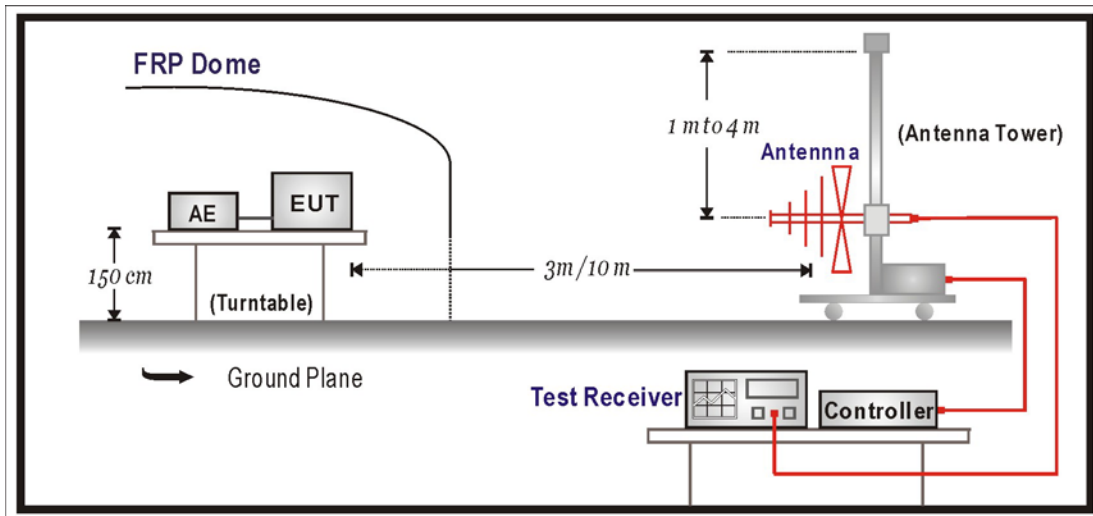

6.3. Limits

Limit	<-13dBm
--------------	-------------------

43 + 10Log(P) down on the carrier where P is the power in Watts.

6.4. Test Procedure

In accordance with Part 2.1051, the spurious emissions from the antenna terminal were measured. The transmitter output power was attenuated using a combination of filters and attenuators and the frequency spectrum investigated from 9kHz to 20GHz. The EUT was set to transmit on full power. The EUT was tested on bottom, middle and top channels for both power levels. The resolution and video bandwidth was set to 1MHz in accordance with Part 24.238. The spectrum analyzer detector was set to Max Hold.

In addition, measurements were made up to the 10th harmonic of the fundamental.

The EUT is placed on a turn table which is 1.5 meter above ground. The turn table can rotate 360 degrees to determine the position of the maximum emission level. The EUT was positioned such that the distance from antenna to the EUT was 3 meters.

The antenna can move up and down between 1 meter and 4 meters to find out the maximum emission level.

Both horizontal and vertical polarization of the antenna are set on measurement. In order to find the maximum emission, all of the interface cables must be manipulated according to TIA/EIA 603-A on radiated measurement.

6.5. Test Specification

According to Part 2.1051, 2.1053, 24.238(b).

6.6. Test Result of Spurious Emission

Product	GSM900/DCS1800 / PCS1900 GSM/GPRS Mobile Phone		
Test Mode	Spurious Emission (Conducted)		
Date of Test	2005/03/01	Test Site	CB5
Test Condition	PCS1900 GSM/GPRS	Test Range	9KHz~20GHz

GSM-Channel 661

Frequency (GHz)	Reading Level (dBm)	Path Loss (dB)	Emission Level (dBm)	Limit (dBm)
3.765	-50.42	1.10	-49.32	-13
5.64	-63.29	1.23	-62.06	-13
7.52	-62.77	1.61	-61.16	-13
9.4	-45.55	2.19	-43.36	-13
11.28	-63.16	2.12	-61.04	-13
13.16	-63.74	3.09	-60.65	-13
15.04	-66.07	3.84	-62.23	-13
16.92	-56.63	4.75	-51.88	-13
18.8	-64.09	5.46	-58.69	-13

GPRS-Channel 661

Frequency (GHz)	Reading Level (dBm)	Path Loss (dB)	Emission Level (dBm)	Limit (dBm)
3.76	-48.22	1.10	-47.12	-13
5.64	-62.35	1.23	-61.12	-13
7.52	-63.25	1.61	-61.64	-13
9.4	-44.71	2.19	-42.52	-13
11.8	-63.49	2.12	61.37	-13
13.16	-63.99	3.09	-60.90	-13
15.04	-65.55	3.84	61.71	-13
16.92	-56.70	4.75	-51.95	-13
18.8	-63.41	5.46	-57.95	-13

Product	GSM900/DCS1800 / PCS1900 GSM/GPRS Mobile Phone		
Test Mode	Spurious Emission (Radiated)		
Date of Test	2005/03/01	Test Site	No.3 OATS
Test Condition	Channel 661 (PCS1900 GSM)	Test Range	9KHz ~20GHz

Frequency	Reading Level	Signal Generator Level	Cable Loss	Antenna Gain	EIRP Value	Limit
(GHz)	(dBm)	(dBm)	(Db)	(dBi)	(dBm)	(dBm)

Horizontal Emissions

3.76	-56.60	-60.50	1.41	12.6	-49.31	-13
5.64	-55.38	-48.79	1.56	13.1	-37.25	-13
7.52	-58.07	-53.15	2.01	11.5	-43.66	-13
9.40	-53.98	-46.64	2.74	12.0	-37.38	-13
11.28	-57.63	-44.82	2.64	11.6	-35.86	-13

Vertical Emissions

3.76	-54.88	-57.44	1.41	12.6	-46.25	-13
5.64	-58.95	-58.58	1.56	13.1	-47.04	-13
7.52	-58.66	-54.53	2.01	11.5	-45.04	-13
9.40	-55.02	-46.45	2.74	12.0	-37.19	-13
11.28	-57.87	-44.88	2.64	11.6	-35.92	-13

Note:

1. Receiver setting (Peak Detector) : RBW:1MHz; VBW:3MHz ◦
2. EIRP Value = Signal Generator Level + Antenna Gain - Cable Loss
3. Spurious emissions past 12GHz are not shown, due to the magnitude of spurious emissions attenuated more than 20 dB below the limit

Product	GSM900/DCS1800 / PCS1900 GSM/GPRS Mobile Phone		
Test Mode	Spurious Emission (Radiated)		
Date of Test	2005/03/01	Test Site	No.3 OATS
Test Condition	Channel 661 (PCS1900 GPRS)	Test Range	9KHz ~20GHz

Frequency	Reading Level	Signal Generator Level	Cable Loss	Antenna Gain	EIRP Value	Limit
(GHz)	(dBm)	(dBm)	(dB)	(dBi)	(dBm)	(dBm)

Horizontal Emissions

3.76	-56.65	-60.49	3.08	12.6	-50.97	-13
5.64	-50.88	-43.82	3.91	13.1	-34.63	-13
7.50	-58.35	-53.52	4.38	11.5	-46.40	-13
9.40	-55.91	-49.85	4.86	12.0	-42.71	-13
11.28	-57.21	-44.29	6.25	11.6	-38.94	-13

Vertical Emissions

3.76	-54.99	-57.58	3.08	12.6	-48.06	-13
5.64	-51.16	-48.44	3.91	13.1	-39.25	-13
7.50	-58.72	-54.75	4.38	11.5	-47.63	-13
9.40	-55.59	-47.18	4.86	12.0	-40.04	-13
11.28	-57.52	-44.33	6.25	11.6	-38.98	-13

Note:

1. Receiver setting (Peak Detector) : RBW:1MHz; VBW:3MHz ◦
2. EIRP Value = Signal Generator Level + Antenna Gain - Cable Loss
3. Spurious emissions past 12GHz are not shown, due to the magnitude of spurious emissions attenuated more than 20 dB below the limit

7. Frequency Stability Under Temperature & Voltage Variations

7.1. Test Equipment

The following test equipments are used during the frequency stability test:

Equipment	Manufacturer	Model No./Serial No.	Last Cal.
Universal Radio Communication Tester	R & S	CMU200 / 104846	May, 2004
Standard Temperature & Humidity Chamber	WIT	TH-1S-B / 108210	Aug., 2004
DC Power Supply	Topward	6303D / 670302	N/A

Note: All equipments upon which need to be calibrated are with calibration period of 1 year

7.2. Test Setup

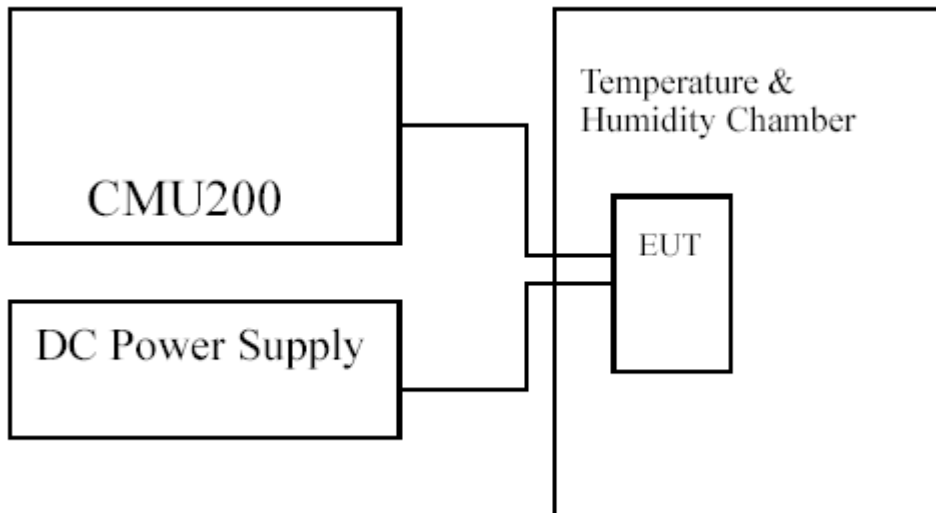

7.3. Limits

Limit	$\leq \pm 1 \text{ppm}$
-------	-------------------------

7.4. Test Procedure

GSM

The EUT was set to transmit on maximum power and measurements were made on Timeslot3. Universal Radio Communication Tester, (CMU200), was used to measure The Frequency Error. The maximum result of measurements made over 200 bursts was recorded.

GPRS

The EUT was set to transmit on maximum power, (timeslots 3 and 4 active), and measurements performed on Timeslot 3. A Universal Radio Communication Tester, (CMU200), was used to measure the frequency error. The maximum result of measurements made over 200 bursts was recorded.

7.5. Test Specification

According to Part 2.1055, 24.235

7.6. Test Result of Frequency Stability Under Temperature Variations

Product	GSM900/DCS1800 / PCS1900 GSM/GPRS Mobile Phone		
Test Mode	Frequency Stability Under Temperature Variations & Voltage Variations		
Date of Test	2005/03/01	Test Site	CB4
Test Condition	PCS 1900 GSM/GPRS Channel 661	Test Range	-30°C ~+50°C

GSM-Circuit Switched

Temperature Interval()	Test Frequency (GHz)	Deviation (Hz)	Limit (KHz)
-30	1.88	-73	±1.88
-20	1.88	-67	±1.88
-10	1.88	-54	±1.88
0	1.88	-46	±1.88
10	1.88	-40	±1.88
20	1.88	-35	±1.88
30	1.88	-40	±1.88
40	1.88	-46	±1.88
50	1.88	-48	±1.88

GSM-Circuit Switched

DC Voltage (V)	Test Frequency (GHz)	Deviation (Hz)	Limit (KHz)
3.145	1.88	-51	±1.88
3.7	1.88	-38	±1.88
4.225	1.88	-49	±1.88

8. EMI Reduction Method During Compliance Testing

No modification was made during testing.

Attachment 1: EUT Test Photographs

Test Mode : PCS1900 GSM

Description : Front View of Spurious Emission Test

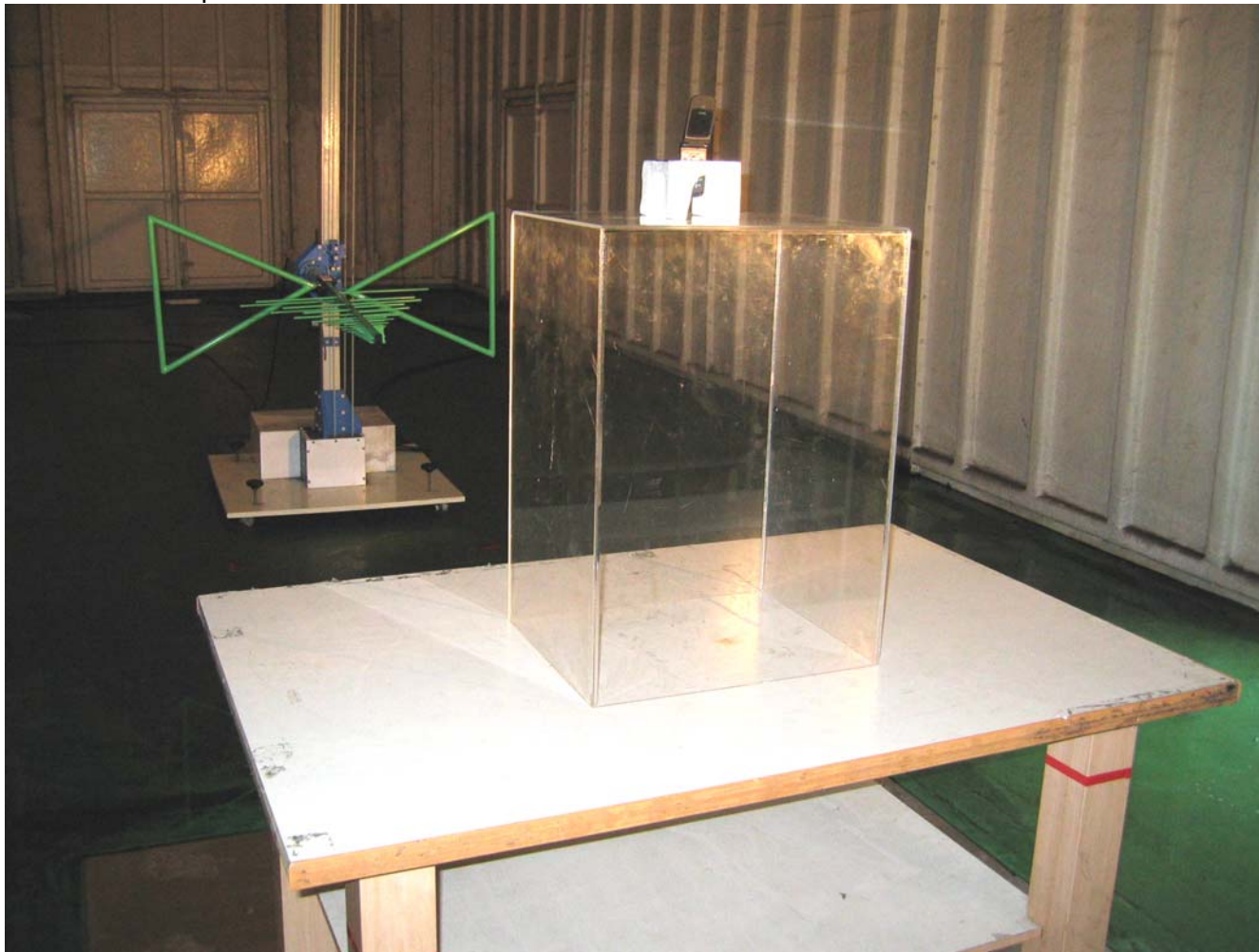

Test Mode : PCS1900 GSM

Description : Back View of Spurious Emission Test

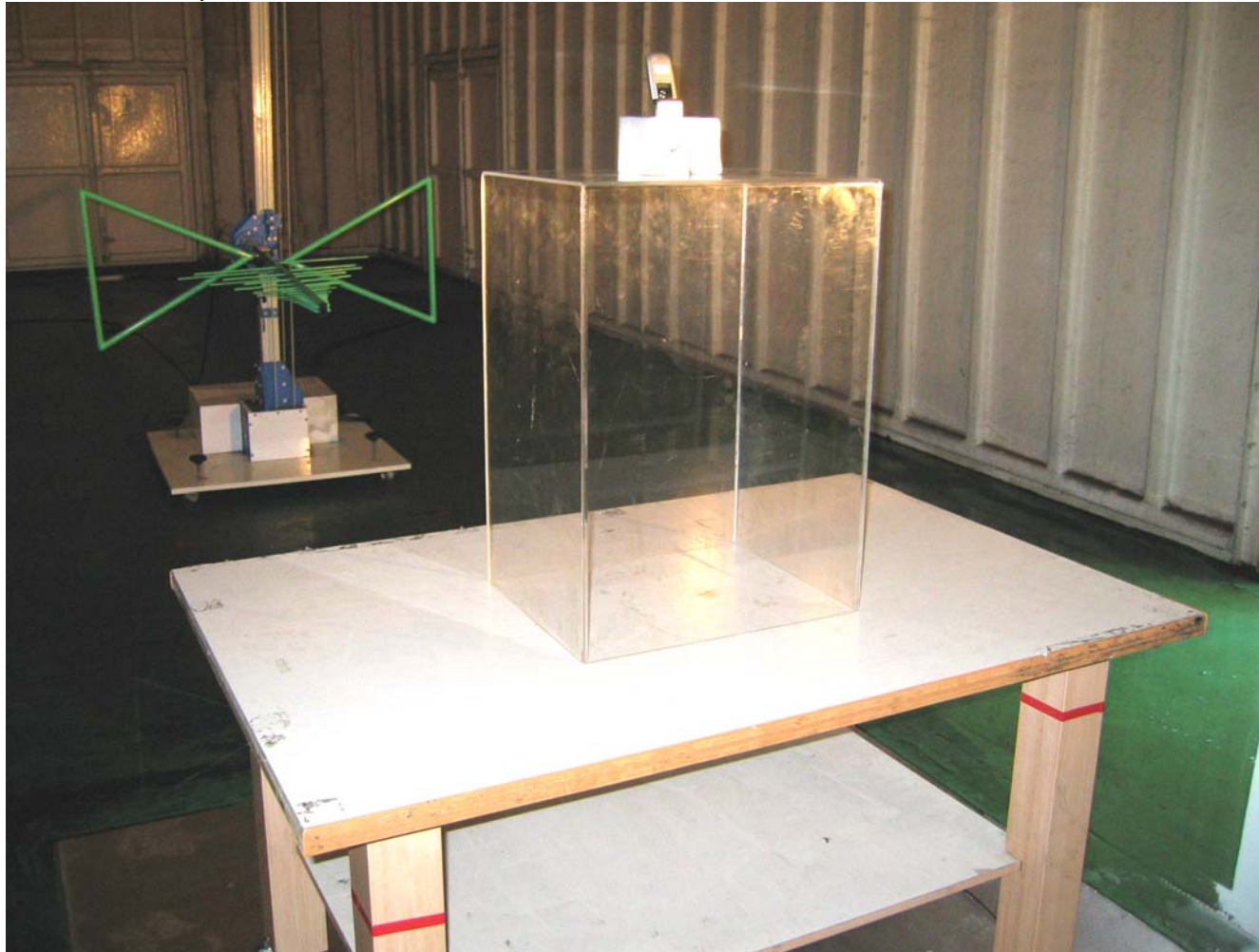

Test Mode : PCS1900 GSM

Description : Front View of Spurious Emission Test

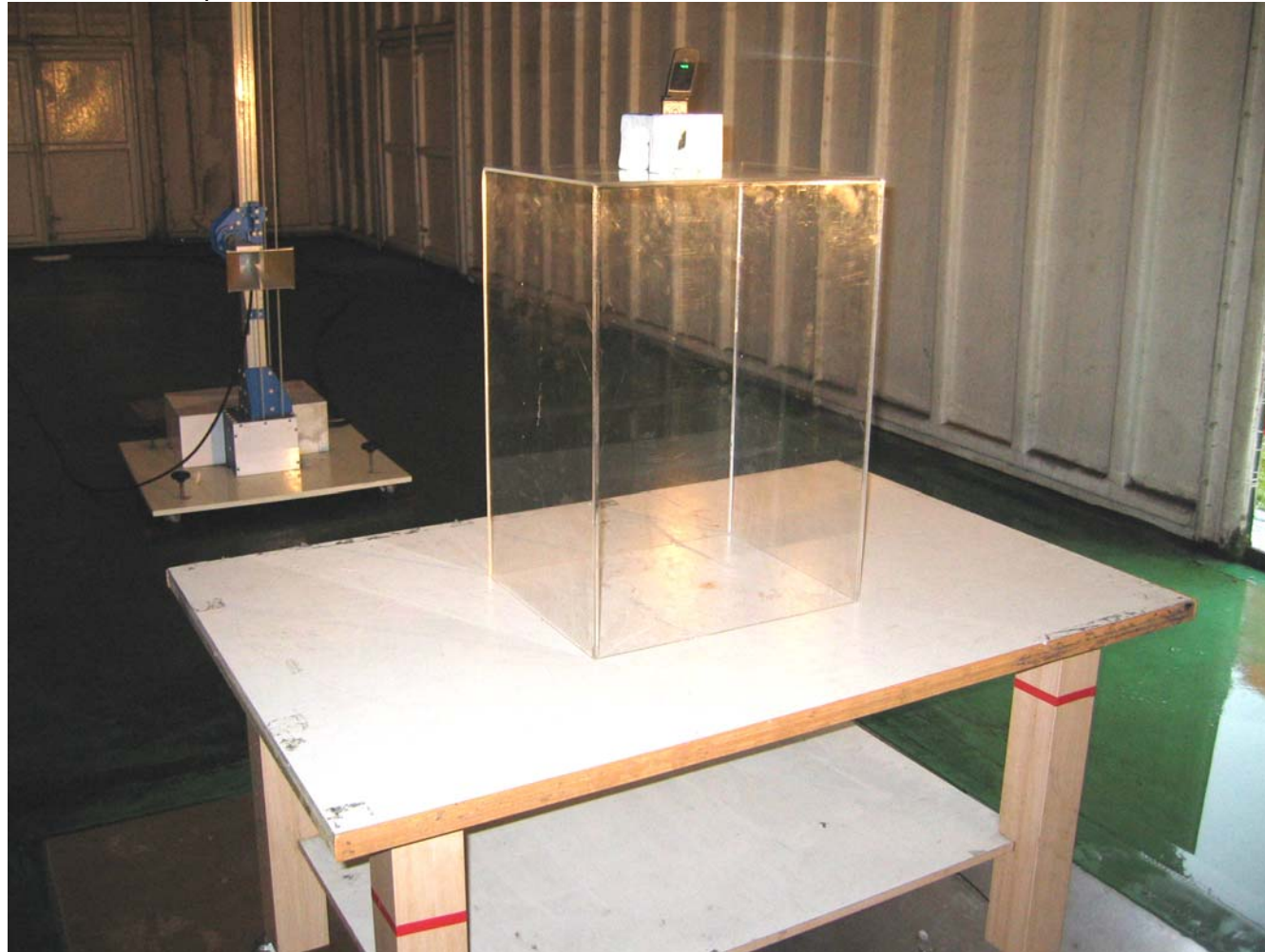

Test Mode : PCS1900 GSM

Description : Back View of Spurious Emission Test



Attachment 2: EUT Detailed Photographs













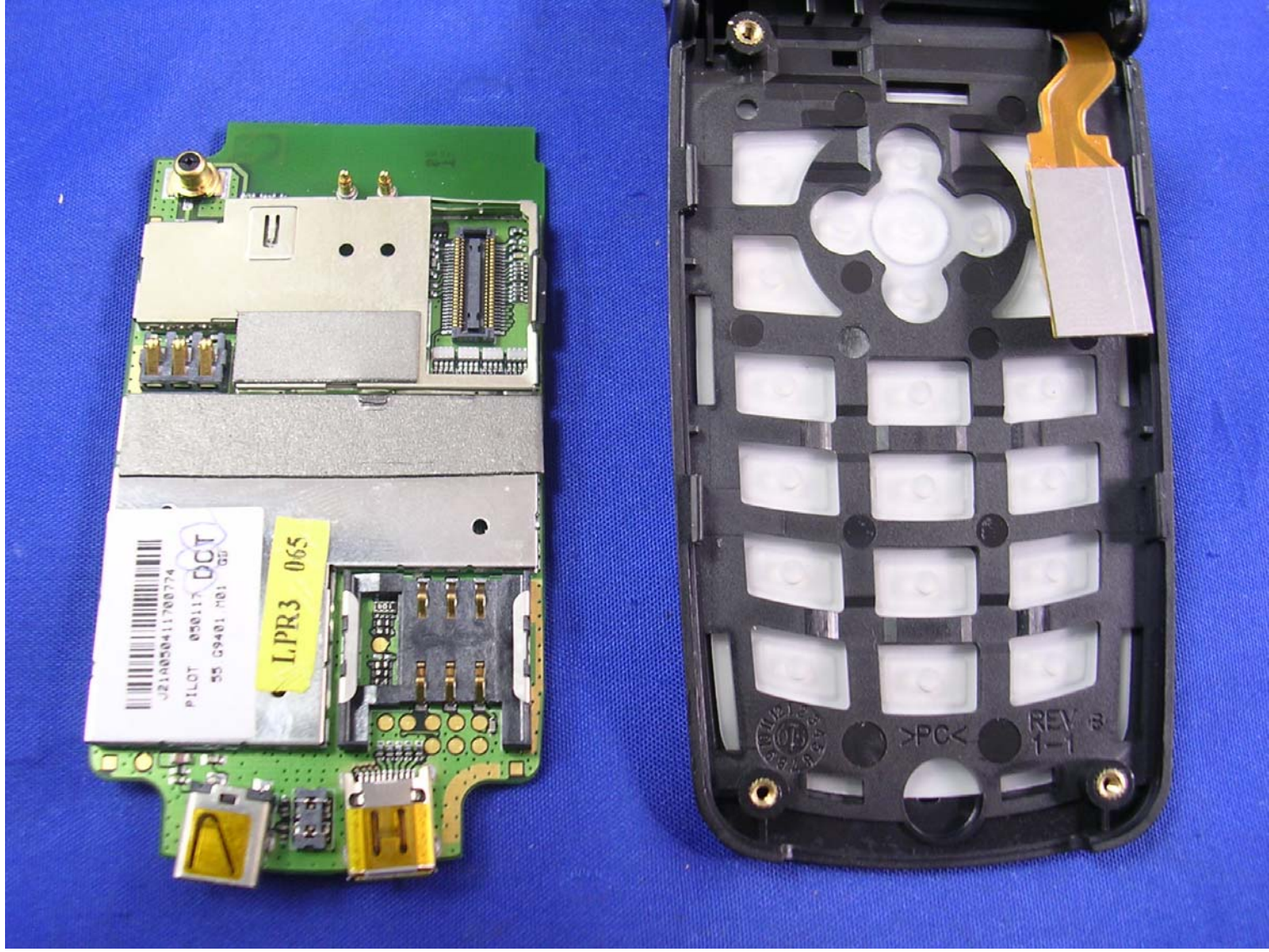

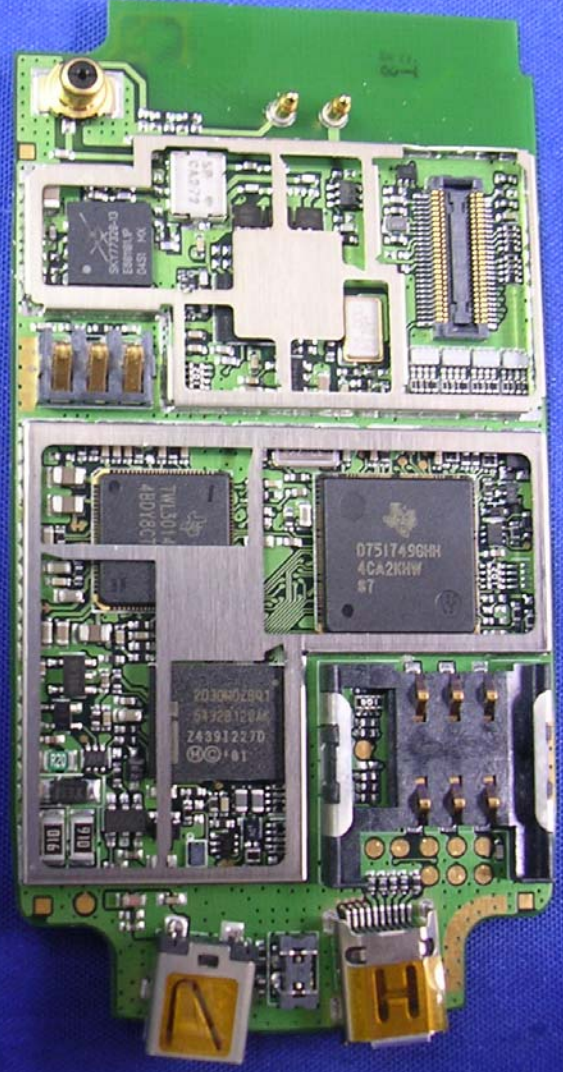
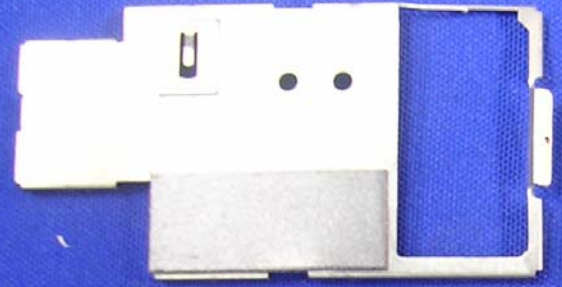

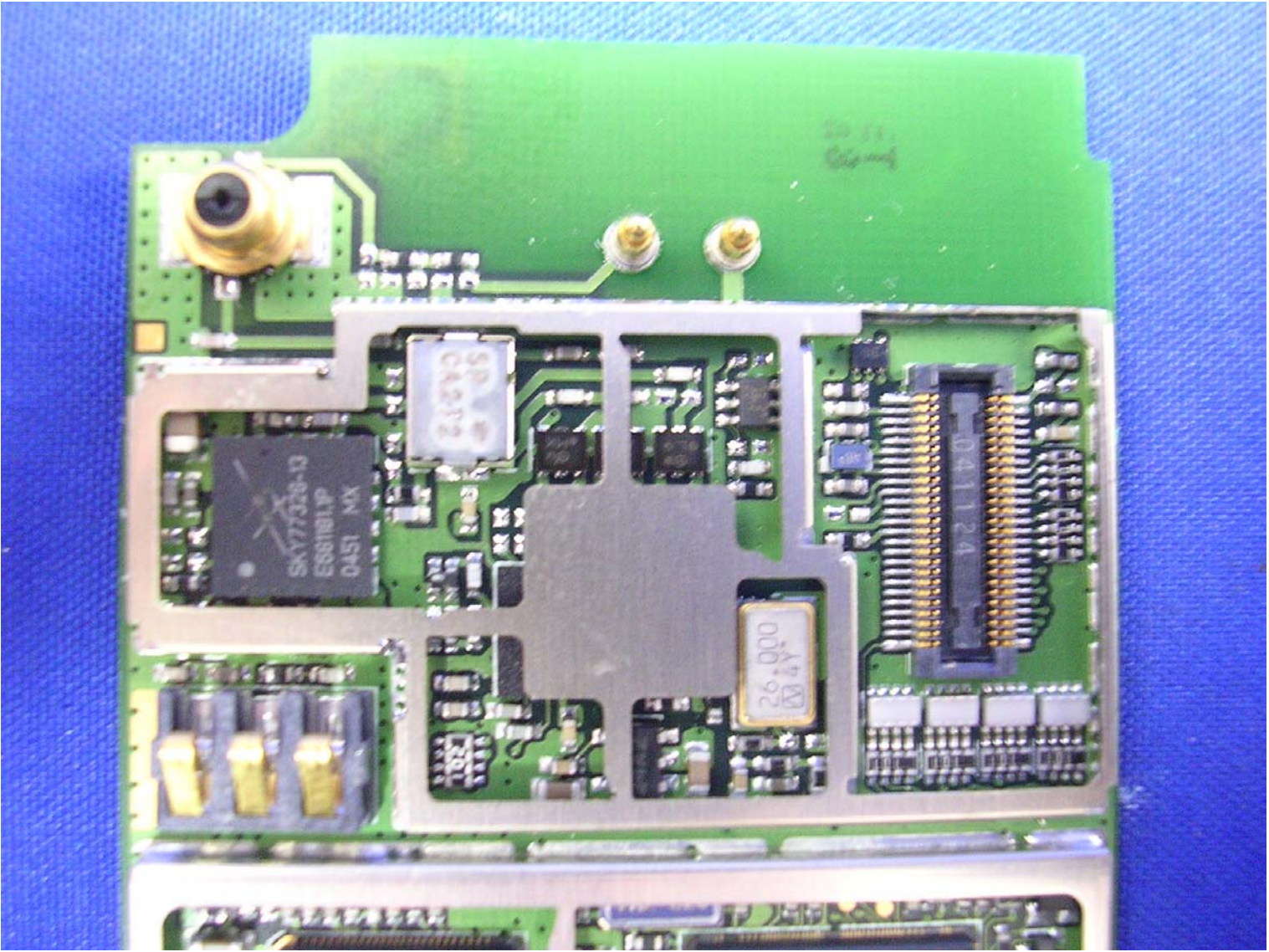

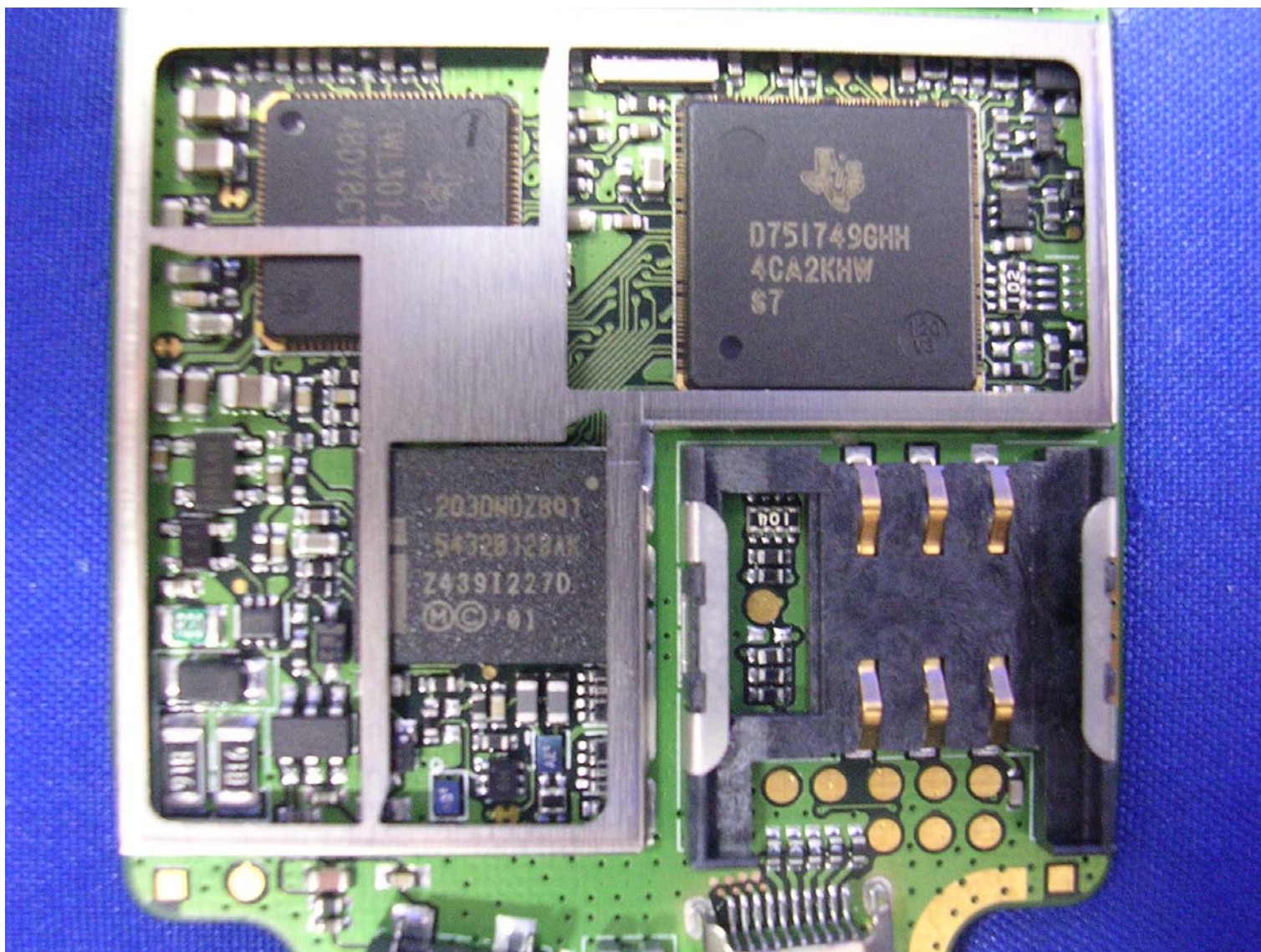

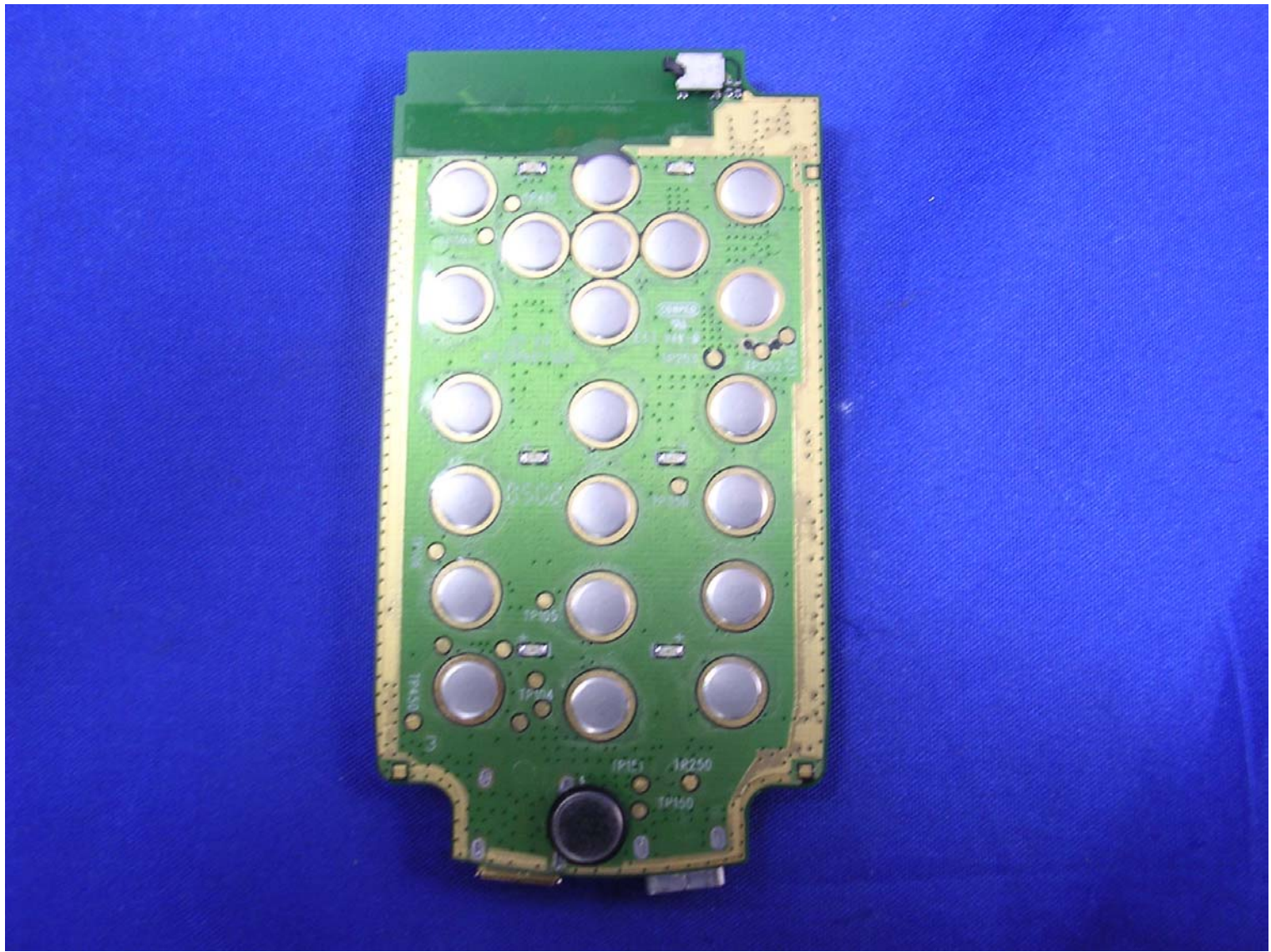

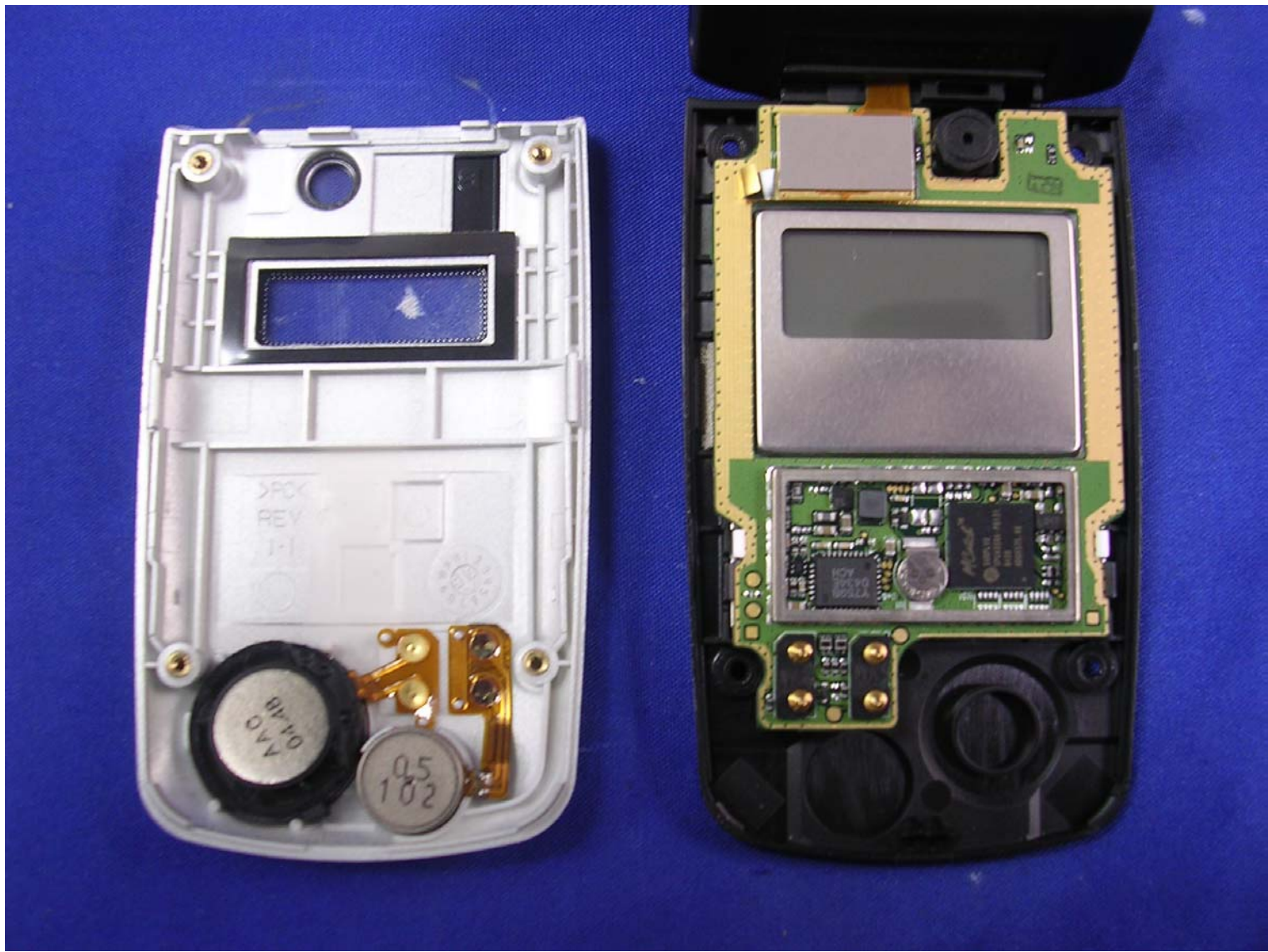



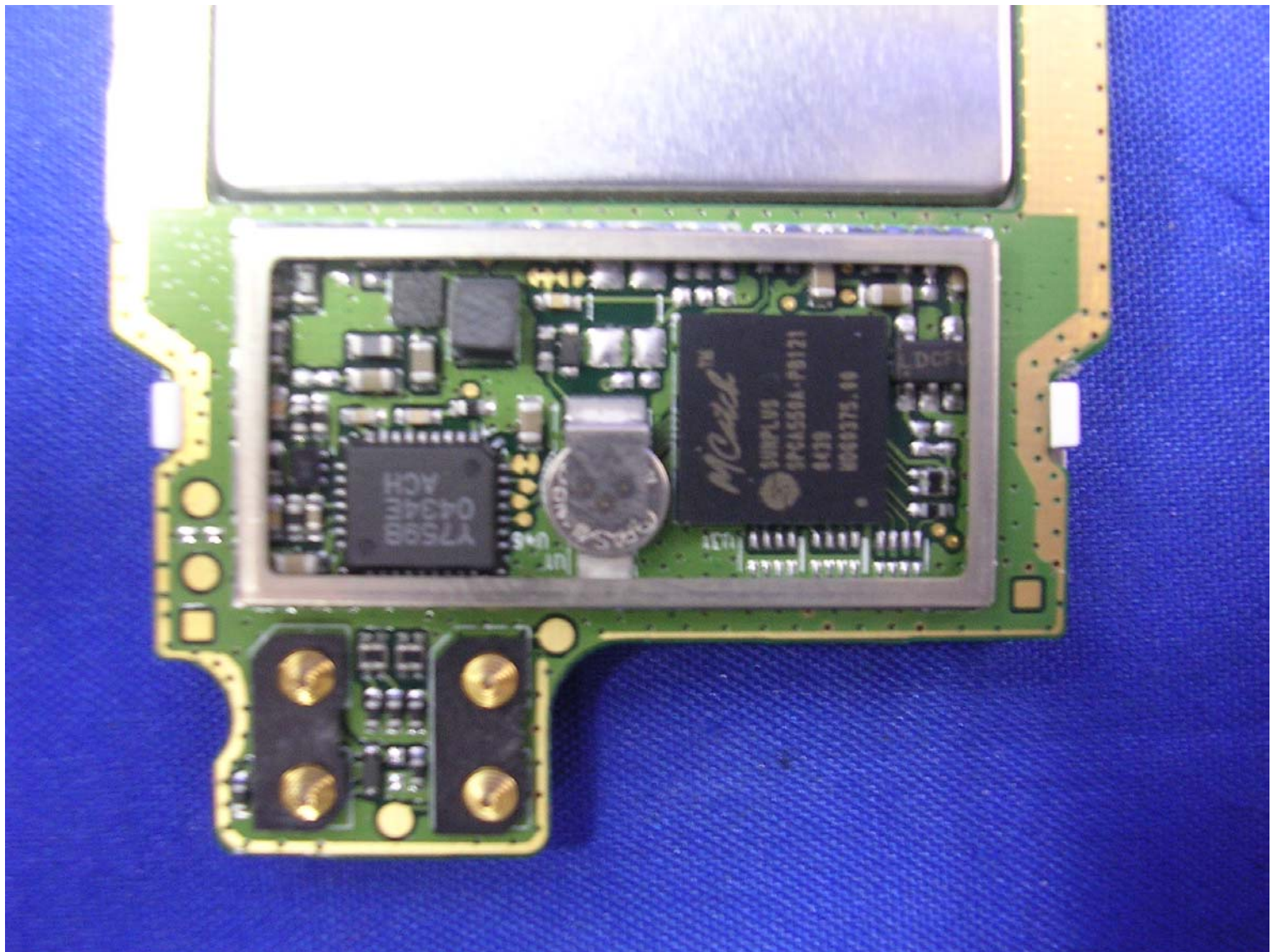

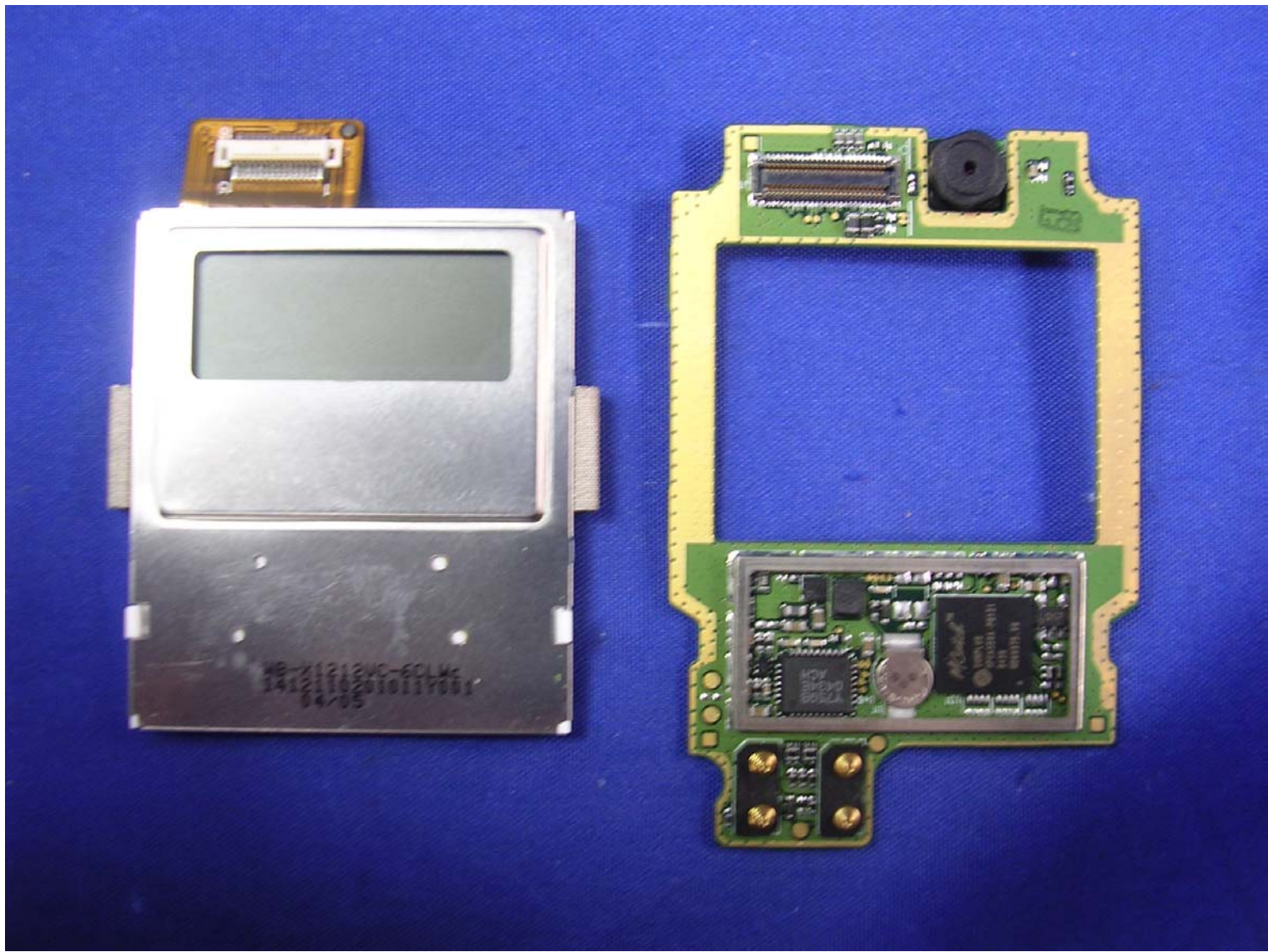

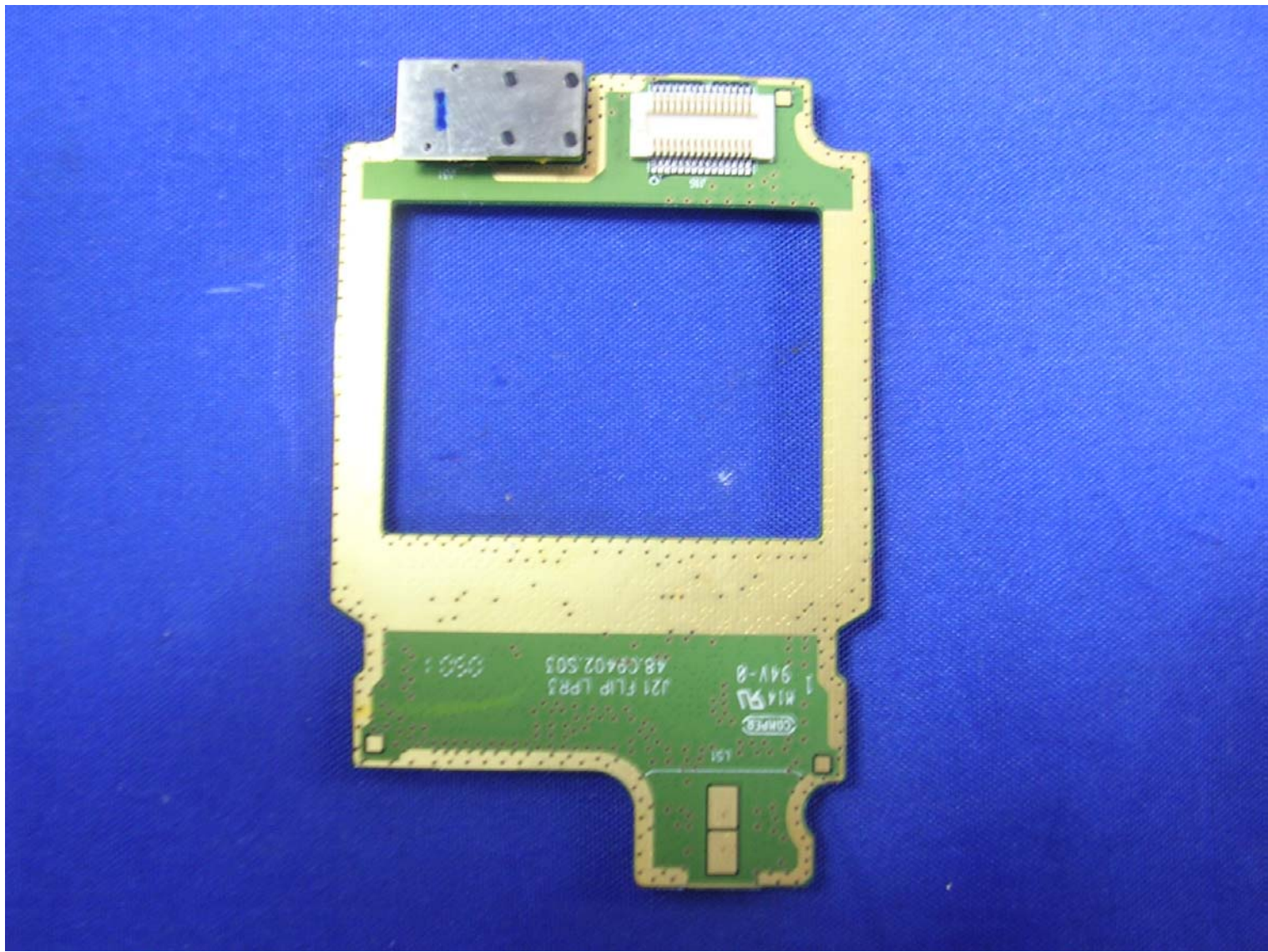

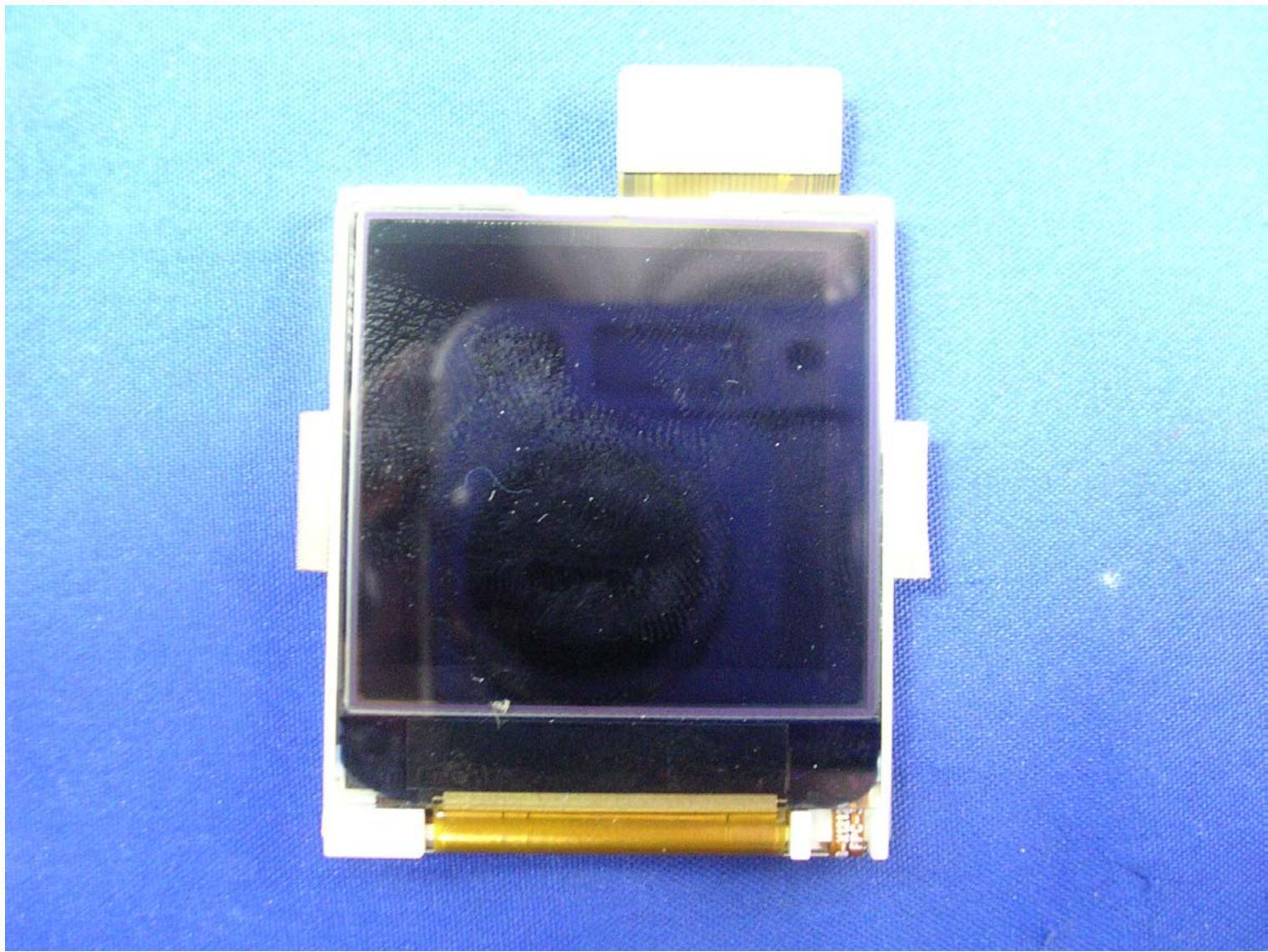

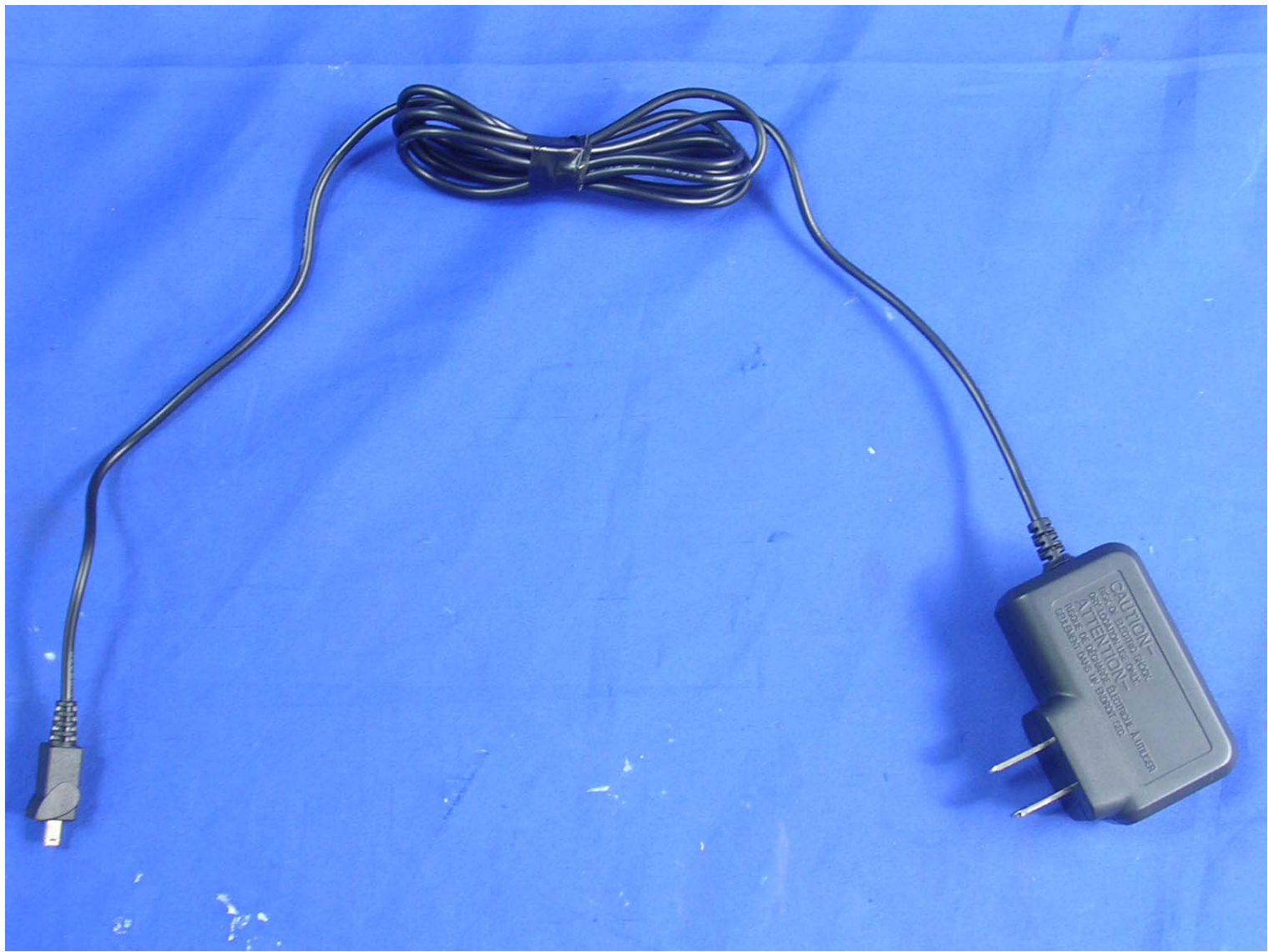

CAUTION
Do not touch the hot surface.
ATTENTION
Ne pas toucher la surface chaude.
© 2004 Intel Corporation. All rights reserved.

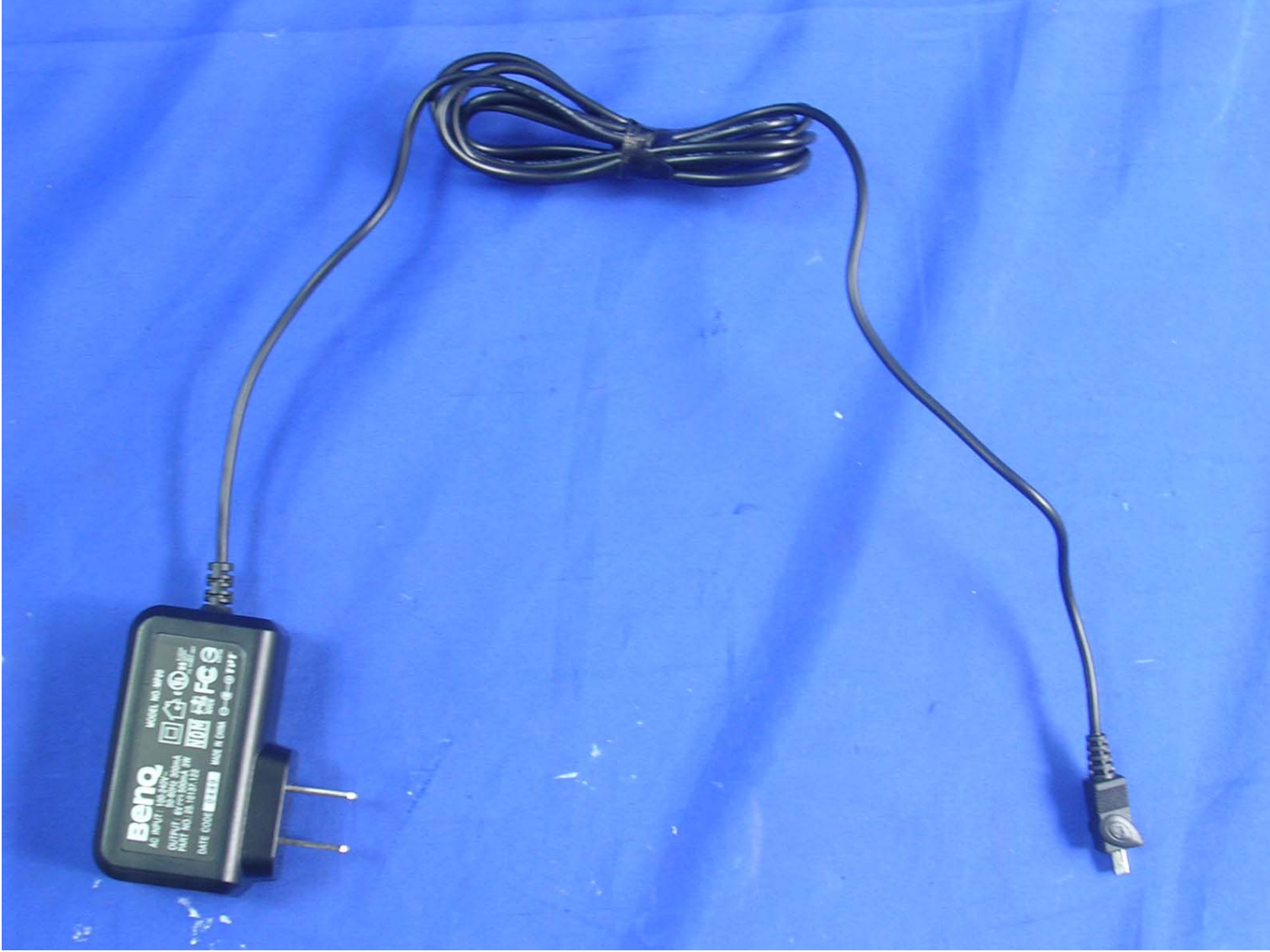

BenQ
MODEL NO. MP44
INPUT: 100-240V AC
OUTPUT: 5V DC 1.5A
PART NO. 600000000000
DATE CODE: 000000000000 MADE IN CHINA

Benq

MODEL NO.:MP20

AC INPUT: 100-240V~
50-60Hz 300mA

OUTPUT: 6V $\overline{\text{---}}$ 500mA 3W
PART NO.: 25.10137.122



C



US

UL LISTED
3210
ITS POWER UNIT

NOM



FC



DATE CODE **0449**

MADE IN CHINA



TPT





