

FCC TEST REPORT

for

47 CFR Part 24E

Equipment : **Mobile Phone**
Model No. : **S700 (56E05)**
FCC ID : **JVP56E05**
Filing Type : **Certification**
Applicant : **BENQ Corporation**
157 Shan-Ying Road, Gueishan, Taoyuan 333,
Taiwan R.O.C.

- The test result refers exclusively to the test presented test model / sample.
- Without written approval of SPORTON International Inc., the test report shall not be reproduced except in full.
- **Certificate or Test Report must not be used by the applicant to claim the product in this test report endorsement by NVLAP or any agency of U.S. government.**

SPORTON International Inc.

6F, No.106, Sec. 1, Hsin Tai Wu Rd., Hsi Chih, Taipei Hsien, Taiwan, R.O.C.

The applicant has been cautioned as to the following:

15.21 Information to User.

The users manual or instruction manual for an intentional radiator shall caution the user that changes or modifications not expressly approved by the party responsible for compliance could void the user's authority to operate the equipment.

15.27(a) Special Accessories.

Equipment marketed to a consumer must be capable of complying with the necessary regulations in the configuration in which the equipment is marketed. Where special accessories, such as shielded cables and/or special connectors are required to enable an unintentional or intentional radiator to comply with the emission limits in this part, the equipment must be marketed with, i.e. shipped and sold with, those special accessories. However, in lieu of shipping or packaging the special accessories with the unintentional or intentional radiator, the responsible party may employ other methods of ensuring that the special accessories are provided to the consumer, without additional charge.

Information detailing any alternative method used to supply the special accessories for a grant of equipment authorization or retained in the verification records, as appropriate. The party responsible for the equipment, as detailed in § 2.909 of this chapter, shall ensure that these special accessories are provided with the equipment. The instruction manual for such devices shall include appropriate instructions on the first page of text concerned with the installation of the device that these special accessories must be used with the device. It is the responsibility of the user to use the needed special accessories supplied with the equipment.

Table of Contents

Rule	Description	Page
	Test Report	4
2.1033(c)	General Information Required	5
2.1033(c)(14)	Rule Summary	9
	General Information	10
	Standard Test Conditions and Engineering Practices	11
2.1046(a)	EIRP Carrier Power (Radiated)	12
2.1051, 2.1049(c), 24, 24.238(b)	Transmitter Conducted Measurements	17
	Conducted Spurious Emission	23
2.1053(a)	Field Strength of Spurious Radiation	28
2.1055(a)(1)	Frequency Stability (Temperature Variation)	45
2.1055(b)(1)	Frequency Stability (Voltage Variation)	46
	Antenna Factor & Cable Loss	49
	List of Measuring Equipments	50
	Uncertainty of Test Site	51
Appendix A	External Product Photograph	
Appendix B	Internal Photograph	
Appendix C	Set up Photograph	

Required information per ISO/IEC Guide 25-1990, paragraph 13.2:

a) **Test Report**

b) Laboratory: Sporton International Inc.
No.52, Hwa-Ya 1st RD., Hwa Ya Technology Park, Kwei-Shan
Hsiang, TaoYuan Hsien, Taiwan, R.O.C.

c) Report Number: F481204

d) Client: BENQ Corporation
157 Shan-Ying Road, Gueishan, Taoyuan, 333, Taiwan R.O.C.

e) Identification: Model Name: S700 (56E05)
FCC ID : JVP56E05
Description: GSM 1900 Radio

f) EUT Condition: Not required unless specified in individual tests.

g) Report Date: Aug. 12, 2004
EUT Received: Aug. 12, 2004

h, j, k): As indicated in individual tests.

i) Sampling method: No sampling procedure used.

l) Uncertainty: In accordance with Sporton internal quality manual.

m) Supervised by:

Hendry Yang

n) Results: The results presented in this report relate only to the item tested.

o) Reproduction: This report must not be reproduced, except in full, without written permission from this laboratory.

Accessories Used During Testing:

Type	Model
EUT	S700 (56E05)
Earpiece	N/A

List of General Information Required for Certification

In Accordance with FCC Rules and Regulations,
Volume II, Part 2 and
24E, Confidentiality

Sub-Part 2.1033

(c)(1): Name and Address of Applicant:

BENQ Corporation
157 Shan-Ying Road, Gueishan, Taoyuan 333,
Taiwan R.O.C.

Manufacturer

BENQ Corporation
157 Shan-Ying Road, Gueishan, Taoyuan 333,
Taiwan R.O.C.

(c)(2): FCC ID: JVP56E05

Model Number: S700 (56E05)

(c)(3): Instruction Manual(s):

Please See Attached Exhibits

(c)(4): Type of Emission: 300 KGXW

(c)(5): FREQUENCY RANGE, MHz: 1850.2 to 1909.8

(c)(6): Power Rating, Watts: 0.871 (conducted)
0.361 (EIRP)
x Switchable Variable N/A

(c)(7): Maximum Power Rating, Watts: 1

Subpart 2.1033 (continued)

(c)(8): Voltages & Currents in All Elements in Final RF Stage, Including Final Transistor or Solid State Device:

Collector Current, A = 0.5
Collector Voltage, Vdc = 3.6
Supply Voltage, Vdc = 3.6

(c)(9): **Tune-Up Procedure:**

Please See Attached Exhibits

(c)(10): **Circuit Diagram/Circuit Description:**

Please See Attached Exhibits

(c)(11): **Label Information:**

Please See Attached Exhibits

(c)(12): **Photographs:**

Please See Attached Exhibits

(c)(13): **Digital Modulation Description:**

Attached Exhibits
 N/A

(c)(14): **Test and Measurement Data:**

Follows

**Testimonial
and
Statement of Certification**

This is to certify that:

1. **That** the application was prepared either by, or under the direct supervision of, the undersigned.
2. **That** the technical data supplied with the application was taken under my direction and supervision.
3. **That** the data was obtained on representative units, randomly selected.
4. **That**, to the best of my knowledge and belief, the facts set forth in the application and accompanying technical data are true and correct.

Certified by:

Daniel Lee 8/30/2004

Daniel Lee
Manager

Certificate of NVLAP Accreditation

United States Department of Commerce
National Institute of Standards and Technology

NVLAP[®]

Certificate of Accreditation

SPORTON INTERNATIONAL, INC.
TAIPEI HSIEN 221
TAIWAN

*is recognized by the National Voluntary Laboratory Accreditation Program
for satisfactory compliance with criteria set forth in NIST Handbook 150:2001,
all requirements of ISO/IEC 17025:1999, and relevant requirements of ISO 9002:1994.
Accreditation is awarded for specific services, listed on the Scope of Accreditation, for:*

ELECTROMAGNETIC COMPATIBILITY AND TELECOMMUNICATIONS

December 31, 2004

Effective through

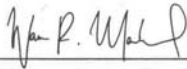
For the National Institute of Standards and Technology
NVLAP Lab Code: 200079-0



ISO/IEC 17025:1999
ISO 9002:1994

NVLAP-01C (06-01)

Sub-part

2.1033(c)(14): Test and Measurement Data

All tests and measurement data shown were performed in accordance with FCC Rules and Regulations, Volume II; Part 2, Sub-part J, Sections 2.947, 2.1033(c), 2.1041, 2.1046, 2.1047, 2.1079, 2.1051, 2.1053, 2.1055, 2.1057 and the following individual Parts:

- 22 – Public Mobile Services
- 22 Subpart H - Cellular Radiotelephone Service
- x 24 – Personal Communications Services

General Information

Product Feature & Specification	
1. Type of Modulation	GMSK
2. Number of Channels	GSM 1900 : 512 to 810
3. Frequency Band , MHz	Tx: 1850-1910 Rx: 1930-1990
4. Channel Spacing	200 KHz
5. Maximum Output Power to Antenna	29.4 dBm
6. HW Version	LPR3
7. SW Version	1.0 (FTA / TTPCOM 6.52)
8. Antenna Type	Fixed External Antenna

**Standard Test Conditions
and
Engineering Practices**

Except as noted herein, the following conditions and procedures were observed during the testing:

In accordance with TIA603, and unless otherwise indicated in the specific measurement results, the ambient temperature of the actual EUT was maintained within the range of 10° to 40°C (50° to 104 °F) unless the particular equipment requirements specify testing over a different temperature range. Also, unless otherwise indicated, the humidity levels were in the range of 10% to 90% relative humidity.

Prior to testing, the EUT was tuned up in accordance with the manufacturer's alignment procedures. All external gain controls were maintained at the position of maximum and/or optimum gain throughout the testing.

Measurement results, unless otherwise noted, are worst-case measurements.

Name of Test: EIRP Carrier Power (Radiated)

Specification: TIA/EIA 603A (Substitution Method)

Definition: The average radiated power of device is the equivalent power required, when delivered to a substitution antenna, to produce at a distant point the same average received power as produced by the licensed device.

Method Of Measurement:

a) Connect the equipment as illustrated. Place the transmitter to be tested on the turntable in the standard test site.

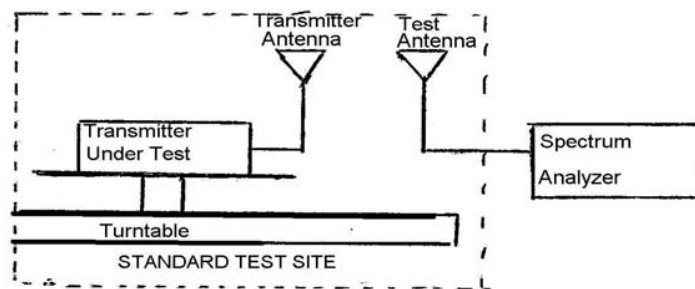

b) Raise and lower the test antenna from 1m to 4m and rotate turntable from 0° to 360°. Record the highest received signal showed in spectrum analyzer as R_t . Calculate electric field strength in receive antenna as E_t .

$$E_t = R_t + AF$$

AF (dB/m): Receive Antenna Factor

c) Replace the transmitter under test with a substitution antenna. The center of the antenna should be at the same location as the transmitter under test. Connect the antenna to a signal generator with a known output power level P_s . Raise and lower the test antenna like in step b) and record the highest received signal showed in spectrum analyzer as R_s . Calculate electric field strength in receive antenna as E_s .

$$E_s = R_s + AF$$

AF (dB/m): Receive Antenna Factor

d) Calculate radiated power as following:

$$EIRP = P_s + E_t - E_s + G_s$$

P_s (dBm): Input Power to Substitution Antenna

G_s (dBi) : Substitution Antenna Gain

Results Attached

Tim Kao

Tested By:

Tim Kao

Test Results For: EIRP Carrier Power (Radiated)

Conducted Power

Bands	Channel	Frequency (MHz)	Conducted Power (dBm)	Conducted Power (Watts)
GSM 1900	512	1850.2 (Low)	29.4	0.871
	661	1880.0 (Mid)	29.3	0.851
	810	1909.8 (High)	29.0	0.798

EIRP

Freq MHz	Pol	Substitution Antenna Input Power (dBm)	Substitution Antenna Gain (dBi)	Et (dBuV/m)	Es (dBuV/m)	Et - Es (dB)	Radiated Power (dBm)	Radiated Power (Watts)
1850.27	H	-3.76	6.64	119.62	101.70	17.92	20.81	0.120
1880.07	H	-3.78	6.65	118.88	101.64	17.24	20.11	0.103
1909.87	H	-3.81	6.66	116.85	101.58	15.27	18.12	0.065
1850.15	V	-3.76	6.64	123.85	101.70	22.15	25.04	0.319
1879.90	V	-3.78	6.65	121.76	101.64	20.12	22.99	0.199
1909.83	V	-3.81	6.66	124.30	101.58	22.72	25.57	0.361

GSM 1900 CH512 Horizontal Polarization

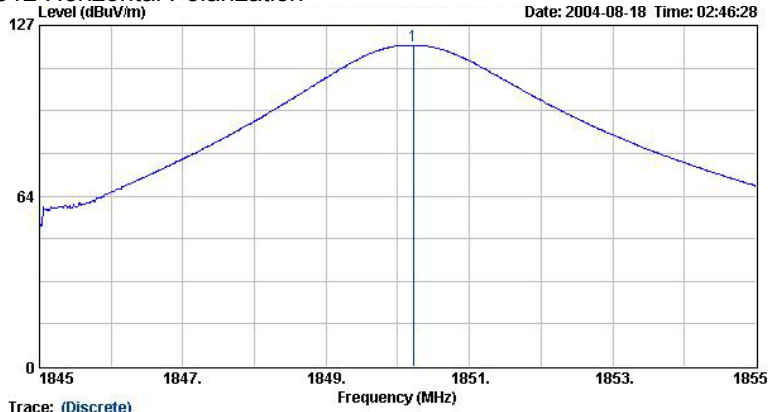

Trace: (Discrete)
 Site : 03CH06
 Condition : 3m HF-HORN AH-118 HORIZONTAL
 EUT : Tri Band 900/1800/1900 Handset
 Power : 120Vac/60Hz
 Model : S700
 Memo : PCS Link Mode ; CH 512

	Freq	Over Limit	Level	Limit	Antenna Line	Preamp Factor	Cable Loss	Remark	Ant Pos	Table Pos
	MHz	dB	dBuV/m	dBuV/m	dB/m	dB	dB		cm	deg
1 @	1850.22	-----	119.62	-----	27.25	0.00	2.91	Peak	---	---

GSM 1900 CH512 Vertical Polarization

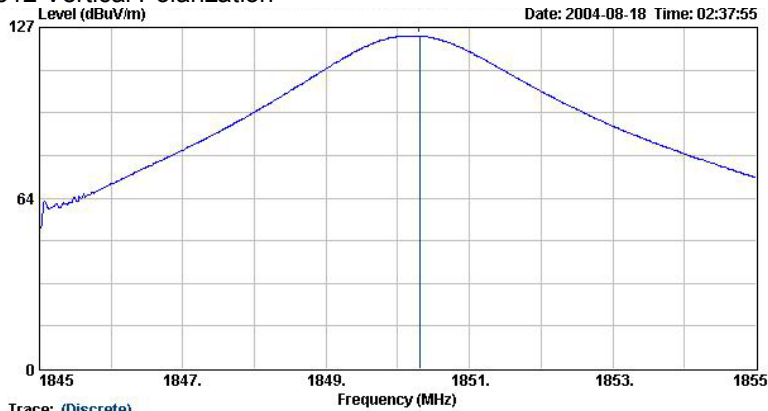

Trace: (Discrete)
 Site : 03CH06
 Condition : 3m HF-HORN AH-118 VERTICAL
 EUT : Tri Band 900/1800/1900 Handset
 Power : 120Vac/60Hz
 Model : S700
 Memo : PCS Link Mode ; CH 512

	Freq	Over Limit	Level	Limit	Antenna Line	Preamp Factor	Cable Loss	Remark	Ant Pos	Table Pos
	MHz	dB	dBuV/m	dBuV/m	dB/m	dB	dB		cm	deg
1 @	1850.30	-----	123.85	-----	27.25	0.00	2.91	Peak	---	---

GSM 1900 CH661 Horizontal Polarization

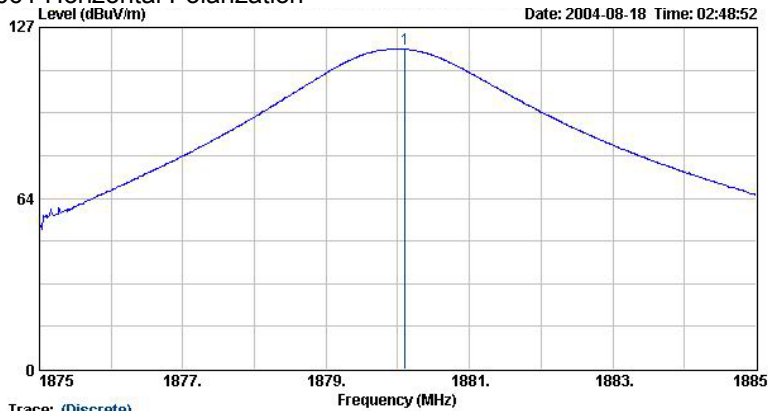

Trace: (Discrete)
 Site : 03CH06
 Condition : 3m HF-HORN AH-118 HORIZONTAL
 EUT : Tri Band 900/1800/1900 Handset
 Power : 120Vac/60Hz
 Model : S700
 Memo : PCS Link Mode ; CH 661

	Freq	Over Limit	Level	LimitAntenna Line	Antenna Factor	Preamp Factor	Cable Loss	Remark	Ant Pos	Table Pos
	MHz	dB	dBuV/m	dBuV/m	dB/m	dB	dB		cm	deg
1 @	1880.10	-----	118.88	-----	27.42	0.00	2.95	Peak	---	---

GSM 1900 CH661 Vertical Polarization

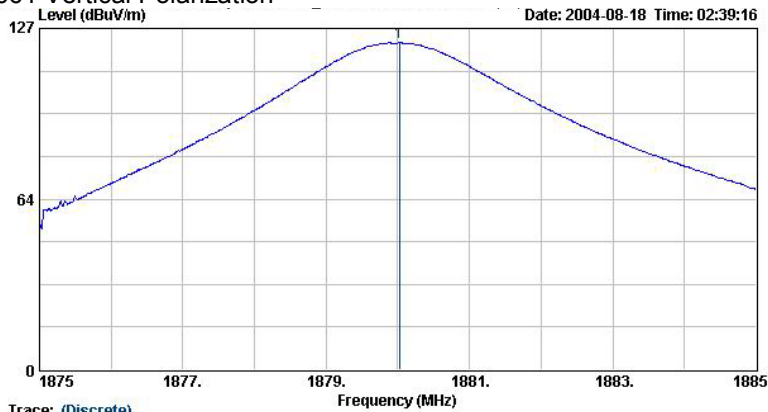

Trace: (Discrete)
 Site : 03CH06
 Condition : 3m HF-HORN AH-118 VERTICAL
 EUT : Tri Band 900/1800/1900 Handset
 Power : 120Vac/60Hz
 Model : S700
 Memo : PCS Link Mode ; CH 661

	Freq	Over Limit	Level	LimitAntenna Line	Antenna Factor	Preamp Factor	Cable Loss	Remark	Ant Pos	Table Pos
	MHz	dB	dBuV/m	dBuV/m	dB/m	dB	dB		cm	deg
1 @	1880.02	-----	121.76	-----	27.42	0.00	2.95	Peak	---	---

GSM 1900 CH810 Horizontal Polarization

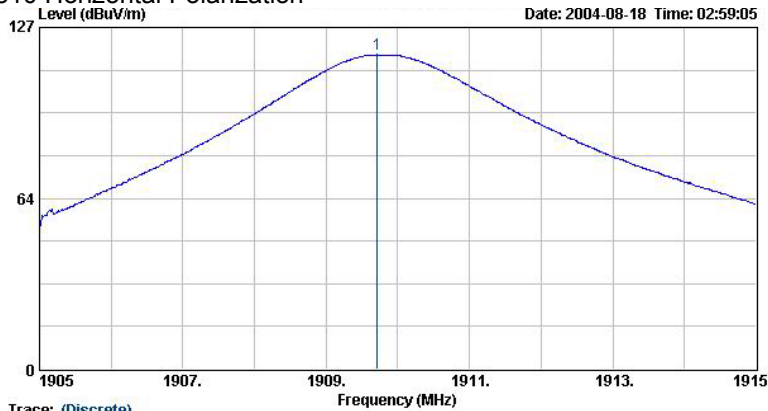

Trace: (Discrete)
 Site : 03CH06
 Condition : 3m HF-HORN AH-118 HORIZONTAL
 EUT : Tri Band 900/1800/1900 Handset
 Power : 120Vac/60Hz
 Model : S700
 Memo : PCS Link Mode ; CH 810

	Freq	Over Limit	Level	Limit	Antenna Line	Preamp Factor	Cable Loss	Remark	Ant Pos	Table Pos
	MHz	dB	dBuV/m	dBuV/m	dB/m	dB	dB		cm	deg
1 @	1909.71	-----	116.85	-----	27.58	0.00	2.98	Peak	---	---

GSM 1900 CH810 Vertical Polarization

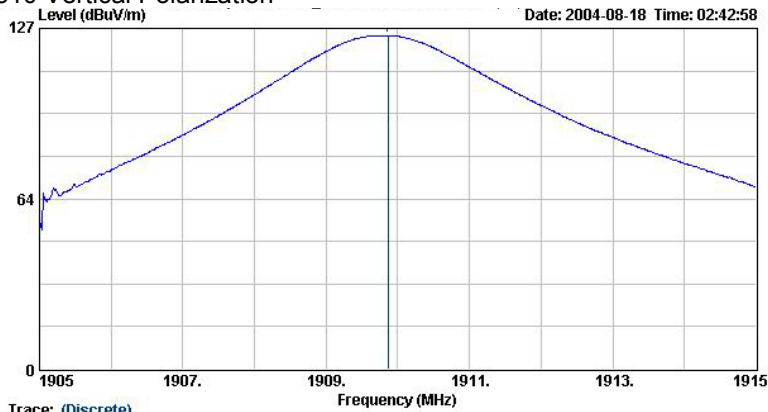

Trace: (Discrete)
 Site : 03CH06
 Condition : 3m HF-HORN AH-118 VERTICAL
 EUT : Tri Band 900/1800/1900 Handset
 Power : 120Vac/60Hz
 Model : S700
 Memo : PCS Link Mode ; CH 810

	Freq	Over Limit	Level	Limit	Antenna Line	Preamp Factor	Cable Loss	Remark	Ant Pos	Table Pos
	MHz	dB	dBuV/m	dBuV/m	dB/m	dB	dB		cm	deg
1 @	1909.86	-----	124.30	-----	27.58	0.00	2.98	Peak	---	---

Name of Test: Transmitter Conducted Measurements

Specification: 47 CFR 2.1051: Unwanted (spurious) Emissions
2.1049(c), 24.238(b): Occupied Bandwidth
24: Emissions at Band Edges

Test Equipment: As per attached page

Measurement Procedure

1. The EUT and test equipment were set up as shown on the following page with the Spectrum Analyzer connected.
2. The low and high channels for all RF powers within the transmitting frequency band were measured.
3. Measurement Results: Attached



Tested By:

Tim Kao

Transmitter Spurious Emission

Test A. Occupied Bandwidth (In-Band Spurious)
Test B. Out-of-Band Spurious

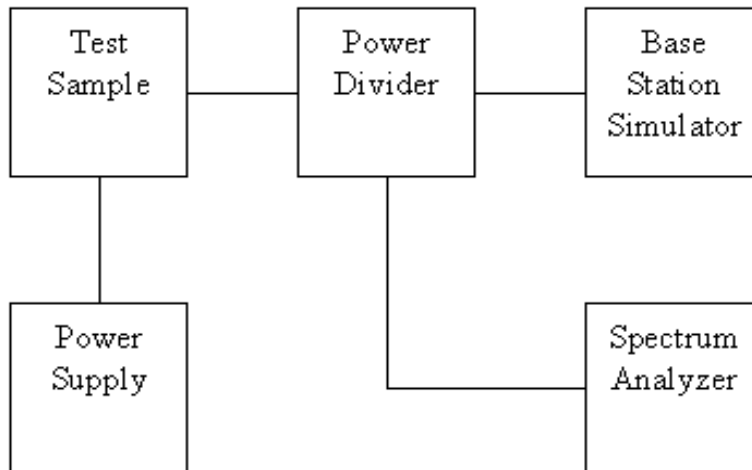

Asset	Model Name	S/N
Base Station Simulator	CMU200	102278
Base Station Simulator	E5515C	GB43460754
Spectrum Analyzer	FSP30	838858/014
AC/DC Power Source	HPA-500W	HPA0100024

Name of Test: Emission Masks (Occupied Bandwidth)
State 2:High Power

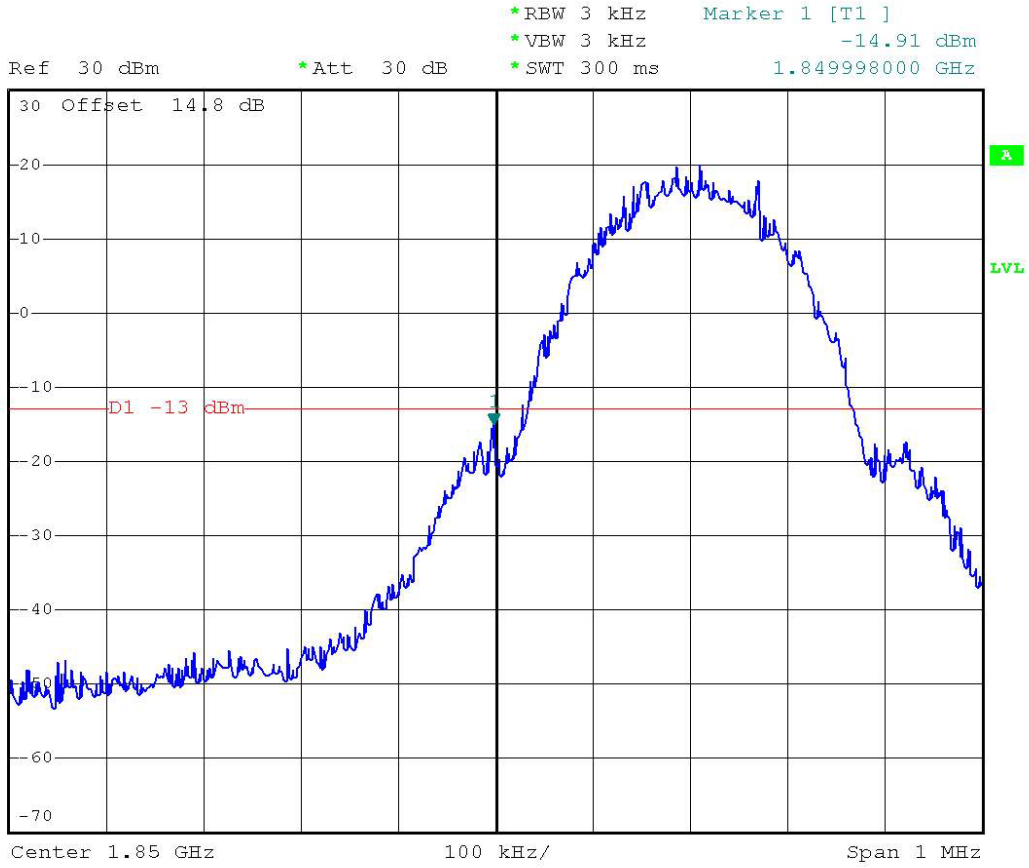

Power: HIGH
Modulation: GSM 1900
LOWER BAND EDGE

Name of Test: Emission Masks (Occupied Bandwidth)
 State 1:Low Power



*RBW 3 kHz Marker 1 [T1]
 *VBW 3 kHz -9.55 dBm
 *SWT 300 ms 1.879954000 GHz

Ref 30 dBm *Att 30 dB

1 PK
 VIEW

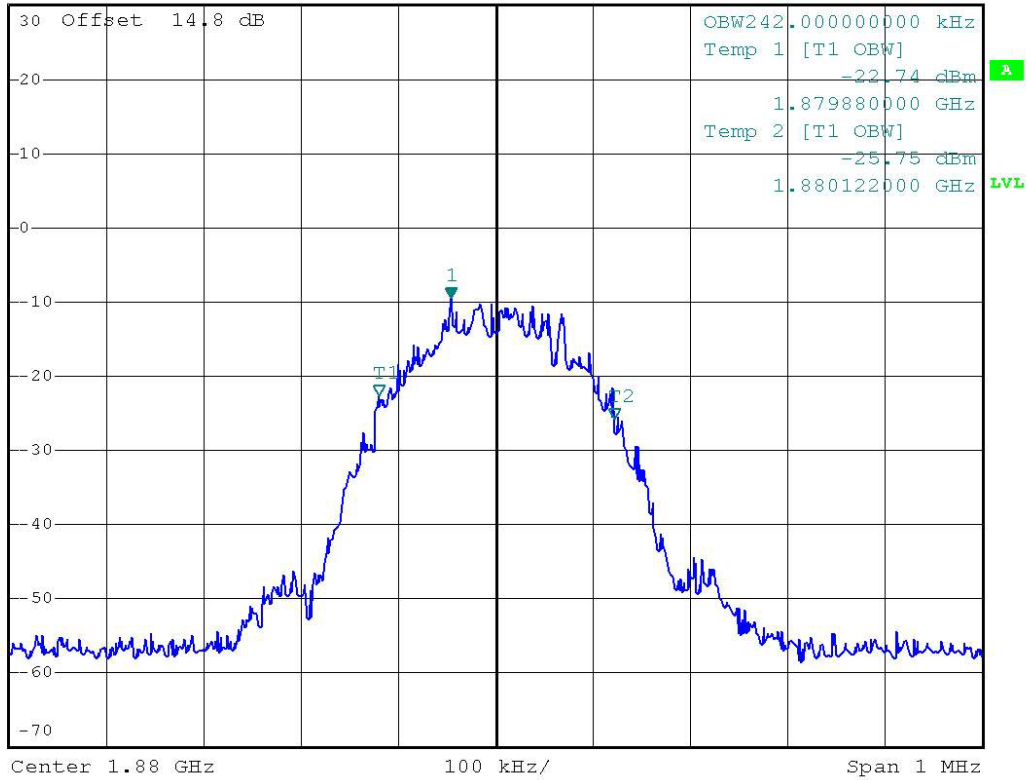

Power: LOW
 Modulation: GSM 1900
 99% BANDWIDTH

Name of Test: Emission Masks (Occupied Bandwidth)
 State 2:High Power

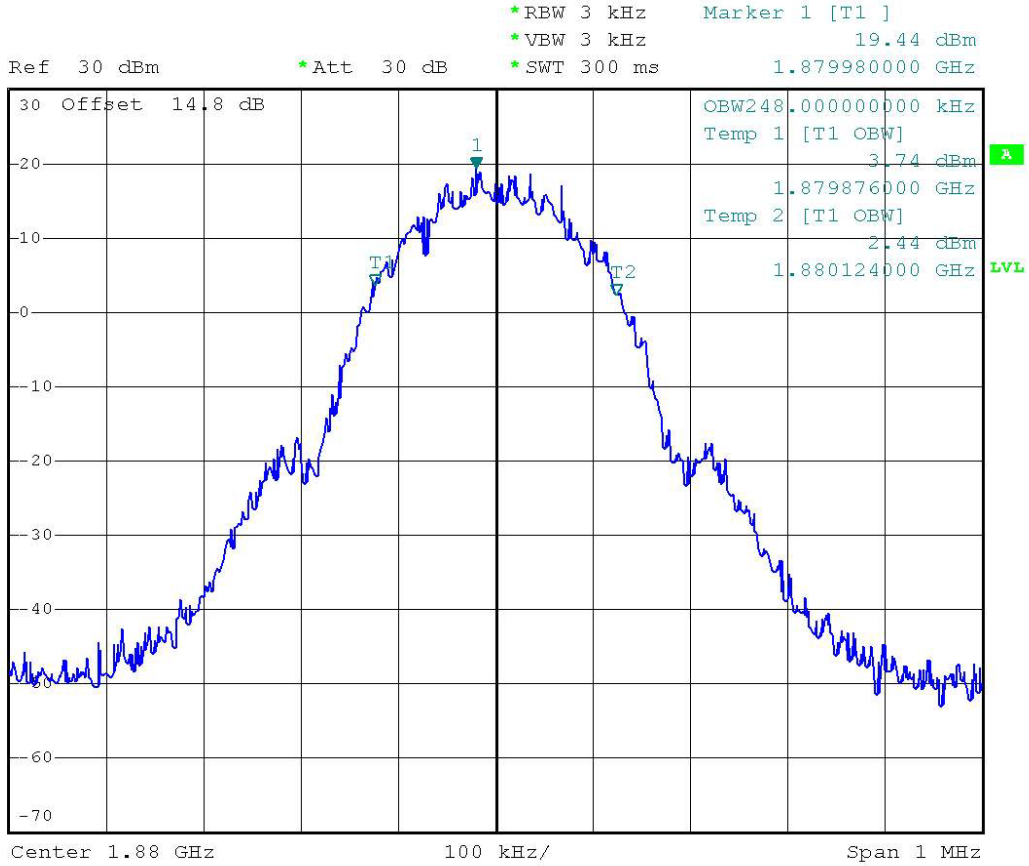

Power: HIGH
 Modulation: GSM 1900
 99% BANDWIDTH

Name of Test: Emission Masks (Occupied Bandwidth)
State 2:High Power

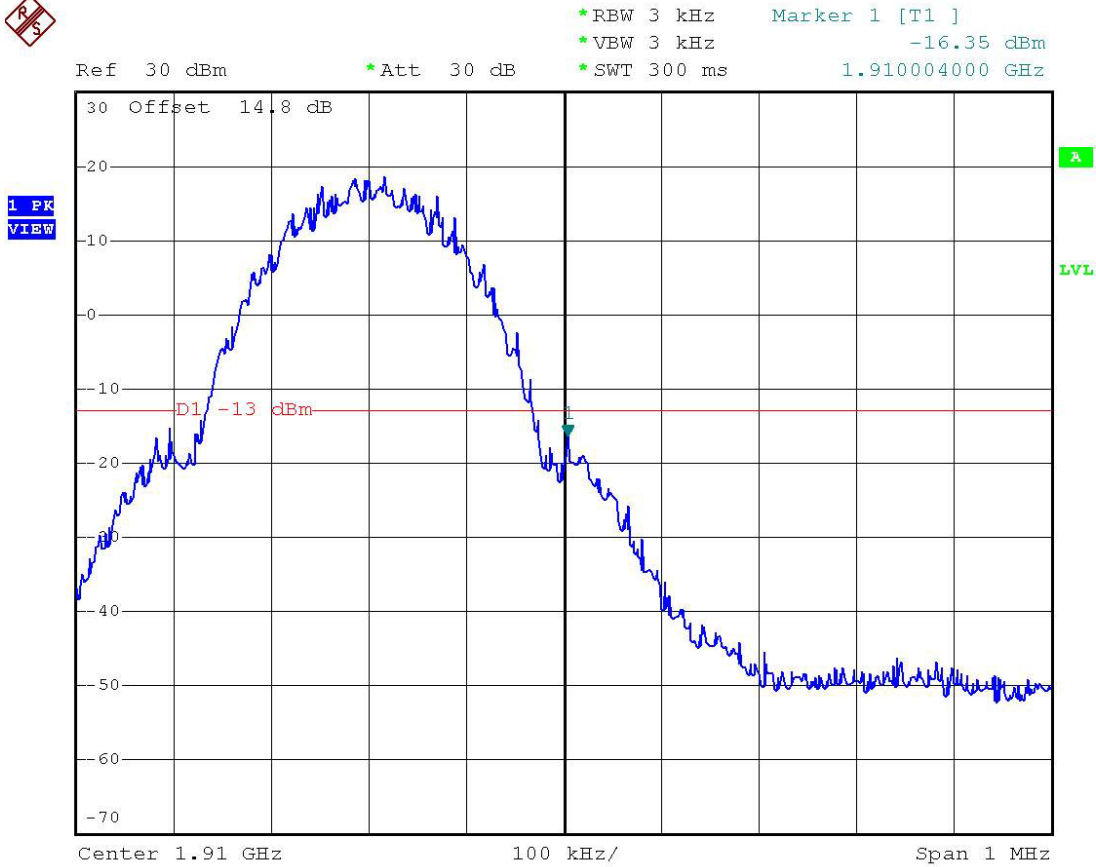

Power: HIGH
Modulation: GSM 1900
UPPER BAND EDGE

Name of Test: Conducted Spurious Emission
30M-1G

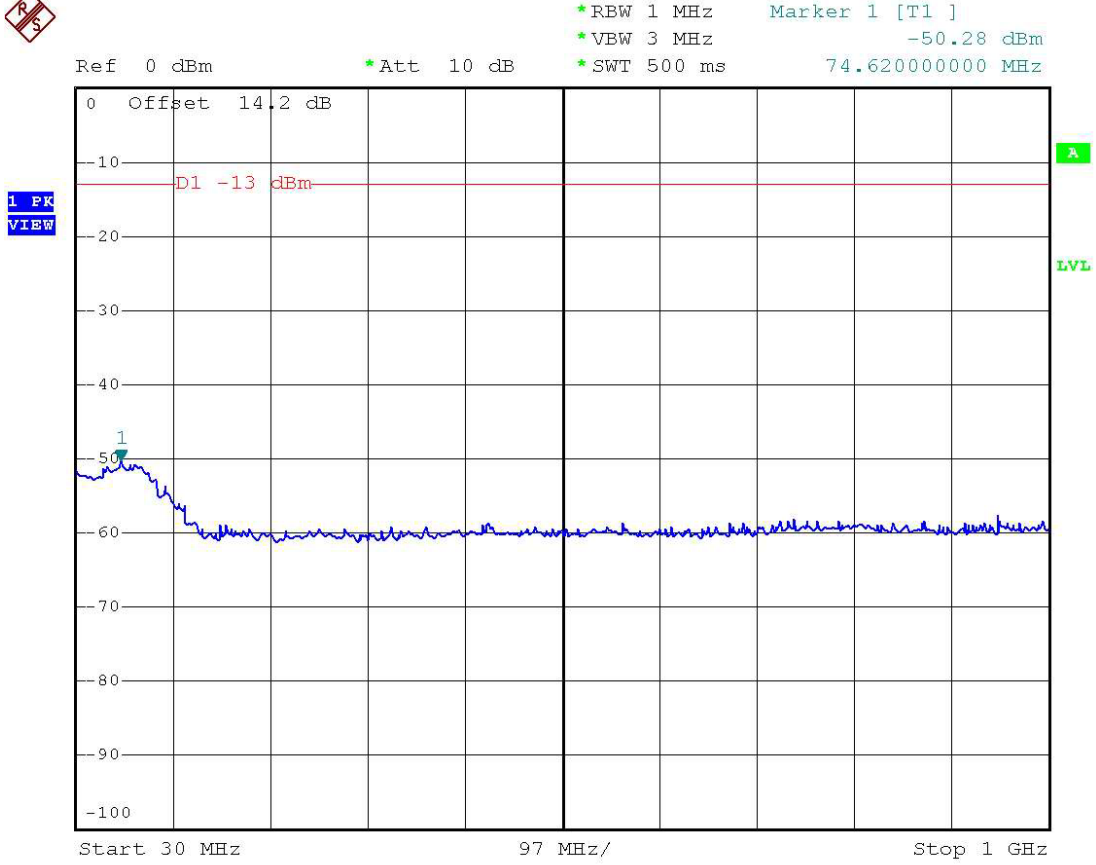

Name of Test: Conducted Spurious Emission
1G-3G

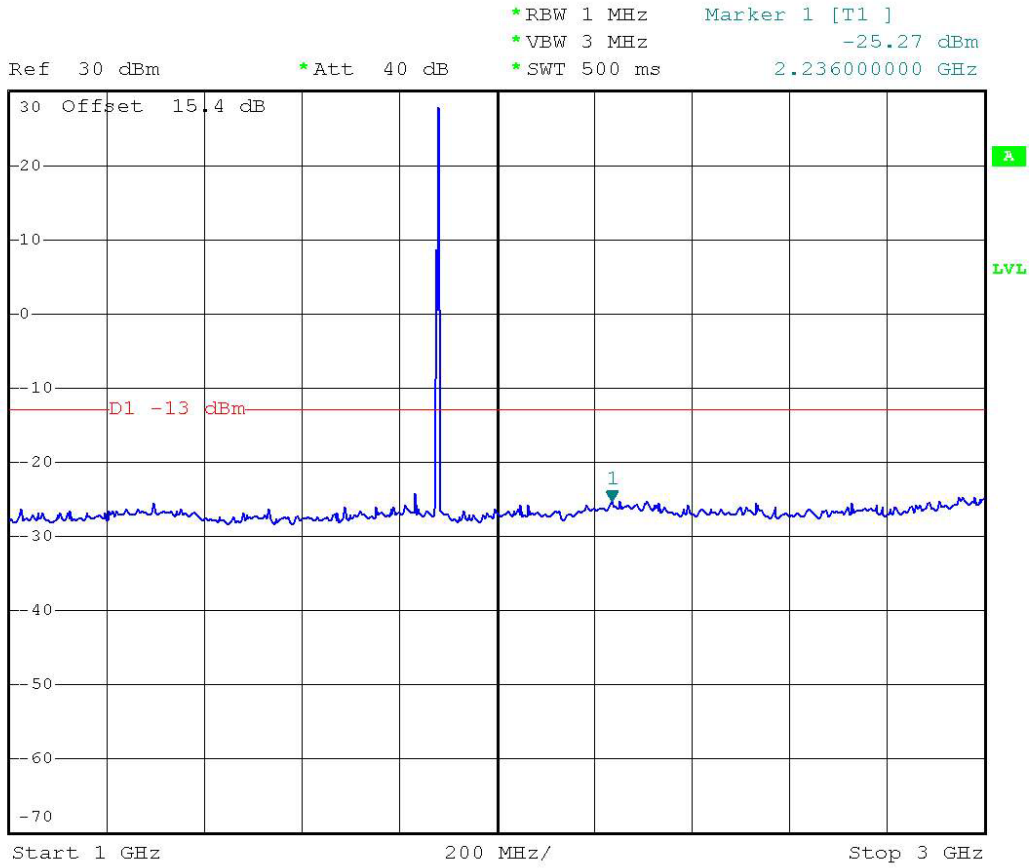

Name of Test: Conducted Spurious Emission
3G-7G



*RBW 1 MHz Delta 2 [T1]
*VBW 3 MHz -6.43 dB
*SWT 500 ms 1.880000000 GHz

Ref 0 dBm

*Att 0 dB

1 PK
VIEW

