



**FCC 47 CFR PART 15 SUBPART C &  
INDUSTRY CANADA RSS-210**

**TEST REPORT**

**For**

**PDA**

**Model: TNJ32**

**Trade Name: Trimble**

*Issued to*

**For FCC**

**Trimble Navigation Ltd.**

**935 Stewart Drive, Sunnyvale, CA 94088-3642 U.S.A.**

**For IC**

**Trimble Navigation Ltd.**

**935 Stewart Drive,**

**Sunnyvale California 94085 United States**

*Issued by*

**Compliance Certification Services Inc.**

**No.11, Wu-Gong 6th Rd., Wugu Industrial Park,**

**New Taipei City 248, Taiwan (R.O.C.)**

**<http://www.ccsrf.com>**

**[service@ccsrf.com](mailto:service@ccsrf.com)**

**Issued Date: January 9, 2012**



---

*Note: This report shall not be reproduced except in full, without the written approval of Compliance Certification Services Inc. This document may be altered or revised by Compliance Certification Services Inc. personnel only, and shall be noted in the revision section of the document.*



**Revision History**

| Rev. | Issue Date      | Revisions     | Effect Page | Revised By  |
|------|-----------------|---------------|-------------|-------------|
| 00   | January 9, 2012 | Initial Issue | ALL         | Eunice Shen |



## TABLE OF CONTENTS

|   |           |
|---|-----------|
| <b>1. TEST RESULT CERTIFICATION.....</b>                                | <b>4</b>  |
| <b>2. EUT DESCRIPTION .....</b>   | <b>5</b>  |
| <b>3. TEST METHODOLOGY .....</b>  | <b>6</b>  |
| 3.1 EUT CONFIGURATION .....   | 6         |
| 3.2 EUT EXERCISE.....   | 6         |
| 3.3 GENERAL TEST PROCEDURES.....  | 6         |
| 3.4 FCC PART 15.205 RESTRICTED BANDS OF OPERATIONS.....                 | 7         |
| 3.5 DESCRIPTION OF TEST MODES .....                                     | 8         |
| <b>4. INSTRUMENT CALIBRATION.....</b>                                   | <b>9</b>  |
| 4.1 MEASURING INSTRUMENT CALIBRATION .....                              | 9         |
| 4.2 MEASUREMENT EQUIPMENT USED .....                                    | 9         |
| 4.3 MEASUREMENT UNCERTAINTY .....                                       | 10        |
| <b>5. FACILITIES AND ACCREDITATIONS .....</b>                           | <b>11</b> |
| 5.1 FACILITIES .....  | 11        |
| 5.2 EQUIPMENT.....  | 11        |
| 5.3 TABLE OF ACCREDITATIONS AND LISTINGS.....                           | 12        |
| <b>6. SETUP OF EQUIPMENT UNDER TEST .....</b>                           | <b>13</b> |
| 6.1 SETUP CONFIGURATION OF EUT.....                                     | 13        |
| 6.2 SUPPORT EQUIPMENT .....   | 13        |
| <b>7. APPLICABLE RULES .....</b>  | <b>14</b> |
| <b>8. FCC PART 15.247 REQUIREMENTS &amp; RSS 210 REQUIREMENTS .....</b> | <b>23</b> |
| 8.1 99% BANDWIDTH .....   | 23        |
| 8.2 20 DB BANDWIDTH.....  | 27        |
| 8.3 PEAK POWER.....   | 34        |
| 8.4 AVERAGE POWER .....   | 35        |
| 8.5 BAND EDGES MEASUREMENT .....  | 36        |
| 8.6 FREQUENCY SEPARATION .....  | 51        |
| 8.7 NUMBER OF HOPPING FREQUENCY.....                                    | 56        |
| 8.8 TIME OF OCCUPANCY (DWELL TIME) .....                                | 61        |
| 8.9 SPURIOUS EMISSIONS .....  | 70        |
| 8.10 POWERLINE CONDUCTED EMISSIONS.....                                 | 89        |
| <b>APPENDIX I RADIO FREQUENCY EXPOSURE.....</b>                         | <b>92</b> |
| <b>APPENDIX II PHOTOGRAPHS OF TEST SETUP.....</b>                       | <b>93</b> |
| <b>APPENDIX 1 - PHOTOGRAPHS OF EUT</b>                                  |           |



# 1. TEST RESULT CERTIFICATION

**Applicant:** For FCC  
 Trimble Navigation Ltd.  
 935 Stewart Drive, Sunnyvale, CA 94088-3642 U.S.A.  
 For IC  
 Trimble Navigation Ltd.  
 935 Stewart Drive, Sunnyvale California 94085 United States

**Manufacturer:** GOLDTEK Technology Co., Ltd.  
 6F., No. 3, Ln 768, Sec.4, Pateh Rd., Taipei 115, Taiwan, R.O.C.

**Equipment Under Test:** PDA

**Trade Name:** Trimble

**Model:** TNJ32

**Date of Test:** December 16, 2011 ~ January 9, 2012

| APPLICABLE STANDARDS  |                         |
|---|-------------------------|
| STANDARD  | TEST RESULT             |
| FCC 47 CFR Part 15 Subpart C<br>&<br>Industry Canada RSS-210 Issue 8 December, 2010 | No non-compliance noted |

## We hereby certify that:

The above equipment was tested by Compliance Certification Services Inc. The test data, data evaluation, test procedures, and equipment configurations shown in this report were made in accordance with the procedures given in **ANSI C63.4: 2003** and the energy emitted by the sample EUT tested as described in this report is in compliance with the requirements of FCC Rules Part 15.207, 15.209, 15.247.

The test results of this report relate only to the tested sample EUT identified in this report.

Approved by:

Reviewed by:

*Jason Lin*

*Gina Lo*

---

Jason Lin  
 Section Manager  
 Compliance Certification Services Inc.

---

Gina Lo  
 Section Manager  
 Compliance Certification Services Inc.



## 2. EUT DESCRIPTION

|                              |   |
|------------------------------|---|
| <b>Product</b>               | PDA   |
| <b>Trade Name</b>            | Trimble   |
| <b>Model Number</b>          | TNJ32   |
| <b>Model Discrepancy</b>     | N/A   |
| <b>Received Date</b>         | December 15, 2011   |
| <b>Power Supply</b>          | 1. Power Adapter<br>ENG / 3A182WP05<br>I/P: 100-240V, 50-60Hz, 0.6A<br>O/P: 5V, 3.0A<br>2. Li-ion Polymer Battery<br>Model: 707-0008-00A<br>Rating: DC 3.7V, 3060mAh, 11.32W/hr |
| <b>Frequency Range</b>       | 2402 ~ 2480 MHz   |
| <b>Transmit Power</b>        | 1.20 dBm  |
| <b>Modulation Technique</b>  | GFSK for 1Mbps; $\pi/4$ -DQPSK for 2Mbps; 8DPSK for 3Mbps   |
| <b>Number of Channels</b>    | 79 Channels   |
| <b>Antenna Specification</b> | Gain: 1.24 dBi  |
| <b>Antenna Designation</b>   | PIFA Antenna  |

**Remark:**

1. The sample selected for test was engineering sample that approximated to production product and was provided by manufacturer.
2. This submittal(s) (test report) is intended for FCC ID: **JUP96420** filing to comply with Section 15.207, 15.209 and 15.247 of the FCC Part 15, Subpart C Rules.



### **3. TEST METHODOLOGY**

The tests documented in this report were performed in accordance with ANSI C63.4: 2003 and FCC CFR 47 FCC CFR 47 Part 15.207, 15.209 and 15.247, RSS-GEN Issue 2, and RSS-210 Issue 7.

#### **3.1 EUT CONFIGURATION**

The EUT configuration for testing is installed on RF field strength measurement to meet the Commissions requirement and operating in a manner that intends to maximize its emission characteristics in a continuous normal application.

#### **3.2 EUT EXERCISE**

The EUT was operated in the engineering mode to fix the TX frequency that was for the purpose of the measurements.

According to its specifications, the EUT must comply with the requirements of the Section 15.207, 15.209 and 15.247 under the FCC Rules Part 15 Subpart C.

The tests documented in this report were performed in accordance with IC RSS-210, IC RSS-Gen, IC RSS-102, and ANSI C63.4: 2003.

#### **3.3 GENERAL TEST PROCEDURES**

##### **Conducted Emissions**

The EUT is placed on the turntable, which is 0.8 m above ground plane. According to the requirements in Section 13.1.4.1 of ANSI C63.4 Conducted emissions from the EUT measured in the frequency range between 0.15 MHz and 30MHz using CISPR Quasi-peak and average detector modes.

##### **Radiated Emissions**

The EUT is placed on a turn table, which is 0.8 m above ground plane. The turntable shall rotate 360 degrees to determine the position of maximum emission level. EUT is set 3m away from the receiving antenna, which varied from 1m to 4m to find out the highest emission. And also, each emission was to be maximized by changing the polarization of receiving antenna both horizontal and vertical. In order to find out the maximum emissions, exploratory radiated emission measurements were made according to the requirements in Section 13.1.4.1 of ANSI C63.4: 2003.



### 3.4 FCC PART 15.205 RESTRICTED BANDS OF OPERATIONS

(a) Except as shown in paragraph (d) of this section, only spurious emissions are permitted in any of the frequency bands listed below:

| MHz                        | MHz                 | MHz             | GHz              |
|----------------------------|---------------------|-----------------|------------------|
| 0.090 - 0.110              | 16.42 - 16.423      | 399.9 - 410     | 4.5 - 5.15       |
| <sup>1</sup> 0.495 - 0.505 | 16.69475 - 16.69525 | 608 - 614       | 5.35 - 5.46      |
| 2.1735 - 2.1905            | 16.80425 - 16.80475 | 960 - 1240      | 7.25 - 7.75      |
| 4.125 - 4.128              | 25.5 - 25.67        | 1300 - 1427     | 8.025 - 8.5      |
| 4.17725 - 4.17775          | 37.5 - 38.25        | 1435 - 1626.5   | 9.0 - 9.2        |
| 4.20725 - 4.20775          | 73 - 74.6           | 1645.5 - 1646.5 | 9.3 - 9.5        |
| 6.215 - 6.218              | 74.8 - 75.2         | 1660 - 1710     | 10.6 - 12.7      |
| 6.26775 - 6.26825          | 108 - 121.94        | 1718.8 - 1722.2 | 13.25 - 13.4     |
| 6.31175 - 6.31225          | 123 - 138           | 2200 - 2300     | 14.47 - 14.5     |
| 8.291 - 8.294              | 149.9 - 150.05      | 2310 - 2390     | 15.35 - 16.2     |
| 8.362 - 8.366              | 156.52475 -         | 2483.5 - 2500   | 17.7 - 21.4      |
| 8.37625 - 8.38675          | 156.52525           | 2655 - 2900     | 22.01 - 23.12    |
| 8.41425 - 8.41475          | 156.7 - 156.9       | 3260 - 3267     | 23.6 - 24.0      |
| 12.29 - 12.293             | 162.0125 - 167.17   | 3332 - 3339     | 31.2 - 31.8      |
| 12.51975 - 12.52025        | 167.72 - 173.2      | 3345.8 - 3358   | 36.43 - 36.5     |
| 12.57675 - 12.57725        | 240 - 285           | 3600 - 4400     | ( <sup>2</sup> ) |
| 13.36 - 13.41              | 322 - 335.4         |                 |                  |

<sup>1</sup> Until February 1, 1999, this restricted band shall be 0.490-0.510 MHz.

<sup>2</sup> Above 38.6

(b) Except as provided in paragraphs (d) and (e), the field strength of emissions appearing within these frequency bands shall not exceed the limits shown in Section 15.209. At frequencies equal to or less than 1000 MHz, compliance with the limits in Section 15.209 shall be demonstrated using measurement instrumentation employing a CISPR quasi-peak detector. Above 1000 MHz, compliance with the emission limits in Section 15.209 shall be demonstrated based on the average value of the measured emissions. The provisions in Section 15.35 apply to these measurements.



### 3.5 DESCRIPTION OF TEST MODES

The EUT (model: TNJ32) had been tested under operating condition.

Test program used to control the EUT for staying in continuous transmitting mode was programmed.

Software used to control the EUT for staying in continuous transmitting mode was programmed.

After verification, all tests carried out are with the worst-case test modes as shown below except radiated spurious emission below 1GHz and power line conducted emissions below 30MHz, which worst case was in normal link mode and receiving radiated spurious emission above 1GHz, which worst case was in CH Mid mode only.

During the preliminary test, GFSK,  $\pi/4$ -QPSK & 8DPSK with DH1 were pre-tested and found that 8DPSK emits the highest output power. Then the tests were carried on with DH1 compare to DH3 & DH5 and found that 8DPSK with DH5 emit the highest output power, and therefore had been tested under operating condition.

Following channels were selected for the for radiated emission testing only as listed below:

| Tested Channel | Modulation Type | Packet Type | Date Rate |
|----------------|-----------------|-------------|-----------|
| Low, Mid, High | GFSK            | DH 5        | 1         |
| Low, Mid, High | 8DPSK           | DH 5        | 3         |

The field strength of spurious emission was measured in the following position: EUT stand-up position (Z axis), lie-down position (X, Y axis). The worst emission was found in stand-up position (Z axis) and the worst case was recorded.





## 4. INSTRUMENT CALIBRATION

### 4.1 MEASURING INSTRUMENT CALIBRATION

The measuring equipment, which was utilized in performing the tests documented herein, has been calibrated in accordance with the manufacturer's recommendations for utilizing calibration equipment, which is traceable to recognized national standards.

### 4.2 MEASUREMENT EQUIPMENT USED

#### Equipment Used for Emissions Measurement

*Remark: Each piece of equipment is scheduled for calibration once a year and Loop Antenna is scheduled for calibration once three years.*

| Conducted Emissions Test Site |              |         |               |                 |
|-------------------------------|--------------|---------|---------------|-----------------|
| Name of Equipment             | Manufacturer | Model   | Serial Number | Calibration Due |
| Spectrum Analyzer             | Agilent      | E4446A  | MY43360131    | 03/17/2012      |
| Power Meter                   | Anritsu      | ML2495A | 1012009       | 04/27/2012      |
| Power Sensor                  | Anritsu      | MA2411B | 0917072       | 04/27/2012      |

| Wugu 966 Chamber A |                    |                          |               |                 |
|--------------------|--------------------|--------------------------|---------------|-----------------|
| Name of Equipment  | Manufacturer       | Model                    | Serial Number | Calibration Due |
| Spectrum Analyzer  | Agilent            | E4446A                   | US42510252    | 11/02/2012      |
| EMI Test Receiver  | R&S                | ESCI                     | 100064        | 02/17/2012      |
| Pre-Amplifier      | Mini-Circuits      | ZFL-1000LN               | SF350700823   | 01/13/2012      |
| Pre-Amplifier      | MITEQ              | AFS44-00102650-42-10P-44 | 1415367       | 11/19/2012      |
| Bilog Antenna      | Sunol Sciences     | JB3                      | A030105       | 10/03/2012      |
| Horn Antenna       | EMCO               | 3117                     | 00055165      | 01/12/2012      |
| Horn Antenna       | EMCO               | 3116                     | 00026370      | 10/12/2012      |
| Loop Antenna       | EMCO               | 6502                     | 8905/2356     | 06/10/2013      |
| Turn Table         | CCS                | CC-T-1F                  | N/A           | N.C.R           |
| Antenna Tower      | CCS                | CC-A-1F                  | N/A           | N.C.R           |
| Controller         | CCS                | CC-C-1F                  | N/A           | N.C.R           |
| Site NSA           | CCS                | N/A                      | N/A           | 12/25/2012      |
| Test S/W           | EZ-EMC (CCS-3A1RE) |                          |               |                 |

| Conducted Emission room # A |              |           |               |                 |
|-----------------------------|--------------|-----------|---------------|-----------------|
| Name of Equipment           | Manufacturer | Model     | Serial Number | Calibration Due |
| EMI Test Receiver           | R&S          | ESHS10    | 843743/015    | 05/01/2012      |
| LISN                        | SCHWARZBECK  | NSLK 8127 | 8127-541      | 12/17/2012      |
| LISN                        | SCHAFFNER    | NNB 41    | 03/10013      | N.C.R.          |
| Test S/W                    | CCS-3A1-CE   |           |               |                 |



### 4.3 MEASUREMENT UNCERTAINTY

| PARAMETER                             | UNCERTAINTY |
|---------------------------------------|-------------|
| Powerline Conducted Emission          | +/- 1.2159  |
| 3M Semi Anechoic Chamber / 30M~200M   | +/- 14.0138 |
| 3M Semi Anechoic Chamber / 200M~1000M | +/- 13.9483 |
| 3M Semi Anechoic Chamber / 1G~8G      | +/- 12.5975 |
| 3M Semi Anechoic Chamber / 8G~18G     | +/- 12.6112 |
| 3M Semi Anechoic Chamber / 18G~26G    | +/- 12.7389 |
| 3M Semi Anechoic Chamber / 26G~40G    | +/- 12.9683 |

**Remark:** This uncertainty represents an expanded uncertainty expressed at approximately the 95% confidence level using a coverage factor of  $k=2$ .



## **5. FACILITIES AND ACCREDITATIONS**

### **5.1 FACILITIES**

All measurement facilities used to collect the measurement data are located at

No.199, Chunghsen Road, Hsintien City, Taipei Hsien, Taiwan, R.O.C.

Tel: 886-2-2217-0894 / Fax: 886-2-2217-1029

No.11, Wu-Gong 6th Rd., Wugu Industrial Park, New Taipei City 248, Taiwan (R.O.C.)

Tel: 886-2-2299-9720 / Fax: 886-2-2298-4045

No.81-1, Lane 210, Bade 2nd Rd., Lujhu Township, Taoyuan County 33841, TAIWAN, R.O.C.

Tel: 886-3-324-0332 / Fax: 886-3-324-5235

The sites are constructed in conformance with the requirements of ANSI C63.7, ANSI C63.4 and CISPR Publication 22.

### **5.2 EQUIPMENT**

Radiated emissions are measured with one or more of the following types of linearly polarized antennas: tuned dipole, biconical, log periodic, bi-log, and/or ridged waveguide, horn. Spectrum analyzers with pre-selectors and quasi-peak detectors are used to perform radiated measurements.



Conducted emissions are measured with Line Impedance Stabilization Networks and EMI Test Receivers.

Calibrated wideband preamplifiers, coaxial cables, and coaxial attenuators are also used for making measurements.

All receiving equipment conforms to CISPR Publication 16-1, "Radio Interference Measuring Apparatus and Measurement Methods."



### 5.3 TABLE OF ACCREDITATIONS AND LISTINGS

| Country | Agency          | Scope of Accreditation   | Logo  |
|---------|-----------------|--|---|
| USA     | FCC             | 3M Semi Anechoic Chamber (FCC MRA: TW1039) to perform FCC Part 15 measurements   | <br>FCC MRA: TW1039          |
| Taiwan  | TAF             | LP0002, RTTE01, FCC Method-47 CFR Part 15 Subpart C, D, E, RSS-210, RSS-310<br>IDA TS SRD, AS/NZS 4268, AS/NZS 4771, TS 12.1 & 12.2, ETSI EN 300 440-1, ETSI EN 300 440-2, ETSI EN 300 328, ETSI EN 300 220-1, ETSI EN 300 220-2, ETSI EN 301 893, ETSI EN 301 489-1/3/7/17<br>FCC OET Bulletin 65 + Supplement C,<br>EN 50360, EN 50361, EN 50371, RSS 102, EN 50383, EN 50385, EN 50392, IEC 62209, CNS 14958-1, CNS 14959<br>FCC Method -47 CFR Part 15 Subpart B<br>IEC / EN 61000-3-2, IEC / EN 61000-3-3,<br>IEC / EN 61000-4-2/3/4/5/6/8/11 |                              |
| Canada  | Industry Canada | 3M Semi Anechoic Chamber (IC 2324G-1 / IC 2324G-2) to perform  | <br>IC 2324G-1<br>IC 2324G-2 |

\* No part of this report may be used to claim or imply product endorsement by A2LA or any agency of the US Government.



## 6. SETUP OF EQUIPMENT UNDER TEST

### 6.1 SETUP CONFIGURATION OF EUT

See test photographs attached in Appendix II for the actual connections between EUT and support equipment.

### 6.2 SUPPORT EQUIPMENT

| No | Equipment                 | Brand   | Model         | Series No.                   | FCC ID  | Data Cable       | Power Cord  |
|----|---------------------------|---------|---------------|------------------------------|---------|------------------|---|
| 1. | Notebook PC               | IBM     | 1951-I3V(T60) | L3B2188                      | FCC DoC | N/A              | AC I/P:<br>Unshielded, 1.8m<br>DC O/P:<br>Unshielded, 1.8m<br>with a core |
| 2. | LCD Monitor               | DELL    | 3008WFP       | CN-0XK290-7161<br>8-846-169L | FCC DoC | Unshielded, 1.8m | Shielded, 1.8m  |
| 3. | GPS Antenna               | N/A     | N/A           | N/A                          | N/A     | N/A              | Unshielded, 3m  |
| 4. | USB Mouse                 | DELL    | M-UV69a       | 323617-001                   | FCC DoC | Shielded, 1.8m   | N/A   |
| 5. | SD Card                   | SANDISK | N/A           | N/A                          | N/A     | N/A              | N/A   |
| 6. | SIM Card                  | N/A     | N/A           | N/A                          | N/A     | N/A              | N/A   |
| 7. | Bluetooth Tester (Remote) | Anritsu | MT8852B       | 750013                       | N/A     | N/A              | Unshielded, 1.8m  |

**Remark:**

1. All the equipment/cables were placed in the worst-case configuration to maximize the emission during the test.
2. Grounding was established in accordance with the manufacturer's requirements and conditions for the intended use.



## 7. APPLICABLE RULES

### **RSS-210 §2 General Certification Requirements and Specifications**

#### **RSS-210 §2.1 RSS-Gen Compliance**

In addition to RSS-210, the requirements in RSS-Gen, *General Requirements and Information for the Certification of Radio Apparatus*, must be met.

#### **RSS-210 §2.2 Emissions Falling Within Restricted Frequency Bands**

Category I licence-exempt equipment is required to comply with the provisions in RSS-Gen with respect to emissions falling within restricted frequency bands. These restricted frequency bands are listed in RSS-Gen.

#### **RSS-210 §2.3 Receivers**

Category I equipment receivers for use with transmitters subject to RSS-210 must comply with the applicable requirements set out in RSS-Gen and be certified under RSS-210. Category II equipment receivers for use with transmitters subject to RSS-210 are exempt from certification, but are subject to compliance with RSS-Gen and RSS-310.

#### **RSS-210 §2.5 General Field Strength Limits**

RSS-Gen includes the general field strength limits of unwanted emissions, where applicable, for transmitters and receivers operating in accordance with the provisions specified in this standard. Unwanted emissions of transmitters and receivers are permitted to fall within the restricted bands listed in RSS-Gen, and including the TV bands, but fundamental emissions are prohibited in the restricted bands.

##### **RSS-210 §2.5.1 Transmitters with Wanted Emissions that are Within the General Field Strength Limits**

Whether or not their operation is addressed by published RSS standards, transmitters whose wanted and unwanted emissions are within the general field strength limits shown in RSS-Gen, they may operate in any of the frequency bands, other than the restricted bands listed in RSS-Gen and including the TV bands, and shall be certified under RSS-210. Under no conditions may the level of any unwanted emissions exceed the level of the fundamental emission.

**Note:** Devices operating below 490 kHz in which all emissions are at least 40 dB below the limit listed in RSS-Gen (*General Field Strength Limits for Transmitters at Frequencies below 30 MHz*) are Category II devices and are subject to RSS-310.



## **RSS-210 §2.7 Tables**

### **RSS-210 §Annex 8: Frequency Hopping and Digital Modulation Systems Operating in the 902-928 MHz, 2400-2483.5 MHz, and 5725-5850 MHz Bands**

This section applies to systems that employ frequency hopping (FH) and digital modulation technology in the 902-928 MHz, 2400-2483.5 MHz and 5725-5850 MHz bands. Systems in these bands may employ frequency hopping, digital modulation and or a combination (hybrid) of both techniques.

A frequency hopping system that synchronizes with another or several other systems (to avoid frequency collision among them) via off-air sensing or via connecting cables is not hopping randomly and therefore is not in compliance with RSS-210.

### **RSS-210 §A8.1 Frequency Hopping Systems**

Frequency hopping systems are spread spectrum systems in which the carrier is modulated with coded information in a conventional manner causing a conventional spreading of the RF energy about the carrier frequency. The frequency of the carrier is not fixed but changes at fixed intervals under the direction of a coded sequence.

Frequency hopping systems are not required to employ all available hopping frequencies during each transmission. However, the system, consisting of both the transmitter and the receiver, must be designed to comply with all of the regulations in this section should the transmitter be presented with a continuous data (or information) stream.

Incorporation of intelligence into a frequency hopping system that enables it to recognize other users of the band and to avoid occupied frequencies is permitted, provided that the frequency hopping system does it individually, and independently chooses or adapts its hopset. The coordination of frequency hopping systems in any other manner for the express purpose of avoiding the simultaneous occupancy of individual hopping frequencies by multiple transmitters is not permitted.

The following applies to frequency hopping systems in each of the three bands.

(a) The bandwidth of a frequency hopping channel is the 20 dB emission bandwidth, measured with the hopping stopped. The system RF bandwidth is equal to the channel bandwidth multiplied by the number of channels in the hopset. The hopset shall be such that the near term distribution of frequencies appears random, with sequential hops randomly distributed in both direction and magnitude of change in the hopset while the long term distribution appears evenly distributed.



(b) Frequency hopping systems shall have hopping channel carrier frequencies separated by a minimum of 25 kHz or the 20 dB bandwidth of the hopping channel, whichever is greater. Alternatively, frequency hopping systems operating in the 2400-2483.5 MHz band may have hopping channel carrier frequencies that are separated by 25 kHz or two-thirds of the 20 dB bandwidth of the hopping channel, whichever is greater, provided the systems operate with an output power no greater than 0.125 W. The system receivers shall have input bandwidths that match the hopping channel bandwidths of their corresponding transmitters and shall shift frequencies in synchronization with the transmitted signals.

(d) Frequency hopping systems operating in the 2400-2483.5 MHz band shall use at least 15 hopping channels. The average time of occupancy on any channel shall not be greater than 0.4 seconds within a period of 0.4 seconds multiplied by the number of hopping channels employed. Transmissions on particular hopping frequencies may be avoided or suppressed provided that a minimum of 15 hopping channels are used.

### **RSS-210 §A8.2 Digital Modulation Systems**

These include systems employing digital modulation techniques resulting in spectral characteristics similar to direct sequence systems. The following applies to all three bands.

### **RSS-210 §A8.4 Transmitter Output Power and e.i.r.p. Requirements**

(4) For systems employing digital modulation techniques operating in the 902-928 MHz, 2400-2483.5 MHz and 5725-5850 MHz bands, the maximum peak conducted power shall not exceed 1 W. Except as provided in Section A8.4(5), the e.i.r.p. shall not exceed 4 W.

As an alternative to a peak power measurement, compliance can be based on a measurement of the maximum conducted output power (see RSS-Gen)

(5) Point-to-point systems in the bands 2400-2483.5 MHz and 5725-5850 MHz are permitted to have an e.i.r.p. higher than 4 W, provided that the higher e.i.r.p. is achieved by employing higher gain directional antennas and not higher transmitter output powers. Point-to-multipoint systems, omni-directional applications and multiple co-located transmitters transmitting the same information are prohibited from exceeding 4 W e.i.r.p. However, remote stations of point-to-multipoint systems shall be allowed to operate at greater than 4 W e.i.r.p. under the same conditions as for point-to-point systems.

**Note:** "Fixed, point-to-point operation", excludes point-to-multipoint systems, omnidirectional applications and multiple co-located transmitters transmitting the same information.





### **RSS-210 §A8.5 Out-of-band Emissions**

In any 100 kHz bandwidth outside the frequency band in which the spread spectrum or digitally modulated device is operating, the radio frequency power that is produced shall be at least 20 dB below that in the 100 kHz bandwidth within the band that contains the highest level of the desired power, based on either an RF conducted or a radiated measurement, provided the transmitter demonstrates compliance with the peak conducted power limits. If the transmitter complies with the conducted power limits based on the use of RMS averaging over a time interval, as permitted under section A8.4(4), the attenuation required shall be 30 dB instead of 20 dB. Attenuation below the general limits specified in Tables 2 and 3 is not required.

### **RSS-Gen §2 General Information**

#### **RSS-Gen §2.1.2 Category II Equipment**

Category II equipment comprises radio devices where a standard has been prescribed but for which a TAC is not required, that is, equipment certification by Industry Canada or a Certification Body (CB) is not required (certification exempt), pursuant to subsection 4(3) of the Radiocommunication Act. The manufacturer or importer shall nevertheless ensure that the standards are complied with. A test report shall be available on request and the device shall be properly labelled.

#### **RSS-Gen §2.2 Receivers**

Receivers that are used for radiocommunication other than broadcasting are defined as Category I equipment or Category II equipment, subject to compliance with applicable Industry Canada standards.

Receivers shall be capable of operation only with transmitters for which RSSs are published. Receivers are classified as described in sections 2.2.1 and 2.2.2.

#### **RSS-Gen §2.2.1 Category I Equipment Receivers**

A receiver is classified as Category I equipment if it meets one of the following conditions:

- (a) a stand-alone receiver (see Note 1, below), which operates on any frequency in the band 30-960 MHz, and is used for the reception of signals in that frequency band from a transmitter classified as Category I equipment;
- (b) a Citizen's Band (CB) receiver (26.96-27.410 MHz);
- (c) a scanner receiver.

**Note 1:** A *stand-alone receiver* is defined as any receiver that is not permanently combined together with a transmitter in a single case (transceiver), in which it functions as the receiver component of the transceiver.

Receivers classified as Category I equipment shall comply with the limits for receiver spurious emissions set out in RSS-Gen; however, equipment certification is granted under the applicable RSS standard along with the associated transmitter classified as Category I equipment. Scanner receivers are covered under their own specific RSS.

#### **RSS-Gen §2.2.2 Category II Equipment Receivers**

A receiver is classified as Category II equipment if it does not meet any of the conditions of Section 2.2.1.

Category II receivers shall comply with the applicable testing, labelling and user manual requirements in RSS-310.



**RSS-Gen §5.6 Exposure of Humans to RF Fields**

Category I and Category II equipment shall comply with the applicable requirements of RSS-102.

**RSS-Gen §6 Receiver Spurious Emission Standard**

Receivers shall comply with the limits of spurious emissions set out in this section, measured over the frequency range determined in accordance with Section 4.10.

**RSS-Gen §6.1 Radiated Limits**

Radiated spurious emission measurements shall be performed with the receiver antenna connected to the receiver antenna terminals.

Spurious emissions from receivers shall not exceed the radiated limits shown in the table below:

**RSS-Gen Table 2 - Spurious Emission Limits for Receivers**

| Frequency (MHz) | Field Strength microvolts/m at 3 metres |
|-----------------|---|
| 30-88           | 100                                     |
| 88-216          | 150                                     |
| 216-960         | 200                                     |
| Above 960       | 500                                     |

\*Measurements for compliance with limits in the above table may be performed at distances other than 3 metres, in accordance with Section 7.2.7.

**RSS- Gen Table 3: Restricted Frequency Bands** <sup>(Note)</sup>

| MHz             | MHz                | MHz                 | MHz           | GHz         |
|-----------------|--------------------|---------------------|---------------|-------------|
| 0.090-0.110     | 8.37625-8.38675    | --                  | 1718.8-1722.2 | 9.0-9.2     |
| --              | 8.41425-8.41475    | 156.52475-156.52525 | 2200-2300     | 9.3-9.5     |
| 2.1735-2.1905   | 12.29-12.293       | 156.7-156.9         | 2310-2390     | 10.6-12.7   |
| 3.020-3.026     | 12.51975-12.52025  | --                  | --            | 13.25-13.4  |
| 4.125-4.128     | 12.57675-12.57725  | --                  | 2655-2900     | 14.47-14.5  |
| 4.17725-4.17775 | 13.36-13.41        | 240-285             | 3260-3267     | 15.35-16.2  |
| 4.20725-4.20775 | 16.42-16.423       | 322-335.4           | 3332-3339     | 17.7-21.4   |
| 5.677-5.683     | 16.69475-16.69525  | 399.9-410           | 3345.8-3358   | 22.01-23.12 |
| 6.215-6.218     | 16.80425-16.80475  | 608-614             | 3500-4400     | 23.6-24.0   |
| 6.26775-6.26825 | 25.5-25.67         | 960-1427            | 4500-5150     | 31.2-31.8   |
| 6.31175-6.31225 | 37.5-38.25         | 1435-1626.5         | 5350-5460     | 36.43-36.5  |
| 8.291-8.294     | 73-74.6; 74.8-75.2 | 1645.5-1646.5       | 7250-7750     | Above 38.6  |
| 8.362-8.366     | 108-138            | 1660-1710           | 8025-8500     |             |

**Note:** Certain frequency bands listed in Table 2 and above 38.6 GHz are designated for low-power licence-exempt applications. These frequency bands and the requirements that apply to the devices are set out in this Standard as well as RSS-310.

**RSS- Gen Table 5: General Field Strength Limits for Transmitters at Frequencies Above 30 MHz**

| Frequency (MHz) | Field Strength (microvolt/m at 3 metres) |
|-----------------|--|
| 30-88           | 100                                      |
| 88-216          | 150                                      |
| 216-960         | 200                                      |
| Above 960       | 500                                      |

**Note:** Transmitting devices are not permitted in Table 1 bands or, unless stated otherwise, in TV bands (54-72 MHz, 76-88 MHz, 174-216 MHz, 470-608 MHz and 614-806 MHz).



**RSS- Gen Table 6: General Field Strength Limits for Transmitters at Frequencies Below 30 MHz (Transmit)**

| Frequency<br>(fundamental<br>or spurious) | Field Strength<br>(microvolts/m) | Magnetic<br>H-Field<br>(microamperes/m) | Measurement<br>Distance<br>(metres) |
|---|----------------------------------|---|-------------------------------------|
| 9-490 kHz                                 | 2,400/F<br>(F in kHz)            | 2,400/377F<br>(F in Hz)                 | 300                                 |
| 490-1.705 kHz                             | 24,000/F<br>(F in kHz)           | 24,000/377F<br>(F in kHz)               | 30                                  |
| 1.705-30 MHz                              | 30                               | N/A                                     | 30                                  |

*Note: The emission limits for the bands 9-90 kHz and 110-490 kHz are based on measurements employing an average detector.*



### **RSS-Gen §7.1.2 Transmitter Antenna**

A transmitter can only be sold or operated with antennas with which it was approved. Transmitter may be approved with multiple antenna types. An antenna type comprises antennas having similar in-band and out-of-band radiation patterns. Testing shall be performed using the highest gain antenna of each combination of transmitter and antenna type for which approval is being sought, with the transmitter output power set at the maximum level. Any antenna of the same type having equal or lesser gain as an antenna that had been successfully tested with the transmitter, will also be considered approved with the transmitter, and may be used and marketed with the transmitter. For Category I transmitters, the manufacturer shall include with the application for certification a list of acceptable antenna types to be used with the transmitter.

When a measurement at the antenna connector is used to determine RF output power, the effective gain of the device's antenna shall be stated, based on measurement or on data from the antenna manufacturer.

For transmitters of RF output power of 10 milliwatts or less, only the portion of the antenna gain that is in excess of 6 dBi (6 dB above isotropic gain) shall be added to the measured RF output power to demonstrate compliance with the radiated power limits specified in the applicable standard. For transmitters of output power greater than 10 milliwatts, the total antenna gain shall be added to the measured RF output power to demonstrate compliance to the specified radiated power limits. User manuals for transmitters shall display the following notice in a conspicuous location:

*Under Industry Canada regulations, this radio transmitter may only operate using an antenna of a type and maximum (or lesser) gain approved for the transmitter by Industry Canada. To reduce potential radio interference to other users, the antenna type and its gain should be so chosen that the equivalent isotropically radiated power (e.i.r.p.) is not more than that necessary for successful communication.*

The above notice may be affixed to the device instead of displayed in the user manual.

User manuals for transmitters equipped with detachable antennas shall also contain the following notice in a conspicuous location:

*This radio transmitter (identify the device by certification number, or model number if Category II) has been approved by Industry Canada to operate with the antenna types listed below with the maximum permissible gain and required antenna impedance for each antenna type indicated. Antenna types not included in this list, having a gain greater than the maximum gain indicated for that type, are strictly prohibited for use with this device.*

Immediately following the above notice, the manufacturer shall provide a list of all antenna types approved for use with the transmitter, indicating the maximum permissible antenna gain (in dBi) and required impedance for each.



**RSS-Gen §7.2.4 Transmitter and Receiver AC Power Lines Conducted Emission Limits**

Except when the requirements applicable to a given device state otherwise, for any radio apparatus equipped to operate from the public utility AC power supply, either directly or indirectly (such as with a battery charger), the radio frequency voltage of emissions conducted back onto the AC power lines in the frequency range of 0.15 MHz to 30 MHz shall not exceed the limits shown in the table below. The more stringent limit applies at the frequency range boundaries.

The conducted emissions shall be measured with a 50 ohm/50 microhenry line impedance stabilization network (LISN).

**RSS-Gen Table 4 – AC Power Line Conducted Emission Limits**

| Frequency Range (MHz) | Conducted limit (dBμV) |           |
|-----------------------|------------------------|-----------|
|                       | Quasi-peak             | Average   |
| 0.15 to 0.5           | 66 to 56*              | 56 to 46* |
| 0.5 to 5              | 56                     | 46        |
| 5 to 30               | 60                     | 50        |

*\*Decreases with the logarithm of the frequency.*



## 8. FCC PART 15.247 REQUIREMENTS & RSS 210 REQUIREMENTS

### 8.1 99% BANDWIDTH

#### Test Configuration

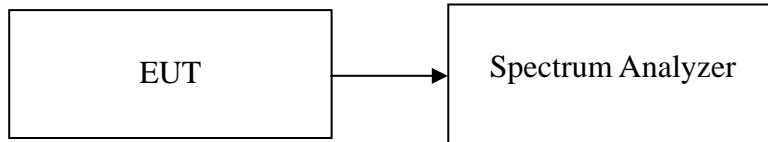

#### TEST PROCEDURE

The resolution bandwidth shall be set to as close to 1% of the selected span as is possible without being below 1%. The video bandwidth shall be set to 3 times the resolution bandwidth. Video averaging is not permitted. Where practical, a sampling detector shall be used since a peak or peak hold.

#### TEST RESULTS

*No non-compliance noted.*

#### Test Data

##### For GFSK

| Channel | Frequency (MHz) | 99% Bandwidth (MHz) |
|---------|-----------------|---------------------|
| Low     | 2402            | 0.8704522           |
| Mid     | 2441            | 0.8698414           |
| High    | 2480            | 0.8674311           |

##### For 8DPSK

| Channel | Frequency (MHz) | 99% Bandwidth (MHz) |
|---------|-----------------|---------------------|
| Low     | 2402            | 1.1476              |
| Mid     | 2441            | 1.1493              |
| High    | 2480            | 1.1572              |



**Test Plot**

**For GFSK / DH5**

**99% Bandwidth (CH Low)**

Agilent 10:45:20 Dec 16, 2011

R T

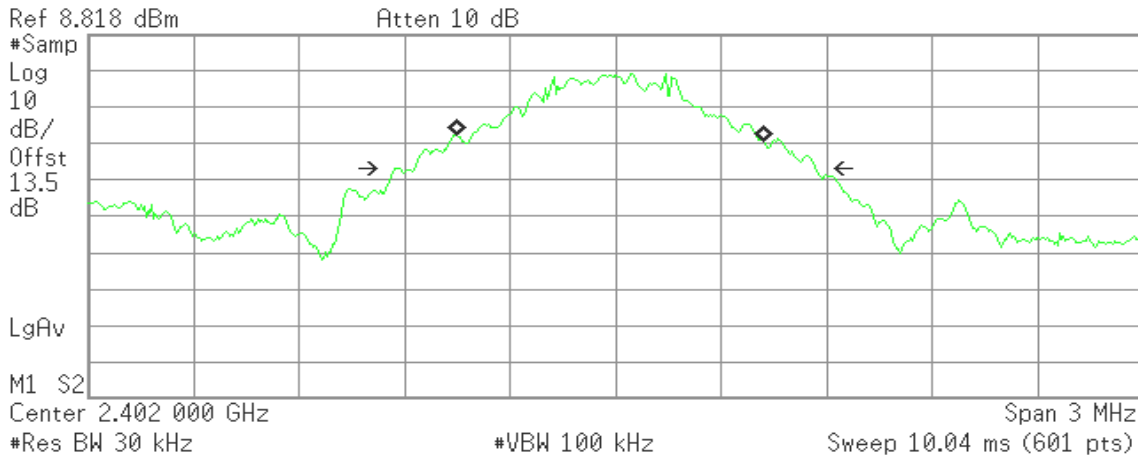

**Occupied Bandwidth**  
870.4522 kHz

**Occ BW % Pwr** 99.00 %  
**x dB** -26.00 dB

**Transmit Freq Error** -15.918 kHz  
**x dB Bandwidth** 1.196 MHz\*

**99% Bandwidth (CH Mid)**

Agilent 10:51:52 Dec 16, 2011

R T

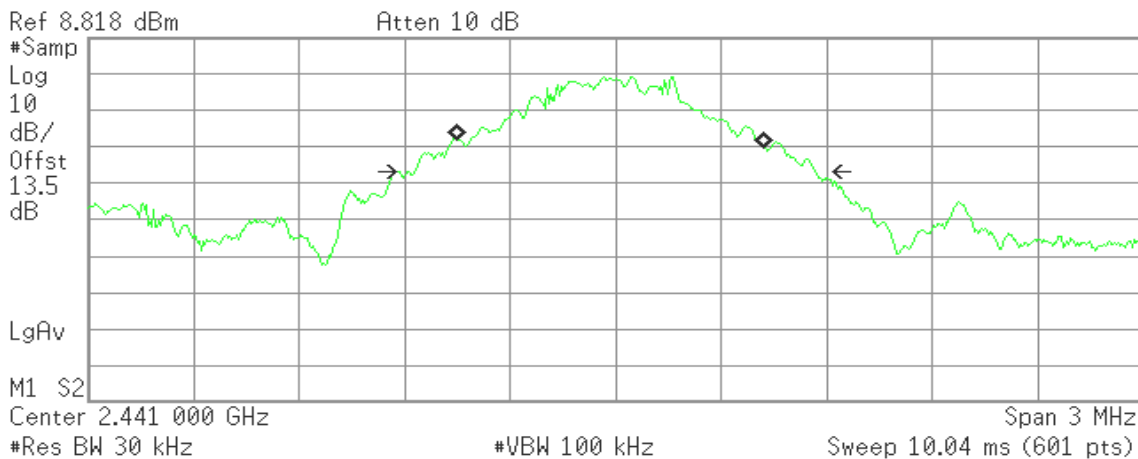

**Occupied Bandwidth**  
869.8414 kHz

**Occ BW % Pwr** 99.00 %  
**x dB** -26.00 dB

**Transmit Freq Error** -15.383 kHz  
**x dB Bandwidth** 1.133 MHz\*





### 99% Bandwidth (CH High)

Agilent 10:52:11 Dec 16, 2011

R T

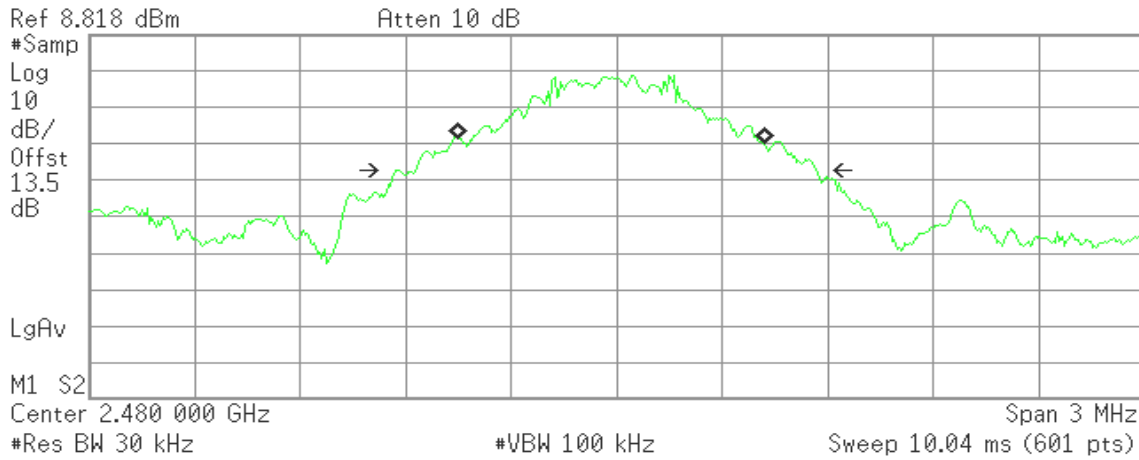

Occupied Bandwidth  
867.4311 kHz

Occ BW % Pwr 99.00 %  
x dB -26.00 dB

Transmit Freq Error -15.948 kHz  
x dB Bandwidth 1.195 MHz\*

### For GFSK / DH5

### 99% Bandwidth (CH Low)

Agilent 10:44:24 Dec 16, 2011

R T

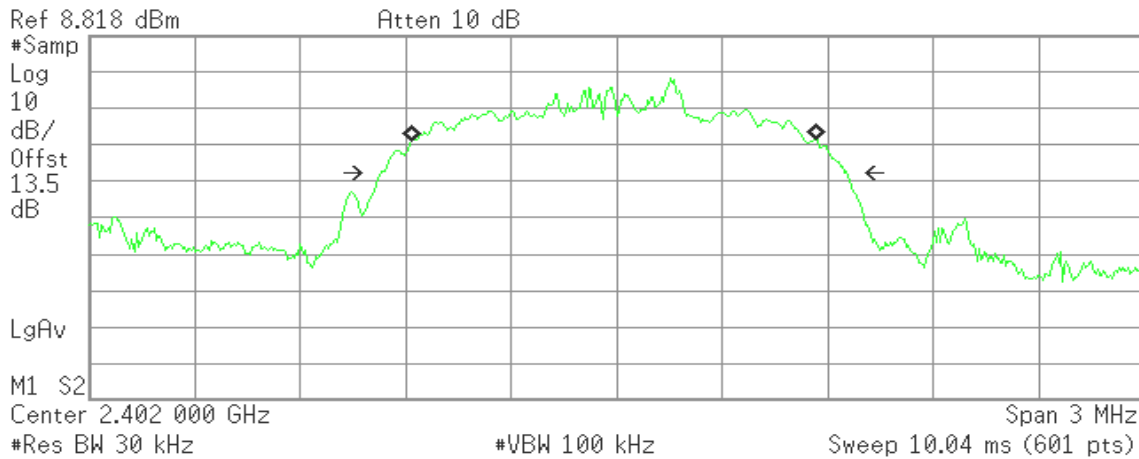

Occupied Bandwidth  
1.1476 MHz

Occ BW % Pwr 99.00 %  
x dB -26.00 dB

Transmit Freq Error -6.545 kHz  
x dB Bandwidth 1.331 MHz\*



### 99% Bandwidth (CH Mid)

Agilent 10:43:54 Dec 16, 2011

R T

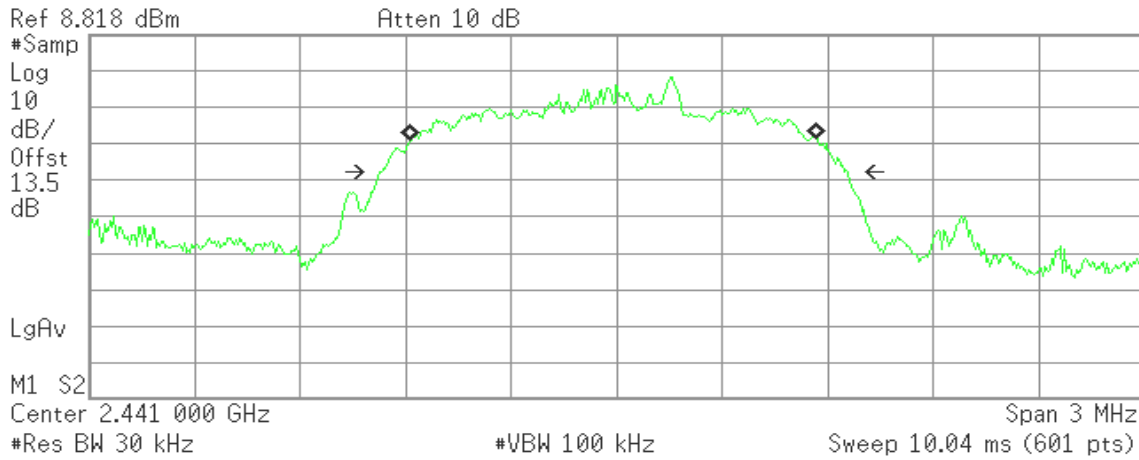

Occupied Bandwidth  
1.1493 MHz

Occ BW % Pwr 99.00 %  
x dB -26.00 dB

Transmit Freq Error -8.284 kHz  
x dB Bandwidth 1.328 MHz\*

### 99% Bandwidth (CH High)

Agilent 10:44:48 Dec 16, 2011

R T

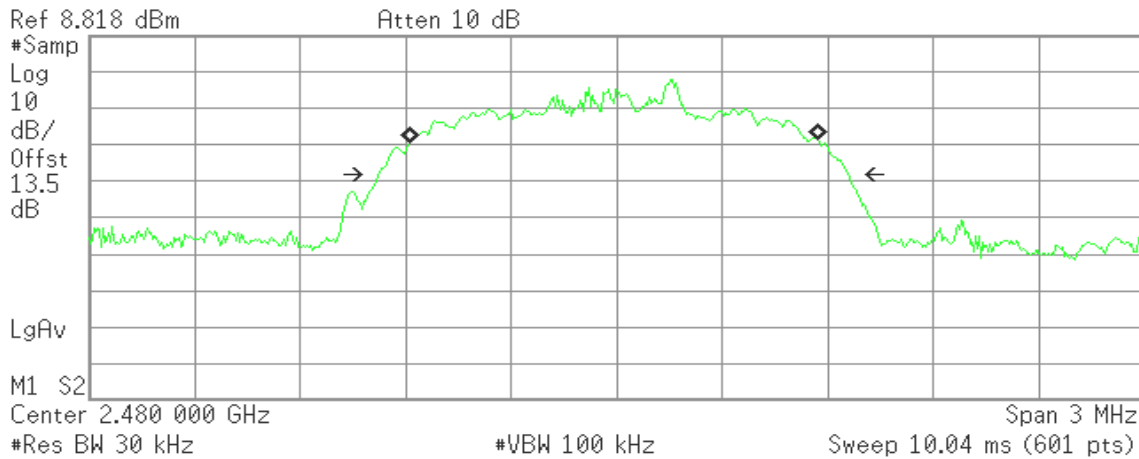

Occupied Bandwidth  
1.1572 MHz

Occ BW % Pwr 99.00 %  
x dB -26.00 dB

Transmit Freq Error -7.281 kHz  
x dB Bandwidth 1.337 MHz\*



## 8.2 20 DB BANDWIDTH

### LIMIT

None; for reporting purposes only.

### Test Configuration

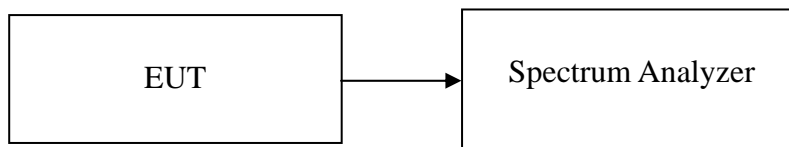

### TEST PROCEDURE

1. Place the EUT on the table and set it in the transmitting mode.
2. Remove the antenna from the EUT and then connect a low loss RF cable from the antenna port to the spectrum analyzer.
3. Set the spectrum analyzer as RBW = 30kHz, VBW = 10030kHz, Span = 200kHz, Sweep Time = 3.2ms.
4. Mark the peak frequency and 20dB (upper and lower) frequency.
5. Repeat until all the rest channels are investigated.

### TEST RESULTS

*No non-compliance noted.*

#### Test Data

##### **For GFSK / DH5**

| Channel | Frequency (MHz) | 20dB Bandwidth (MHz) |
|---------|-----------------|----------------------|
| Low     | 2402            | 0.965                |
| Mid     | 2441            | 0.97                 |
| High    | 2480            | 0.965                |

##### **For 8DPSK / DH5**

| Channel | Frequency (MHz) | 20dB Bandwidth (MHz) |
|---------|-----------------|----------------------|
| Low     | 2402            | 1.25                 |
| Mid     | 2441            | 1.305                |
| High    | 2480            | 1.27                 |



**Test Plot**

For GFSK / DH5

20dB Bandwidth (CH Low)

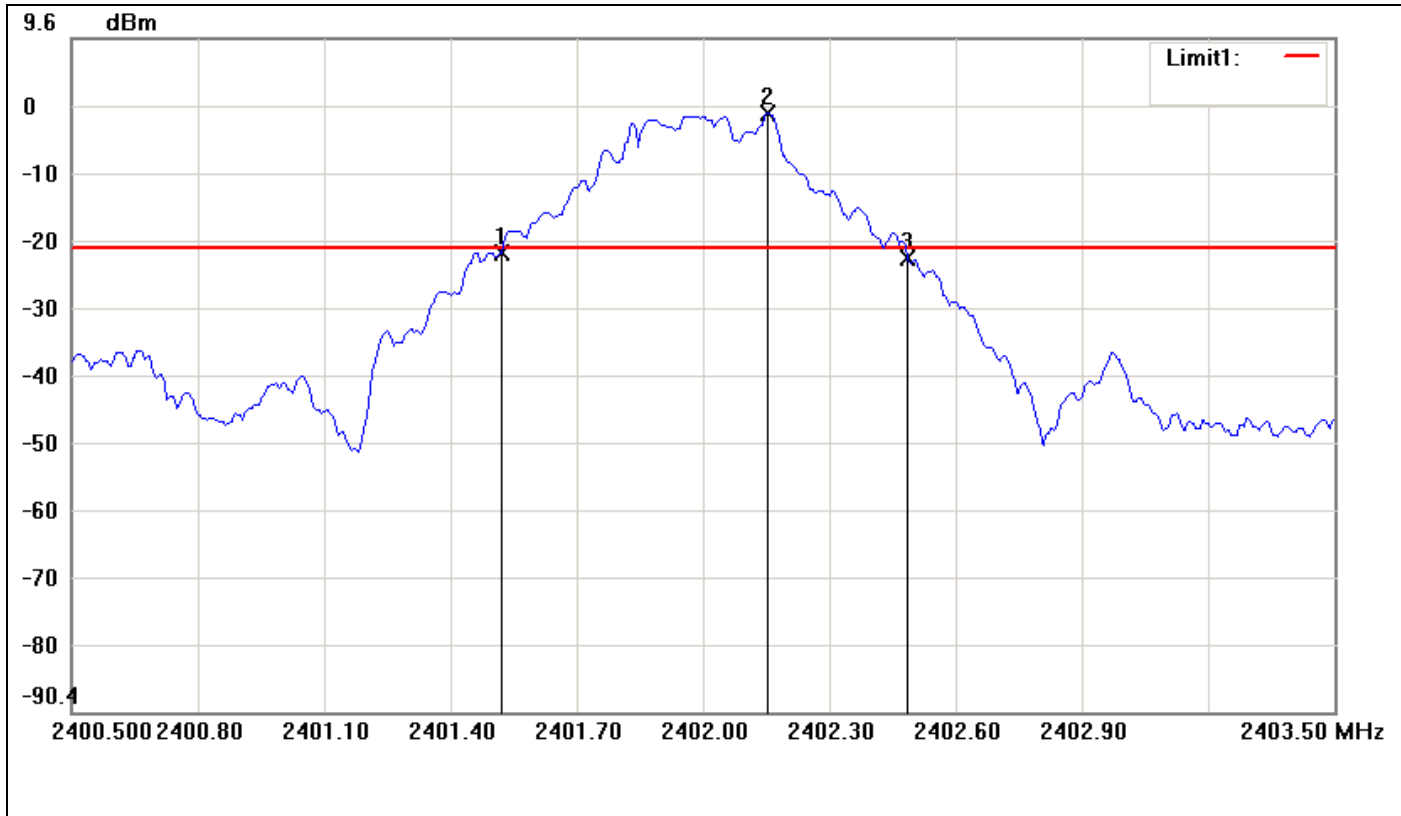

| No. | Frequency(MHz) | Level(dBm) | Limit(dBm) | Margin(dBm) |
|-----|----------------|------------|------------|-------------|
| 1   | 2401.5200      | -22.31     | -21.63     | -0.68       |
| 2   | 2402.1550      | -1.63      | -21.63     | 20.00       |
| 3   | 2402.4850      | -22.97     | -21.63     | -1.34       |

| No. |         | $\Delta$ Frequency(MHz) | $\Delta$ Level(dB) |
|-----|---------|-------------------------|--------------------|
| 1   | mk3-mk1 | 0.965                   | -0.66              |



20dB Bandwidth (CH Mid)

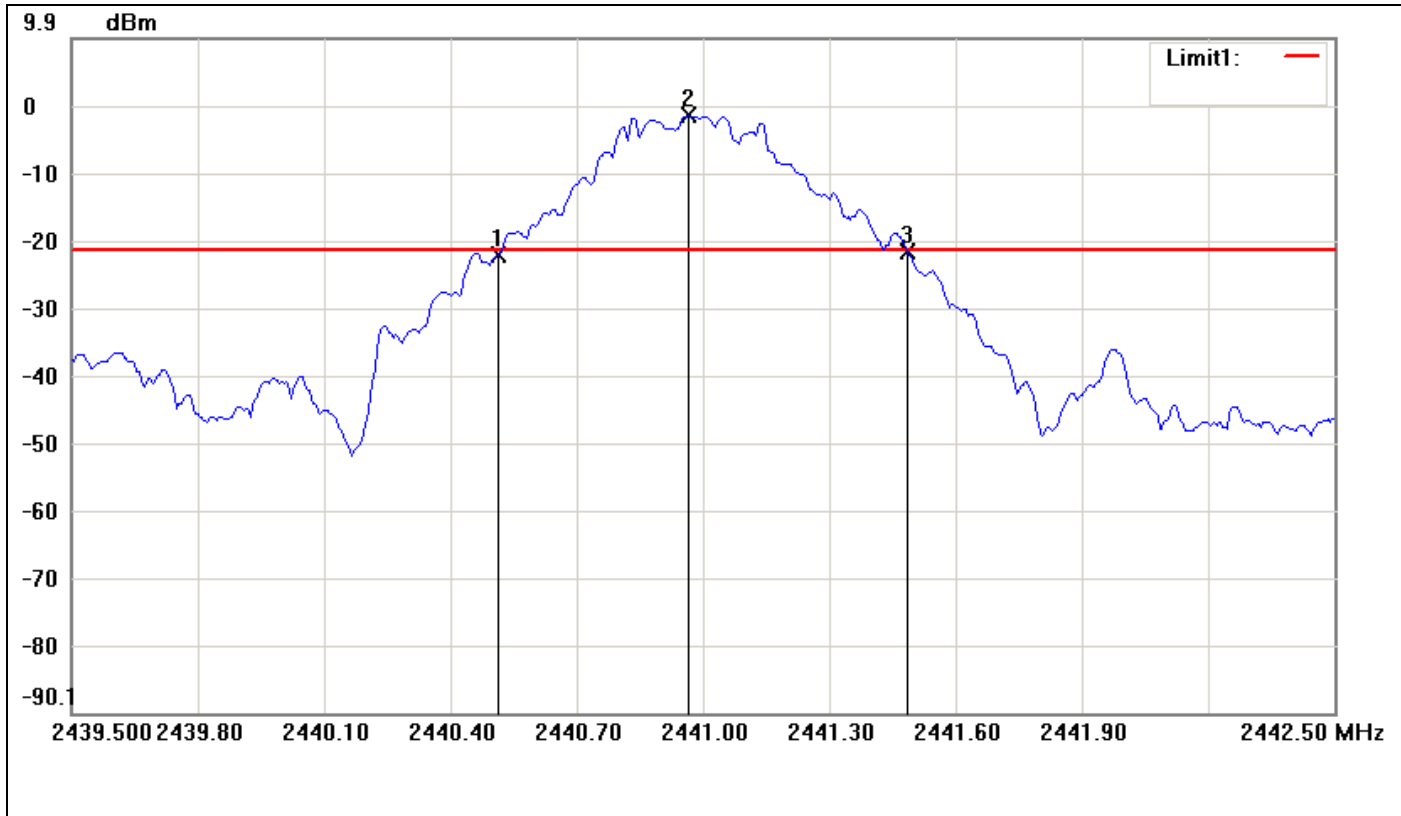

| No. | Frequency(MHz) | Level(dBm) | Limit(dBm) | Margin(dBm) |
|-----|----------------|------------|------------|-------------|
| 1   | 2440.5150      | -22.18     | -21.59     | -0.59       |
| 2   | 2440.9650      | -1.59      | -21.59     | 20.00       |
| 3   | 2441.4850      | -21.83     | -21.59     | -0.24       |

| No. |         | $\Delta$ Frequency(MHz) | $\Delta$ Level(dB) |
|-----|---------|-------------------------|--------------------|
| 1   | mk3-mk1 | 0.97                    | 0.35               |



20dB Bandwidth (CH High)

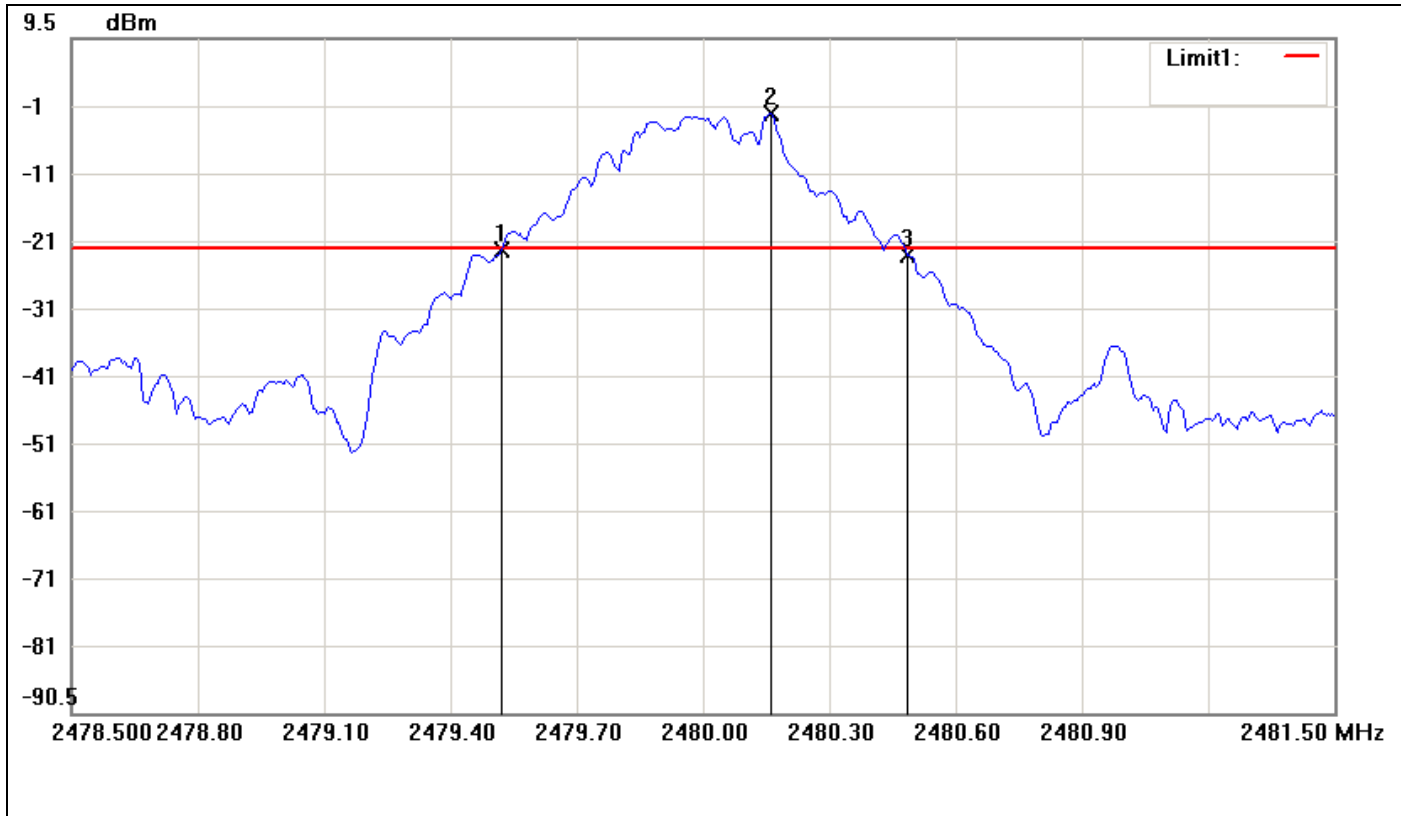

| No. | Frequency(MHz) | Level(dBm) | Limit(dBm) | Margin(dBm) |
|-----|----------------|------------|------------|-------------|
| 1   | 2479.5200      | -22.00     | -21.73     | -0.27       |
| 2   | 2480.1600      | -1.73      | -21.73     | 20.00       |
| 3   | 2480.4850      | -22.62     | -21.73     | -0.89       |

| No. |         | $\Delta$ Frequency(MHz) | $\Delta$ Level(dB) |
|-----|---------|-------------------------|--------------------|
| 1   | mk3-mk1 | 0.965                   | -0.62              |



For 8DPSK / DH5

20dB Bandwidth (CH Low)

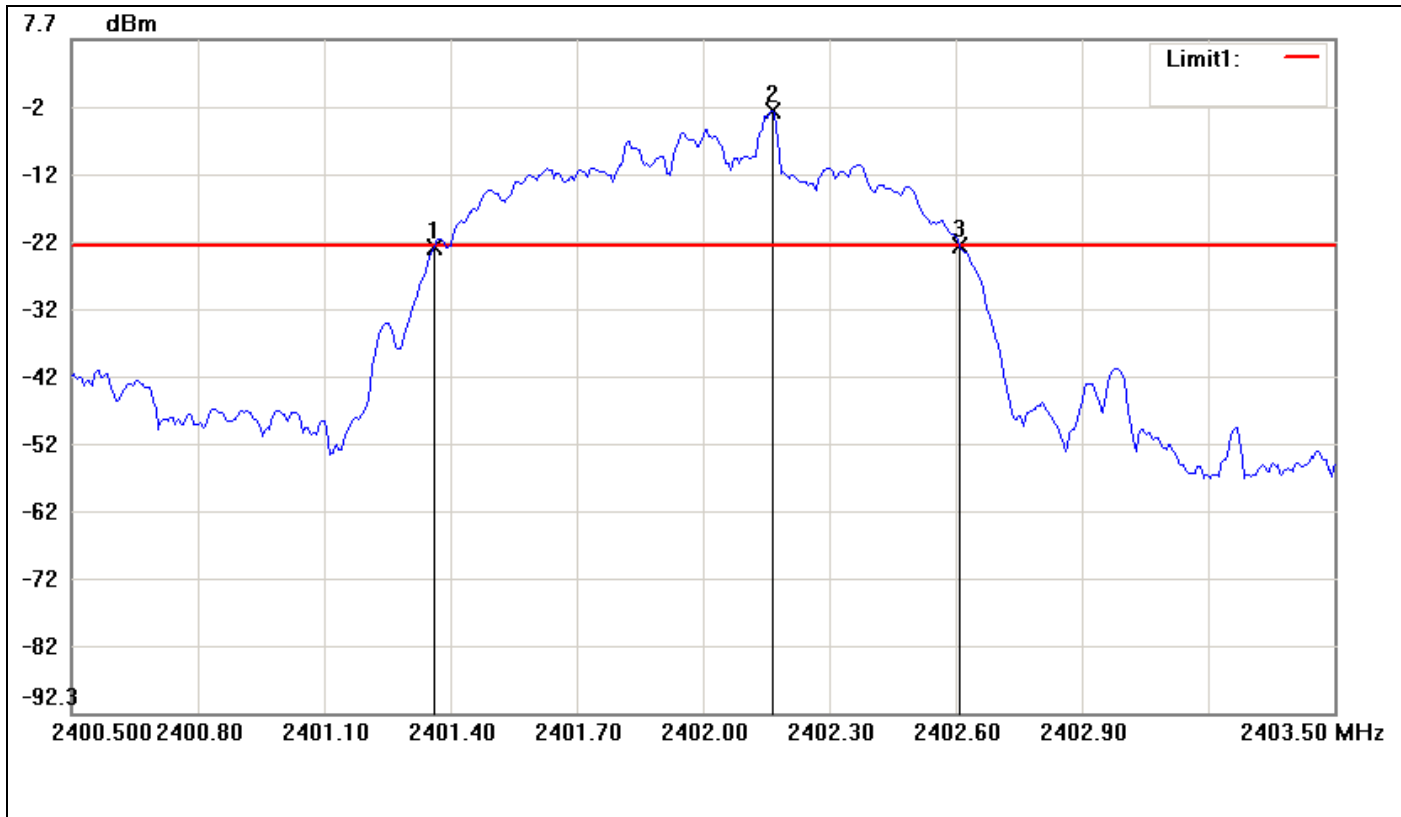

| No. | Frequency(MHz) | Level(dBm) | Limit(dBm) | Margin(dBm) |
|-----|----------------|------------|------------|-------------|
| 1   | 2401.3600      | -23.19     | -22.85     | -0.34       |
| 2   | 2402.1650      | -2.85      | -22.85     | 20.00       |
| 3   | 2402.6100      | -22.93     | -22.85     | -0.08       |

| No. |         | $\Delta$ Frequency(MHz) | $\Delta$ Level(dB) |
|-----|---------|-------------------------|--------------------|
| 1   | mk3-mk1 | 1.25                    | 0.26               |



20dB Bandwidth (CH Mid)

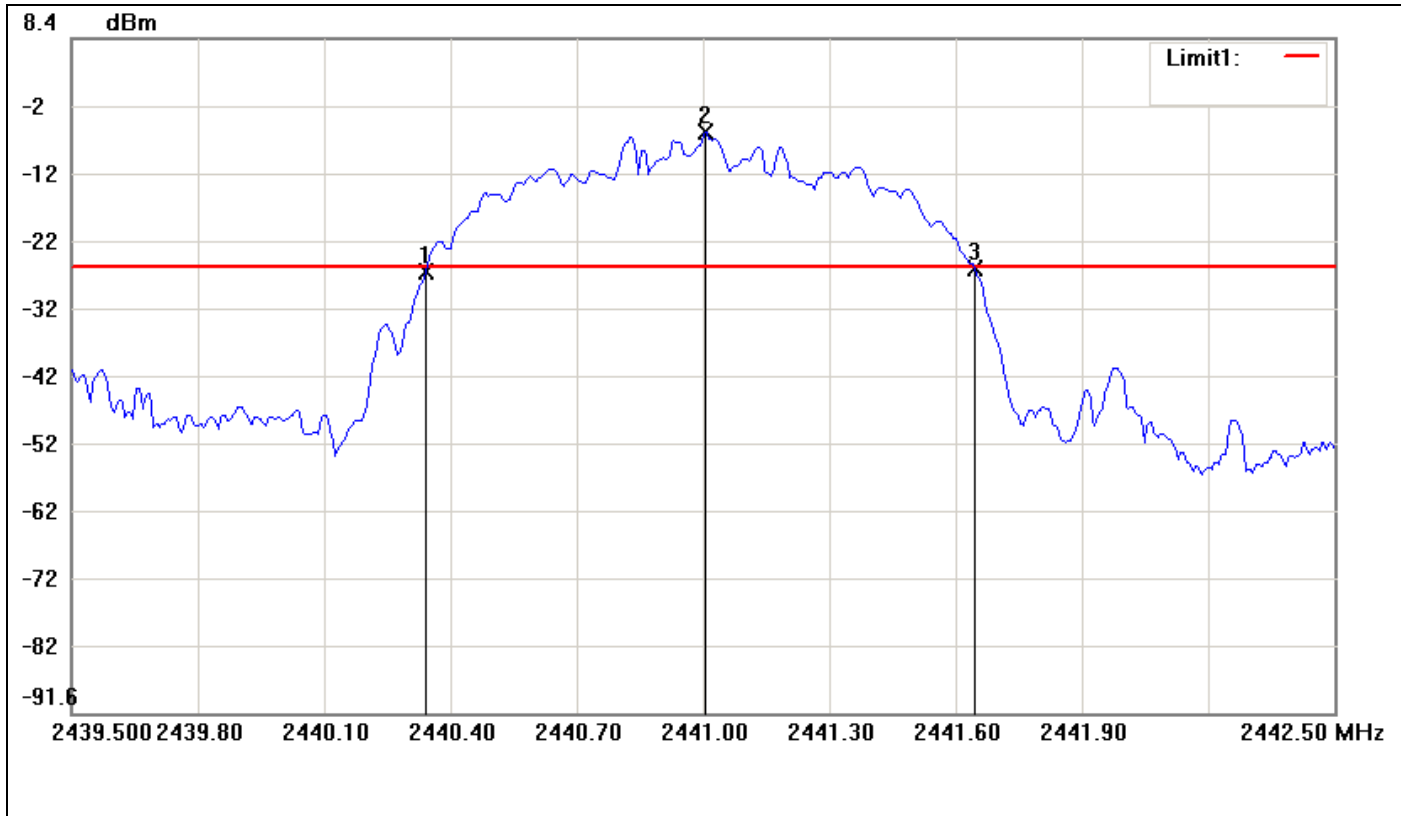

| No. | Frequency(MHz) | Level(dBm) | Limit(dBm) | Margin(dBm) |
|-----|----------------|------------|------------|-------------|
| 1   | 2440.3400      | -26.34     | -25.44     | -0.90       |
| 2   | 2441.0050      | -5.44      | -25.44     | 20.00       |
| 3   | 2441.6450      | -25.79     | -25.44     | -0.35       |

| No. |         | $\Delta$ Frequency(MHz) | $\Delta$ Level(dB) |
|-----|---------|-------------------------|--------------------|
| 1   | mk3-mk1 | 1.305                   | 0.55               |





20dB Bandwidth (CH High)

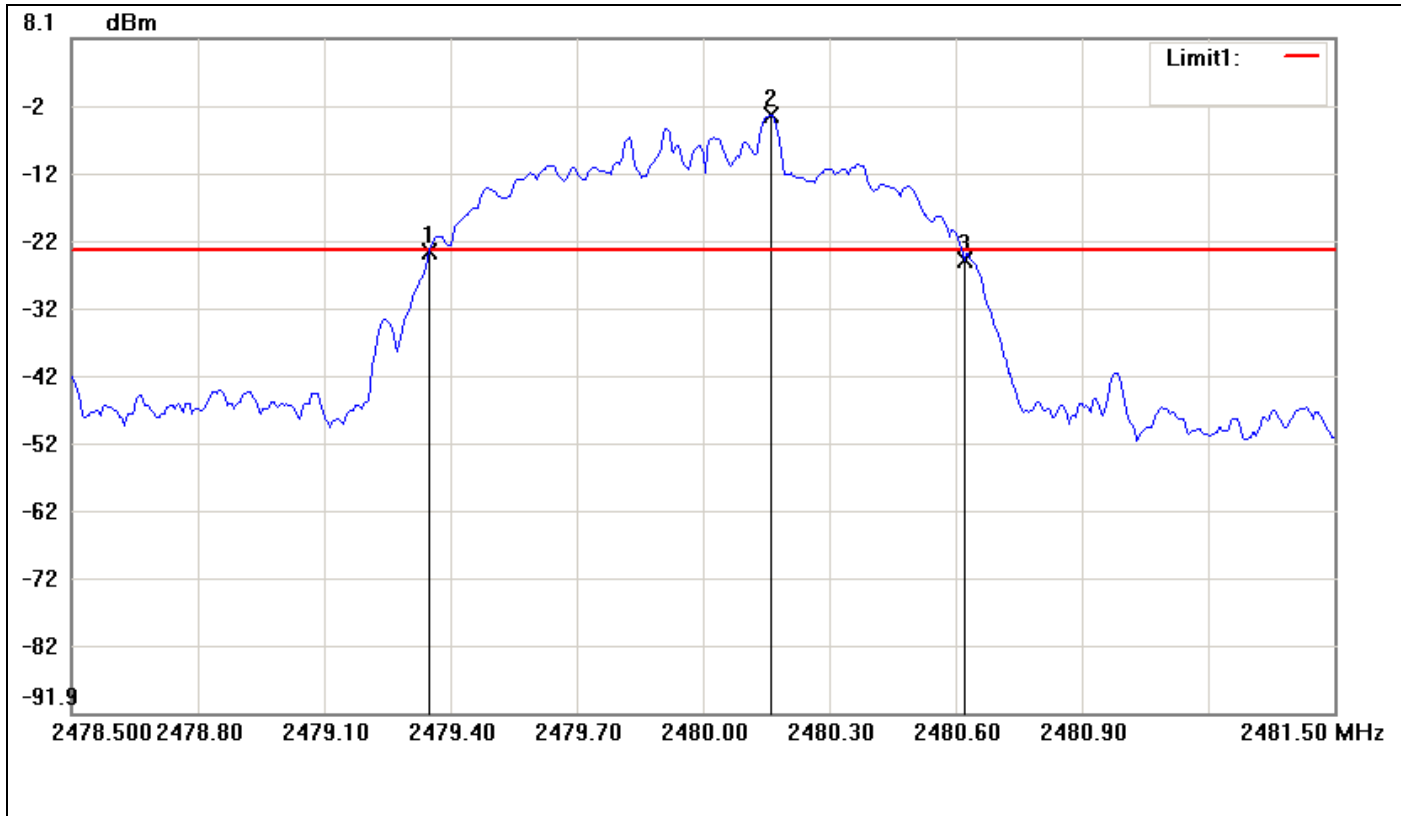

| No. | Frequency(MHz) | Level(dBm) | Limit(dBm) | Margin(dBm) |
|-----|----------------|------------|------------|-------------|
| 1   | 2479.3500      | -23.44     | -23.25     | -0.19       |
| 2   | 2480.1600      | -3.25      | -23.25     | 20.00       |
| 3   | 2480.6200      | -24.82     | -23.25     | -1.57       |

| No. |         | $\Delta$ Frequency(MHz) | $\Delta$ Level(dB) |
|-----|---------|-------------------------|--------------------|
| 1   | mk3-mk1 | 1.27                    | -1.38              |



### 8.3 PEAK POWER

#### LIMIT

The maximum peak output power of the intentional radiator shall not exceed the following:

1. According to §15.247(a)(1) & RSS-210 §A8.4(2) , Frequency hopping systems shall have hopping channel carrier frequencies separated by a minimum of 25 kHz or the 20 dB bandwidth of the hopping channel, whichever is greater. Alternatively, frequency hopping systems operating in the 2400-2483.5 MHz band may have hopping channel carrier frequencies that are separated by 25 kHz or two-thirds of the 20 dB bandwidth of the hopping channel, whichever is greater, provided the systems operate with an output power no greater than 125 mW.
2. According to §15.247(b)(3) & RSS 210 §A8.4(4),, for systems using digital modulation in the bands of 902-928 MHz, 2400-2483.5 MHz, and 5725-5850 MHz: 1 Watt.

#### Test Configuration

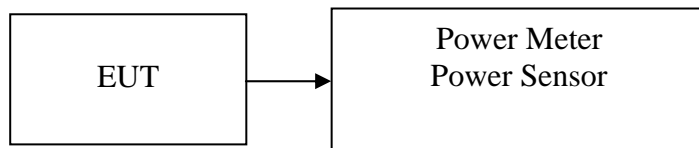

#### TEST PROCEDURE

The transmitter output is connected to the Power Meter. The Power Meter is set to the peak power detection.

#### TEST RESULTS

*No non-compliance noted.*

#### Test Data

##### **For GFSK / DH5**

| Channel | Frequency (MHz) | Output Power (dBm) | Output Power (W) | Limit (W) | Result |
|---------|-----------------|--------------------|------------------|-----------|--------|
| Low     | 2402            | 0.97               | 0.00125          | 0.125     | PASS   |
| Mid     | 2441            | 1.20               | 0.00132          |           | PASS   |
| High    | 2480            | 0.63               | 0.00116          |           | PASS   |

##### **For 8DPSK / DH5**

| Channel | Frequency (MHz) | Output Power (dBm) | Output Power (W) | Limit (W) | Result |
|---------|-----------------|--------------------|------------------|-----------|--------|
| Low     | 2402            | -0.97              | 0.00080          | 0.125     | PASS   |
| Mid     | 2441            | -0.30              | 0.00093          |           | PASS   |
| High    | 2480            | -1.31              | 0.00074          |           | PASS   |



## 8.4 AVERAGE POWER

### LIMIT

None; for reporting purposes only.

### Test Configuration

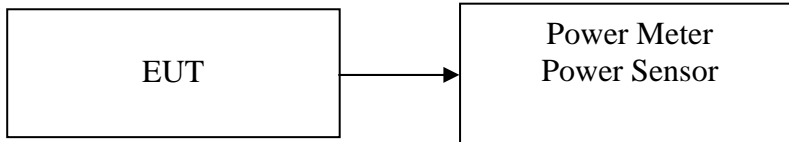

### TEST PROCEDURE

The transmitter output is connected to the Power Meter The Power Meter is set to the average power detection.

### TEST RESULTS

*No non-compliance noted.*

#### Test Data

##### For GFSK / DH5

| Channel | Frequency (MHz) | Output Power (dBm) | Output Power (W) |
|---------|-----------------|--------------------|------------------|
| Low     | 2402            | -3.85              | 0.0004           |
| Mid     | 2441            | -4.12              | 0.0004           |
| High    | 2480            | -4.93              | 0.0003           |

##### For 8DPSK / DH5

| Channel | Frequency (MHz) | Output Power (dBm) | Output Power (W) |
|---------|-----------------|--------------------|------------------|
| Low     | 2402            | -9.28              | 0.0001           |
| Mid     | 2441            | -8.93              | 0.0001           |
| High    | 2480            | -9.30              | 0.0001           |



## 8.5 BAND EDGES MEASUREMENT

### LIMIT

According to §15.247(d), in any 100 kHz bandwidth outside the frequency band in which the spread spectrum or digitally modulated intentional radiator is operating, the radio frequency power that is produced by the intentional radiator shall be at least 20 dB below that in the 100 kHz bandwidth within the band that contains the highest level of the desired power, based on either an RF conducted or a radiated measurement, provided the transmitter demonstrates compliance with the peak conducted power limits. If the transmitter complies with the conducted power limits based on the use of RMS averaging over a time interval, as permitted under paragraph (b)(3) of this section, the attenuation required under this paragraph shall be 30 dB instead of 20 dB. Attenuation below the general limits specified in §15.209(a) is not required. In addition, radiated emissions which fall in the restricted bands, as defined in §15.205(a), must also comply with the radiated emission limits specified in §15.209(a) (see §15.205(c)).

According to RSS-210 §A8.5, in any 100 kHz bandwidth outside the frequency band in which the spread spectrum or digitally modulated device is operating, the radio frequency power that is produced shall be at least 20 dB below that in the 100 kHz bandwidth within the band that contains the highest level of the desired power, based on either an RF conducted or a radiated measurement, provided the transmitter demonstrates compliance with the peak conducted power limits. If the transmitter complies with the conducted power limits based on the use of RMS averaging over a time interval, as permitted under section A8.4(4), the attenuation required shall be 30 dB instead of 20 dB. Attenuation below the general limits specified in Tables 2 and 3 is not required. In addition, radiated emissions which fall in the restricted bands of Table 1 must also comply with the radiated emission limits specified in Tables 2 and 3.



**Test Configuration**

**For Radiated**

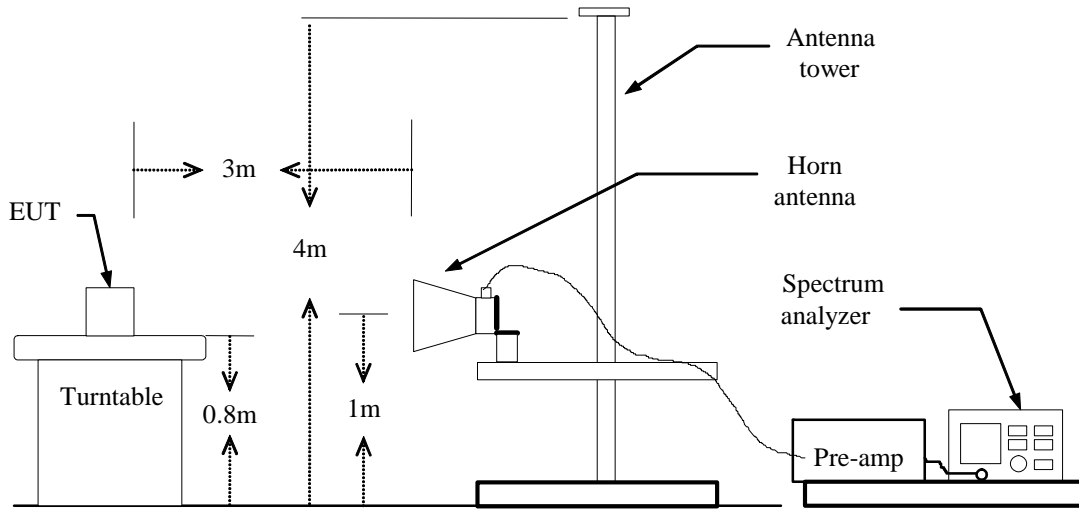

**For Conducted**

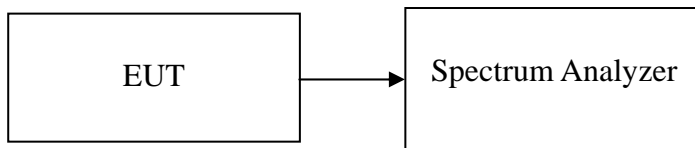



## **TEST PROCEDURE**

### **For Radiated**

1. The EUT is placed on a turntable, which is 0.8m above the ground plane.
2. The turntable shall be rotated for 360 degrees to determine the position of maximum emission level.
3. EUT is set 3m away from the receiving antenna, which is varied from 1m to 4m to find out the highest emission.
4. Set the spectrum analyzer in the following setting in order to capture the lower and upper band-edges of the emission:
  - (a) PEAK: RBW=VBW=1MHz / Sweep=AUTO
  - (b) AVERAGE: RBW=1MHz / VBW=10Hz / Sweep=AUTO
5. Repeat the procedures until all the PEAK and AVERAGE versus POLARIZATION are measured.

### **For Conducted**

Conducted RF measurements of the transmitter output were made to confirm that the EUT antenna port conducted emissions meet the specified limit and to identify any spurious signals that require further investigation or measurements on the radiated emissions site.

The transmitter output is connected to the spectrum analyzer. The resolution bandwidth is set to 300 kHz. The video bandwidth is set to 300 kHz.

## **TEST RESULTS**

Refer to attach spectrum analyzer data chart.



For GFSK / DH5

Band Edges (CH Low)

Detector mode: Peak

Polarity: Vertical

Agilent 11:33:31 17 Dec 2011

R T

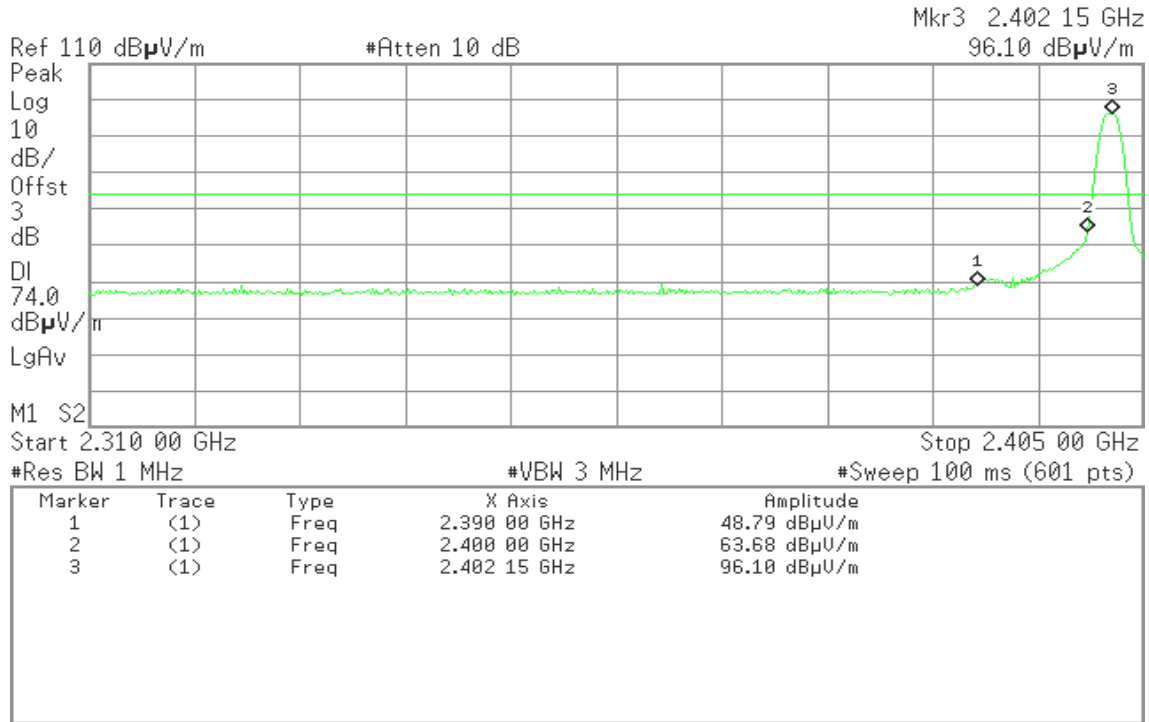

Detector mode: Average

Polarity: Vertical

Agilent 11:34:24 17 Dec 2011

R T

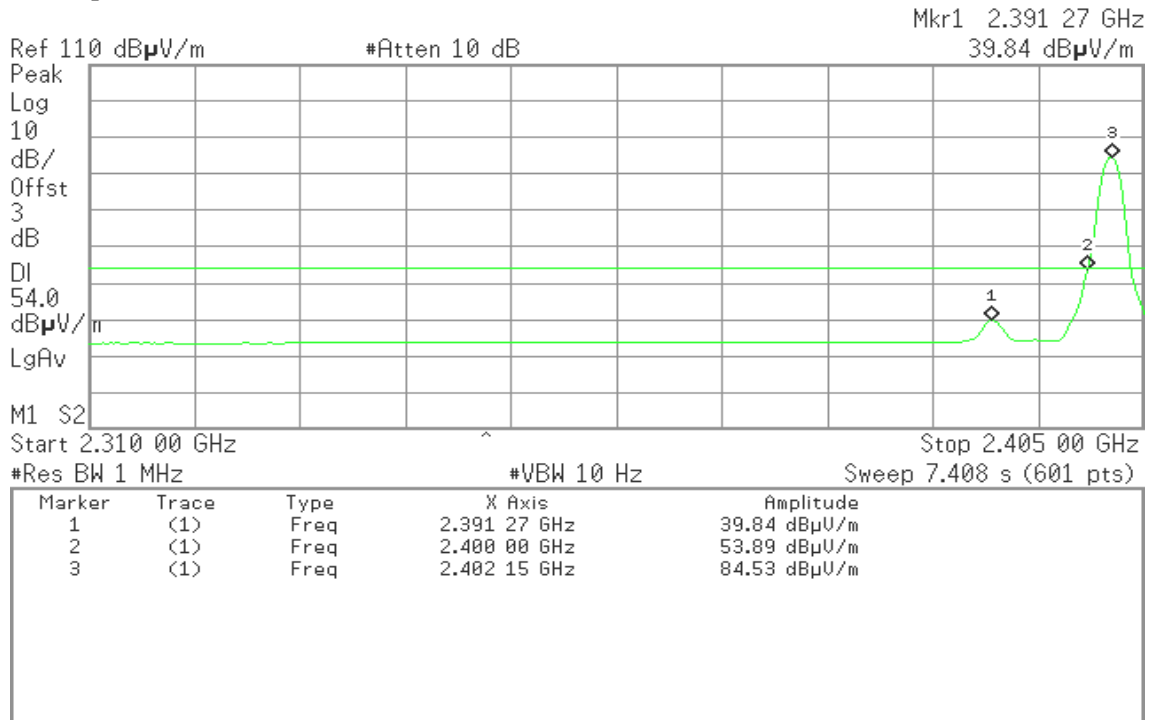



Detector mode: Peak

Polarity: Horizontal

Agilent 11:23:05 17 Dec 2011

R T

Mkr3 2.401 99 GHz  
94.97 dBµV/m

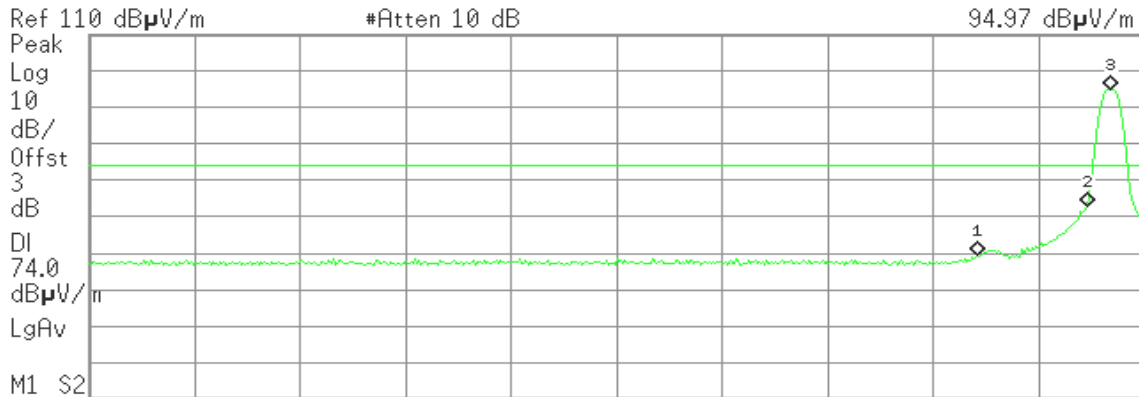

Start 2.310 00 GHz Stop 2.405 00 GHz  
#Res BW 1 MHz #VBW 3 MHz #Sweep 100 ms (601 pts)

| Marker | Trace | Type | X Axis       | Amplitude    |
|--------|-------|------|--------------|--------------|
| 1      | (1)   | Freq | 2.390 00 GHz | 49.23 dBµV/m |
| 2      | (1)   | Freq | 2.400 00 GHz | 62.95 dBµV/m |
| 3      | (1)   | Freq | 2.401 99 GHz | 94.97 dBµV/m |

Detector mode: Average

Polarity: Horizontal

Agilent 11:23:37 17 Dec 2011

R T

Mkr3 2.401 99 GHz  
83.62 dBµV/m



Start 2.310 00 GHz Stop 2.405 00 GHz  
#Res BW 1 MHz #VBW 10 Hz Sweep 7.408 s (601 pts)

| Marker | Trace | Type | X Axis       | Amplitude    |
|--------|-------|------|--------------|--------------|
| 1      | (1)   | Freq | 2.390 00 GHz | 35.20 dBµV/m |
| 2      | (1)   | Freq | 2.400 00 GHz | 52.97 dBµV/m |
| 3      | (1)   | Freq | 2.401 99 GHz | 83.62 dBµV/m |





### Band Edges (CH High)

Detector mode: Peak

Polarity: Vertical

Agilent 11:57:38 17 Dec 2011

R T

Mkr1 2.483 50 GHz

54.71 dB $\mu$ V/m

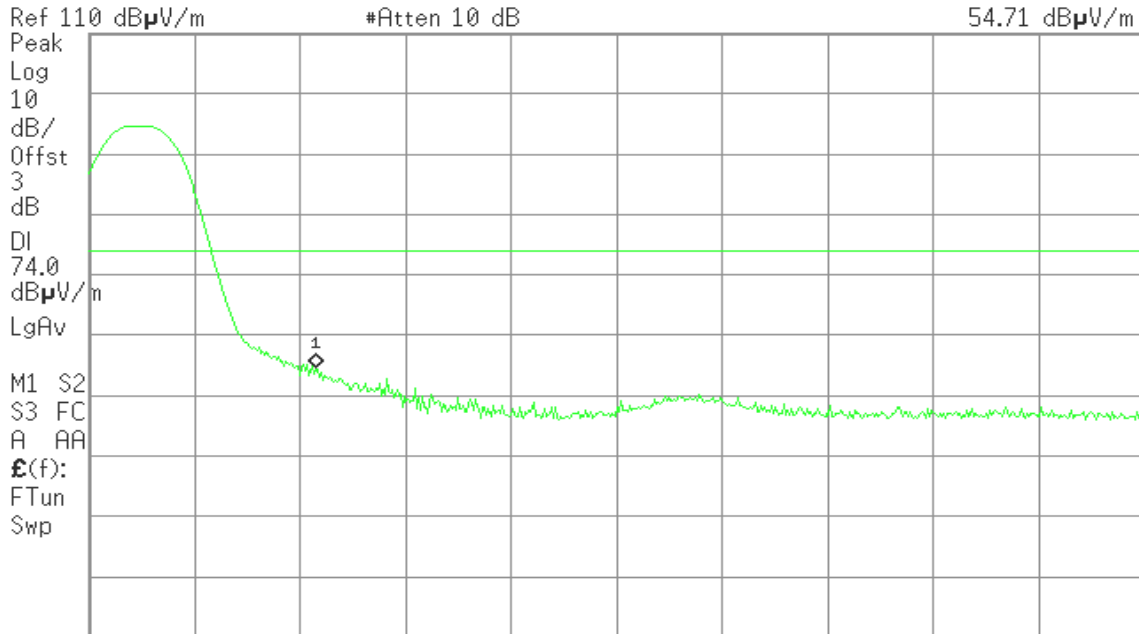

Start 2.479 00 GHz #Res BW 1 MHz #VBW 3 MHz Stop 2.500 00 GHz #Sweep 100 ms (601 pts)\_

Detector mode: Average

Polarity: Vertical

Agilent 11:58:17 17 Dec 2011

R T

Mkr1 2.483 50 GHz

36.79 dB $\mu$ V/m

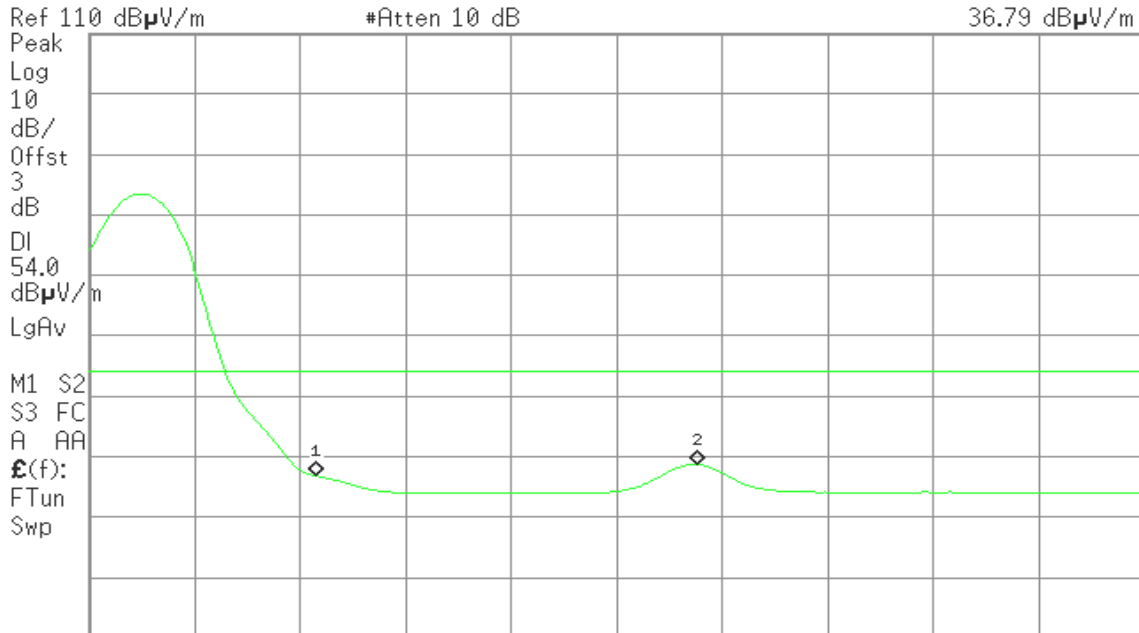

Start 2.479 00 GHz #Res BW 1 MHz #VBW 10 Hz Stop 2.500 00 GHz Sweep 1.637 s (601 pts)\_



**Detector mode: Peak**

**Polarity: Horizontal**

Agilent 11:52:48 17 Dec 2011

R T

Mkr1 2.483 50 GHz  
55.90 dB $\mu$ V/m

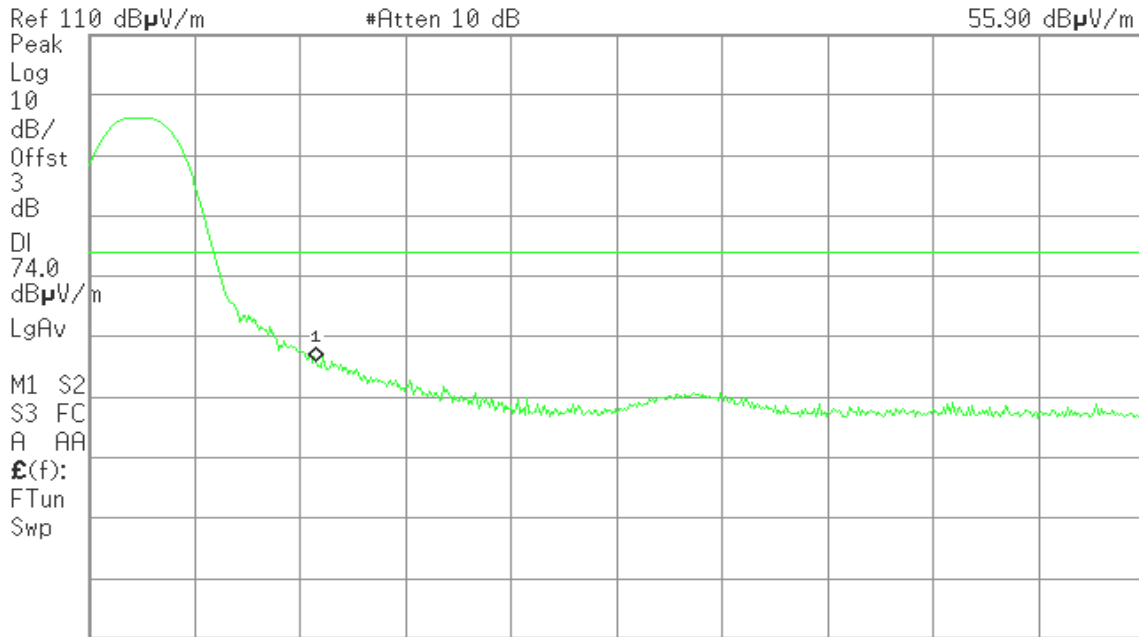

Start 2.479 00 GHz Stop 2.500 00 GHz  
#Res BW 1 MHz #VBW 3 MHz #Sweep 100 ms (601 pts)

**Detector mode: Average**

**Polarity: Horizontal**

Agilent 11:53:50 17 Dec 2011

R T

Mkr1 2.483 50 GHz  
37.61 dB $\mu$ V/m

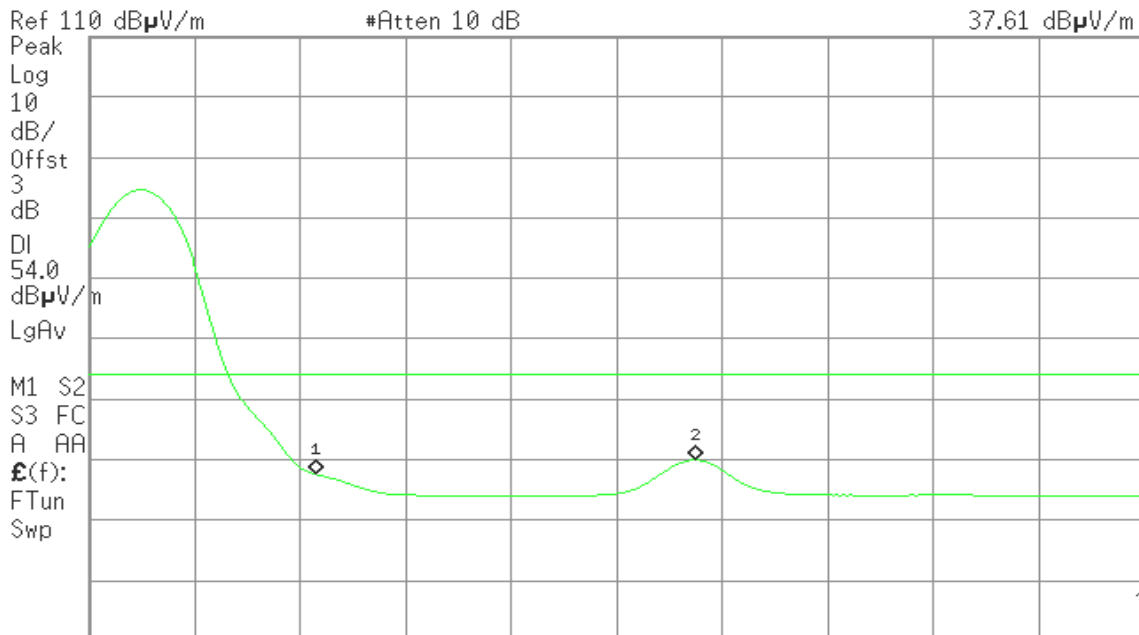

Start 2.479 00 GHz Stop 2.500 00 GHz  
#Res BW 1 MHz #VBW 10 Hz Sweep 1.637 s (601 pts)



For 8DPSK / DH5

Band Edges (CH Low)

Detector mode: Peak

Polarity: Vertical

Agilent 12:45:07 17 Dec 2011

R T

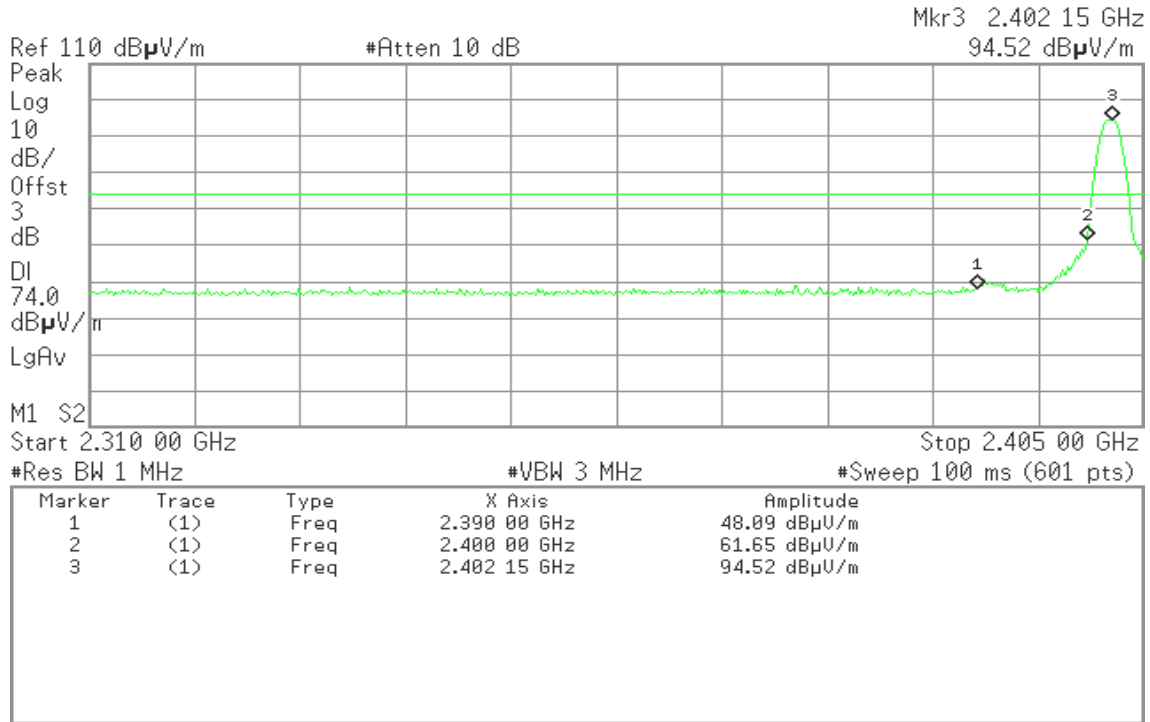

Detector mode: Average

Polarity: Vertical

Agilent 12:45:54 17 Dec 2011

R T

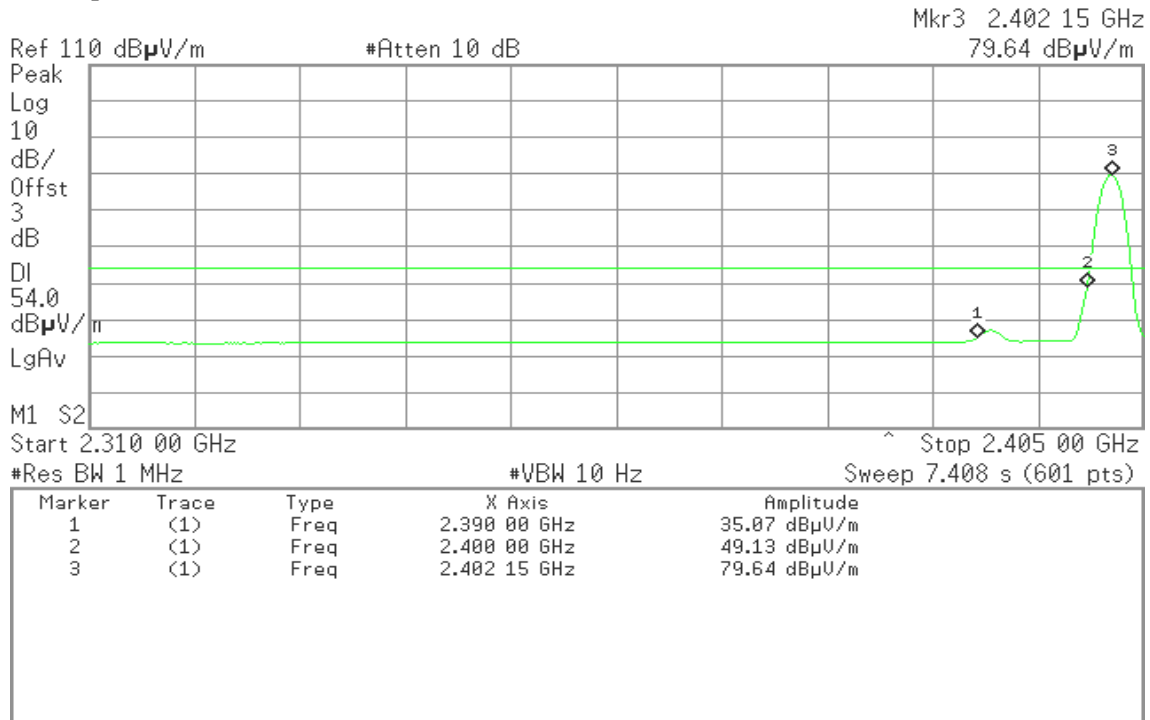



Detector mode: Peak

Polarity: Horizontal

Agilent 12:50:40 17 Dec 2011

R T

Mkr3 2.402 15 GHz  
93.21 dBµV/m

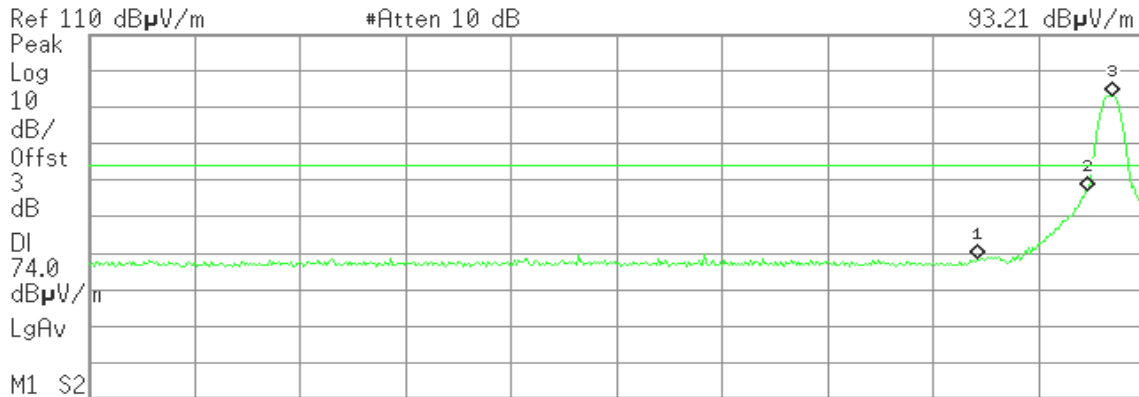

| Marker | Trace | Type | X Axis       | Amplitude    |
|--------|-------|------|--------------|--------------|
| 1      | (1)   | Freq | 2.390 00 GHz | 48.62 dBµV/m |
| 2      | (1)   | Freq | 2.400 00 GHz | 67.14 dBµV/m |
| 3      | (1)   | Freq | 2.402 15 GHz | 93.21 dBµV/m |

#Res BW 1 MHz #VBW 3 MHz #Sweep 100 ms (601 pts)

Detector mode: Average

Polarity: Horizontal

Agilent 12:51:19 17 Dec 2011

R T

Mkr3 2.402 15 GHz  
79.06 dBµV/m

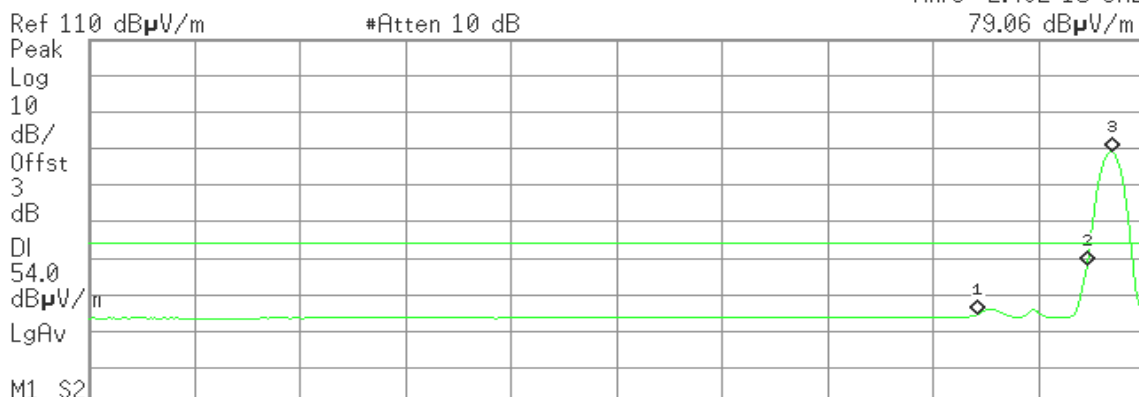

| Marker | Trace | Type | X Axis       | Amplitude    |
|--------|-------|------|--------------|--------------|
| 1      | (1)   | Freq | 2.390 00 GHz | 34.58 dBµV/m |
| 2      | (1)   | Freq | 2.400 00 GHz | 48.16 dBµV/m |
| 3      | (1)   | Freq | 2.402 15 GHz | 79.06 dBµV/m |

#Res BW 1 MHz #VBW 10 Hz Sweep 7.408 s (601 pts)



### Band Edges (CH High)

Detector mode: Peak

Polarity: Vertical

Agilent 13:06:51 17 Dec 2011

R T

Mkr1 2.483 50 GHz

53.10 dB $\mu$ V/m

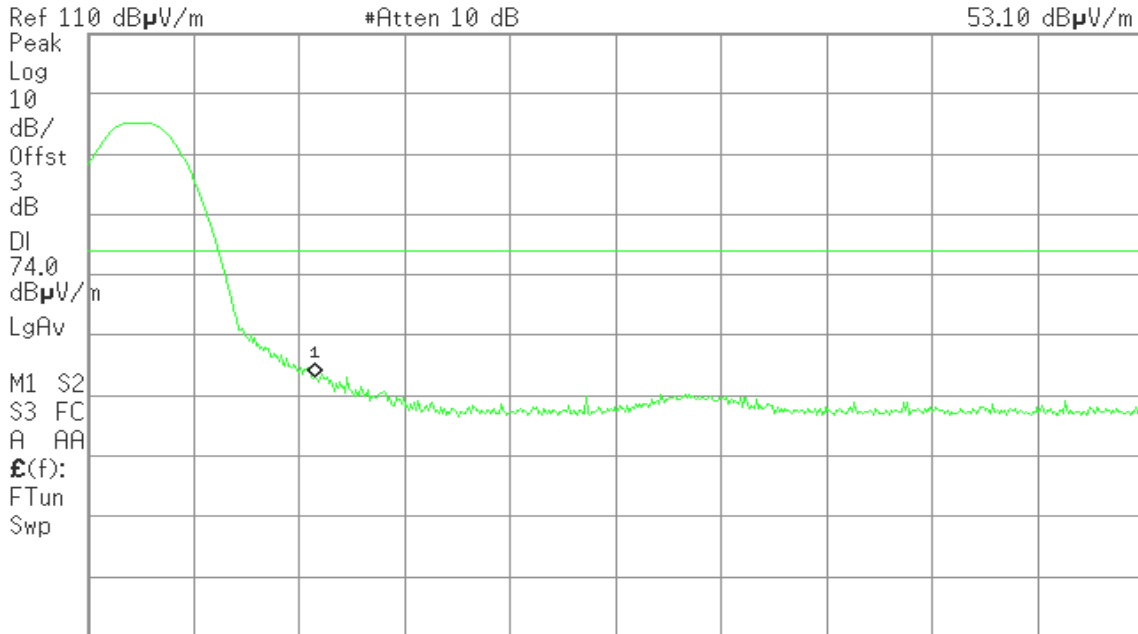

Start 2.479 00 GHz #Res BW 1 MHz #VBW 3 MHz Stop 2.500 00 GHz #Sweep 100 ms (601 pts)

Detector mode: Average

Polarity: Vertical

Agilent 13:07:32 17 Dec 2011

R T

Mkr2 2.491 14 GHz

38.00 dB $\mu$ V/m

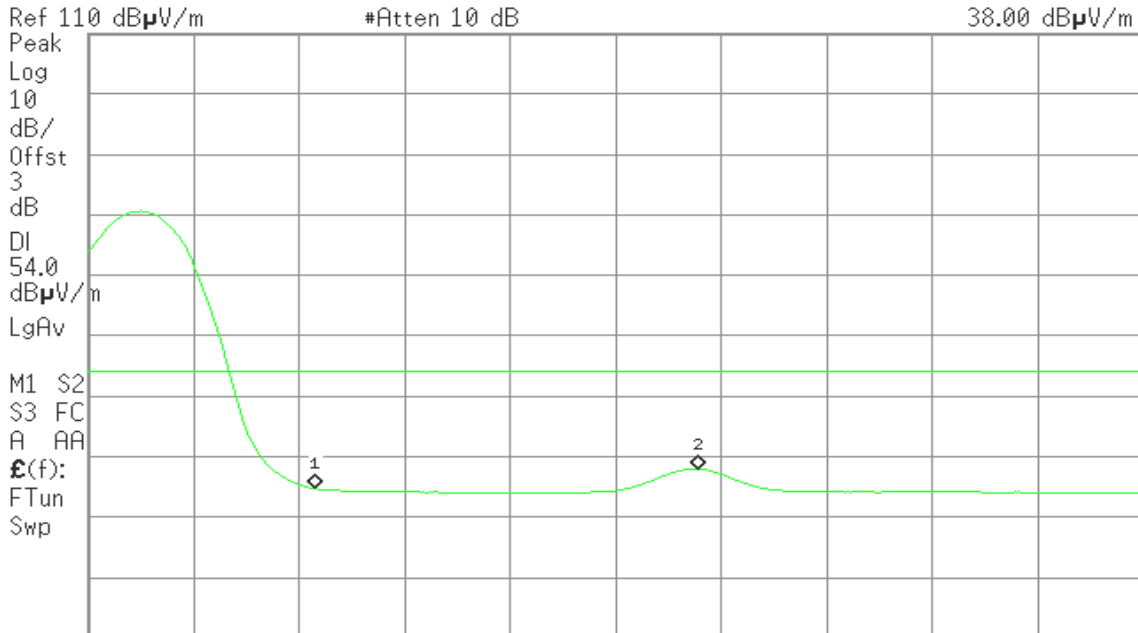

Start 2.479 00 GHz #Res BW 1 MHz #VBW 10 Hz Stop 2.500 00 GHz Sweep 1.637 s (601 pts)



Detector mode: Peak

Polarity: Horizontal

Agilent 13:03:40 17 Dec 2011

R T

Mkr1 2.483 50 GHz  
58.55 dB $\mu$ V/m

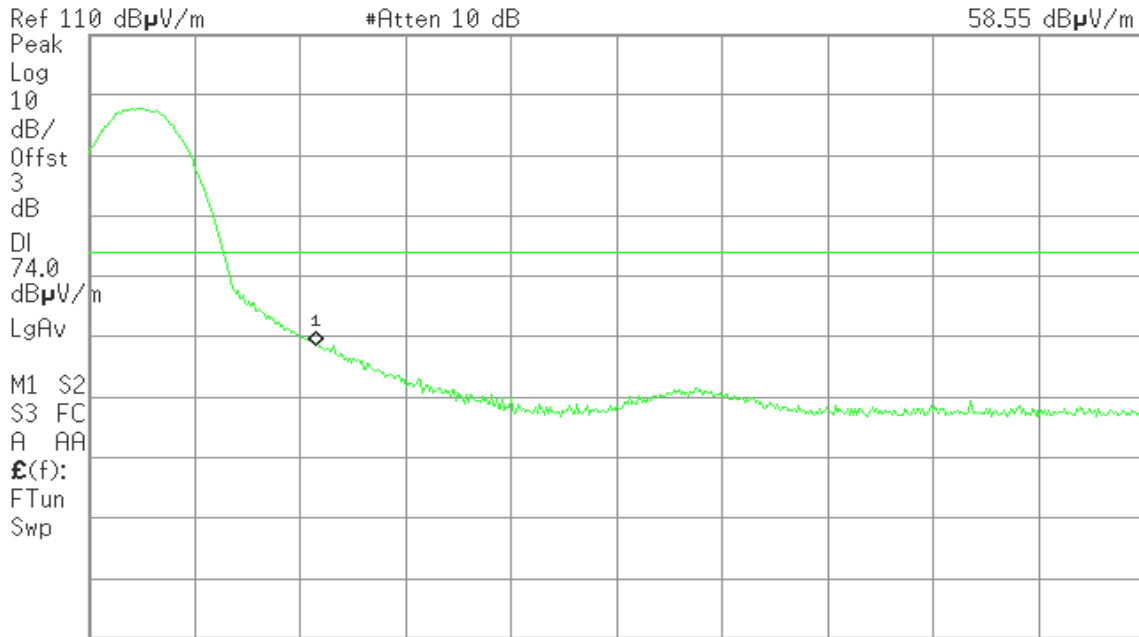

Start 2.479 00 GHz Stop 2.500 00 GHz  
#Res BW 1 MHz #VBW 3 MHz #Sweep 100 ms (601 pts)

Detector mode: Average

Polarity: Horizontal

Agilent 13:04:14 17 Dec 2011

R T

Mkr1 2.483 50 GHz  
35.21 dB $\mu$ V/m

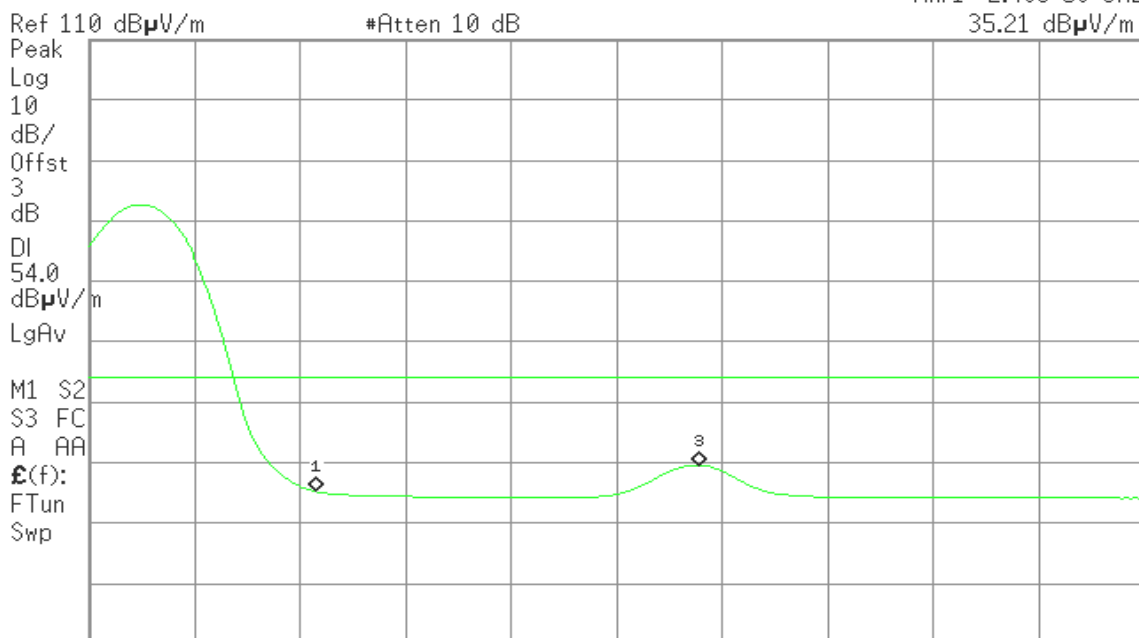

Start 2.479 00 GHz Stop 2.500 00 GHz  
#Res BW 1 MHz #VBW 10 Hz Sweep 1.637 s (601 pts)



**GFSK**  
**Hopping Mode**  
**(CH Low)**

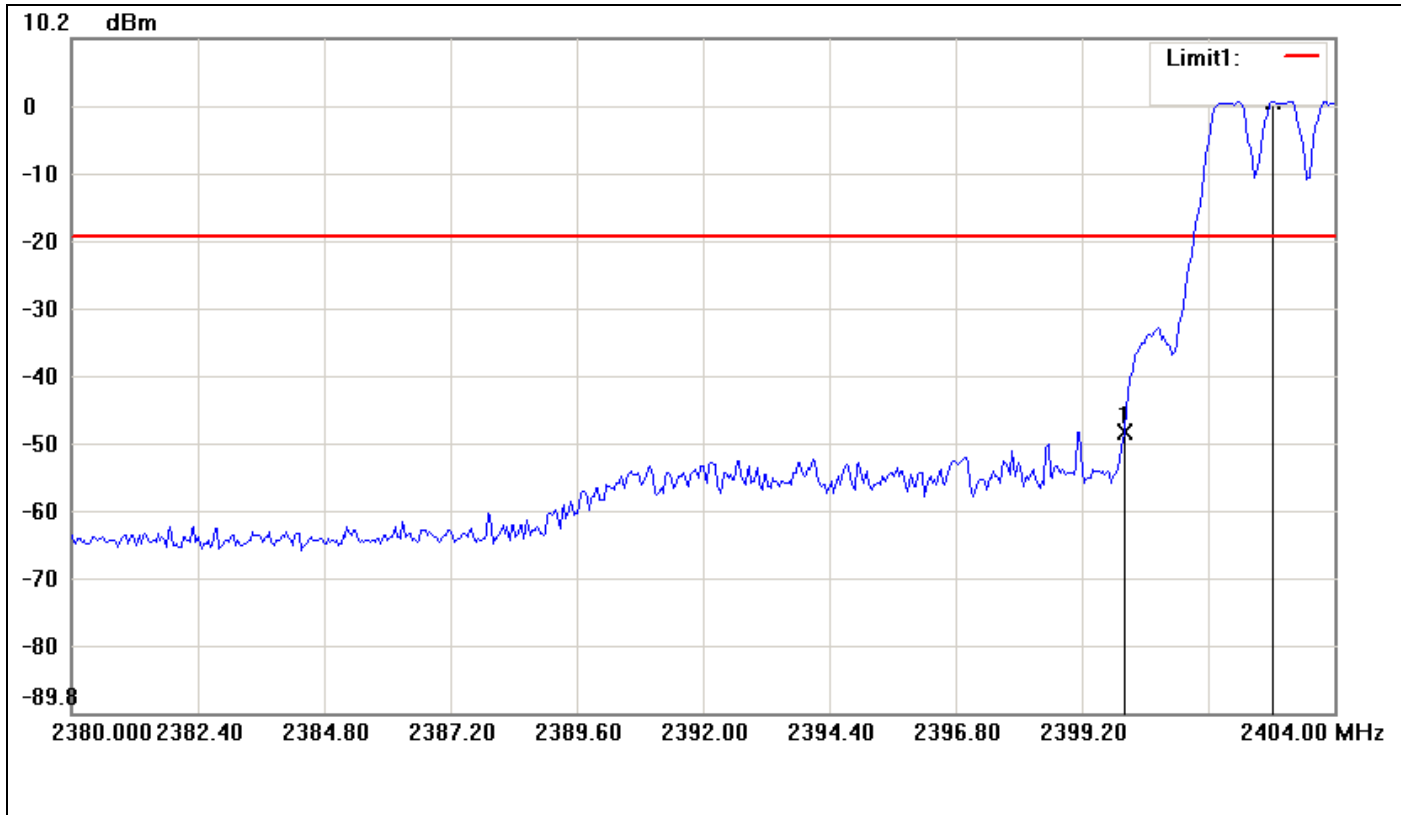

| No. | Frequency(MHz) | Level(dBm) | Limit(dBm) | Margin(dBm) |
|-----|----------------|------------|------------|-------------|
| 1   | 2400.0000      | -48.06     | -19.10     | -28.96      |
| 2   | 2402.8400      | 0.90       | -19.10     | 20.00       |



(CH High)

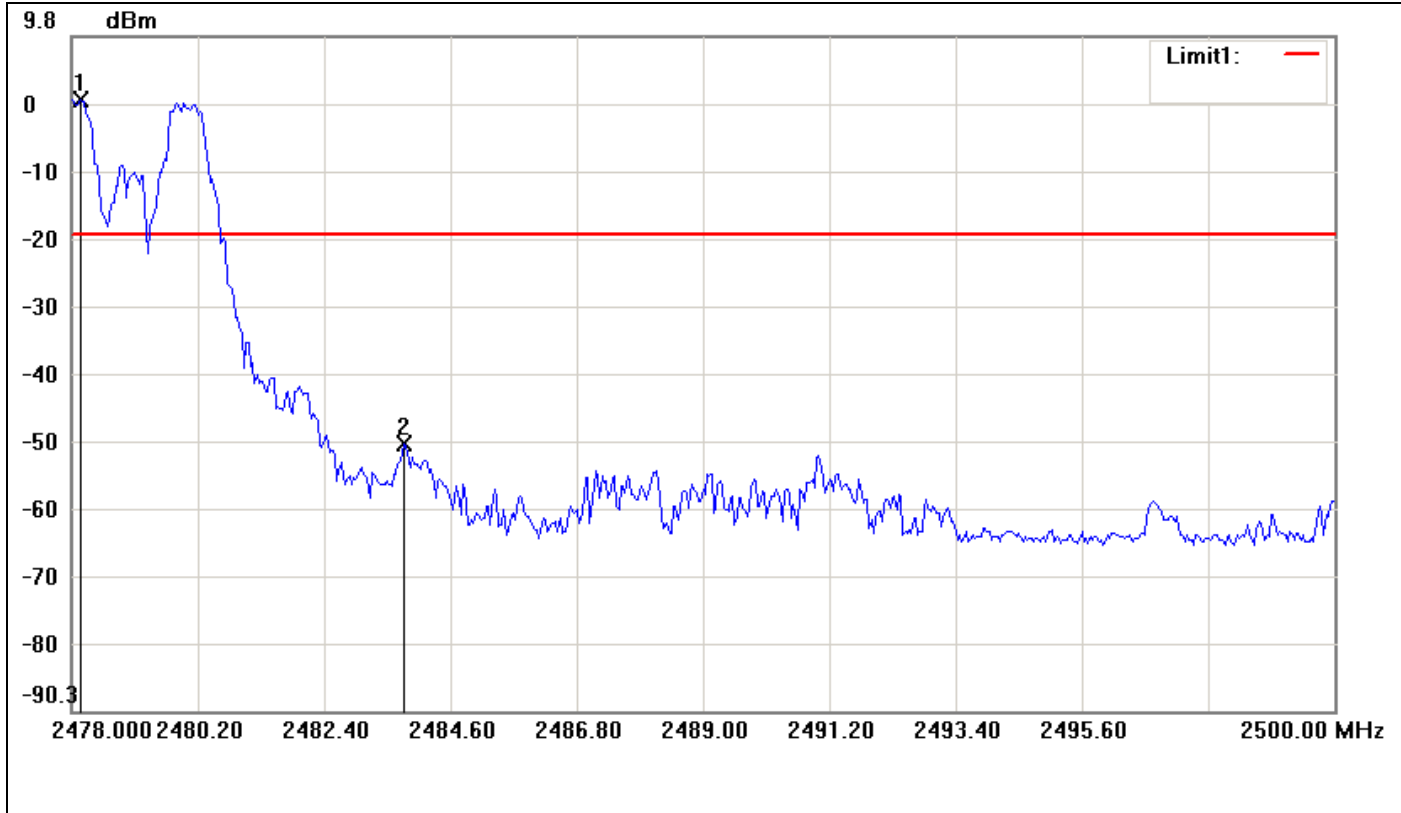

| No. | Frequency(MHz) | Level(dBm) | Limit(dBm) | Margin(dBm) |
|-----|----------------|------------|------------|-------------|
| 1   | 2478.1467      | 0.37       | -19.63     | 20.00       |
| 2   | 2483.7933      | -50.68     | -19.63     | -31.05      |





**8DPSK**  
**Hopping Mode**  
**(CH Low)**

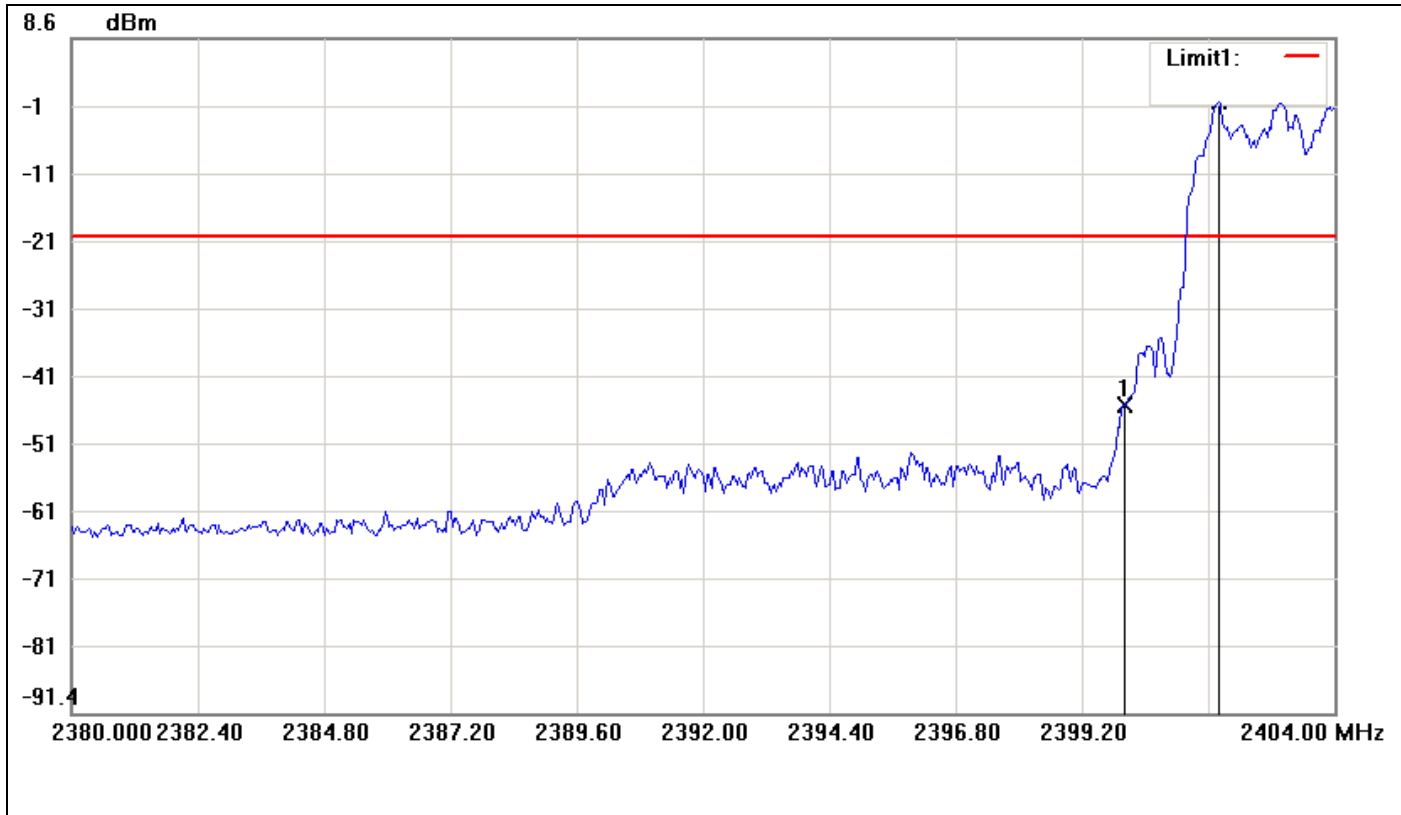

| No. | Frequency(MHz) | Level(dBm) | Limit(dBm) | Margin(dBm) |
|-----|----------------|------------|------------|-------------|
| 1   | 2400.0000      | -45.68     | -20.85     | -24.83      |
| 2   | 2401.8000      | -0.85      | -20.85     | 20.00       |



(CH High)

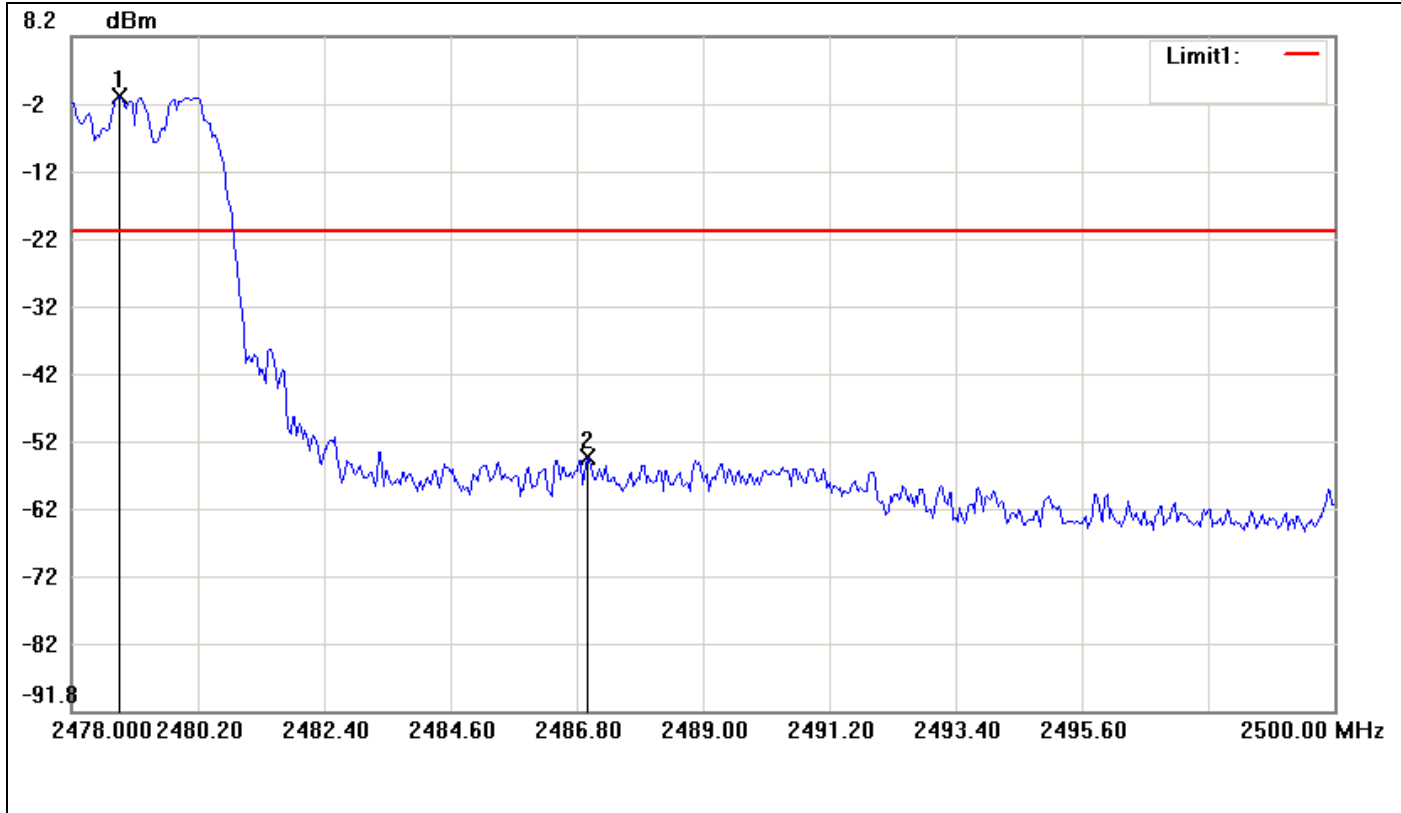

| No. | Frequency(MHz) | Level(dBm) | Limit(dBm) | Margin(dBm) |
|-----|----------------|------------|------------|-------------|
| 1   | 2478.8433      | -0.75      | -20.75     | 20.00       |
| 2   | 2486.9833      | -54.19     | -20.75     | -33.44      |



## 8.6 FREQUENCY SEPARATION

### LIMIT

According to §15.247(a)(1) & RSS-210 §A8.1 (2), Frequency hopping systems shall have hopping channel carrier frequencies separated by a minimum of 25 kHz or the 20 dB bandwidth of the hopping channel, whichever is greater. Alternatively, frequency hopping systems operating in the 2400-2483.5 MHz band may have hopping channel carrier frequencies that are separated by 25 kHz or two-thirds of the 20 dB bandwidth of the hopping channel, whichever is greater, provided the systems operate with an output power no greater than 125 mW.

### Test Configuration

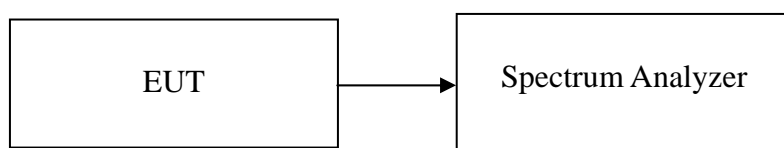

### TEST PROCEDURE

1. Place the EUT on the table and set it in transmitting mode.
2. Remove the antenna from the EUT and then connect a low loss RF cable from the antenna port to the spectrum analyzer.
3. Set center frequency of spectrum analyzer = middle of hopping channel.
4. Set the spectrum analyzer as RBW = 30kHz, VBW = 100kHz, Span = 3MHz, Sweep = auto.
5. Max hold, mark 3 peaks of hopping channel and record the 3 peaks frequency.

### TEST RESULTS

*No non-compliance noted*

#### Test Data

##### **For GFSK / DH5**

| Channel Separation (MHz) | two-thirds of the 20 dB bandwidth | Channel Separation Limit           | Result |
|--------------------------|-----------------------------------|------------------------------------|--------|
| 1.025                    | 646.66                            | >two-thirds of the 20 dB bandwidth | Pass   |

##### **For 8DPSK / DH5**

| Channel Separation (MHz) | two-thirds of the 20 dB bandwidth | Channel Separation Limit           | Result |
|--------------------------|-----------------------------------|------------------------------------|--------|
| 1.27                     | 870                               | >two-thirds of the 20 dB bandwidth | Pass   |



**Test Plot**

**For GFSK / DH5**

**Measurement of Channel Separation**

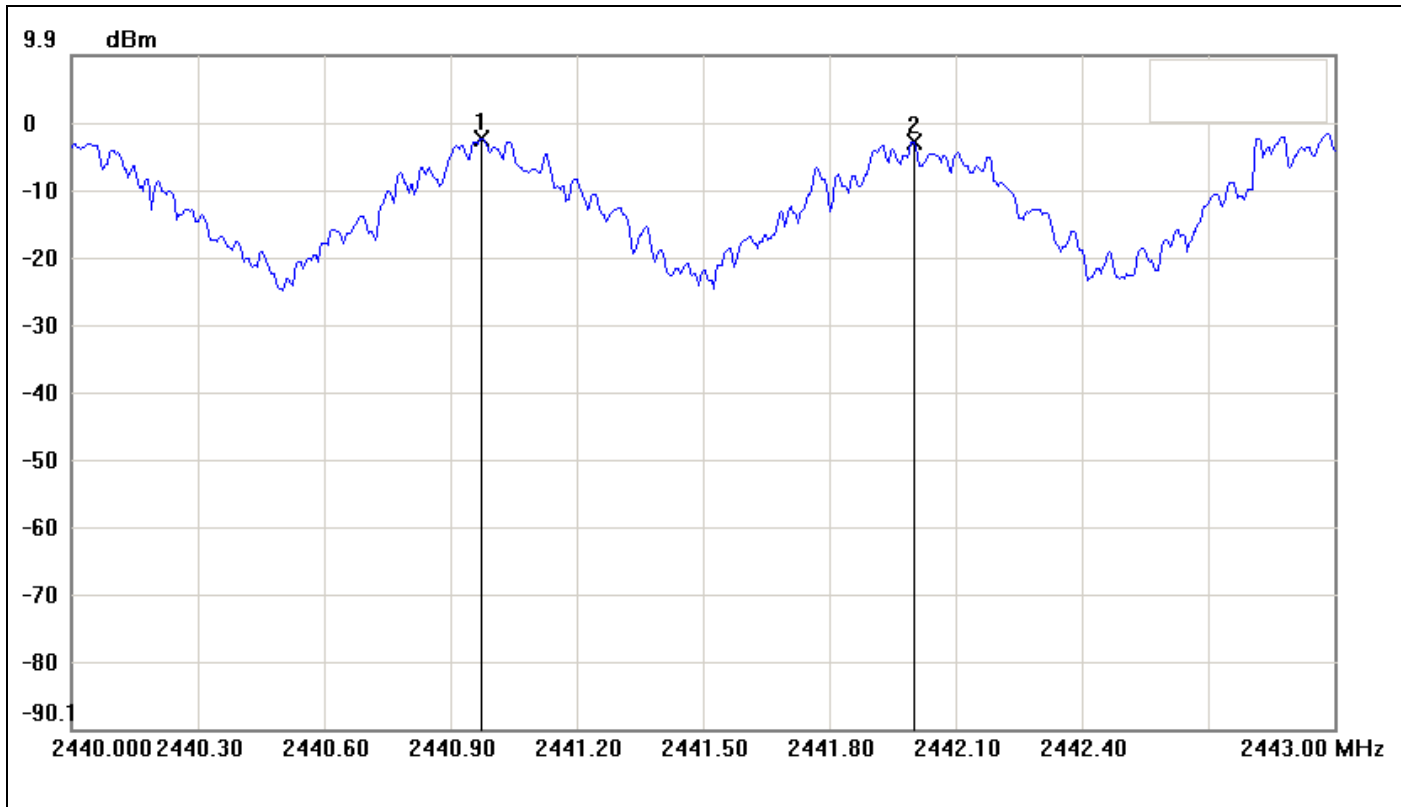

| No. | Frequency(MHz) | Level(dBm) | Limit(dBm) | Margin(dBm) |
|-----|----------------|------------|------------|-------------|
| 1   | 2440.9750      | -2.53      |            |             |
| 2   | 2442.0000      | -3.00      |            |             |

| No. |         | $\Delta$ Frequency(MHz) | $\Delta$ Level(dB) |
|-----|---------|-------------------------|--------------------|
| 1   | mk2-mk1 | 1.025                   | -0.47              |



**Measurement of 20dB Bandwidth**

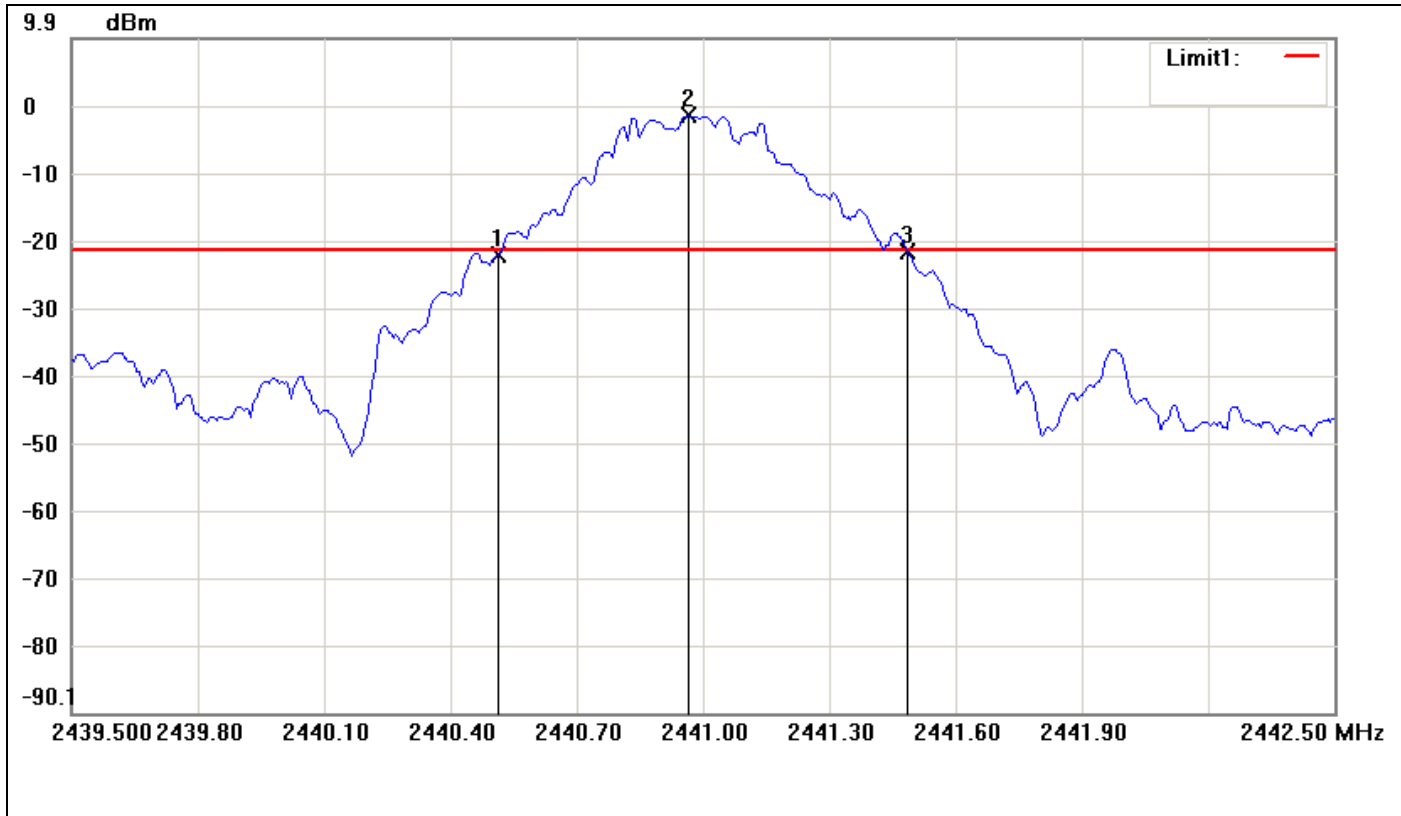

| No. | Frequency(MHz) | Level(dBm) | Limit(dBm) | Margin(dBm) |
|-----|----------------|------------|------------|-------------|
| 1   | 2440.5150      | -22.18     | -21.59     | -0.59       |
| 2   | 2440.9650      | -1.59      | -21.59     | 20.00       |
| 3   | 2441.4850      | -21.83     | -21.59     | -0.24       |

| No. |         | $\Delta$ Frequency(MHz) | $\Delta$ Level(dB) |
|-----|---------|-------------------------|--------------------|
| 1   | mk3-mk1 | 0.97                    | 0.35               |



**For 8DPSK / DH5**

**Measurement of Channel Separation**

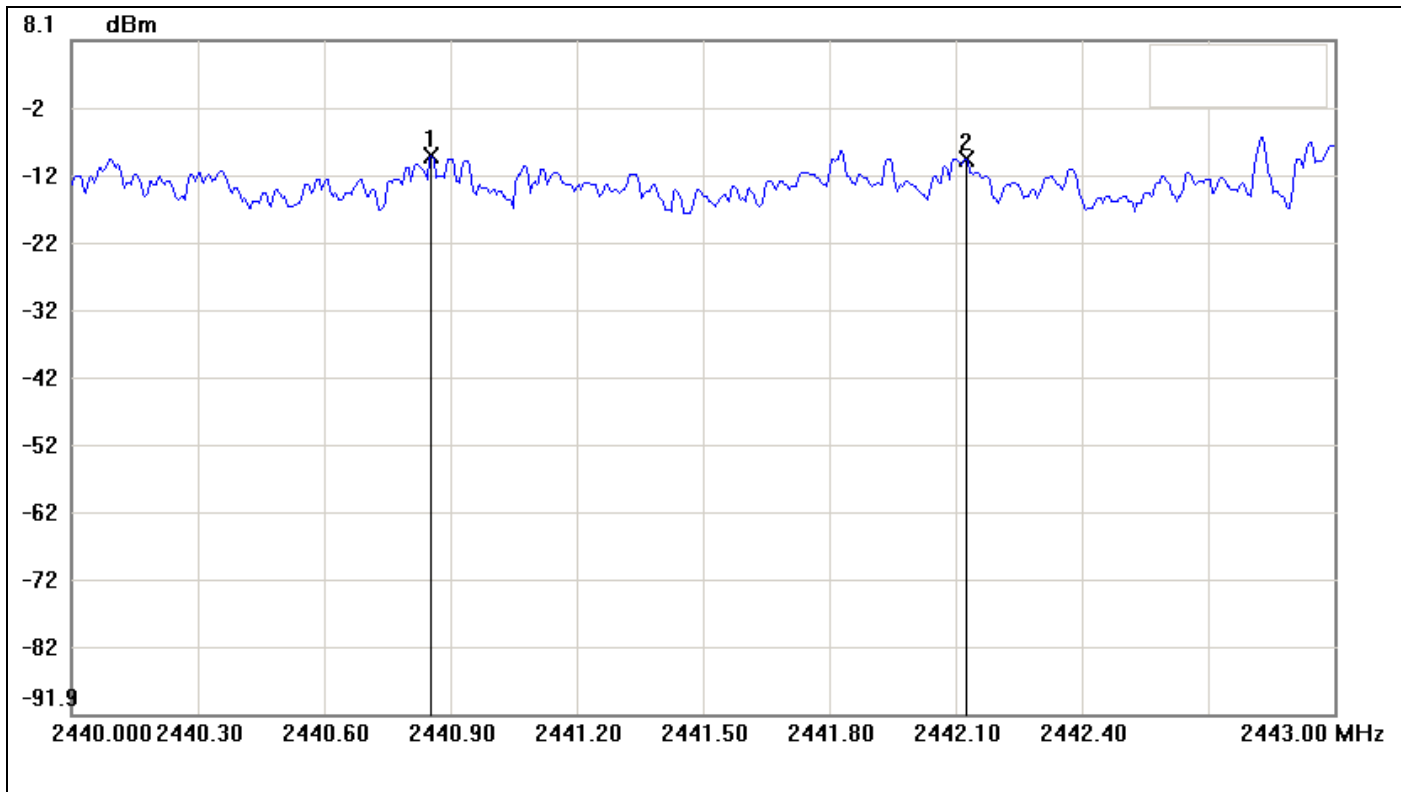

| No. | Frequency(MHz) | Level(dBm) | Limit(dBm) | Margin(dBm) |
|-----|----------------|------------|------------|-------------|
| 1   | 2440.8550      | -9.01      |            |             |
| 2   | 2442.1250      | -9.39      |            |             |

| No. |         | $\Delta$ Frequency(MHz) | $\Delta$ Level(dB) |
|-----|---------|-------------------------|--------------------|
| 1   | mk2-mk1 | 1.27                    | -0.38              |



**Measurement of 20dB Bandwidth**

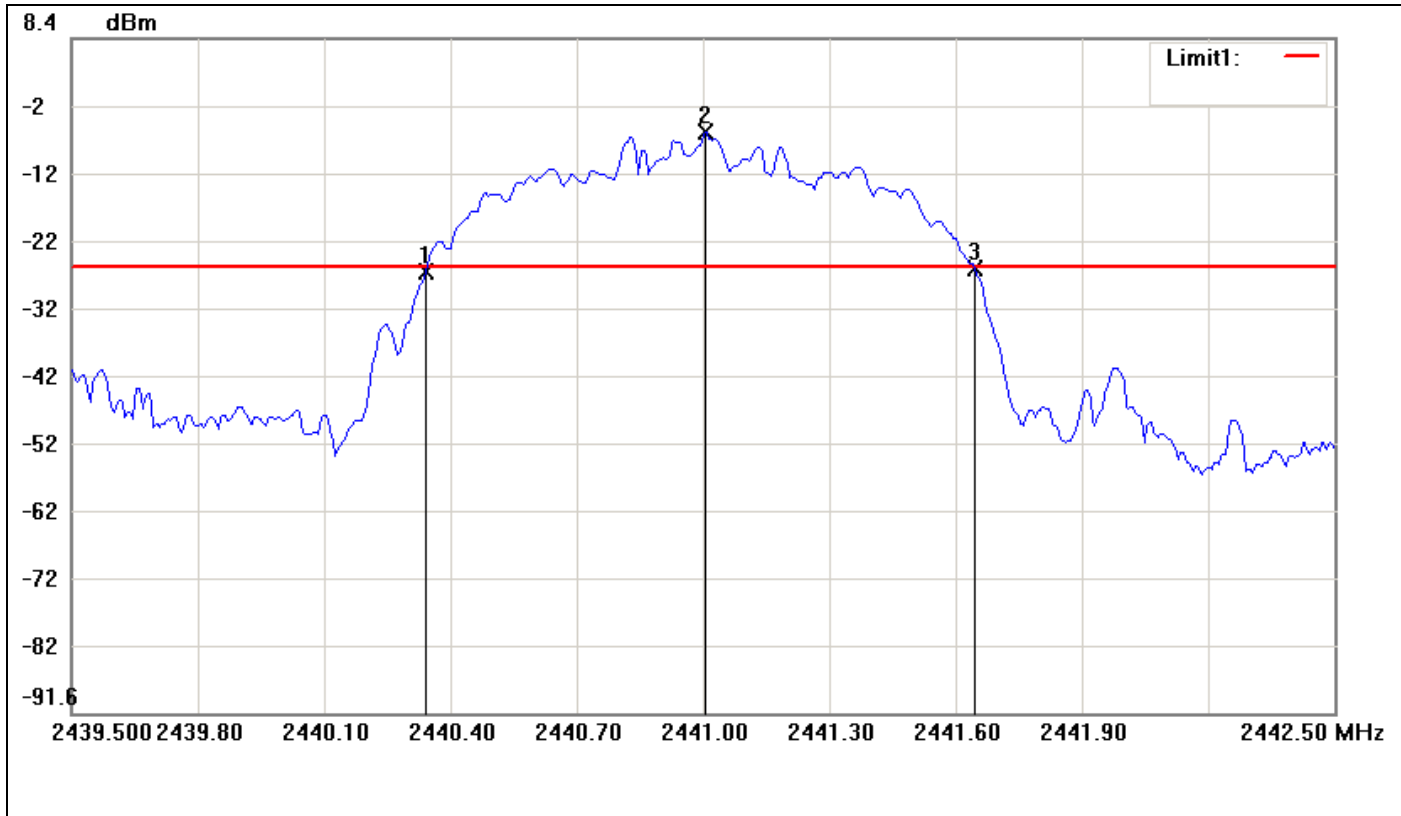

| No. | Frequency(MHz) | Level(dBm) | Limit(dBm) | Margin(dBm) |
|-----|----------------|------------|------------|-------------|
| 1   | 2440.3400      | -26.34     | -25.44     | -0.90       |
| 2   | 2441.0050      | -5.44      | -25.44     | 20.00       |
| 3   | 2441.6450      | -25.79     | -25.44     | -0.35       |

| No. |         | $\Delta$ Frequency(MHz) | $\Delta$ Level(dB) |
|-----|---------|-------------------------|--------------------|
| 1   | mk3-mk1 | 1.305                   | 0.55               |



## 8.7 NUMBER OF HOPPING FREQUENCY

### LIMIT

According to §15.247(a)(1)(ii), Frequency hopping systems operating in the 2400MHz-2483.5 MHz bands shall use at least 75 hopping frequencies.

### Test Configuration

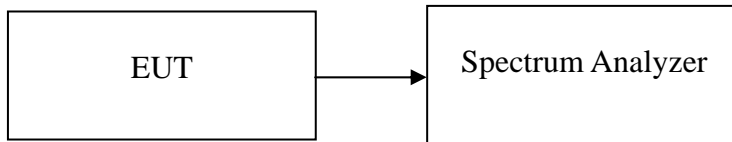

### TEST PROCEDURE

1. Place the EUT on the table and set it in transmitting mode.
2. Remove the antenna from the EUT and then connect a low loss RF cable from the antenna port to the spectrum analyzer.
3. Set spectrum analyzer Start=2400MHz, Stop = 2430.5MHz, Sweep = auto, Start=2430.5MHz, Stop = 2460.5MHz, Sweep = auto and Start=2460.5MHz, Stop =2485.5MHz, Sweep = auto.
4. Set the spectrum analyzer as RBW, VBW = 510kHz.
5. Max hold, view and count how many channel in the band.

### TEST RESULTS

*No non-compliance noted*

### Test Data

| Result (No. of CH) | Limit (No. of CH) | Result |
|--------------------|-------------------|--------|
| 79                 | >15               | PASS   |





**Test Plot**  
**For GFSK**

**Channel Number**

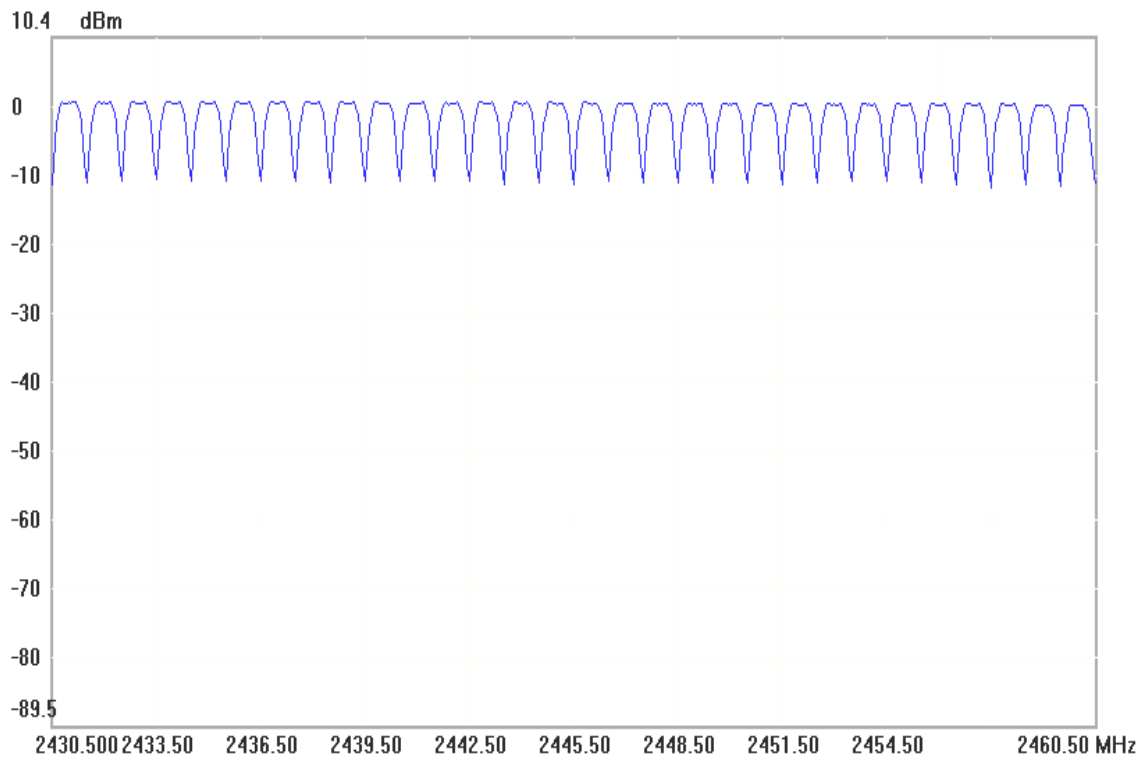
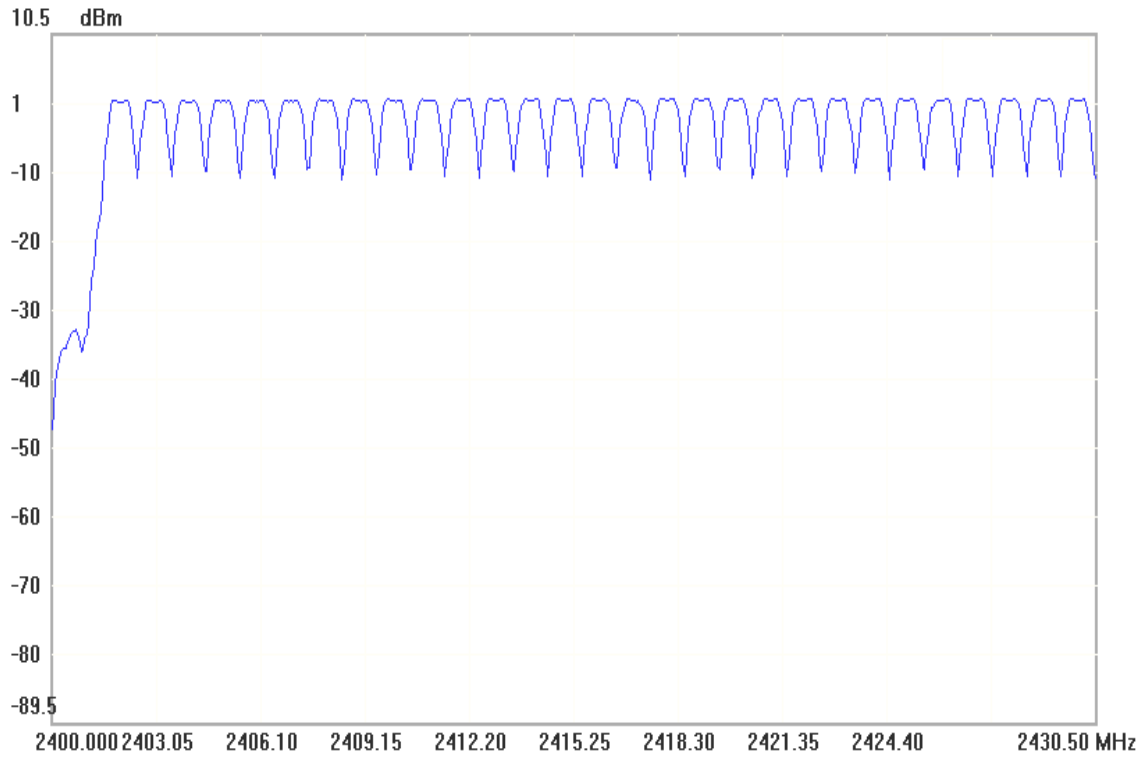

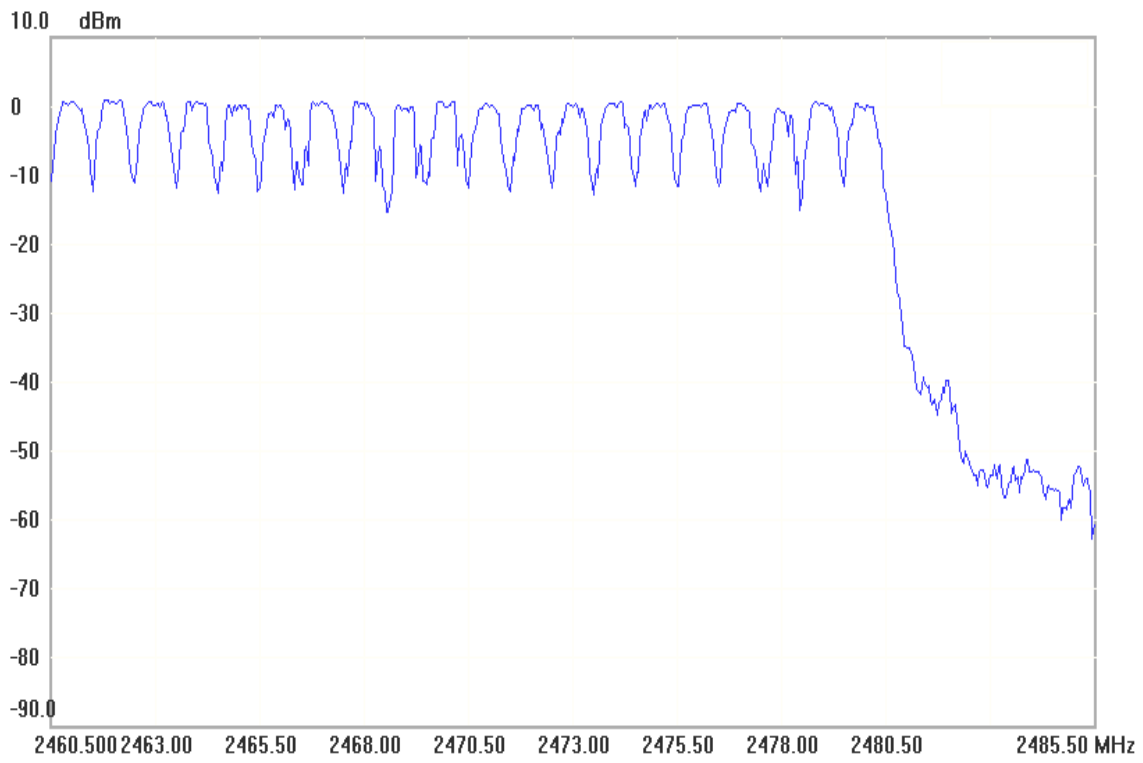



**For 8DPSK**

**Channel Number**

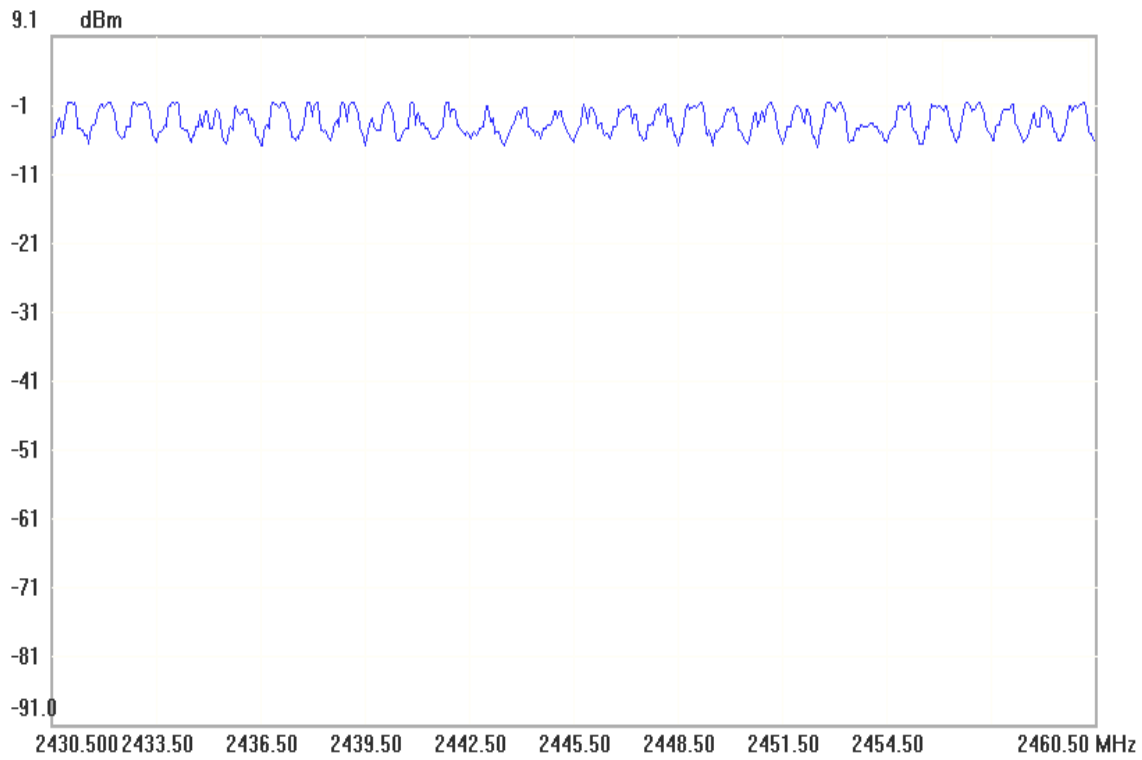
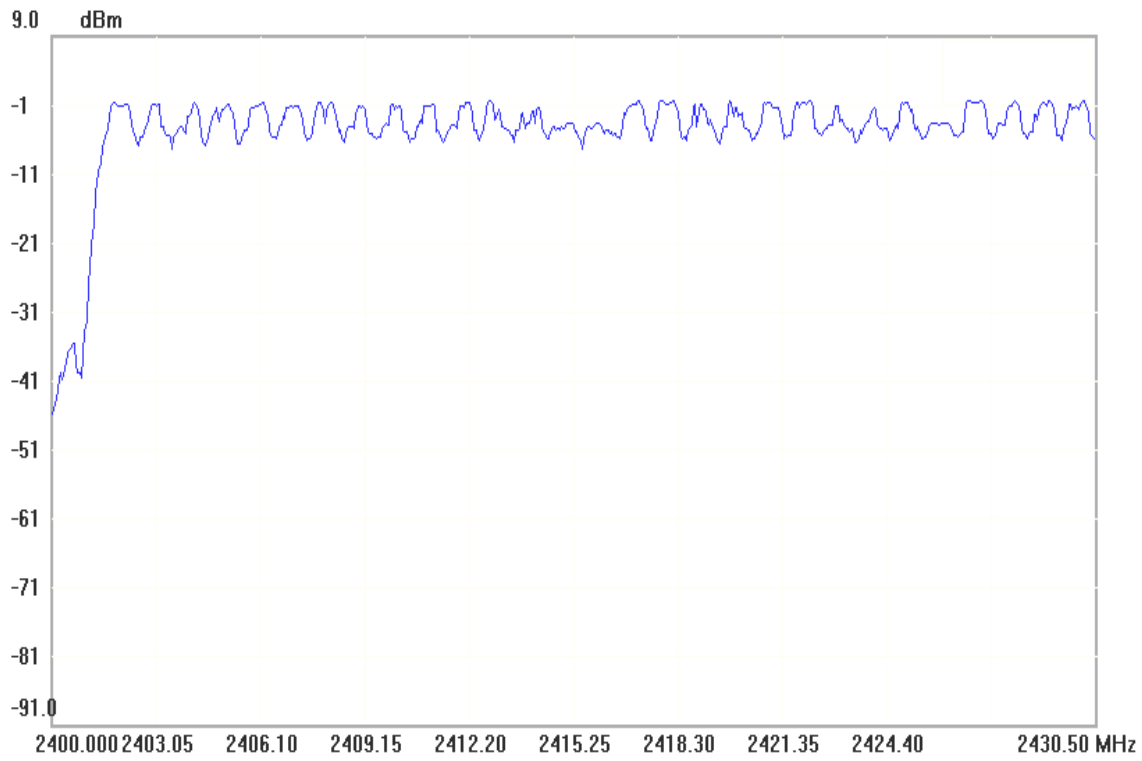

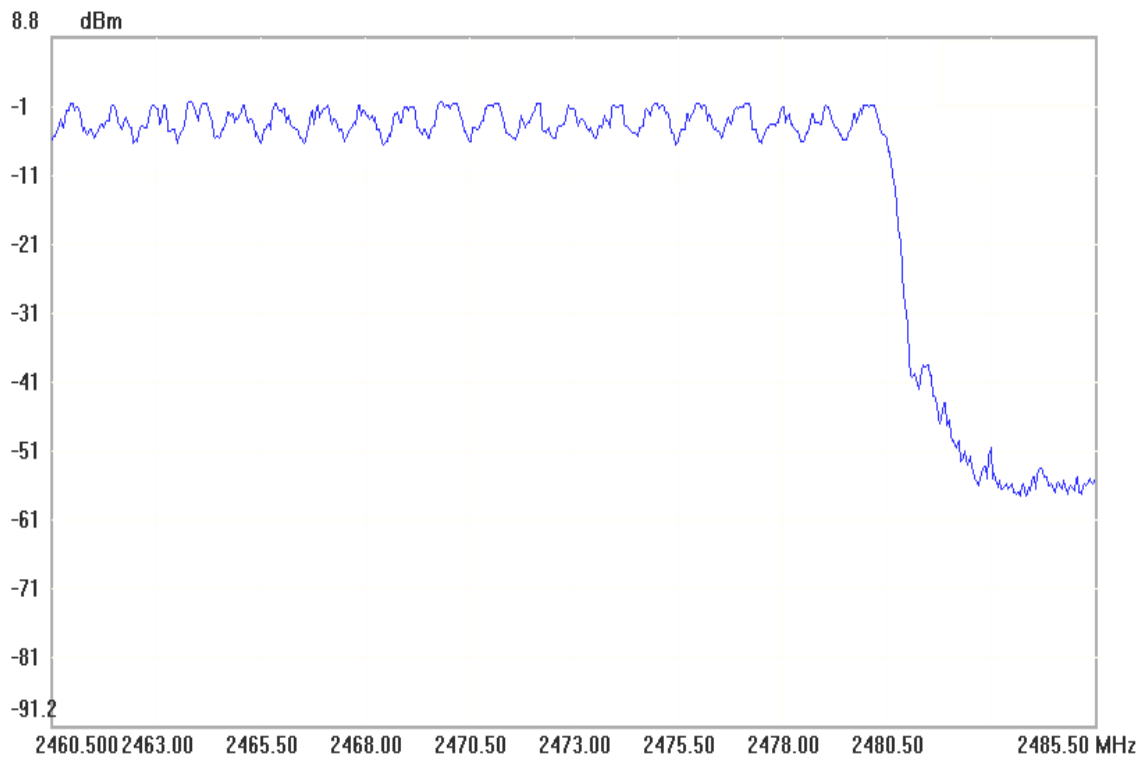



## 8.8 TIME OF OCCUPANCY (DWELL TIME)

### LIMIT

According to §15.247(a)(1)(iii), Frequency hopping systems operating in the 2400MHz-2483.5 MHz bands. The average time of occupancy on any channels shall not greater than 0.4 s within a period 0.4 s multiplied by the number of hopping channels employed.

According to RSS-210 §A8.1(4), the average time of occupancy on any channel shall not be greater than 0.4 seconds within a period of 0.4 seconds multiplied by the number of hopping channels employed. Transmissions on particular hopping frequencies may be avoided or suppressed provided that a minimum of 15 hopping channels are used.

### Test Configuration

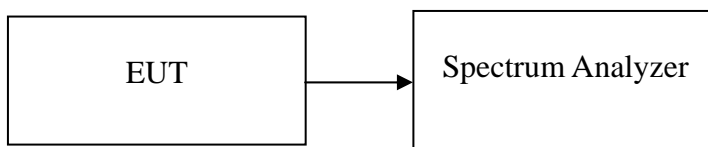

### TEST PROCEDURE

1. Place the EUT on the table and set it in transmitting mode.
2. Remove the antenna from the EUT and then connect a low loss RF cable from the antenna port to the spectrum analyzer.
3. Set center frequency of spectrum analyzer = operating frequency.
4. Set the spectrum analyzer as RBW = 1000 KHz, VBW = RBW, Span = 0Hz, Sweep = auto.
5. Repeat above procedures until all frequency measured were complete.

### TEST RESULTS

*No non-compliance noted*



**For GFSK**

**Test Data**

DH 1:  $0.3933 * (1600/2)/79 * 31.6 = 125.856$  (ms)

DH 3:  $1.655 * (1600/4)/79 * 31.6 = 264.800$  (ms)

DH 5:  $2.9083 * (1600/6)/79 * 31.6 = 310.219$  (ms)

|      | <b>Pulse Time<br/>(ms)</b> | <b>Total of Dwell<br/>(ms)</b> | <b>Period Time<br/>(s)</b> | <b>Limit<br/>(ms)</b> | <b>Result</b> |
|------|----------------------------|--------------------------------|----------------------------|-----------------------|---------------|
| DH 1 | 0.3933                     | 125.856                        | 31.60                      | 400.00                | PASS          |
| DH 3 | 1.655                      | 264.800                        | 31.60                      |                       | PASS          |
| DH 5 | 2.9083                     | 310.219                        | 31.60                      |                       | PASS          |



**Test Plot**

**DH 1**

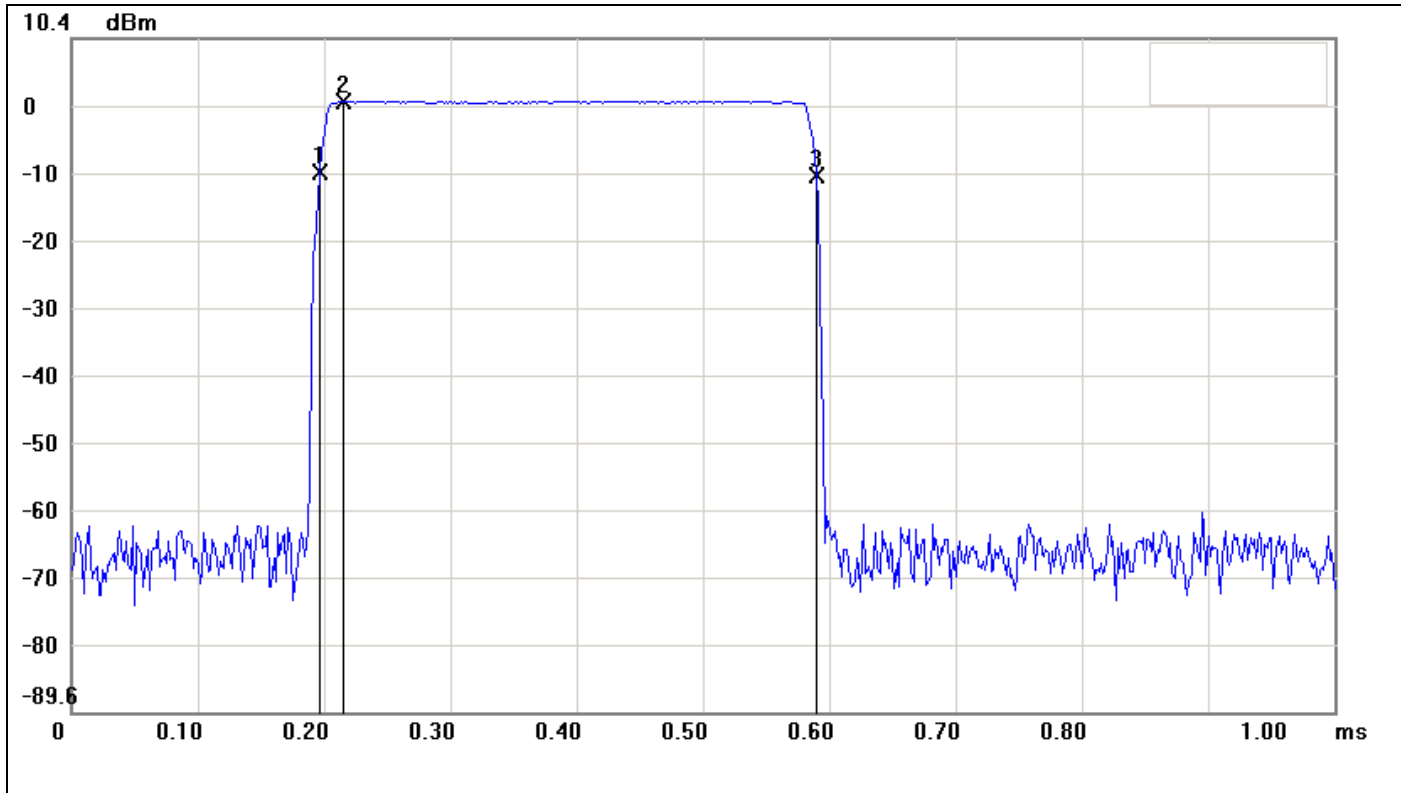

| No. | Sweep time(ms) | Level(dBm) | Limit(dBm) | Margin(dBm) |
|-----|----------------|------------|------------|-------------|
| 1   | 0.1967         | -9.58      |            |             |
| 2   | 0.2150         | 1.06       |            |             |
| 3   | 0.5900         | -10.08     |            |             |

| No. |         | $\Delta$ Time(ms) | $\Delta$ Level(dB) |
|-----|---------|-------------------|--------------------|
| 1   | mk3-mk1 | 0.3933            | -0.5               |



**DH 3**

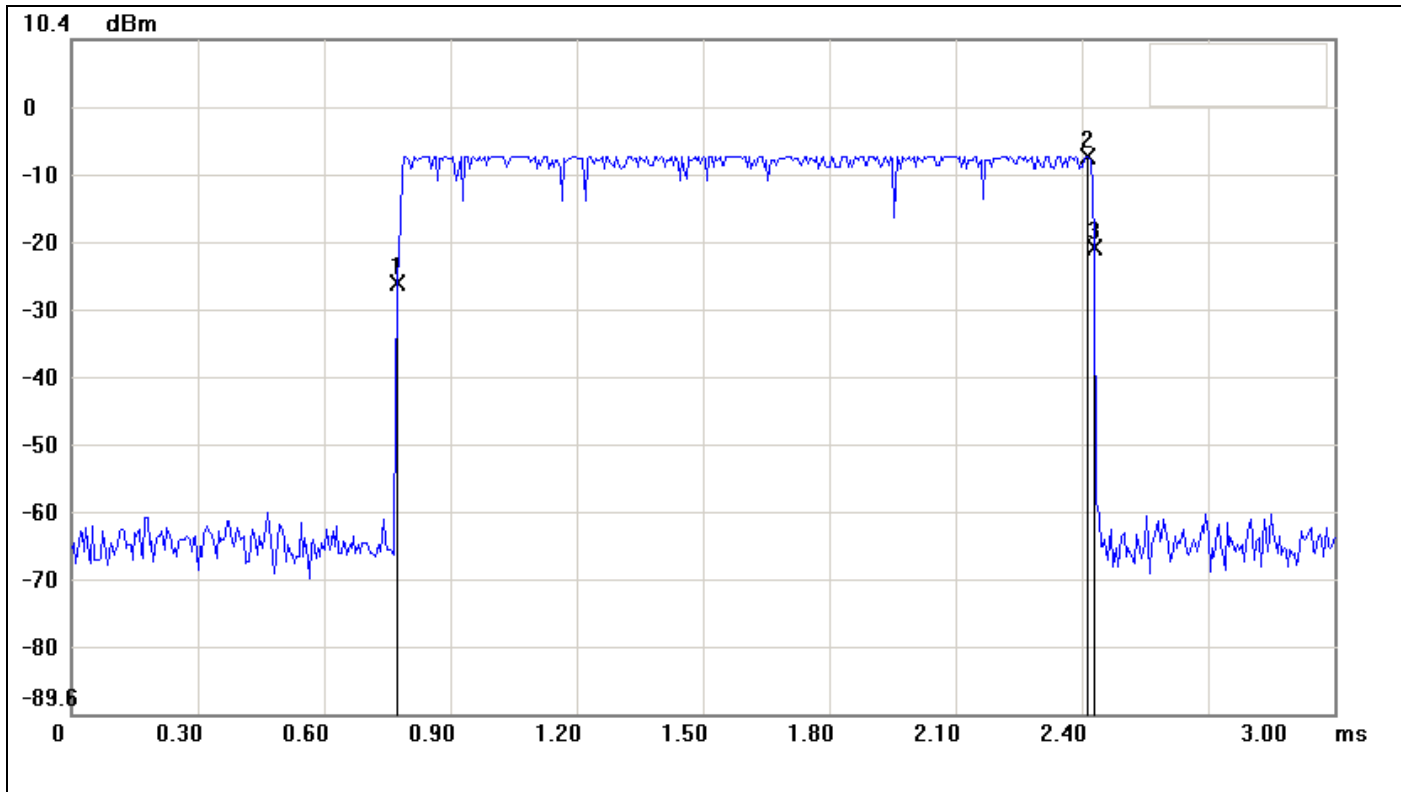

| No. | Sweep time(ms) | Level(dBm) | Limit(dBm) | Margin(dBm) |
|-----|----------------|------------|------------|-------------|
| 1   | 0.7750         | -25.66     |            |             |
| 2   | 2.4150         | -6.89      |            |             |
| 3   | 2.4300         | -20.47     |            |             |

| No. |         | $\Delta$ Time(ms) | $\Delta$ Level(dB) |
|-----|---------|-------------------|--------------------|
| 1   | mk3-mk1 | 1.655             | 5.19               |





**DH 5**

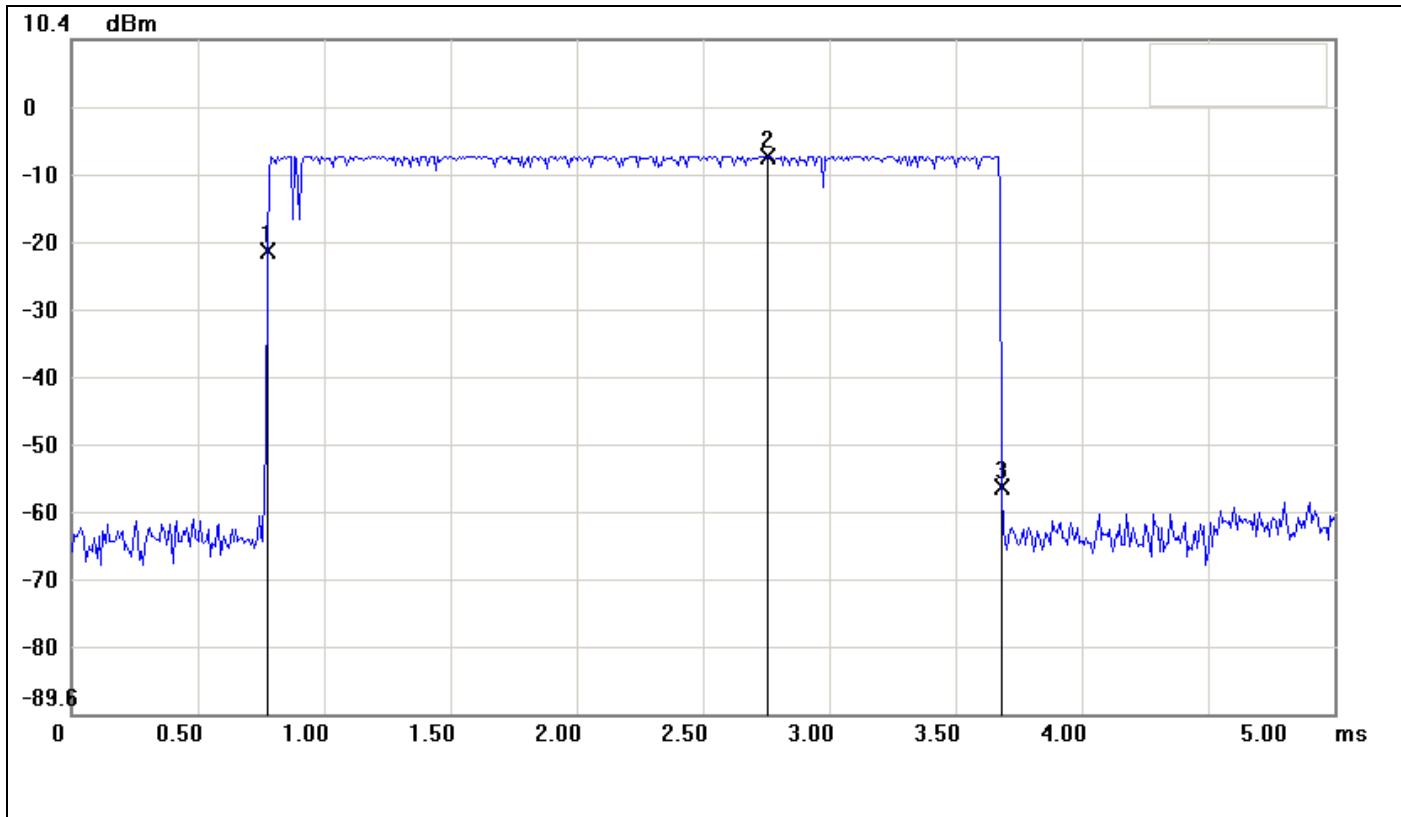

| No. | Sweep time(ms) | Level(dBm) | Limit(dBm) | Margin(dBm) |
|-----|----------------|------------|------------|-------------|
| 1   | 0.7750         | -20.86     |            |             |
| 2   | 2.7583         | -6.96      |            |             |
| 3   | 3.6833         | -56.04     |            |             |

| No. |         | $\Delta$ Time(ms) | $\Delta$ Level(dB) |
|-----|---------|-------------------|--------------------|
| 1   | mk3-mk1 | 2.9083            | -35.18             |



**For 8DPSK**

**Test Data**

DH 1:  $0.3967 * (1600/2)/79 * 31.6 = 126.944$  (ms)

DH 3:  $1.645 * (1600/4)/79 * 31.6 = 263.200$  (ms)

DH 5:  $2.9333 * (1600/6)/79 * 31.6 = 312.885$  (ms)

|      | <b>Pulse Time<br/>(ms)</b> | <b>Total of Dwell<br/>(ms)</b> | <b>Period Time<br/>(s)</b> | <b>Limit<br/>(ms)</b> | <b>Result</b> |
|------|----------------------------|--------------------------------|----------------------------|-----------------------|---------------|
| DH 1 | 0.3967                     | 126.944                        | 31.60                      | 400.00                | PASS          |
| DH 3 | 1.645                      | 263.200                        | 31.60                      |                       | PASS          |
| DH 5 | 2.9333                     | 312.885                        | 31.60                      |                       | PASS          |



**Test Plot**

**DH 1**

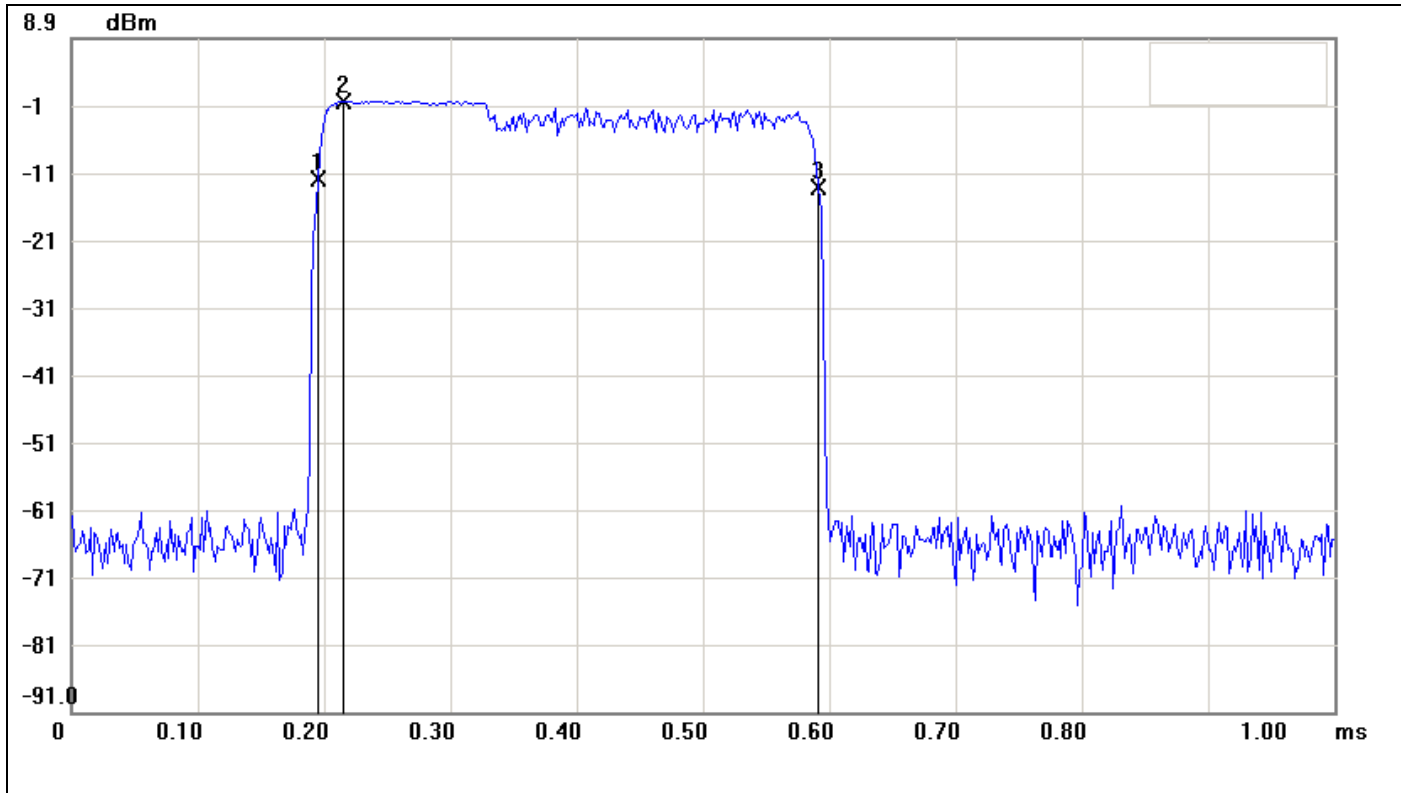

| No. | Sweep time(ms) | Level(dBm) | Limit(dBm) | Margin(dBm) |
|-----|----------------|------------|------------|-------------|
| 1   | 0.1950         | -11.98     |            |             |
| 2   | 0.2150         | -0.46      |            |             |
| 3   | 0.5917         | -13.28     |            |             |

| No. |         | $\Delta$ Time(ms) | $\Delta$ Level(dB) |
|-----|---------|-------------------|--------------------|
| 1   | mk3-mk1 | 0.3967            | -1.3               |



**DH 3**

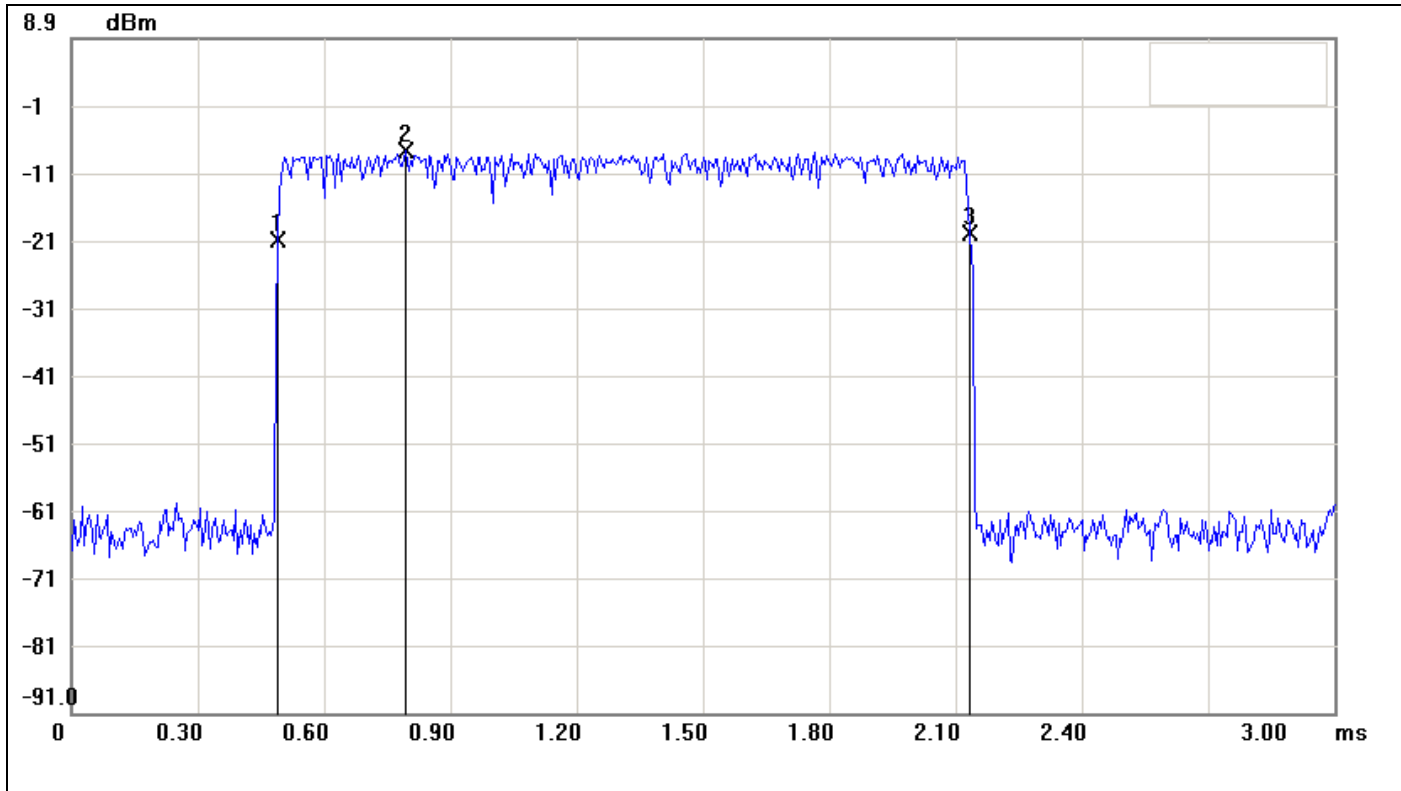

| No. | Sweep time(ms) | Level(dBm) | Limit(dBm) | Margin(dBm) |
|-----|----------------|------------|------------|-------------|
| 1   | 0.4900         | -20.97     |            |             |
| 2   | 0.7950         | -7.79      |            |             |
| 3   | 2.1350         | -19.83     |            |             |

| No. |         | $\Delta$ Time(ms) | $\Delta$ Level(dB) |
|-----|---------|-------------------|--------------------|
| 1   | mk3-mk1 | 1.645             | 1.14               |



**DH 5**

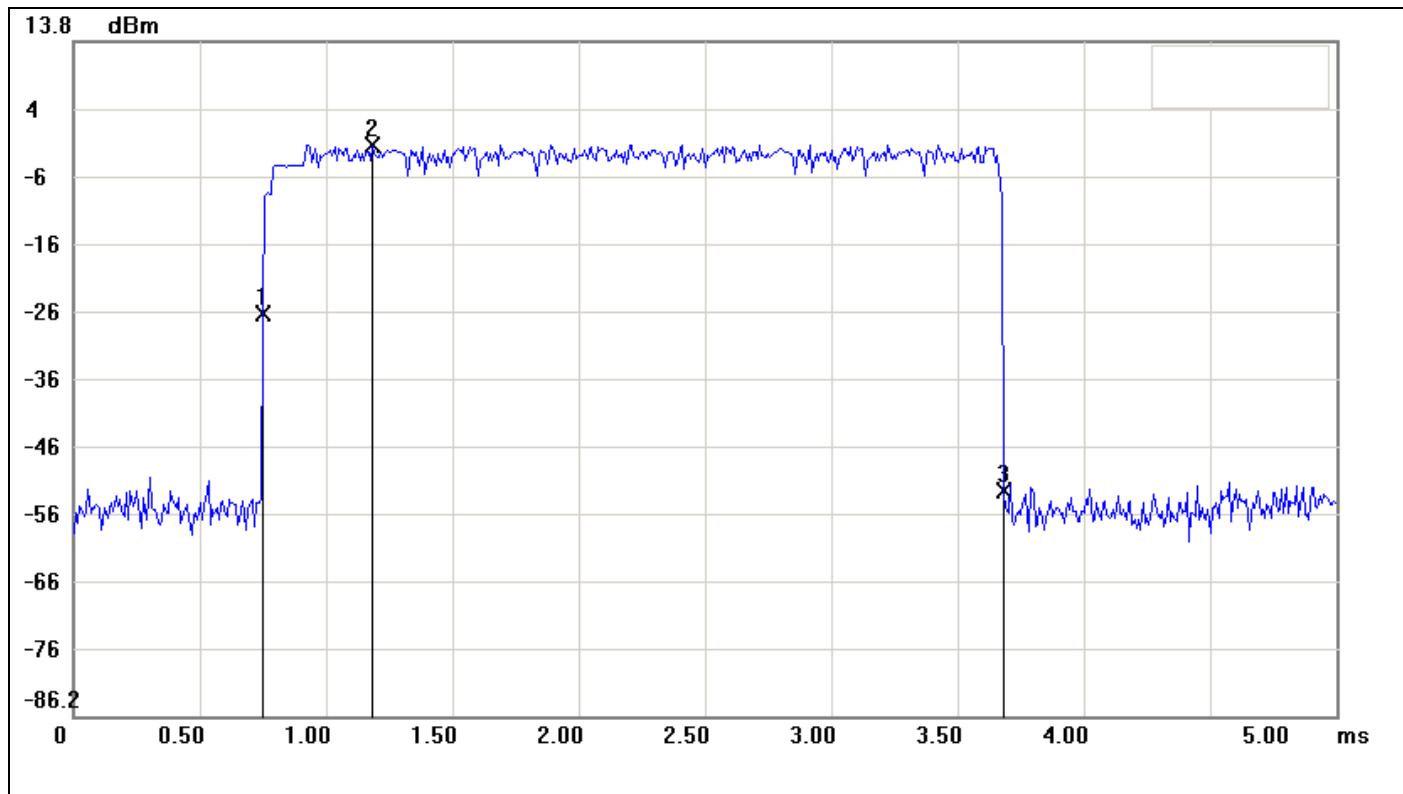

| No. | Sweep time(ms) | Level(dBm) | Limit(dBm) | Margin(dBm) |
|-----|----------------|------------|------------|-------------|
| 1   | 0.7500         | -26.45     |            |             |
| 2   | 1.1833         | -1.43      |            |             |
| 3   | 3.6833         | -52.72     |            |             |

| No. |         | $\Delta$ Time(ms) | $\Delta$ Level(dB) |
|-----|---------|-------------------|--------------------|
| 1   | mk3-mk1 | 2.9333            | -26.27             |



## 8.9 SPURIOUS EMISSIONS

### 8.9.1 Conducted Measurement

#### LIMIT

According to §15.247(d) & RSS-210 §A8.5, in any 100 kHz bandwidth outside the frequency bands in which the spread spectrum intentional radiator is operating, the radio frequency power that is produced by the intentional radiator shall be at least 20 dB below that in the 100 kHz bandwidth within the band that contains the highest level of the desired power, based on either an RF conducted or a radiated measurement, provided the transmitter demonstrates compliance with the peak conducted power limits. In addition, radiated emissions which fall in the restricted bands, as defined in §15.205(a), must also comply with the radiated emission limits specified in 15.209(a) (see Section 15.205(c)).

#### Test Configuration

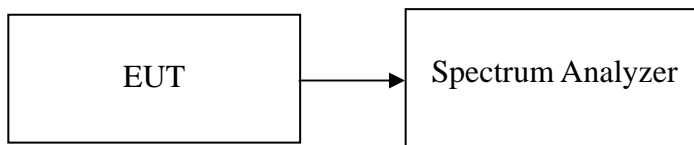

#### TEST PROCEDURE

Conducted RF measurements of the transmitter output were made to confirm that the EUT antenna port conducted emissions meet the specified limit and to identify any spurious signals that require further investigation or measurements on the radiated emissions site.

The transmitter output is connected to the spectrum analyzer. The resolution bandwidth is set to 100 kHz. The video bandwidth is set to 100 kHz.

Measurements are made over the 30MHz to 26GHz range with the transmitter set to the lowest, middle, and highest channels.

#### TEST RESULTS

*No non-compliance noted*



**Test Plot**

**For GFSK / DH5**

**CH Low**

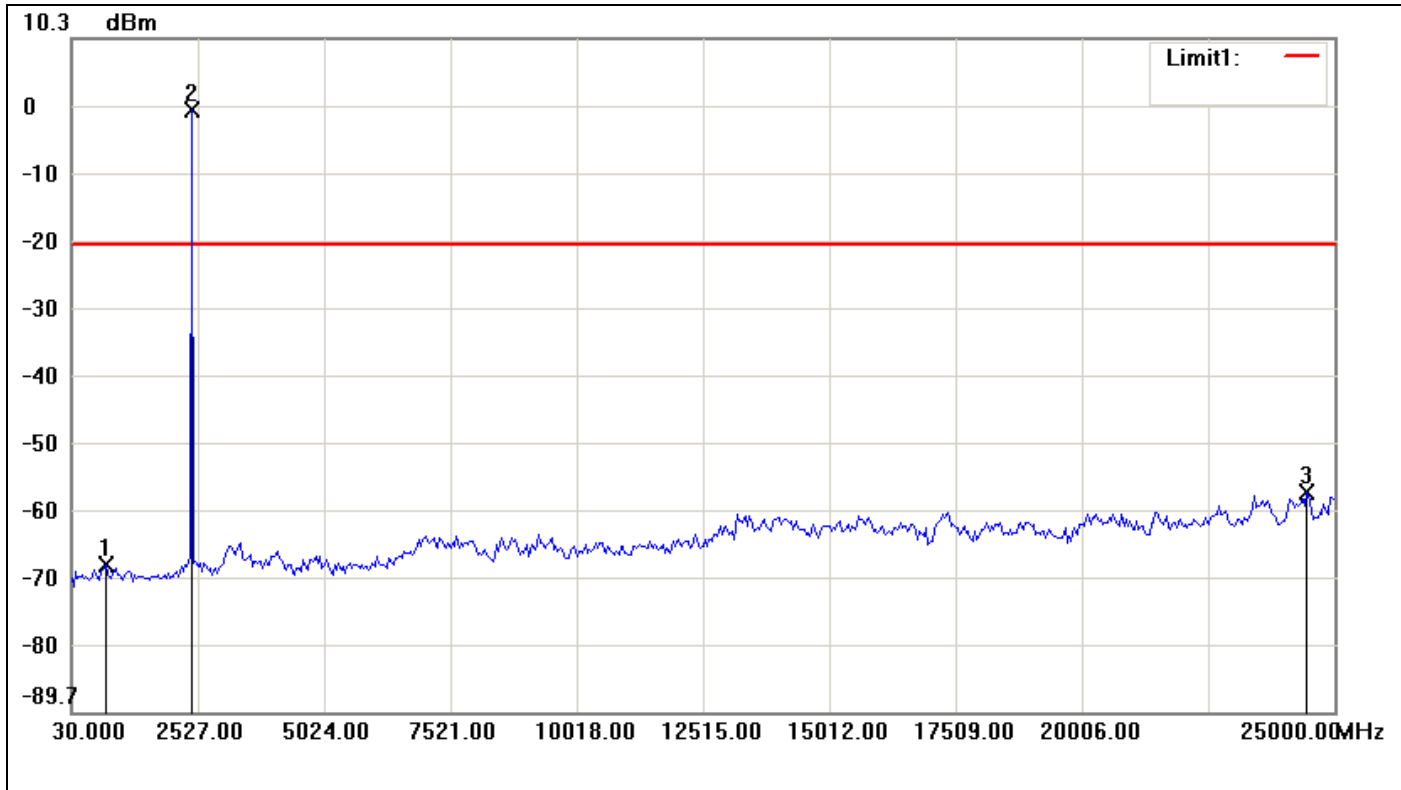

| No. | Frequency(MHz) | Level(dBm) | Limit(dBm) | Margin(dBm) |
|-----|----------------|------------|------------|-------------|
| 1   | 695.8667       | -67.86     | -20.25     | -47.61      |
| 2   | 2402.1500      | -0.25      | -20.25     | 20.00       |
| 3   | 24458.9833     | -57.01     | -20.25     | -36.76      |



### CH Mid

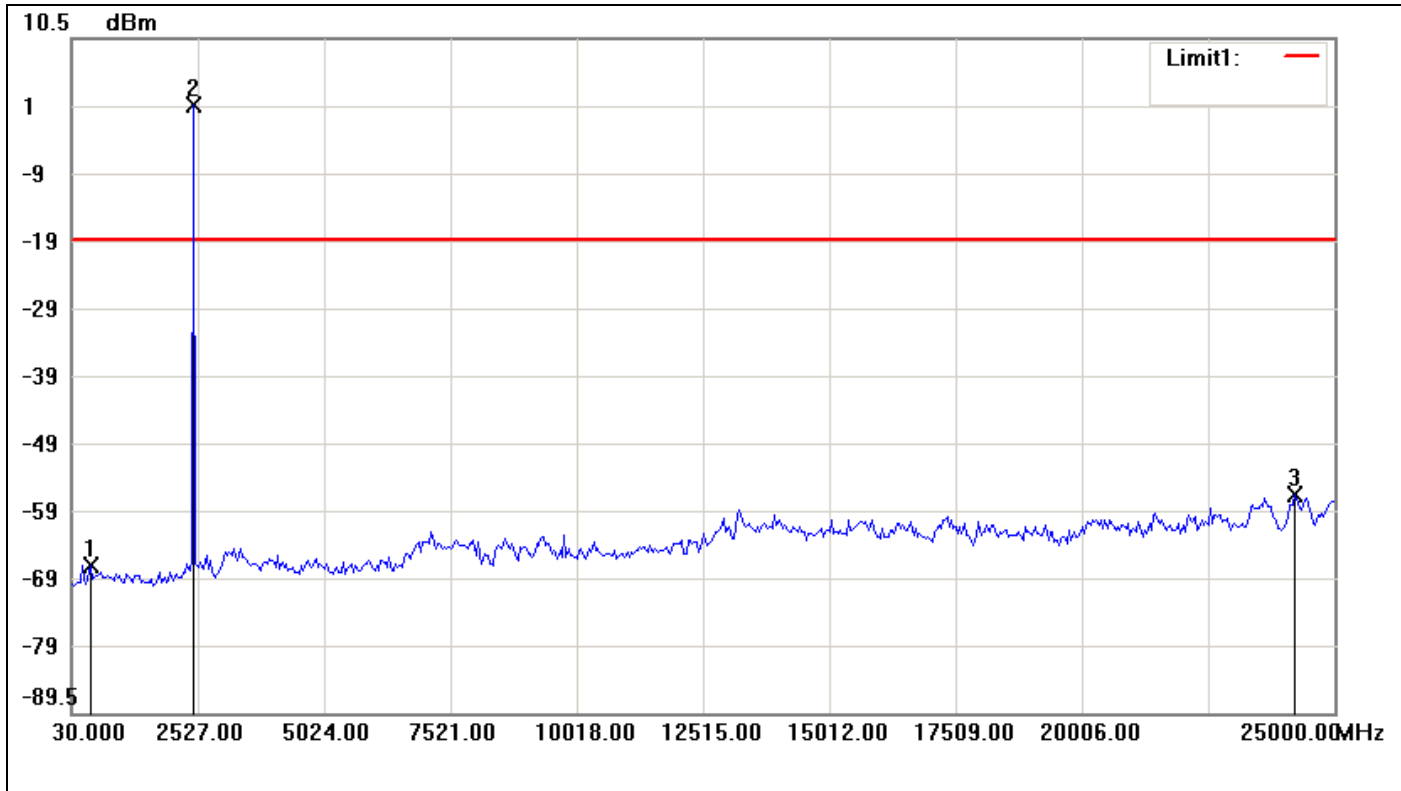

| No. | Frequency(MHz) | Level(dBm) | Limit(dBm) | Margin(dBm) |
|-----|----------------|------------|------------|-------------|
| 1   | 404.5500       | -67.48     | -19.34     | -48.14      |
| 2   | 2443.7667      | 0.66       | -19.34     | 20.00       |
| 3   | 24209.2833     | -56.98     | -19.34     | -37.64      |





### CH High

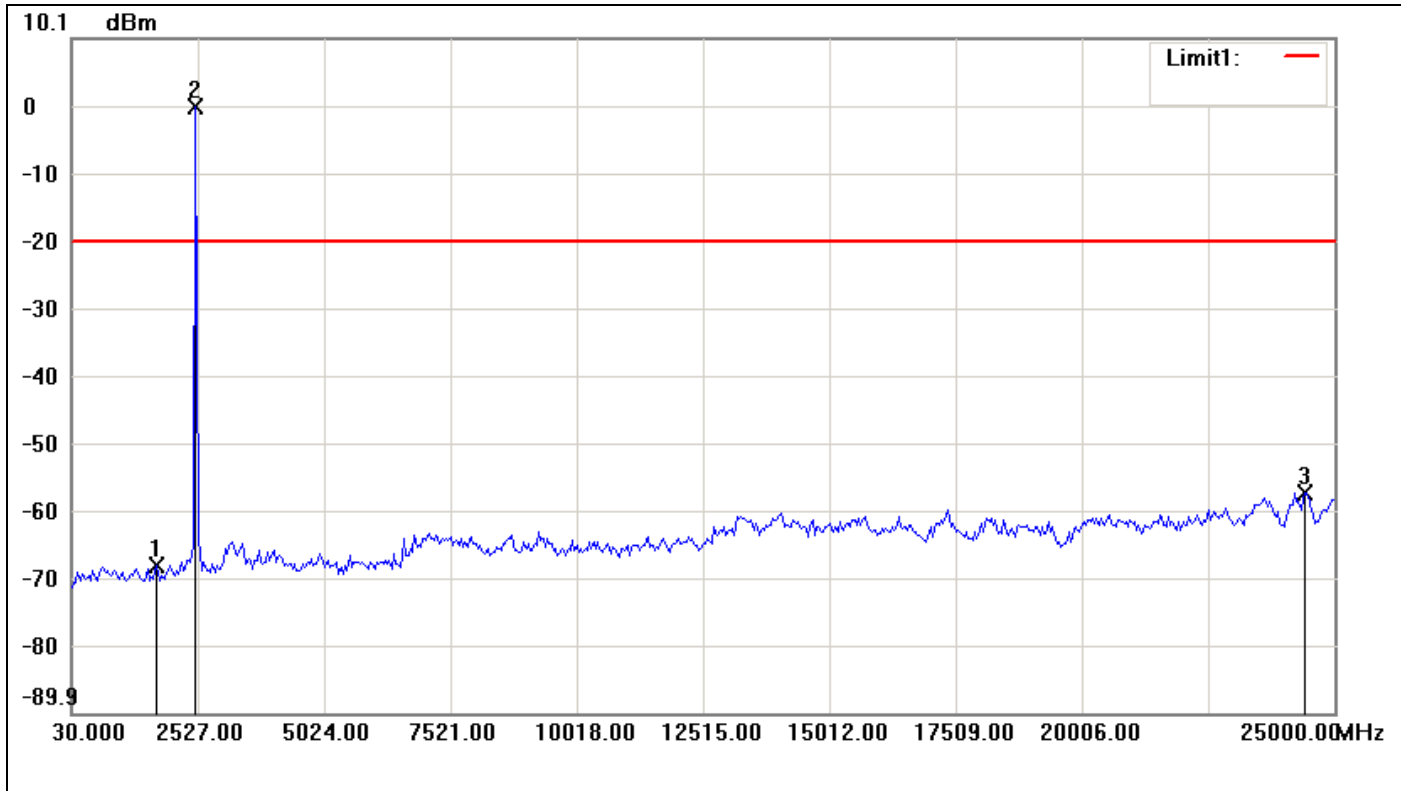

| No. | Frequency(MHz) | Level(dBm) | Limit(dBm) | Margin(dBm) |
|-----|----------------|------------|------------|-------------|
| 1   | 1694.6667      | -67.93     | -19.96     | -47.97      |
| 2   | 2485.3833      | 0.04       | -19.96     | 20.00       |
| 3   | 24417.3667     | -57.19     | -19.96     | -37.23      |



**Test Plot**

**For 8DPSK / DH5**

**CH Low**

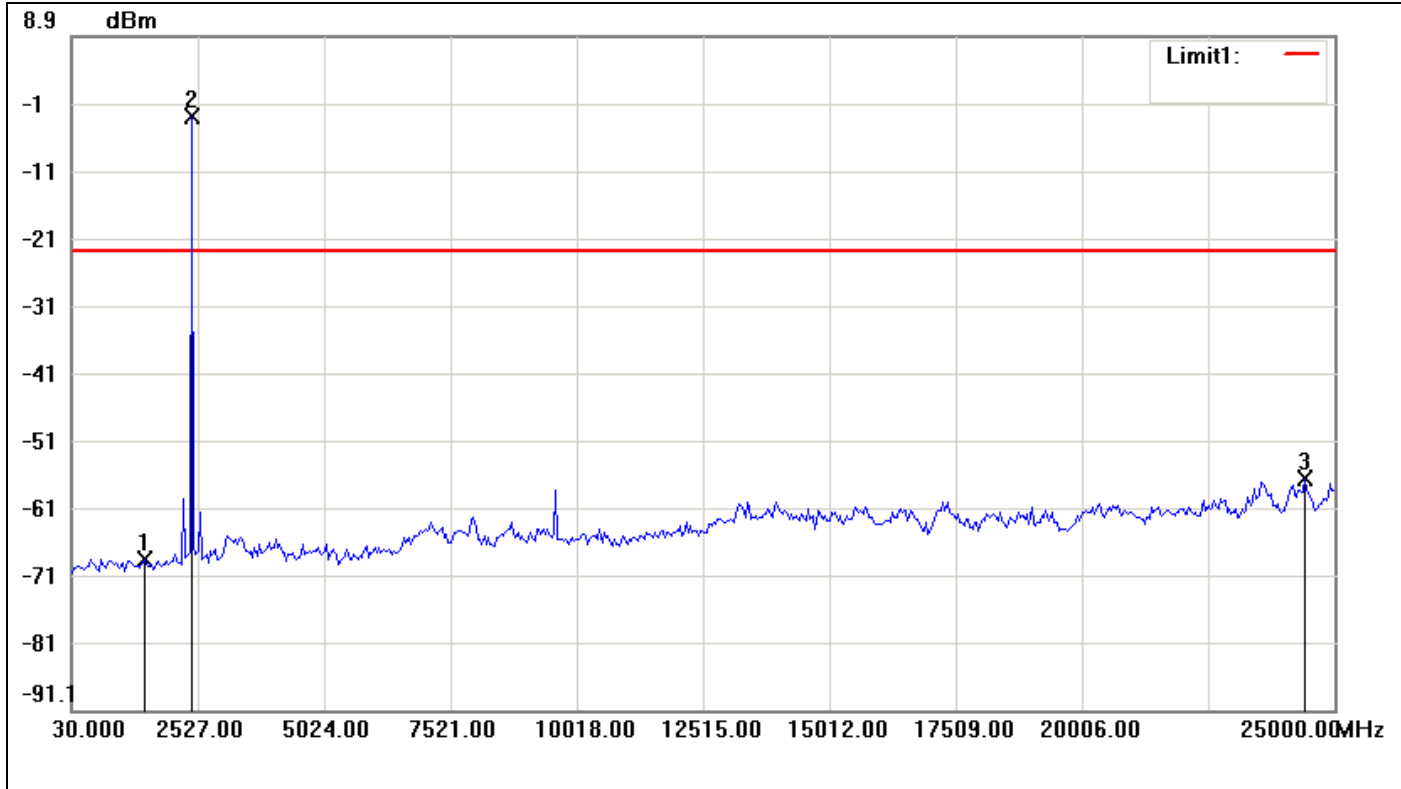

| No. | Frequency(MHz) | Level(dBm) | Limit(dBm) | Margin(dBm) |
|-----|----------------|------------|------------|-------------|
| 1   | 1486.5833      | -68.63     | -23.01     | -45.62      |
| 2   | 2402.1500      | -3.01      | -23.01     | 20.00       |
| 3   | 24417.3667     | -56.64     | -23.01     | -33.63      |



### CH Mid

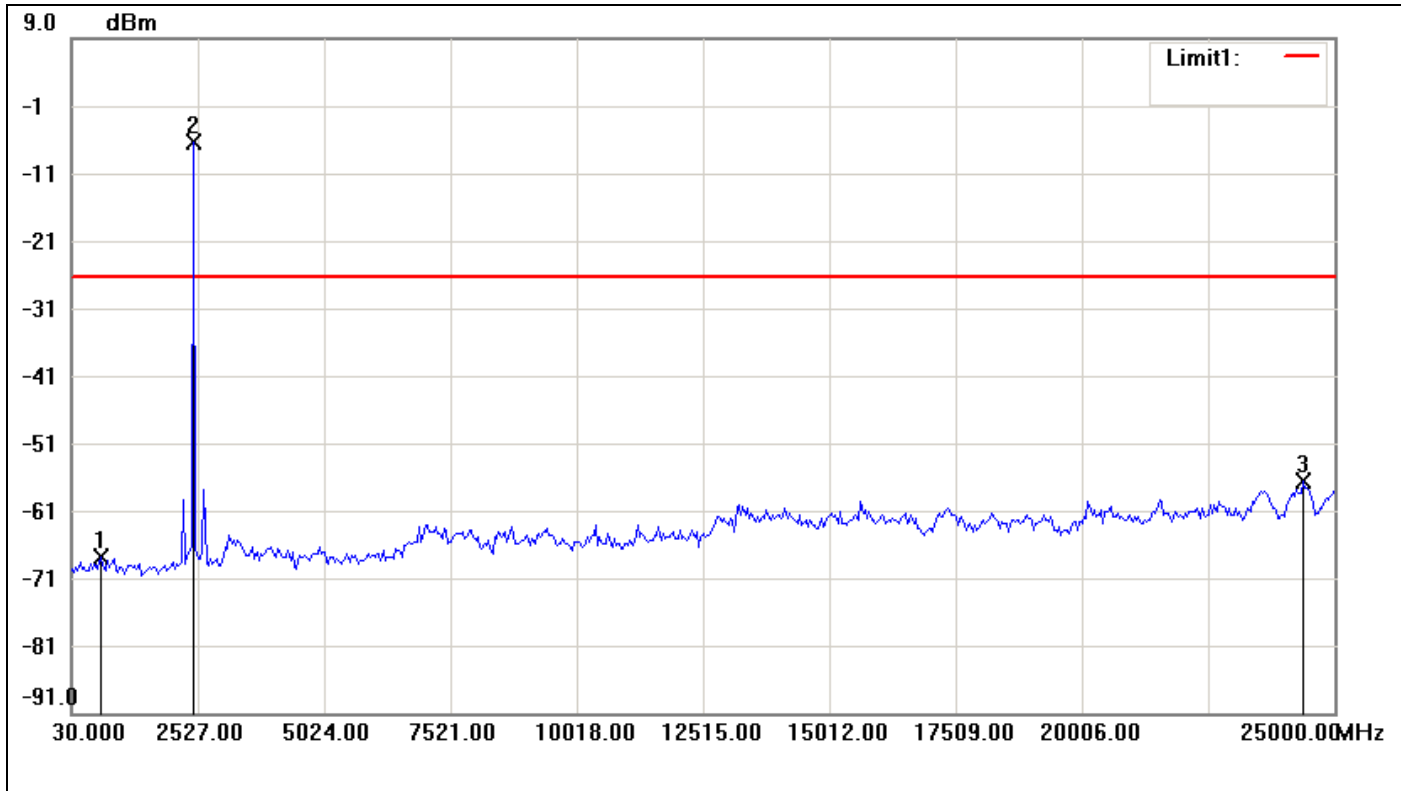

| No. | Frequency(MHz) | Level(dBm) | Limit(dBm) | Margin(dBm) |
|-----|----------------|------------|------------|-------------|
| 1   | 612.6333       | -67.83     | -26.42     | -41.41      |
| 2   | 2443.7667      | -6.42      | -26.42     | 20.00       |
| 3   | 24375.7500     | -56.58     | -26.42     | -30.16      |



### CH High

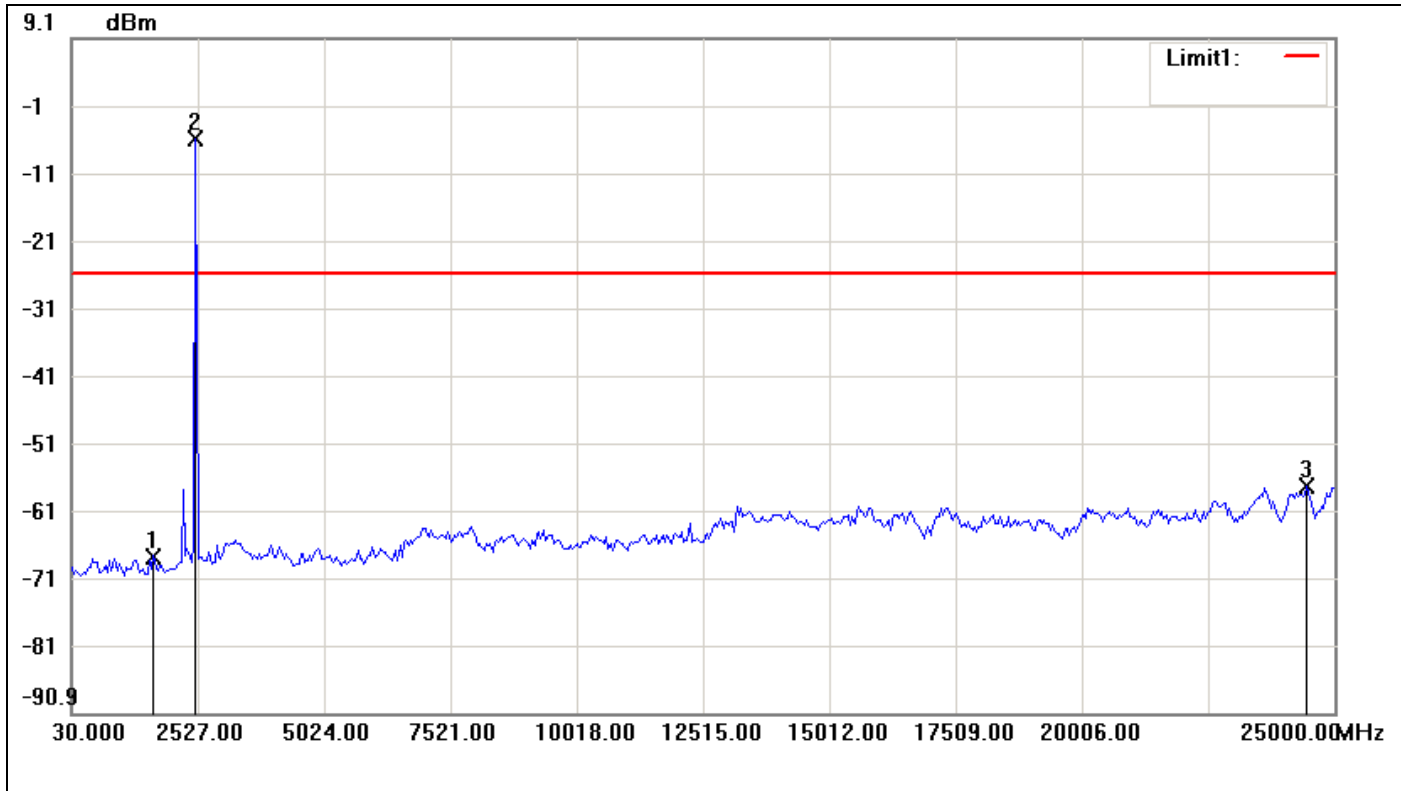

| No. | Frequency(MHz) | Level(dBm) | Limit(dBm) | Margin(dBm) |
|-----|----------------|------------|------------|-------------|
| 1   | 1653.0500      | -67.63     | -25.64     | -41.99      |
| 2   | 2485.3833      | -5.64      | -25.64     | 20.00       |
| 3   | 24458.9833     | -57.17     | -25.64     | -31.53      |



### 8.9.2 Radiated Emissions

#### LIMIT

All spurious emissions shall comply with the limits of §15.209(a) and RSS-Gen Table 2 & Table 5.

#### RSS-Gen Table 2 & Table 5: General Field Strength Limits for Transmitters and Receivers at Frequencies Above 30 MHz <sup>(Note)</sup>

| Frequency (MHz) | Field Strength<br>microvolts/m at 3 metres (watts, e.i.r.p.) |              |
|-----------------|--|--------------|
|                 | Transmitters   | Receivers    |
| 30-88           | 100 (3 nW)   | 100 (3 nW)   |
| 88-216          | 150 (6.8 nW)   | 150 (6.8 nW) |
| 216-960         | 200 (12 nW)  | 200 (12 nW)  |
| Above 960       | 500 (75 nW)  | 500 (75 nW)  |

**Note:** \*Measurements for compliance with limits in the above table may be performed at distances other than 3 metres, in accordance with Section 7.2.7.

Transmitting devices are not permitted in Table 1 bands or, unless stated otherwise, in TV bands (54-72 MHz, 76-88 MHz, 174-216 MHz, 470-608 MHz and 614-806 MHz).

#### RSS-Gen Table 6: General Field Strength Limits for Transmitters at Frequencies Below 30 MHz (Transmit)

| Frequency     | Field Strength (microvolts/m) | Magnetic H-Field (microamperes/m) | Measurement Distance (metres) |
|---------------|-------------------------------|-----------------------------------|-------------------------------|
| 9-490 kHz     | 2,400/F (F in kHz)            | 2,400/377F (F in kHz)             | 3000                          |
| 490-1,705 kHz | 24,000/F (F in kHz)           | 24,000/377F (F in kHz)            | 30                            |
| 1.705-30 MHz  | 30                            | N/A                               | 30                            |

**Note:** The emission limits for the bands 9-90 kHz and 110-490 kHz are based on measurements employing an average detector.



### Test Configuration

#### 9kHz ~ 30MHz

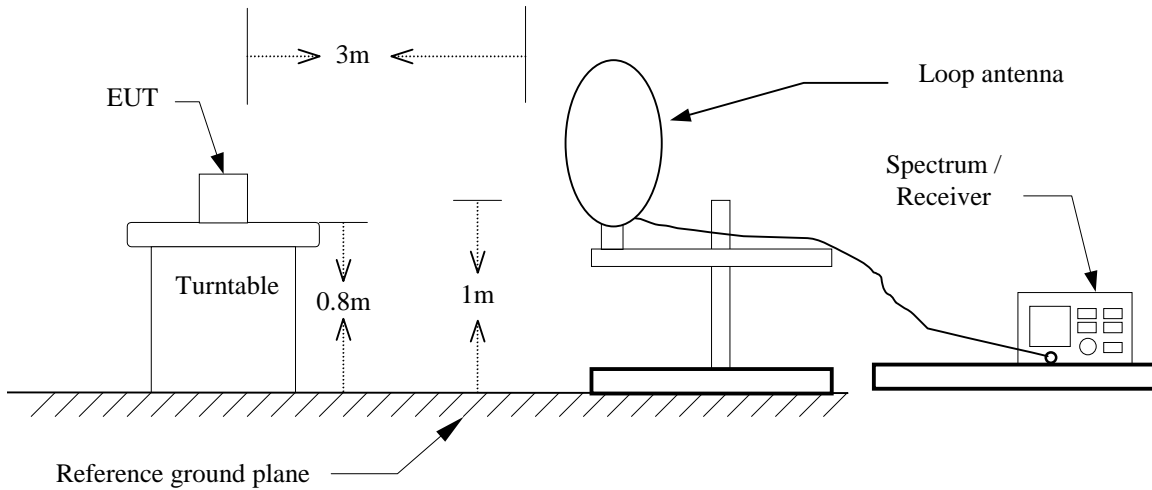

#### 30MHz ~ 1GHz

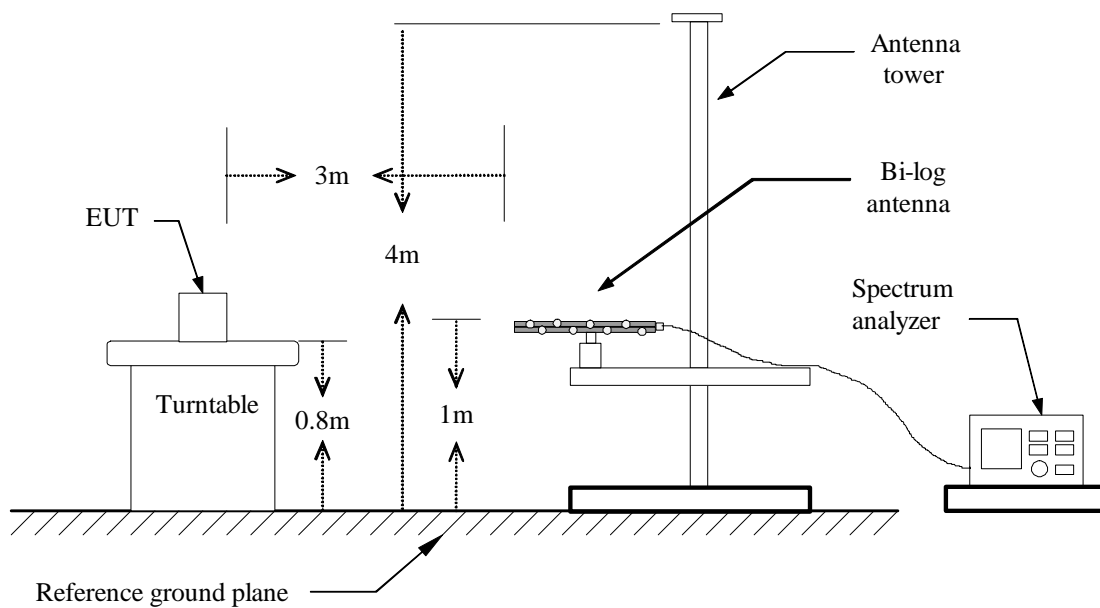



Above 1 GHz

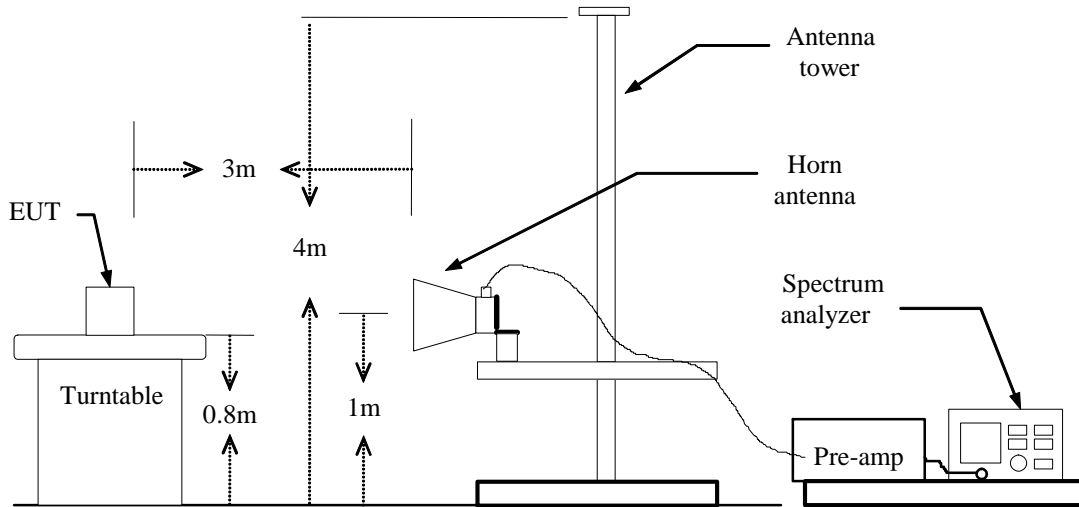



## **TEST PROCEDURE**

1. The EUT is placed on a turntable, which is 0.8m above ground plane.
2. The turntable shall be rotated for 360 degrees to determine the position of maximum emission level.
3. EUT is set 3m away from the receiving antenna, which is varied from 1m to 4m to find out the highest emissions.
4. Maximum procedure was performed on the six highest emissions to ensure EUT compliance.
5. And also, each emission was to be maximized by changing the polarization of receiving antenna both horizontal and vertical.
6. Set the spectrum analyzer in the following setting as:  
Below 1GHz:  
RBW=100kHz / VBW=300kHz / Sweep=AUTO  
Above 1GHz:  
(a) PEAK: RBW=VBW=1MHz / Sweep=AUTO  
(b) AVERAGE: RBW=1MHz / VBW=10Hz / Sweep=AUTO
7. Repeat above procedures until the measurements for all frequencies are complete.



**Below 1 GHz**

**Operation Mode:** Normal Link      **Test Date:** December 17, 2011  
**Temperature:** 24°C      **Tested by:** Ali Shu  
**Humidity:** 50 % RH      **Polarity:** Ver. / Hor.

| Frequency (MHz) | Reading (dBuV) | Correction Factor (dB/m) | Result (dBuV/m) | Limit (dBuV/m) | Margin (dB) | Remark | Ant.Pol. (H/V) |
|-----------------|----------------|--------------------------|-----------------|----------------|-------------|--------|----------------|
| 62.33           | 50.26          | -17.49                   | 32.77           | 40.00          | -7.23       | Peak   | V              |
| 107.60          | 37.21          | -13.42                   | 23.78           | 43.50          | -19.72      | Peak   | V              |
| 152.87          | 39.53          | -12.54                   | 26.99           | 43.50          | -16.51      | Peak   | V              |
| 217.53          | 36.92          | -13.31                   | 23.61           | 46.00          | -22.39      | Peak   | V              |
| 448.72          | 32.22          | -8.61                    | 23.61           | 46.00          | -22.39      | Peak   | V              |
| 663.73          | 28.69          | -5.64                    | 23.05           | 46.00          | -22.95      | Peak   | V              |
| 39.70           | 43.26          | -11.52                   | 31.75           | 40.00          | -8.25       | Peak   | H              |
| 52.63           | 46.03          | -17.40                   | 28.63           | 40.00          | -11.37      | Peak   | H              |
| 93.05           | 42.85          | -16.42                   | 26.44           | 43.50          | -17.06      | Peak   | H              |
| 156.10          | 40.78          | -12.65                   | 28.14           | 43.50          | -15.36      | Peak   | H              |
| 306.45          | 33.12          | -10.73                   | 22.39           | 46.00          | -23.61      | Peak   | H              |
| 684.75          | 28.82          | -5.39                    | 23.44           | 46.00          | -22.56      | Peak   | H              |

**Remark:**

1. No emission found between lowest internal used/generated frequency to 30MHz (9kHz~30MHz)
2. Radiated emissions measured in frequency range from 30 MHz to 1000MHz were made with an instrument using peak/quasi-peak detector mode.
3. Quasi-peak test would be performed if the peak result were greater than the quasi-peak limit or as required by the applicant.
4. Measurements above show only up to 6 maximum emissions noted, or would be lesser, with " N/A " remark, if no specific emissions from the EUT are recorded (ie: margin>20dB from the applicable limit) and considered that's already beyond the background noise floor.
5.  $Margin (dB) = Remark\ result (dBuV/m) - Quasi-peak\ limit (dBuV/m).$



**Above 1 GHz**

**Operation Mode:** TX / GFSK / DH5 / CH Low

**Test Date:** December 17, 2011

**Temperature:** 24°C

**Tested by:** Ali Shu

**Humidity:** 50 % RH

**Polarity:** Ver. / Hor.

| Frequency (MHz) | Reading (Peak) (dBuV) | Reading (Average) (dBuV) | Correction Factor (dB/m) | Result (Peak) (dBuV/m) | Result (Average) (dBuV/m) | Limit (Peak) (dBuV/m) | Limit (Average) (dBuV/m) | Margin (dB) | Remark | Ant.Pol. (H/V) |
|-----------------|-----------------------|--------------------------|--------------------------|------------------------|---------------------------|-----------------------|--------------------------|-------------|--------|----------------|
| 1640.00         | 52.29                 | ---                      | -9.13                    | 43.16                  | ---                       | 74.00                 | 54.00                    | -10.84      | Peak   | V              |
| N/A             |                       |                          |                          |                        |                           |                       |                          |             |        |                |
|                 |                       |                          |                          |                        |                           |                       |                          |             |        |                |
|                 |                       |                          |                          |                        |                           |                       |                          |             |        |                |
|                 |                       |                          |                          |                        |                           |                       |                          |             |        |                |
|                 |                       |                          |                          |                        |                           |                       |                          |             |        |                |
| 1400.00         | 53.55                 | ---                      | -10.65                   | 42.90                  | ---                       | 74.00                 | 54.00                    | -11.10      | Peak   | H              |
| N/A             |                       |                          |                          |                        |                           |                       |                          |             |        |                |
|                 |                       |                          |                          |                        |                           |                       |                          |             |        |                |
|                 |                       |                          |                          |                        |                           |                       |                          |             |        |                |
|                 |                       |                          |                          |                        |                           |                       |                          |             |        |                |
|                 |                       |                          |                          |                        |                           |                       |                          |             |        |                |

**Remark:**

1. Measuring frequencies from 1 GHz to the 10th harmonic of highest fundamental frequency.
2. Radiated emissions measured in frequency above 1000MHz were made with an instrument using peak/average detector mode.
3. Average test would be performed if the peak result were greater than the average limit .
4. Data of measurement within this frequency range shown “ --- ” in the table above means the reading of emissions are attenuated more than 20dB below the permissible limits or the field strength is too small to be measured.
5. Measurements above show only up to 6 maximum emissions noted, or would be lesser, with “ N/A ” remark, if no specific emissions from the EUT are recorded (ie: margin>20dB from the applicable limit) and considered that's already beyond the background noise floor.
6. Margin (dB) = Remark result (dBuV/m) – Average limit (dBuV/m).



Operation Mode: TX / GFSK / DH5 / CH Mid

Test Date: December 17, 2011

Temperature: 24°C

Tested by: Ali Shu

Humidity: 50 % RH

Polarity: Ver. / Hor.

| Frequency (MHz) | Reading (Peak) (dBuV) | Reading (Average) (dBuV) | Correction Factor (dB/m) | Result (Peak) (dBuV/m) | Result (Average) (dBuV/m) | Limit (Peak) (dBuV/m) | Limit (Average) (dBuV/m) | Margin (dB) | Remark | Ant.Pol. (H/V) |
|-----------------|-----------------------|--------------------------|--------------------------|------------------------|---------------------------|-----------------------|--------------------------|-------------|--------|----------------|
| 1526.67         | 52.80                 | ---                      | -10.28                   | 42.53                  | ---                       | 74.00                 | 54.00                    | -11.47      | Peak   | V              |
| N/A             |                       |                          |                          |                        |                           |                       |                          |             |        |                |
|                 |                       |                          |                          |                        |                           |                       |                          |             |        |                |
|                 |                       |                          |                          |                        |                           |                       |                          |             |        |                |
|                 |                       |                          |                          |                        |                           |                       |                          |             |        |                |
|                 |                       |                          |                          |                        |                           |                       |                          |             |        |                |
| 1636.67         | 52.33                 | ---                      | -9.16                    | 43.17                  | ---                       | 74.00                 | 54.00                    | -10.83      | Peak   | H              |
| N/A             |                       |                          |                          |                        |                           |                       |                          |             |        |                |
|                 |                       |                          |                          |                        |                           |                       |                          |             |        |                |
|                 |                       |                          |                          |                        |                           |                       |                          |             |        |                |
|                 |                       |                          |                          |                        |                           |                       |                          |             |        |                |
|                 |                       |                          |                          |                        |                           |                       |                          |             |        |                |

Remark:

1. Measuring frequencies from 1 GHz to the 10th harmonic of highest fundamental frequency.
2. Radiated emissions measured in frequency above 1000MHz were made with an instrument using peak/average detector mode.
3. Average test would be performed if the peak result were greater than the average limit.
4. Data of measurement within this frequency range shown “ --- ” in the table above means the reading of emissions are attenuated more than 20dB below the permissible limits or the field strength is too small to be measured.
5. Measurements above show only up to 6 maximum emissions noted, or would be lesser, with “ N/A ” remark, if no specific emissions from the EUT are recorded (ie: margin>20dB from the applicable limit) and considered that's already beyond the background noise floor.
6. Margin (dB) = Remark result (dBuV/m) – Average limit (dBuV/m).



Operation Mode: TX / GFSK / DH5 / CH High

Test Date: December 17, 2011

Temperature: 24°C

Tested by: Ali Shu

Humidity: 50 % RH

Polarity: Ver. / Hor.

| Frequency (MHz) | Reading (Peak) (dBuV) | Reading (Average) (dBuV) | Correction Factor (dB/m) | Result (Peak) (dBuV/m) | Result (Average) (dBuV/m) | Limit (Peak) (dBuV/m) | Limit (Average) (dBuV/m) | Margin (dB) | Remark | Ant.Pol. (H/V) |
|-----------------|-----------------------|--------------------------|--------------------------|------------------------|---------------------------|-----------------------|--------------------------|-------------|--------|----------------|
| 1653.33         | 52.95                 | ---                      | -8.99                    | 43.96                  | ---                       | 74.00                 | 54.00                    | -10.04      | Peak   | V              |
| N/A             |                       |                          |                          |                        |                           |                       |                          |             |        |                |
|                 |                       |                          |                          |                        |                           |                       |                          |             |        |                |
|                 |                       |                          |                          |                        |                           |                       |                          |             |        |                |
|                 |                       |                          |                          |                        |                           |                       |                          |             |        |                |
| 1636.67         | 51.14                 | ---                      | -9.16                    | 41.98                  | ---                       | 74.00                 | 54.00                    | -12.02      | Peak   | H              |
| 4741.67         | 48.09                 | ---                      | 2.44                     | 50.53                  | ---                       | 74.00                 | 54.00                    | -3.47       | Peak   | H              |
| N/A             |                       |                          |                          |                        |                           |                       |                          |             |        |                |
|                 |                       |                          |                          |                        |                           |                       |                          |             |        |                |
|                 |                       |                          |                          |                        |                           |                       |                          |             |        |                |
|                 |                       |                          |                          |                        |                           |                       |                          |             |        |                |

**Remark:**

1. Measuring frequencies from 1 GHz to the 10th harmonic of highest fundamental frequency.
2. Radiated emissions measured in frequency above 1000MHz were made with an instrument using peak/average detector mode.
3. Average test would be performed if the peak result were greater than the average limit.
4. Data of measurement within this frequency range shown “ --- ” in the table above means the reading of emissions are attenuated more than 20dB below the permissible limits or the field strength is too small to be measured.
5. Measurements above show only up to 6 maximum emissions noted, or would be lesser, with “ N/A ” remark, if no specific emissions from the EUT are recorded (ie: margin>20dB from the applicable limit) and considered that's already beyond the background noise floor.
6. Margin (dB) = Remark result (dBuV/m) – Average limit (dBuV/m).



Operation Mode: TX / 8DPSK / DH5 / CH Low

Test Date: December 17, 2011

Temperature: 24°C

Tested by: Ali Shu

Humidity: 50 % RH

Polarity: Ver. / Hor.

| Frequency (MHz) | Reading (Peak) (dBuV) | Reading (Average) (dBuV) | Correction Factor (dB/m) | Result (Peak) (dBuV/m) | Result (Average) (dBuV/m) | Limit (Peak) (dBuV/m) | Limit (Average) (dBuV/m) | Margin (dB) | Remark | Ant.Pol. (H/V) |
|-----------------|-----------------------|--------------------------|--------------------------|------------------------|---------------------------|-----------------------|--------------------------|-------------|--------|----------------|
| 1623.33         | 52.73                 | ---                      | -9.30                    | 43.43                  | ---                       | 74.00                 | 54.00                    | -10.57      | Peak   | V              |
| N/A             |                       |                          |                          |                        |                           |                       |                          |             |        |                |
|                 |                       |                          |                          |                        |                           |                       |                          |             |        |                |
|                 |                       |                          |                          |                        |                           |                       |                          |             |        |                |
|                 |                       |                          |                          |                        |                           |                       |                          |             |        |                |
|                 |                       |                          |                          |                        |                           |                       |                          |             |        |                |
| 1386.67         | 52.98                 | ---                      | -10.67                   | 42.31                  | ---                       | 74.00                 | 54.00                    | -11.69      | Peak   | H              |
| N/A             |                       |                          |                          |                        |                           |                       |                          |             |        |                |
|                 |                       |                          |                          |                        |                           |                       |                          |             |        |                |
|                 |                       |                          |                          |                        |                           |                       |                          |             |        |                |
|                 |                       |                          |                          |                        |                           |                       |                          |             |        |                |
|                 |                       |                          |                          |                        |                           |                       |                          |             |        |                |

Remark:

1. Measuring frequencies from 1 GHz to the 10th harmonic of highest fundamental frequency.
2. Radiated emissions measured in frequency above 1000MHz were made with an instrument using peak/average detector mode.
3. Average test would be performed if the peak result were greater than the average limit.
4. Data of measurement within this frequency range shown “ --- ” in the table above means the reading of emissions are attenuated more than 20dB below the permissible limits or the field strength is too small to be measured.
5. Measurements above show only up to 6 maximum emissions noted, or would be lesser, with “ N/A ” remark, if no specific emissions from the EUT are recorded (ie: margin>20dB from the applicable limit) and considered that's already beyond the background noise floor.
6. Margin (dB) = Remark result (dBuV/m) – Average limit (dBuV/m).



Operation Mode: TX / 8DPSK / DH5 / CH Mid

Test Date: December 17, 2011

Temperature: 24°C

Tested by: Ali Shu

Humidity: 50 % RH

Polarity: Ver. / Hor.

| Frequency (MHz) | Reading (Peak) (dBuV) | Reading (Average) (dBuV) | Correction Factor (dB/m) | Result (Peak) (dBuV/m) | Result (Average) (dBuV/m) | Limit (Peak) (dBuV/m) | Limit (Average) (dBuV/m) | Margin (dB) | Remark | Ant.Pol. (H/V) |
|-----------------|-----------------------|--------------------------|--------------------------|------------------------|---------------------------|-----------------------|--------------------------|-------------|--------|----------------|
| 1640.00         | 52.18                 | ---                      | -9.13                    | 43.05                  | ---                       | 74.00                 | 54.00                    | -10.95      | Peak   | V              |
| 4383.33         | 47.72                 | ---                      | 1.61                     | 49.34                  | ---                       | 74.00                 | 54.00                    | -4.66       | Peak   | V              |
| N/A             |                       |                          |                          |                        |                           |                       |                          |             |        |                |
|                 |                       |                          |                          |                        |                           |                       |                          |             |        |                |
|                 |                       |                          |                          |                        |                           |                       |                          |             |        |                |
|                 |                       |                          |                          |                        |                           |                       |                          |             |        |                |
| 1393.33         | 54.19                 | ---                      | -10.66                   | 43.53                  | ---                       | 74.00                 | 54.00                    | -10.47      | Peak   | H              |
| 4908.33         | 47.74                 | ---                      | 2.78                     | 50.52                  | ---                       | 74.00                 | 54.00                    | -3.48       | Peak   | H              |
| N/A             |                       |                          |                          |                        |                           |                       |                          |             |        |                |
|                 |                       |                          |                          |                        |                           |                       |                          |             |        |                |
|                 |                       |                          |                          |                        |                           |                       |                          |             |        |                |
|                 |                       |                          |                          |                        |                           |                       |                          |             |        |                |

Remark:

1. Measuring frequencies from 1 GHz to the 10th harmonic of highest fundamental frequency.
2. Radiated emissions measured in frequency above 1000MHz were made with an instrument using peak/average detector mode.
3. Average test would be performed if the peak result were greater than the average limit.
4. Data of measurement within this frequency range shown “ --- ” in the table above means the reading of emissions are attenuated more than 20dB below the permissible limits or the field strength is too small to be measured.
5. Measurements above show only up to 6 maximum emissions noted, or would be lesser, with “ N/A ” remark, if no specific emissions from the EUT are recorded (ie: margin>20dB from the applicable limit) and considered that's already beyond the background noise floor.
6. Margin (dB) = Remark result (dBuV/m) – Average limit (dBuV/m).



Operation Mode: TX / 8DPSK / DH5 / CH High

Test Date: December 17, 2011

Temperature: 24°C

Tested by: Ali Shu

Humidity: 50 % RH

Polarity: Ver. / Hor.

| Frequency (MHz) | Reading (Peak) (dBuV) | Reading (Average) (dBuV) | Correction Factor (dB/m) | Result (Peak) (dBuV/m) | Result (Average) (dBuV/m) | Limit (Peak) (dBuV/m) | Limit (Average) (dBuV/m) | Margin (dB) | Remark | Ant. Pol. (H/V) |
|-----------------|-----------------------|--------------------------|--------------------------|------------------------|---------------------------|-----------------------|--------------------------|-------------|--------|-----------------|
| 1480.00         | 52.94                 | ---                      | -10.57                   | 42.37                  | ---                       | 74.00                 | 54.00                    | -11.63      | Peak   | V               |
| 5466.67         | 48.27                 | ---                      | 2.94                     | 51.21                  | ---                       | 74.00                 | 54.00                    | -2.79       | Peak   | V               |
| N/A             |                       |                          |                          |                        |                           |                       |                          |             |        |                 |
|                 |                       |                          |                          |                        |                           |                       |                          |             |        |                 |
|                 |                       |                          |                          |                        |                           |                       |                          |             |        |                 |
|                 |                       |                          |                          |                        |                           |                       |                          |             |        |                 |
| 1550.00         | 52.93                 | ---                      | -10.04                   | 42.89                  | ---                       | 74.00                 | 54.00                    | -11.11      | Peak   | H               |
| N/A             |                       |                          |                          |                        |                           |                       |                          |             |        |                 |
|                 |                       |                          |                          |                        |                           |                       |                          |             |        |                 |
|                 |                       |                          |                          |                        |                           |                       |                          |             |        |                 |
|                 |                       |                          |                          |                        |                           |                       |                          |             |        |                 |
|                 |                       |                          |                          |                        |                           |                       |                          |             |        |                 |

Remark:

1. Measuring frequencies from 1 GHz to the 10th harmonic of highest fundamental frequency.
2. Radiated emissions measured in frequency above 1000MHz were made with an instrument using peak/average detector mode.
3. Average test would be performed if the peak result were greater than the average limit.
4. Data of measurement within this frequency range shown “ --- ” in the table above means the reading of emissions are attenuated more than 20dB below the permissible limits or the field strength is too small to be measured.
5. Measurements above show only up to 6 maximum emissions noted, or would be lesser, with “ N/A ” remark, if no specific emissions from the EUT are recorded (ie: margin>20dB from the applicable limit) and considered that's already beyond the background noise floor.
6. Margin (dB) = Remark result (dBuV/m) – Average limit (dBuV/m).



Operation Mode: RX / Bluetooth / CH Mid

Test Date: December 17, 2011

Temperature: 24°C

Tested by: Ali Shu

Humidity: 50 % RH

Polarity: Ver. / Hor.

| Frequency (MHz) | Reading (Peak) (dBuV) | Reading (Average) (dBuV) | Correction Factor (dB/m) | Result (Peak) (dBuV/m) | Result (Average) (dBuV/m) | Limit (Peak) (dBuV/m) | Limit (Average) (dBuV/m) | Margin (dB) | Remark | Ant.Pol. (H/V) |
|-----------------|-----------------------|--------------------------|--------------------------|------------------------|---------------------------|-----------------------|--------------------------|-------------|--------|----------------|
| 1986.67         | 48.94                 | ---                      | -5.61                    | 43.33                  | ---                       | 74.00                 | 54.00                    | -10.67      | Peak   | V              |
| 2550.00         | 48.58                 | ---                      | -3.70                    | 44.88                  | ---                       | 74.00                 | 54.00                    | -9.12       | Peak   | V              |
| 4116.67         | 47.89                 | ---                      | 0.83                     | 48.71                  | ---                       | 74.00                 | 54.00                    | -5.29       | Peak   | V              |
| 5150.00         | 47.72                 | ---                      | 2.95                     | 50.68                  | ---                       | 74.00                 | 54.00                    | -3.32       | Peak   | V              |
| N/A             |                       |                          |                          |                        |                           |                       |                          |             |        |                |
|                 |                       |                          |                          |                        |                           |                       |                          |             |        |                |
| 1583.33         | 50.56                 | ---                      | -9.70                    | 40.86                  | ---                       | 74.00                 | 54.00                    | -13.14      | Peak   | H              |
| 2853.33         | 48.76                 | ---                      | -2.67                    | 46.09                  | ---                       | 74.00                 | 54.00                    | -7.91       | Peak   | H              |
| 4250.00         | 47.52                 | ---                      | 1.22                     | 48.74                  | ---                       | 74.00                 | 54.00                    | -5.26       | Peak   | H              |
| N/A             |                       |                          |                          |                        |                           |                       |                          |             |        |                |
|                 |                       |                          |                          |                        |                           |                       |                          |             |        |                |
|                 |                       |                          |                          |                        |                           |                       |                          |             |        |                |

Remark:

1. Measuring frequencies from 1 GHz to the 10th harmonic of highest fundamental frequency.
2. Radiated emissions measured in frequency above 1000MHz were made with an instrument using peak/average detector mode.
3. Average test would be performed if the peak result were greater than the average limit or as required by the applicant.
4. Data of measurement within this frequency range shown “ --- ” in the table above means the reading of emissions are attenuated more than 20dB below the permissible limits or the field strength is too small to be measured.
5. Measurements above show only up to 6 maximum emissions noted, or would be lesser, with “ N/A ” remark, if no specific emissions from the EUT are recorded (ie: margin>20dB from the applicable limit) and considered that's already beyond the background noise floor.
6. Margin (dB) = Remark result (dBuV/m) – Average limit (dBuV/m).





## 8.10 POWERLINE CONDUCTED EMISSIONS

### LIMIT

According to §15.207(a) & RSS-Gen §7.2.4, except as shown in paragraphs (b) and (c) of this section, for an intentional radiator that is designed to be connected to the public utility (AC) power line, the radio frequency voltage that is conducted back onto the AC power line on any frequency or frequencies within the band 150 kHz to 30 MHz shall not exceed the limits in the following table, as measured using a 50  $\mu$ H/50 ohms line impedance stabilization network (LISN). Compliance with the provisions of this paragraph shall be based on the measurement of the radio frequency voltage between each power line and ground at the power terminal. The lower limit applies at the boundary between the frequency ranges.

| Frequency Range (MHz) | Limits (dB $\mu$ V) |           |
|-----------------------|---------------------|-----------|
|                       | Quasi-peak          | Average   |
| 0.15 to 0.50          | 66 to 56*           | 56 to 46* |
| 0.50 to 5             | 56                  | 46        |
| 5 to 30               | 60                  | 50        |

\* Decreases with the logarithm of the frequency.

### Test Configuration

See test photographs attached in Appendix II for the actual connections between EUT and support equipment.

### TEST PROCEDURE

1. The EUT was placed on a table, which is 0.8m above ground plane.
2. Maximum procedure was performed on the six highest emissions to ensure EUT compliance.
3. Repeat above procedures until all frequency measured were complete.



### TEST RESULTS

The initial step in collecting conducted data is a spectrum analyzer peak scan of the measurement range. Significant peaks are then marked as shown on the following data page, and these signals are then quasi-peaked.

#### Test Data

**Operation Mode:** Normal Link                      **Test Date:** January 9, 2012  
**Temperature:** 26°C                                      **Tested by:** Chester Tsai  
**Humidity:** 60% RH

| Freq. (MHz) | QP Reading (dBuV) | AV Reading (dBuV) | Corr. factor (dB) | QP Result (dBuV) | AV Result (dBuV) | QP Limit (dBuV) | AV Limit (dBuV) | QP Margin (dB) | AV Margin (dB) | Note |
|-------------|-------------------|-------------------|-------------------|------------------|------------------|-----------------|-----------------|----------------|----------------|------|
| 0.1537      | 46.97             | 33.60             | 0.09              | 47.06            | 33.69            | 65.80           | 55.80           | -18.74         | -22.11         | L1   |
| 0.2714      | 28.39             | 13.19             | 0.09              | 28.48            | 13.28            | 61.07           | 51.07           | -32.59         | -37.79         | L1   |
| 0.8745      | 32.90             | 21.90             | 0.11              | 33.01            | 22.01            | 56.00           | 46.00           | -22.99         | -23.99         | L1   |
| 3.1750      | 25.24             | 17.83             | 0.18              | 25.42            | 18.01            | 56.00           | 46.00           | -30.58         | -27.99         | L1   |
| 16.7071     | 44.25             | 36.64             | 0.71              | 44.96            | 37.35            | 60.00           | 50.00           | -15.04         | -12.65         | L1   |
| 25.0599     | 42.82             | 35.55             | 0.95              | 43.77            | 36.50            | 60.00           | 50.00           | -16.23         | -13.50         | L1   |
| 0.1517      | 51.47             | 51.47             | 0.09              | 51.56            | 51.56            | 65.91           | 55.91           | -14.35         | -4.35          | L2   |
| 0.3915      | 34.04             | 34.04             | 0.09              | 34.13            | 34.13            | 58.03           | 48.03           | -23.90         | -13.90         | L2   |
| 1.1183      | 29.40             | 21.04             | 0.10              | 29.50            | 21.14            | 56.00           | 46.00           | -26.50         | -24.86         | L2   |
| 4.3453      | 26.27             | 16.61             | 0.18              | 26.45            | 16.79            | 56.00           | 46.00           | -29.55         | -29.21         | L2   |
| 16.7080     | 43.62             | 36.23             | 0.51              | 44.13            | 36.74            | 60.00           | 50.00           | -15.87         | -13.26         | L2   |
| 25.0588     | 42.91             | 35.62             | 0.66              | 43.57            | 36.28            | 60.00           | 50.00           | -16.43         | -13.72         | L2   |

#### **Remark:**

1. Measuring frequencies from 0.15 MHz to 30MHz.
2. The emissions measured in frequency range from 0.15 MHz to 30MHz were made with an instrument using Quasi-peak detector and average detector.
3. The IF bandwidth of SPA between 0.15MHz and 30MHz was 10kHz; the IF bandwidth of Test Receiver between 0.15MHz and 30MHz was 9kHz;
4. L1 = Line One (Live Line) / L2 = Line Two (Neutral Line)



### Test Plots

#### Conducted emissions (Line 1)

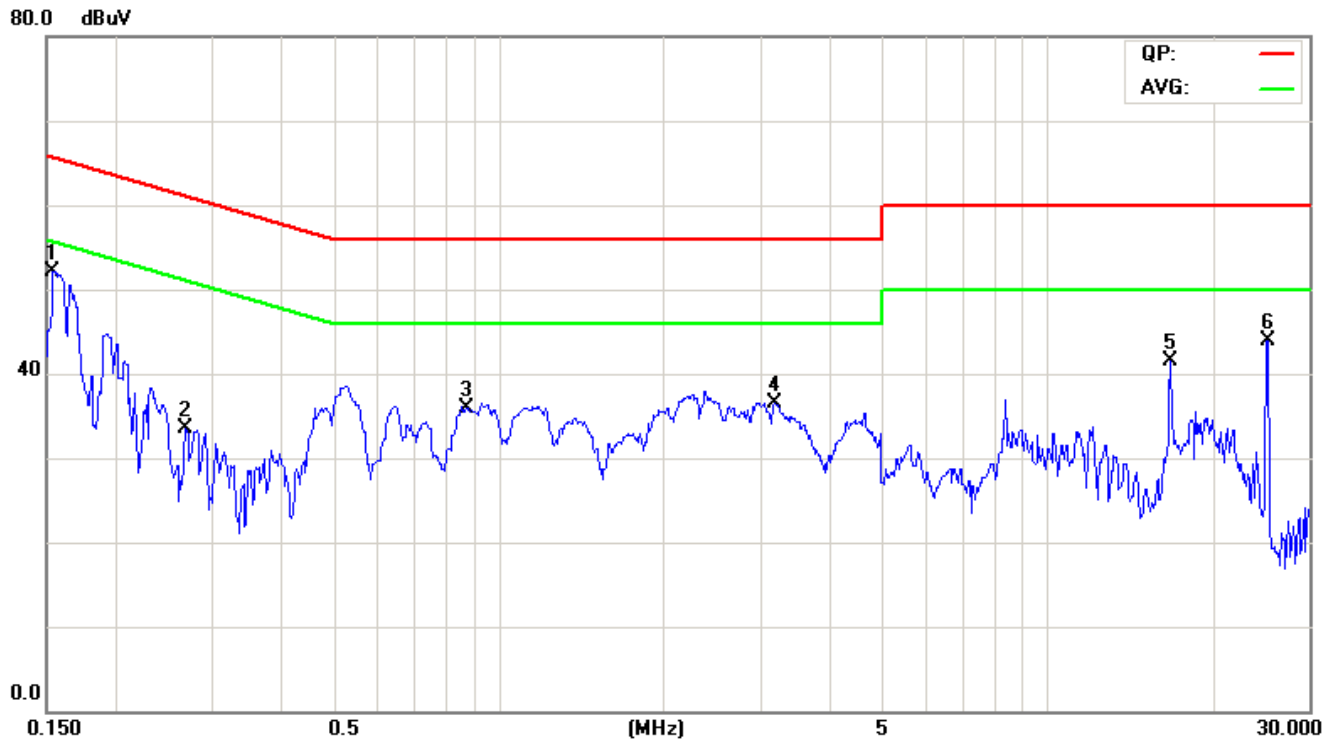

#### Conducted emissions (Line 2)

