

FCC Test Report

EQUIPMENT : PDA
BRAND NAME : Trimble
MODEL NAME : Juno SC
FCC ID : JUP66400
STANDARD : 47 CFR Part 2, 22(H), 24(E)
CLASSIFICATION : PCS Licensed Transmitter (PCB)
Tx/Rx FREQUENCY RANGE : GSM850 : 824.2 ~ 848.8 / 869.2 ~ 893.8 MHz
GSM1900 : 1850.2 ~1909.8 / 1930.2 ~ 1989.8 MHz
WCDMA Band V : 826.4 ~ 846.6 / 871.4 ~ 891.6 MHz
WCDMA Band II : 1852.4 ~1907.6 / 1932.4 ~ 1987.6 MHz
MAX. ERP/EIRP POWER : GSM850 (GPRS) : 0.78 W
GSM850 (EDGE) : 0.33 W
GSM1900 (GPRS) : 1.93 W
GSM1900 (EDGE) : 1.53 W
WCDMA Band V (HSDPA) : 0.10 W
WCDMA Band II (HSDPA) : 0.59 W
EMISSION DESIGNATOR : GSM : 300KGXW
EDGE : 300KG7W
WCDMA : 4M22F9W
APPLICANT : Trimble Navigation Ltd.
935 STEWART DRIVE, SUNNYVALE CA 94088-3642, U.S.A.

The product sample received on Oct. 04, 2008 and completely tested on Oct. 24, 2008. We, SPORTON INTERNATIONAL INC., would like to declare that the tested sample has been evaluated in accordance with the procedures given in ANSI C63.4-2003 and shown compliance with the applicable technical standards.

The test results in this report apply exclusively to the tested model / sample. Without written approval of SPORTON INTERNATIONAL INC., the test report shall not be reproduced except in full.



Reviewed by: Roy Wu / Manager



SPORTON INTERNATIONAL INC.

No. 52, Hwa Ya 1st Rd., Hwa Ya Technology Park, Kwei-Shan Hsiang, Tao Yuan Hsien, Taiwan, R.O.C.



TABLE OF CONTENTS

SUMMARY OF TEST RESULT 3

REVISION HISTORY..... 4

1 GENERAL DESCRIPTION 5

 1.1 Applicant..... 5

 1.2 Manufacturer 5

 1.3 Feature of Equipment Under Test..... 5

 1.4 Testing Site..... 6

 1.5 Applied Standards 7

 1.6 Ancillary Equipment List 7

2 TEST CONFIGURATION OF EQUIPMENT UNDER TEST 8

 2.1 Test Mode..... 8

 2.2 Connection Diagram of Test System 8

3 TEST RESULT 9

 3.1 Conducted Output Power Measurement..... 9

 3.2 Effective Radiated Power and Effective Isotropic Radiated Power Measurement 11

 3.3 Occupied Bandwidth and Band Edge Measurement 16

 3.4 Conducted Emission Measurement 29

 3.5 Field Strength of Spurious Radiation Measurement 45

 3.6 Frequency Stability Measurement..... 58

4 LIST OF MEASURING EQUIPMENTS..... 62

5 UNCERTAINTY OF EVALUATION 63

6 CERTIFICATION OF TAF ACCREDITATION 65

APPENDIX A. PHOTOGRAPHS OF EUT

APPENDIX B. SETUP PHOTOGRAPHS



SUMMARY OF TEST RESULT

Report Section	FCC Rule	IC Rule	Description	Limit	Result
3.1	§2.1046	N/A	Conducted Output Power	N/A	PASS
3.2	§22.913(a)(2)	RSS-132(4.4) SRSP-503(5.1.3)	Effective Radiated Power	< 7 Watts for FCC (<6.3 Watts for IC)	PASS
3.2	§24.232(c)	RSS-133 (6.4) SRSP-510(5.1.2)	Equivalent Isotropic Radiated Power	< 2 Watts	PASS
3.3	§2.1049 §22.917(a) §24.238(a)	N/A	Occupied Bandwidth	N/A	PASS
3.3	§2.1051 §22.917(a) §24.238(a)	RSS-132 (4.5.1) RSS-133 (6.5.1)	Band Edge Measurement	< 43+10log ₁₀ (P[Watts])	PASS
3.4	§2.1051 §22.917(a) §24.238(a)	RSS-132 (4.5.1) RSS-133 (6.5.1)	Conducted Emission	< 43+10log ₁₀ (P[Watts])	PASS
3.5	§2.1053 §22.917(a) §24.238(a)	RSS-132 (4.5.1) RSS-133 (6.5.1)	Field Strength of Spurious Radiation	< 43+10log ₁₀ (P[Watts])	PASS
3.6	§2.1055 §22.355 §24.235	RSS-132(4.3) RSS-133(6.3)	Frequency Stability for Temperature & Voltage	< 2.5 ppm	PASS



1 General Description

1.1 Applicant

Trimble Navigation Ltd.
935 Stewart Drive, Sunnyvale CA 94088-3642, U.S.A.

1.2 Manufacturer

GOLDTEK Technology Co., Ltd.
3F., No.3, Ln. 768, Sec. 4, Pateh Rd., Taipei 115, Taiwan, R.O.C.

1.3 Feature of Equipment Under Test

Product Feature & Specification	
Equipment	PDA
Brand Name	Trimble
Model Name	Juno SC
Tx Frequency	GSM850 : 824 MHz ~ 849 MHz GSM1900 : 1850 MHz ~ 1910 MHz WCDMA Band V : 824 MHz ~ 849 MHz WCDMA Band II : 1850 MHz ~ 1910 MHz
Rx Frequency	GSM850 : 869 MHz ~ 894 MHz GSM1900 : 1930 MHz ~ 1990 MHz WCDMA Band V : 869 MHz ~ 894 MHz WCDMA Band II : 1930 MHz ~ 1990 MHz
Maximum Output Power to Antenna	GSM850 : 31.73 dBm GSM1900 : 28.89 dBm WCDMA Band V : 22.20 dBm WCDMA Band II : 22.69 dBm
Maximum ERP/EIRP	GSM850 (GPRS) : 0.78 W (28.93 dBm) GSM850 (EDGE) : 0.33 W (25.25 dBm) GSM1900 (GPRS) : 1.93 W (32.86 dBm) GSM1900 (EDGE) : 1.53 W (31.86 dBm) WCDMA Band V (HSDPA) : 0.10 W (20.21 dBm) WCDMA Band II (HSDPA) : 0.59 W (27.73 dBm)
Antenna Type	Fixed Internal Antenna
HW Version	1.0
SW Version	1.0
Type of Modulation	GSM / GPRS : GMSK EDGE : 8PSK WCDMA : QPSK HSDPA : QPSK / 16QAM
Type of Emission	GSM : 300KGXW EDGE : 300KG7W WCDMA : 4M22F9W
EUT Stage	Identical Prototype

Accessories List:

Accessories Specification		
AC Adapter	Brand Name	Trimble
	Model Name	3A-161WP05
	Power Rating	I/P: 100-240Vac, 50-60Hz, 0.6A; O/P: 5Vdc, 2.6A
	AC Power Cord Type	1.24 meter non-shielded cable with ferrite core
Battery	Model Name	BA-1405206
	Power Rating	3.7Vdc, 2600mAh
	Type	Li-ion
USB Cable	Signal Line Type	1.2 meter shielded cable with ferrite core
LCD Panel	Brand Name	Toppy
	Model Name	td035sted7

Remark:

1. The above EUT's information was declared by manufacturer. Please refer to the specifications or user's manual for more detailed description.
2. For accessories equipped with this EUT, please refer to the appendix of the external photo.

1.4 Testing Site

Test Site	SPORTON INTERNATIONAL INC.		
Test Site Location	No. 52, Hwa Ya 1 st Rd., Hwa Ya Technology Park, Kwei-Shan Hsiang, Tao Yuan Hsien, Taiwan, R.O.C TEL: +886-3-327-3456 FAX: +886-3-328-4978		
Test Site No.	Sporton Site No.		FCC/IC Registration No.
	TH02-HY	03CH06-HY	TW1022/4086B-1



1.5 Applied Standards

According to the specifications of the manufacturer, the EUT must comply with the requirements of the following standards:

- Preliminary Guidance for Receiving Applications for Certification of 3G Device. May 9, 2006.
- 47 CFR Part 2, 22(H), 24(E)
- ANSI C63.4-2003
- ANSI / TIA / EIA-603-C-2004
- IC RSS-132, RSS-133

Remark:

1. All test items were verified and recorded according to the standards and without any deviation during the test.
2. This EUT has also been tested and complied with the requirements of FCC Part 15, Subpart B (DoC), recorded in a separate test report.

1.6 Ancillary Equipment List

Item	Equipment	Trade Name	Model No.	FCC ID	Data Cable	Power Code
1.	Base Station	R&S	CMU200	N/A	N/A	Unshielded, 1.8m

2 Test Configuration of Equipment Under Test

2.1 Test Mode

During all testing, EUT is in link mode with base station emulator at maximum power level. The spurious emission measurements were carried out in semi-anechoic chamber with 3-meter test range, and EUT is rotated on three test planes to find out the worst emission.

Frequency range investigated for radiated emission is as follows:

1. 30 MHz to 9000 MHz for GSM850 and WCDMA Band V
2. 30MHz to 19000 MHz for GSM1900 and WCDMA Band II.

Test Modes		
Band	Radiated TCs	Conducted TCs
GSM 850	<ul style="list-style-type: none"> ■ GPRS Link ■ EDGE Link 	<ul style="list-style-type: none"> ■ GPRS Link ■ EDGE Link
GSM 1900	<ul style="list-style-type: none"> ■ GPRS Link ■ EDGE Link 	<ul style="list-style-type: none"> ■ GPRS Link ■ EDGE Link
WCDMA Band V	<ul style="list-style-type: none"> ■ HSDPA Link 	<ul style="list-style-type: none"> ■ WCDMA Link ■ HSDPA Link
WCDMA Band II	<ul style="list-style-type: none"> ■ HSDPA Link 	<ul style="list-style-type: none"> ■ WCDMA Link ■ HSDPA Link

2.2 Connection Diagram of Test System

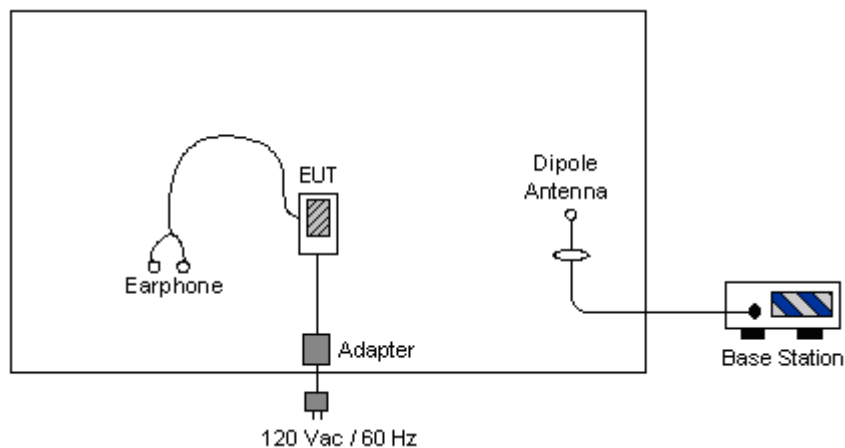

3 Test Result

3.1 Conducted Output Power Measurement

3.1.1 Description of the Conducted Output Power Measurement

A base station simulator was used to establish communication with the EUT. Its parameters were set to transmit the maximum power on the EUT. The measured power in the radio frequency on the transmitter output terminals shall be reported.

3.1.2 Measuring Instruments

See list of measuring instruments of this test report.

3.1.3 Test Procedures

1. The transmitter output port was connected to base station.
2. Set EUT at maximum power through base station.
3. Select lowest, middle, and highest channels for each band and different modulation.

3.1.4 Test Setup

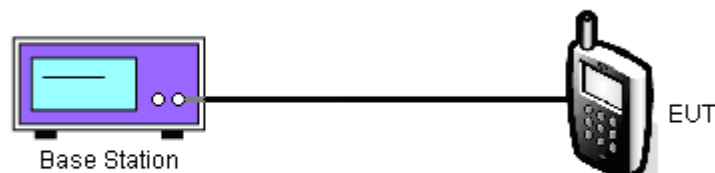



3.1.5 Test Result of Conducted Output Power

Cellular Band					
Modes	Channel	Frequency (MHz)	Conducted Power		
			(dBm)	(Watts)	
GPRS	128 (Low)	824.2	31.44	1.39	
	189 (Mid)	836.4	31.61	1.45	
	251 (High)	848.8	31.73	1.49	
EDGE	128 (Low)	824.2	26.51	0.45	
	189 (Mid)	836.4	26.66	0.46	
	251 (High)	848.8	26.77	0.48	
WCDMA Band V	12.2k bps	4132 (Low)	826.4	21.92	0.16
		4182 (Mid)	836.4	21.96	0.16
		4233 (High)	846.6	21.93	0.16
	HSDPA β (2/15)	4132 (Low)	826.4	22.02	0.16
		4182 (Mid)	836.4	21.99	0.16
		4233 (High)	846.6	22.04	0.16
	HSDPA β (12/15)	4132 (Low)	826.4	22.14	0.16
		4182 (Mid)	836.4	22.20	0.17
		4233 (High)	846.6	22.13	0.16
	HSDPA β (15/8)	4132 (Low)	826.4	20.68	0.12
		4182 (Mid)	836.4	20.75	0.12
		4233 (High)	846.6	20.98	0.13
	HSDPA β (15/4)	4132 (Low)	826.4	19.63	0.09
		4182 (Mid)	836.4	19.54	0.09
		4233 (High)	846.6	19.77	0.09

PCS Band					
Modes	Channel	Frequency (MHz)	Conducted Power		
			(dBm)	(Watts)	
GPRS	512 (Low)	1850.2	28.87	0.77	
	661 (Mid)	1880.0	28.89	0.77	
	810 (High)	1909.8	28.59	0.72	
EDGE	512 (Low)	1850.2	25.74	0.37	
	661 (Mid)	1880.0	25.68	0.37	
	810 (High)	1909.8	25.42	0.35	
WCDMA Band II	12.2k bps	9262 (Low)	1852.4	22.10	0.16
		9400 (Mid)	1880.0	22.50	0.18
		9538 (High)	1907.6	22.19	0.17
	HSDPA β (2/15)	9262 (Low)	1852.4	22.28	0.17
		9400 (Mid)	1880.0	22.68	0.19
		9538 (High)	1907.6	22.30	0.17
	HSDPA β (12/15)	9262 (Low)	1852.4	22.30	0.17
		9400 (Mid)	1880.0	22.69	0.19
		9538 (High)	1907.6	22.34	0.17
	HSDPA β (15/8)	9262 (Low)	1852.4	21.01	0.13
		9400 (Mid)	1880.0	21.44	0.14
		9538 (High)	1907.6	21.13	0.13
	HSDPA β (15/4)	9262 (Low)	1852.4	19.93	0.10
		9400 (Mid)	1880.0	20.38	0.11
		9538 (High)	1907.6	20.09	0.10

3.2 Effective Radiated Power and Effective Isotropic Radiated Power Measurement

3.2.1 Description of the ERP/EIRP Measurement

ERP/EIRP is measured by substitution method according to ANSI / TIA / EIA-603-C-2004. The ERP of mobile transmitters must not exceed 7 Watts and the EIRP of mobile transmitters are limited to 2 Watts.

3.2.2 Measuring Instruments

See list of measuring instruments of this test report.

3.2.3 Test Procedures

1. The EUT was placed on a turntable with 1.0 meter height in a fully anechoic chamber.
2. The EUT was set at 1.2 meters from the receiving antenna, which was mounted on the antenna tower.
3. The table was rotated 360 degrees to determine the position of the highest radiated power.
4. The height of the receiving antenna is adjusted to look for the maximum ERP/EIRP.
5. Taking the record of maximum ERP/EIRP.
6. A dipole antenna was substituted in place of the EUT and was driven by a signal generator.
7. The conducted power at the terminal of the dipole antenna is measured.
8. Repeat step 3 to step 5 to get the maximum ERP/EIRP of the substitution antenna.
9. $ERP/EIRP = P_s + E_t - E_s + G_s = P_s + R_t - R_s + G_s$

P_s (dBm) : Input power to substitution antenna.

G_s (dBi or dBd) : Substitution antenna Gain.

$E_t = R_t + AF$

$E_s = R_s + AF$

AF (dB/m) : Receive antenna factor

R_t : The highest received signal in spectrum analyzer for EUT.

R_s : The highest received signal in spectrum analyzer for substitution antenna.

3.2.4 Test Setup

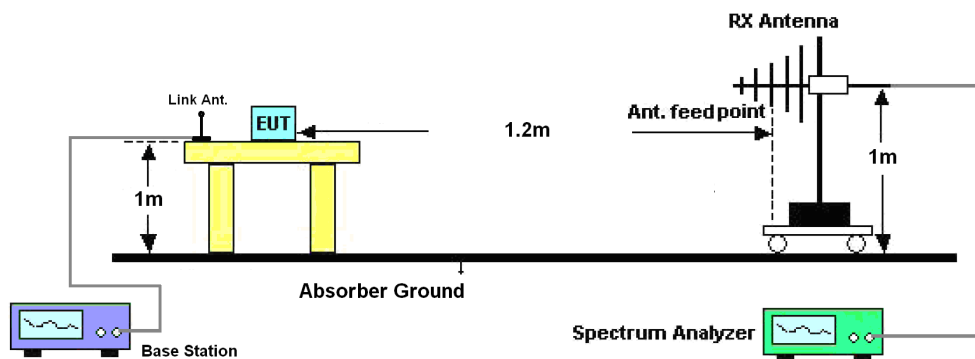



3.2.5 Test Result of ERP

GSM850 (GPRS) Radiated Power ERP						
Horizontal Polarization						
Frequency (MHz)	Rt (dBm)	Rs (dBm)	Ps (dBm)	Gs (dBd)	ERP (dBm)	ERP (W)
824.20	-30.90	-48.12	0.00	-1.08	16.14	0.04
836.40	-30.12	-48.28	0.00	-0.93	17.23	0.05
848.80	-28.82	-48.35	0.00	-0.76	18.77	0.08
Vertical Polarization						
Frequency (MHz)	Rt (dBm)	Rs (dBm)	Ps (dBm)	Gs (dBd)	ERP (dBm)	ERP (W)
824.20	-19.12	-47.97	0.00	-1.08	27.77	0.60
836.40	-18.15	-48.01	0.00	-0.93	28.93	0.78
848.80	-19.80	-48.05	0.00	-0.76	27.49	0.56

GSM850 (EDGE) Radiated Power ERP						
Horizontal Polarization						
Frequency (MHz)	Rt (dBm)	Rs (dBm)	Ps (dBm)	Gs (dBd)	ERP (dBm)	ERP (W)
824.20	-35.95	-48.12	0.00	-1.08	11.09	0.01
836.40	-35.23	-48.28	0.00	-0.93	12.12	0.02
848.80	-33.88	-48.35	0.00	-0.76	13.71	0.02
Vertical Polarization						
Frequency (MHz)	Rt (dBm)	Rs (dBm)	Ps (dBm)	Gs (dBd)	ERP (dBm)	ERP (W)
824.20	-24.11	-47.97	0.00	-1.08	22.78	0.19
836.40	-23.23	-48.01	0.00	-0.93	23.85	0.24
848.80	-22.04	-48.05	0.00	-0.76	25.25	0.33



WCDMA Band V (HSDPA) Radiated Power ERP						
Horizontal Polarization						
Frequency (MHz)	Rt (dBm)	Rs (dBm)	Ps (dBm)	Gs (dBd)	ERP (dBm)	ERP (W)
826.40	-37.08	-48.12	0.00	-1.08	9.96	0.01
836.40	-37.73	-48.28	0.00	-0.93	9.62	0.01
846.60	-37.19	-48.35	0.00	-0.76	10.40	0.01
Vertical Polarization						
Frequency (MHz)	Rt (dBm)	Rs (dBm)	Ps (dBm)	Gs (dBd)	ERP (dBm)	ERP (W)
826.40	-26.68	-47.97	0.00	-1.08	20.21	0.10
836.40	-26.88	-48.01	0.00	-0.93	20.20	0.10
846.60	-26.26	-48.05	0.00	-0.76	21.03	0.13



3.2.6 Test Result of EIRP

GSM1900 (GPRS) Radiated Power EIRP						
Horizontal Polarization						
Frequency (MHz)	Rt (dBm)	Rs (dBm)	Ps (dBm)	Gs (dBi)	EIRP (dBm)	EIRP (W)
1850.20	-22.66	-51.88	0.00	1.96	31.18	1.31
1880.00	-23.85	-52.99	0.00	2.00	31.14	1.30
1909.80	-25.69	-54.28	0.00	1.98	30.57	1.14
Vertical Polarization						
Frequency (MHz)	Rt (dBm)	Rs (dBm)	Ps (dBm)	Gs (dBi)	EIRP (dBm)	EIRP (W)
1850.20	-21.23	-52.13	0.00	1.96	32.86	1.93
1880.00	-22.52	-53.17	0.00	2.00	32.65	1.84
1909.80	-24.01	-54.13	0.00	1.98	32.10	1.62

GSM1900 (EDGE) Radiated Power EIRP						
Horizontal Polarization						
Frequency (MHz)	Rt (dBm)	Rs (dBm)	Ps (dBm)	Gs (dBi)	EIRP (dBm)	EIRP (W)
1850.20	-23.71	-51.88	0.00	1.96	30.13	1.03
1880.00	-25.53	-52.99	0.00	2.00	29.46	0.88
1909.80	-28.00	-54.28	0.00	1.98	28.26	0.67
Vertical Polarization						
Frequency (MHz)	Rt (dBm)	Rs (dBm)	Ps (dBm)	Gs (dBi)	EIRP (dBm)	EIRP (W)
1850.20	-22.23	-52.13	0.00	1.96	31.86	1.53
1880.00	-23.93	-53.17	0.00	2.00	31.24	1.33
1909.80	-25.67	-54.13	0.00	1.98	30.44	1.11



WCDMA Band II (HSDPA) Radiated Power EIRP						
Horizontal Polarization						
Frequency (MHz)	Rt (dBm)	Rs (dBm)	Ps (dBm)	Gs (dBi)	EIRP (dBm)	EIRP (W)
1852.40	-28.12	-51.88	0.00	1.96	25.72	0.37
1880.00	-28.17	-52.99	0.00	2.00	26.82	0.48
1907.60	-30.13	-54.28	0.00	1.98	26.13	0.41
Vertical Polarization						
Frequency (MHz)	Rt (dBm)	Rs (dBm)	Ps (dBm)	Gs (dBi)	EIRP (dBm)	EIRP (W)
1852.40	-27.07	-52.13	0.00	1.96	27.02	0.50
1880.00	-27.44	-53.17	0.00	2.00	27.73	0.59
1907.60	-29.28	-54.13	0.00	1.98	26.83	0.48

3.3 Occupied Bandwidth and Band Edge Measurement

3.3.1 Description of Occupied Bandwidth and Band Edge Measurement

The power of any emission outside of the authorized operating frequency ranges must be lower than the transmitter power (P) by a factor of at least $43 + 10 \log (P)$ dB.

The emission bandwidth is defined as the width of the signal between two points, located at the 2 sides of the carrier frequency, outside of which all emissions are attenuated at least 26 dB below the transmitter power.

3.3.2 Measuring Instruments

See list of measuring instruments of this test report.

3.3.3 Test Procedures

1. The EUT was connected to Spectrum Analyzer and Base Station via power divider.
2. The 99% and 26 dB occupied bandwidth (BW) of the low, middle and high channels for the highest RF powers were measured.
3. The band edges of low and high channels for the highest RF powers were measured. Setting RBW as roughly BW/100.
4. The RBW was replaced by 10 kHz, due to the spectrum analyzer IF-Filter including an excess of the limit. A worst case correction factor of $10 \log (1\% \text{ BW}/\text{measurement RBW})$ was implemented.

3.3.4 Test Setup

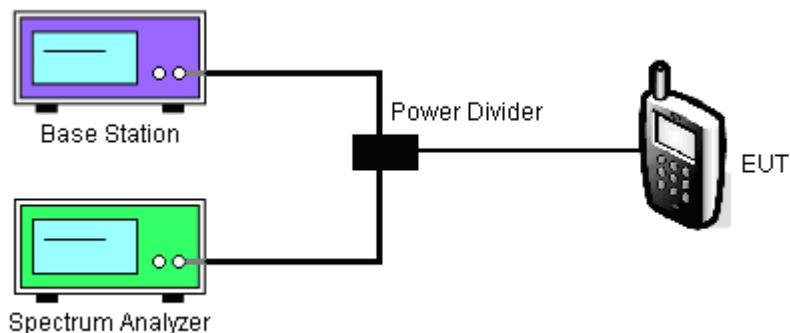



3.3.5 Test Result (Plots) of Occupied Bandwidth

Band :	GSM 850	Power Stage :	High
Test Mode :	GPRS Link		

99% Occupied Bandwidth Plot on Channel 189

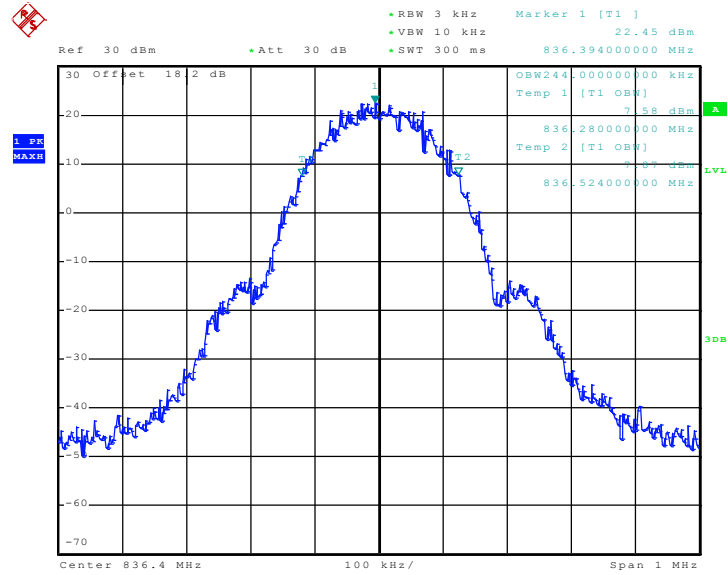

Date: 24.OCT.2008 22:11:47

26dB Bandwidth Plot on Channel 189

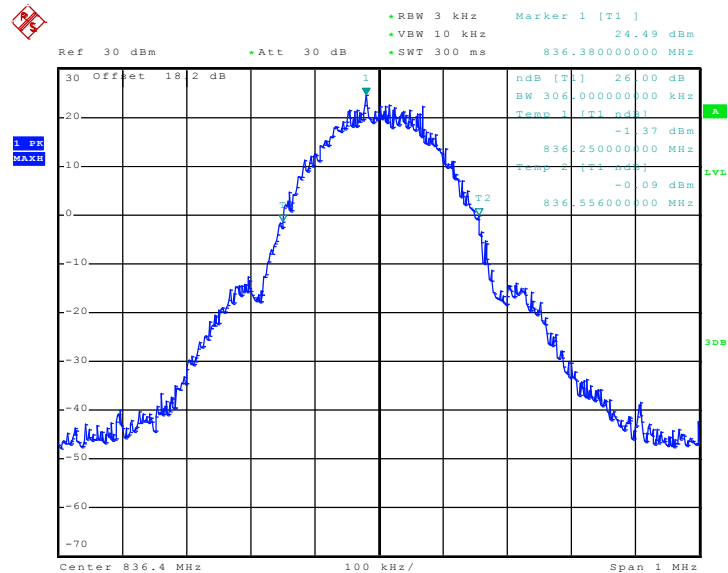

Date: 24.OCT.2008 22:03:45



Band :	GSM 850	Power Stage :	High
Test Mode :	EDGE Link		

99% Occupied Bandwidth Plot on Channel 189

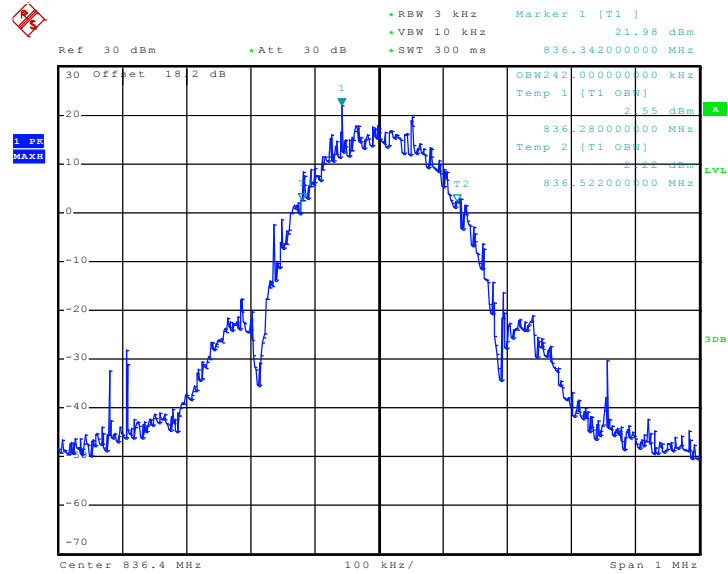

Date: 24.OCT.2008 23:09:56

26dB Bandwidth Plot on Channel 189

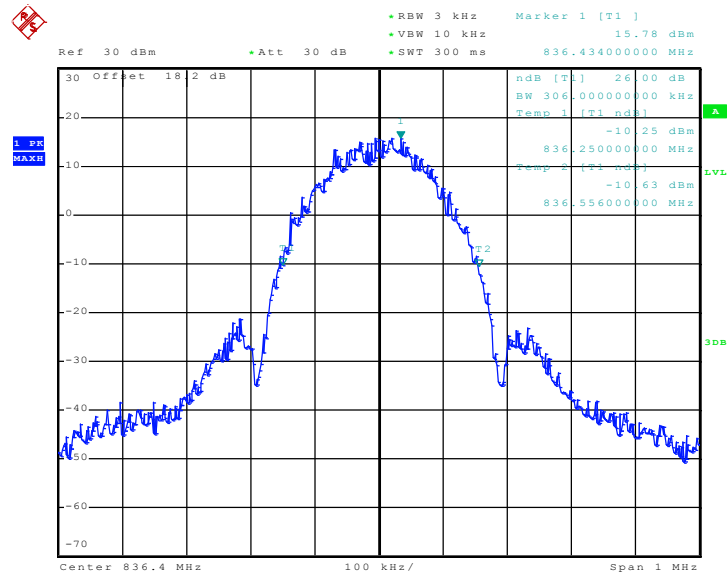

Date: 25.OCT.2008 04:41:53



Band :	GSM 1900	Power Stage :	High
Test Mode :	GPRS Link		

99% Occupied Bandwidth Plot on Channel 661

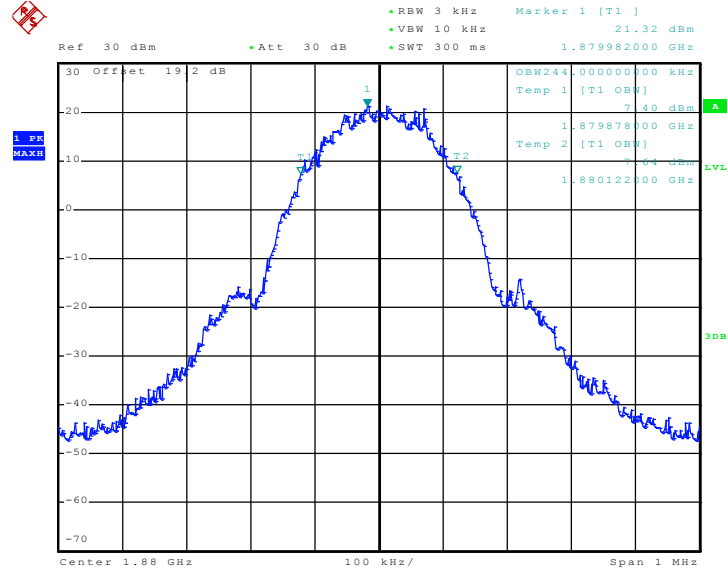

Date: 24.OCT.2008 23:59:25

26dB Bandwidth Plot on Channel 661

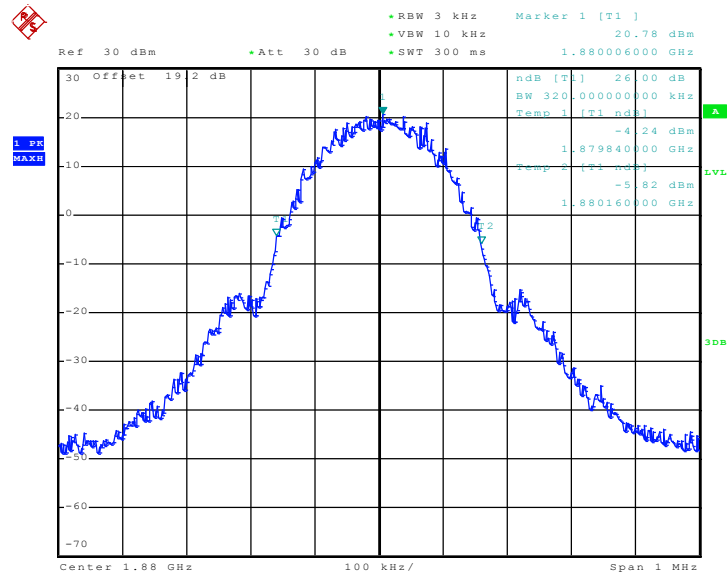

Date: 24.OCT.2008 23:56:38



Band :	GSM 1900	Power Stage :	High
Test Mode :	EDGE Link		

99% Occupied Bandwidth Plot on Channel 661

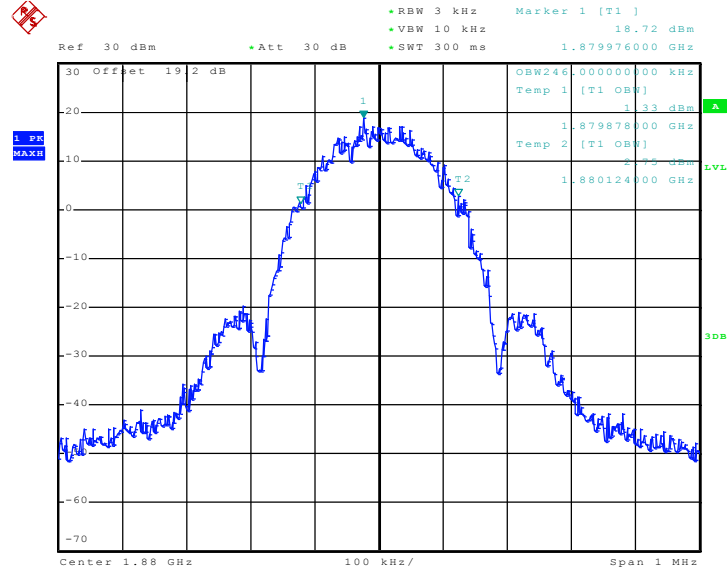

Date: 25.OCT.2008 02:46:31

26dB Bandwidth Plot on Channel 661

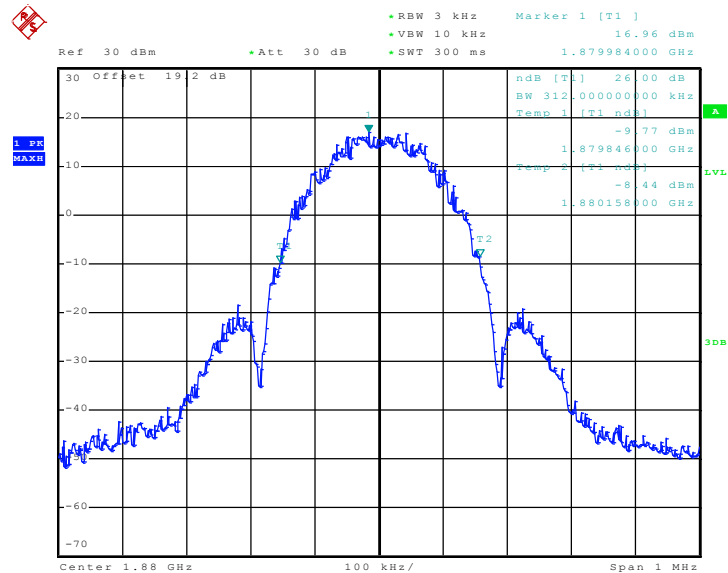

Date: 25.OCT.2008 02:43:39



Band :	WCDMA Band II	Power Stage :	High
Test Mode :	HSDPA Link		

99% Occupied Bandwidth Plot on Channel 9400

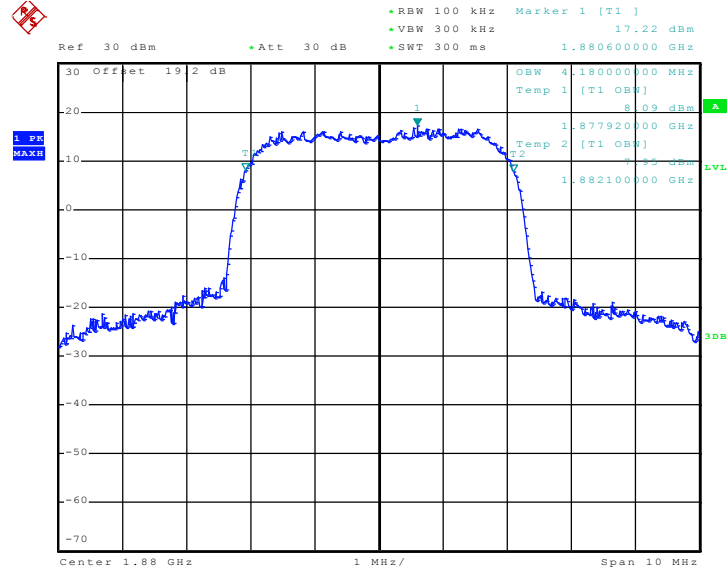

Date: 25.OCT.2008 04:07:42

26dB Bandwidth Plot on Channel 9400

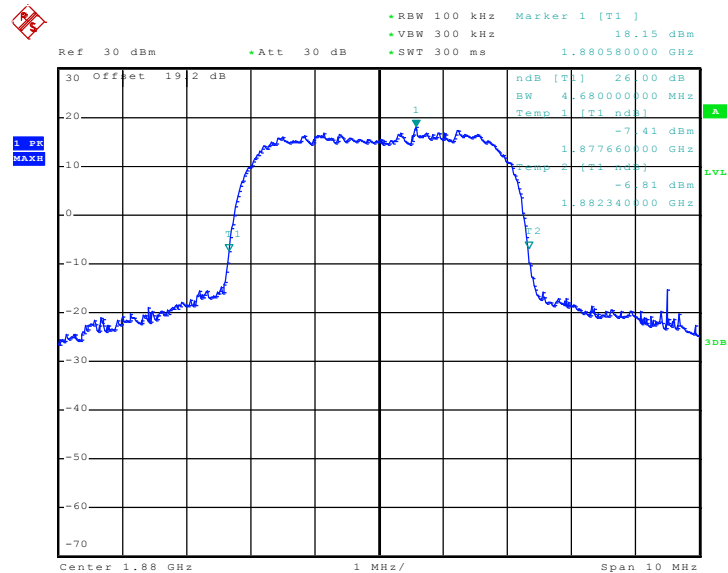

Date: 25.OCT.2008 04:12:55



Test Result (Plots) of Conducted Band Edges

Band :	GSM850	Power Stage :	High
Test Mode :	GPRS Link		

Lower Band Edge Plot on Channel 128

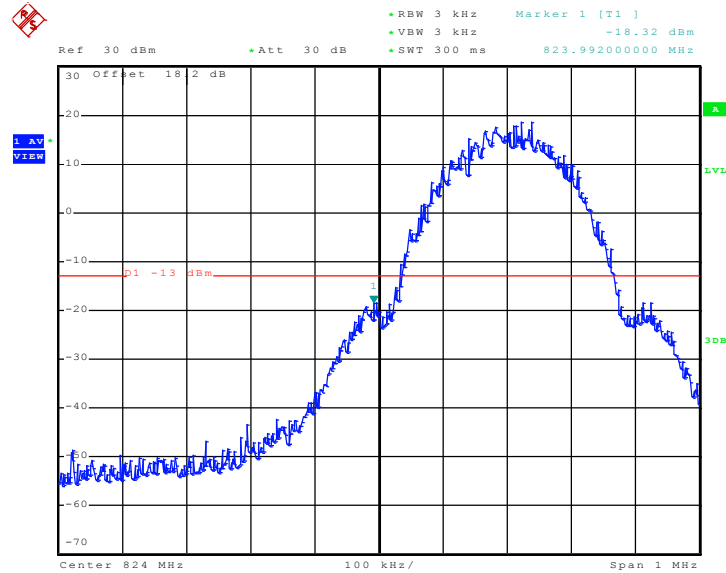

Date: 24.OCT.2008 22:22:13

Higher Band Edge Plot on Channel 251

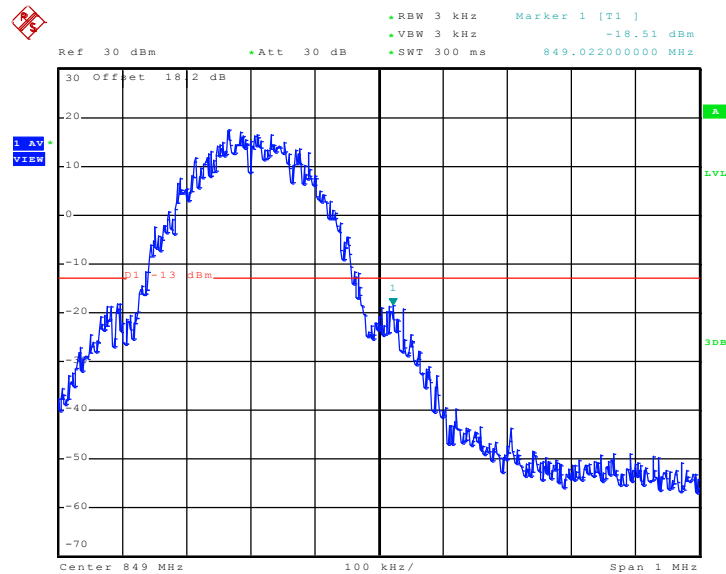

Date: 24.OCT.2008 22:24:11



Band :	GSM850	Power Stage :	High
Test Mode :	EDGE Link		

Lower Band Edge Plot on Channel 128

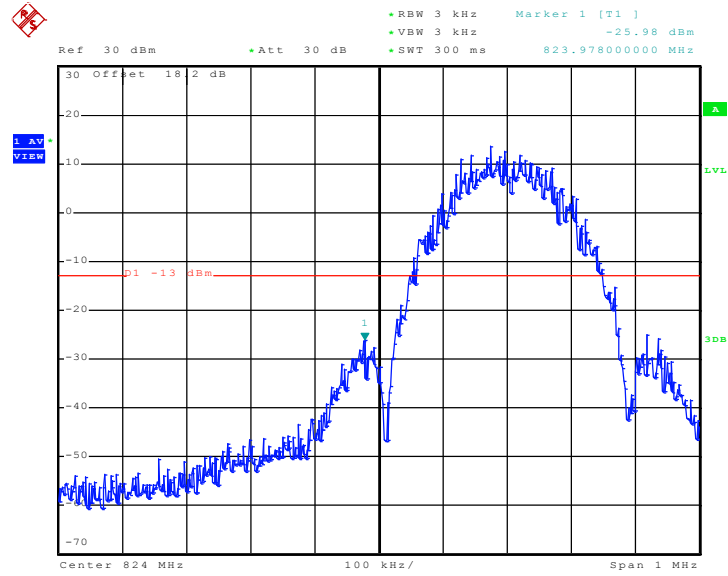

Date: 24.OCT.2008 23:19:37

Higher Band Edge Plot on Channel 251

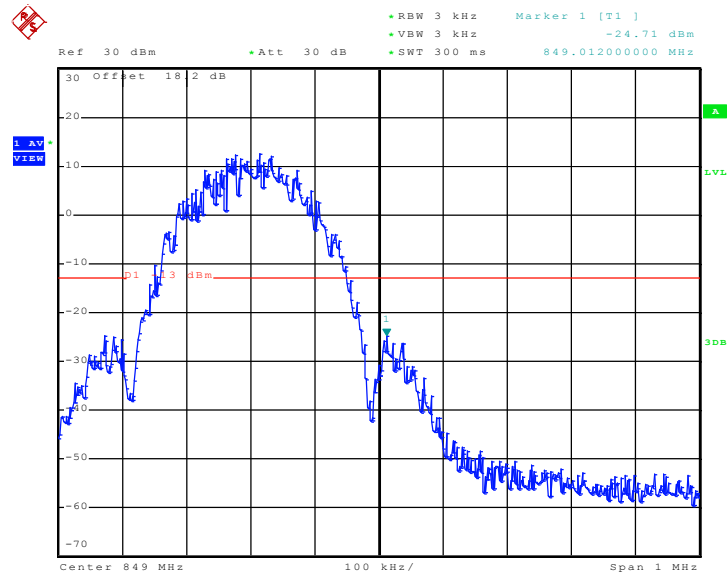

Date: 24.OCT.2008 23:26:44



Band :	GSM1900	Power Stage :	High
Test Mode :	GPRS Link		

Lower Band Edge Plot on Channel 512

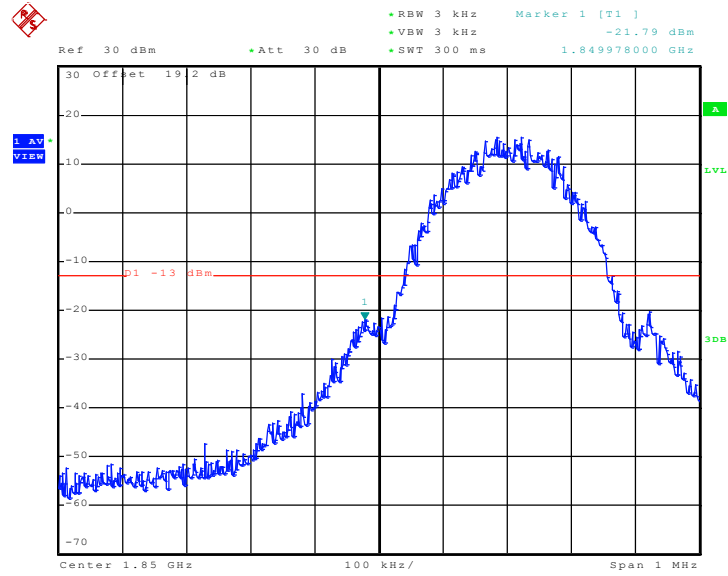

Date: 25.OCT.2008 00:26:45

Higher Band Edge Plot on Channel 810

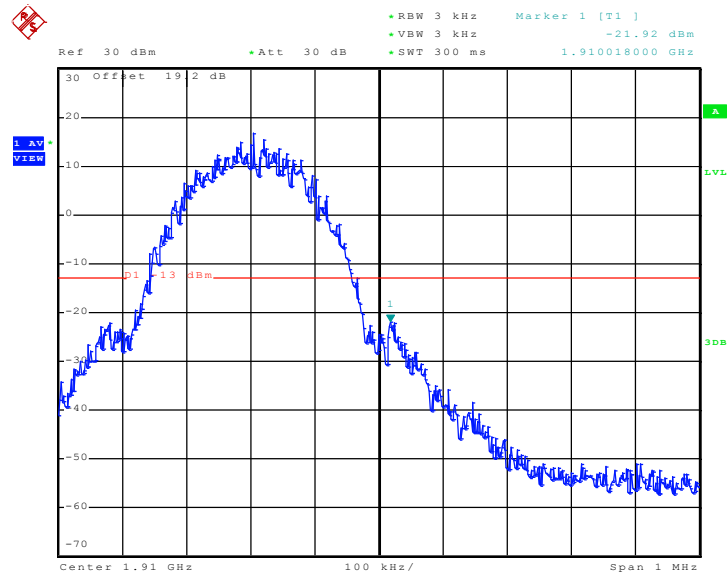

Date: 25.OCT.2008 00:29:21



Band :	GSM1900	Power Stage :	High
Test Mode :	EDGE Link		

Lower Band Edge Plot on Channel 512

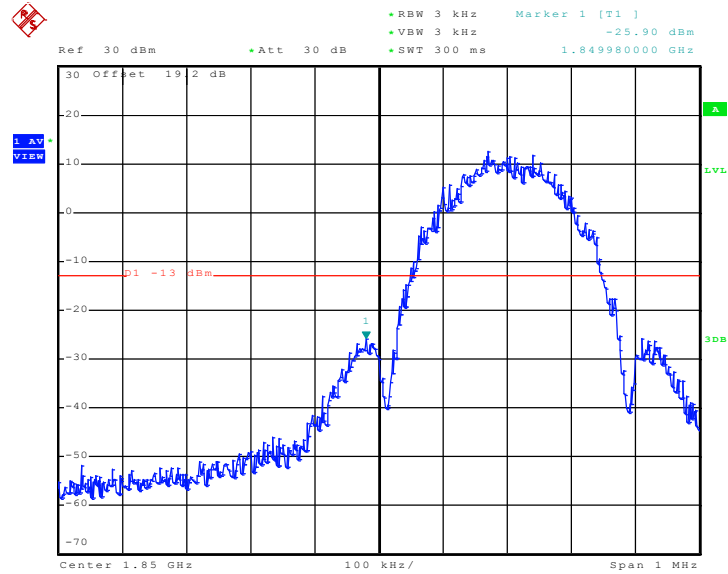

Date: 25.OCT.2008 02:53:05

Higher Band Edge Plot on Channel 810

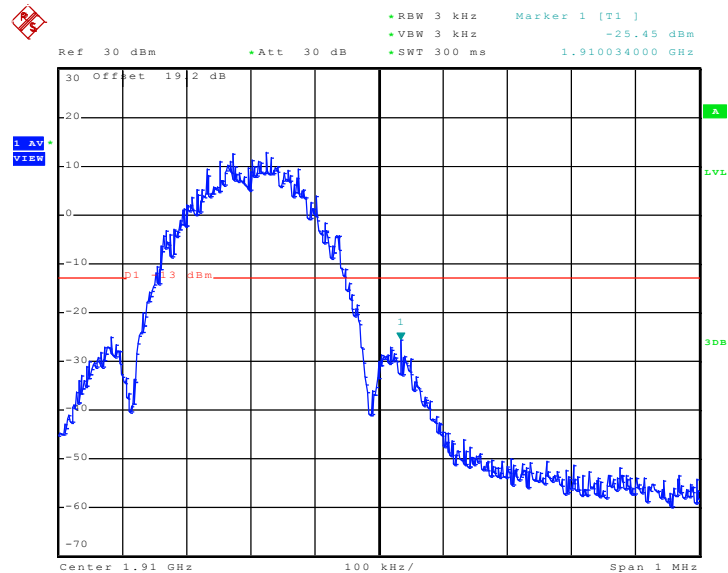

Date: 25.OCT.2008 02:55:10



Band :	WCDMA Band V	Power Stage :	High
Test Mode :	HSDPA Link		

Lower Band Edge Plot on Channel 4132

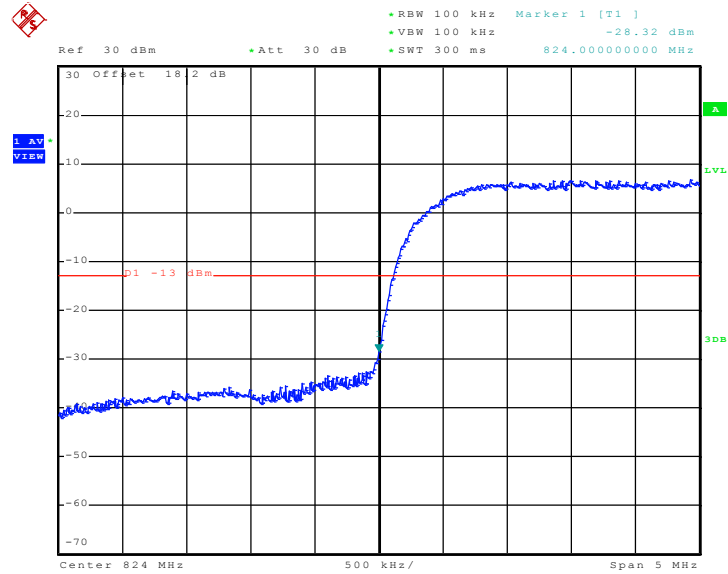

Date: 25.OCT.2008 03:31:48

Higher Band Edge Plot on Channel 4233

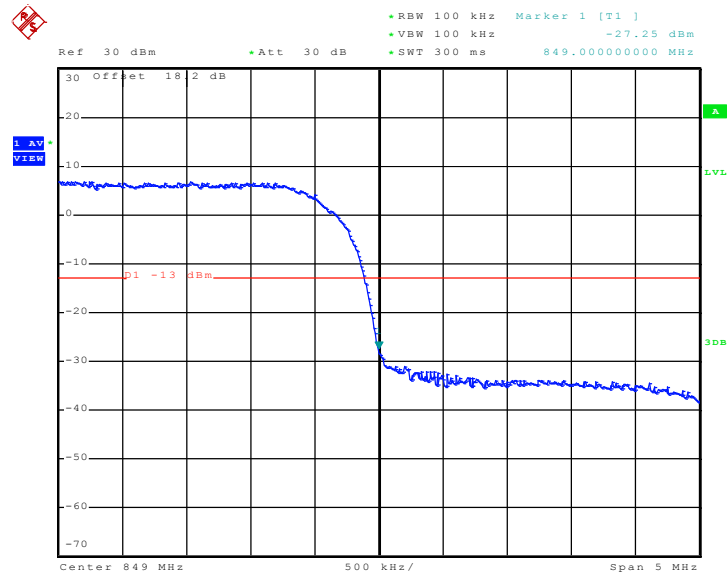

Date: 25.OCT.2008 03:33:04



Band :	WCDMA Band II	Power Stage :	High
Test Mode :	HSDPA Link		

Lower Band Edge Plot on Channel 9262

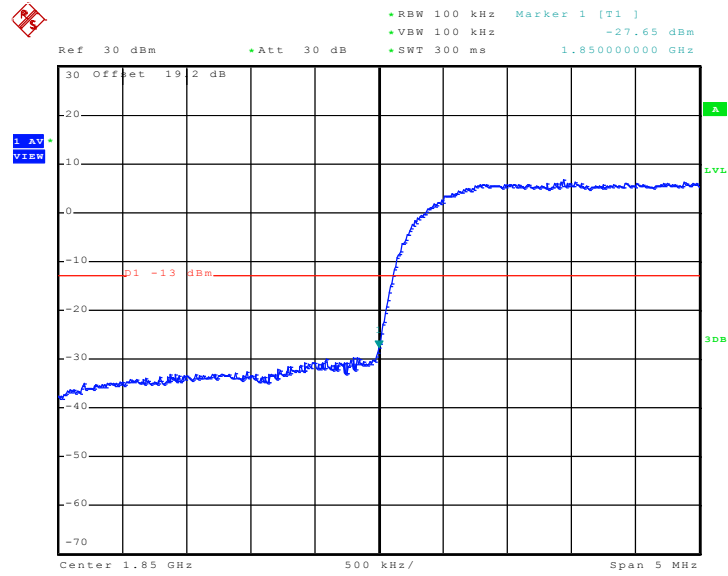

Date: 25.OCT.2008 04:17:14

Higher Band Edge Plot on Channel 9538

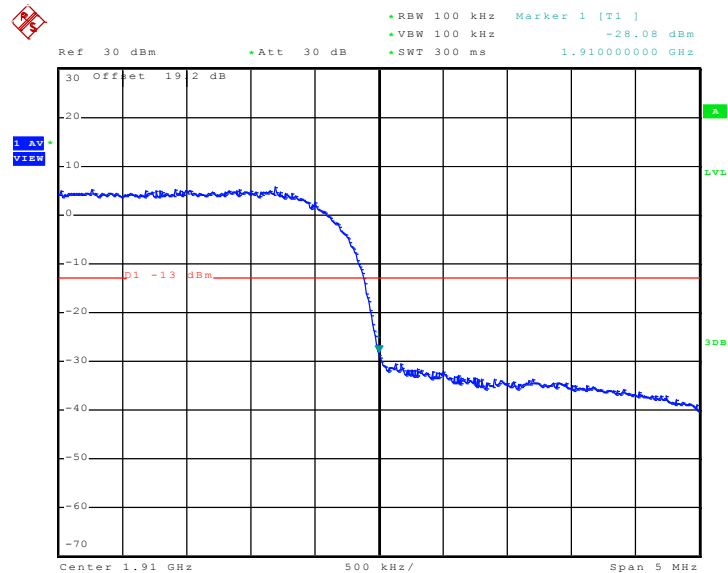

Date: 25.OCT.2008 04:16:14

3.4 Conducted Emission Measurement

3.4.1 Description of Conducted Emission Measurement

The power of any emission outside of the authorized operating frequency ranges must be lower than the transmitter power (P) by a factor of at least $43 + 10 \log (P)$ dB.

It is measured by means of a calibrated spectrum analyzer and scanned from 30 MHz up to a frequency including its 10th harmonic.

3.4.2 Measuring Instruments

See list of measuring instruments of this test report.

3.4.3 Test Procedures

1. The EUT was connected to spectrum analyzer and base station via power divider.
2. The middle channel for the highest RF power within the transmitting frequency was measured.
3. The conducted spurious emission for the whole frequency range was taken.

3.4.4 Test Setup

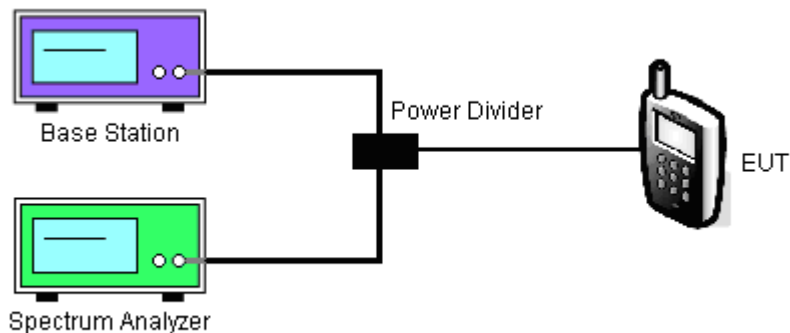



3.4.5 Test Result of Conducted Emission

Band :	GSM850	Channel :	CH189
Test Mode :	GPRS Link		

Conducted Emission Plot between 30M-1G

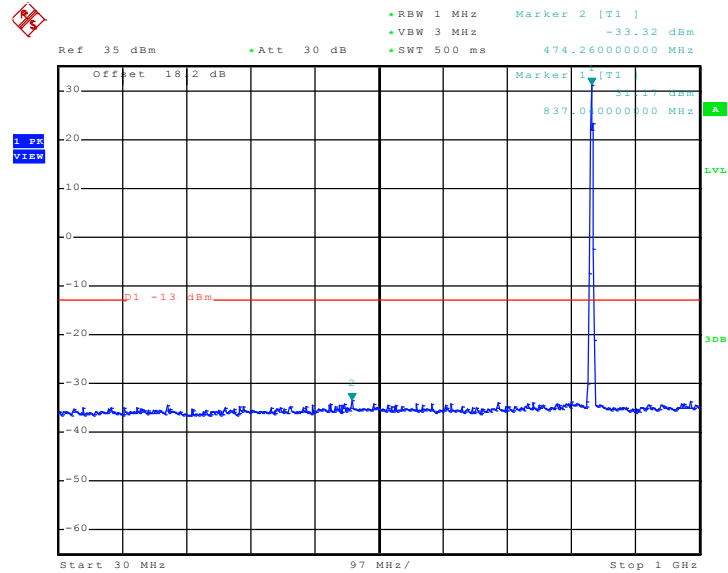

Date: 24.OCT.2008 22:31:12

Conducted Emission Plot between 1GHz ~ 3GHz

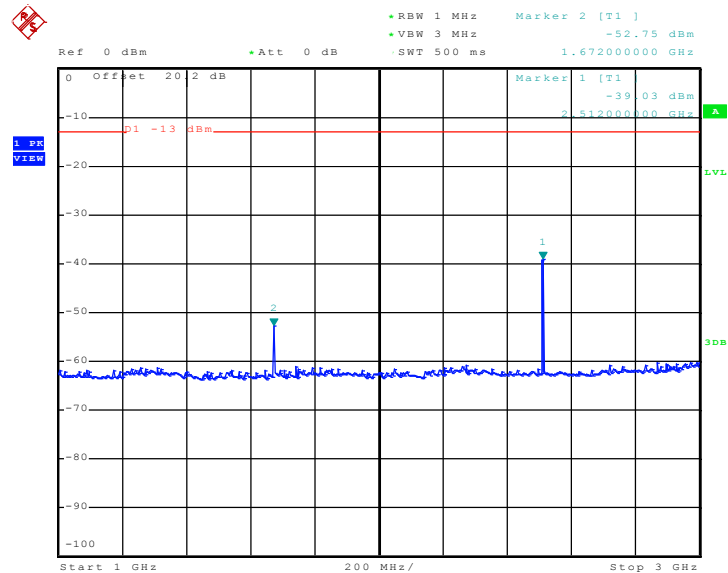

Date: 24.OCT.2008 22:33:36



Conducted Emission Plot between 3GHz ~ 7GHz

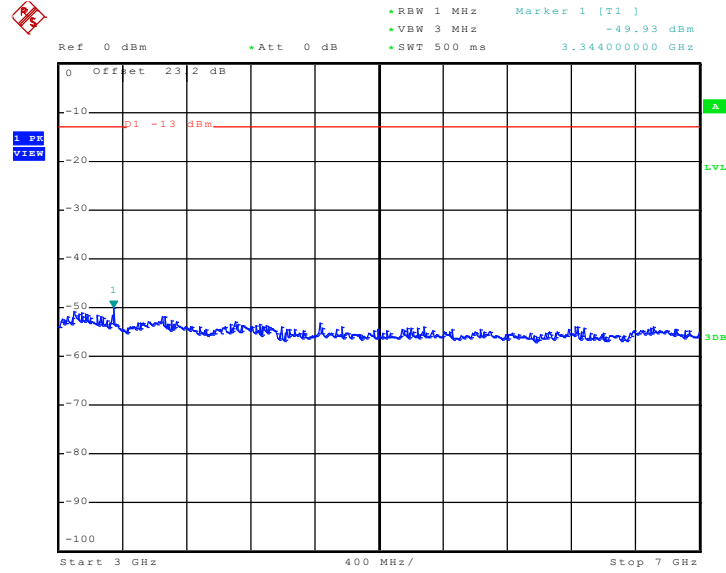

Date: 24.OCT.2008 22:34:13

Conducted Emission Plot between 7GHz ~ 9GHz

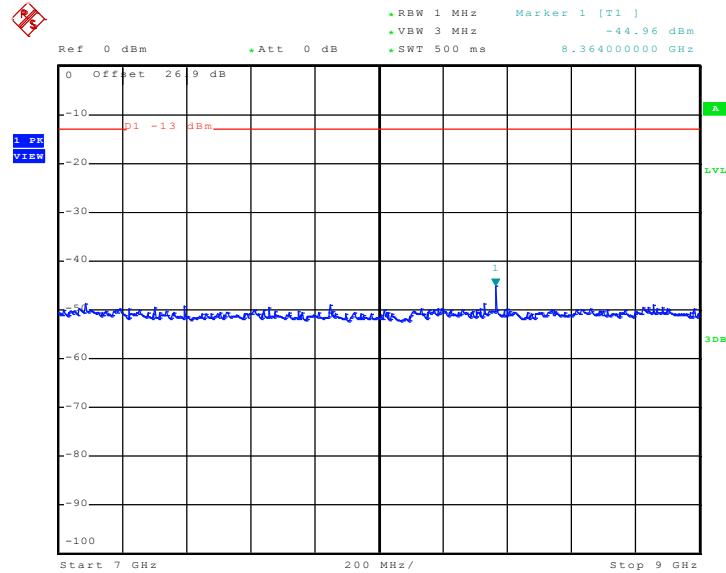

Date: 24.OCT.2008 22:36:29



Band :	GSM850	Channel :	CH189
Test Mode :	EDGE Link		

Conducted Emission Plot between 30M-1G

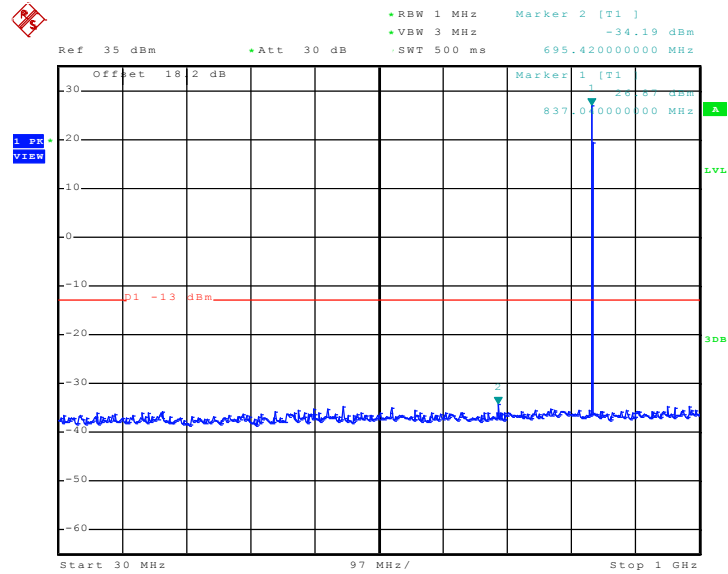

Date: 24.OCT.2008 23:00:55

Conducted Emission Plot between 1GHz ~ 3GHz

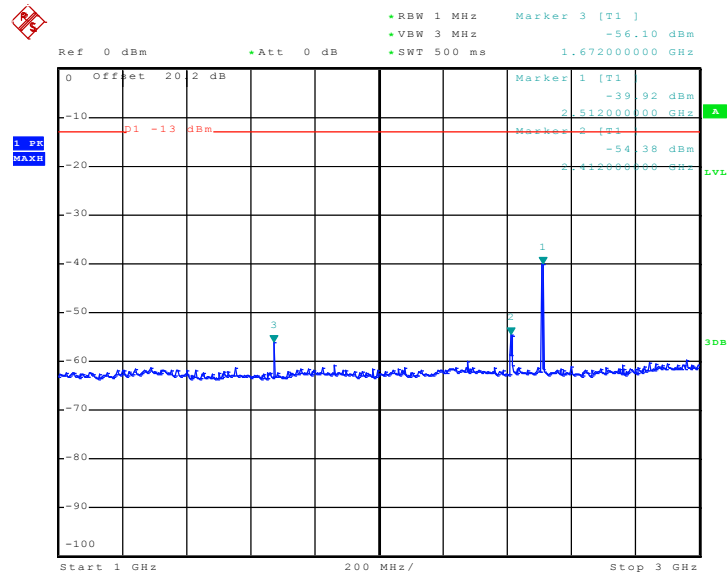

Date: 24.OCT.2008 22:46:23



Conducted Emission Plot between 3GHz ~ 7GHz

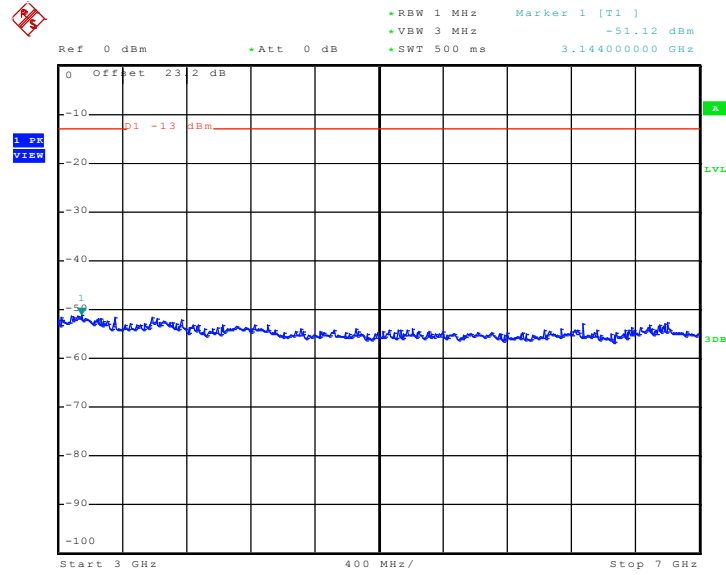

Date: 24.OCT.2008 22:44:48

Conducted Emission Plot between 7GHz ~ 9GHz

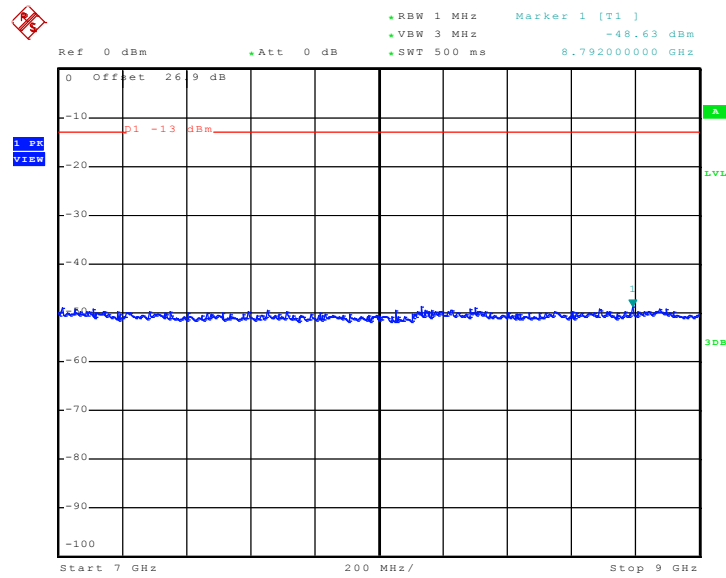

Date: 24.OCT.2008 22:44:07



Band :	GSM1900	Channel :	CH661
Test Mode :	GPRS Link		

Conducted Emission Plot between 30M-1G

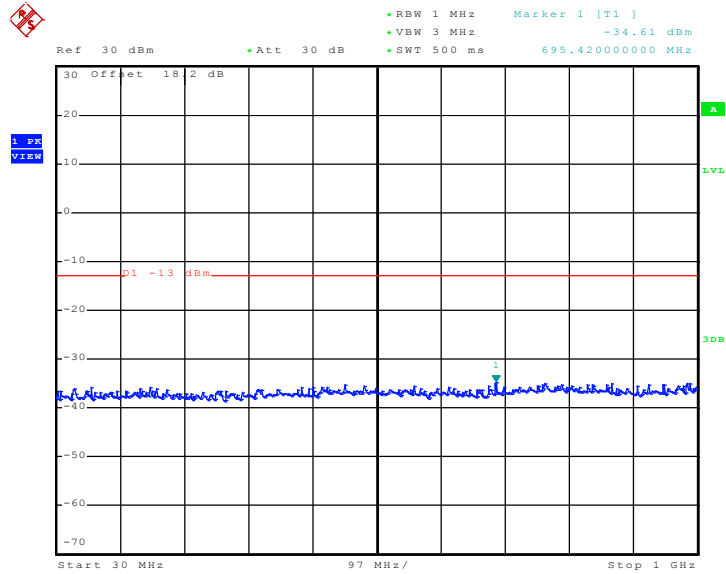

Date: 25.OCT.2008 02:12:06

Conducted Emission Plot between 1GHz ~ 3GHz

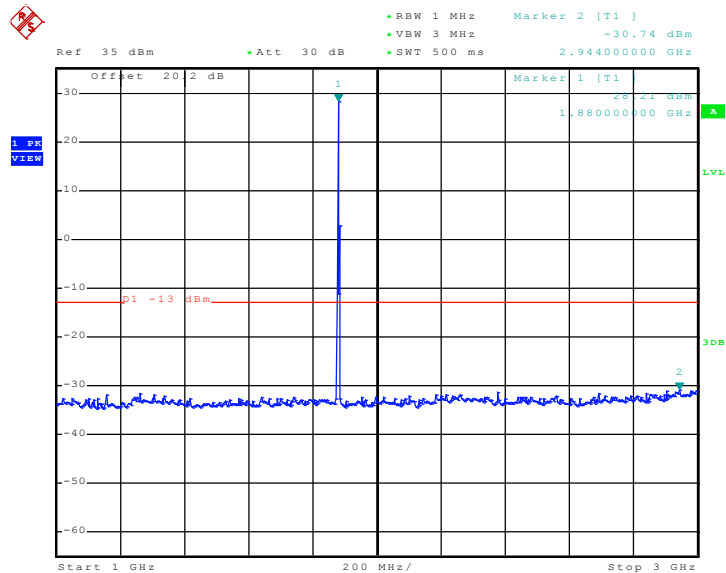

Date: 25.OCT.2008 02:17:40



Conducted Emission Plot between 3G-7G

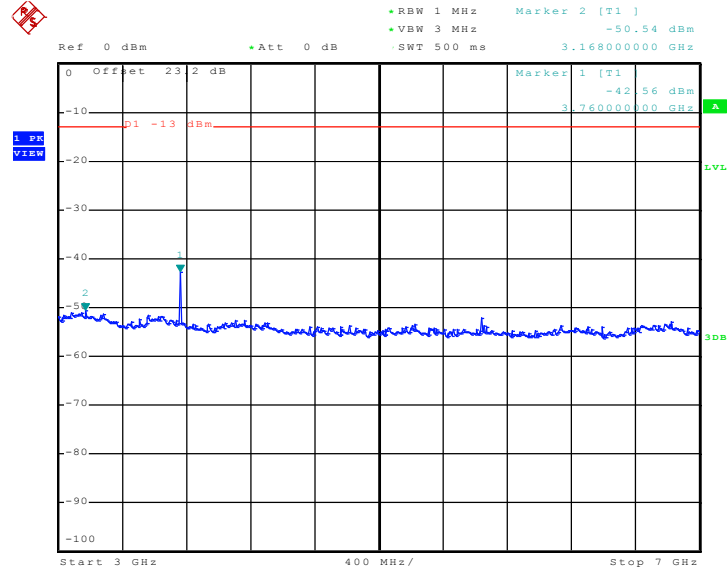

Date: 25.OCT.2008 02:19:06

Conducted Emission Plot between 7G-13.6G

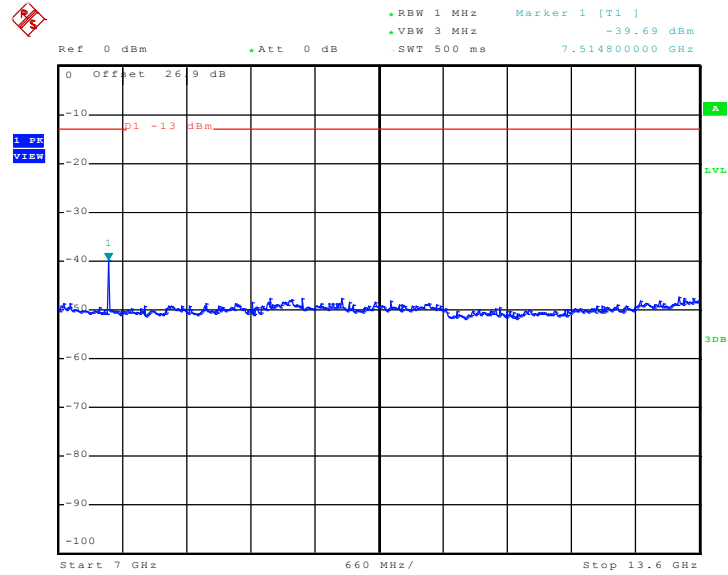

Date: 25.OCT.2008 03:14:47



Conducted Emission Plot between 13.6G-19.1G

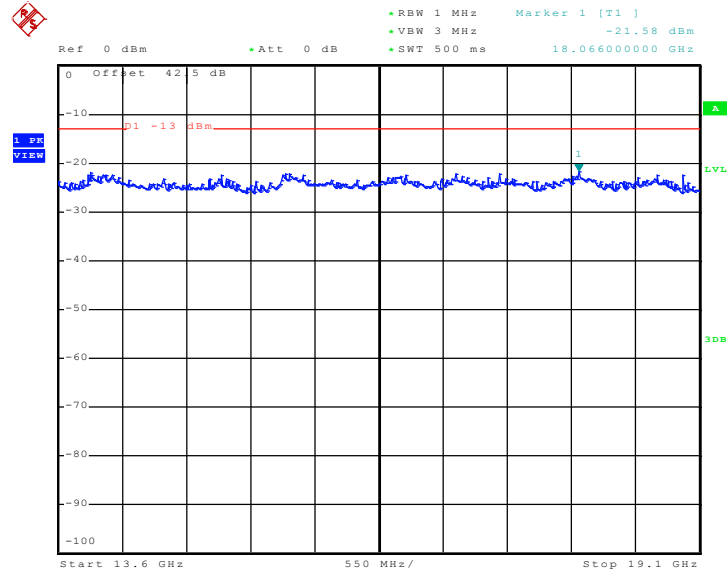

Date: 25.OCT.2008 02:20:34



Band :	GSM1900	Channel :	CH661
Test Mode :	EDGE Link		

Conducted Emission Plot between 30M-1G

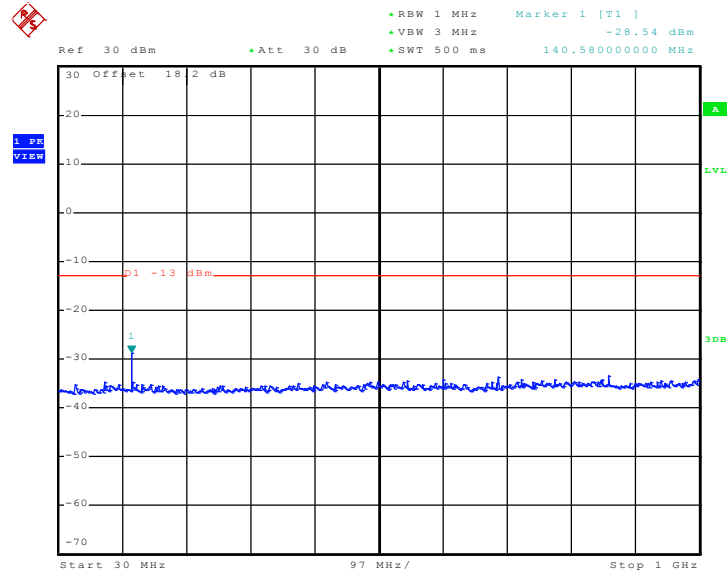

Date: 25.OCT.2008 02:41:09

Conducted Emission Plot between 1GHz ~ 3GHz

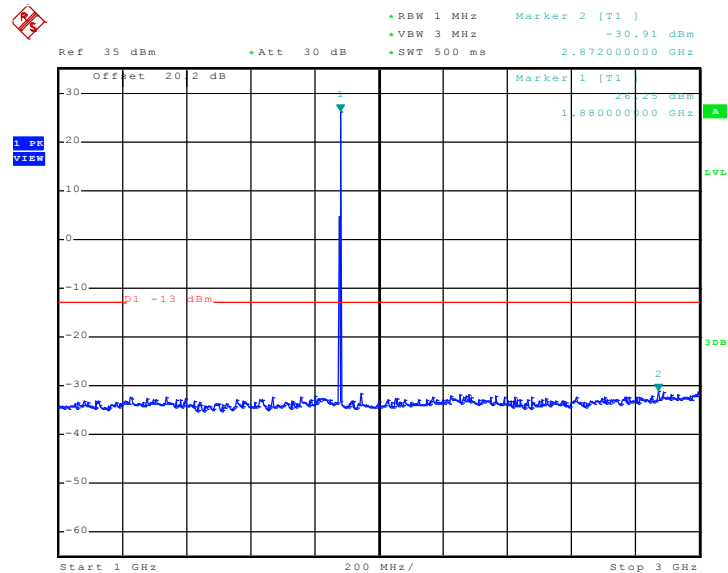

Date: 25.OCT.2008 02:38:38



Conducted Emission Plot between 3G-7G

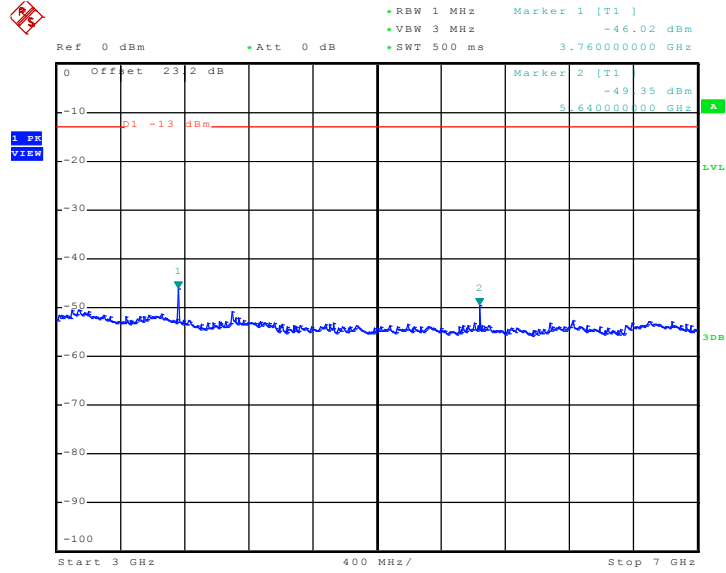

Date: 25.OCT.2008 02:35:28

Conducted Emission Plot between 7G-13.6G

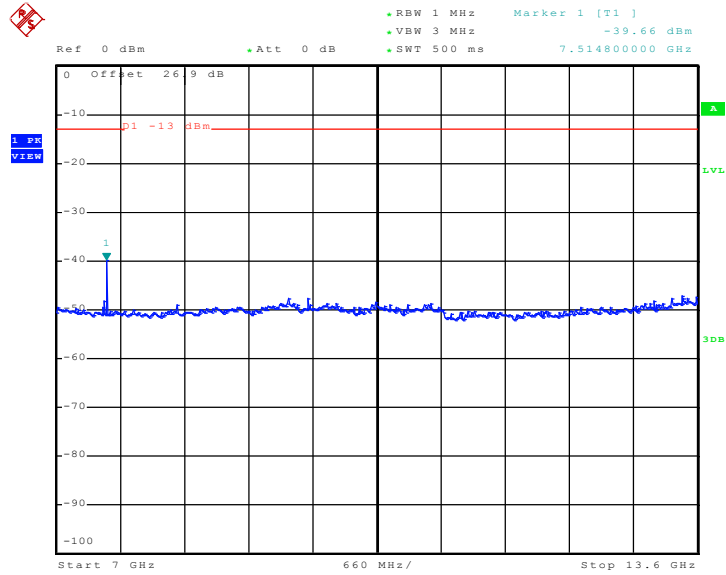

Date: 25.OCT.2008 02:33:44



Conducted Emission Plot between 13.6G-19.1G

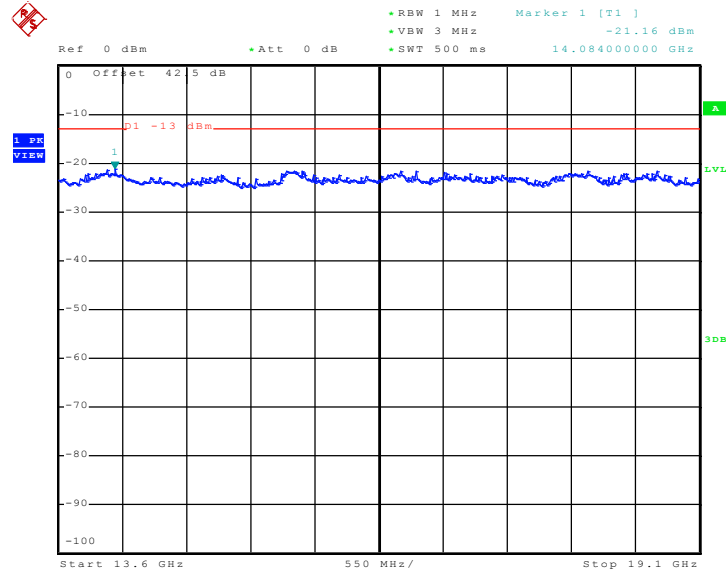

Date: 25.OCT.2008 02:23:27



Band :	WCDMA Band V	Channel :	CH4182
Test Mode :	HSDPA Link		

Conducted Emission Plot between 30M-1G

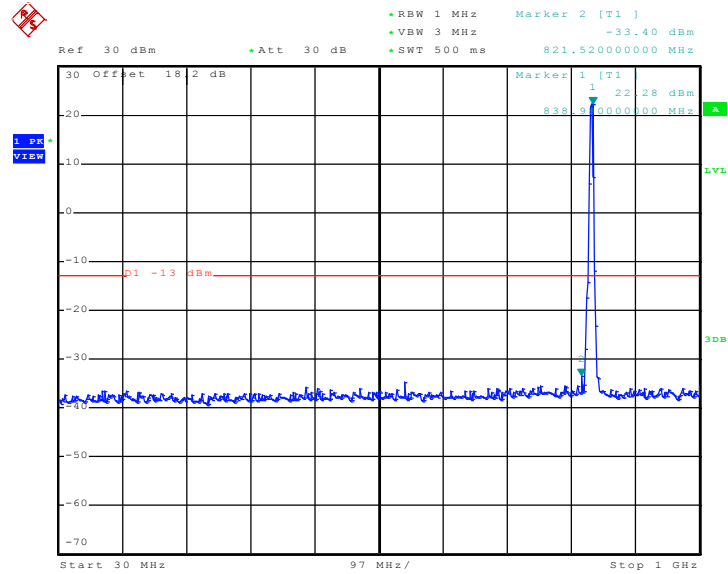

Date: 25.OCT.2008 03:49:46

Conducted Emission Plot between 1GHz ~ 3GHz

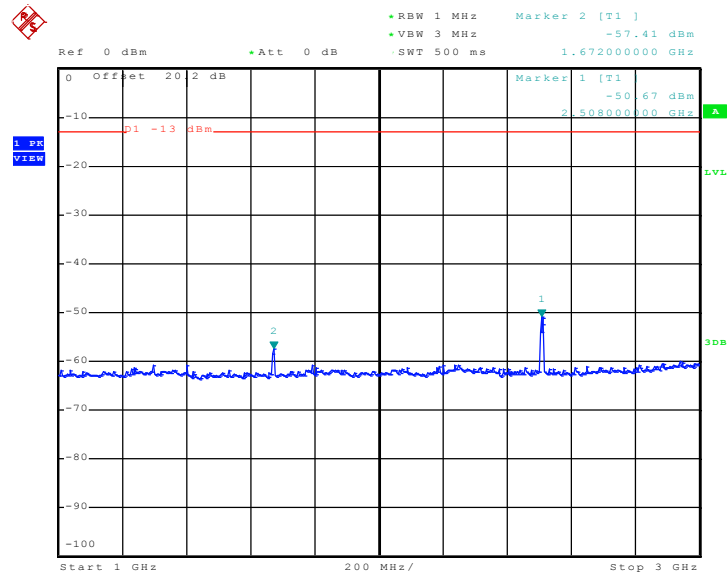

Date: 25.OCT.2008 03:53:30



Conducted Emission Plot between 3GHz ~ 7GHz

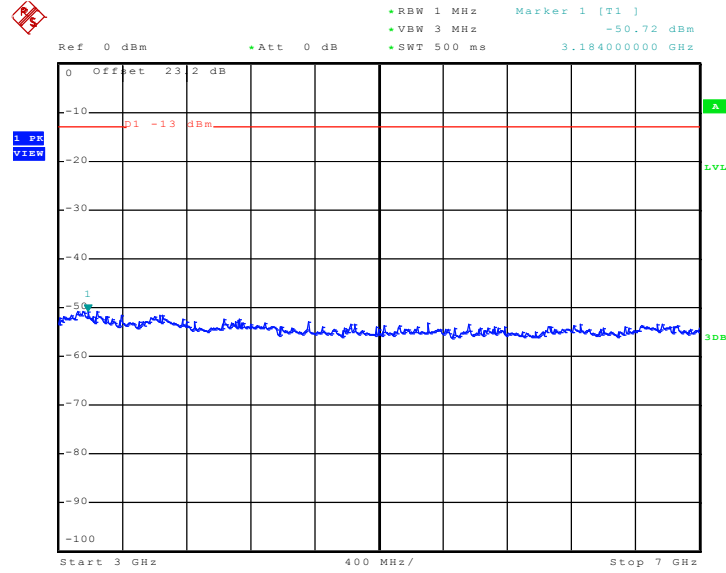

Date: 25.OCT.2008 03:55:29

Conducted Emission Plot between 7GHz ~ 9GHz

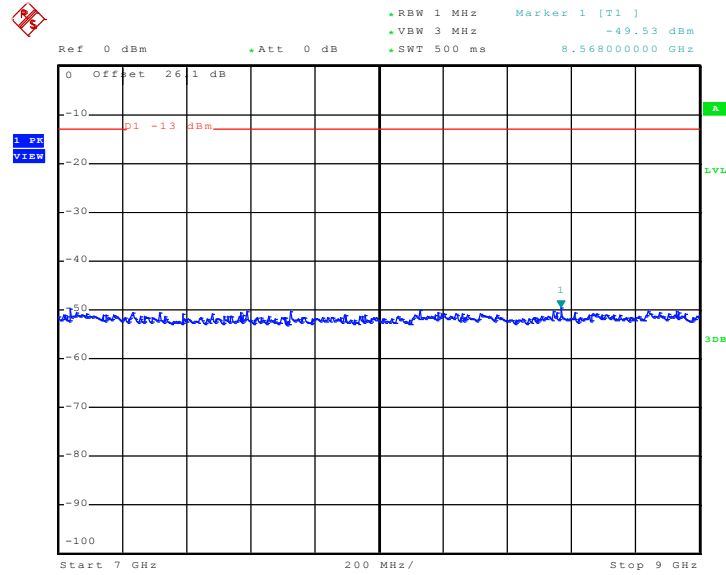

Date: 25.OCT.2008 03:55:59



Band :	WCDMA Band II	Channel :	CH9400
Test Mode :	HSDPA Link		

Conducted Emission Plot between 30M-1G

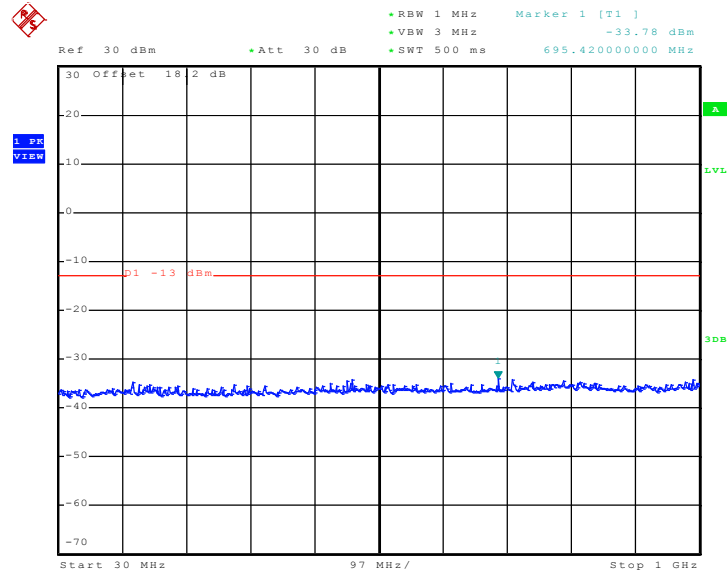

Date: 25.OCT.2008 04:01:28

Conducted Emission Plot between 1GHz ~ 3GHz

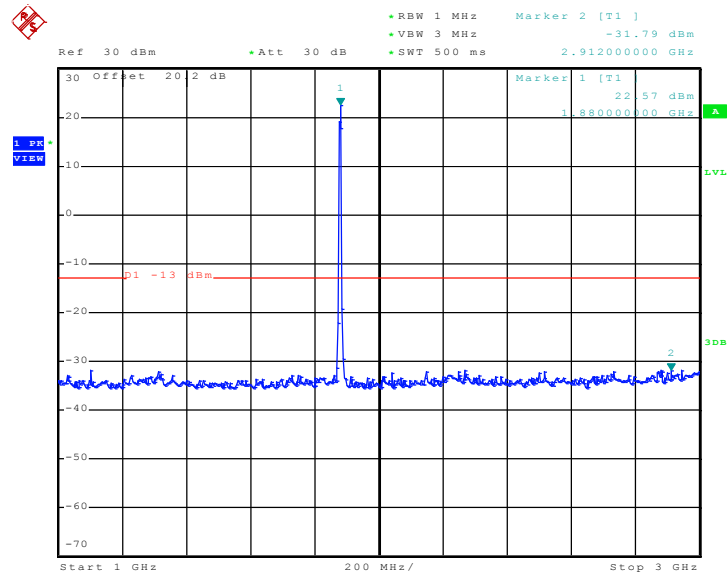

Date: 25.OCT.2008 04:00:48



Conducted Emission Plot between 3G-7G

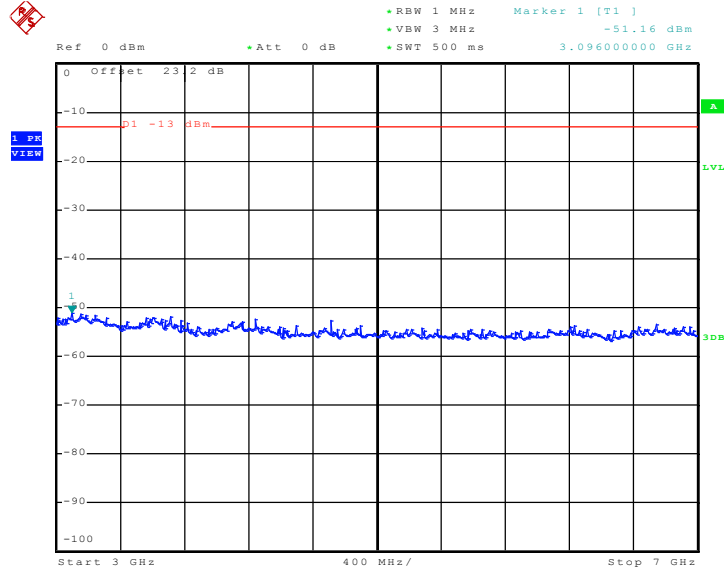

Date: 25.OCT.2008 03:59:00

Conducted Emission Plot between 7G-13.6G

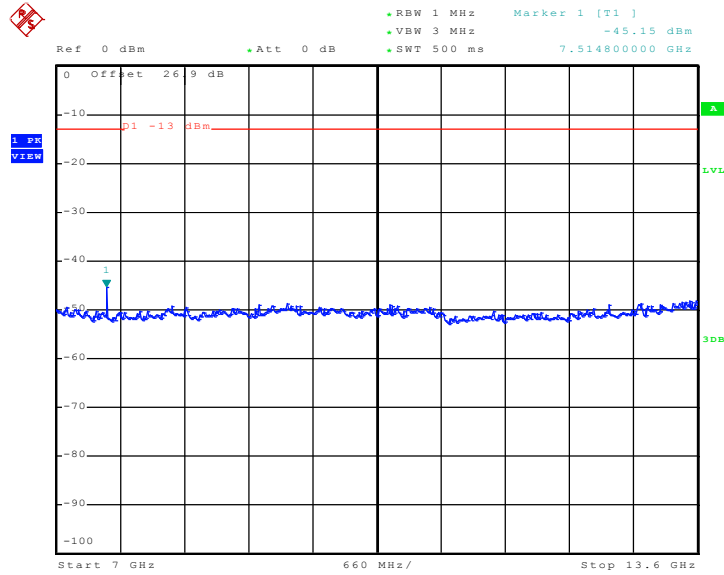

Date: 25.OCT.2008 03:58:33



Conducted Emission Plot between 13.6G-19.1G

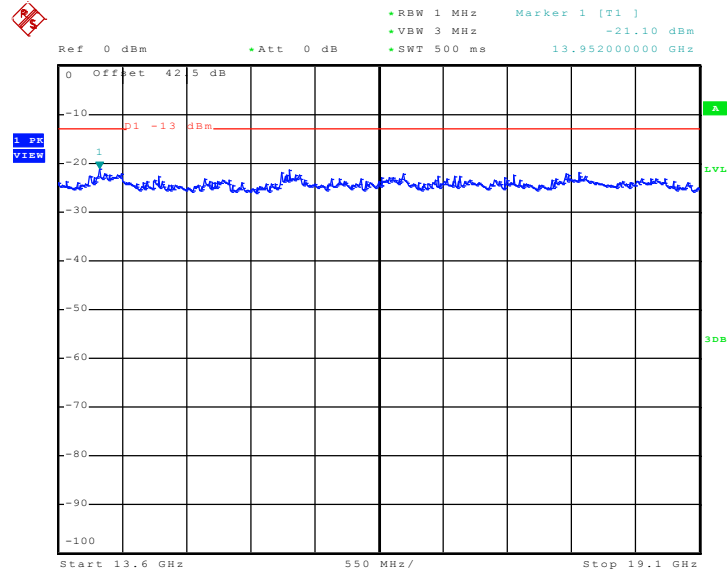

Date: 25.OCT.2008 03:57:14

3.5 Field Strength of Spurious Radiation Measurement

3.5.1 Description of Field Strength of Spurious Radiated Measurement

The radiated spurious emission was measured by substitution method according to ANSI / TIA / EIA-603-C-2004. The power of any emission outside of the authorized operating frequency ranges must be attenuated below the transmitter power (P) by a factor of at least $43 + 10 \log (P)$ dB. The spectrum is scanned from 30 MHz up to a frequency including its 10th harmonic.

3.5.2 Measuring Instruments

See list of measuring instruments of this test report.

3.5.3 Test Procedures

1. The EUT was placed on a rotatable wooden table with 0.8 meter about ground.
2. The EUT was set 3 meters from the receiving antenna, which was mounted on the antenna tower.
3. The table was rotated 360 degrees to determine the position of the highest spurious emission.
4. The height of the receiving antenna is varied between one meter and four meters to search the maximum spurious emission for both horizontal and vertical polarizations.
5. Taking the record of maximum spurious emission.
6. A horn antenna was substituted in place of the EUT and was driven by a signal generator.
7. Tune the output power of signal generator to the same emission level with EUT maximum spurious emission.
8. Taking the record of output power at antenna port.
9. Repeat step 7 to step 8 for another polarization.
10. Emission level (dBm) = output power + substitution Gain.

3.5.4 Test Setup

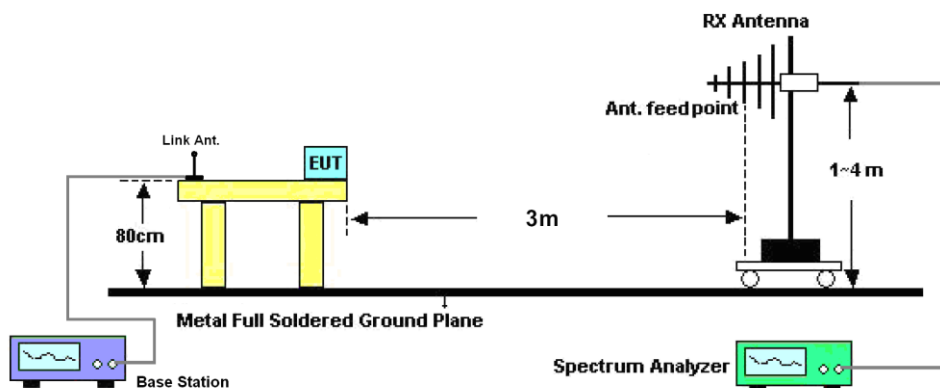



3.5.5 Test Result of Field Strength of Spurious Radiated

Band :	GSM850	Temperature :	26~28°C
Test Mode :	GPRS Link	Relative Humidity :	52~54%
Test Engineer :	Kay Wu	Polarization :	Horizontal
Remark :	Spurious emissions within 30-1000MHz were found more than 20dB below limit line.		

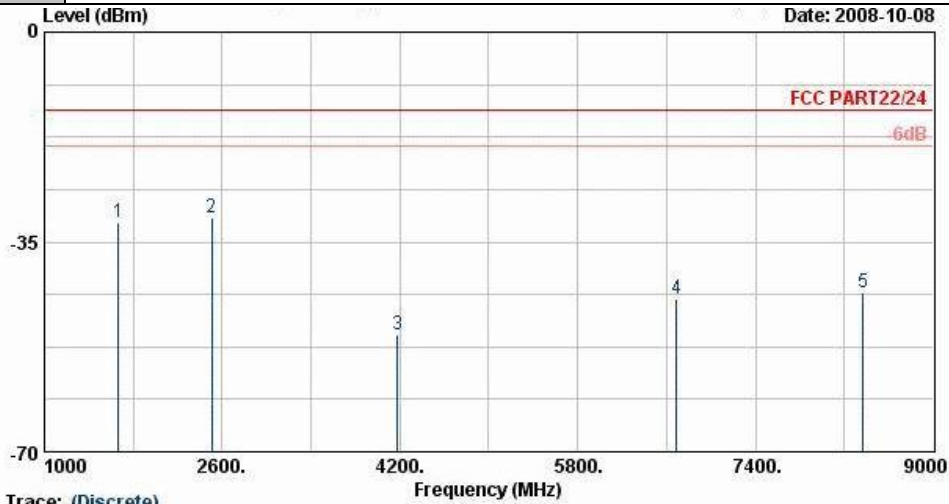

Trace: (Discrete)
 Site : 03CH07-HY
 Condition : HF-EIRP(080306) HORIZONTAL
 Model : FG800405

Frequency (MHz)	ERP (dBm)	Limit (dBm)	Over Limit (dB)	SPA Reading (dBm)	S.G. Power (dBm)	TX Cable loss (dB)	TX Antenna Gain (dBi)	Polarization (H/V)	Result
1669	-31.77	-13	-18.77	-40.17	-30.78	3.39	4.55	H	Pass
2509	-30.89	-13	-17.89	-39.55	-30.95	3.71	5.92	H	Pass
4175	-50.49	-13	-37.49	-63.59	-52.9	3.01	7.57	H	Pass
6690	-44.41	-13	-31.41	-66.22	-46.6	5.22	9.56	H	Pass
8370	-43.42	-13	-30.42	-65.24	-46.16	5.59	10.48	H	Pass



Band :	GSM850	Temperature :	26~28°C
Test Mode :	GPRS Link	Relative Humidity :	52~54%
Test Engineer :	Kay Wu	Polarization :	Vertical
Remark :	Spurious emissions within 30-1000MHz were found more than 20dB below limit line.		

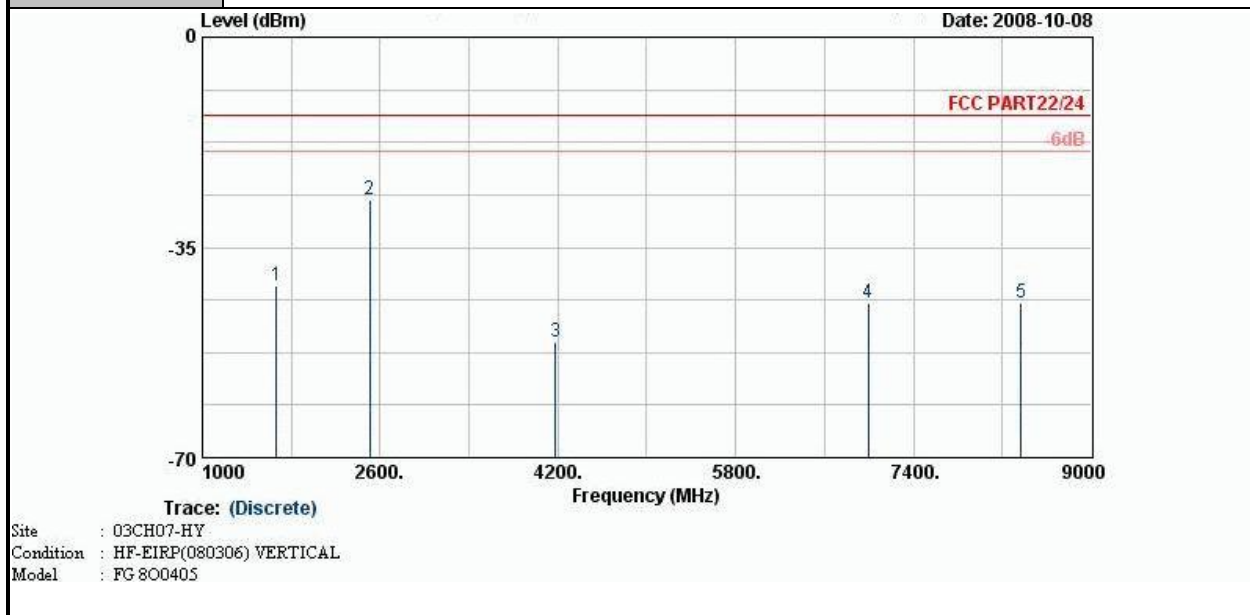

Frequency (MHz)	ERP (dBm)	Limit (dBm)	Over Limit (dB)	SPA Reading (dBm)	S.G. Power (dBm)	TX Cable loss (dB)	TX Antenna Gain (dBi)	Polarization (H/V)	Result
1669	-41.45	-13	-28.45	-47.1	-40.07	3.39	4.16	V	Pass
2506	-27.12	-13	-14.12	-39.03	-26.98	3.71	5.72	V	Pass
4175	-50.63	-13	-37.63	-64.56	-53.75	3.01	8.28	V	Pass
6990	-44.29	-13	-31.29	-66.69	-47.54	5.22	10.62	V	Pass
8370	-44.15	-13	-31.15	-65.73	-47.77	5.59	11.36	V	Pass



Band :	GSM850	Temperature :	26~28°C
Test Mode :	EDGE Link	Relative Humidity :	52~54%
Test Engineer :	Kay Wu	Polarization :	Horizontal
Remark :	Spurious emissions within 30-1000MHz were found more than 20dB below limit line.		

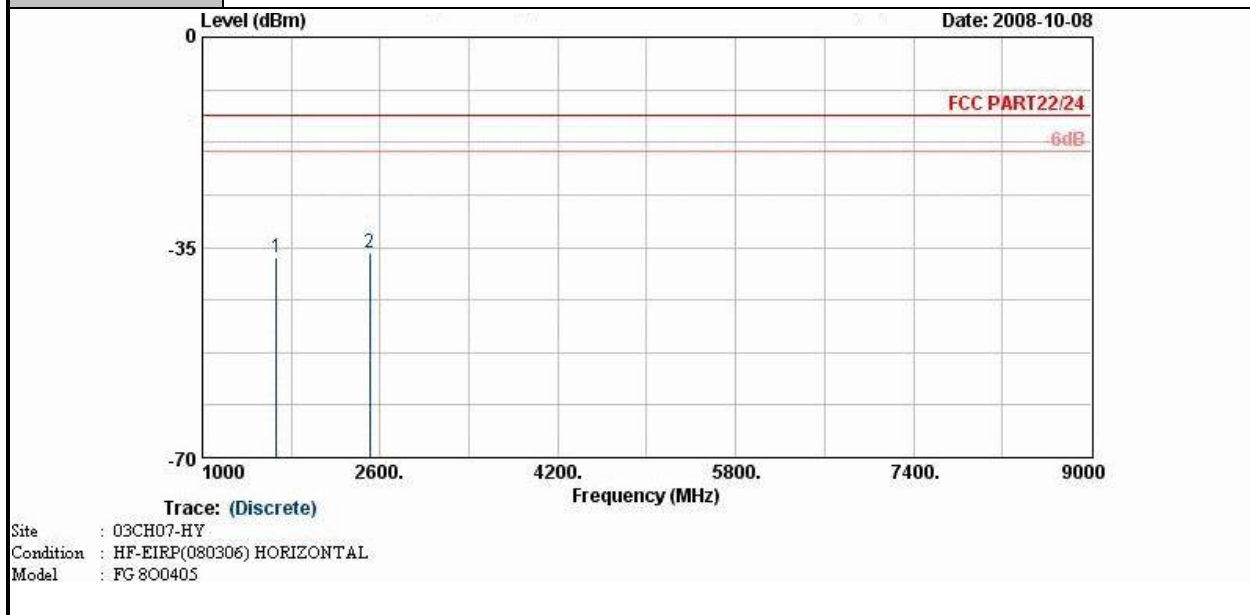

Frequency (MHz)	ERP (dBm)	Limit (dBm)	Over Limit (dB)	SPA Reading (dBm)	S.G. Power (dBm)	TX Cable loss (dB)	TX Antenna Gain (dBi)	Polarization (H/V)	Result
1669	-36.80	-13	-23.80	-45.35	-35.81	3.39	4.55	H	Pass
2509	-36.00	-13	-23.00	-44.43	-36.06	3.71	5.92	H	Pass



Band :	GSM850	Temperature :	26~28°C
Test Mode :	EDGE Link	Relative Humidity :	52~54%
Test Engineer :	Kay Wu	Polarization :	Vertical
Remark :	Spurious emissions within 30-1000MHz were found more than 20dB below limit line.		

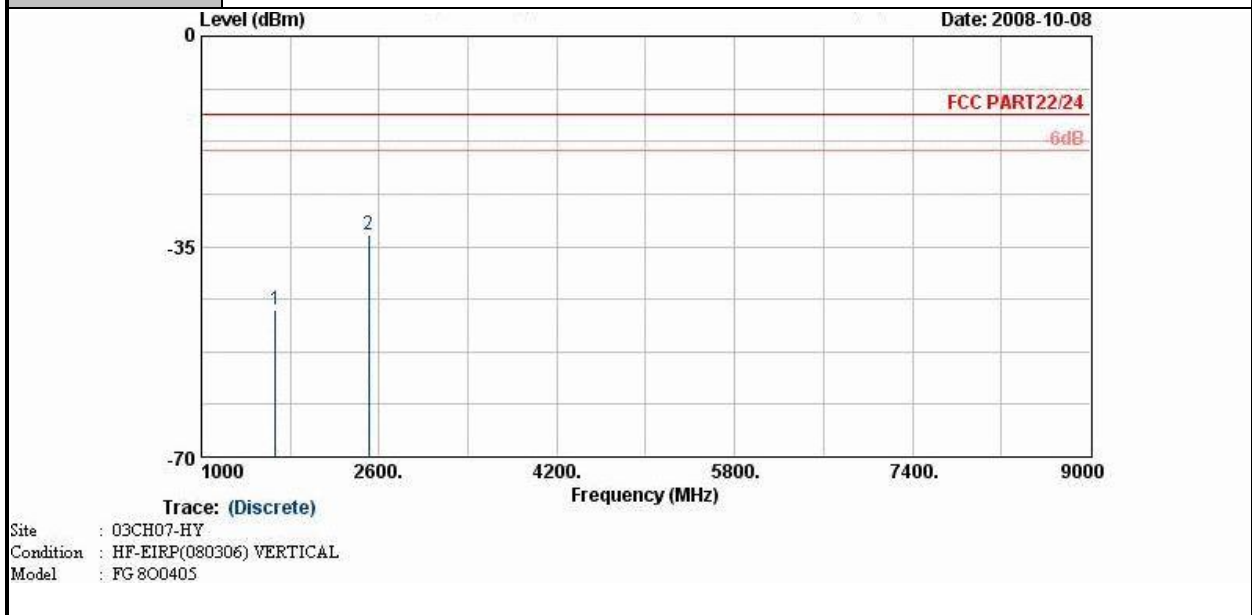

Frequency (MHz)	ERP (dBm)	Limit (dBm)	Over Limit (dB)	SPA Reading (dBm)	S.G. Power (dBm)	TX Cable loss (dB)	TX Antenna Gain (dBi)	Polarization (H/V)	Result
1669	-45.46	-13	-32.46	-50.85	-44.08	3.39	4.16	V	Pass
2509	-32.98	-13	-19.98	-44.61	-32.84	3.71	5.72	V	Pass



Band :	GSM1900	Temperature :	26~28°C
Test Mode :	GPRS Link	Relative Humidity :	52~54%
Test Engineer :	Kay Wu	Polarization :	Horizontal
Remark :	Spurious emissions within 30-1000MHz were found more than 20dB below limit line.		

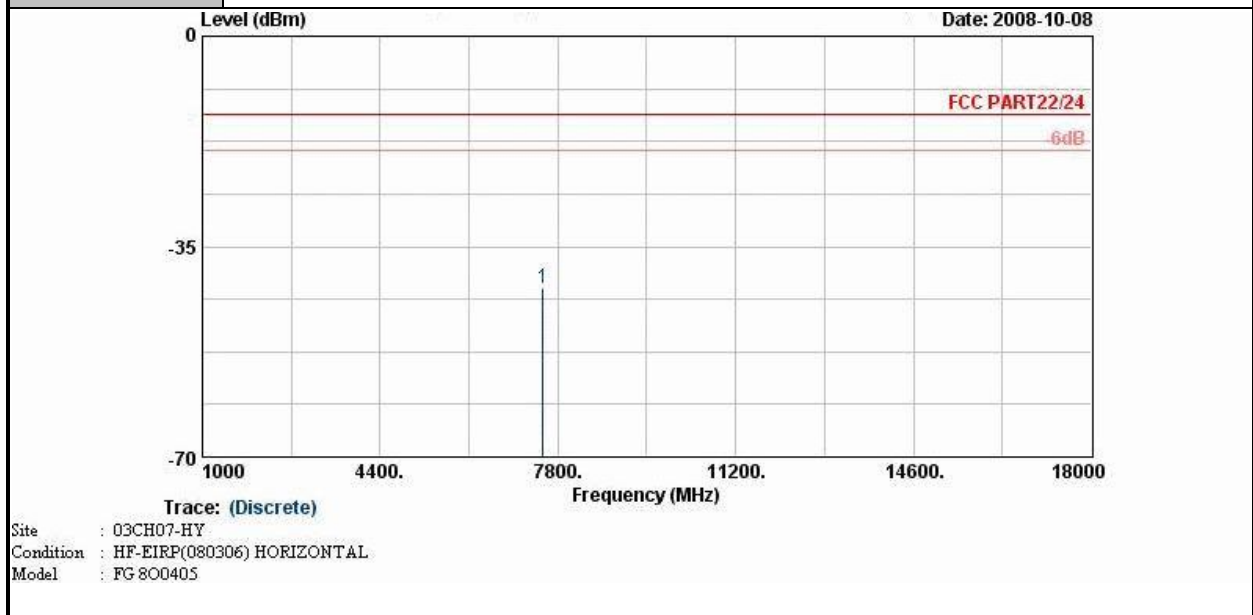

Frequency (MHz)	EIRP (dBm)	Limit (dBm)	Over Limit (dB)	SPA Reading (dBm)	S.G. Power (dBm)	TX Cable loss (dB)	TX Antenna Gain (dBi)	Polarization (H/V)	Result
7520	-41.89	-13	-28.89	-63.51	-45.77	5.83	9.71	H	Pass



Band :	GSM1900	Temperature :	26~28°C
Test Mode :	GPRS Link	Relative Humidity :	52~54%
Test Engineer :	Kay Wu	Polarization :	Vertical
Remark :	Spurious emissions within 30-1000MHz were found more than 20dB below limit line.		

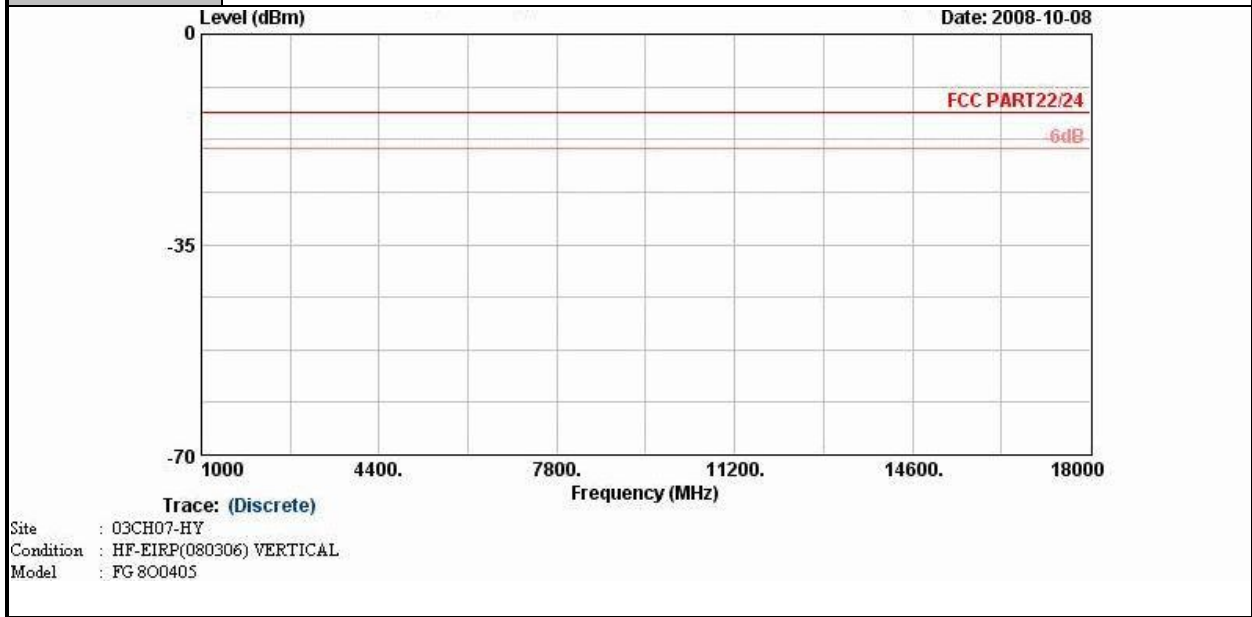



Band :	GSM1900	Temperature :	26~28°C
Test Mode :	EDGE Link	Relative Humidity :	52~54%
Test Engineer :	Kay Wu	Polarization :	Horizontal
Remark :	Spurious emissions within 30-1000MHz were found more than 20dB below limit line.		

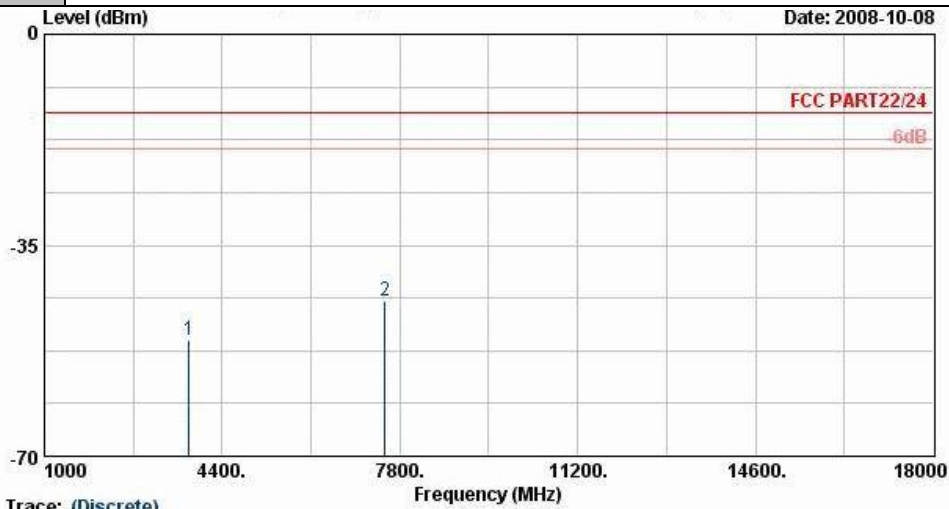

Site : 09CH07-HY
 Condition : HF-EIRP(080306) HORIZONTAL
 Model : FG 800405

Frequency (MHz)	EIRP (dBm)	Limit (dBm)	Over Limit (dB)	SPA Reading (dBm)	S.G. Power (dBm)	TX Cable loss (dB)	TX Antenna Gain (dBi)	Polarization (H/V)	Result
3760	-50.77	-13	-37.77	-65.12	-54.14	4.03	7.40	H	Pass
7520	-44.27	-13	-31.27	-65.18	-48.15	5.83	9.71	H	Pass



Band :	GSM1900	Temperature :	26~28°C
Test Mode :	EDGE Link	Relative Humidity :	52~54%
Test Engineer :	Kay Wu	Polarization :	Vertical
Remark :	Spurious emissions within 30-1000MHz were found more than 20dB below limit line.		

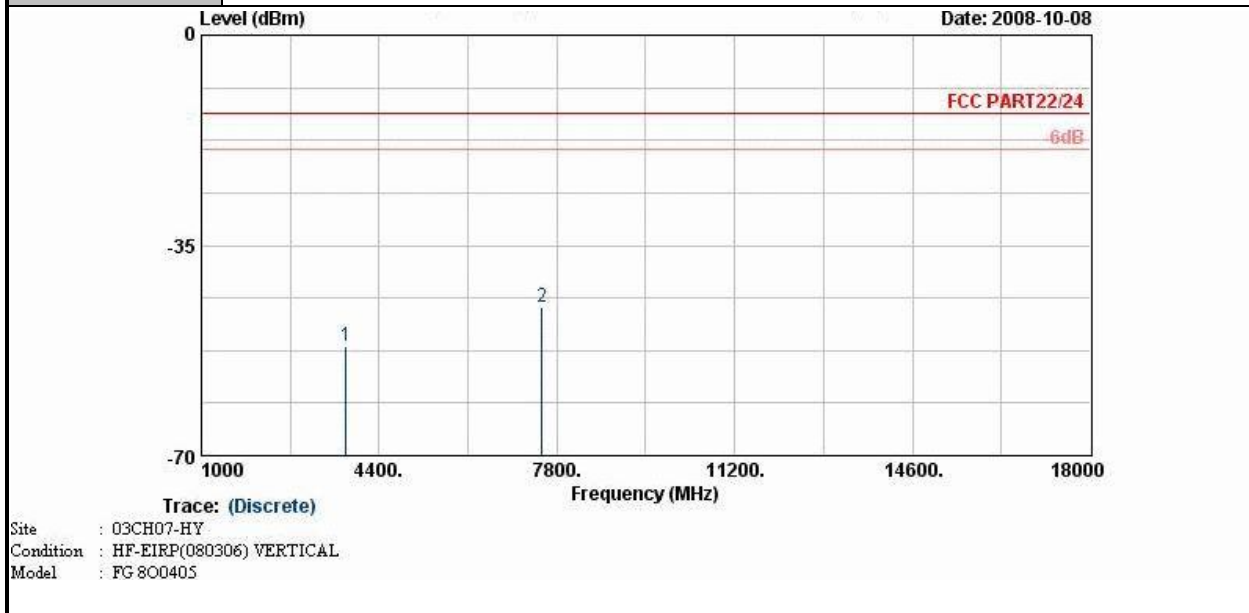

Frequency (MHz)	EIRP (dBm)	Limit (dBm)	Over Limit (dB)	SPA Reading (dBm)	S.G. Power (dBm)	TX Cable loss (dB)	TX Antenna Gain (dBi)	Polarization (H/V)	Result
3760	-51.85	-13	-38.85	-65.02	-55.73	4.03	7.91	V	Pass
7520	-45.31	-13	-32.31	-66.01	-50.29	5.83	10.81	V	Pass



Band :	WCDMA Band V	Temperature :	26~28°C
Test Mode :	HSDPA Link	Relative Humidity :	52~54%
Test Engineer :	Kay Wu	Polarization :	Horizontal
Remark :	Spurious emissions within 30-1000MHz were found more than 20dB below limit line.		

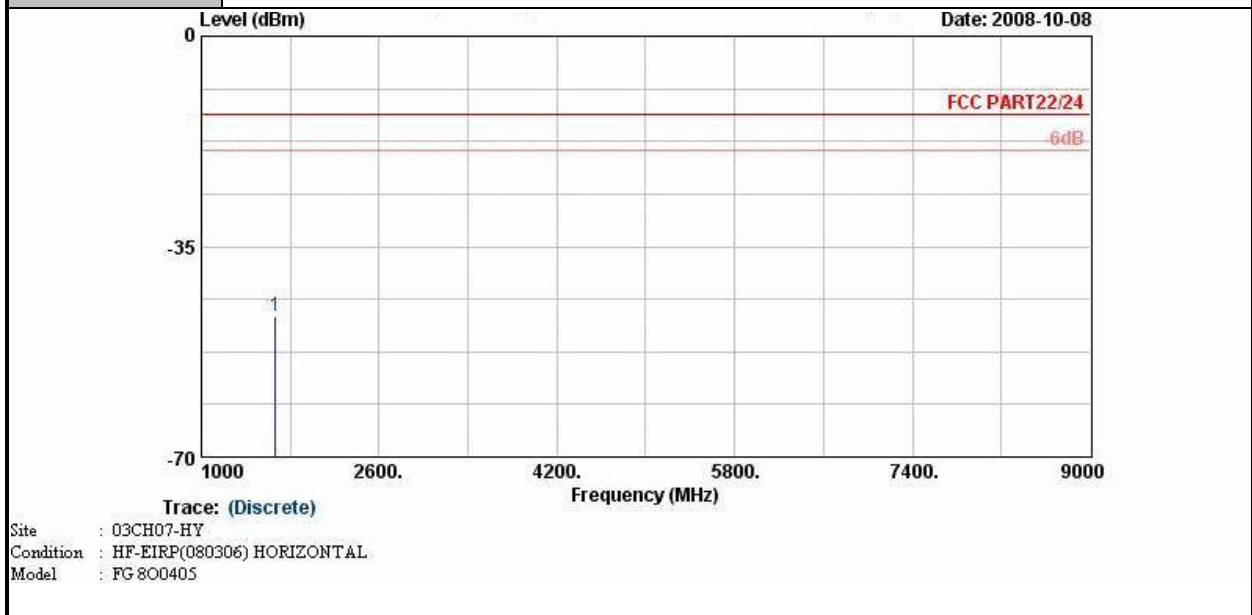

Frequency (MHz)	ERP (dBm)	Limit (dBm)	Over Limit (dB)	SPA Reading (dBm)	S.G. Power (dBm)	TX Cable loss (dB)	TX Antenna Gain (dBi)	Polarization (H/V)	Result
1669	-47.85	-13	-34.85	-54.35	-46.86	3.39	4.55	H	Pass



Band :	WCDMA Band V	Temperature :	26~28°C
Test Mode :	HSDPA Link	Relative Humidity :	52~54%
Test Engineer :	Kay Wu	Polarization :	Vertical
Remark :	Spurious emissions within 30-1000MHz were found more than 20dB below limit line.		

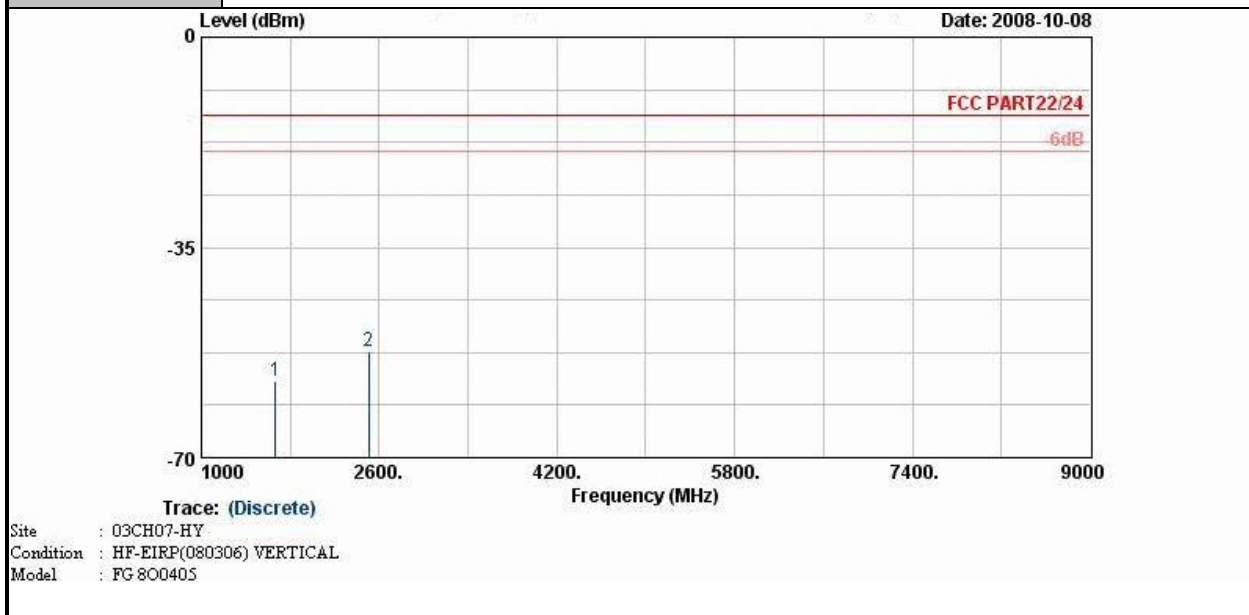

Frequency (MHz)	ERP (dBm)	Limit (dBm)	Over Limit (dB)	SPA Reading (dBm)	S.G. Power (dBm)	TX Cable loss (dB)	TX Antenna Gain (dBi)	Polarization (H/V)	Result
1669	-57.13	-13	-44.13	-59.71	-55.75	3.39	4.16	V	Pass
2509	-52.36	-13	-39.36	-62.95	-52.22	3.71	5.72	V	Pass



Band :	WCDMA Band II	Temperature :	26~28°C
Test Mode :	HSDPA Link	Relative Humidity :	52~54%
Test Engineer :	Kay Wu	Polarization :	Horizontal
Remark :	Spurious emissions within 30-1000MHz were found more than 20dB below limit line.		

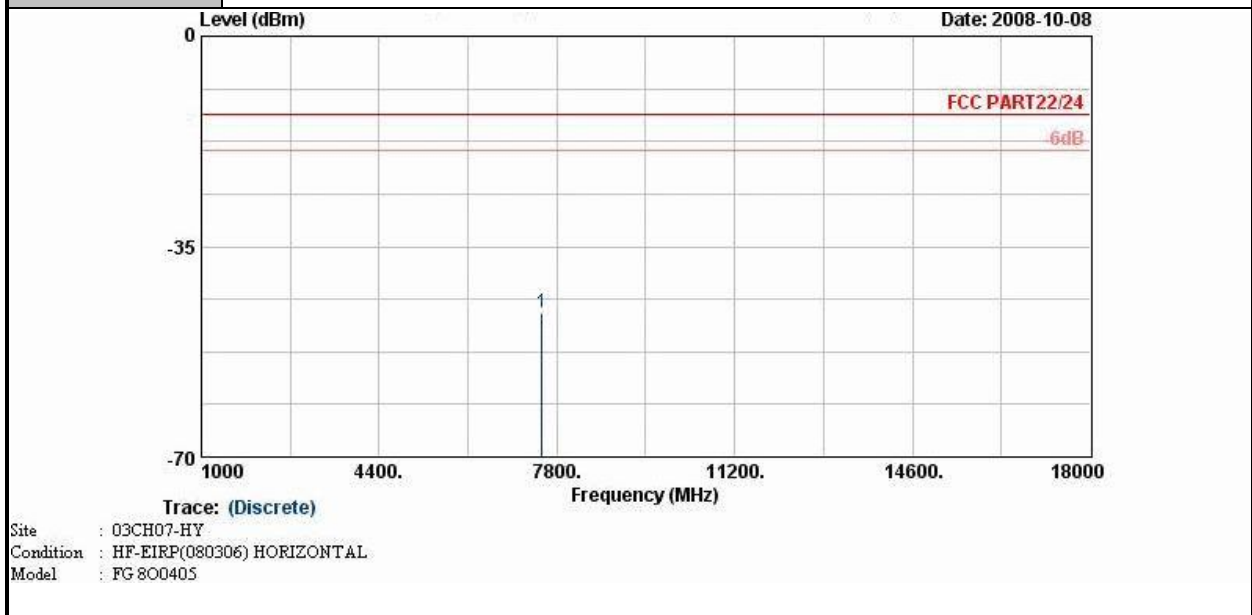

Frequency (MHz)	EIRP (dBm)	Limit (dBm)	Over Limit (dB)	SPA Reading (dBm)	S.G. Power (dBm)	TX Cable loss (dB)	TX Antenna Gain (dBi)	Polarization (H/V)	Result
7520	-45.93	-13	-32.93	-66.2	-49.81	5.83	9.71	H	Pass



Band :	WCDMA Band II	Temperature :	26~28°C
Test Mode :	HSDPA Link	Relative Humidity :	52~54%
Test Engineer :	Kay Wu	Polarization :	Vertical
Remark :	Spurious emissions within 30-1000MHz were found more than 20dB below limit line.		

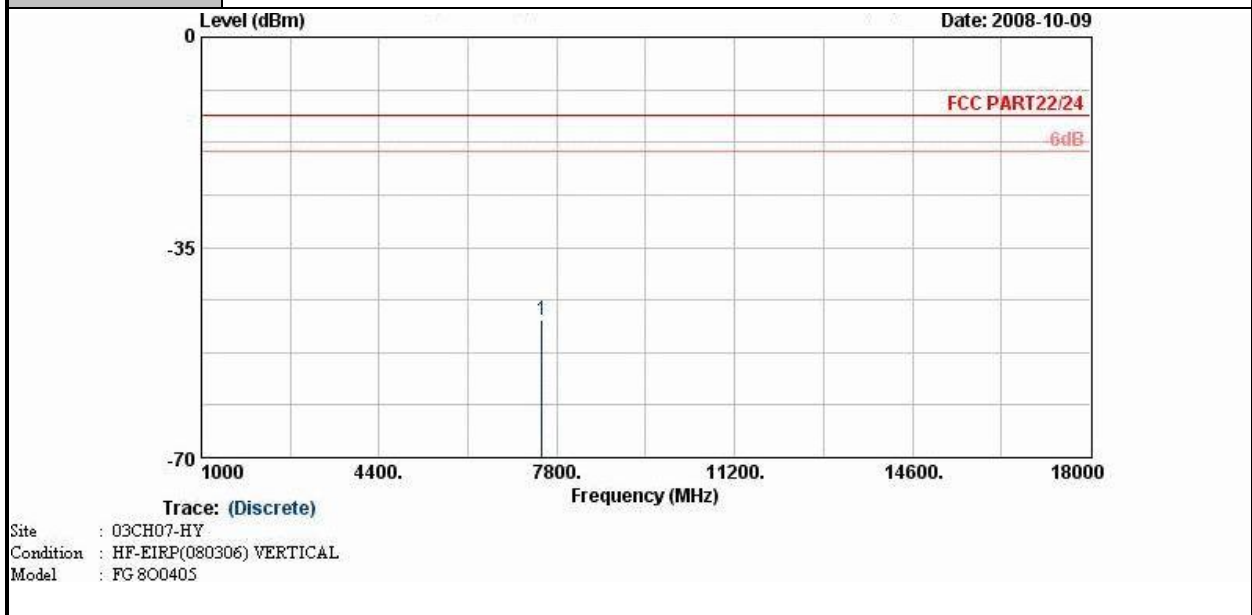

Frequency (MHz)	EIRP (dBm)	Limit (dBm)	Over Limit (dB)	SPA Reading (dBm)	S.G. Power (dBm)	TX Cable loss (dB)	TX Antenna Gain (dBi)	Polarization (H/V)	Result
7520	-47.00	-13	-34.00	-66.88	-51.98	5.83	10.81	V	Pass

3.6 Frequency Stability Measurement

3.6.1 Description of Frequency Stability Measurement

The frequency stability shall be measured by variation of ambient temperature and variation of primary supply voltage to ensure that the fundamental emission stays within the authorized frequency block. The frequency stability of the transmitter shall be maintained within $\pm 0.00025\%$ ($\pm 2.5\text{ppm}$) of the center frequency.

3.6.2 Measuring Instruments

See list of measuring instruments of this test report.

3.6.3 Test Procedures for Temperature Variation

1. The EUT was set up in the thermal chamber and connected with the base station.
2. With power OFF, the temperature was decreased to -30°C and the EUT was stabilized for three hours. Power was applied and the maximum change in frequency was recorded within one minute.
3. With power OFF, the temperature was raised in 10°C step up to 50°C . The EUT was stabilized at each step for at least half an hour. Power was applied and the maximum frequency change was recorded within one minute.
4. If the EUT can not be turned on at -30°C , the testing lowest temperature will be raised in 10°C step until the EUT can be turned on.

3.6.4 Test Procedures for Voltage Variation

1. The EUT was placed in a temperature chamber at $25\pm 5^{\circ}\text{C}$ and connected with the base station.
2. The power supply voltage to the EUT was varied from BEP to 115% of the nominal value measured at the input to the EUT.
3. The variation in frequency was measured for the worst case.

3.6.5 Test Setup

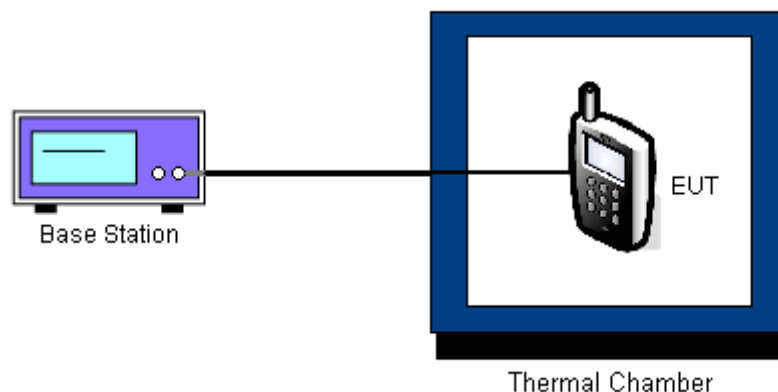



3.6.6 Test Result of Temperature Variation

Band :	GSM 850	Channel :	189
Limit (ppm) :	2.5		

Temperature (°C)	GSM		EDGE		Result
	Freq. Dev. (Hz)	Deviation (ppm)	Freq. Dev. (Hz)	Deviation (ppm)	
0	34	0.04	-20	-0.02	PASS
10	33	0.04	-18	-0.02	
20	30	0.04	-29	-0.03	
30	33	0.04	-47	-0.06	
40	35	0.04	-48	-0.06	
50	38	0.04	-46	-0.05	
60	41	0.05	-40	-0.05	

Band :	GSM 1900	Channel :	661
Limit (ppm) :	2.5		

Temperature (°C)	GSM		EDGE		Result
	Freq. Dev. (Hz)	Deviation (ppm)	Freq. Dev. (Hz)	Deviation (ppm)	
0	48	0.03	15	0.01	PASS
10	49	0.03	25	0.01	
20	51	0.03	34	0.02	
30	45	0.02	30	0.02	
40	56	0.03	38	0.02	
50	44	0.02	46	0.02	
60	31	0.02	53	0.03	



Band :	WCDMA Band V	Channel :	4182
Limit (ppm) :	2.5		

Temperature (°C)	HSDPA		Result
	Freq. Dev. (Hz)	Deviation (ppm)	
0	13	0.02	PASS
10	27	0.03	
20	23	0.03	
30	39	0.05	
40	40	0.05	
50	46	0.05	
60	53	0.06	

Band :	WCDMA Band II	Channel :	9400
Limit (ppm) :	2.5		

Temperature (°C)	HSDPA		Result
	Freq. Dev. (Hz)	Deviation (ppm)	
0	26	0.01	PASS
10	42	0.02	
20	47	0.02	
30	56	0.03	
40	35	0.02	
50	48	0.03	
60	53	0.03	

3.6.7 Test Result of Voltage Variation

Band & Channel	Mode	Voltage (Volt)	Freq. Dev. (Hz)	Deviation (ppm)	Limit (ppm)	Result
GSM 850 CH189	GSM	3.7	30	0.04	2.5	PASS
		BEP	22	0.03		
		4.2	32	0.04		
	EDGE	3.7	-29	-0.03		
		BEP	40	0.05		
		4.2	-47	-0.06		
GSM 1900 CH661	GSM	3.7	51	0.03		
		BEP	57	0.03		
		4.2	48	0.03		
	EDGE	3.7	34	0.02		
		BEP	33	0.02		
		4.2	27	0.01		
WCDMA Band V CH4182	HSDPA	3.7	23	0.03		
		BEP	18	0.02		
		4.2	26	0.03		
WCDMA Band II CH9400	HSDPA	3.7	47	0.02		
		BEP	56	0.03		
		4.2	40	0.02		

Remark:

1. Normal Voltage = 3.7V.
2. Battery End Point (BEP) = 3.3 V.



4 List of Measuring Equipments

Instrument	Manufacturer	Model No.	Serial No.	Characteristics	Calibration Date	Due Date	Remark
Base Station	R&S	CMU200	116456	N/A	Jun. 05, 2008	Jun. 04, 2009	Conducted (TH02-HY)
Spectrum Analyzer	R&S	FSP40	100055	9KHz~40GHz	Jun. 26, 2008	Jun. 25, 2009	Conducted (TH02-HY)
Thermal Chamber	Ten Billion	TTH-D35P	TBN-930701	N/A	Aug. 01, 2008	Jul. 31, 2009	Conducted (TH02-HY)
Bilog Antenna	SCHAFFNER	CBL6111C	2726	30MHz ~ 1GHz	Dec. 01, 2007	Nov. 30, 2008	Radiation (03CH07-HY)
Spectrum Analyzer	R & S	FSP	101067	9KHz ~ 30GHz	Dec. 05, 2007	Dec. 04, 2008	Radiation (03CH07-HY)
Double Ridge Horn Antenna	ESCO	3117	75962	1G ~ 18GHz	Aug. 13, 2008	Aug. 12, 2009	Radiation (03CH07-HY)
Pre Amplifier	Agilent	8449B	3008A02362	1 ~ 26.5GHz	Dec. 22, 2007	Dec. 21, 2008	Radiation (03CH07-HY)
Pre Amplifier	COM-POWER	PA-103A	161241	10-1000MHz.32dB GAIN	Mar. 31, 2008	Mar. 30, 2009	Radiation (03CH07-HY)
Double Ridge Horn Antenna	ESCO	3117	66584	1G ~ 18GHz	Aug. 06, 2008	Aug. 05, 2009	Radiation (03CH07-HY)

5 Uncertainty of Evaluation

Uncertainty of Conducted Emission Measurement (150 KHz ~ 30 MHz)

Contribution	Uncertainty of x_i		$u(x_i)$
	dB	Probability Distribution	
Receiver reading	0.10	Normal(k=2)	0.05
Cable loss	0.10	Normal(k=2)	0.05
AMN insertion loss	2.50	Rectangular	0.63
Receiver Spec	1.50	Rectangular	0.43
Site imperfection	1.39	Rectangular	0.80
Mismatch	+0.34/-0.35	U-shape	0.24
Combined standard uncertainty Uc(y)	1.13		
Measuring uncertainty for a level of confidence of 95% U=2Uc(y)	2.26		

Uncertainty of Radiated Emission Measurement (30 MHz ~ 1000 MHz)

Contribution	Uncertainty of x_i		$u(x_i)$
	dB	Probability Distribution	
Receiver reading	0.41	Normal(k=2)	0.21
Antenna factor calibration	0.83	Normal(k=2)	0.42
Cable loss calibration	0.25	Normal(k=2)	0.13
Pre Amplifier Gain calibration	0.27	Normal(k=2)	0.14
RCV/SPA specification	2.50	Rectangular	0.72
Antenna Factor Interpolation for Frequency	1.00	Rectangular	0.29
Site imperfection	1.43	Rectangular	0.83
Mismatch	+0.39/-0.41	U-shaped	0.28
Combined standard uncertainty Uc(y)	1.27		
Measuring uncertainty for a level of confidence of 95% U=2Uc(y)	2.54		



Uncertainty of Radiated Emission Measurement (1 GHz ~ 40 GHz)

Contribution	Uncertainty of x_i		$u(x_i)$	C_i	$C_i * u(x_i)$
	dB	Probability Distribution			
Receiver reading	±0.10	Normal(k=1)	0.10	1	0.10
Antenna factor calibration	±1.70	Normal(k=2)	0.85	1	0.85
Cable loss calibration	±0.50	Normal(k=2)	0.25	1	0.25
Receiver Correction	±2.00	Rectangular	1.15	1	1.15
Antenna Factor Directional	±1.50	Rectangular	0.87	1	0.87
Site imperfection	±2.80	Triangular	1.14	1	1.14
Mismatch Receiver VSWR $\Gamma_1 = 0.197$ Antenna VSWR $\Gamma_2 = 0.194$ Uncertainty = $20 \log(1 - \Gamma_1 * \Gamma_2)$	+0.34/-0.35	U-shaped	0.244	1	0.244
Combined standard uncertainty Uc(y)	2.36				
Measuring uncertainty for a level of confidence of 95% U=2Uc(y)	4.72				

6 Certification of TAF Accreditation



Certificate No. : L1190-070110

財團法人全國認證基金會
Taiwan Accreditation Foundation

Certificate of Accreditation

This is to certify that

Sporton International Inc.
EMC & Wireless Communications Laboratory
No.52, Hwa Ya 1st Rd., Hwa Ya Technology Park, Kwei-Shan Hsiang, Tao Yuan Hsien,
Taiwan, R.O.C.

is accredited in respect of laboratory

Accreditation Criteria	: ISO/IEC 17025:2005
Accreditation Number	: 1190
Originally Accredited	: December 15, 2003
Effective Period	: January 10, 2007 to January 09, 2010
Accredited Scope	: Testing Field, see described in the Appendix Accreditation Program for Designated Testing Laboratory
Specific Accreditation Program	: for Commodities Inspection Accreditation Program for Telecommunication Equipment Testing Laboratory

Jay-San Chen

Jay-San Chen
President, Taiwan Accreditation Foundation
Date : January 10, 2007



PI, total 9 pages

The Appendix forms an integral part of this Certificate, which shall be invalid when used without the Appendix.



Appendix A. Photographs of EUT

Please refer to Sporton report number EP8O0405 as below.



1. External Photographs of EUT

Model Name: Juno SC





Model Name: Juno SC



Model Name: Juno SC





Model Name: Juno SC





Model Name: Juno SC



Model Name: Juno SC



2. Photographs of Accessories

Model Name: Juno SC





Model Name: Juno SC





Model Name: Juno SC



Model Name: Juno SC





Model Name: Juno SC

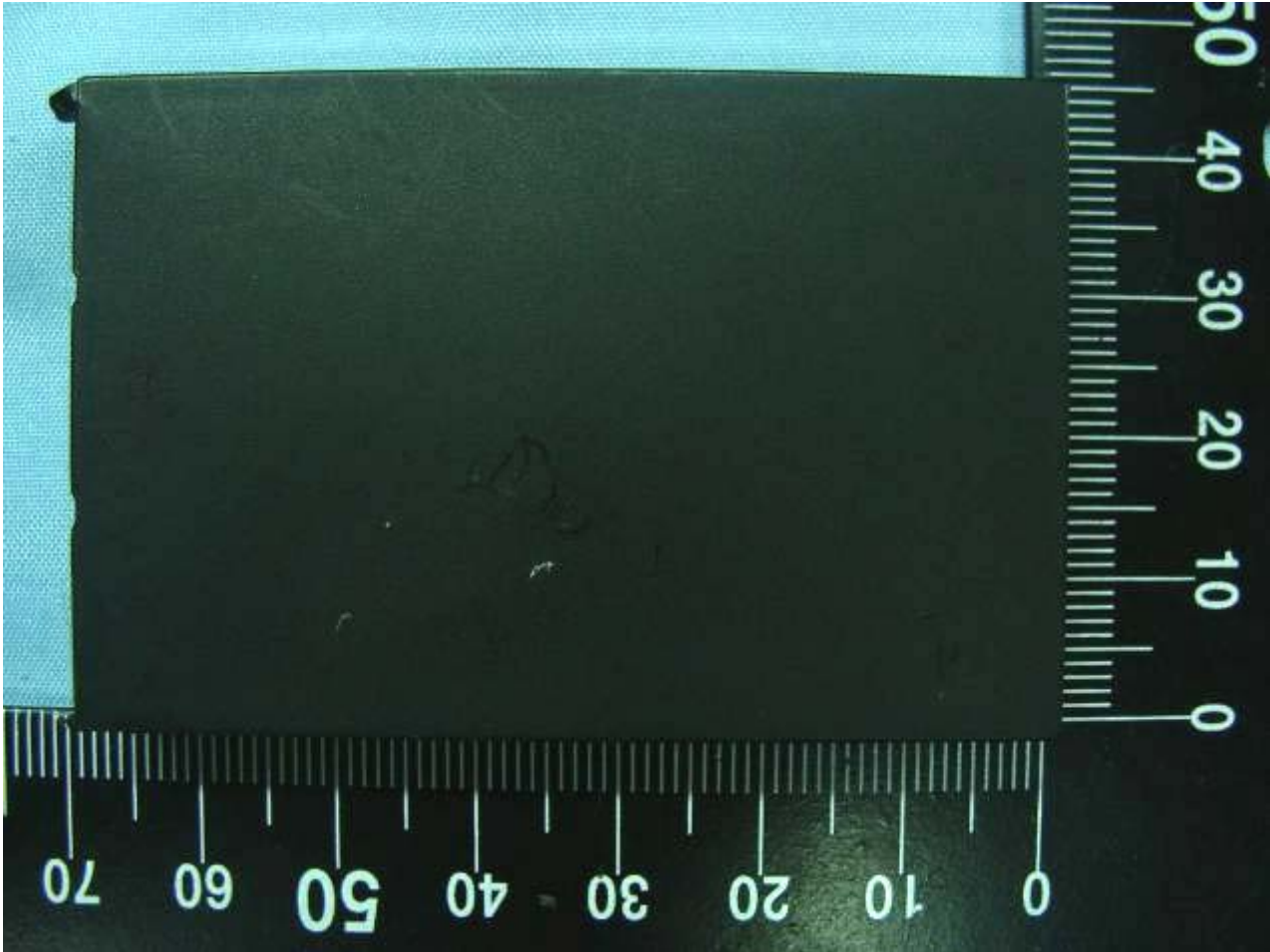

Model Name: Juno SC

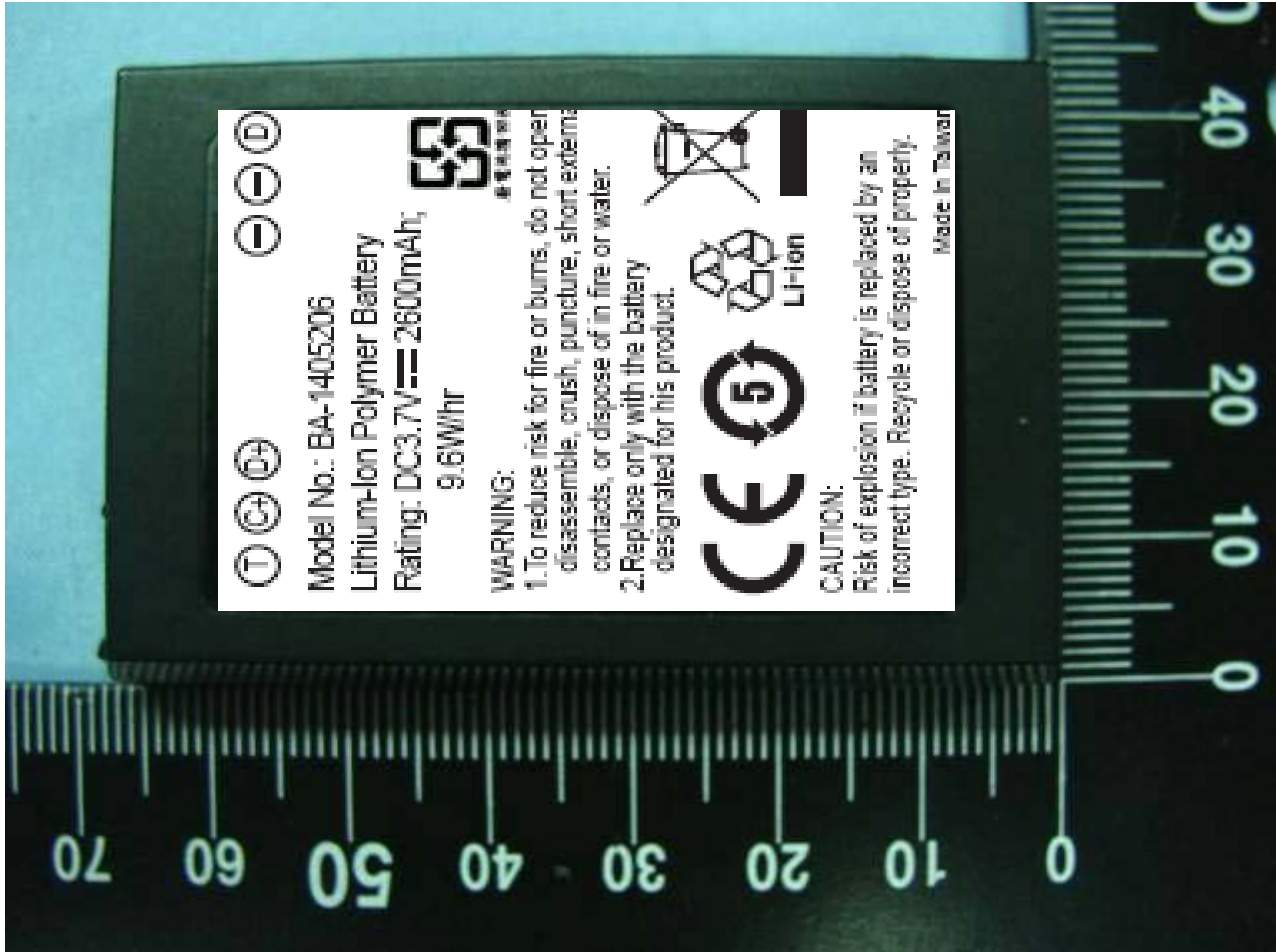

3. Internal Photographs of EUT

Model Name: Juno SC



Model Name: Juno SC



Model Name: Juno SC



Model Name: Juno SC



Model Name: Juno SC

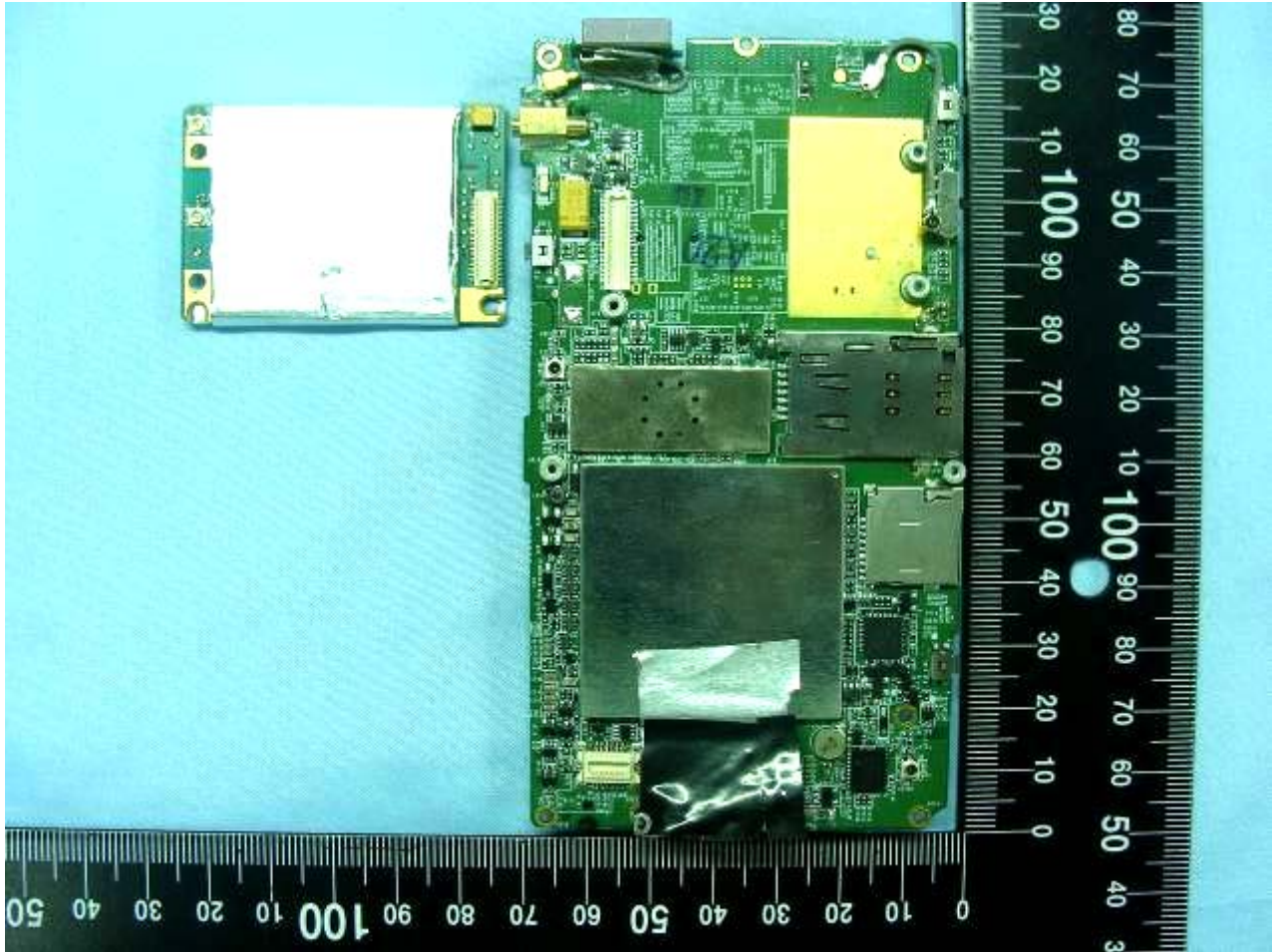

Model Name: Juno SC

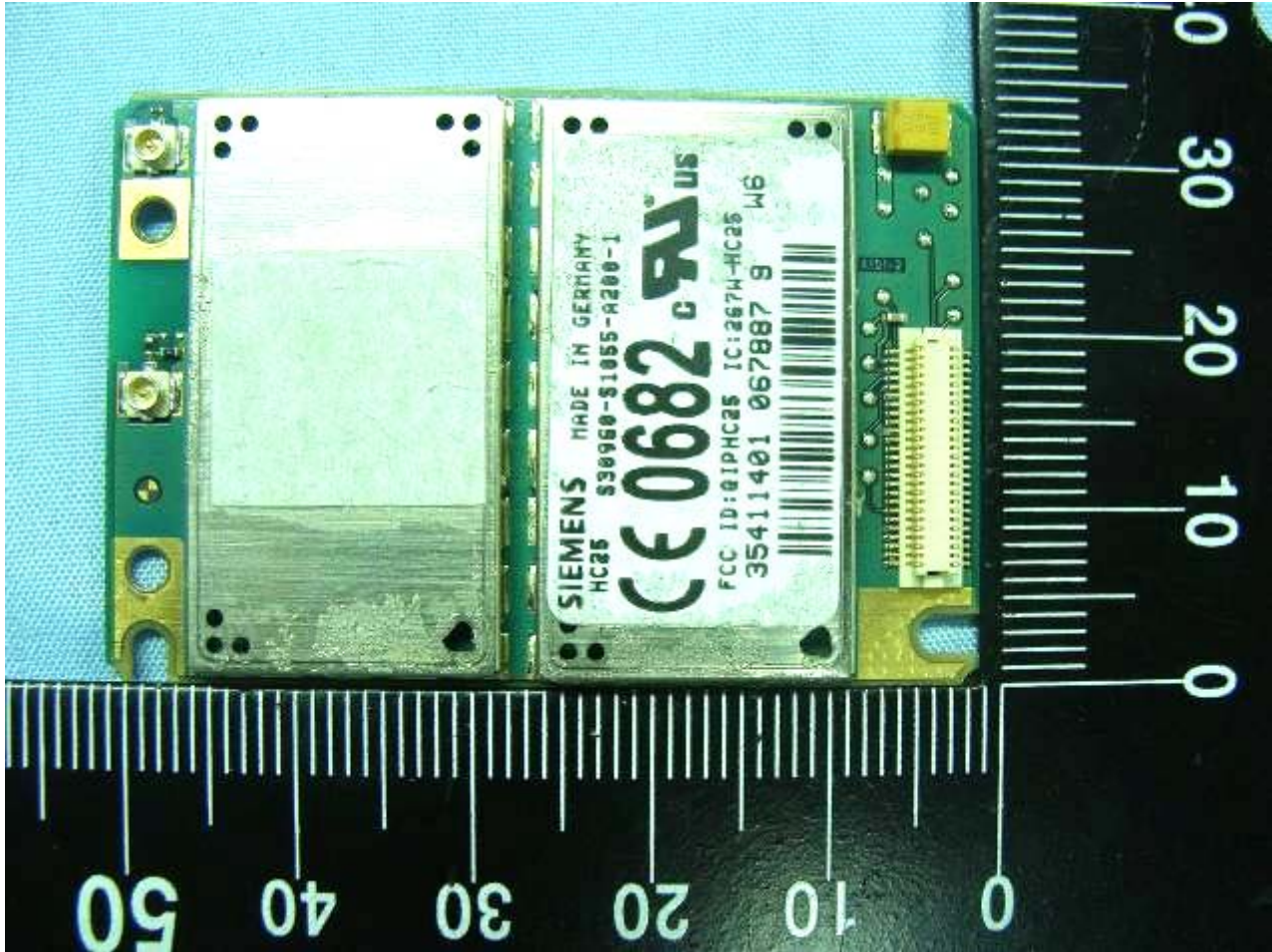

Model Name: Juno SC

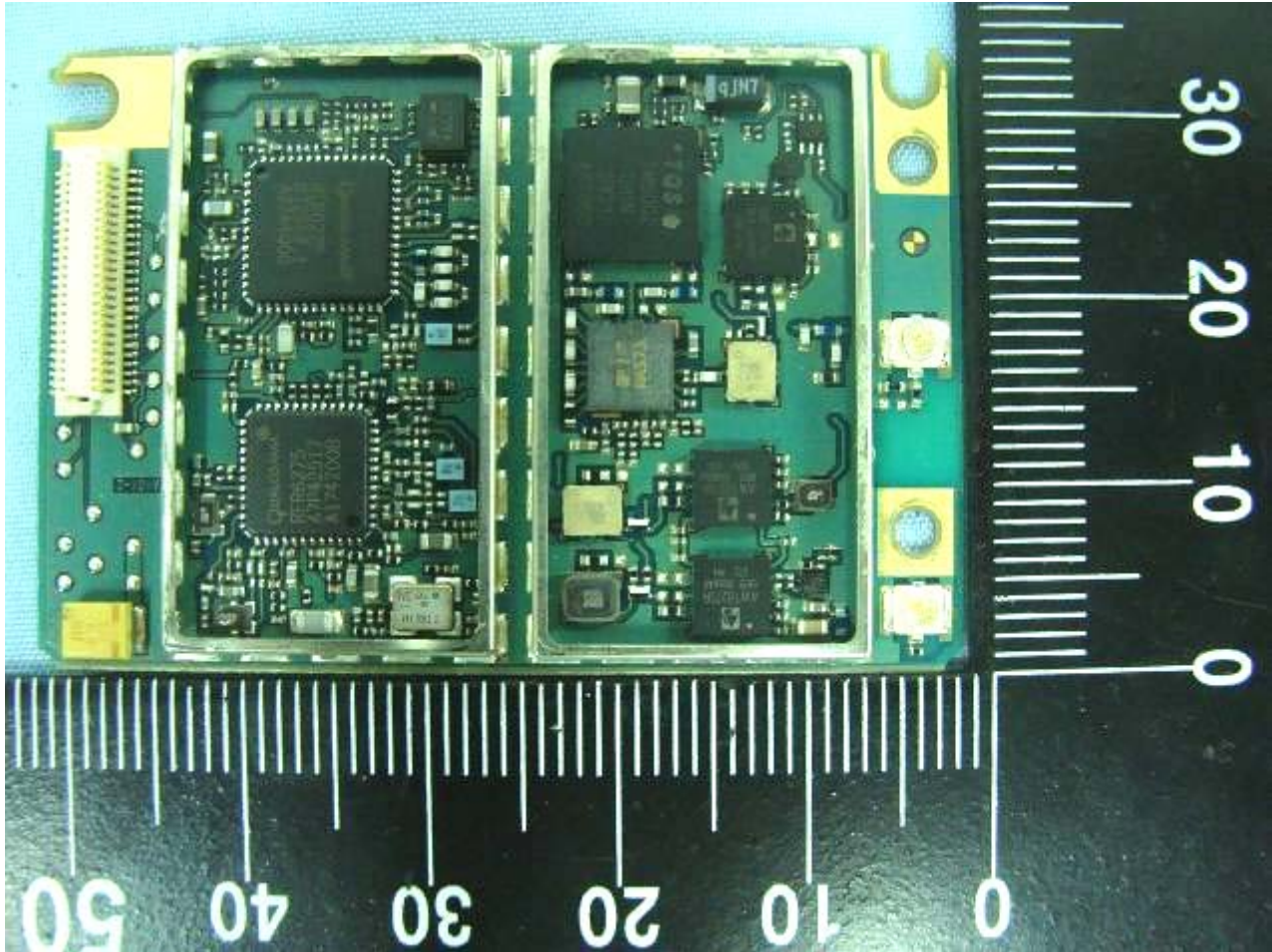

Model Name: Juno SC

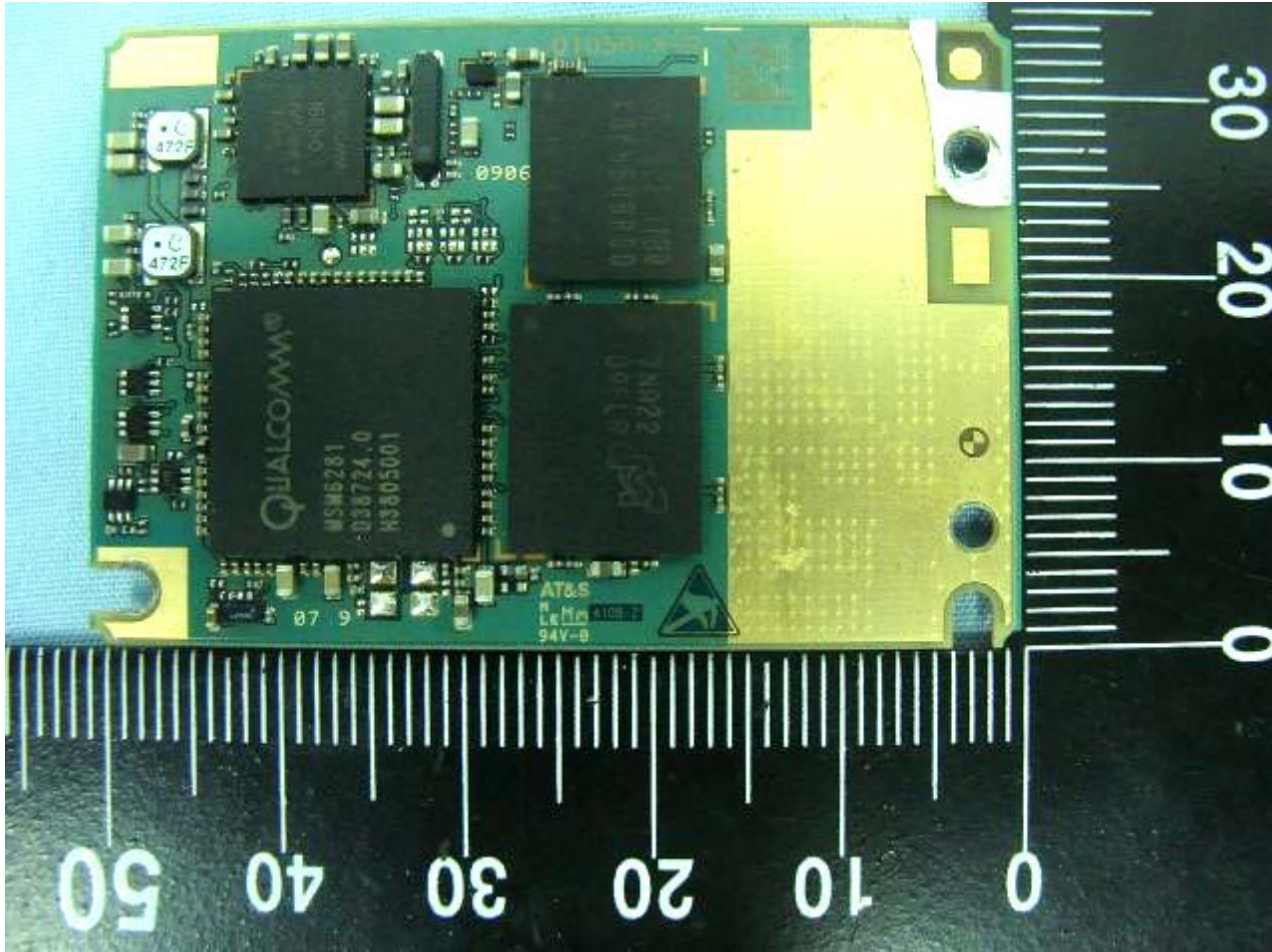

Model Name: Juno SC

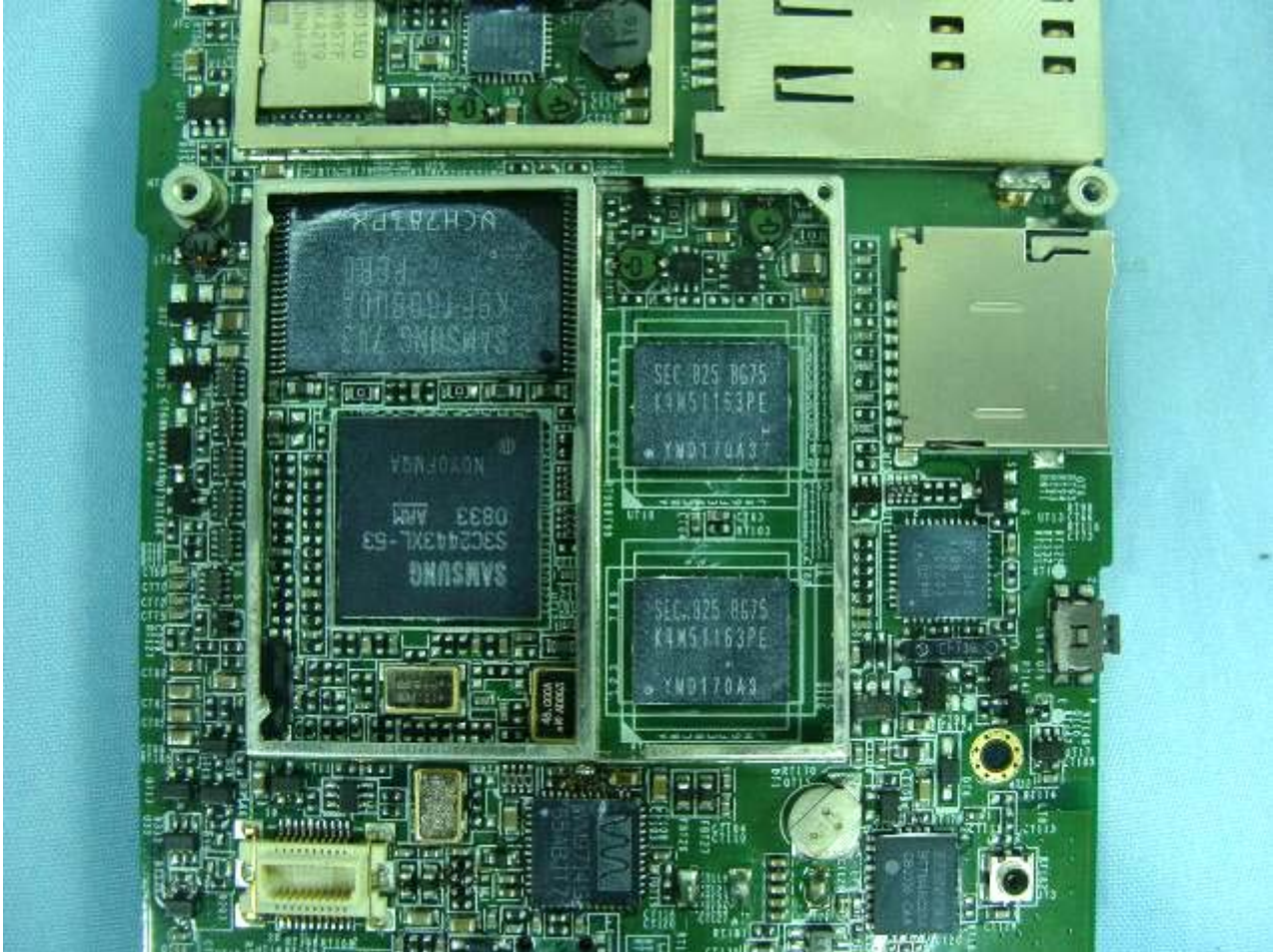



Model Name: Juno SC



Model Name: Juno SC

GSM ANT



Model Name: Juno SC

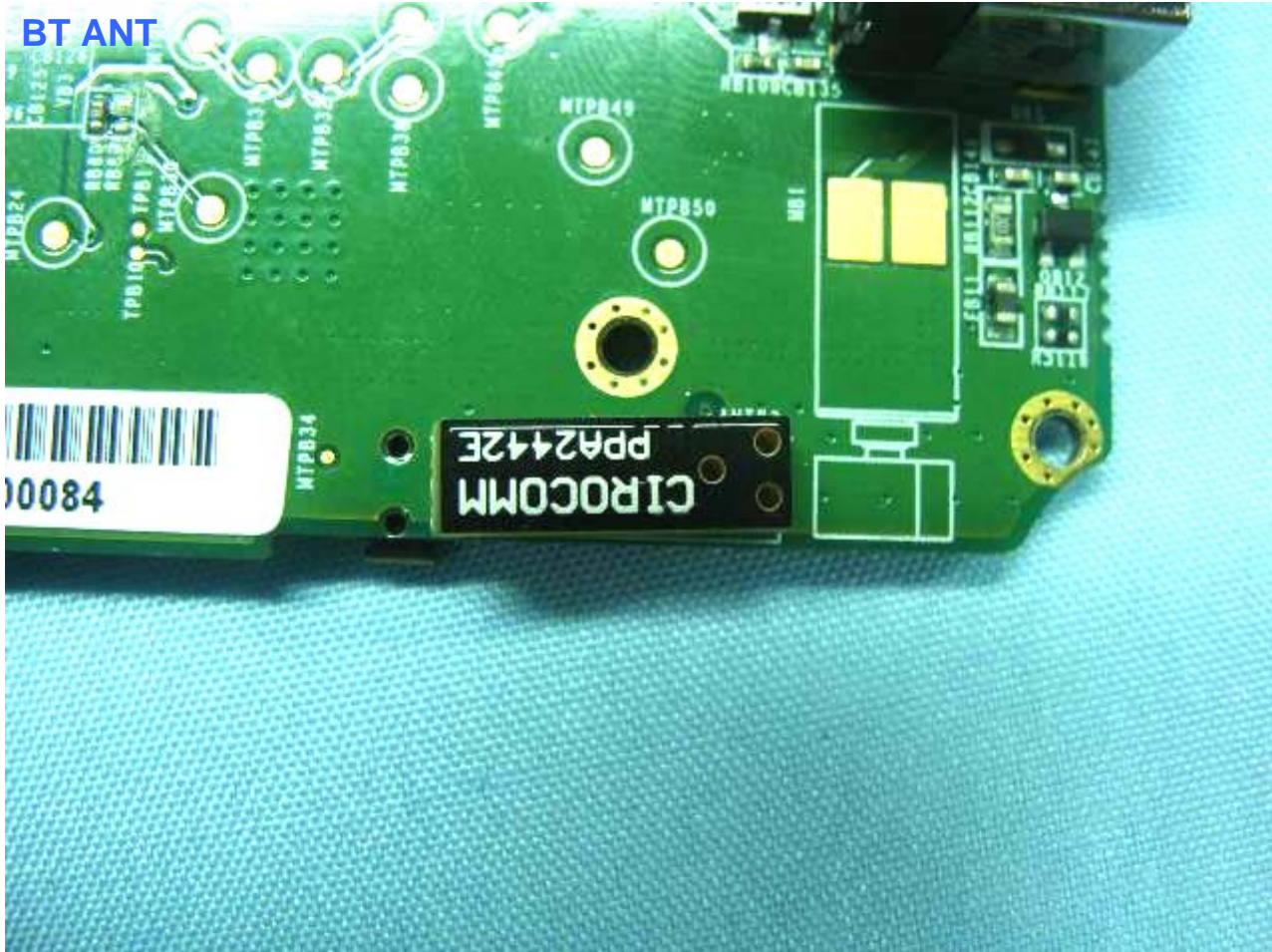

GSM Ant

Model Name: Juno SC



Appendix B. Setup Photographs

<Radiated Emission>

Front View

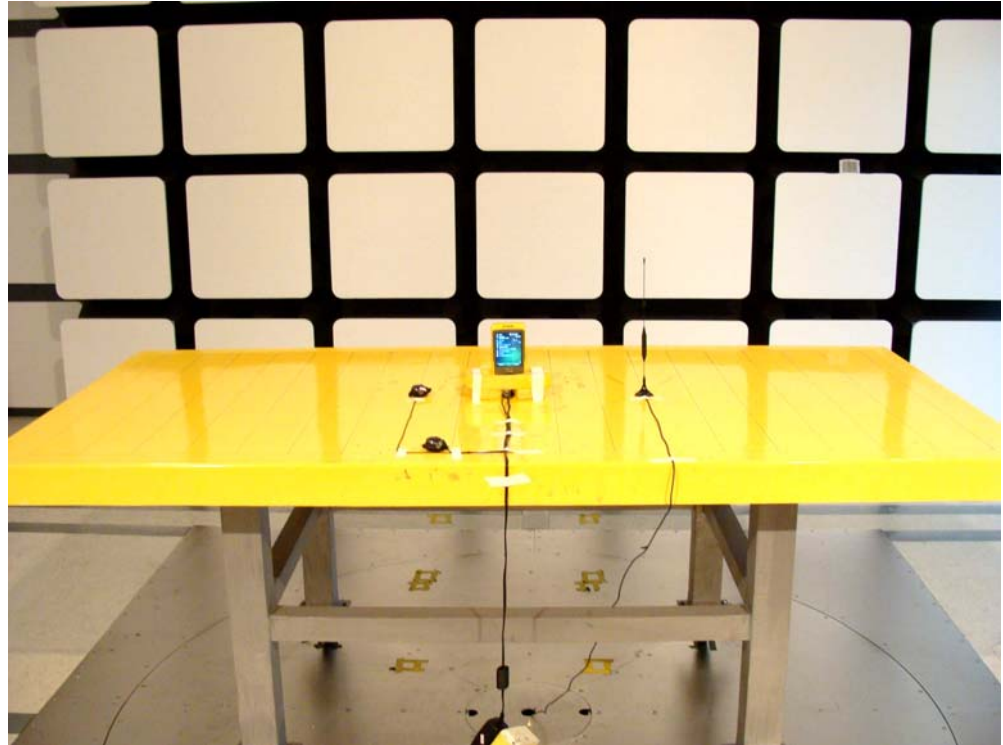

Rear View

