



GETTING STARTED GUIDE

GeoExplorer® 2005 series



GETTING STARTED GUIDE

GeoExplorer® 2005 series



Version 1.00
Revision A
Part Number 46506-40-ENG
October 2005

Contact Information

Trimble Navigation Limited, Mapping & GIS Business Area,
7401 Church Ranch Blvd, Westminster, 80021.

www.trimble.com.

Copyright and Trademarks

© 2002–2005, Trimble Navigation Limited. All rights reserved.

Trimble, the Globe & Triangle logo, GeoExplorer, and GPS Pathfinder are trademarks of Trimble Navigation Limited, registered in the United States Patent and Trademark Office and other countries. BoB, EVEREST, GeoBeacon, GeoXH, GeoXM, GeoXT, GPS Analyst, GPSCorrect, H-Star, TerraSync, VRS, and Zephyr are trademarks of Trimble Navigation Limited. Microsoft, Windows, Windows Mobile and ActiveSync are either registered trademarks or trademarks of Microsoft Corporation in the United States and/or other countries. The Bluetooth word mark and logos are owned by the Bluetooth SIG, Inc. and any use of such marks by Trimble Navigation Limited is under license. All other trademarks are the property of their respective owners.

This product is covered by the following US patents: 5,187,450; 5,311,149; 5,402,450; 5,493,588; 5,815,539; 6,377,891; 6,587,788; and 6,807,485.

Release Notice

This is the October 2005 release (Revision A) of the *GeoExplorer 2005 Series Getting Started Guide*, part number 46506-40-ENG. It applies to version 5.10 of the GeoExplorer series operating system and firmware. The GeoExplorer series handheld's operating system is based on the Microsoft Windows Mobile Version 5.0 software for Pocket PC (5.1.1702).

Legal Notices

Limited Warranty Terms and Conditions

Product Limited Warranty

Subject to the terms and conditions set forth herein, Trimble Navigation Limited ("Trimble") warrants that for a period of (1) year from date of purchase this Trimble product (the "Product") will substantially conform to Trimble's publicly available specifications for the Product and that the hardware and any storage media components of the Product will be substantially free from defects in materials and workmanship.

Product Software

Product software, whether built into hardware circuitry as firmware, provided as a standalone computer software product, embedded in flash memory, or stored on magnetic or other media, is licensed and not sold. If accompanied by a separate end user license agreement, use of any such software will be subject to the terms of such end user license agreement (including any differing limited warranty terms, exclusions and limitations), which shall control over the terms and conditions set forth in this limited warranty).

Software Updates

During the limited warranty period you will be entitled to receive such Fix Updates and Minor Updates to the Product software that Trimble releases and makes commercially available and for which it does not charge separately, subject to the procedures for delivery to purchasers of Trimble products generally. If you have purchased the Product from an authorized Trimble distributor rather than from Trimble directly, Trimble may, at its option, forward the software Fix Update or Minor Update to the Trimble distributor for final

distribution to you. Major Upgrades, new products, or substantially new software releases, as identified by Trimble are expressly excluded from this update process and limited warranty. Receipt of software updates shall not serve to extend the limited warranty period.

For purposes of this warranty the following definitions shall apply: (1) "Fix Update" means an error correction or other update created to fix a previous software version that does not substantially conform to its published specifications; (2) "Minor Update" occurs when enhancements are made to current features in a software program; and (3) "Major Upgrade" occurs when significant new features are added to software, or when a new product containing new features replaces the further development of a current product line. Trimble reserves the right to determine, in its sole discretion, what constitutes a significant new feature and Major Upgrade.

Warranty Remedies

If the Trimble Product fails during the warranty period for reasons covered by this Limited Warranty and you notify Trimble of such failure during the warranty period, Trimble at its option will repair OR replace the nonconforming Product, OR refund the purchase price paid by you for the Product, upon your return of the Product to Trimble in accordance with Trimble's standard return material authorization procedures.

How to Obtain Warranty Service

To obtain warranty service for the Product, please contact your Trimble dealer. Alternatively, you may contact Trimble to request warranty service at +1-408-481-6940 (24 hours a day) or e-mail your request to trimble_support@trimble.com. Please be prepared to provide:

- your name, address, and telephone numbers
- proof of purchase
- this Trimble warranty card
- a description of the nonconforming Product including the model number
- an explanation of the problem.

The customer service representative may need additional information from you depending on the nature of the problem.

Warranty Exclusions and Disclaimer

This Product limited warranty shall only apply in the event and to the extent that (i) the Product is properly and correctly installed, configured, interfaced, maintained, stored, and operated in accordance with Trimble's applicable operator's manual and specifications, and; (ii) the Product is not modified or misused. This Product limited warranty shall not apply to, and Trimble shall not be responsible for defects or performance problems resulting from (i) the combination or utilization of the Product with hardware or software products, information, data, systems, interfaces or devices not made, supplied or specified by Trimble; (ii) the operation of the Product under any specification other than, or in addition to, Trimble's standard specifications for its products; (iii) the unauthorized, installation, modification, or use of the Product; (iv) damage caused by: accident, lightning or other electrical discharge, fresh or salt water immersion or spray; or exposure to environmental conditions for which the Product is not intended; or (v) normal wear and tear on consumable parts (e.g., batteries). Trimble does not warrant or guarantee the results obtained through the use of the Product. NOTICE REGARDING PRODUCTS EQUIPPED WITH GPS TECHNOLOGY: TRIMBLE IS NOT

RESPONSIBLE FOR THE OPERATION OR FAILURE OF OPERATION OF GPS SATELLITES OR THE AVAILABILITY OF GPS SATELLITE SIGNALS.

THE FOREGOING LIMITED WARRANTY TERMS STATE TRIMBLE'S ENTIRE LIABILITY, AND YOUR EXCLUSIVE REMEDIES, RELATING TO PERFORMANCE OF THE TRIMBLE PRODUCT, EXCEPT AS OTHERWISE EXPRESSLY PROVIDED HEREIN, THE PRODUCT AND ACCOMPANYING DOCUMENTATION AND MATERIALS ARE PROVIDED "AS-IS" AND WITHOUT EXPRESS OR IMPLIED WARRANTY OF ANY KIND, BY EITHER TRIMBLE OR ANYONE WHO HAS BEEN INVOLVED IN ITS CREATION, PRODUCTION, INSTALLATION, OR DISTRIBUTION, INCLUDING, BUT NOT LIMITED TO, THE IMPLIED WARRANTIES OF MERCHANTABILITY AND FITNESS FOR A PARTICULAR PURPOSE, TITLE, AND NON-INFRINGEMENT. THE STATED EXPRESS WARRANTIES ARE IN LIEU OF ALL OBLIGATIONS OR LIABILITIES ON THE PART OF TRIMBLE ARISING OUT OF, OR IN CONNECTION WITH, ANY PRODUCT.

SOME STATES AND JURISDICTIONS DO NOT ALLOW LIMITATIONS ON DURATION OR THE EXCLUSION OF AN IMPLIED WARRANTY, SO THE ABOVE LIMITATION MAY NOT APPLY TO YOU.

Limitation of Liability

TRIMBLE'S ENTIRE LIABILITY UNDER ANY PROVISION HEREIN SHALL BE LIMITED TO THE AMOUNT PAID BY YOU FOR THE PRODUCT. TO THE MAXIMUM EXTENT PERMITTED BY APPLICABLE LAW, IN NO EVENT SHALL TRIMBLE OR ITS SUPPLIERS BE LIABLE FOR ANY INDIRECT, SPECIAL, INCIDENTAL OR CONSEQUENTIAL DAMAGE WHATSOEVER UNDER ANY CIRCUMSTANCE OR LEGAL THEORY RELATING IN ANYWAY TO THE PRODUCTS, SOFTWARE AND ACCOMPANYING DOCUMENTATION AND MATERIALS, (INCLUDING, WITHOUT LIMITATION, DAMAGES FOR LOSS OF BUSINESS PROFITS, BUSINESS INTERRUPTION, LOSS OF DATA, OR ANY OTHER PECUNIARY LOSS), REGARDLESS OF WHETHER TRIMBLE HAS BEEN ADVISED OF THE POSSIBILITY OF ANY SUCH LOSS AND REGARDLESS OF THE COURSE OF DEALING WHICH DEVELOPS OR HAS DEVELOPED BETWEEN YOU AND TRIMBLE. BECAUSE SOME STATES AND JURISDICTIONS DO NOT ALLOW THE EXCLUSION OR LIMITATION OF LIABILITY FOR CONSEQUENTIAL OR INCIDENTAL DAMAGES, THE ABOVE LIMITATION MAY NOT APPLY TO YOU.

PLEASE NOTE: THE ABOVE TRIMBLE LIMITED WARRANTY PROVISIONS WILL NOT APPLY TO PRODUCTS PURCHASED IN THOSE JURISDICTIONS, SUCH AS COUNTRIES OF THE EUROPEAN ECONOMIC COMMUNITY, IN WHICH PRODUCT WARRANTIES ARE OBTAINED FROM THE LOCAL DISTRIBUTOR. IN SUCH CASE, PLEASE CONTACT YOUR TRIMBLE DEALER FOR APPLICABLE WARRANTY INFORMATION.

Registration

To receive information regarding updates and new products, please contact your local dealer or visit the Trimble website at www.trimble.com/register. Upon registration you may select the newsletter, upgrade or new product information you desire.

Notices

Class B Statement – Notice to Users. This equipment has been tested and found to comply with the limits for a Class B digital device, pursuant to Part 15 of the FCC rules. These limits are designed to provide reasonable protection against harmful interference in a residential installation. This equipment generates, uses, and can radiate radio frequency

energy and, if not installed and used in accordance with the instructions, may cause harmful interference to radio communication. However, there is no guarantee that interference will not occur in a particular installation. If this equipment does cause harmful interference to radio or television reception, which can be determined by turning the equipment off and on, the user is encouraged to try to correct the interference by one or more of the following measures:

- Reorient or relocate the receiving antenna.
- Increase the separation between the equipment and the receiver.
- Connect the equipment into an outlet on a circuit different from that to which the receiver is connected.
- Consult the dealer or an experienced radio/TV technician for help.

Changes and modifications not expressly approved by the manufacturer or registrant of this equipment can void your authority to operate this equipment under Federal Communications Commission rules.

This device contains Bluetooth and wireless LAN radios and has been evaluated under FCC Bulletin OET 65C and found compliant with the requirements as set forth in CFR 47 Section 2.1093 addressing RF Exposure from radio frequency devices. The radiated output power of this device is far below the FCC radio frequency exposure limits.

The maximum SAR values measured from the device is: 802.11b wireless LAN: 0.043mW/g.

The external antenna connector provided in this device is for GPS antennas only.

Accessories

The following accessories have been approved for use with this device: P/N 53500-00 (support module) and P/N 53550-00 (serial clip).

Canada

This digital apparatus does not exceed the Class B limits for radio noise emissions from digital apparatus as set out in the radio interference regulations of the Canadian Department of Communications.

Le présent appareil numérique n'émet pas de bruits radioélectriques dépassant les limites applicables aux appareils numériques de Classe B prescrites dans le règlement sur le brouillage radioélectrique édicté par le Ministère des Communications du Canada.

Europe

This product has been tested and found to comply with the requirements for a Class B device pursuant to European Council Directive 1999/5/EC on R&TTE, thereby satisfying the requirements for CE Marking and sale within the European Economic Area (EEA). These requirements are designed to provide reasonable protection against harmful interference when the equipment is operated in a residential or commercial environment.



Australia and New Zealand

This product conforms with the regulatory requirements of the Australian Communications Authority (ACA) EMC and Radiocommunications framework, thus satisfying the requirements for C-Tick Marking and sale within Australia and New Zealand.



Notice to Our European Union Customers

For product recycling instructions and more information, please go to www.trimble.com/ev.shtml.

Recycling in Europe: To recycle Trimble WEEE (Waste Electrical and Electronic Equipment, products that run on electrical power), Call +31 497 53 24 30, and ask for the "WEEE Associate".



Or, mail a request for recycling instructions to:

Trimble Europe BV
c/o Menlo Worldwide Logistics
Meerheide 45
5521 DZ Eersel, NL

Taiwan – Battery Recycling Requirements

The product contains an internal Lithium-ion battery. Taiwanese regulations require that waste batteries are recycled.



廢電池請回收

End User License Agreement

IMPORTANT, READ CAREFULLY. THIS END USER LICENSE AGREEMENT ("AGREEMENT") IS A LEGAL AGREEMENT BETWEEN YOU AND TRIMBLE NAVIGATION LIMITED ("Trimble") and applies to the computer software provided with the Trimble product purchased by you (whether built into hardware circuitry as firmware, embedded in flash memory or a PCMCIA card, or stored on magnetic or other media), or provided as a stand-alone computer software product, and includes any accompanying written materials such as a user's guide or product manual, as well as any "online" or electronic documentation ("Software"). This Agreement will also apply to any Software error corrections, updates and upgrades subsequently furnished by Trimble, unless such are accompanied by different license terms and conditions, which will govern their use. You have acquired a Trimble Product ("Device") that includes Software, some of which was licensed by Trimble from an affiliate of Microsoft Corporation (collectively "MS"). The Software licensed from MS, as well as associated media, printed materials, and "online" or electronic documentation ("MS Software"), are protected under this Agreement. The Software is also protected by copyright laws and international copyright treaties, as well as other intellectual property laws and treaties. The Software is licensed, not sold.

BY CLICKING "YES" IN THE ACCEPTANCE BOX, OR BY INSTALLING, COPYING OR OTHERWISE USING THE SOFTWARE, YOU AGREE TO BE BOUND BY THE TERMS OF THIS AGREEMENT. IF YOU DO NOT AGREE TO THE TERMS OF THIS AGREEMENT, DO NOT USE THE DEVICE OR COPY THE SOFTWARE. INSTEAD, PROMPTLY RETURN THE UNUSED SOFTWARE AND ACCOMPANYING TRIMBLE PRODUCT TO THE PLACE FROM WHICH YOU OBTAINED THEM FOR A FULL REFUND. ANY USE OF THE SOFTWARE, INCLUDING, BUT NOT LIMITED TO USE ON THE DEVICE, WILL CONSTITUTE YOUR AGREEMENT TO THIS AGREEMENT (OR RATIFICATION OF ANY PREVIOUS CONSENT).

The MS Software includes software already installed on the Device ("Device Software") and MS software contained on the CD-ROM disk ("Companion CD").

1 SOFTWARE PRODUCT LICENSE

1.1 License Grant. Subject to the terms and conditions of this Agreement, Trimble grants you a non-exclusive right to use one copy of the Software in a machine-readable form only as installed on the Device. Such use is limited to use with the Device for which it was intended, as set forth in the product documentation. The Device Software is licensed

with the Device as a single integrated product. The Device Software installed in read only memory ("ROM") of the Device may only be used as part of the Device into which it was embedded. You may use the installation Software from a computer solely to download the Software to one Device. In no event shall the installation Software be used to download the Software onto more than one Device. A license for the Software may not be shared or used concurrently on different computers or Devices.

1.2 Companion CD. A Companion CD is included with your Device and you may install and use the Microsoft® ActiveSync® component on one (1) or more computers to exchange information with one (1) or more computing devices that contain a compatible version of the Microsoft Windows Mobile™ Version 5.0 operating system. For other software component(s) contained on the Companion CD, you may install and use such components only in accordance with the terms of the printed or online end user license agreement(s) provided with such component(s). In the absence of an end user license agreement for particular component(s) of the Companion CD, you may install and use only one (1) copy of such component(s) on the Device or a single computer with which you use the Device.

1.3 Phone Functionality. If the Device Software includes phone functionality, all or certain portions of the Device Software may be inoperable if you do not have and maintain a service account with an appropriate wireless telecommunication carrier to whom Trimble may distribute its Devices ("Mobile Operator"), or if the Mobile Operator's network facilities are not operating or configured to operate with the Device.

1.4 Microsoft Outlook 2002. If Microsoft Outlook® 2002 is included with your Device, the following terms apply to your use of the Microsoft Outlook 2002: (i) regardless of the information contained in the "Software Installation and Use" section of the online end user license agreement, you may install one (1) copy of Microsoft Outlook 2002 on one (1) computer to use, exchange data, share data, access and interact with the Device, and (ii) the EULA for Microsoft Outlook 2002 is between Trimble and the end user - not between the PC manufacturer and the end user.

1.5 Upgrade Software. In the event that any upgrades to MS Software are provided under this Agreement, then the following shall apply: Trimble is distributing the accompanying Software in this format exclusively for installation as an upgrade to previously distributed Devices preinstalled with one of the following:

- 1 - Microsoft Windows Mobile 2003 Software for Pocket PC, Professional Edition with Microsoft Outlook® 2002;
- 2 - Microsoft Windows Mobile 2003 Software for Pocket PC, Premium Edition with Microsoft Outlook 2002;
- 3 - Microsoft Windows Mobile 2003 Software for Pocket PC, Professional Edition;
- 4 - Microsoft Windows Mobile 2003 Software for Pocket PC, Premium Edition;
- 5 - Microsoft Windows Mobile 2003 Software for Pocket PC, Premium with Phone Edition (GSM/GPRS) with Microsoft Outlook 2002;
- 6 - Microsoft Windows Mobile 2003 Software for Pocket PC, Premium with Phone Edition (GSM/GPRS);
- 7 - Microsoft Windows Mobile 2003 Software for Pocket PC, Premium with Phone Edition (CDMA/1xRTT) with Microsoft Outlook 2002;
- 8 - Microsoft Windows Mobile 2003 Software for Pocket PC, Premium with Phone Edition (CDMA/1xRTT).

Accordingly, you may follow the applicable instructions accompanying this Software and install one (1) copy of the Software on one (1) Device presently containing a licensed

copy of a predecessor version of the Software (unless this Agreement indicates that this Software copy has been licensed for installation on multiple Devices). NO REPRESENTATION OR WARRANTY IS MADE BY MS WITH RESPECT TO THE COMPATIBILITY OF THIS SOFTWARE WITH ANY DEVICE OR ANY OTHER EXISTING SOFTWARE OR DATA OF ANY KIND CONTAINED ON SUCH DEVICES, AND MS SHALL NOT BE RESPONSIBLE IN ANY REGARD WITH RESPECT TO ANY LOSS, CORRUPTION, MODIFICATION OR INACCESSIBILITY OF ANY DATA, APPLICATIONS OR OTHER SOFTWARE RESULTING FROM THE INSTALLATION OF THE SOFTWARE ON ANY DEVICE.

1.6 Security Updates/Digital Rights Management. Content providers are using the digital rights management technology contained in this MS Software ("DRM") to protect the integrity of their content ("Secure Content") so that their intellectual property, including copyright, in such content is not misappropriated. Portions of this Software and third party applications such as media players use DRM to play Secure Content ("DRM Software"). If the DRM Software's security has been compromised, owners of Secure Content ("Secure Content Owners") may request that MS revoke the DRM Software's right to copy, display and/or play Secure Content. Revocation does not alter the DRM Software's ability to play unprotected content. A list of revoked DRM Software is sent to your computer whenever you download a license for Secure Content from the Internet. You therefore agree that MS may, in conjunction with such license, also download revocation lists onto your computer on behalf of Secure Content Owners. MS will not retrieve any personally identifiable information, or any other information, from your computer by downloading such revocation lists. Secure Content Owners may also require you to upgrade some of the DRM components in this Software ("DRM Upgrades") before accessing their content. When you attempt to play such content, MS DRM SOFTWARE will notify you that a DRM Upgrade is required and then ask for your content before the DRM Upgrade is downloaded. Third party DRM Software may do the same. If you decline the upgrade, you will not be able to access content that requires the DRM Upgrade; however, you will still be able to access unprotected content and Secure Content that does not require the upgrade.

1.7 Consent to Use of Data. You agree that MS, Microsoft Corporation, their affiliates and/or their designated agent may collect and use technical information gathered in any manner as part of product support services related to the Device Software. MS, Microsoft Corporation, their affiliates and/or their designated agent may use this information solely to improve their products or to provide customized services or technologies to you. MS, Microsoft Corporation, their affiliates and/or their designated agent may disclose this information to others, but not in a form that personally identifies you.

1.8 Internet Gaming/Update Features. If the Device Software provides, and you choose to utilize, the Internet gaming or update features within the Device Software, it is necessary to use certain computer system, hardware, and software information to implement the features. By using these features, you explicitly authorize MS, Microsoft Corporation and/or their designated agent to use this information solely to improve their products or to provide customized services or technologies to you. MS or Microsoft Corporation may disclose this information to others, but not in a form that personally identifies you.

1.9 Internet-Based Services Components. The Device Software may contain components that enable and facilitate the use of certain Internet-based services. You acknowledge and agree that MS, Microsoft Corporation,

their affiliates and/or their designated agent may automatically check the version of the Device Software and/or its components that you are utilizing and may provide upgrades or supplements to the Device Software that may be automatically downloaded to your Device.

1.10 Additional Software/Services. The Device Software may permit Trimble, MS, Microsoft Corporation, their affiliates and/or their designated agent to provide or make available to you Software updates, supplements, add-on components, or Internet-based services components of the Software after the date you obtain your initial copy of the Software ("Supplemental Components").

1.10.1 If Trimble provides or makes available to you Supplemental Components and no other end user license agreement terms are provided along with the Supplemental Components, then the terms of this Agreement shall apply.

1.10.2 If MS, Microsoft Corporation, their affiliates and/or their designated agent make available Supplemental Components, and no other end user license agreement terms are provided, then the terms of this Agreement shall apply, except that the MS, Microsoft Corporation or affiliate entity providing the Supplemental Component(s) shall be the licensor of the Supplemental Component(s)

1.10.3 Trimble, MS, Microsoft Corporation, their affiliates and/or their designated agent reserve the right to discontinue any Internet-based services provided to you or made available to you through the use of the Device Software.

1.11 Links to Third Party Sites. The Device Software may provide you with the ability to link to third party sites through the use of the Device Software. The third party sites are not under the control of MS, Microsoft Corporation, their affiliates and/or their designated agent. Neither MS nor Microsoft Corporation nor their affiliates nor their designated agents are responsible for (i) the contents of any third party sites, any links contained in third party sites, or any changes or updates to third party sites, or (ii) webcasting or any other form of transmission received from any third party sites. If the Device Software provides links to third party sites, those links are provided to you only as a convenience, and the inclusion of any link does not imply an endorsement of the third party site by MS, Microsoft Corporation, their affiliates and/or their designated agent.

1.12 Other Rights and Limitations. (1) The Software contains valuable trade secrets proprietary to Trimble and its suppliers. To the extent permitted by relevant law, you shall not, nor allow any third party to copy, decompile, disassemble or otherwise reverse engineer the Software, or attempt to do so, provided, however, that to the extent any applicable mandatory laws (such as, for example, national laws implementing EC Directive 91/250 on the Legal Protection of Computer Programs) give you the right to perform any of the aforementioned activities without Trimble's consent in order to gain certain information about the Software for purposes specified in the respective statutes (i.e., interoperability), you hereby agree that, before exercising any such rights, you shall first request such information from Trimble in writing detailing the purpose for which you need the information. Only if and after Trimble, at its sole discretion, partly or completely denies your request, may you exercise such statutory rights. (2) This Software is licensed as a single product. You may not separate its component parts for use on more than one computer. (3) You may not rent, lease, or lend the Software. (4) No service bureau work, multiple-user license or time-sharing arrangement is permitted. For purposes of this Agreement "service bureau work" shall be deemed to

include, without limitation, use of the Software to process or to generate output data for the benefit of, or for purposes of rendering services to any third party over the Internet or other communications network. (5) You may permanently transfer all of your rights under this Agreement only as part of a permanent sale or transfer of the Device, provided you retain no copies, you transfer all of the Software (including all component parts, the media and printed materials, any upgrades, this Agreement, and, if applicable, the Certificate(s) of Authority) and the recipient agrees to the terms of this Agreement. If the Software portion is an upgrade, any transfer must include all prior versions of the Software. If the Device Software includes phone functionality, you may not permanently transfer any of your rights under this Agreement with regard to the Device Software or Companion CD, except as permitted by the applicable Mobile Operator and in accordance with the preceding terms governing transferability. (6) You acknowledge that the Software and underlying technology are subject to U.S. and EU Export jurisdiction. You agree to comply with all applicable international and national laws that apply to the Software and underlying technology, including U.S. Export Administration Regulations, as well as end-user, end-use and destination restrictions issued by U.S. and other governments. For additional information see <http://www.microsoft.com/exporting>. (7) Without prejudice as to any other rights, Trimble may terminate this Agreement without notice if you fail to comply with the terms and conditions of this Agreement. In such event, you must destroy all copies of the Software and all of its component parts. (8) If the MS Software includes speech and/or handwriting recognition component(s), you should understand that speech and handwriting recognition are inherently statistical processes and that errors can occur in the component's recognition of your handwriting, and the final conversion into text. Neither Trimble nor any of its suppliers shall be liable for any damages arising out of errors in the speech and handwriting recognition process. (9) The package for the Device may contain multiple versions of this Agreement, such as multiple translations and/or multiple media versions (e.g., in the user documentation and in the software). Even if you receive multiple versions of this Agreement, you are licensed to use only one (1) copy of the Device Software.

1.13 **Notice Regarding the MPEG-4 Visual Standard.** The MS Software may include MPEG-4 visual decoding technology. MPEG LA, L.L.C. requires the following notice: USE OF THIS SOFTWARE IN ANY MANNER THAT COMPLIES WITH THE MPEG-4 VISUAL STANDARD IS PROHIBITED, EXCEPT FOR USE DIRECTLY RELATED TO (A) DATA OR INFORMATION (i) GENERATED BY AND OBTAINED WITHOUT CHARGE FROM A CONSUMER NOT THEREBY ENGAGED IN A BUSINESS ENTERPRISE, AND (ii) FOR PERSONAL USE ONLY; AND (B) OTHER USES SPECIFICALLY AND SEPARATELY LICENSED BY MPEG LA, L.L.C. If you have any questions regarding this notice, please contact MPEG LA, L.L.C., 250 Steele Street, Suite 300, Denver, Colorado 80206; Telephone 303-331-1880; fax 303-331-1879.

1.14 If the Device Software is provided by Trimble separate from the Device on media such as a ROM chip, CD ROM disk(s) or via web download or other means, and is labeled "For Upgrade Purposes Only" you may install one (1) copy of such Device Software onto the Device as a replacement copy for the existing Device Software and use it accordance with this Agreement, including any additional end user license agreement terms accompanying the upgrade Device Software.

1.15 If any software component(s) provided by Trimble separate from the Device on CD ROM disc(s) or via web download or other means, and labeled "For Upgrade Purposes Only," you may (i) install and use one (1) copy of such component(s) on the computer(s) you use to exchange data with the Device as a replacement copy for the existing Companion CD component(s).

1.16 **Copyright.** All title and copyrights in and to the Software (including but not limited to any images, photographs, animations, video, audio, music, text and "applets," incorporated into the Software), the accompanying printed materials, and any copies of the Software are owned by Trimble, or MS (including Microsoft Corporation), and their respective suppliers. You may not copy the printed materials accompanying the Software. All title and intellectual property rights in and to the content which may be accessed through use of the Software is the property of the respective content owner and may be protected by applicable copyright or other intellectual property laws and treaties. This Agreement grants you no rights to use such content. You shall not remove, cover or alter any of Trimble's patent, copyright or trademark notices placed upon, embedded in or displayed by the Software or on its packaging and related materials. All rights not specifically granted in this Agreement are reserved by Trimble, MS (including Microsoft Corporation), and their respective suppliers.

1.17 **U.S. Government Restricted Rights.** The Software is provided with "RESTRICTED RIGHTS". Use, duplication, or disclosure by the United States Government is subject to restrictions as set forth in this Agreement, and as provided in DFARS 227.7202-1(a) and 227.7202-3(a) (1995), DFARS 252.227-7013(c)(1)(ii) (OCT 1988), FAR 12.212(a) (1995), FAR 52.227-19, or FAR 52.227-14(ALT III), as applicable.

Microsoft Corporation has contractually obligated Trimble to include the following disclaimers in this Agreement:

Product Support. The Product support for the Software is not provided by MS, its parent corporation, Microsoft Corporation, or their affiliates or their affiliates or subsidiaries. For product support, please refer to Trimble support number provided in the documentation for the Device. Should you have any questions concerning this Agreement, or if you desire to contact Trimble for any other reason, please refer to the address provided in the documentation for the Device.

No Liability for Certain Damages. EXCEPT AS PROHIBITED BY LAW, MICROSOFT CORPORATION AND ITS AFFILIATES SHALL HAVE NO LIABILITY FOR ANY INDIRECT, SPECIAL, CONSEQUENTIAL OR INCIDENTAL DAMAGES ARISING FROM OR IN CONNECTION WITH THE USE OR PERFORMANCE OF THE MS SOFTWARE. THIS LIMITATION SHALL APPLY EVEN IF ANY REMEDY FAILS ITS ESSENTIAL PURPOSE.

2 LIMITED WARRANTY.

2.1 **Limited Warranty.** Trimble warrants that the Software will perform substantially in accordance with the accompanying written materials for a period of ninety (90) days from the date of receipt. This limited warranty gives you specific legal rights, you may have others, which vary from state/jurisdiction to state/jurisdiction. The above limited warranty does not apply to error corrections, updates or upgrades of the Software after expiration of the ninety (90) day limited warranty period, which are provided "AS IS" and without warranty unless otherwise specified in writing by Trimble. Because the Software is inherently complex and may not be completely free of nonconformities, defects or errors, you are advised to verify your work. Trimble does not warrant that the Software will

operate error free or uninterrupted, will meet your needs or expectations, or that all nonconformities can or will be corrected.

2.2 **Customer Remedies.** Trimble's and its suppliers' entire liability, and your sole remedy, with respect to the Software shall be either, at Trimble's option, (a) repair or replacement of the Software, or (b) return of the license fee paid for any Software that does not meet Trimble's limited warranty. This limited warranty is void if failure of the Software has resulted from (1) accident, misuse, abuse, or misapplication; (2) alteration or modification of the Software without Trimble's authorization; (3) interaction with software or hardware not supplied or supported by Trimble; (4) your improper, inadequate or unauthorized installation, maintenance or storage; or (5) if you violate the terms of this Agreement. Any replacement Software will be warranted for the remainder of the original warranty period or thirty (30) days, whichever is longer.

2.3 **NO OTHER WARRANTIES.** TO THE MAXIMUM EXTENT PERMITTED BY APPLICABLE LAW, TRIMBLE AND ITS SUPPLIERS DISCLAIM ALL OTHER WARRANTIES, TERMS AND CONDITIONS, EITHER EXPRESS OR IMPLIED, BY STATUTE, COMMON LAW OR OTHERWISE, INCLUDING BUT NOT LIMITED TO, IMPLIED WARRANTIES, TERMS AND CONDITIONS OF MERCHANTABILITY AND FITNESS FOR A PARTICULAR PURPOSE, TITLE, AND NONINFRINGEMENT WITH REGARD TO THE SOFTWARE, ITS SATISFACTORY QUALITY AND THE PROVISION OF OR FAILURE TO PROVIDE SUPPORT SERVICES. TO THE EXTENT ALLOWED BY APPLICABLE LAW, IMPLIED WARRANTIES, TERMS AND CONDITIONS ON THE SOFTWARE ARE LIMITED TO NINETY (90) DAYS. YOU MAY HAVE OTHER LEGAL RIGHTS WHICH VARY FROM STATE/JURISDICTION TO STATE/JURISDICTION.

2.4 **LIMITATION OF LIABILITY.** TO THE MAXIMUM EXTENT PERMITTED BY APPLICABLE LAW, IN NO EVENT SHALL TRIMBLE OR ITS SUPPLIERS BE LIABLE FOR ANY SPECIAL, INCIDENTAL, INDIRECT, CONSEQUENTIAL OR PUNITIVE DAMAGES HOWEVER CAUSED AND REGARDLESS OF THE THEORY OF LIABILITY (INCLUDING, WITHOUT LIMITATION, DAMAGES FOR LOSS OF BUSINESS PROFITS, BUSINESS INTERRUPTION, LOSS OF BUSINESS INFORMATION, OR ANY OTHER PECUNIARY LOSS) ARISING OUT OF THE USE OR INABILITY TO USE THE SOFTWARE, OR THE PROVISION OF OR FAILURE TO PROVIDE SUPPORT SERVICES, EVEN IF TRIMBLE HAS BEEN ADVISED OF THE POSSIBILITY OF SUCH DAMAGES AND NOTWITHSTANDING ANY FAILURE OF ESSENTIAL PURPOSE OF ANY EXCLUSIVE REMEDY PROVIDED IN THIS AGREEMENT.

IN NO EVENT SHALL THE TOTAL CUMULATIVE LIABILITY OF TRIMBLE AND ITS SUPPLIERS IN CONNECTION WITH THIS AGREEMENT OR THE SOFTWARE, WHETHER BASED ON CONTRACT, WARRANTY, TORT (INCLUDING NEGLIGENCE), STRICT LIABILITY OR OTHERWISE, EXCEED THE ACTUAL AMOUNT PAID TO TRIMBLE FOR THE SOFTWARE LICENSE GIVING RISE TO THE CLAIM. BECAUSE SOME STATES AND JURISDICTIONS DO NOT ALLOW THE EXCLUSION OR LIMITATION OF LIABILITY FOR CONSEQUENTIAL OR INCIDENTAL DAMAGES, THE ABOVE LIMITATION MAY NOT APPLY TO YOU.

2.5 *PLEASE NOTE: THE FOREGOING TRIMBLE LIMITED WARRANTY PROVISIONS MAY NOT APPLY TO SOFTWARE PRODUCT LICENSES PURCHASED IN THOSE JURISDICTIONS (SUCH AS COUNTRIES OF THE EUROPEAN UNION) IN WHICH PRODUCT WARRANTIES ARE*

OBTAINED FROM THE LOCAL DISTRIBUTOR. IN SUCH CASES, PLEASE CONTACT YOUR TRIMBLE DEALER FOR APPLICABLE WARRANTY INFORMATION.

2.6 Without prejudice to any other rights, Trimble or MS may terminate this Agreement if you fail to comply with the terms and conditions of this Agreement. In such event, you must destroy all copies of the Software and all of its component parts.

3 **GENERAL.**

3.1 This Agreement shall be governed by the laws of the State of California and applicable United States Federal law without reference to "conflict of laws" principles or provisions. The United Nations Convention on Contracts for the International Sale of Goods will not apply to this Agreement. Jurisdiction and venue of any dispute or court action arising from or related to this Agreement or the Software shall lie exclusively in or be transferred to the courts the County of Santa Clara, California, and/or the United States District Court for the Northern District of California. You hereby consent and agree not to contest, such jurisdiction, venue and governing law.

3.2 Section 3.1 notwithstanding, if you acquired this product in Canada, this Agreement is governed by the laws of the Province of Ontario, Canada. In such case each of the parties to this Agreement irrevocably attorns to the jurisdiction of the courts of the Province of Ontario and further agrees to commence any litigation that may arise under this Agreement in the courts located in the Judicial District of York, Province of Ontario. If you acquired this product in the European Union, this Agreement is governed by the laws of The Netherlands, excluding its rules governing conflicts of laws and including the United Nations Convention on the International Sale of Goods. In such case each of the parties to this Agreement irrevocably attorns to the jurisdiction of the courts of The Netherlands and further agrees to commence any litigation that may arise under this Agreement in the courts of The Hague, The Netherlands.

3.3 Trimble reserves all rights not expressly granted by this Agreement.

3.4 Official Language. The official language of this Agreement and of any documents relating thereto is English. For purposes of interpretation, or in the event of a conflict between English and versions of this Agreement or related documents in any other language, the English language version shall be controlling.

Safety Information

Air travel

The GeoExplorer 2005 series handheld contains a Bluetooth radio and a WLAN (wireless LAN) radio. Aviation authority regulations can restrict the use of radios on board aircraft. You may be required to turn off the handheld or radios.

- To turn off the handheld, press and hold the **Power** button for 15 seconds.
- To turn off the Bluetooth and WLAN radios only, see [Enabling Flight mode, page 54](#).

Battery safety

The internal rechargeable Lithium-ion battery is supplied partially charged. Charge the battery completely before using it for the first time (see [Power, page 34](#)). If the battery has been stored for longer than six months, charge it before use.



WARNING – The GeoExplorer 2005 series handheld is powered by an internal rechargeable Lithium-ion battery. Charge and use the battery only in strict accordance with the instructions provided.

To prevent injury or damage:

- Never attempt to remove, replace, or repair the battery yourself.
 - Do not damage the battery.
 - Do not store or leave your device near a heat source such as near a fireplace or other heat-generating appliance, or otherwise expose it to temperatures in excess of 70°C (158°F) such as on a vehicle dashboard. When heated to excessive temperatures, battery cells could explode or vent, posing a risk of fire.
 - Do not use the handheld if the battery appears to be leaking.
 - If the battery requires attention, send the handheld to your local Trimble Service center.
 - Discharge the handheld before disposing of the battery. When disposing of the battery, be sure to do so in an environmentally sensitive manner. Adhere to any local and national regulations concerning battery disposal or recycling.
-

AC adaptor safety

An international adaptor kit is provided with the GeoExplorer 2005 series handheld. To charge the handheld's internal battery, use the international adaptor kit connected to the support module (see [Power, page 34](#)).



WARNING – To use AC adaptors safely:

- Use only the AC adaptor intended for the GeoExplorer 2005 series handheld. Using any other AC adaptor can damage your product and may void your warranty. Do not use the AC adaptor with any other product.
 - Make certain that the input voltage on the adaptor matches the voltage and frequency in your location.
 - Make certain that the adaptor has prongs compatible with your outlets.
 - AC adaptors are designed for indoor use only. Avoid using the AC adaptor in wet outdoor areas.
 - Unplug the AC adaptor from power when not in use.
 - Do not short the output connector.
 - There are no user-serviceable parts in this product.
 - Should damage to the AC adaptor occur, replace it with a new Trimble AC adaptor (P/N 61234-00).
-

SD card use

The GeoExplorer 2005 series handheld provides a Secure Digital (SD) memory card slot, providing an alternative storage location to the flash disk.



WARNING – The presence of any dust or moisture in the SD slot may adversely affect the device and void your Trimble warranty. To prevent dust or moisture entering the SD slot:

- Make certain that the SD door is attached correctly when you are using the handheld outdoors.
 - When inserting or removing an SD card, place the handheld on a dust-free indoor surface.
-



WARNING – Static electricity can harm electronic components inside your device. To prevent static damage:

- Discharge static electricity from your body before you touch any of your device's electronic components, such as a memory module. You can do so by touching an unpainted metal surface.
-

Contents

Safety Information	ix
Air travel	ix
Battery safety	ix
AC adaptor safety	x
SD card usexi
About this Manual	1
Further information.	1
System Components	2
What's in the box?	2
Accessories	3
Pre-installed software.	4
Parts of the GeoExplorer 2005 series handheld.	5
Getting Started	8
Charge the battery.	8
Turn on and suspend	9
Align the touch screen	9
Turn on the backlight.	9
Set the time zone	10
Install and activate software	10
Use GPS	10
Windows Mobile Basics	11
Parts of the screen.	11
Accessing help	12
Using the stylus	12
Entering text	13

ActiveSync Connections	15
Connecting the handheld to a computer	15
Using ActiveSync technology	17
Installing Software	19
Installing TerraSync software	19
Installing ArcPad software	20
Installing the GPSCorrect extension	20
Using the GPS Analyst extension	20
Using GPS	21
What is GPS?	21
Getting a clear view of the sky	22
GPS COM ports	22
Configuring a GPS application	23
Using your GPS application	24
GPS Connector	28
Antennas	29
Maintaining Accuracy	29
Power	34
Safety warnings	34
Charging the internal Lithium-ion battery	35
Using external power	36
Suspend mode	38
Conserving power	39
Memory	40
SD memory cards	40
Backing up data	42
Resetting the handheld	43

Internet and Network Connections 44

Connection methods 44
Setting up connections 45
Connecting to the Internet 48
Connecting to work 49
Managing connections 50

Using the Bluetooth Radio 51

Bluetooth hosts and clients 51
Deactivating the Bluetooth radio 52
Enabling Bluetooth wireless connections 53
Bonding with a Bluetooth device 54
Setting up Bluetooth connections 55
Connecting to a Bluetooth service as a client 57
Providing Bluetooth services as a host 60

Using the WLAN Radio 63

Wireless LAN access points 63
Setting up a wireless LAN connection 64
Connecting to a network using wireless LAN connectivity 65
Enabling Flight mode 65
Disabling the WLAN radio 65

Using Cabled Ethernet 66

Connecting to the Internet or a network 66
Connecting to an office computer 67

Using the Optional Serial Clip 68

Attaching the serial clip 69
Connecting to external devices 69

Personalizing your Handheld	71
Today	71
Device Lock	72
Sounds and Notifications	73
Screen	74
Power	75
Backlight	75
Use and Care	77
Servicing	77
Cleaning	77
Storage	77
Troubleshooting	78
Battery issues	78
GPS / real-time correction issues	79
Connection issues	81
Touch screen issues	85
Index	87

About this Manual

Welcome to the *GeoExplorer 2005 Series Getting Started Guide*. This manual describes how to use a Trimble® GeoExplorer® 2005 series handheld.

The GeoExplorer 2005 series includes the GeoXH™, GeoXT™, and GeoXM™ handhelds. These handhelds combine a Trimble GPS receiver with a field computer running Microsoft® Windows Mobile™ Version 5.0 software for Pocket PC.

The GeoXM handheld provides reliable accuracy within 1 to 3 meters. The GeoXT and GeoXH handhelds use EVEREST™ multipath rejection technology to provide submeter accuracy. In addition, the GeoXH handheld enables you to use H-Star™ technology to provide subfoot (30 cm) postprocessed accuracy for static GPS positions. For more information, see [Maintaining Accuracy, page 29](#).

Further information

For more information on...	refer to...
ESRI® ArcPad™ software	www.esri.com/arcpad , or ArcPad documentation
GPS	www.trimble.com/gps/
GPS Connector software	GPS Connector help
GPS Controller software	GPS Controller help
GPScorrect™ extension for ESRI ArcPad software	GPScorrect help, or www.trimble.com/gpsccorrect.shtml
Messaging (Inbox)	Pocket PC help
Internet Explorer	Pocket PC help
Microsoft ActiveSync® technology	ActiveSync help
Specifications and accessories for GeoExplorer 2005 series handhelds	www.trimble.com/geoxm.shtml , www.trimble.com/geoxt.shtml , or www.trimble.com/geoxh.shtml
TerraSync™ software	www.trimble.com/terrasync.shtml , or the <i>TerraSync Software Getting Started Guide</i>

System Components

This section lists the components of the GeoExplorer 2005 series system.

What's in the box?

When you receive your GeoExplorer 2005 series handheld, check that you have received all the components, as detailed on the packing list. The standard components are shown below. Depending on the system that you have purchased, you may have received additional components.

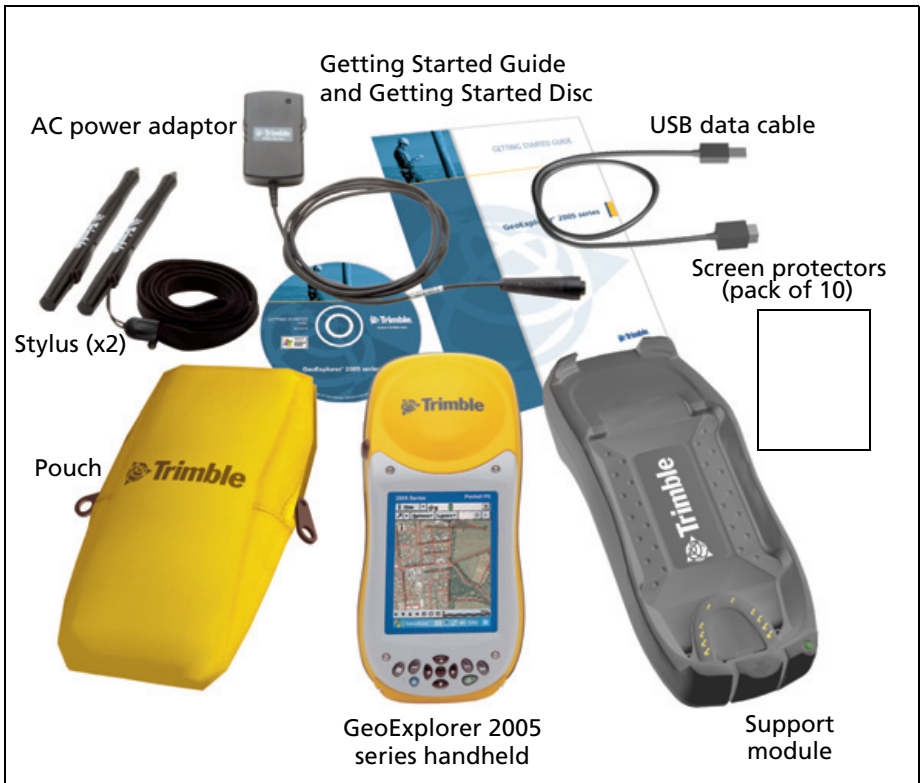

Inspecting the system

Inspect all contents for visible damage (scratches, dents) and if any components appear damaged, notify the shipping carrier. Keep the shipping and packaging material for the carrier's inspection.

Accessories

The following optional accessories are available:

- Power/serial clip
- Vehicle power adaptor¹
- External power kit
- Pole-mountable ground plane
- Baseball cap with antenna sleeve
- Screen protectors (10 pack)
- Stylus kit
- Backpack kit
- Hard carry case
- Null modem cable¹
- GeoBeacon™ receiver (receives differential corrections from a beacon network)
- Range pole
- Range pole bracket
- External patch antennas²
- Hurricane antenna kit²
- Zephyr™ antenna kit³

¹Requires power / serial clip (sold separately)

















²Compatible with GeoXM/XT/XH handhelds for improved accuracy.

³Compatible with GeoXH handheld for improved accuracy.

For more information, visit the Trimble website at www.trimble.com/geoxm.shtml, www.trimble.com/geoxt.shtml, or www.trimble.com/geoxh.shtml.

Pre-installed software

The following software is pre-installed on the GeoExplorer 2005 series handheld:

Software	Function
 ActiveSync	Synchronize information between the handheld and a computer.
 Calculator	Perform basic arithmetic functions.
 Calendar	Keep track of appointments and arrange meetings.
 Contacts	Keep track of your friends and colleagues.
 File Explorer	View and manage files.
 GPS	Located in Settings / System, it allows you to configure the NMEA port (COM2) to be used with more than one application.
 GPS Connector	Configure communications between the handheld's integrated GPS receiver and external devices.
 GPS Controller	Configure and view status information for the integrated GPS receiver.
 Internet Explorer	Browse the World Wide Web.
 Messaging (Inbox)	Write, send, and receive e-mail messages.
 Notes	Create handwritten, typed, or recorded notes.
 Pictures and Videos	Take, view, and edit pictures, as well as record and launch video clips.
 PowerPoint Mobile	View slide show presentations.
 Excel Mobile	Create and edit Excel spreadsheets.
 Word Mobile	Create and edit Word documents.
 Tasks	Keep track of your tasks.
 Windows Media	Play Windows Media or MP3 audio and video files.

Parts of the GeoExplorer 2005 series handheld

The following pages show the main features of the handheld.

Integrated GPS receiver

- High-performance
- Integrated SBAS (WAAS / EGNOS / MSAS) receiver
- EVEREST multipath rejection technology (GeoXT and GeoXH only)
- H-Star technology (GeoXH only) for improved accuracy with shorter occupation times

External antenna connector

Connection to an optional external GPS antenna.

Integrated Bluetooth and WLAN radios

- Connect to external devices using Bluetooth™ wireless technology.
- Connect to networks and the Internet using Wireless Local Area Network (WLAN) connectivity.

Pocket PC

Field computer running Windows Mobile Version 5.0 software for Pocket PC.

Advanced TFT color display

- 16-bit color (65,536 colors)
- Interactive touch screen
- ¼ VGA display
- Backlight

Keypad

Provides 11 buttons for fast, easy access to common actions, including OK and Start. Also provides Display and Power buttons, and buttons for navigation (see [page 7](#)).

Microphone

Run Notes and use the Recording toolbar to record.

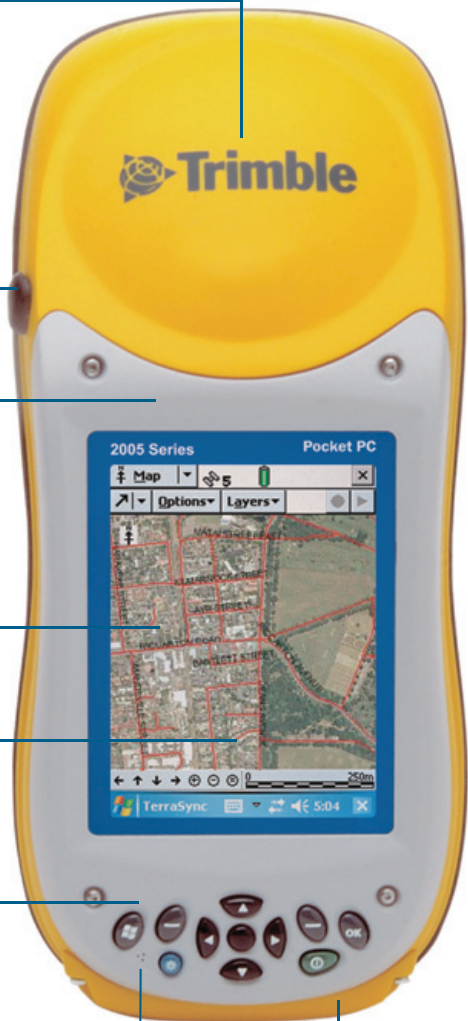

SD card slot

Provides removable storage using SD (Secure Digital) memory cards (see [page 40](#)).

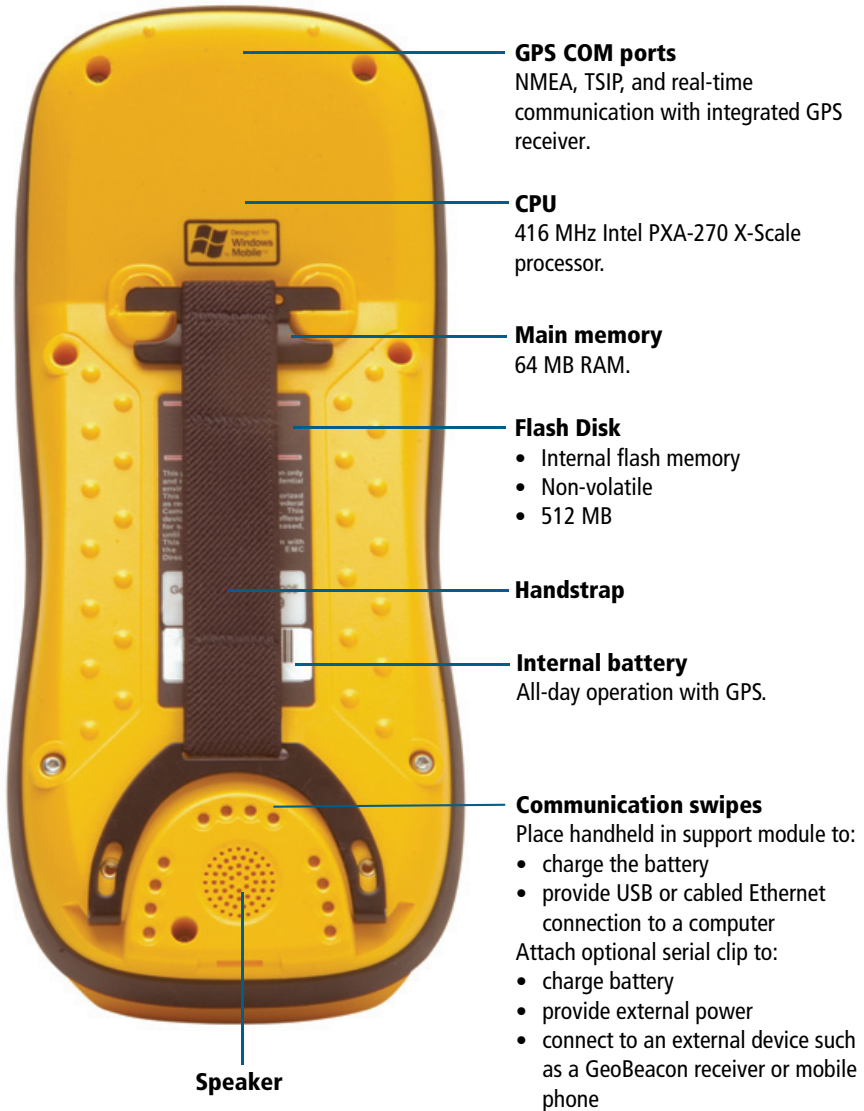

Keypad

Provides 11 buttons for fast, easy access to common actions. The diagram below provides information about each button.

Application buttons

Perform application-specific actions.

- Left button: performs the same action as the softkey on the left of the menu bar.
- Right button: performs the same action as the softkey on the right of the menu bar

When no softkeys are shown in the menu bar, pressing either application key has no effect.

Start button

Displays the *Start* drop-down menu.

OK button

Press to select OK, Enter, or to close an application.

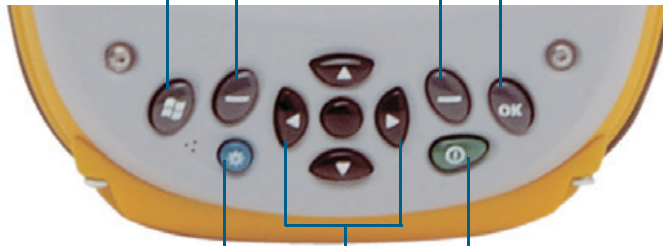

Display button

Press to turn on or turn off the backlight. Press the **Display** button and the **Start** button at the same time to align the touch screen (see [page 9](#)).

Navigation buttons

Provide directional controls for moving around the screen.

- Arrow buttons: move up, down, left, and right.
- Action button: performs an application-specific action, usually Enter.

Power button

Press to turn on the handheld, or to put it into Suspend mode. A 5-second press performs a soft reset. A 15-second press performs a soft reset and powers off the handheld.

Getting Started

Follow the steps below to get started with the GeoExplorer 2005 series handheld. For information on using Windows Mobile software, see [Windows Mobile Basics, page 11](#).

Charge the battery

Before using the handheld for the first time, you must charge the battery.

Connect one end of the AC adaptor cable to the support module and the other to an AC power outlet. Put the handheld in the support module as shown below.



Leave to charge for up to eight hours. For more information, see [Power, page 34](#).

To remove the handheld from the support module, press the release button on the support module, then lift the bottom of the handheld upward.



Turn on and suspend

Press and release the **Power** button to turn on or to suspend the handheld.

For more information, see [Suspend mode, page 38](#).



Align the touch screen

The first time you turn on your handheld, you are prompted to align the touch screen. Follow the on-screen instructions to align the touch screen.

If at any time the touch screen does not respond properly to stylus taps, realign it. To begin the alignment sequence, press the **Display** button and the **Start** button at the same time and follow the on-screen instructions.

Turn on the backlight

The touch screen is visible in all conditions, including bright sunlight. Press the **Display** button to turn the backlight on or off.

To adjust the backlight, use the Backlight control (see [Backlight, page 75](#)).

The **Display** button overrides settings in the Backlight control. To turn on the backlight again, use the **Display** button.



Set the time zone

To set the clock to your local time, the handheld uses the GPS time reported by the integrated GPS receiver and the time zone that you specify. In the *Today* screen, tap the clock icon . The *Clock Settings* screen appears. Tap the *Time* tab, select the *Home* option and then select the correct time zone.

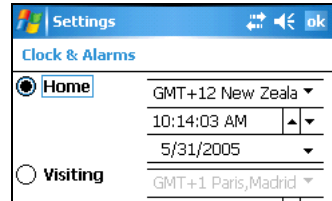

Install and activate software

Connect the handheld to a computer and use ActiveSync technology to install or activate any software you need. For more information, see [Installing Software, page 19](#).

Use GPS

The integrated GPS receiver is switched off until an application opens one of the GPS COM ports. To use GPS, take the handheld outside to a location with a clear view of the sky. From the *Today* screen, tap the *GPS* softkey in the menu bar. The skyplot of the default GPS software appears. Depending on the software you have installed, this will be GPS Controller, TerraSync, or the GPSCorrect extension for ESRI ArcPad software. For more information, see [Using GPS, page 21](#).



Windows Mobile Basics

The GeoExplorer 2005 series handheld's operating system is based on the Windows Mobile Version 5.0 software for Pocket PC.

Parts of the screen

The main parts of the screen are shown below.

Start button

Tap to open the *Start* menu, where you can access programs and system controls.

Title bar

Contains status icons for important system functions.

Today screen

Summarizes your appointments, tasks, notes, and e-mails for the day. Tap any item to open it.

Start menu

Tap any item on the menu to open it.

Menu bar



Contains softkeys providing access to applications, menus, and notifications.

GPS softkey

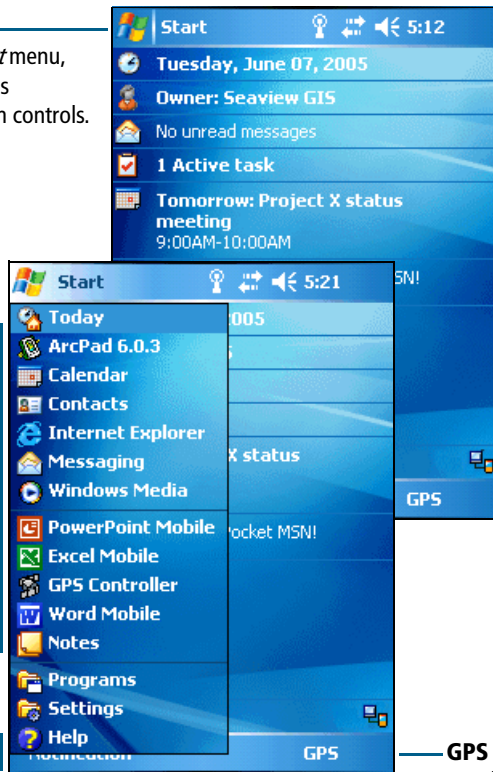
Tap the GPS softkey, or press the right application button on the keypad, to open the skyplot of the default GPS software.



Accessing help

To access help, tap  / *Help* or, if available, tap  in the application window. If there is an application running, context-sensitive help for the current screen appears. To view the main Help Contents page, tap the *Contents* softkey in the menu bar.

Help files installed on the handheld work in the same way as a Web page. Tap hyperlinks to navigate around the help and use  to retrace your steps. Tap *View / Contents* to return to the Contents page for the application, and tap *View / All Installed Help* to return to the main Contents page.

Using the stylus

To interact with the handheld, use the stylus to tap on the touch screen. There are three types of action you can perform with the stylus:

Action	Definition
Tap	Touch the screen once with the stylus to open items and select options.
Tap and hold	Tap and hold the stylus on an item to see a list of actions available for that item. On the pop-up menu that appears, tap the action you want to perform.
Drag	Hold the stylus on the screen and drag across the screen to select text and images. Drag in a list to select multiple items.

The stylus also provides a screwdriver under the cap that you can use to remove and reattach the SD door (see [SD memory cards, page 40](#)).

Entering text

The handheld does not have a physical keyboard. To enter text, use an on-screen keyboard. Alternatively, you can write directly onto the screen.

You can select how you want to enter text using the Input Panel. The Input Panel automatically appears in the menu bar of any application. The default selection is the on-screen keyboard.

To change the text input method:

1. In the menu bar, tap the arrow on the **Input Panel** button. (You may have to activate and then hide the keyboard for the arrow to appear.)
A list of input methods pops up. The currently selected method is indicated by a check mark.
2. Tap the method you want to use to select it.

Using the on-screen keyboard

To activate the on-screen keyboard, tap the keyboard icon  on the Input Panel displayed in the menu bar. The on-screen keyboard appears.

To enter text, tap the appropriate keys on the on-screen keyboard. When you have finished entering text in a field, tap **Tab** to accept the text you have entered and move to the next field.

To hide the keyboard, tap the keyboard icon again.



Input panel showing keyboard icon

Writing on screen

When you select Transcriber, you can write directly onto the screen using the stylus. The Microsoft Transcriber software converts your handwriting to text. You can use it to enter notes in a text editor such as Notes.

To select Transcriber:

1. Tap the arrow on the **Input Panel** button displayed in the menu bar. A list of input methods pops up.
2. Tap *Transcriber*. The *Transcriber Intro* dialog appears.
3. Tap **OK**.

The Transcriber icon  appears in the menu bar, and the Transcriber keyboard appears above the menu bar.

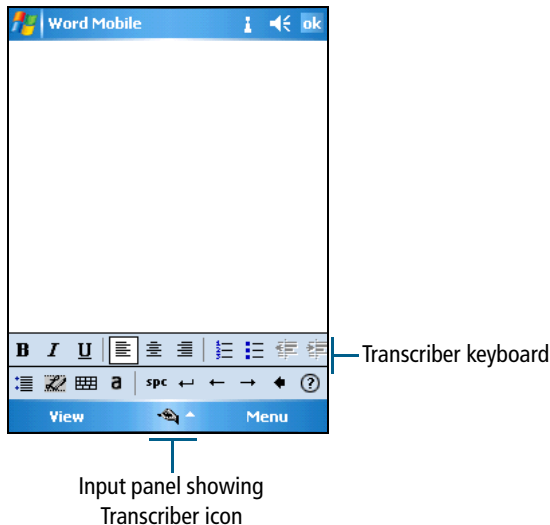

Transcriber has a number of tools and modes that allow you to customize how it works. These tools and modes are controlled from the Transcriber keyboard. For more information, refer to the Transcriber Help.

ActiveSync Connections

You can use Microsoft ActiveSync technology to connect the GeoExplorer 2005 series handheld to an office computer and exchange information between the two devices.

This section provides information on:

- using ActiveSync technology
- connecting the handheld to a computer

ActiveSync version 4.0 and later is compatible with the GeoExplorer 2005 series handheld.

Note – *If you do not have ActiveSync version 4.0 or later installed on your computer, you can install it from the GeoExplorer 2005 Series Getting Started Disc. To download the latest version, or a translated version of ActiveSync, you can download it from the Microsoft website at www.microsoft.com/windowsmobile.*

Connecting the handheld to a computer

You can connect the handheld to a computer using the following:

- the support module connected to a USB port on a computer
- a Bluetooth wireless connection

Once the handheld and computer are physically connected, use ActiveSync technology to establish a relationship between the two devices.

Note – *ActiveSync version 4.0 does not support connections to an office computer using the serial clip, or a wireless LAN or cabled Ethernet connection. For information on using these types of connections, see [Using the Optional Serial Clip, page 68](#), [Using the WLAN Radio, page 63](#), and [Using Cabled Ethernet, page 66](#).*

Support module USB cabled connection

The support module provides a fast, simple USB connection between the GeoExplorer 2005 series handheld and a computer. To connect to a computer using a USB connection:

1. Connect the USB data cable to the USB port on the support module.

Place the handheld in the support module. For information about how to do this, see [Getting Started, page 8](#).



2. Connect the other end of the USB data cable to a USB port on the computer.

Bluetooth wireless connection

You can use the GeoExplorer 2005 series handheld's integrated Bluetooth radio to establish a wireless serial connection to a Bluetooth-enabled office computer. See [Using the Bluetooth Radio, page 51](#).

Using ActiveSync technology

You can use ActiveSync technology to:

- Synchronize information between a computer and the handheld so that you have the latest information in all locations.
- Change synchronization settings so that synchronization occurs automatically.
- Copy files between the handheld and a computer.
- Install software applications onto the handheld.

Note – *If you do not have ActiveSync version 4.0 or later installed on your computer, you can install it from the GeoExplorer 2005 Series Getting Started Disc. To download the latest version, or a translated version of ActiveSync, you can download it from the Microsoft website at www.microsoft.com/windowsmobile.*

To use ActiveSync technology:

1. If necessary, install ActiveSync version 4.0 or later on the computer.
2. Connect the handheld to the computer (see [page 15](#)). The Synchronization Setup Wizard appears automatically.

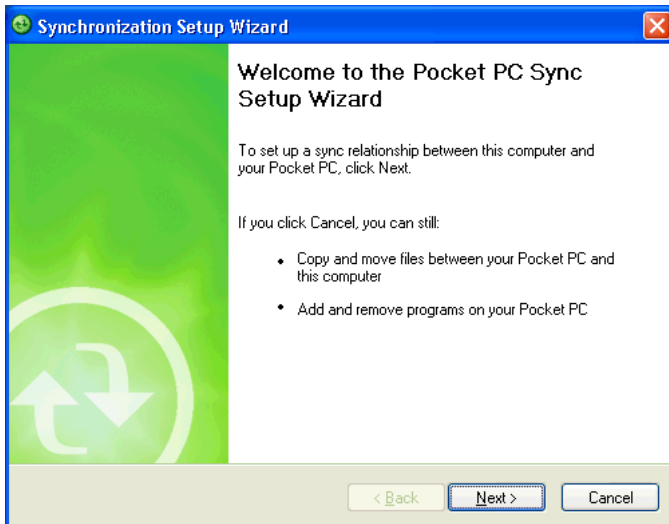

Note – If the connection is not made automatically, check that the connection has been enabled in the ActiveSync software and on the handheld. For more information, see [Troubleshooting, page 78](#).

- Follow the instructions on the office computer screen to connect the handheld to the computer. You can establish two types of connections with ActiveSync: a **partnership** or a **guest** relationship.

Information about a partnership is stored permanently on the computer. You can use a partnership to synchronize files between the handheld and a computer. If you are going to connect to the same computer regularly, you should establish a partnership. A **guest** relationship lasts only as long as the handheld and the computer are connected.

- If you selected a partnership, use the ActiveSync software to configure the synchronization settings for your selected applications (for example, Messaging or Calendar).

For more information, refer to the *ActiveSync Help*.

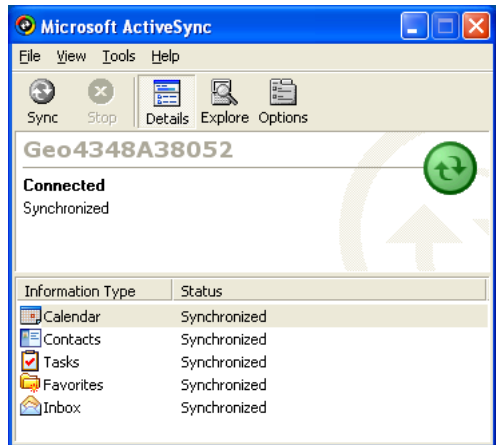

Tip – If you have GPS Pathfinder® Office software version 3.10 or later installed on your office computer, you can configure the Connection Manager utility in the GPS Pathfinder Office software to automatically detect when you connect a GeoExplorer 2005 series handheld to the computer. This will enable you to automatically transfer data from TerraSync software, differentially correct the data, and then export it to a GIS. For more information, refer to the GPS Pathfinder Office Help.

Installing Software

The GeoExplorer 2005 series handheld supports software designed to run on Windows Mobile-based devices. You may also be able to install and run some software designed for other operating systems.

To install software on the handheld, first establish an ActiveSync connection to a computer (see [ActiveSync Connections](#), page 15). Then follow the installation instructions that are provided with the software. If no instructions are provided, run the program file (.exe file) on a computer:

- If the file is an installer, the installation wizard will begin. Follow the instructions on the screen. Once the software is installed on the computer, the installer will automatically transfer it to the handheld.
- If the file is not an installer, an error message appears, stating that the program is valid but designed for a different type of computer. Use ActiveSync technology to copy the file to the Program Files folder on the handheld.

Note – *If an SD (Secure Digital) memory card is inserted in the handheld, the card appears as an installation location option. Trimble recommends that you install software to the handheld's flash disk, not to an SD memory card. If you install software to a card and then remove the card from the handheld, the software will not be available for use.*

Installing TerraSync software

You can install version 2.52 or later of the TerraSync software on a GeoExplorer 2005 series handheld.

To install the TerraSync software, either insert the *TerraSync Software CD* in the CD-ROM drive of a computer and use the menus provided, or run the downloaded setup file. To obtain a serial number for installation, you must register your copy of the software online. Detailed installation instructions are provided in the *TerraSync Software Release Notes*.

Installing ArcPad software

You can install version 6.0.3 of the ESRI ArcPad software on a GeoExplorer 2005 series handheld. Detailed installation instructions for ESRI ArcPad are provided in the ArcPad documentation.

Note – You must install the ArcPAD 6.0.3 QFE patch after installing the software. This patch fixes display issues seen in Windows Mobile software. For more information, visit <http://support.esri.com/index.cfm>, select the Downloads tab and then select the Patches and Service Packs link.

Installing the GPSCorrect extension

You can install version 1.11 or later of the Trimble GPSCorrect extension for ESRI ArcPad software on a GeoExplorer 2005 series handheld. Make sure you install version 6.0.3 of the ArcPad software before you install the GPSCorrect extension.

To install the GPSCorrect extension, either insert the *Trimble GPSCorrect Extension for ESRI ArcPad Software CD* in the CD-ROM drive of a computer and use the menus provided, or run the downloaded setup file. Detailed installation instructions are provided in the *GPSCorrect Extension Release Notes*.

Using the GPS Analyst extension

You can also use the GeoExplorer 2005 series handheld with the Trimble GPS Analyst™ extension for ESRI ArcGIS software. Connect the GeoExplorer handheld to a Tablet PC or laptop running version 1.20 or later of the GPS Analyst extension and use the handheld as your GPS receiver. Run ArcMap software, and use the GPS Analyst extension to collect GPS data.

Using GPS

The GeoExplorer 2005 series handheld provides an integrated GPS receiver that enables you to use GPS data.

***Note** – Before you can use GPS, you may need to configure the application to connect to GPS (see [Configuring a GPS application](#), page 23).*

This section provides information on:

- getting a clear view of the sky (see [page 22](#))
- GPS COM ports (see [page 22](#))
- configuring a GPS application to connect to GPS (see [page 23](#))
- configuring GPS quality control settings to suit your requirements and the current GPS conditions (see [page 24](#))
- using mission planning to identify the best times of the day for working with GPS (see [page 26](#))
- using real-time differential corrections for better accuracy (see [page 28](#))
- the level of accuracy provided by GeoExplorer 2005 series handhelds (see [page 29](#))
- factors that affect accuracy and how to improve accuracy (see [page 30](#))
- differential GPS (see [page 32](#))

What is GPS?

The Global Positioning System (GPS) is a satellite-based positioning system operated by the U.S. Department of Defense (DoD). A constellation of operational NAVSTAR satellites orbit the earth every 12 hours, providing worldwide, all-weather, 24-hour time and position information.

For more information about how GPS works, visit the Trimble website at www.trimble.com/gps/.

Getting a clear view of the sky

To receive signals from GPS satellites, the receiver must have a clear view of the sky. **GPS does not work indoors.** Hold the handheld with the screen toward you. The internal antenna is located above the screen under the Trimble logo. You do not have to hold the handheld perfectly level, but keep the antenna facing upward, not downward or sideways.

Anything that blocks light also blocks signals. Satellite signals can be blocked by people, buildings, heavy tree cover, large vehicles, or powerful transmitters. GPS signals can go through leaves, plastic, and glass, but these all weaken the signal.

GPS COM ports

The integrated GPS receiver has three COM ports for communicating with software on the handheld and with external devices.





Using GPS is as simple as opening the appropriate GPS COM port. Each port is used for a particular type of communication:

Port	Function	Description
COM2	NMEA	Outputs NMEA-0183 messages. NMEA is a standard GPS communication protocol used by most GPS applications. The handheld outputs the following NMEA messages: GGA, GLL, GSA, GSV, RMC, VTG, ZDA. All messages are output at a one second interval.
COM3	TSIP	Outputs and receives TSIP messages. TSIP (Trimble Standard Interface Protocol) is used by Trimble GPS applications, and is also supported by some other GPS applications.
COM4	Real-time	Receives RTCM real-time correction messages. If you are using an external correction source connected to COM1 or a Bluetooth port, the corrections must be redirected to COM4. For more information, see Using real-time corrections from other sources, page 28 .

Note – COM1 is a standard serial port that connects to external devices. For more information, see [Using the Optional Serial Clip, page 68](#).

Configuring a GPS application

The first time you use GPS software on the handheld, you may need to specify which GPS COM port to connect to. Specify COM2 if the software uses NMEA, or COM3 if the software uses TSIP. If you are not sure which protocol to use, check the documentation for the software.

If you are using ...	do this ...
GPS Controller	Run GPS Controller. The software automatically activates the integrated GPS receiver on COM3.
TerraSync	Run Terrasync. The software automatically activates the integrated GPS receiver on COM3.
ArcPad with the GPScorrect extension	<ol style="list-style-type: none"> 1. Within ArcPad, tap the GPS button . The software activates the integrated GPS receiver on COM3. 2. If you want to configure GPS and real-time, or view status information, run the GPScorrect extension. In the Trimble toolbar, tap the GPScorrect button.
ArcPad	<ol style="list-style-type: none"> 1. In ArcPad, tap the Tools button . 2. In the <i>Protocol</i> field select NMEA 0183. 3. Tap the <i>GPS</i> tab and from the <i>Port</i> field select COM2. 4. Tap OK. 5. Tap the GPS button . The software activates the integrated GPS receiver. <p> Tip – ArcPad can also connect using the TSIP protocol. However, if you use the NMEA protocol, you can run GPS Controller at the same time for advanced GPS and real-time configuration and status information.</p>
NMEA application	Configure the software to connect to GPS on COM2, then use the Connect or Activate GPS command.
TSIP application	Configure the software to connect to GPS on COM3, then use the Connect or Activate GPS command.

Only software that is running on the handheld can connect directly to a GPS COM port. To supply GPS data to an *external* device, use GPS Connector to redirect the output from the appropriate GPS COM port to the serial port (COM1) or to a Bluetooth port. Then configure the external device to connect to that serial or Bluetooth port. For more information, see [GPS Connector, page 28](#).

Using your GPS application

By default, the handheld is configured to receive satellite signals in most conditions. The GPS Controller software is pre-installed on all GeoExplorer 2005 series handhelds to enable you to check the current GPS status, or to configure the integrated GPS receiver.

To run GPS Controller, do one of the following:

- From the *Today* screen, tap the *GPS* softkey in the menu bar.
- Tap  / *Programs* / *GPS Controller*.

Note – *GPS Controller* duplicates the status and setup features of *TerraSync* software and the *GPSCorrect* extension for *ESRI ArcPad* software. If one of these applications is installed, it runs instead of *GPS Controller* when you tap the *GPS* softkey in the menu bar of the *Today* screen. For more information about these applications, refer to the documentation for the application.

Use the graphical Skyplot section or the Satellite Info section to view detailed GPS information, and to adjust the quality and yield of the GPS positions you are receiving.

The GPS Controller software includes a Plan section for mission planning (see [Planning a data collection session, page 26](#)) and a Real-time section for configuring and monitoring real-time correction sources (see [Using real-time corrections from other sources, page 28](#)).

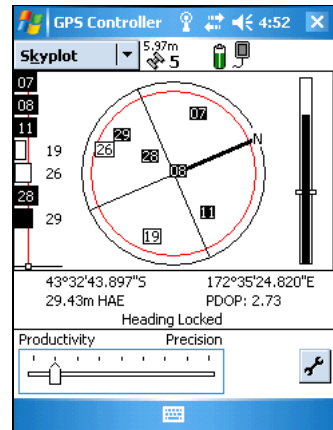

For more information on any GPS Controller section or function, refer to the *GPS Controller Help*.

Configuring GPS settings

Use the *GPS Settings* form in the GPS Controller software to configure the settings you require for GPS positions.

To open the *GPS Settings* form, do one of the following:

- Tap **GPS Settings** in the Setup section.
- Tap  in the Skyplot, Satellite Info, or Plan section.

Selecting predefined settings using the GPS slider

Use the GPS slider to select predefined settings.

To use the slider, select the slider check box. The slider control appears on the GPS slider, and some fields in the form become read-only. The values in these fields change as the slider control position changes.

Drag the slider control to the left to decrease the GPS precision and include more satellites in GPS position calculations. Drag it to the right to increase the GPS precision and exclude satellites that do not meet the precision requirements from GPS position calculations. For more information, see [Factors that affect accuracy](#), page 30.

Selecting custom GPS settings

To select custom GPS settings, clear the slider check box. The slider control disappears from the GPS slider, and the remaining fields change to editable numeric fields. To specify the required GPS settings, enter values in these fields.

Configuring velocity filtering

You can use velocity filtering to smooth GPS positions when collecting lines or areas in high multipath environments. To apply velocity filtering, you must:

1. Configure Velocity Filtering to *Auto* on the *GPS Settings* form.
2. Use real-time corrections, or collect data with SuperCorrect set to *On* in the TerraSync software or GPScorrect extension.

Resetting GPS

Trimble GPS applications all have options to reset the receiver to:

- delete the almanac
- delete information stored on the last known position
- restart the receiver
- reset the GPS receiver to factory defaults

Planning a data collection session

To maximize productivity, plan GPS data collection around the times of the day when satellite geometry is best. The GPS Controller software includes a Plan section with an animated skyplot and DOP (satellite geometry) graph for your position for the next 12 hours.

In the Plan section, you can check the planning skyplot as you play a session, then use the timeline to zoom in on times when geometry is poor. As you adjust GPS settings, the Plan section is updated, so you can see the effect of different quality control settings.

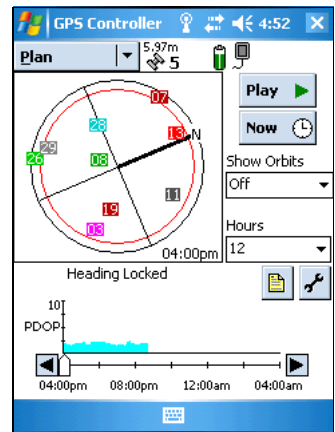

Note – If TerraSync software or the GPScorrect extension for ArcPad is installed, use the planning feature in that application instead of the GPS Controller software.

Using SBAS corrections



The GeoExplorer 2005 series handheld has an integrated receiver that uses Satellite Based Augmentation Systems (SBAS) correction messages to improve the accuracy and integrity of GPS data.

The receiver tracks SBAS satellites according to their geographical location:

- Wide Area Augmentation System (WAAS) satellites between 40° W and 180° W, and between 10° N and 90° N.
- European Geostationary Navigation Overlay Service (EGNOS) satellites between 40° W and 60° E, and between 10° N and 90° N.
- MTSAT Satellite-based Augmentation System (MSAS) satellites between 120° E and 165° E.

You can use the default zones, or configure the receiver to use particular SBAS satellites in the *Integrated SBAS Settings* form.

To use SBAS corrections:

1. In the GPS Controller software, open the Real-time section and tap the **Setup** button .
2. In the *Choice 1* field, select Integrated SBAS. To select particular satellites, tap the **Setup** button  next to the *Choice 1* field.
3. In the *Choice 2* field, specify whether to use uncorrected positions, or to stop using GPS positions, if corrections are not available.
4. Tap **OK**.

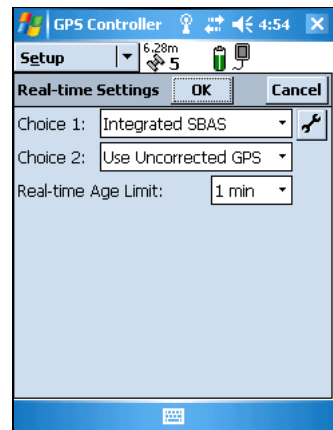

Note – If TerraSync software or the GPSCorrect extension for ArcPad is installed, configure real-time settings in that application instead of the GPS Controller software.

Using real-time corrections from other sources

You can use corrections from an external correction source, such as a GeoBeacon receiver, a DGPS radio, or a mobile phone. The external correction source can be connected to a Bluetooth port or to the optional serial clip (COM1). Use the GPS Controller software to set up and monitor the real-time input source that you want to use.

Note – *If TerraSync software or the GPScorrect extension for ArcPad is installed, configure real-time settings in that application instead of the GPS Controller software.*

The integrated GPS receiver communicates only through its GPS COM ports (COM2, COM3, and COM4). Input from an external correction source connected to COM1 or to a Bluetooth port must be redirected to the real-time GPS COM port (COM4). Trimble applications, such as GPS Controller, handle the redirection automatically. If you are using any other application to set up and monitor real-time sources, use GPS Connector to redirect the input to COM4 (see below).

GPS Connector

The GPS Connector software is pre-installed on all GeoExplorer 2005 series handhelds. To open GPS Connector, tap  / *Settings / Connections / GPS Connector*.

The GPS Connector software lets you connect the GPS COM ports to COM1 or Bluetooth ports and configure port settings such as the baud rate. GPS Connector software has a graphical display that shows all active connections, and a text display that shows connection messages.

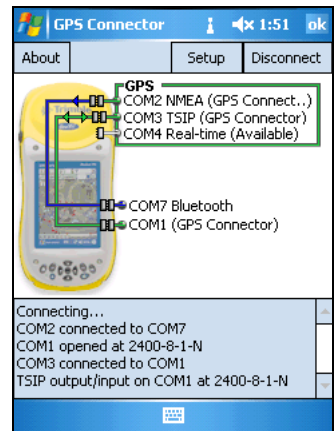

Use the GPS Connector software to output NMEA or TSIP messages from the integrated GPS receiver to another device, such as an external data collector.

Note – If you are using a Bluetooth port, enable and configure the Bluetooth Serial Port service **before** you connect to the port.

The connections that you create in the GPS Connector software are only active while the software is running.

Connections created by the GPS Connector software are labeled GPS Connector in the status screen and end when you exit the software.

For more information, refer to the *GPS Connector Help*.

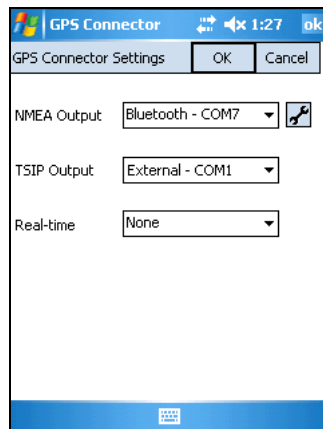

Antennas

The GeoExplorer 2005 series handheld has an internal antenna, which is suitable for use in most conditions. You can also connect a Hurricane or an external patch antenna for when you work in a vehicle. For improved yield under canopy, you can use a patch antenna with a Hurricane antenna or a ground plane.

If you have a GeoXH handheld, you can connect an external Zephyr antenna for improved accuracy when you collect data using H-Star technology (see [Maintaining Accuracy](#) below).

Maintaining Accuracy

GeoExplorer 2005 series handhelds are high performance GPS receivers that calculate very accurate GPS positions. The GeoXM handheld provides reliable accuracy within 1 to 3 meters. The GeoXT and GeoXH handhelds use EVEREST multipath rejection technology to provide submeter accuracy.

Note – All accuracy figures are for both real-time and postprocessed differentially corrected positions, unless otherwise stated.

In addition, the GeoXH handheld enables you to use H-Star technology to provide to obtain 30 cm (subfoot) postprocessed accuracy for static GPS positions. Using an external Zephyr antenna, the GeoXH receiver is capable of providing postprocessed accuracy of 20 cm (8 inches) or better for static GPS positions.

Note – Accuracy estimates for streaming (dynamic) GPS positions may be larger than 20 cm (using the external Zephyr antenna) or 30 cm (using the internal antenna).

Factors that affect accuracy

As discussed above, the accuracy that you obtain from your GeoExplorer 2005 series handheld is affected by the receiver model, the type of antenna used, whether the data is differentially corrected in real-time or after data collection, and whether you are logging a point feature using static GPS positions, or a line or area feature using streaming GPS positions.

The table below lists several other factors that affect the accuracy obtained from your receiver, and recommends ways to minimize their effect.

Factor	Description	To Maximize Accuracy
Number of visible satellites	The accuracy of your data increases with the number of satellites being used to calculate the position.	You need at least four satellites to calculate an accurate 3-dimensional position. Trimble data collection software only logs GPS positions when four or more satellites are visible. Tracking more satellites can help to lower DOP values.
Multipath	Multipath is when GPS satellite signals are reflected off nearby objects, such as buildings or cars, causing an erroneous signal to be received by the GPS antenna. This can cause errors of several meters.	To reduce multipath, collect data in an open environment away from large reflective surfaces and with a clear view of the sky. In high multipath environments, record velocity data and use velocity filtering when postprocessing the data.

Factor	Description	To Maximize Accuracy
Poor satellite geometry	Dilution of Precision (DOP) is a measure of the quality of GPS positions, based on the spread (geometry) of the satellites in the sky that are used to compute the positions. When satellites are widely spaced relative to each other, the PDOP value is lower, and position accuracy is greater. If the view of the sky is partially blocked, or if all of the satellites are in one area of the sky, the geometry and DOP may be poor.	Set your GPS application to ignore positions with a poor DOP value. You can choose to filter positions based on PDOP (Position Dilution of Precision) or HDOP (Horizontal Dilution of Precision). PDOP is a measure of the horizontal and vertical quality of the GPS positions, whereas HDOP is just a measure of the horizontal precision (x and y coordinates). Select HDOP rather than PDOP if you want to ensure positions are accurate horizontally, and when vertical accuracy is less important. Trimble recommends a maximum PDOP setting of 6, or a maximum HDOP setting of 4.
Weak satellite signals	Signal-to-Noise Ratio (SNR) is a measure of the strength of the satellite signal relative to the background noise. Accuracy degrades as the signal strength decreases. Weak signals may be caused by signals coming through vegetation, multipath signals, or low satellite elevation.	Set your GPS application to ignore satellites with a weak SNR. Trimble recommends a minimum SNR setting of 39 dBHz.
Satellite elevation	When a satellite is low on the horizon, satellite signals must travel farther through the atmosphere. This results in a lower signal strength and delayed reception by the GPS receiver, which can cause errors in calculating the position.	Set the elevation field in your data collection software to ignore satellites that are low in the sky. Trimble recommends a minimum elevation setting of 15°.
Occupation time at a point	Occupation time is the time spent at a point logging GPS positions.	For point features, remain at the feature and log a number of GPS positions to obtain an averaged position. When collecting line and area features, collect them using averaged vertices.

Differential GPS

Use differential GPS to correct errors in your collected data. Differential GPS (DGPS) requires two or more receivers. One receiver, called the *reference station*, is located at a known point to determine the GPS measurement errors and compute corrections to these errors. An unlimited number of mobile GPS receivers, called *rovers*, collect GPS data at unknown locations within the vicinity of the reference station. Errors common at both the reference and rover receivers are corrected with DGPS either in real time or during postprocessing.

Real-time DGPS

In real-time DGPS, the reference station calculates and broadcasts the error for each satellite as each measurement is received, enabling you to immediately see differentially corrected data on the map displayed in the data collection software.

Real-time DGPS sources include external beacon and radio sources, as well as Satellite Based Augmentation Systems (SBAS) such as WAAS in the US and EGNOS in Europe, and Virtual Reference Station (VRS™) systems. SBAS and VRS systems use multiple reference stations in a network to calculate the DGPS corrections which are then delivered to the user from a Geostationary satellite (SBAS) or from a radio or cell phone (VRS).

Factors that affect real-time DGPS accuracy include how often the corrections are updated, and whether the coordinate system used by the correction source matches the coordinate system used by the GPS receiver.

Postprocessed DGPS

In postprocessed DGPS, the collected GPS data is transferred to an office computer, and measurements from the reference station are downloaded. Postprocessing software such as the GPS Pathfinder Office software or the Trimble GPS Analyst extension for ESRI ArcGIS software is used to differentially correct the collected data.

Postprocessed DGPS typically uses only one reference station, however, when differentially correcting data collected with GeoXH receivers using H-Star technology, you can select multiple reference stations to correct the file against for improved accuracy.

Factors that affect the accuracy of postprocessed DGPS include the distance between the reference station and the location where the rover data was collected, the accuracy of the reference station position, and the logging interval at the reference station.

For more information, refer to the documentation provided with your postprocessing software.

Postprocessed real-time DGPS

Postprocessed DGPS positions are generally more accurate than DGPS positions obtained in real time. If you collect SuperCorrect records, or H-Star data with the ProXH receiver, as well as GPS positions using the TerraSync software or the GPSCorrect extension, or using applications developed using the GPS Pathfinder Tools SDK, you can postprocess your files in the GPS Pathfinder Office software or the Trimble GPS Analyst extension to improve accuracy.

***Note** – For more information about GPS and DGPS, review the All About GPS tutorial available from the Trimble website at www.trimble.com/gps.*

Power

When fully charged, the internal battery of the handheld provides enough power for a full working day using GPS. To extend the time between charges, use the optional vehicle power adaptor (P/N 61235-00) or the external power kit (P/N 57123-00). Use the support module with the AC adaptor (P/N 61234-00) supplied with the international adaptor kit to recharge the internal battery.

Safety warnings

Battery safety



WARNING – The GeoExplorer 2005 series handheld is powered by an internal rechargeable Lithium-ion battery. Charge and use the battery only in strict accordance with the instructions provided.

To prevent injury or damage:

- Never attempt to remove, replace, or repair the battery yourself.
 - Do not damage the battery.
 - Do not store or leave your device near a heat source such as near a fireplace or other heat-generating appliance, or otherwise expose it to temperatures in excess of 70°C (158°F) such as on a vehicle dashboard. When heated to excessive temperatures, battery cells could explode or vent, posing a risk of fire.
 - Do not use the handheld if the battery appears to be leaking.
 - If the battery requires attention, send the handheld to your local Trimble Service center.
 - Discharge the handheld before disposing of the battery. When disposing of the battery, be sure to do so in an environmentally sensitive manner. Adhere to any local and national regulations concerning battery disposal or recycling.
-

AC adaptor safety



WARNING – To use AC adaptors safely:

- Use only the AC adaptor intended for the GeoExplorer 2005 series handheld. Using any other AC adaptor can damage your product and may void your warranty. Do not use the AC adaptor with any other product.
 - Make certain that the input voltage on the adaptor matches the voltage and frequency in your location.
 - Make certain that the adaptor has prongs compatible with your outlets.
 - AC adaptors are designed for indoor use only. Avoid using the AC adaptor in wet outdoor areas.
 - Unplug the AC adaptor from power when not in use.
 - Do not short the output connector.
 - There are no user-serviceable parts in this product.
 - Should damage to the AC adaptor occur, replace it with a new Trimble AC adaptor (P/N 61234-00).
-

Charging the internal Lithium-ion battery

The rechargeable Lithium-ion battery is supplied partially charged. Charge the battery completely before using it for the first time. If the battery has been stored for longer than six months, charge it before use. Trimble recommends charging the battery for eight hours to recharge it fully.

An international adaptor kit is provided with the GeoExplorer 2005 series handheld. To charge the handheld's internal battery, use the international adaptor kit connected to either the support module or the optional serial clip.

Note – *The GeoExplorer 2005 series handheld is not compatible with the AC adaptor or support module supplied with previous versions of the handheld (and vice versa). You must use the AC power adaptor (P/N 61234-00) and support module (P/N 53500-00) provided with the GeoExplorer 2005 series handheld.*

To charge the internal battery using the support module:

1. Use the AC power adaptor to connect the support module to mains power.
2. Place the handheld in the support module.
3. Leave for up to eight hours to recharge.



Note – The Power settings screen always shows 100% power for the backup battery. The handheld does not have a backup battery installed.

Using the support module with the AC power adaptor recharges the internal battery. In the office, leave the GeoExplorer 2005 series handheld in the support module to conserve the battery.

If you are not going to use the handheld for some time, either keep the handheld connected to mains power to continually charge it, or fully charge the handheld and switch it off. See [Storage, page 77](#).

Using external power

Use the optional serial clip to connect the GeoExplorer 2005 series handheld to an external power source. Depending on the optional accessories that you have purchased, you can use mains power, the external power kit, or a vehicle's battery to supply power to the handheld.



To connect to an external power source:

1. Attach the serial clip (P/N 53550-00) to the handheld.
2. Plug the appropriate cable into the power port on the serial clip.

Note – The GeoExplorer 2005 series handheld is not compatible with the serial clip supplied with previous versions of the handheld. You must use the **gray** serial clip (P/N 53550-00) provided with the GeoExplorer 2005 series handheld.

3. Connect the other end of the cable to the external power source.

To use power from ...	connect this ...	to ...
AC power source (mains power)	AC power adaptor supplied with the handheld	AC power outlet
external power kit battery	adaptor cable from optional external power kit (P/N 57123-00)	Lithium-ion battery provided as part of external power kit
vehicle battery	optional vehicle power adaptor (P/N 61235-00)	vehicle's cigarette lighter socket

Note – You must use the vehicle power adaptor (P/N 61235-00) or the Lithium-ion battery supplied with the external power kit (P/N 57123-00) provided with the GeoExplorer 2005 series handheld. These components are not compatible with previous versions of the GeoExplorer series handheld. Likewise, the GeoExplorer 2005 series handheld is not compatible with the 12V vehicle power adaptor or the 12V lead acid camcorder battery supplied with the external power kit used with previous versions of the handheld.

Recharging from an external power source

By default, the GeoExplorer 2005 series handheld recharges its internal battery from any external power source that is connected. Recharging the battery draws more power from the external source than is used to power the handheld.

Suspend mode

When you press the **Power** button to turn off the handheld, the handheld goes into Suspend mode. This is a low-power mode that maintains the main memory contents but does not allow you to operate any of the handheld's functions. The handheld appears to be turned off. The integrated GPS receiver is turned off and any application using GPS is disconnected.

To turn on the handheld when it is in Suspend mode, press the **Power** button. The handheld is ready for operation. There may be a delay of up to 30 seconds while the integrated GPS receiver automatically reactivates.

You can configure the handheld to automatically enter Suspend mode when it has been idle for a specified time. By default, the handheld is set to enter Suspend mode if the handheld is not used for three minutes.

To change the time to enter Suspend mode:

1. Tap  / *Settings* / *System* / *Power*.
2. Tap the *Advanced* tab.
3. From the *On battery power* group, select the *Turn off device if not used for* check box and select the idle time from the drop-down list.
4. Tap **OK**.

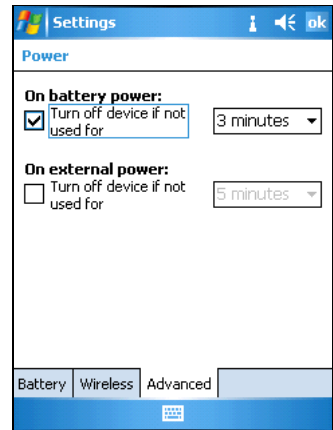

Conserving power

Although the handheld battery can operate for a full day without recharging, you should try to conserve battery power as much as possible. Follow these tips to reduce power consumption:



Power saving tips

- Set the handheld to automatically enter Suspend mode when idle. For more information, see [Suspend mode, page 38](#).
- Turn off the integrated Bluetooth or WLAN radios whenever you are not using them. For more information, see [Using the Bluetooth Radio, page 51](#) and [Using the WLAN Radio, page 63](#).
- Do not use the backlight, unless required. To turn off the backlight, press the **Display** button. You can also set the backlight to automatically turn off if the handheld has been idle for a specified time. For more information, see [Backlight, page 75](#).
- Disconnect from the integrated GPS receiver when GPS data is not required, using the application's Disconnect or Deactivate GPS option. When you disconnect from GPS, the integrated GPS receiver switches off and stops drawing power.

Note – Do not disconnect from GPS if you will be reconnecting within about five minutes. A GPS application can take up to 30 seconds to reactivate the integrated GPS receiver, so disconnecting to save power can cost time.

Memory

The handheld has two types of memory:

- **main memory** is similar to the RAM in a computer, and is used for running programs.
- **flash disk** is similar to the hard disk in a computer, and is used for storing programs and data.

Windows Mobile Version 5.0-based devices have persistent storage. All registry settings and data are stored on the non-volatile disk memory. RAM is not accessible for saving data, and is only used for running programs.

To check the memory capacity on the handheld, tap  / *Settings* / *System* / *Memory*. The Storage and Program columns show the current memory available, and the total memory (disk and RAM) that is already in use.

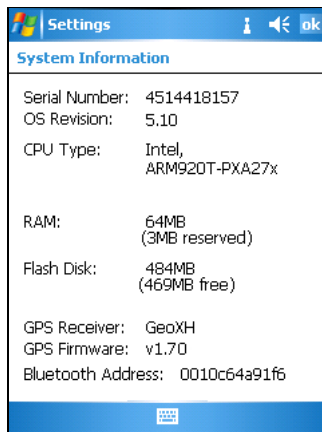

SD memory cards

To save data in an alternative location to the flash disk, the handheld has a **Secure Digital (SD) Memory Card** slot. You can use SD memory cards to make copies of information and to securely transfer data to and from another device with an SD slot.



WARNING – Static electricity can harm electronic components inside your device. To prevent static damage:

- Discharge static electricity from your body before you touch any of your device's electronic components, such as a memory module. You can do so by touching an unpainted metal surface.

Note – Do not store data to an SD memory card that you will require if the card is removed, for example an application. Data saved to an SD memory card is only available when the card is inserted in the handheld.

To insert an SD memory card:

Place the handheld on a dust-free indoor surface.



WARNING – The presence of any dust or moisture in the SD slot may adversely affect the device and void your Trimble warranty. To prevent dust or moisture entering the SD slot:

- Make certain that the SD door is attached correctly when you are using the handheld outdoors.
- When inserting or removing an SD card, place the handheld on a dust-free indoor surface.

1. Unscrew the stylus cap to access the screwdriver.

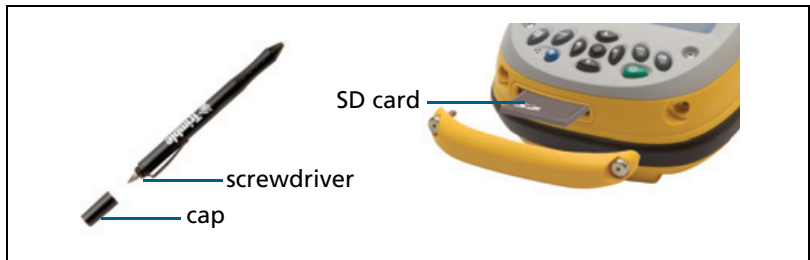

2. Use the screwdriver to undo both screws on the SD door.
3. Insert the SD memory card into the SD slot.

Note – The GeoExplorer 2005 series handheld does not support SDIO (SD input/output) cards.

4. Reattach the SD door, insert both screws and tighten. Ensure that it is attached correctly.
5. Replace the stylus cap.

To remove an SD memory card:

1. Remove the SD door (see steps 1 to 2 above).
2. To eject the SD card from the SD card slot, push the card in.

The card pops out.

3. Remove the card and, if you want to, insert a new SD card.
4. Reattach the SD door, insert both screws and tighten.
5. Replace the stylus cap.

Backing up data

Documents and program files that are stored on the flash disk are not affected by power loss or resetting. However, you can still lose data if you accidentally delete or overwrite it.



CAUTION – Windows Mobile Version 5.0 software does not include a Recycle Bin. When you delete files from the flash disk, they are deleted permanently.

To protect your data, Trimble recommends that you regularly copy important data to your office computer or to an SD memory card.

To back up files:

1. Connect the handheld to the computer using ActiveSync technology.
2. In ActiveSync, click **Explore**. Windows Explorer opens, showing the contents of the handheld.
3. Browse to the location of the files that you want to back up.
4. Select the files that you want to back up, and then copy them to the computer or to your SD memory card.

To restore files from a backup on a computer:

1. Connect the handheld to the computer using ActiveSync technology.
2. Copy files from the backup copy on the computer or your SD memory card to the handheld, overwriting the existing files.

Resetting the handheld

If the handheld stops responding to the stylus, or the screen goes blank, you may need to reset it.



Tip – If the screen is blank, low contrast may be the cause. Press the **Display** button to turn on the backlight.

To reset the GeoExplorer 2005 series handheld, hold down the Power button for 5 seconds to perform a soft reset.

If that does not work, hold down the **Power** button for 15 seconds to perform a soft reset and turn off the handheld. Then press the **Power** button to turn it on again.

***Note** – Files stored on the flash disk are **not** affected by a reset.*

Internet and Network Connections

You can connect to the Internet and your corporate network to browse the Internet or intranet, send and receive e-mail and instant messages, and access files on the network.

This section provides information on:

- connection methods
- setting up a dial-up modem connection (see [page 45](#))
- setting up a VPN server connection (see [page 46](#))
- setting up a mail service (see [page 47](#))
- connecting to the Internet (see [page 48](#))
- connecting to work (see [page 49](#))
- managing connections by ending, removing or changing existing connections (see [page 50](#))

Connection methods

You can connect to the Internet or a network using an external modem or mobile phone connected to the handheld using Bluetooth technology or the optional serial clip.

The simplest connection method is a wireless LAN (Local Area Network) connection using the GeoExplorer 2005 series handheld's integrated WLAN radio (see [Connecting to the Internet, page 48](#) and [Connecting to work, page 49](#)). For more information, see [Setting up a wireless LAN connection, page 64](#).

You can also connect to the internet or a network using **cabled Ethernet**. For more information, see [Using Cabled Ethernet, page 66](#).

Setting up connections

The GeoExplorer 2005 series handheld has two groups of connection settings: My ISP and My Work Network. My ISP settings are used to connect your device to the Internet, and My Work Network settings can be used to connect to any other private network, such as a corporate intranet you use at work.

You can set up a connection to store the configuration details for connecting to a particular computer or network, so that you do not have to enter these details each time you connect.

Set up a new dial-up modem connection or a Virtual Private Network (VPN) for each computer or network that you want to access remotely.

Setting up a dial-up modem connection

Before you begin, obtain the following information from your Internet Service provider or wireless service provider:

- ISP server phone number or access point
- user name and password

To set up a dial-up connection to an ISP or network:

1. Tap  / *Settings* / *Connections* / *Connections*.
2. From either the *My ISP* list or the *My Work Network* list, tap *Add a new modem connection*.
3. Enter a name for the connection.
4. From the *Select a modem* list, select a modem and then tap **Next**.
5. Enter the dial-up phone number for the connection.
6. If required, enter the user name, password and domain provided by the ISP or network administrator.

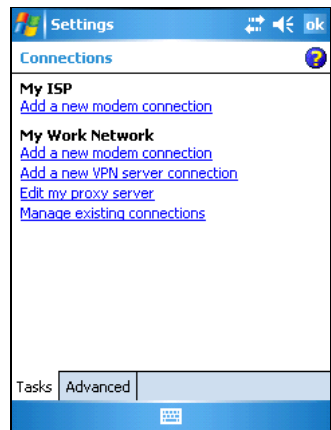

7. You should not need to configure advanced settings. However, if you want to change the connection preferences, tap **Advanced**.
8. Tap **OK**.
9. Tap **Finish**.





Tip – If you cannot connect with the default configuration or TCP/IP settings, contact your ISP or network administrator.

Setting up a VPN server connection

A Virtual Private Network (VPN) connection helps you to securely connect to servers, such as a corporate network, using the Internet. Before you begin, obtain the following information from your network administrator:

- user name and password
- domain name
- TCP/IP settings
- host name or IP address of the VPN server

To set up a VPN server connection to a network:

1. Tap  / *Settings* / *Connections* / *Connections*.
2. From the *My Work Network* list, tap *Add a new VPN server connection*.
3. Follow the instructions in the Make New Connection wizard. To view additional information for any screen in the wizard, tap .
4. Tap **Finish**.

Setting up a mail service

To connect to a mail server for sending and receiving e-mail, you need to create a mail service in the Messaging software. If you need to connect to different mailboxes, set up and name a different service for each connection.

Note – The Messaging software supports only the POP3 and IMAP4 protocols for incoming mail, and SMTP for outgoing mail.

To set up a mail service:

1. Tap  / *Messaging*.
2. Tap *Menu / Tools / New Account*.
3. In the *Name* field, enter a unique name for the account. Tap **Next**.
4. Follow the steps in the Setup wizard, using the connection details supplied by your ISP or network administrator.

Note – You cannot change the account name later.



Tip – To receive TerraSync data files by e-mail, tap **Options** and in the last page select the *Get full copy of messages* option from the drop-down list, as well as the *Get attachments* option if it is displayed.

5. Tap **Finish**.
6. Tap **OK** to download mail immediately, using a previously configured dial-up or wireless network connection.

Connecting to the Internet

Connect to the Internet using either:

- the wireless LAN connection you have set up and the handheld's internal WLAN radio.
- the dial-up modem connection you have set up and an external modem or mobile phone connected to the handheld using Bluetooth technology or the optional serial clip.

To **automatically** connect to the Internet, start using the desired program, for example Internet Explorer Mobile.

To manually connect to the Internet:

1. Set up either a wireless LAN connection (see [page 64](#)) or a dial-up modem connection (see [page 45](#)).
2. If you are using a wireless connection, remove the handheld from the support module.
3. If you are using a dial-up modem connection, connect to the external modem or mobile phone using either a Bluetooth connection (see [Bonding with a Bluetooth device, page 54](#)), or the optional serial clip (see [Connecting to external devices, page 69](#)).
4. Go to the Connection settings page, tap and hold the connection you want to use, and tap *Connect*.

If required, enter your user name, password, and domain, and then tap **Connect**.

5. Start using the desired program. For example, start Internet Explorer Mobile to browse the Web or an intranet. Use Messaging to send and receive e-mail. For more information, refer to the Help.



Connecting to work

Connect to a work network or intranet using either:

- the wireless LAN connection you have set up and the handheld's internal WLAN radio.
- the dial-up modem or VPN server connection you have set up and an external modem or mobile phone connected to the handheld using Bluetooth technology or the optional serial clip.

To **automatically** connect to the network, start using the desired program, for example Windows Explorer Mobile.

***Note** – If you have set up more than one wireless network connection, you may need to manually select the connection you want to use .*

To manually connect to work:

1. Set up a wireless LAN connection (see [page 64](#)), a VPN server connection (see [page 46](#)), or a dial-up modem connection (see [page 45](#)).
2. Remove the handheld from the support module.
3. Establish a physical connection between the handheld and the network. If you are using:
 - a wireless LAN connection, bring the handheld within range of the network so that the handheld's internal WLAN radio can locate it.
 - an external modem or mobile phone, connect it to the handheld using either a Bluetooth connection (see [Bonding with a Bluetooth device, page 54](#)), or the optional serial clip (see [Connecting to external devices, page 69](#)).
4. Go to the Connection settings page, tap and hold the connection you want to use and then tap *Connect*.
5. If required, enter your user name, password, and domain and then tap **Connect**.
6. Start using the desired program. For example, Windows Explorer Mobile to locate files on the network. For more information, refer to the Help.

Managing connections

You can change connection settings or remove existing connections. You can also end a connection at any time.

Ending a connection

To minimize mobile phone or Internet provider connection charges and to free resources on the handheld, end a connection when you have finished using it.

To end a connection when connected using a modem or VPN, tap  on the title bar and then tap **Disconnect**.

Changing connection settings

To change settings for a dial-up modem or VPN server connection:

1. Tap  / *Settings* / *Connections* / *Connections*.
2. From the *My Work Network* list, tap *Manage existing connections*.
3. Depending on the type of connection, tap either the *Modem* or *VPN* tab.
4. Select the connection and then tap **Edit**.

Deleting a connection

To delete a dial-up modem or VPN server connection:

1. Tap  / *Settings* / *Connections* / *Connections*.
2. From either the *My ISP* or *My Work Network* list, tap *Manage existing connections*.
3. Depending on the type of connection, tap either the *Modem* or *VPN* tab.
4. Tap and hold the connection you want to remove, and tap *Delete*.



Tip – To delete a wireless LAN connection, see [page 64](#).

Using the Bluetooth Radio

The GeoExplorer 2005 series handheld has an integrated Bluetooth radio that you can use to establish a wireless connection to other Bluetooth devices that are within range.

Using a Bluetooth connection, you can communicate with devices such as mobile phones, desktop computers, handhelds, and digital cameras. You can also communicate with peripheral devices that use Bluetooth adaptors instead of serial or USB connections.

This section provides information on:

- Bluetooth hosts and clients (see [page 51](#))
- deactivating the Bluetooth radio (see [page 52](#))
- enabling Bluetooth wireless connections (see [page 53](#))
- bonding with other Bluetooth devices (see [page 54](#))
- connecting to a Bluetooth service as a client (see [page 57](#))
- providing Bluetooth services as a host (see [page 60](#))

Bluetooth hosts and clients

The handheld can be used as a client or as a host, and can act as both at the same time.

To communicate using a Bluetooth connection, a *client* device scans the Bluetooth radio frequency to “discover” other Bluetooth devices. Once it has discovered a *host*, the client selects the *service* that it will use. A service defines what type of information can be transferred to or from the host, and how. A client can connect to a number of different services provided by different hosts. The network created by all of a client’s connections to hosts is called a *piconet*. A client can connect to up to seven other devices, but the number of connections affects the speed of the connections.

The following diagram shows the handheld connected to different types of devices using Bluetooth. The arrows indicate the direction of the flow of data from the host to the client device.

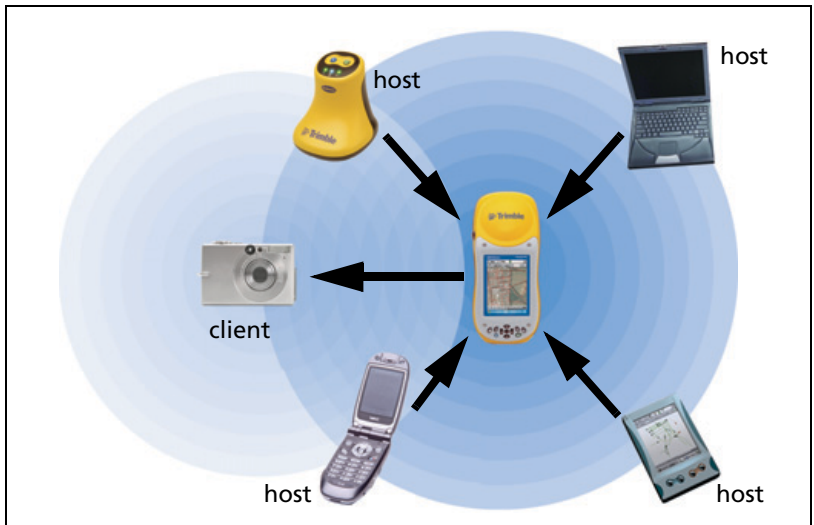

Deactivating the Bluetooth radio

The GeoExplorer 2005 series handheld is shipped with Bluetooth wireless technology activated. To use the Bluetooth radio, you need to turn it on (see [Enabling Bluetooth wireless connections](#), page 53).

You may need to deactivate the Bluetooth radio in the handheld if the country in which you are working does not approve the use of Bluetooth wireless technology. If you are unsure about whether the GeoExplorer 2005 series handheld's Bluetooth radio is approved for use in your country, check with your local Trimble Distributor.

Use the Bluetooth Activation Manager software to deactivate the Bluetooth radio, or to reactivate the Bluetooth radio if it has been deactivated.

The Bluetooth Activation Manager software runs on an office computer. The latest copy of the software is available for download from the Internet. To download the software, go to

www.trimble.com/support.shtml, click one of the GeoExplorer 2005 series links (GeoXH 2005 series, GeoXT 2005 series, or GeoXM 2005 series), click Downloads and then select the Bluetooth Activation Manager.

Enabling Bluetooth wireless connections

The GeoExplorer 2005 series handheld is shipped with Bluetooth wireless technology activated.

Use the Bluetooth control to turn on the integrated Bluetooth radio, scan for and bond with other Bluetooth devices, and configure host services on the GeoExplorer 2005 series handheld.

To open the Bluetooth control, tap  / *Settings* / *Connections* / *Bluetooth*.

Turning on the Bluetooth radio

To use the GeoExplorer 2005 series handheld as a Bluetooth host or client, you must turn on the Bluetooth radio.

To turn on the Bluetooth radio:

1. Tap  / *Settings* / *Connections* / *Bluetooth*.
2. In the *Mode* tab, select the *Turn on Bluetooth* option. This enables the integrated Bluetooth radio.

Note – If the integrated Bluetooth radio is deactivated, the message **No Bluetooth hardware appears**.

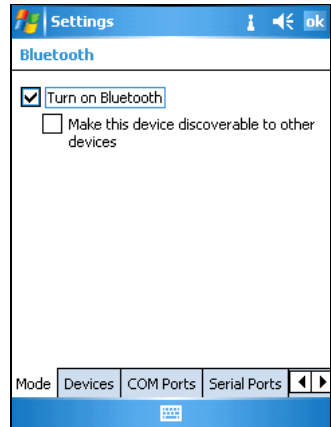



Tip – To conserve power, turn off the Bluetooth radio when it is not in use.

Enabling Flight mode

Aviation authority regulations can restrict the use of radios on board aircraft. You may be required to turn off the handheld or radios.

When Flight mode is enabled, the handheld cannot send or receive Bluetooth or WLAN signals.

To enable Flight mode, do one of the following:

- Tap  / *Settings* / *System* / *Power* / *Wireless* tab. Select *Wireless signals off (Flight mode)*.
- Tap  in the title bar and then tap *Turn on flight mode*.

Making the handheld discoverable

If you want to set up a bond with another Bluetooth device, or if you want to use the handheld as a host device, you need to make the handheld Discoverable. A discoverable device can be detected by other devices when they scan.

To make the handheld discoverable:

1. Tap  / *Settings* / *Connections* / *Bluetooth*.
2. In the *Mode* tab, select the *Make this device discoverable to other devices* check box.

Bonding with a Bluetooth device

Creating a bond between the handheld and another Bluetooth device helps to exchange information securely between the devices. Once a bond is created, the handheld and the other Bluetooth device only need to have their Bluetooth radios turned on to exchange information; they do not need to be in discoverable mode.

To bond with a Bluetooth device:

1. Make sure that the handheld and the Bluetooth device you want to bond with are within five meters of each other, and that Bluetooth is in Discoverable mode on both devices.
2. Tap  / *Settings* / *Connections* / *Bluetooth* and then tap the *Devices* tab.

3. In the Devices list, tap *New Partnership*. The handheld searches for other Bluetooth devices and displays them in the list.
4. Tap the name of the device you want to bond with and then tap **Next**.
5. In the *Passkey* field, enter a passkey of between 1 and 16 characters and tap **Next**.
6. Enter the same PIN on the other device.
7. In the *Display Name* field, change the name of the device if required.
8. Select the services you want to use with this device. For more information, see the table on [page 58](#).
9. Tap **Finish**.

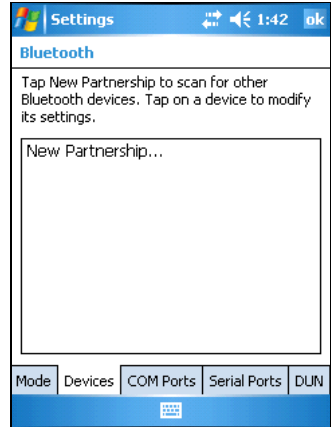

Tip – You only need to create a bond once between two devices.

Setting up Bluetooth connections

For e-mail and Internet access, you can use Bluetooth wireless technology to connect to a Bluetooth-enabled mobile phone or modem.

If the handheld is running TerraSync software, you can use Bluetooth wireless technology to connect the handheld to a VRS™ (Virtual Reference Station) network. A mobile phone provides the modem.

To set up a Bluetooth dial-up connection to the Internet:

1. On the mobile phone, enable Bluetooth as required and make the phone Discoverable (see [page 54](#)).
2. On the handheld, tap  / *Settings* / *Connections* / *Connections*.

3. Select *Add a new modem connection*.
4. Enter the name for the connection and select Bluetooth for the modem type. Tap **Next**.
5. If the device has not already been bonded, select *New Partnership* to bond with the device.
6. Select the mobile phone from the *Select a Bluetooth Device* list and then enter a passkey.
7. Select the Dialup Networking service (if it is not already selected) and tap **Finish**.
8. Tap *Connections / Manage existing connections* then tap and hold the connection you just created and then select *Connect*.
9. The phone should now dial the configured number.

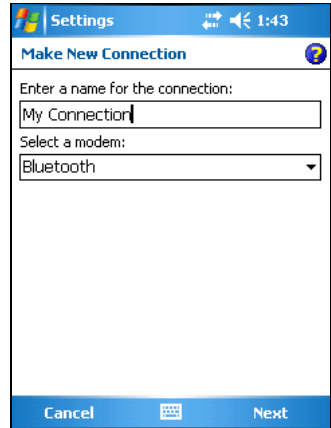

To set up a Bluetooth direct dial connection to a VRS network:

1. Create a bond between the handheld and the mobile phone you intend to connect to (see [Bonding with a Bluetooth device, page 54](#)).
2. On the handheld, tap  / *Settings / Connections / Bluetooth* and then tap the *DUN* (Dial-Up Networking) tab.
3. On the *DUN* tab, click and hold the name of the mobile phone that you have bonded with and then select *Activate*.

A green symbol appears beside the name of the mobile phone.

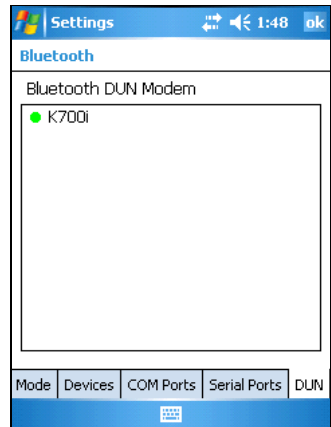

The Bluetooth dial-up connection is enabled. You can now select the mobile phone as an option in the TerraSync software.

4. Run the TerraSync software and set up an **external** real-time correction source:
 - a. As the connection method, select *Direct Dial*.
 - b. As the modem type, select *Bluetooth DUN Modem*.

The next time you connect to the VRS network, the handheld uses a Bluetooth connection to the mobile phone to dial into the VRS.

For more information, refer to the *TerraSync Software Reference Manual*.



Connecting to a Bluetooth service as a client

You can use the GeoExplorer 2005 series handheld as a Bluetooth client. A Bluetooth client uses services offered by Bluetooth host devices that are within range.

For example, you can connect the handheld to a mobile phone that has an internal modem, so that you can access the Internet. The mobile phone is the host (because it is providing the Dial-up Networking (DUN) service) and the handheld is a client using that service.

Another example is connecting the handheld to a Trimble GeoBeacon receiver to receive real-time differential GPS corrections from a DGPS beacon network. The GeoBeacon receiver is the host and the handheld is a client using that service.

The GeoExplorer 2005 series handheld can connect to the following services:

Service	Description
ActiveSync	Enables an ActiveSync connection to a computer. To use an ActiveSync service, enable the Bluetooth port on the computer and then configure ActiveSync to use this port. Bond with a device (see page 54) that has an ActiveSync service, making sure that you select the <i>ActiveSync</i> check box in the <i>Bonded Devices</i> tab of the Bluetooth control. Then tap  / <i>Programs</i> / <i>ActiveSync</i> and tap <i>Menu</i> / <i>Connect via Bluetooth</i> .
Dial-Up Network (DUN)	Connects the handheld to a mobile phone or modem for dial-up network or Internet access. Bond with a Bluetooth service (see page 54), tap  / <i>Settings</i> / <i>Connections</i> / <i>Connections</i> and then add a new dial-up connection. From the list of modems, select the Bluetooth mobile phone or modem that you have connected to.
Beam Objects	Allows the handheld and host to beam files, contacts, tasks, and appointments.
Serial Port	Emulates an RS-232 serial (COM) port on the handheld.

Setting up a client serial port service

A serial port service creates a virtual serial port on the GeoExplorer 2005 series handheld. You can use this port to connect to another Bluetooth device, just as you would use a physical COM port and a cable to connect to a physical serial port. Like a physical port, the virtual serial port sends and receives data using the RS-232 serial communication protocol.

Unlike other Bluetooth connections, you do not need to bond with the other device before you set up the client serial port connection. This means you can set up serial port connections with devices that otherwise you would not be able to bond with, such as the GeoBeacon receiver, which does not have a keypad for entering a PIN.

For information about host serial port services, see [Providing Bluetooth services as a host, page 60](#).

To set up a client serial port service:

1. Make sure that the *host* Bluetooth device is Discoverable.
2. Make the handheld Discoverable (see [page 54](#)) and then in the Bluetooth control, tap the *Serial Ports* tab.
3. Add a new *client* serial port, or change the settings for an existing one.
 - To change the settings for an existing client serial port, tap and hold the name of the serial port in the *Client Serial Ports* list.
 - To add a new client serial port, tap *New* in the *Client Serial Ports* list. The list immediately shows any bonded devices that have a serial port profile exposed. The Searching icon appears, and the handheld scans for any other Bluetooth devices that are within range and that expose the serial port profile. Tap the name of the serial port you want to set up and then tap **Next**.
4. The *Setup the Bluetooth device* dialog appears. The name of the host device is in the *Name* field. Edit the *Name* field if required.
5. From the *Port* list, select an available COM or BSP port on the handheld. The next available port is selected as the default.

Note – If the application that will use this service cannot recognize BSP ports, select a COM port.

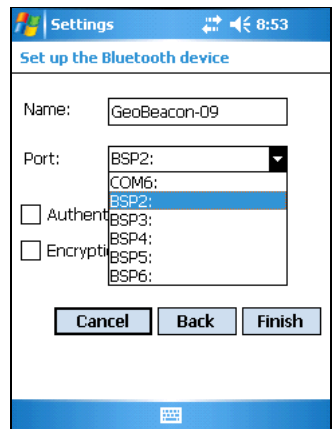
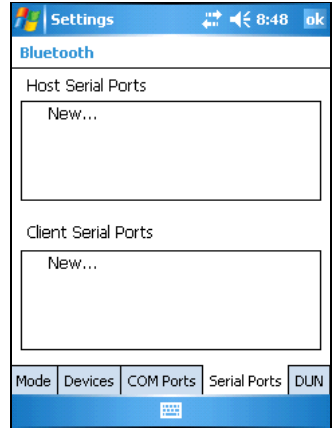

6. Normally, the host device handles authentication and encryption. If you require these options, and the host cannot be configured, select the *Authentication* and *Encryption* check boxes.
7. Tap **Finish**. The client serial port you have just set up is listed under *New* in the Client Serial Ports list, with the assigned port indicated.

Applications on the handheld can now use the client serial port you have set up. If the host requires authentication, you must enter a PIN to connect.

Providing Bluetooth services as a host

You can use the predefined Bluetooth host services on the handheld, or create additional serial port services.

To provide a host service, turn on the Bluetooth radio (see [page 53](#)) and make the device Discoverable (see [page 54](#)). If the service is a serial port service, you may need to add or configure the service (see [Setting up a host serial port service](#) below). Other host services do not require any configuration because they use either pre-assigned ports, or use the My Documents folder for file transfers. Other services already have authentication and encryption enabled.

The GeoExplorer 2005 series handheld provides the following host services:

Service	Description
Basic Imaging	Allows the client to preview, browse, and copy JPEG image files, and to send JPEG files to the handheld.
File Transfer	Allows a client to browse, copy, paste, and delete files and folders on the handheld.
Note – <i>File transfers are not supported between two GeoExplorer 2005 series handhelds, as the client file transfer profile is not supported. The handheld supports file transfers as a host device only.</i>	
Beam Object	Allows the handheld and the client to beam files, contacts, tasks, and appointments.
Serial Port	Emulates an RS-232 serial (COM) port on the handheld. For more information, see Setting up a host serial port service below.

Setting up a host serial port service

A serial port service creates a virtual serial port on the GeoExplorer 2005 series handheld, enabling you to connect to another Bluetooth device without using a physical COM port and cable. Like a physical port, the virtual serial port sends and receives data using the RS-232 serial communication protocol.

Note – *Trimble GPS field applications, such as the GPS Controller and TerraSync software, can connect to BSP ports as well as to COM ports. However, some other applications do not recognize BSP ports. If a client device is unable to connect to a serial port service that uses a BSP port, configure the service to use a COM port instead.*

To add or configure a host serial port service:

1. Make sure that the **client** Bluetooth device is Discoverable.
2. Make the handheld Discoverable (see [page 54](#)) and then tap the *Serial Ports* tab.
3. Add a new **host** serial port, or change the settings for an existing one.
 - To change the settings for an existing host serial port, tap and hold the name of the serial port in the *Host Serial Ports* list.
 - To add a new host serial port, tap *New* in the *Host Serial Ports* list.
4. The *Setup the Bluetooth Device* dialog appears.
5. In the *Name* field, enter a unique name, or for an existing host serial port, edit the name if required.
6. From the *Port* list, select an available COM or BSP port on the handheld. By default, the next available port is selected.

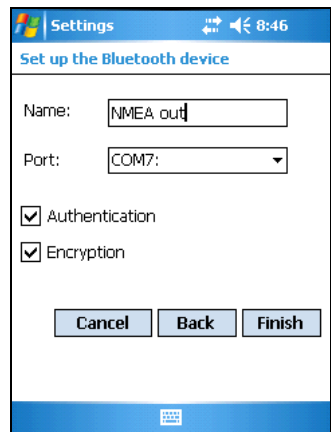

7. The *Authentication* check box is selected by default. When the host connects to this service, the *Enter PIN* dialog appears. Enter a PIN in this dialog and then enter the same PIN on the client.

Note – *Authentication helps to ensure that your data remains secure. However, if you enable authentication, only client devices that support PIN entry will be able to connect to the service.*

8. The *Encryption* check box is selected by default, so that data transferred using this service will be encrypted.
9. Tap **Finish** to return to the *Serial Ports* tab. The new host serial port is listed in the Host Serial Ports list, with the assigned port indicated.

Applications on the handheld can now use the COM or BSP port that you selected for this service. For example, to provide NMEA messages from the integrated GPS receiver to a Bluetooth client, use the GPS Connector software to redirect the NMEA output on COM2 to the virtual serial port or Bluetooth port that you have assigned to this service.

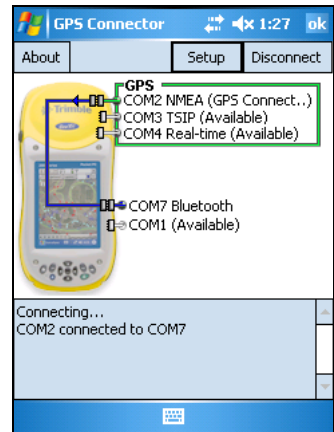

Tip – Trimble recommends that you establish the Bluetooth connection **before** you supply data to a service.

Using the WLAN Radio

The GeoExplorer 2005 series handheld has an integrated Wireless Local Area Network (WLAN) radio that you can use to receive data anywhere within the range of a wireless LAN access point.

This section provides information on:

- wireless LAN access points
- setting up a wireless LAN connection
- connecting to a network using a wireless LAN connection
- enabling Flight mode
- disabling the WLAN radio

Wireless LAN access points

Wireless LAN is sometimes referred to as *wireless Ethernet*.

A wireless LAN connection can be used to connect to the Internet (at broadband speeds), and to connect to 802.11b standard Ethernet networks within range of an available wireless LAN access point. Access points are also known as “hotspots”.

When a wireless LAN is detected, the access point icon  on the title bar is animated, and a notification message appears.

Setting up a wireless LAN connection

Use the Network Cards settings page to set up wireless LAN connections to networks.

To set up a wireless LAN connection:

1. Tap  / *Settings* / *Connections* / *Network Cards*.
2. Select the *Wireless* tab.

Any networks that you have already configured are displayed in the list of preferred networks.
3. To add a new network, tap *Add New*. To change the settings for an existing network, tap the network.
4. Enter the name of the network and other connection details.
 - To use authentication, tap the *Network Key* tab and select the authentication method from the *Authentication* list.
 - To use data encryption, select an encryption method from the *Data encryption* list.
 - To automatically use a network key, tap *The key is automatically provided*. Otherwise, enter the network key.
 - For increased security, tap the *802.1x* tab and configure additional authentication information.
5. Tap **OK** to return to the *Configure Wireless Networks* page.
6. From the *Networks to access* drop-down list, select the types of network you want to connect to. Options are *All Available*, *Only access points* or *Only computer-to-computer*.
7. Tap **OK**.

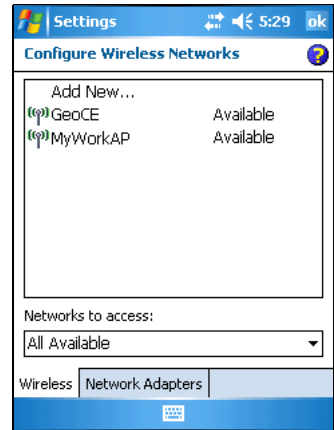

To delete a wireless LAN connection, tap and hold the connection in the *Wireless* tab and select *Delete*.

Connecting to a network using wireless LAN connectivity

To automatically connect to a network or access point using the wireless LAN connection you have set up:



1. Remove the handheld from the support module, as the handheld prioritizes a USB connection over a wireless LAN connection.
2. Bring the handheld within range of the network or access point.
3. Start using the desired program, for example Windows Explorer Mobile.

If you are within range of more than one network or access point that you have set up wireless LAN connections to, you may need to **manually** select the connection you want to use (see [Connecting to the Internet](#), page 48 and [Connecting to work](#), page 49).

Enabling Flight mode

When Flight mode is enabled, the handheld cannot send or receive Bluetooth or WLAN signals.

To enable Flight mode, do one of the following:

- Tap  / *Settings* / *System* / *Power* / *Wireless* tab. Select *Wireless signals off (Flight mode)*.
- Tap  in the title bar and then tap *Turn on flight mode*.

Disabling the WLAN radio

The GeoExplorer 2005 series handheld is shipped with the integrated WLAN radio enabled. You can disable (that is, turn off) the radio, for example, if you want to conserve power.

To disable or re-enable the WLAN radio:

1. Tap  / *Settings* / *Connections* / *Wireless Network*.
2. Tap the *Tools* softkey and select *Disable Radio*.

Using Cabled Ethernet

The GeoExplorer 2005 series handheld provides the option of connecting the handheld to the Internet, a network, or an office computer using a cabled Ethernet connection.

***Note** – ActiveSync version 4.0 does not support connections to an office computer using cabled Ethernet technology. If you want to **synchronize** the handheld and an office computer, you will need to use a support module USB or a Bluetooth connection (see [ActiveSync Connections](#), page 15).*

Connecting to the Internet or a network

You can use a cabled Ethernet connection to connect the handheld to a network port (or “hub”) and transfer files to and from the network. You can also use the network port to browse the Internet.

For most network connections, you will be able to connect directly to the network, without first setting up the connection using the software on the handheld.

To connect to a network using a cabled Ethernet connection:

1. Place the GeoExplorer 2005 series handheld in the support module.
2. Detach the USB cable from the support module, if it is connected.
3. Connect one end of a standard **straight-through** cable to the RJ-45 socket on the support module, and the other end of the cable to the network port.

The handheld automatically connects to the network, and a dialog appears on the handheld indicating the connection is active.

4. To go to a location on the network, tap  / *Programs / File Explorer* and use the input panel to enter the path and filename of the folder.

Connecting to an office computer

You can use a cabled Ethernet connection to connect the handheld to an office computer and transfer files to and from the computer.

Note – If you want to **synchronize** the handheld and an office computer, you will need to use a support module USB or a Bluetooth connection (see *ActiveSync Connections*, page 15).

To connect to a computer using a cabled Ethernet connection:

1. Place the GeoExplorer 2005 series handheld in the support module.
2. Detach the USB cable from the support module, if it is connected.
3. Connect one end of a standard **cross-over** cable to the RJ-45 socket on the support module, and the other end of the cable to the computer.
4. Configure the handheld to connect to the computer.

To configure the cabled Ethernet connection to a computer:

1. Tap  / *Settings* / *Connections* / *Network Cards*.
2. Select the *Network Adaptors* tab.
3. From the list of adaptors, tap the SMC LAN91C111 adaptor.

The settings page for the selected adaptor appears.

4. If required, change the server information to match your requirements.
5. Tap **OK**.

A message appears indicating that the new settings will be applied the next time the adaptor is used, and that you must reset the handheld. Tap **OK**.

6. Press and hold the **Power** button for five seconds to perform a soft reset and activate the new settings.

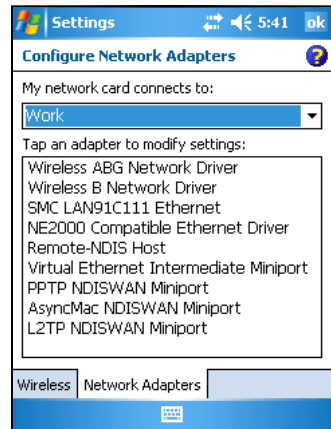

Using the Optional Serial Clip

The optional serial clip (P/N 53550-00) attaches to the communication swipes on the back of the handheld. When the serial clip is attached, it adds a serial port (COM1) to the GeoExplorer 2005 series handheld.

Note – *The GeoExplorer 2005 series handheld is not compatible with the serial clip supplied with previous versions of the handheld. You must use the **gray** serial clip (P/N 53550-00) provided with the GeoExplorer 2005 series handheld.*

You can use the serial clip to:

- supply external power from the external power kit or a vehicle's battery (see [Using external power, page 36](#)).
- recharge the internal battery from an external power source (see [Using external power, page 36](#)).
- receive differential corrections from an external real-time correction source, such as a Trimble GeoBeacon or Beacon-on-a-Belt (BoB™) receiver, or a DGPS radio
- receive GPS data from a Trimble GPS Pathfinder series or GPS Pathfinder Pro series receiver
- connect to an external modem or mobile phone for wireless Internet access
- connect to other external devices, such as a laser rangefinder
- connect to a computer to supply GPS data (for example, when running the Trimble GPS Analyst extension for ESRI ArcGIS software on a laptop)

Note – *When connecting to an office computer using the serial clip, you cannot use ActiveSync technology to establish the connection or synchronize data. To use ActiveSync, you need to use a support module USB or a Bluetooth connection (see [ActiveSync Connections, page 15](#)).*

Attaching the serial clip

The serial clip must be screwed onto the handheld.

Note – *When the serial clip is attached, you cannot place the handheld in the support module.*

To attach the serial clip to the handheld:

1. Line up the communication swipes on the handheld with the pins on the serial clip.
2. Lower the handheld onto the serial clip.
3. Use the screws supplied with the serial clip to secure it to the handheld.



Connecting to external devices

You can use the serial clip instead of the support module to connect to a computer. The serial clip also provides a serial port to connect to other devices.

To connect to an external device:

1. Attach the serial clip to the handheld.
2. Plug the null modem cable into the serial (COM) port on the serial clip.

3. Connect the other end of the cable to the serial port on the external device.

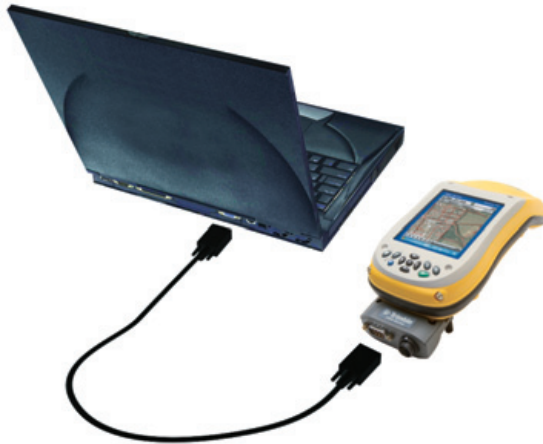

To connect to a device that does not have a serial port, such as an external modem or mobile phone, use a cable that has a DE9 connector on one end, and the appropriate connector for the other device on the other end. A suitable cable may be supplied with the external device.

For more information about using an external modem or mobile phone to access the Internet, see [Internet and Network Connections](#), page 44.



Personalizing your Handheld

Use the controls in the *Settings* screen to customize the handheld. The following are examples of the controls that are available.

Today

Use the Today control to change the display theme that controls the appearance of the *Today* screen, and to customize which items appear on the *Today* screen.

Appearance

You can use a theme to customize the background picture on the *Today* screen, the color of the title and menu bars, menus, and messages.

To change the display theme:

1. Tap  / *Settings* / *Personal* / *Today*.
2. Tap the *Appearance* tab.
3. Do one of the following:
 - To use a predefined theme, select it from the list.
 - To select the picture that you want to display in the *Today* screen background, select the *Use this picture as the background* check box. Then tap **Browse** to search for a file on the handheld.
4. Tap **OK**.

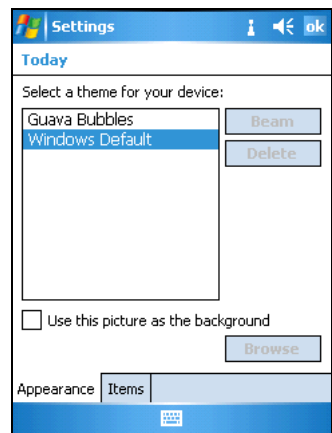

Items

You can choose the items that appear on the *Today* screen, and the order that they appear in.

To change the items that appear on the *Today* screen:

1. Tap  / *Settings* / *Personal* / *Today*.
2. Tap the *Items* tab.
3. Select or clear the check boxes to display or hide the *Today* screen items.
4. Use the **Move Up** and **Move Down** buttons to change where the selected item appears on the *Today* screen.
5. Tap **OK**.

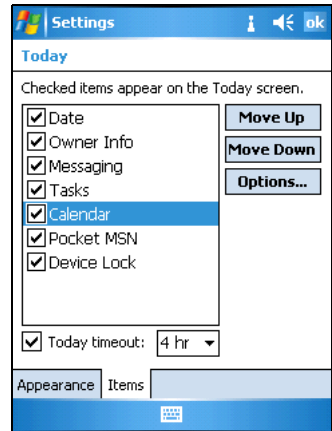

Device Lock

Use the Device Lock option on the *Today* screen to lock the screen. Stylus taps on the screen will not work while the device is locked. Tap the *Unlock* softkey in the menu bar and then tap **Unlock** to unlock the device.

Alternatively, you can help to keep your data secure by requiring a password each time the handheld is turned on. Tap  / *Settings* / *Personal* / *Password* to set a password or to change password settings.

Sounds and Notifications

Use the Sounds and Notifications control to set preferences for the speaker volume and system sounds. To open the Sounds and Notifications control:

- Tap  / *Settings* / *Personal* / *Sounds and Notifications*.

To turn sounds on or off:

1. Tap the *Sounds* tab.
2. Select or clear the check boxes to enable or disable categories of sounds.
3. If you select the *Screen taps* or *Hardware buttons* check boxes, select the *Soft* or *Loud* option to control the volume of the sounds.
4. Tap **OK**.

You can use predefined schemes to customize sounds, or you can create your own sound schemes.

To specify a sound scheme:

1. Tap the *Notifications* tab.
2. From the *Select an event* drop-down list, select an event.
3. Select from the available options the type of notification you want to receive for the selected event.
4. Tap **OK**.

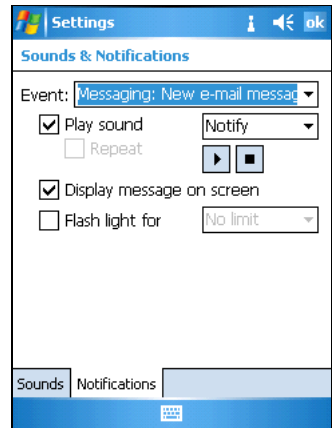
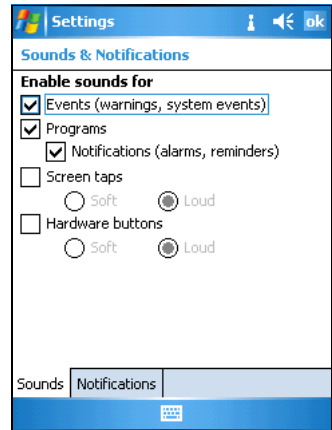

Screen

Use the *Screen* control to align the touch screen or to change the appearance of text on the screen. To open the Screen control:

- Tap  / *Settings* / *System* / *Screen*.

To change the screen settings:

1. Tap the *General* tab.
2. To change the orientation of the screen, select an option in the Orientation group.
3. To start the alignment sequence for the touch screen, tap **Align Screen**.
For more information, see [page 9](#).
4. Tap **OK**.

To enable ClearType:

Using ClearType font smoothing can make text easier to read on the screen.

1. Tap the *ClearType* tab and select the *Enable ClearType* check box.
2. Tap **OK**.

To change the size of text on screen:

1. Tap the *Text Size* tab.
2. Tap and drag the slider control to the left to make text smaller, or to the right to make text larger.

The example text below the slider shows how the text will appear on screen.

3. Tap **OK**.

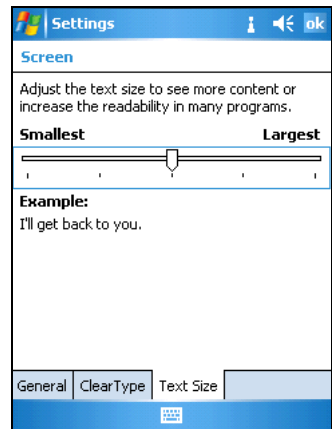
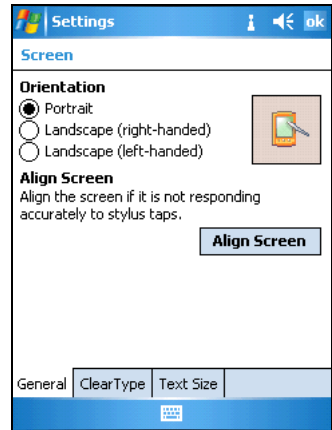

Power

Use the *Battery* tab to check the battery level, the *Wireless* tab to turn off all wireless signals from the handheld, and the *Advanced* tab to set the idle time before Suspend mode is activated. For more information, see [Enabling Flight mode, page 54](#) and [Suspend mode, page 38](#).

Backlight

The backlight makes the screen easier to read in low light, but uses extra power. Use the Backlight control to configure power-saving settings for the backlight. To open the Backlight control:

- Tap  / *Settings* / *System* / *Backlight*.

To turn off the backlight:

1. To automatically turn off the backlight when the handheld is idle and is using **battery power**, tap the *Battery Power* tab. Select the *Turn off backlight* check box and select a time from the drop-down list.
2. To automatically turn off the backlight when the handheld is idle and is using **external power**, tap the *External Power* tab. Select the *Turn off backlight* check box and select a time from the drop-down list.

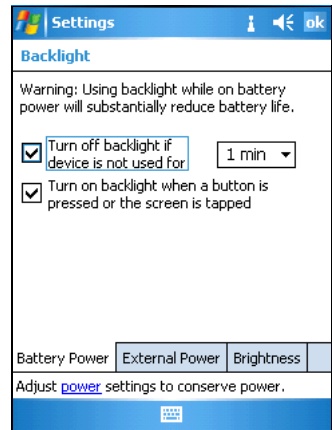

Note – The **Display** button on the handheld overrides settings in the Backlight control. To turn on the backlight again, use the **Display** button.

3. Tap **OK**.

To change the brightness:

1. Tap the *Brightness* tab.
2. Tap and drag the slider control to the left to make the backlight darker, or to the right to make the backlight brighter.
3. Tap **OK**.

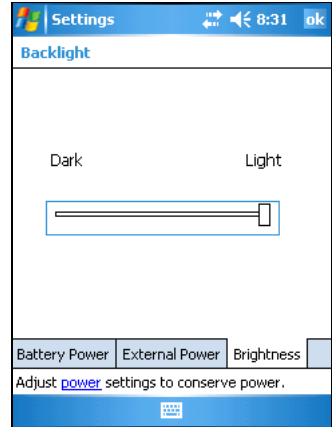

Use and Care

When using the GeoExplorer 2005 series handheld:

- Keep the outer surface free of dirt and dust.
- Keep the communication swipes, the external antenna port, and the SD card slot free of dirt and dust (see [SD memory cards, page 40](#)).
- Protect the touch screen from pressure and sharp or abrasive objects. Trimble recommends applying a screen protector to the device.

Servicing

If the handheld requires servicing, contact your local dealer.

Cleaning

To clean the handheld, wipe it with a clean dry cloth. Do *not* immerse the handheld in water.

Storage

If you are not going to use the handheld for three months or more, Trimble recommends that you turn the handheld off instead of leaving it in Suspend mode, and store in a cool place.

To prepare the GeoExplorer 2005 series handheld for storage:

1. Transfer any data that you need to a desktop computer.
2. Hold down the **Power** button until the handheld turns off (about 15 seconds).

To use the GeoExplorer 2005 series handheld after storage:

1. Press the **Power** button to turn on the handheld.
2. Recharge the internal battery using the support module (see [Charging the internal Lithium-ion battery, page 35](#)).

Troubleshooting

This section describes problems that can occur when using the GeoExplorer 2005 series handheld and explains how to solve them. The following categories of problems are covered:

- Battery issues
- GPS/real-time correction issues (see [page 79](#))
- Connection issues
 - ActiveSync connections (see [page 81](#))
 - Bluetooth wireless technology (see [page 82](#))
 - Network connections (see [page 84](#))
 - Wireless LAN connections (see [page 83](#))
- Touch screen issues (see [page 85](#))

For information on the latest support issues, visit the Trimble website at www.trimble.com/geoxm.shtml, www.trimble.com/geoxt.shtml, or www.trimble.com/geoxh.shtml, and click the Support link.

Battery issues

Problem	Cause and Solution
Handheld does not turn on	Battery is flat Recharge the internal battery (see Charging the internal Lithium-ion battery, page 35).
Battery power percentage bar not shown in Power control	Battery has 0% power Recharge the internal battery (see Charging the internal Lithium-ion battery, page 35). Once the battery level is above 0%, the battery power percentage bar reappears. Tap  / <i>Settings / System / Power / Battery</i> to view the level of power remaining in the battery.

GPS / real-time correction issues

Problem	Cause and Solution
<p>No GPS position</p>	<p>The integrated GPS receiver is not activated Use the application's Connect or Activate GPS command to open the GPS COM port and activate the integrated GPS receiver. For more information, see Using GPS, page 21.</p>
	<p>Incorrect configuration of serial COM port When supplying GPS to an external device using the COM 1 serial clip, set the baud rate to the high-speed TSIP setting: 38400, 8, 1, Odd.</p>
	<p>GPS COM port is already in use Only one application at a time can have the port open (unless you have configured NMEA on COM 2 to be assigned to a COM port using the GPS Connector utility). Exit the program that is using the GPS COM port and then retry in your program.</p>
	<p>Using wrong GPS COM port Connect to COM2 if the application uses NMEA messages, or COM3 for TSIP messages. For information on which protocol to use, check the documentation for the application.</p>
	<p>Not enough satellites are visible Move to a location where the receiver has a clear view of the sky and ensure the antenna is not obstructed. Alternatively, adjust the GPS settings to increase productivity. For more information, refer to the Help provided with your GPS Controller or TerraSync software, or the GPScorrect or GPS Analyst extension.</p>
	<p>External antenna connected but not receiving data The handheld can take up to two seconds to detect that an optional external antenna has been connected or disconnected</p>
	<p>Not receiving SBAS real-time corrections</p>
<p>You are outside the WAAS, EGNOS, or MSAS coverage area WAAS corrections are available in the Northern hemisphere between 40° West and 180° West. EGNOS corrections are available in the Northern hemisphere between 30° West and 60° East. MSAS corrections are available between 120° E and 165° E. If you have selected satellites not available at your location, you cannot use SBAS corrections.</p>	

Problem	Cause and Solution
<p>Not receiving real-time corrections from external source</p>	<p>No physical connection Connect the external real-time source to COM1 using the optional serial clip (P/N 53550-00), or to a Bluetooth port on the handheld.</p>
	<p>Not connected to real-time COM port correctly In the Real-time section in the GPS Controller or TerraSync software, or the GPScorrect or GPS Analyst extension, select the serial (COM) or Bluetooth (BSP) port that the real-time source is connected to. If you are using a non-Trimble application, use GPS Connector to create a connection between the COM or BSP port and the integrated GPS receiver's real-time GPS COM port (COM4).</p>
	<p>Incorrect port settings Change the port settings to match those used by the external source.</p>
	<p>No GPS positions You cannot use real-time corrections until the GPS receiver is computing positions. In the application, make sure that the integrated GPS receiver is activated, enough satellites are available, and the satellite geometry (PDOP) is good enough to compute positions.</p>
	<p>No Bluetooth connection to external correction source The Bluetooth external correction source is more than ten meters from the handheld, or is obstructed. Move the devices closer together, in a direct line of sight, to re-connect.</p>
<p>NMEA data includes autonomous positions</p>	<p>Integrated GPS receiver outputs autonomous positions when real-time corrections are unavailable. Configure your NMEA application to filter out non-DGPS positions.</p>

Connection issues

ActiveSync connections

Problem	Cause and Solution
<p>Cannot connect to computer using ActiveSync</p>	<p>No physical connection Use the USB port on the support module or a Bluetooth wireless connection to connect the handheld to the computer.</p>
	<p>Connection not initiated automatically Remove the handheld from the support module, and then place it in the support module again. Alternatively, in the ActiveSync software on your computer, tap File / Get Connected.</p>
	<p>Connection not enabled in ActiveSync on computer In the ActiveSync software on your computer, click <i>File / Connection Settings</i> and make sure that the correct port for Bluetooth is selected. If you are using the support module, make sure that the <i>Allow USB connection</i> check box is selected from the drop-down list. If you are using a Bluetooth connection, open the Bluetooth control on the handheld, view the partnership from the Devices tab, and in the services list make sure that the <i>ActiveSync</i> check box is selected.</p>
	<p>Connection not enabled in ActiveSync on handheld On the handheld, tap  / <i>Programs / ActiveSync / Tools / Options / PC</i>. Make sure that the <i>Enable PC sync using this connection</i> check box is selected, and that the correct options are selected.</p>
	<p>ActiveSync does not recognize the GeoExplorer 2005 series handheld Restart the desktop computer. Remove the handheld from the support module, reset it (see Resetting the handheld, page 43) and then replace it in the support module.</p>
	<p>An incompatible version of ActiveSync software is installed ActiveSync version 4.0 and later is compatible with the GeoExplorer 2005 series handheld. If you do not have ActiveSync version 4.0 or later installed on your computer, you can install it from the <i>GeoExplorer 2005 Series Getting Started Disc</i>. You can also download the latest version from the Microsoft website at www.microsoft.com/windowsmobile.</p>
<p>For more information</p>	<p>For more troubleshooting information when using ActiveSync visit the Trimble website at www.trimble.com/geoxt_ts.asp</p>

Bluetooth wireless technology

Problem	Cause and Solution
Cannot discover a nearby Bluetooth device	<p>The integrated Bluetooth radio is not activated</p> <p>The handheld's Bluetooth radio has been deactivated. If Bluetooth wireless technology is allowed where you are working, use the Bluetooth Activation Manager software to re-activate the radio (see Deactivating the Bluetooth radio, page 52).</p>
	<p>The device is out of range</p> <p>Move the devices closer to each other and then scan again.</p>
	<p>Bluetooth is not enabled on one or both devices</p> <p>Make sure that the Bluetooth radio is turned on, on both the handheld (see Enabling Bluetooth wireless connections, page 53) and the other Bluetooth device.</p>
	<p>The device has not been made Discoverable</p> <p>Make sure that the Bluetooth device has been made Discoverable.</p>
	<p>Bluetooth radio has lost the connection</p> <p>Turn off the Bluetooth radio on the handheld and then turn on the Bluetooth radio (see Enabling Bluetooth wireless connections, page 53).</p>
Cannot detect a host serial port service	<p>GeoExplorer 2005 series handheld can only discover one host serial port service</p> <p>Although multiple host serial port services can be configured on a handheld, when another handheld is connected as a client, the client handheld can only detect the first serial port service configured on the host. To avoid this, make sure the host serial port service you want to use is the first host serial port service listed on the host.</p>
The COM or BSP that you assigned to a serial port service is not available in your application	<p>The application cannot recognize ports if they are added after the application opens</p> <p>Exit from the application, add the port and then run the application again.</p>
	<p>The application cannot recognize BSP ports</p> <p>Use a COM port instead of a Bluetooth Serial Port (BSP) for this service.</p>

Problem	Cause and Solution
Bluetooth connection fails while in use	<p>The Bluetooth device has moved out of range</p> <p>Move the devices closer to each other. The devices should reconnect automatically. If they do not, select the Bluetooth device in the <i>Bonded Devices</i> tab. Tap and hold the device name and select <i>Delete</i>. Tap <i>New</i> to discover the device again.</p>
	<p>Bluetooth radio has lost the connection</p> <p>Turn off the Bluetooth radio on the handheld and then turn on the Bluetooth radio (see Enabling Bluetooth wireless connections, page 53).</p>
	<p>Bluetooth file transfer interrupts connection</p> <p>When you transfer large image or data files, other Bluetooth connections may stop responding. To avoid problems, close other Bluetooth connections before transferring large files.</p>

Wireless LAN connections

Problem	Cause and Solution
Cannot connect to a secure site, or configure an Internet connection	<p>The date on the handheld is incorrect</p> <p>Check that the handheld has the date set correctly on the Today screen. If the date is incorrect, tap the clock icon on the today screen and adjust the date and time.</p>
Within range of more than one network, you are not connecting to the network you would prefer to use	<p>The radio is connecting to the first network signal it has received</p> <p>Tap  / <i>Settings / Connections / Network Cards</i>. Tap and hold the network you would prefer to use and then select <i>Connect</i>.</p>
You are not able to respond to the 'New Network Detected' notification	<p>The 'New Network Detected' notification appears but the menu bar and soft key options are not displayed</p> <p>Some applications are not fully compatible with all Windows Mobile Version 5.0 features. Use the application buttons on the keypad, as they map to the soft keys in the menu bar. To dismiss the notification, press the right application button on the keypad. To connect to the network, press the left application button. Alternatively, select a Windows Mobile application from the <i>Start</i> menu, such as the <i>Today</i> screen or <i>File Explorer</i>, and the menu bar and soft keys will be displayed correctly.</p>

Network connections

Problem	Cause and Solution
<p>Connection with mobile phone ends.</p>	<p>Changing proxy settings while connected ends the connection. Changing the proxy settings of the handheld while connected to a mobile phone causes the mobile phone to end the connection. Make any changes to proxy settings before connecting to a mobile device to maintain the connection.</p>
<p>Unable to connect to another GeoExplorer 2005 series handheld</p>	<p>Data encryption settings are incorrectly set When setting up a peer-to-peer ad-hoc network with a WEP encryption, set a Network Key, rather than leaving the key blank to be provided automatically.</p>

Touch screen issues

Problem	Cause and Solution
Touch screen does not respond to stylus taps	Touch screen is incorrectly aligned Hold down both the Display button and the Start button for two seconds to start the alignment sequence.
	GeoExplorer 2005 series handheld has locked up Deleting directories containing certain types of files may cause the unit to lock up and stop responding to screen taps. Reset the handheld (see Resetting the handheld, page 43). To remove any problematic files, remove the files first, and then the directory.
Screen is blank or hard to see	GeoExplorer 2005 series handheld is turned off or is in Suspend mode Press the Power button to turn on the handheld.
	Backlight is off Press the Display button to turn on the backlight.
	Backlight level needs to be adjusted Open the Backlight control and adjust the backlight level (see Backlight, page 75).
	GeoExplorer 2005 series handheld has locked up Reset the handheld (see Resetting the handheld, page 43).
	Unable to see parts of an application window when screen is in landscape orientation Some applications have been designed for portrait orientation only. To view the entire application window, change the screen display to portrait.

A

- AC power adaptor
 - connecting 8, 36
 - safety x, 35
 - system component 2
- accessing online help 12
- accessories 1, 3, 68
- accuracy 33
 - maintaining 29
 - of GeoExplorer 2005 series
 - handhelds 1, 29
- ActiveSync
 - documentation 1
 - features 15
 - troubleshooting 81
 - USB support module
 - connection 16
 - using with a Bluetooth connection 58
- adjusting screen display 9
- animated skyplot 26
- antenna
 - external 3, 5, 29
 - Hurricane 3, 29
 - internal 22, 29
 - Zephyr 3, 29
- Application buttons 7
- ArcPad
 - connecting to GPS 23
 - documentation 1
 - installing 20
- Australia, notices to users iii
- authentication
 - enabling for a Bluetooth Serial Port service 62
 - enabling when connecting as a Bluetooth client 60

B

- backlight
 - Display button 7
 - settings 75, 76
 - turning off to save power 39, 75, 76
 - turning on or off 9
- battery
 - camcorder 37
 - charging 8, 35, 37
 - conserving 39
 - life 34
 - recharging from external power 37
 - safety ix, 34
 - troubleshooting 78
 - vehicle 37
- beam objects 58
- Bluetooth Activation Manager
 - software 52
- Bluetooth radio
 - deactivating 52, 53
 - integrated 5
 - making the handheld
 - Discoverable 54
 - reactivating 52
 - turning off to save power 39
 - turning on 53
- Bluetooth Serial Port 59, 61, 62
- Bluetooth wireless technology
 - ActiveSync connection 58
 - client device 51, 57
 - client services 57
 - creating a bond 54
 - Flight mode 54, 65
 - host device 51, 60
 - host services on the handheld 60
 - settings 53
 - troubleshooting 82

BoB receiver 68
Bond, creating a 54
BSP [See](#) Bluetooth Serial Port
buttons [See](#) Keypad 5

C

cabled 44
cabled Ethernet 44, 66
Calculator 4
Calendar 4
camcorder battery, using power from 36
cellular modem [See](#) external modem
charging battery
 in support module 35
 via serial clip 37
cleaning 77
client 51
client serial port 58, 59
client, connecting as a 57
clock icon 10
communicating with a desktop
 computer 15
communication swipes 6, 69
components 2
computer, connecting to
 using ActiveSync 15
 using cabled Ethernet 67
 using USB support module
 connection 16
connecting to
 desktop computer 17
 external device 69
 host device 57
 the Internet 44
 the network 44
Connection Manager Utility 18
connection methods 44
connections

 managing 50
 setting up 45
conserving power 39
Contacts 4
context-sensitive help 12

D

data collection, planning 26
deactivating the Bluetooth radio 52, 53
desktop computer, connecting to 17
dial-up connection, setting up 45
Dial-Up Network (DUN) service 58
Discoverable mode 54
Display button 7
DOP graph 26

E

EGNOS satellites 27, 79
e-mail [See](#) Messaging 4
encryption
 enabling for Serial Port service 62
 enabling when connecting as a
 client device 60
entering text 13
Ethernet, cabled [See](#) cabled Ethernet 44
Ethernet, wireless [See](#) wireless LAN 44
Europe, notices to users iii
European Council Directive
 89/336/EEC iii
Excel Mobile 4
external antenna 3, 5
external antenna connector 5
external device, connecting to 69
external modem 70
external patch antenna 29
external power 36, 37

F

- features of GeoExplorer 2005 series
 - handheld 5
- File Explorer 4
- file transfer folder 60
- file viewers 4
- flash disk 19, 40
- Flight mode 54, 65

G

- GeoBeacon receiver
 - client serial port service with 57, 58
 - connecting 68
 - ordering 3
- GeoExplorer 2005 series handheld
 - accessories 1
 - accuracy 1, 29
 - attaching serial clip 69
 - caring for 77
 - copying files to 17
 - features 5
 - GeoXH 1
 - GeoXM 1
 - GeoXT 1
 - H-Star technology 1, 5
 - integrated Bluetooth radio 5
 - integrated GPS receiver 5
 - integrated SBAS receiver 5, 27
 - integrated WLAN radio 5
 - parts 5
 - resetting 43
 - specifications 1
 - storing 77
 - Suspend mode 7, 38
 - system components 2
 - turning off 7, 38, 77
 - turning on 7, 9
 - using support module 8
- GeoXH *See* GeoExplorer 2005 series handheld
- GeoXM *See* GeoExplorer 2005 series handheld
- GeoXT *See* GeoExplorer 2005 series handheld
- getting help 12
- getting started 8
- Getting Started Guide 2
- GPS
 - about 21
 - changing settings 24
 - resetting 26
 - troubleshooting 79
 - viewing status 24
- GPS COM ports 6, 22, 28
- GPS Connector
 - documentation 1
 - pre-installed 4
 - using 28, 62
- GPS Controller
 - connecting to GPS 23
 - documentation 1
 - features 24
 - mission planning 26
 - pre-installed 4
- GPS Pathfinder Office software 18
- GPS Pathfinder Pro series receiver 68
- GPS Pathfinder series receiver 68
- GPS precision 25
- GPS receiver
 - GPS COM ports 6
 - integrated 5
 - turning off to save power 39
- GPS satellite signals 22
- GPS softkey 10, 11
- GPS software
 - configuring 23

- default 10
- ground plane 29
- guest relationship (ActiveSync) 18

H

- handstrap 6
- handwriting recognition 14
- help 12
- host 51, 60
- host serial port 61
- H-Star technology 1, 5, 30, 33
- Hurricane antenna 3, 29

I

- idle time 38
- IMAP4 mail service 47
- Inbox [See](#) Messaging software
- Input Panel 13
- installing software 10, 19
- internal antenna 22
- internal battery 34
- Internet
 - browsing 48, 49
 - connecting to 44, 48, 66
- Internet Explorer
 - browsing Web with 48, 49
 - documentation 1
- intranet
 - browsing 48, 49
 - connecting to 49, 66
 - setting up connection to 45
- ISP
 - connecting to 48
 - setting up connection 45

K

- keypad 5, 7

M

- mail service, setting up 47
- main 40
- main memory
 - backing up 42
- mains power, using 36
- maintenance 77
- memory
 - flash disk 40
 - main memory 40
 - SD memory card [See](#) SD memory card 40
- Messaging software 1, 47, 48
- Microsoft Transcriber 14
- mission planning 26
- modem [See](#) external modem
- MP3 files 4
- MSAS satellites 27, 79

N

- Navigation buttons 7
- network
 - connecting to 49, 66
 - setting up connection to 45
- network card connections 64
- New Zealand, notices to users iii
- NMEA
 - applications 23
 - GPS COM port for 22
 - output to external device 29
 - supported messages 22
- Notes 4
- notices to users

Australia and New Zealand iii
Europe iii

O

object beam 58
OK button 7
online help, accessing 12
on-screen keyboard 13
optional accessories 1, 3, 68

P

packing list 2
partnership with ActiveSync 18
PC, connecting to 15
piconet 51
Pictures and Videos 4
planning GPS data collection 26
Pocket PC
 help 12
 parts of the screen 11
POP3 mail service 47
pouch 2
power
 battery life 34
 charging battery 8, 35, 37
 conserving 39, 75, 76
 external 36
Power button 5, 7
PowerPoint Mobile 4
precision 25
preferences 71
pre-installed software 4
programs, pre-installed 4
protocols 23

R

radio noise emissions, Canada iii
reactivating the Bluetooth radio 52
real-time
 external correction source 28
 GPS COM port (COM4) 28
 SBAS corrections 27
 troubleshooting 79
receiving e-mail 48
recharging battery from external power source 37
recording notes 5
release button on support module 8
remote connection 45
removable storage [See](#) SD memory card 5
resetting
 GPS receiver 26
 handheld 43
RTCM 22

S

safety
 AC power adaptor x, 35
 battery ix, 34
satellite geometry 26
SBAS satellites
 troubleshooting 79
 using 27
screen 2, 5, 77
screwdriver 12, 41
SD card slot xi, 5
SD memory card
 inserting 41
 removing 41
 using 5, 19
sending e-mail 48

- serial clip
 - attaching to handheld 69
 - connecting to external device 69
 - connecting to external power 36
 - recharging battery with 37
- serial connection
 - using Bluetooth 16
 - using USB support module connection 16
- Serial Port
 - client, setting up a 58, 59
 - host, adding a 61
 - service 58, 61
- servicing 77
- Skyplot 24
- skyplot 26
- SMTP mail service 47
- soft reset 7, 43
- softkeys 7
- software
 - authorizing 10
 - Bluetooth Activation Manager 52
 - GPS Connector 4, 28, 62
 - GPS Controller 4, 24
 - installing 19
 - pre-installed 4
 - Trimble GPS Analyst
 - extension 20
 - Trimble GPSCorrect extension 23
- sounds 73
- speaker 6
- spreadsheets, working with 4
- Start button 7
- static GPS positions 30
- storage space 40
- storage, removable [See](#) SD memory card 5
- storing 77
- streaming GPS positions 30
- stylus 2, 12, 41

- support module
 - connecting to desktop computer 16
 - placing handheld in 2, 8
 - removing handheld from 8
 - using to charge battery 35
- Suspend mode 7, 39, 77
- swipes, communication 6
- synchronizing information 17
- system components 2

T

- Tasks 4
- TerraSync software
 - automatically transferring data 18
 - connecting to GPS 23
 - documentation 1
 - installing 19
 - mission planning 26
 - real-time setup 27, 28
- text editor 4
- text entry 13
- touch screen 85
- Transcriber 14
- Trimble GPS Analyst extension 20
- Trimble GPSCorrect extension
 - connecting to GPS 23
 - documentation 1
 - installing 20
 - mission planning 26
 - real-time setup 27, 28
- troubleshooting
 - ActiveSync 81
 - battery 78
 - Bluetooth wireless technology 82
 - GPS 79
 - real-time 79

- touch screen 85
- wireless LAN 83, 84

TSIP

- applications 23
- GPS COM port for 22
- output to external device 29

turning on and off

- backlight 9
- Bluetooth radio 53
- GPS receiver 39
- handheld 9, 77
- wireless signals 54, 65

U

USB connection 16, 81

USB data cable 2

Using 63, 66

using

- Bluetooth wireless technology 51
- cabled Ethernet 66
- GPS 22
- WLAN radio 63

V

vehicle, using power from 36

velocity filtering 25

Virtual Private Network (VPN) 46

Virtual Reference Station (VRS) 55, 56

Voice Recorder 5

VPN server connection 46

W

WAAS satellites 27, 79

Windows Media 4

wireless LAN

- connections 44, 64

- troubleshooting 83, 84

- wireless signals, turning on and off 54, 65

- WLAN radio 5, 39, 63

- WLAN *See* wireless LAN *and* WLAN radio 44

- Word Mobile 4

- World Wide Web 4, 48, 49

Z

- Zephyr antenna 3, 29



NORTH & SOUTH AMERICA

Trimble Navigation Limited
7401 Church Ranch Blvd
Westminster, CO 80021
USA

**EUROPE, AFRICA &
MIDDLE EAST**

Trimble GmbH
Am Prime Parc 11
65479 Raunheim
GERMANY

ASIA-PACIFIC

Trimble Navigation Australia
PTY Limited
120 Wickham Street
Fortitude Valley, QLD 4006
AUSTRALIA



www.trimble.com