

Thomas N. Cokenias *EMC/RFI Specialist*
Test & Consulting Services for Commercial, Military, International Compliance
P.O. Box 50128
Palo Alto, CA 94303

CERTIFICATION TEST REPORT FOR A 902-928 MHz FHSS TRANSCEIVER

Applicant: Trimble Navigation Limited
645 North Mary Avenue
Sunnyvale, CA 94086

Model: TRIMCOMM 900IP, TC900IP
FCC ID: JUP-7112-900IP

Model Differences: Case color, different data I/O and power connectors

Operating Frequency: 902-928 MHz

RF Output Power: 28 dBm

FCC Rule Part: 15.247

Used For: Data link between two GPS receivers

Power Source: 13.5 V battery operation
Also works from 13.5 VDC tap on AC operated battery charger

Test Location: Compliance Consulting Services
951F Monterey Road
Morgan Hill, CA 95087

All tests were performed by me or under my supervision. The Trimcomm 900IP meets all emissions and modulation requirements specified under Parts 2 and 15 of the Commission's Rules.

THOMAS N. COKENIAS

8 October

EXHIBITS

EXHIBIT A: Letter Requesting Confidentiality under Sec. 0.457(d)

EXHIBIT B: Information for which Confidentiality is Requested

B1: Theory of Operation

B2: Block Diagram

B3 Schematics

EXHIBIT C: Product Photographs

EXHIBIT D: FCC ID Label Drawing

EXHIBIT E: User Manual

EXHIBIT F: Schematics and Block Diagrams

EXHIBIT G: Theory of Operation and Hopping Frequency List

EXHIBIT H: Description of Antennas and Antenna Connector Per 15.203

EXHIBIT I: Report of Measurements

EXHIBIT A: Letter Requesting Confidentiality under Sec. 0.457(d)

EXHIBIT B: Information for which Confidentiality is Requested

B1: Theory of Operation

B2: Block Diagram

B3 Schematics

EXHIBIT C: Product Photographs

EXHIBIT D: FCC ID Label Drawing

EXHIBIT E: User Manual

EXHIBIT F: Schematics and Block Diagrams

-see Exhibit B (confidential material)

EXHIBIT G: Theory of Operation and List of Hopping Frequencies

-see Exhibit B (confidential material)

**EXHIBIT H: Description of Antennas and Antenna Connector per
FCC Rule Para. 15.203**

The TC900IP uses a unique antenna connector

EXHIBIT I: Report of Measurements

EMISSIONS TEST REPORT FOR A LOW POWER TRANSMITTER

I. GENERAL INFORMATION

Requirement: Federal Communications Commissions

Test Requirements: 15.107, 15.109, 15.205, 15.207, 15.209, 15.247

Applicant: Trimble Navigation Ltd.
645 North Mary Avenue
Sunnyvale, CA 94086

Model: TRIMCOMM 900IP, TC900IP
FCC ID: JUP-7112-900IP

Model Differences: Case color, different data I/O and power connectors

II. DESCRIPTION OF EQUIPMENT UNDER TEST (EUT)

The Trimcomm FCC ID: JUP-7112-900IP is a 902-928 MHz frequency hopping spread spectrum (FHSS) transceiver used to link data between two or more GPS receivers. Three different antennas are available for use with this transceiver: a short whip, a whip with one helical coil, and a whip with two helical coils.

III. TEST LOCATION

All emissions tests were performed at:

Compliance Certification Services
561F Monterey Road
Morgan Hill, CA 95037

TEST PROCEDURES

Radiated Emissions

Test Requirement: 15.205

Measurement Equipment Used:

HP 8593EM Spectrum Analyzer

HP 8449 Preamplifier, 1-26.5 GHz

FSY high pass filter, $f_o = 1800$ MHz

EMCO 3115 Double Ridged Horn antenna, 1 - 18 GHz

16 ft Flexco low loss cable (0.85 dB/ft at 26.5 GHz)

Test Set-Up

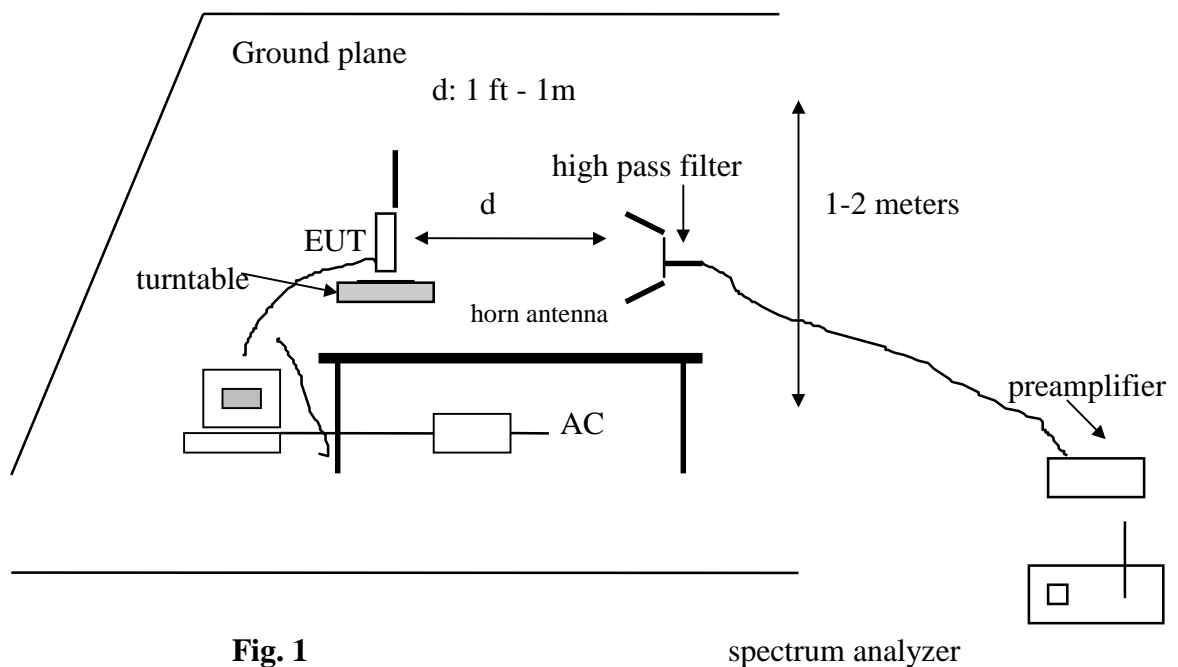

Fig. 1

spectrum analyzer

1. The EUT was placed on a wooden table resting on a turntable on the open air test site. The search antenna was placed 3m from the EUT. The EUT antenna was mounted vertically as per normal installation.
2. The turntable was slowly rotated to locate the direction of maximum emission at each emission falling in the restricted bands of 15.205.

3. Once maximum direction was determined, the search antenna was raised and lowered in both vertical and horizontal polarizations. The maximum readings so obtained are recorded in the data listed below.

Test Results: Refer to attached tabular data sheets

AC Line Conducted Emissions Test Requirement: 15.107, 15.207

Measurement Equipment Used:

Rohde & Schwarz EMI Receiver ESHS-20
Fischer Custom Communication LISN, FCC-LISN-50/250-25-2

Test Set-up

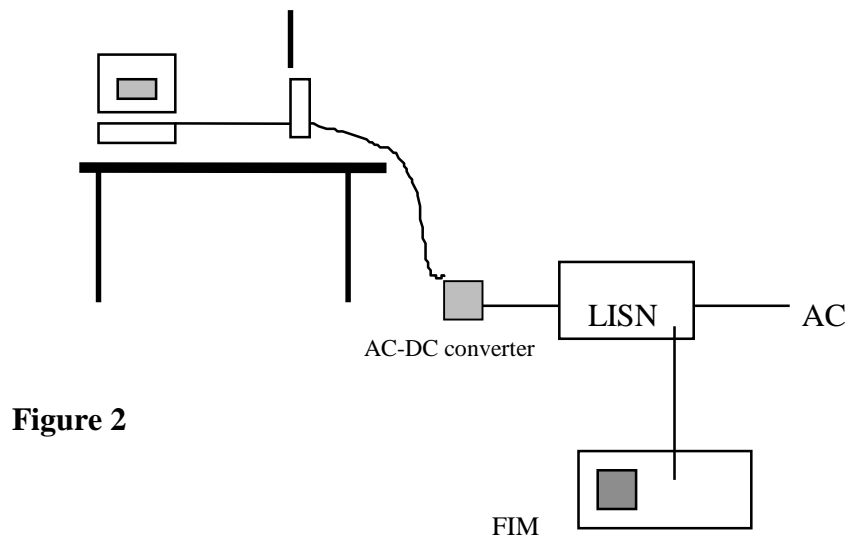

Test Procedure

1. The EUT was placed on a wooden table 40 cm from a vertical ground plane and approximately 80 cm above the horizontal ground plane on the floor. The EUT was set to transmit in a normal hopping mode.
2. Line conducted data was recorded for both NEUTRAL and HOT lines.

Test Results

Refer to attached graph and tabulated data sheets.

Minimum 20 dB Bandwidth for FHSS**Test Requirement: 15.247****Measurement Equipment Used:**

HP 8593EM Spectrum Analyzer
2 ft Flexco low loss cable (0.85 dB/ft at 26.5 GHz)

Measurement Equipment Used:

HP 8563E Spectrum Analyzer
Narda Coaxial attenuator, 30 dB, DC-12.6 GHz
Flexco low loss cable, 3ft (loss: 0.85 dB/ft@ 26 GHz)

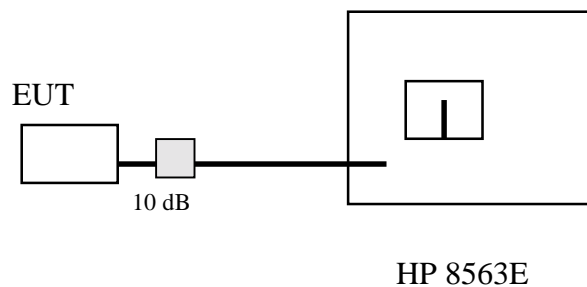
Test Set-up**Fig. 3****Test Procedures**

1. The EUT was configured on a test bench. The EUT's hopping function was stopped, transmission was continuous at 915.865 MHz (MID channel). While the transmitter broadcast a steady stream of digital data, the analyzer MAX HOLD function was used to capture the envelope of the transmission occupied bandwidth.
2. The process in (1) was repeated for 902.625 MHz (LOW channel) and 927.585 MHz (HIGH channel).

Test Results: Refer to attached spectrum analyzer charts. Data taken with RES BW of 30 kHz shows 20 dB BW of approximately 650 kHz.

RF Power Output**Test Requirement:** 15.247**Measurement Equipment Used:**

HP 436 A power meter w/HP8482A power head

Test Procedures

1. The EUT was configured on a test bench. The antenna was removed and a suitable matching connector was screwed on. The HP8482A was connected directly to the antenna adapter.

The EUT's hopping function was stopped, transmission was continuous at the LOW channel. While the transmitter broadcast a steady stream of digital data, the analyzer MAX HOLD function was used to capture the envelope of the transmission.

2. The process in (1) was repeated for MID channel and HIGH channel.

Test Results

Refer to attached data sheets showing readings in dBuV. Power level readings converted to dBm are shown below

Channel	Frequency, MHz	Output Power, dBm	Limit, dBm
Low	902.625	28.68	30.0
Mid	913.854	28.15	30.0
High	927.585	28.23	30.0

Out of Band Measurements**Test Requirement: 15.247****Measurement Equipment Used:**

HP 8593EM Spectrum Analyzer
2 ft Flexco low loss cable (0.85 dB/ft at 26.5 GHz)

Test Set-up

Per Figure 3 above.

Test Procedure

1. The EUT was configured on a test bench. The antenna was removed and a suitable matching connector was soldered. The Flexco cable was connected between the EUT and the spectrum analyzer input port.

Spectrum analyzer RES BW was set to 100 kHz. The EUT's hopping function was stopped, transmission was continuous at the LOW channel. While the transmitter broadcast a steady stream of digital data, the analyzer MAX HOLD function was used to capture the envelope of the transmission.

Readings were taken out to 10fo.

2. The process in (1) was repeated for MID channel and HIGH channel.

Test Results

Refer to attached data sheets. Data shows out of band emissions are suppressed well below the 20 dB minimum required by the Rules.

Minimum Number of Hopping Channels**Test Requirement: 15.247(a)(1)(ii)****Measurement Equipment Used:**

HP 8593EM Spectrum Analyzer
2 ft Flexco low loss cable (0.85 dB/ft at 26.5 GHz)

Test Set-up

Per Figure 3 above.

Test Procedure

The EUT was set to transmit in normal hopping mode. The spectrum analyzer was set to MAX HOLD and swept continuously for 5 - 10 minutes so as to capture all the hopping channels.

Test Results

A total of 50 hopping channels were counted. This corresponds to design. Refer to spectrum analyzer chart labelled 15.247(a)(1)(i).

Average Time of Channel Occupancy

Test Requirement: 15.247

Measurement Equipment Used:

HP 8593EM Spectrum Analyzer
2 ft Flexco low loss cable (0.85 dB/ft at 26.5 GHz)

Test Set-up

Per Figure 3 above.

Test Procedure

1. The EUT was set to transmit in normal hopping mode.
2. The analyzer was center tuned to 915.865 MHz. Analyzer frequency SPAN was set to ZERO SPAN. SWEEP TIME was set to 20 seconds, MAX HOLD function was engaged.
3. A total of 10 different 20 second sweeps were performed and the maximum time of channel occupancy was determined by the maximum number of transmissions detected in any 20 second period, times the duration of each transmission.

Test Results

Maximum channel occupancy time was determined to be $5 \times .67.5 \text{ msec} = 337.5 \text{ msec}$, below the 0.4 second maximum allowed. Refer to attached spectrum analyzer charts.

Radiated Emissions from ITE Portion of EUT**Test Requirement: FCC: 15.109****Industry Canada: ICES-003, 5.3****Measurement Equipment Used:**

HP 8568A Spectrum Analyzer

HP 8447D Preamplifier

Eaton 94456-1 Biconical Antenna, 20 - 200 MHz

EMCO 3146 Log Periodic Antenna, 200 - 1000 MHz

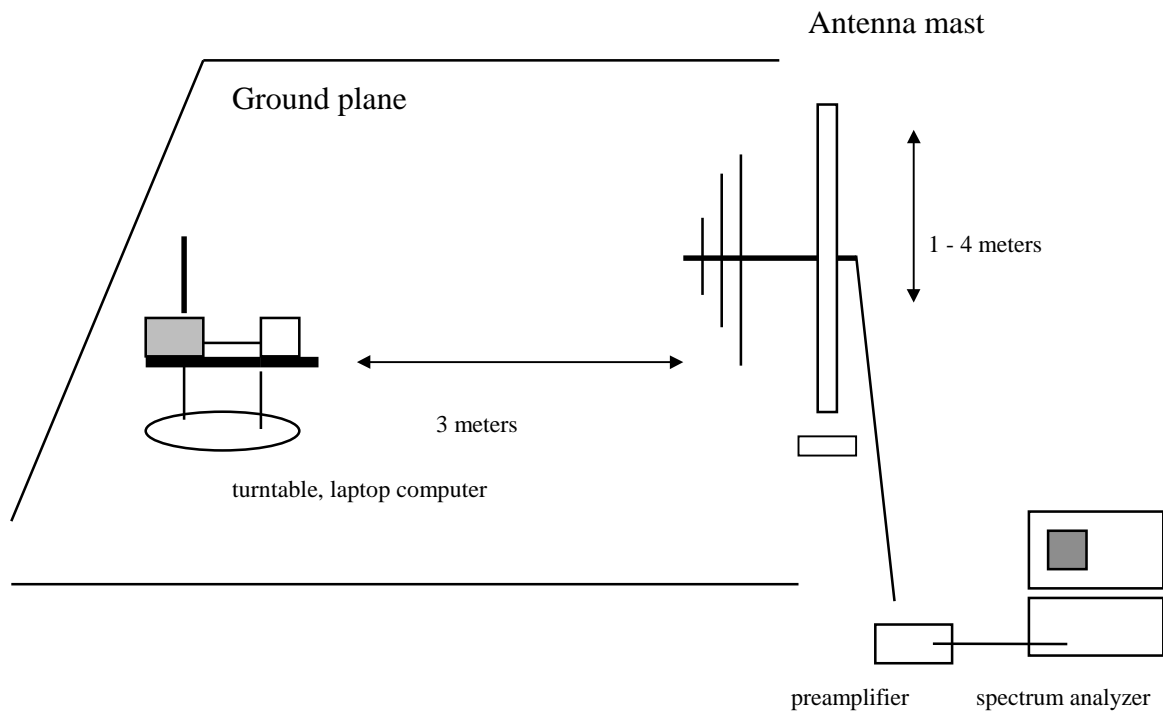
Test Set-up**Fig. 5****Test Procedure**

The EUT was set to transmit mode on the LOW channel. Radiation emissions from the digital portion of the EUT were measured according to the dictates of ANSI C63.4.

The test was repeated with the EUT transmitting on the MID channel and the HIGH channel.

Test Results

Refer to tabulated data sheet.

DATA SHEETS, CHARTS, AND GRAPHS

RADIATED EMISSIONS - SHORT WHIP

COMPLIANCE ENGINEERING SERVICES, INC.

Out of Band
15.247

10/7/99
Juan
Martinez
C site (1.0 Meter)

Trimble
Trimcomm900IP w/ short whip
antenna

fo= 902.63 MHz (Peak of 123.3 dBuV/m @ 3 meters)

F(MHz)	READING		AF	CL	AMP	DIST	HP	TOTAL		LIMI		MARGIN	
	(dBu V)	Avg						(dB)	(dB)	(dB)	(dB)	(dB)	(dB)
1805	52.6		27	2.5	0	-15.5	0	66.6		103			-36.7
2707.89	44.1	31.9	31	3.5	-35	-9.5	1	35.1	22.9	74	54	-38.9	-31.1
3610.52	41.1	29.6	33.2	3.8	-35	-9.5	1	34.6	23.1	74	54	-39.4	-30.9
4513.15	45.9	37.1	32.5	4.62	-35	-9.5	1	39.5	30.8	74	54	-34.5	-23.2
5416	52.3	48.4	34	4.95	-35	-9.5	1	47.7	43.8	74	54	-26.3	-10.2
6319	52.8	48.6	35.9	5.44	-35	-9.5	1	50.6	46.4	74	54	-23.4	-7.58
7221	48.9	40.7	37	5.94	-35	-9.5	1	48.4	40.2	74	54	-25.6	-13.8
8124	42.9	35.6	37.5	6.6	-35	-9.5	1	43.5	36.2	74	54	-30.5	-17.8
9026	44	33.9	39.1	6.79	-35	-9.5	1	46.4	36.3	74	54	-27.6	-17.7
fo=													
913.8													
1827	41.2	28.7	27	2.5	-35	-9.5	1	27.2	14.7	74	54	-46.8	-39.3
2745.9	44.3	31.8	31	3.5	-35	-9.5	1	35.3	22.8	74	54	-38.7	-31.2
3661.2	43.8	35.9	33.2	3.8	-35	-9.5	1	37.3	29.4	74	54	-36.7	-24.6
4576.7	41.7	34.6	32.5	4.62	-35	-9.5	1	35.3	28.3	74	54	-38.7	-25.7
5483	52	44.1	34	4.95	-35	-9.5	1	47.4	39.5	74	54	-26.6	-14.5
6397	52.9	48.8	35.9	5.44	-35	-9.5	1	50.7	46.6	74	54	-23.3	-7.41
7322.6	45.6	38.4	37	5.94	-35	-9.5	1	45	37.9	74	54	-29	-16.1
8224	38.1	25.6	37.5	6.6	-35	-9.5	1	38.7	26.2	74	54	-35.3	-27.8
9138	42.9	33.6	39.1	6.79	-35	-9.5	1	45.3	36	74	54	-28.7	-18.1
fo=													
927.6													

1855	45.3	36.4	27	2.5	-35	-9.5	1	31.3	22.4	74	54	-42.7	-31.6
2783	45.9	36.9	31	3.5	-35	-9.5	1	36.9	27.9	74	54	-37.1	-26.1
3711	49.1	39.6	33.2	3.8	-35	-9.5	1	42.6	33.1	74	54	-31.4	-20.9
4638	44.3	35.8	32.5	4.62	-35	-9.5	1	37.9	29.5	74	54	-36.1	-24.5
5566	43.7	37.4	34	4.95	-35	-9.5	1	39.2	32.8	74	54	-34.8	-21.2
6493	47.9	36.8	35.9	5.44	-35	-9.5	1	45.7	34.7	74	54	-28.3	-19.3
7421	43.2	25.1	37	5.94	-35	-9.5	1	42.6	24.5	74	54	-31.4	-29.5
8348	38	25.7	37.5	6.6	-35	-9.5	1	38.6	26.3	74	54	-35.4	-27.7
9276	39	26.1	39.1	6.79	-35	-9.5	1	41.4	28.5	74	54	-32.6	-25.5

NOTE: ALL READINGS ARE

VERTICAL

DIST: Correction to extrapolate reading to 3m specification distance

1.0M measurement distance: -

10.45dB

0.5M measurement distance: -

15.5dB

AF: Antenna Factor

AMP: Pre-amp gain

CL: Cable loss

HPF: High pass filter insertion loss
(1.802GHz)

FSY (S/N: 001)

ANALYZER
SETTINGS

<u>Res</u>	<u>Avg.</u>
<u>bw</u>	<u>bw</u>

PEAK(Pk): 1MH

z

AVERAGE(Avg): 1MH

z

z

COMPLIANCE ENGINEERING SERVICES, INC.

Out of Band

15.247

10/7/99
 Juan Martinez
 C site (1.0 Meter)

Trimble
 Trimcomm900IP w/ 1 coil whip antenna

fo= 902.63 MHz (Peak of 123.3 dBuV/m @ 3 meters)

F(MHz)	READING		AF (dB)	CL (dB)	AMP (dB)	DIST (dB)	HP (dB)	TOT AL		LIMI T (dBu V/m)	MAR GIN (dB)		
	(dBu V)							(dBu V/m)					
	<u>Pk</u>	<u>Avg</u>						<u>Pk</u>	<u>Avg</u>	<u>Pk</u>	<u>Avg</u>	<u>Pk</u>	<u>Avg</u>
1805	57.96		27	2.5	0	-15.5	0	71.96		103.3		-	
												31.34	
2707.89	44.06	31.84	31	3.5	-35	-9.5	1	35.06	22.84	74	54	-	-
												38.94	31.16
3610.52	44.75	37.68	33.2	3.8	-35	-9.5	1	38.25	31.18	74	54	-	-
												35.75	22.82
4513.15	46.93	39.77	32.5	4.62	-35	-9.5	1	40.55	33.39	74	54	-	-
												33.45	20.61
5416	57.29	51.79	34	4.95	-35	-9.5	1	52.74	47.24	74	54	-	-6.76
												21.26	
6319	54	48.04	35.9	5.44	-35	-9.5	1	51.84	45.88	74	54	-	-8.12
												22.16	
7221	46.11	39.35	37	5.94	-35	-9.5	1	45.55	38.79	74	54	-	-
												28.45	15.21
8124	39.14	26.96	37.5	6.6	-35	-9.5	1	39.74	27.56	74	54	-	-
												34.26	26.44
9026	43.79	36.97	39.1	6.79	-35	-9.5	1	46.18	39.36	74	54	-	-
												27.82	14.64
fo=													
913.8													
1827	41.45	28.97	27	2.5	-35	-9.5	1	27.45	14.97	74	54	-	-
												46.55	39.03
2745.9	45.24	31.8	31	3.5	-35	-9.5	1	36.24	22.8	74	54	-	-31.2

													37.76
3661.2	45.31	38.37	33.2	3.8	-35	-9.5	1	38.81	31.87	74	54	-	-
												35.19	22.13
4576.7	42.94	33.23	32.5	4.62	-35	-9.5	1	36.56	26.85	74	54	-	-
												37.44	27.15
5483	43.35	36.61	34	4.95	-35	-9.5	1	38.8	32.06	74	54	-35.2	-
													21.94
6397	53.82	47.46	35.9	5.44	-35	-9.5	1	51.66	45.3	74	54	-	-8.7
												22.34	
7322.6	47.19	40.84	37	5.94	-35	-9.5	1	46.63	40.28	74	54	-	-
												27.37	13.72
8224	40.11	28.85	37.5	6.6	-35	-9.5	1	40.71	29.45	74	54	-	-
												33.29	24.55
9138	44.07	37.27	39.1	6.79	-35	-9.5	1	46.46	39.66	74	54	-	-
												27.54	14.34
fo=													
927.6													
1855	42.19	28.29	27	2.5	-35	-9.5	1	28.19	14.29	74	54	-	-
												45.81	39.71
2783	45.22	32.15	31	3.5	-35	-9.5	1	36.22	23.15	74	54	-	-
												37.78	30.85
3711	47.26	36.86	33.2	3.8	-35	-9.5	1	40.76	30.36	74	54	-	-
												33.24	23.64
4638	43.07	35.4	32.5	4.62	-35	-9.5	1	36.69	29.02	74	54	-	-
												37.31	24.98
5566	43.58	37.55	34	4.95	-35	-9.5	1	39.03	33	74	54	-	-21
												34.97	
6493	47.62	37.67	35.9	5.44	-35	-9.5	1	45.46	35.51	74	54	-	-
												28.54	18.49
7421	44.64	40.84	37	5.94	-35	-9.5	1	44.08	40.28	74	54	-	-
												29.92	13.72
8348	39.16	27.13	37.5	6.6	-35	-9.5	1	39.76	27.73	74	54	-	-
												34.24	26.27
9276	38.71	25.98	39.1	6.79	-35	-9.5	1	41.1	28.37	74	54	-32.9	-
													25.63

NOTE: ALL READINGS ARE VERTICAL

DIST: Correction to extrapolate reading to 3m specification distance

1.0M measurement distance: **-10.45dB**

0.5M measurement distance: **-15.5dB**

AF: Antenna

ANALYZER SETTINGS

	<u>Res</u>	<u>Avg.</u>
	<u>bw</u>	<u>bw</u>
PEAK(Pk):	1MH	1MH
	z	z
AVERAGE(Avg):	1MH	10Hz
	z	

Factor

AMP: Pre-amp
gain

CL:
Cable
loss

HPF: High pass filter insertion loss
(1.802GHz)

FSY (S/N:
001)

COMPLIANCE ENGINEERING SERVICES, INC.

Out of Band

15.247

10/7/99
 Juan Martinez
 C site (1.0 Meter)

Trimble
 Trimcomm900IP w/ **Double coil whip antenna**

fo= 902.63 MHz (Peak of 123.3 dBuV/m @ 3 meters)

F(MHz)	READING (dBu V)		AF (dB)	CL (dB)	AMP (dB)	DIST (dB)	HP (dB)	TOT AL (dBu V/m)	LIMI T (dBu V/m)		MARGIN (dB)		
	<u>Pk</u>	<u>Avg</u>						<u>Pk</u>	<u>Avg</u>	<u>Pk</u>	<u>Avg</u>	<u>Pk</u>	<u>Avg</u>
1805	52.43		27	2.5	0	-15.5	0	66.43		103.3		-	
												36.87	
2707.89	43.6	31.68	31	3.5	-35	-9.5	1	34.6	22.68	74	54	-39.4	-
													31.32
3610.52	43.57	35.44	33.2	3.8	-35	-9.5	1	37.07	28.94	74	54	-	-
												36.93	25.06
4513.15	44.5	36.33	32.5	4.62	-35	-9.5	1	38.12	29.95	74	54	-	-
												35.88	24.05
5416	53.09	47.26	34	4.95	-35	-9.5	1	48.54	42.71	74	54	-	-
												25.46	11.29
6319	52.25	47.25	35.9	5.44	-35	-9.5	1	50.09	45.09	74	54	-	-8.91
												23.91	
7221	45.37	38.39	37	5.94	-35	-9.5	1	44.81	37.83	74	54	-	-
												29.19	16.17
8124	38.84	26.32	37.5	6.6	-35	-9.5	1	39.44	26.92	74	54	-	-
												34.56	27.08
9026	44.42	38.34	39.1	6.79	-35	-9.5	1	46.81	40.73	74	54	-	-
												27.19	13.27
fo=													
913.8													
1827	40.87	28.85	27	2.5	-35	-9.5	1	26.87	14.85	74	54	-	-
												47.13	39.15
2745.9	44.14	31.7	31	3.5	-35	-9.5	1	35.14	22.7	74	54	-	-31.3

Factor

AMP: Pre-amp
gain

CL:
Cable

loss

HPF: High pass filter insertion loss
(1.802GHz)

FSY (S/N:
001)

CONDUCTED EMISSIONS



1366 Bordeaux Dr.
Sunnyvale, CA 94089-1005 USA
Tel: (408) 752-8166
Fax: (408) 752-8168

Data#: 7 File#: 99U0517.EMI Date: 08-27-1999 Time: 10:48:53

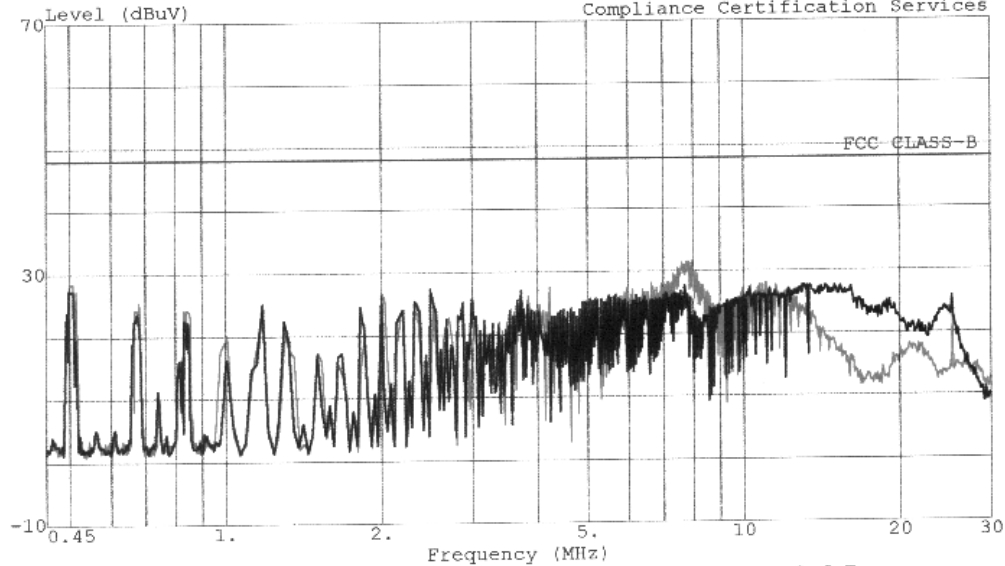

Trace: 3
Project No. : 99U0517-1
Report No. : 990827LC
Test Engr : Jesse Saldivar *JS*
Company : Trimble
EUT : Trimcomm 900-1999
Test Config.: EUT/PRINTER/LAPTOP
Type of Test: FCC 15.247
Mode of Op. : NORMAL
 : Peak: L1(Green), L2(Black); 110Vac, 60Hz

Ref Trace:

MAXIMUM 20 dB BANDWIDTH

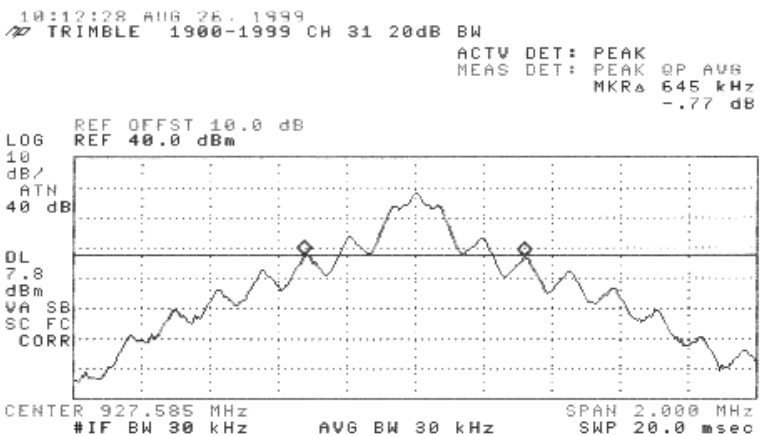
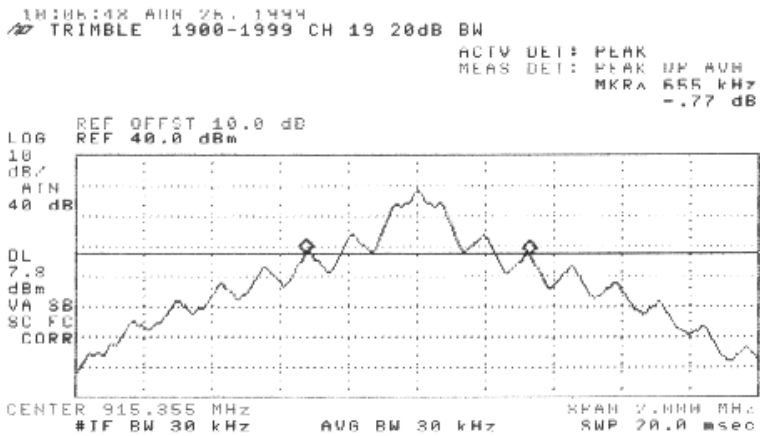
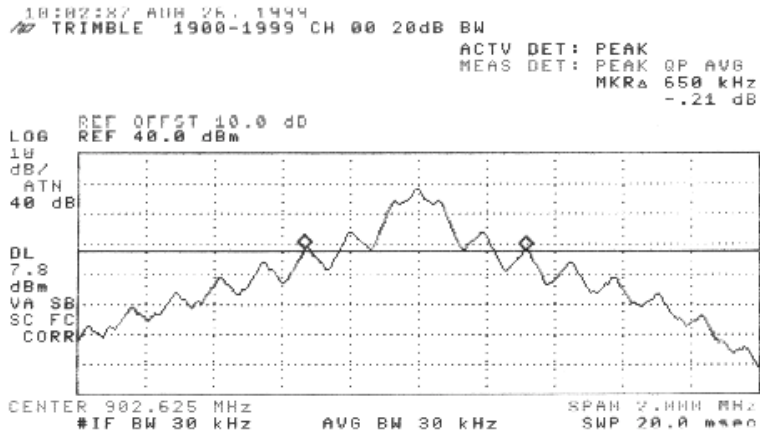

OUT OF BAND MEASUREMENTS

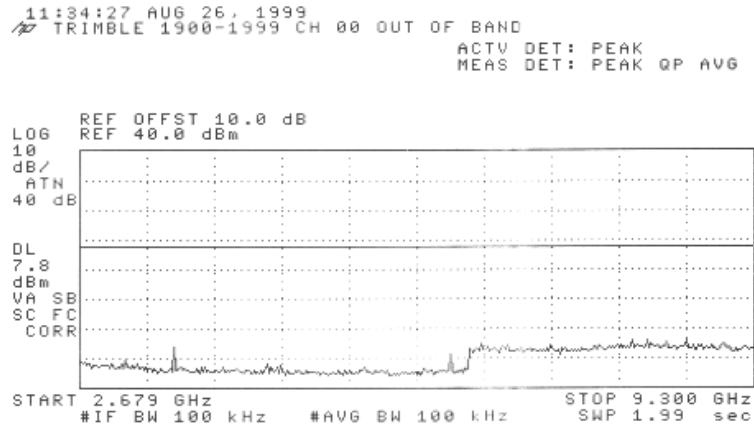
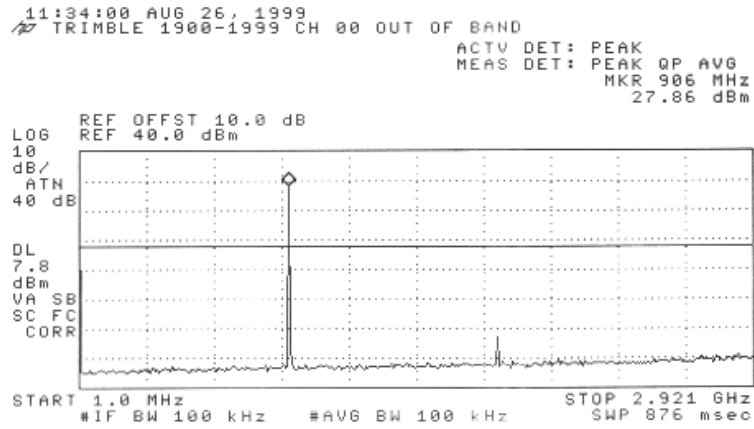

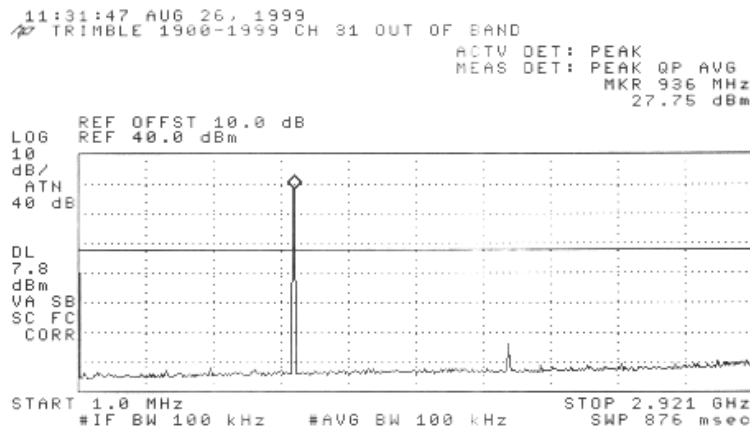
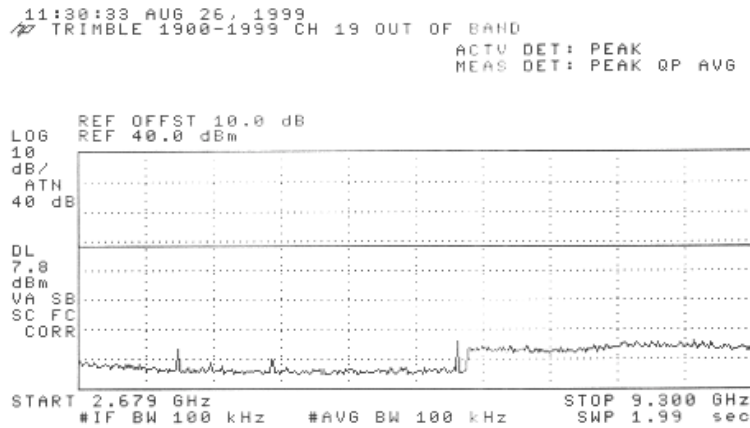
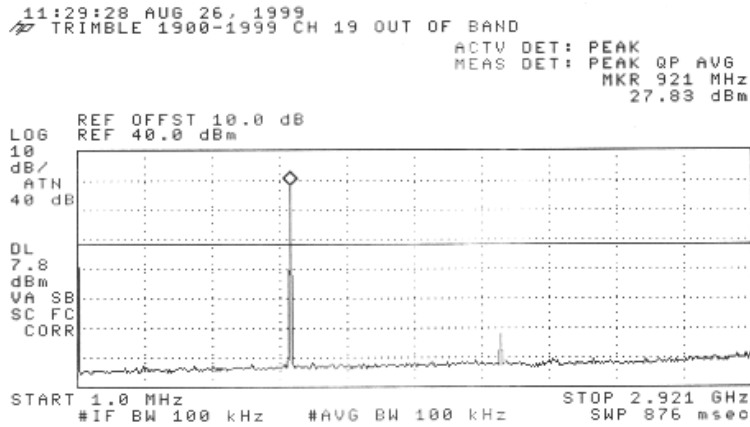

11:32:23 AUG 26, 1999
TRIMBLE 1900-1999 CH 31 OUT OF BAND

ACTV DET: PEAK
MEAS DET: PEAK QP AVG

LOG REF OFFST 10.0 dB
10 dB/ REF 40.0 dBm
ATN 40 dB

DL 7.8 dBm
VA SB
SC FC
CORR

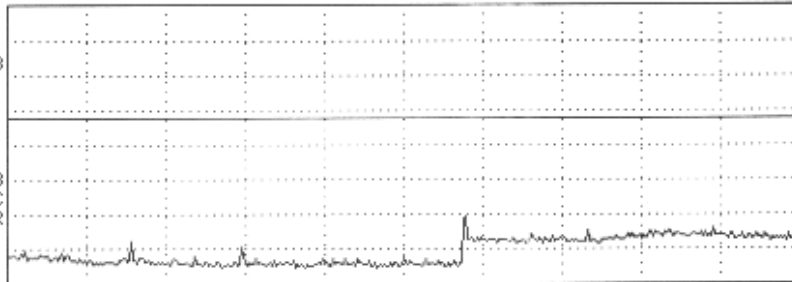

START 2.679 GHz STOP 9.300 GHz
#IF BW 100 kHz #AVG BW 100 kHz SWP 1.99 sec

MINIMUM NUMBER OF HOPPING CHANNELS

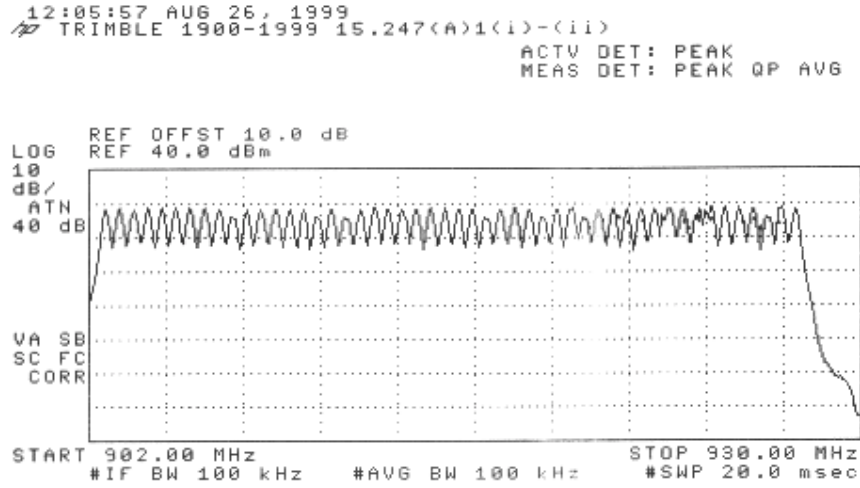

AVERAGE TIME OF CHANNEL OCCUPANCY

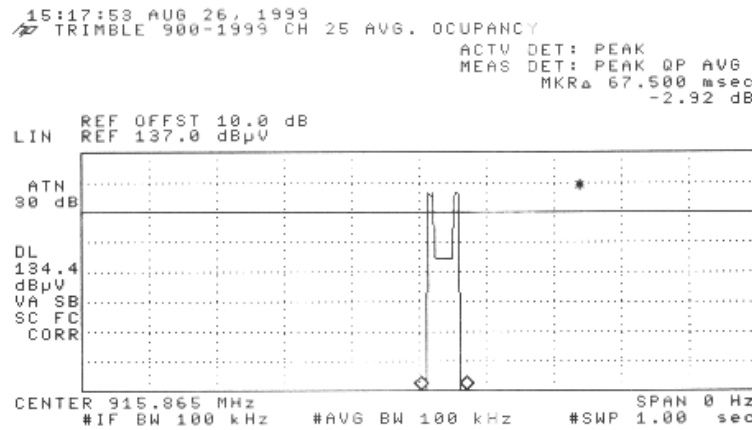
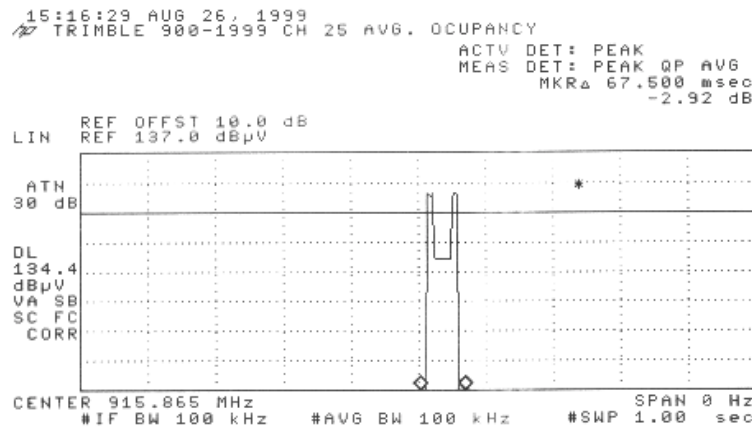
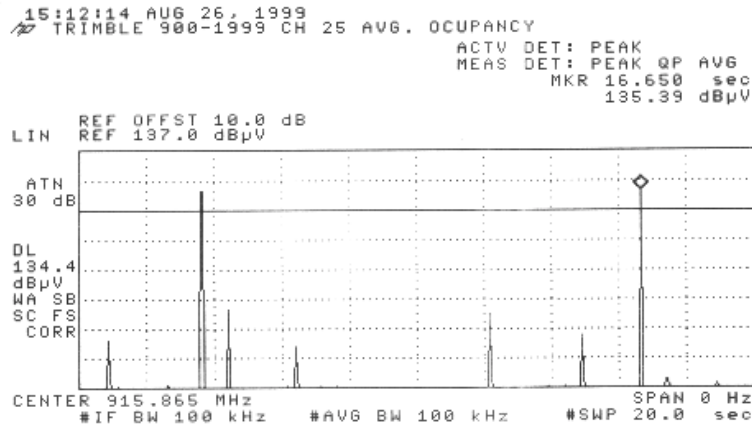

RADIATED EMISSIONS FOR ITE PORTION OF EUT

Compliance Engineering Services Inc. Project No. :
 Report No. : 990825C1
 Date : 08/25/1999
 Time : 14:06
 Test Engr : JESSE SALDIVAR

>> 3 M RADIATED EMISSION DATA <<

Company : TRIMBLE
 Equipment Under Test : TRIMCOM 900-1999
 Test Configuration : EUT/LAPTOP PC/MOUSE/KEYBOARD
 Type of Test : FCC CLASS B
 Mode of Operation : TX/RX

Freq.	dBuV	PreAmp	Ant	Cable	dBuV/m	Limit	Margin	Pol	Hgt(m)	Az
16MHz STEP:										
Biconical 1214 ; Pre-pamp = 8447D-P5 2944A06550:										
80.00	48.20	-27.34	8.83	1.14	30.83	40.00	-9.17	V	1.0	180
80.00	38.50	-27.34	8.15	1.14	20.45	40.00	-19.55	H	1.0	180
LP 9107-3163 ; Pre-pamp = 8447D-P5 2944A06550:										
416.03	37.70	-27.36	15.58	2.78	28.71	46.00	-17.29	V	1.0	180
428.00	43.50	-27.43	15.84	2.82	34.74	46.00	-11.26	V	1.0	180
428.00	40.80	-27.43	16.04	2.82	32.23	46.00	-13.77	H	1.0	270
416.00	39.90	-27.36	15.84	2.78	31.17	46.00	-14.83	H	1.0	180

COMPLETED SCAN FROM 30MHz TO 1GHz IN VERTICAL AND HORIZONTAL POLARIZATIONS.

Total # of data 6
 V. c2.2