



FCC PART 15 SUBPART C
IC RSS-210 ISSUE 8, DEC 2010



TEST AND MEASUREMENT REPORT

For

Trimble Navigation Ltd

935 Stewart Drive,
Sunnyvale, CA 94085, USA

FCC ID: JUP-6829395
IC: 1756A-6829395

Report Type: Original Report	Product Type: GPS Receiver with 900 MHz Transceiver
Test Engineer: <u>Quinn Jiang</u>	
Report Number: <u>R1202012-247</u>	
Report Date: <u>2012-04-05</u>	
Reviewed By: <u>RF/EMC Lead</u>	Victor Zhang 
Prepared By: <u>(84)</u>	Bay Area Compliance Laboratories Corp. 1274 Anvilwood Avenue, Sunnyvale, CA 94089, USA Tel: (408) 732-9162 Fax: (408) 732 9164

Note: This test report is prepared for the customer shown above and for the device described herein. It may not be duplicated or used in part without prior written consent from Bay Area Compliance Laboratories Corp. This report **must not** be used by the customer to claim product certification, approval, or endorsement by NVLAP*, NIST, or any agency of the Federal Government.

* This report may contain data that are not covered by the NVLAP accreditation and are marked with an asterisk "*" ...

TABLE OF CONTENTS

1	GENERAL INFORMATION.....	6
1.1	PRODUCT DESCRIPTION FOR EQUIPMENT UNDER TEST (EUT).....	6
1.2	MECHANICAL DESCRIPTION OF EUT.....	6
1.3	OBJECTIVE.....	6
1.4	RELATED SUBMITTAL(S)/GRANT(S).....	6
1.5	TEST METHODOLOGY.....	6
1.6	MEASUREMENT UNCERTAINTY.....	6
1.7	TEST FACILITY.....	7
2	SYSTEM TEST CONFIGURATION.....	8
2.1	JUSTIFICATION.....	8
2.2	EUT EXERCISE SOFTWARE.....	8
2.3	SPECIAL ACCESSORIES.....	8
2.4	EQUIPMENT MODIFICATIONS.....	8
2.5	LOCAL SUPPORT EQUIPMENT.....	8
2.6	POWER SUPPLY AND LINE FILTERS.....	8
2.7	INTERFACE PORTS AND CABLING.....	8
2.8	INTERNAL PARTS LIST AND DETAILS.....	9
3	SUMMARY OF TEST RESULTS.....	10
4	FCC §15.203 & IC RSS-GEN §7.1.2 – ANTENNA REQUIREMENTS.....	11
4.1	APPLICABLE STANDARD.....	11
4.2	RESULT.....	11
5	FCC §15.207 & IC RSS-GEN §7.2.4 – AC LINE CONDUCTED EMISSIONS.....	12
5.1	APPLICABLE STANDARDS.....	12
5.2	TEST SETUP.....	12
5.3	TEST PROCEDURE.....	12
5.4	TEST SETUP BLOCK DIAGRAM.....	13
5.5	CORRECTED AMPLITUDE & MARGIN CALCULATION.....	13
5.6	TEST EQUIPMENT LIST AND DETAILS.....	14
5.7	TEST ENVIRONMENTAL CONDITIONS.....	14
5.8	SUMMARY OF TEST RESULTS.....	14
5.9	CONDUCTED EMISSIONS TEST PLOTS AND DATA.....	15
6	FCC §15.205, §15.209, §15.247(D) & IC RSS-210 §2.2, §A8.5 – SPURIOUS RADIATED EMISSIONS.....	17
6.1	APPLICABLE STANDARD.....	17
6.2	TEST SETUP.....	18
6.3	TEST PROCEDURE.....	18
6.4	CORRECTED AMPLITUDE & MARGIN CALCULATION.....	19
6.5	TEST EQUIPMENT LIST AND DETAILS.....	19
6.6	TEST ENVIRONMENTAL CONDITIONS.....	19
6.7	SUMMARY OF TEST RESULTS.....	20
6.8	RADIATED EMISSIONS TEST RESULT DATA.....	21
7	FCC §15.247(A) & IC RSS-210 §A8.1 – HOPPING CHANNEL BANDWIDTH.....	24
7.1	APPLICABLE STANDARD.....	24
7.2	MEASUREMENT PROCEDURE.....	24
7.3	TEST EQUIPMENT LIST AND DETAILS.....	24

7.4	TEST ENVIRONMENTAL CONDITIONS.....	24
7.5	TEST RESULTS	25
8	FCC §15.247(A) & IC RSS-210 §A8.1 – HOPPING CHANNEL SEPARATION.....	27
8.1	APPLICABLE STANDARD.....	27
8.2	MEASUREMENT PROCEDURE.....	27
8.3	TEST EQUIPMENT LIST AND DETAILS	27
8.4	TEST ENVIRONMENTAL CONDITIONS.....	27
8.5	TEST RESULTS	28
9	FCC §15.247(A) & IC RSS-210 §A8.1 - NUMBER OF HOPPING CHANNELS	30
9.1	APPLICABLE STANDARD.....	30
9.2	MEASUREMENT PROCEDURE.....	30
9.3	TEST EQUIPMENT LIST AND DETAILS	30
9.4	TEST ENVIRONMENTAL CONDITIONS.....	30
9.5	TEST RESULTS	31
10	FCC §15.247(A) & IC RSS-210 §A8.1 - DWELL TIME.....	32
10.1	APPLICABLE STANDARD.....	32
10.2	MEASUREMENT PROCEDURE.....	32
10.3	TEST EQUIPMENT LIST AND DETAILS	32
10.4	TEST ENVIRONMENTAL CONDITIONS.....	32
10.5	TEST RESULTS	32
11	FCC §15.247(B) & IC RSS-210 §A8.4 – MAXIMUM PEAK OUTPUT POWER.....	36
11.1	APPLICABLE STANDARD.....	36
11.2	MEASUREMENT PROCEDURE.....	36
11.3	TEST EQUIPMENT LIST AND DETAILS	36
11.4	TEST ENVIRONMENTAL CONDITIONS.....	36
11.5	TEST RESULTS	36
12	FCC §15.247(D) & IC RSS-210 §A 8.5 - BAND EDGES EMISSIONS	37
12.1	APPLICABLE STANDARD.....	37
12.2	MEASUREMENT PROCEDURE.....	37
12.3	TEST EQUIPMENT LIST AND DETAILS	37
12.4	TEST ENVIRONMENTAL CONDITIONS.....	37
12.5	TEST RESULTS	38
13	FCC §15.247(D) & IC RSS-210 §A8.5 - SPURIOUS EMISSIONS AT ANTENNA TERMINALS.....	39
13.1	APPLICABLE STANDARD.....	39
13.2	MEASUREMENT PROCEDURE.....	39
13.3	TEST EQUIPMENT LIST AND DETAILS	39
13.4	TEST ENVIRONMENTAL CONDITIONS.....	39
13.5	TEST RESULTS	39
14	IC RSS-GEN §6 - RECEIVER RADIATED SPURIOUS EMISSIONS.....	43
14.1	APPLICABLE STANDARDS	43
14.2	EUT SETUP.....	43
14.3	TEST PROCEDURE	43
14.4	CORRECTED AMPLITUDE & MARGIN CALCULATION	43
14.5	TEST EQUIPMENT LIST AND DETAILS	44
14.6	TEST ENVIRONMENTAL CONDITIONS.....	44
14.7	SUMMARY OF TEST RESULTS.....	44
14.8	TEST RESULTS	45
15	FCC §15.247(I), §2.1091 & IC RSS-102 - RF EXPOSURE INFORMATION.....	47
15.1	APPLICABLE STANDARDS	47
15.2	MPE PREDICTION	48

15.3	MPE RESULTS	48
15.4	TEST RESULT	48
16	EXHIBIT A - FCC & IC EQUIPMENT LABELING REQUIREMENTS.....	49
16.1	FCC ID LABEL REQUIREMENTS	49
16.2	IC LABEL REQUIREMENTS	49
16.3	FCC ID & IC LABEL CONTENTS.....	50
16.4	FCC ID & IC LABEL LOCATION	50
17	EXHIBIT B - TEST SETUP PHOTOGRAPHS	51
17.1	RADIATED EMISSION FRONT VIEW	51
17.2	RADIATED EMISSION BELOW 1 GHZ REAR VIEW	51
17.3	RADIATED EMISSION ABOVE 1 GHZ REAR VIEW	52
17.4	AC LINE CONDUCTED EMISSION FRONT VIEW.....	52
17.5	AC LINE CONDUCTED EMISSION SIDE VIEW	53
18	EXHIBIT C - EUT PHOTOGRAPHS.....	54
18.1	EUT - TOP VIEW	54
18.2	EUT - BOTTOM VIEW	54
18.3	EUT - SIDE VIEW 1	55
18.4	EUT - SIDE VIEW 2.....	55
18.5	EUT - SIDE VIEW 3.....	56
18.6	EUT - SIDE VIEW 4 (BATTERY DOOR).....	56
18.7	EUT - COVER OFF VIEW 1.....	57
18.8	EUT - COVER OFF VIEW 2.....	57
18.9	EUT - 900 MHZ MODULE WITH SHIELD TOP VIEW	58
18.10	EUT - 900 MHZ MODULE WITHOUT SHIELD TOP VIEW	58
18.11	EUT - 900 MHZ MODULE WITH SHIELD BOTTOM VIEW	59
18.12	EUT - 900 MHZ MODULE WITHOUT SHIELD BOTTOM VIEW.....	59
18.13	POWER SUPPLY BOARD BOTTOM VIEW	60
18.14	EUT - GPS BOARD/ANTENNA TOP VIEW.....	60
18.15	EUT - GPS BOARD/ANTENNA SHIELDED BOTTOMVIEW	61
18.16	EUT - GPS BOARD/ANTENNA WITHOUT SHIELD BOTTOM VIEW	61
18.17	EUT - DIGITAL MAIN BOARD TOP VIEW	62
18.18	EUT - DIGITAL MAIN BOARD BOTTOM VIEW	62
18.19	EUT - KEYPAD INTERFACE BOARD TOP VIEW	63
18.20	EUT - KEYPAD INTERFACE BOARD BOTTOM VIEW	63
18.21	EUT - WI-FI AND BT ANTENNA TOP VIEW	64
18.22	EUT- WI-FI AND BT ANTENNA BOTTOM VIEW	64
18.23	EUT - RADIO INTERFACE BOARD TOP VIEW	65
18.24	EUT - RADIO INTERFACE BOARD BOTTOM VIEW	65
18.25	AC/DC ADAPTOR	66
18.26	EXTERNAL ANTENNA VIEW	66

DOCUMENT REVISION HISTORY

Revision Number	Report Number	Description of Revision	Date of Revision
0	R1202012-247	Original Report	2012-04-05

1 General Information

1.1 Product Description for Equipment under Test (EUT)

This test and measurement report was prepared on behalf of *Trimble Navigation* and their product, *model number: CBSMA-110B, P/N: 82500-95, FCC ID: JUP-6829395, IC: 1756A-6829395* or the “EUT” as referred to this report. The EUT is a 900 MHz FHSS transceiver which consists of GPS receiver, 2.4 GHz Wi-Fi+ Bluetooth module inside.

1.2 Mechanical Description of EUT

The EUT measures approximately 12 cm (**L**) x 12 cm (**W**) x 13 cm (**H**) and weighs approximately 1.55 g.

The data gathered are from a typical production sample provided by the manufacturer with serial ROCKD40570 provided by the manufacturer.

1.3 Objective

This report is prepared on behalf of *Trimble Navigation Ltd* in accordance with Part 2, Subpart J, and Part 15, Subparts B and C of the Federal Communication Commissions rules and IC RSS-210 Issue 8, Dec 2010.

1.4 Related Submittal(s)/Grant(s)

N/A

1.5 Test Methodology

All measurements contained in this report were conducted in accordance with ANSI C63.4-2003.

1.6 Measurement Uncertainty

All measurements involve certain levels of uncertainties, especially in the field of EMC. The factors contributing to uncertainties are spectrum analyzer, cable loss, antenna factor calibration, antenna directivity, antenna factor variation with height, antenna phase center variation, antenna factor frequency interpolation, measurement distance variation, site imperfections, mismatch (average), and system repeatability.

Based on CISPR16-4-2:2003, The Treatment of Uncertainty in EMC Measurements, the values ranging from ± 2.0 dB for Conducted Emissions tests and ± 4.0 dB for Radiated Emissions tests are the most accurate estimates pertaining to uncertainty of EMC measurements at BA CL Corp.

1.7 Test Facility

The test site used by BACL Corp. to collect radiated and conducted emissions measurement data is located at its facility in Sunnyvale, California, USA.

The test site at BACL Corp. has been fully described in reports submitted to the Federal Communication Commission (FCC) and Voluntary Control Council for Interference (VCCI). The details of these reports have been found to be in compliance with the requirements of Section 2.948 of the FCC Rules on February 11 and December 10, 1997, and Article 8 of the VCCI regulations on December 25, 1997. The test site also complies with the test methods and procedures set forth in CISPR 22:2008 §10.4 for measurements below 1 GHz and §10.6 for measurements above 1 GHz as well as ANSI C63.4-2003, ANSI C63.4-2009, TIA/EIA-603 & CISPR 24:2010.

The Federal Communications Commission and Voluntary Control Council for Interference have the reports on file and they are listed under FCC registration number: 90464 and VCCI Registration No.: R-3729, C-4176, G-469, and T-1206. The test site has been approved by the FCC and VCCI for public use and is listed in the FCC Public Access Link (PAL) database.

Additionally, BACL Corp. is a National Institute of Standards and Technology (NIST) accredited laboratory under the National Voluntary Laboratory Accredited Program (Lab Code 200167-0). The current scope of accreditations can be found at <http://ts.nist.gov/Standards/scopes/2001670.htm>

2 System Test Configuration

2.1 Justification

The system was configured for testing in accordance with ANSI C63.4-2003.
The EUT was tested in the testing mode to represent *worst*-case results during the final qualification test.

2.2 EUT Exercise Software

The software used, CommSet.EXE version 1.27 were provided by client and verified by Quinn Jiang to comply with the standard requirements being tested against.

2.3 Special Accessories

N/A.

2.4 Equipment Modifications

No modifications were made to the EUT.

2.5 Local Support Equipment

Manufacturer	Description	Model No.	Serial No.
DELL	Laptop	PP18L	-

2.6 Power Supply and Line Filters

Manufacturer	Description	Model	Serial Number
Delta Electronics Inc.	AC/DC Adapter	ADP-65JH AB	67JW1CG0080

2.7 Interface Ports and Cabling

Cable Description	Length (m)	From	To
RF Cable	< 1	EUT	Spectrum Analyzer

2.8 Internal Parts List and Details

Manufacturers	Descriptions	Models	Serial Numbers
Trimble Navigation	GPS Board and Antenna	65995-E	-
Trimble Navigation	900 MHz Module	80385-B	-
Trimble Navigation	BT and Wi-Fi Antenna	81078	-
Murata	BT and Wi-Fi radio	76577	-
Trimble Navigation	Digital Main Board	80090-D	-
Trimble Navigation	Keypad Board	81079-B	-
Trimble Navigation	Power Supply	80091-C	-
Trimble Navigation	Radio Interface	81077-C	-

3 Summary of Test Results

FCC & IC Rules	Description of Test	Result
FCC §15.247 (i), §2.1091 IC RSS-102	RF Exposure	Compliant
FCC §15.203 IC RSS-Gen §7.1.2	Antenna Requirements	Compliant
FCC §15.207 (a) IC RSS-Gen §7.2.4	AC Line Conducted Emissions	Compliant
FCC §15.247(d) IC RSS-210 §A8.5	Spurious Emissions at Antenna Port	Compliant
FCC §15.205, §15.209, §15.247(d) IC RSS-210 §2.2, §A8.5	Restricted Bands, Spurious Radiated Emissions	Compliant
FCC §15.247 (a)(1)(i) IC RSS-210 §A8.1(c)	20 dB Channel Bandwidth	Compliant
FCC §15.247 (a)(1) IC RSS-210 §A8.1(b)	Hopping Channel Separation	Compliant
FCC §15.247 (a)(1)(i) IC RSS-210 §A8.1(c)	Dwell Time	Compliant
FCC §15.247(a)(1)(i) IC RSS-210 §A8.1(c)	Number of Hopping Channels	Compliant
FCC §15.247(b)(2) IC RSS-210 §A8.4 (1)	Maximum Peak Output Power	Compliant
FCC §15.247(d) IC RSS-210 §A8.5	Band Edge	Compliant
FCC Part 15.109 IC RSS-Gen §6	Receiver Spurious Emission	Compliant

4 FCC §15.203 & IC RSS-Gen §7.1.2 – Antenna Requirements

4.1 Applicable Standard

For intentional device, according to FCC Part §15.203, an intentional radiator shall be designed to ensure that no antenna other than that furnished by the responsible party shall be used.

Per IC RSS-Gen §7.1.2, A transmitter can only be sold or operated with antennas with which it was certified. A transmitter maybe certified with multiple antenna types. An antenna type comprises antennas having similar in-band and out-of-band radiation patterns. Testing shall be performed using the highest-gain antenna of each combination of transmitter and antenna type for which certification is being sought, with the transmitter output power set at the maximum level. Any antenna of the same type and having equal or lesser gain as an antenna that had been successfully tested for certification with the transmitter, will also be considered certified with the transmitter, and may be used and marketed with the transmitter. The manufacturer shall include with the application for certification a list of acceptable antenna types to be used with the transmitter.

When a measurement at the antenna connector is used to determine RF output power, the effective gain of the device's antenna shall be stated, based on measurement or on data from the antenna manufacturer. Any antenna gain in excess of 6 dBi (6 dB above isotropic gain) shall be added to the measured RF output power before using the power limits specified in IC RSS-210 or RSS-310 for devices of RF output powers of 10 milliwatts or less. For devices of output powers greater than 10 milliwatts, except devices subject to IC RSS-210 Annex 8 or RSS-210 Annex 9, the total antenna gain shall be added to the measured RF output power before using the specified power limits. For devices subject to IC RSS-210 Annex 8 or Annex 9, the antenna gain shall not be added.

4.2 Result

The EUT has maximum gain of 0 dBi antenna with the reversed TNC connector , which in accordance to sections FCC Part 15.203 and IC RSS-Gen §7.1.2, is considered sufficient to comply with the provisions of these sections. Please refer to the EUT photos.

5 FCC §15.207 & IC RSS-Gen §7.2.4 – AC Line Conducted Emissions

5.1 Applicable Standards

As per FCC §15.207 & IC RSS-Gen §7.2.4 Conducted limits:

For an intentional radiator that is designed to be connected to the public utility (AC) power line, the radio frequency voltage that is conducted back onto the AC power line on any frequency or frequencies within the band 150 kHz to 30 MHz shall not exceed the limits in the following table, as measured using a 50 μ H/50 ohms line impedance stabilization network (LISN). Compliance with the provisions of this paragraph shall be based on the measurement of the radio frequency voltage between each power line and ground at the power terminal. The lower limit applies at the boundary between the frequencies ranges.

Frequency of Emission (MHz)	Conducted Limit (dBuV)	
	Quasi-peak	Average
0.15-0.5	66 to 56 ¹	56 to 46 ¹
0.5-5	56	46
5-30	60	50

Note ¹: Decreases with the logarithm of the frequency.

5.2 Test Setup

The measurement was performed at shield room, using the setup per ANSI C63.4-2003 measurement procedure. The specification used was FCC Part 15.207 and IC RSS-Gen limits.

External I/O cables were draped along the edge of the test table and bundle when necessary.

The AC/DC power adapter of the EUT was connected with LISN-1 which provided 120 V/60 Hz AC power.

5.3 Test Procedure

During the conducted emissions test, the power cord of the EUT host system was connected to the mains outlet of the LISN-2.

Maximizing procedure was performed on the six (6) highest emissions of the EUT.

All data was recorded in the peak detection mode, quasi-peak and average. Quasi-Peak readings are distinguished with a “QP.” Average readings are distinguished with an “Ave”.

5.4 Test Setup Block Diagram

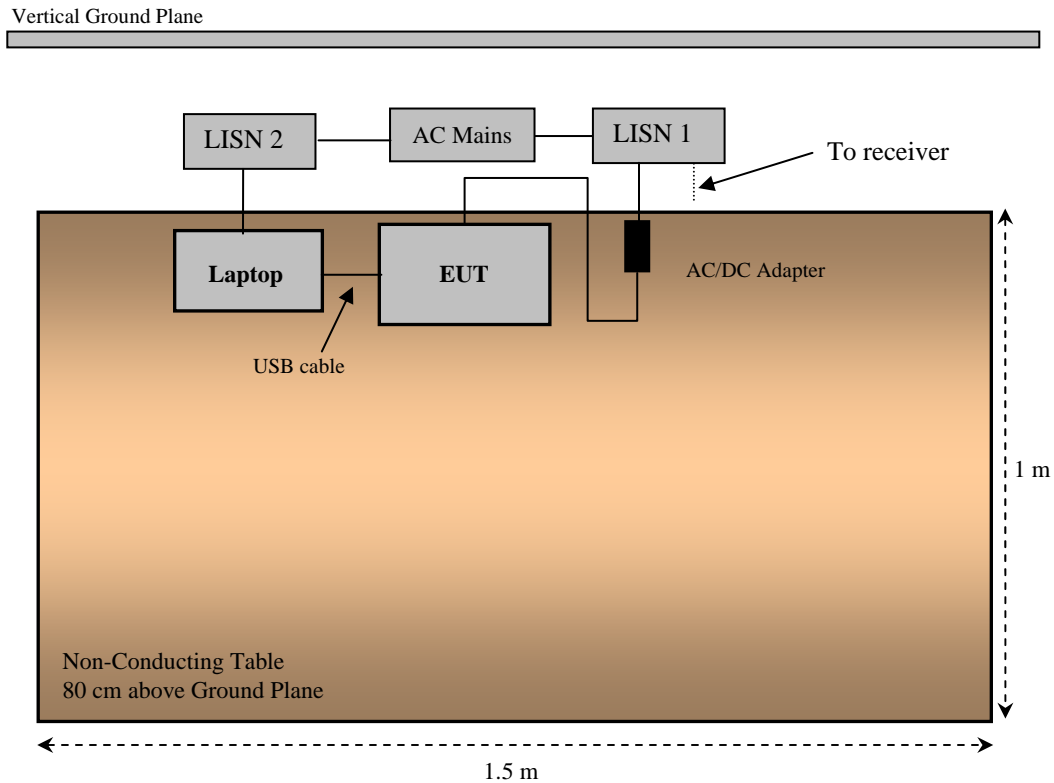

5.5 Corrected Amplitude & Margin Calculation

The Corrected Amplitude (CA) is calculated by adding the Cable Loss (CL) plus the High Pass Filter/Attenuator value (HA) and subtracting the Amplifier Gain (Ga) to the indicated Amplitude (Ai) reading. The basic equation is as follows:

$$CA = Ai + CL + HA - Ga$$

For example, a corrected amplitude (CA) of 36 dBuV = Indicated Amplitude reading (Ai) of 50.0 dBuV + Cable Loss (CL) 1.0 dB + High Pass Filter/Attenuator (IA) 5 dB - Amplifier Gain (Ga) 20 dB

The “**Margin**” column of the following data tables indicates the degree of compliance within the applicable limit. For example, a margin of 7 dB means the emission is 7 dB below the maximum limit. The equation for margin calculation is as follows:

$$\text{Margin (dB)} = \text{Corrected Amplitude (dBuV)} - \text{Limit (dBuV)}$$

5.6 Test Equipment List and Details

Manufacturer	Description	Model No.	Serial No.	Calibration Date
Rohde & Schwarz	EMI Test Receiver	ESCI 1166.5950K03	100044	2011-04-14
Solar Electronics	LISN	9252-R-24-BNC	511205	2011-06-25
TTE	Filter, High Pass	H9962-150K-50-21378	K7133	2011-06-10

Statement of Traceability: BACL Corp. attests that all calibrations have been performed per the NVLAP requirements, traceable to the NIST.

5.7 Test Environmental Conditions

Temperature:	22 °C
Relative Humidity:	33 %
ATM Pressure:	101.7kPa

The testing was performed by Quinn Jiang on 2012-02-27 in 5 meter chamber #3.

5.8 Summary of Test Results

According to the recorded data in following table, the EUT complied with the FCC/IC standard's conducted emissions limits, with the margin reading of:

Connection: AC/DC adapter connected to 120 V/60 Hz, AC			
Margin (dB)	Frequency (MHz)	Conductor Mode (Line/Neutral)	Range (MHz)
-1.41	0.150129	Line	0.15-30 MHz

5.9 Conducted Emissions Test Plots and Data

120V/60 Hz Line:

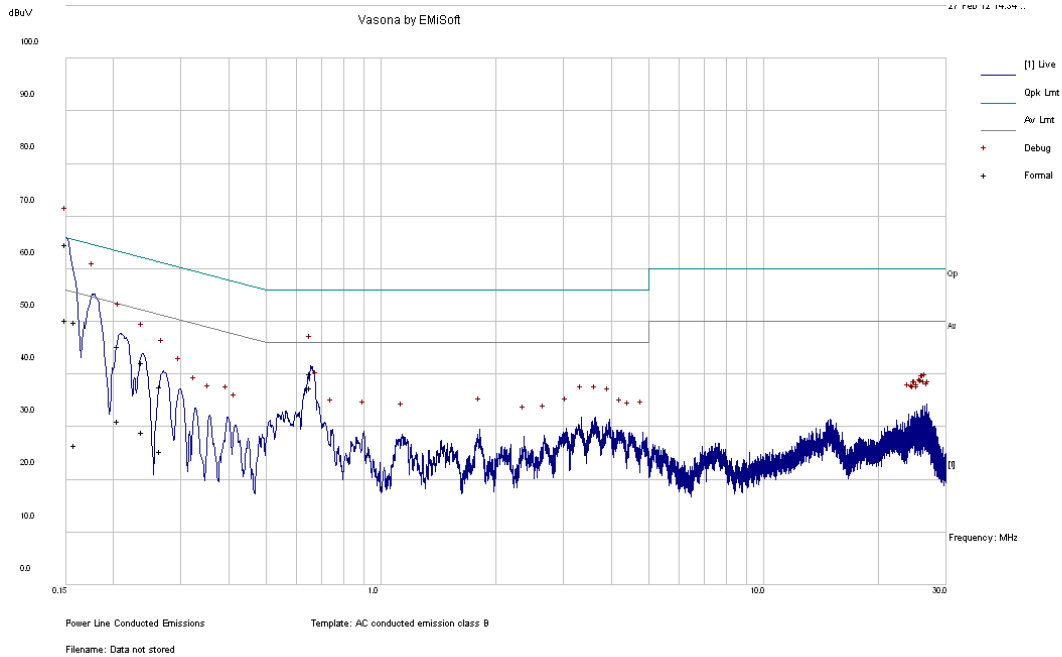

Quasi-Peak Measurement:

Frequency (MHz)	Corrected Amplitude (dBuV)	Conductor (Line/Neutral)	Limit (dBuV)	Margin (dB)
0.150129	64.59	Line	65.99	-1.41
0.159093	49.89	Line	65.51	-15.62
0.655005	40.15	Line	56	-15.85
0.20655	45.32	Line	63.34	-18.02
0.237954	42.2	Line	62.17	-19.96
0.26604	37.73	Line	61.24	-23.51

Average Measurement:

Frequency (MHz)	Corrected Amplitude (dBuV)	Conductor (Line/Neutral)	Limit (dBuV)	Margin (dB)
0.150129	50.27	Line	55.99	-5.72
0.655005	37.48	Line	46	-8.52
0.20655	31.06	Line	53.34	-22.28
0.237954	29.12	Line	52.17	-23.04
0.26604	25.37	Line	51.24	-25.87
0.159093	26.54	Line	55.51	-28.97

120V/60 Hz Neutral:

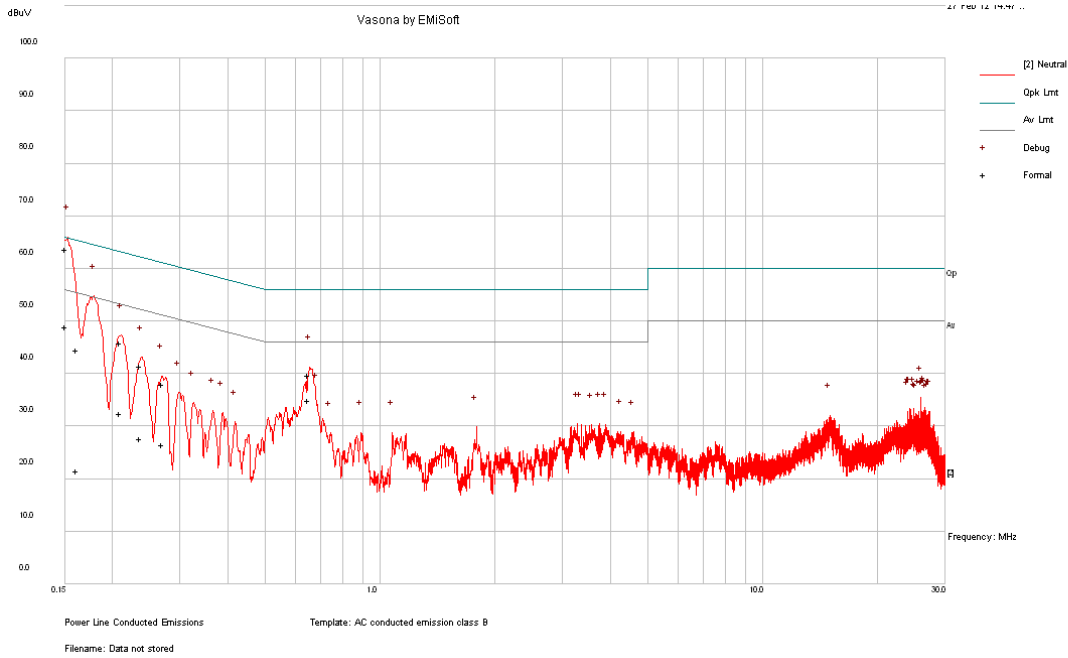

Quasi-Peak Measurement:

Frequency (MHz)	Corrected Amplitude (dBuV)	Conductor (Line/Neutral)	Limit (dBuV)	Margin (dB)
0.151125	63.68	Neutral	65.94	-2.26
0.651912	39.82	Neutral	56	-16.18
0.209151	45.95	Neutral	63.24	-17.29
0.236766	41.55	Neutral	62.21	-20.66
0.161193	44.46	Neutral	65.4	-20.94
0.26991	38	Neutral	61.12	-23.12

Average Measurement:

Frequency (MHz)	Corrected Amplitude (dBuV)	Conductor (Line/Neutral)	Limit (dBuV)	Margin (dB)
0.151125	48.92	Neutral	55.94	-7.02
0.651912	35.05	Neutral	46	-10.95
0.209151	32.45	Neutral	53.24	-20.79
0.236766	27.63	Neutral	52.21	-24.58
0.26991	26.48	Neutral	51.12	-24.64
0.161193	21.49	Neutral	55.4	-33.91

6 FCC §15.205, §15.209, §15.247(d) & IC RSS-210 §2.2, §A8.5 – Spurious Radiated Emissions

6.1 Applicable Standard

As per FCC §15.35(d): Unless otherwise specified, on any frequency or frequencies above 1000 MHz, the radiated emission limits are based on the use of measurement instrumentation employing an average detector function. Unless otherwise specified, measurements above 1000 MHz shall be performed using a minimum resolution bandwidth of 1 MHz.

As per FCC §15.209(a) and RSS-210: Except as provided elsewhere in this Subpart, the emissions from an intentional radiator shall not exceed the field strength levels specified in the following table

Frequency (MHz)	Field Strength (micro volts/meter)	Measurement Distance (meters)
0.009 - 0.490	2400/F(kHz)	300
0.490 - 1.705	24000/F(kHz)	30
1.705 - 30.0	30	30
30 - 88	100 ^{Note 1}	3
88 - 216	150 ^{Note 1}	3
216 - 960	200 ^{Note 1}	3
Above 960	500	3

Note 1: Except as provided in paragraph (g), fundamental emissions from intentional radiators operating under this Section shall not be located in the frequency bands 54-72 MHz, 76-88 MHz, 174-216 MHz or 470-806 MHz. However, operation within these frequency bands is permitted under other sections of this Part, e.g., Sections 15.231 and 15.241.

As Per FCC §15.205(a) except as show in paragraph (d) of this section, only spurious emissions are permitted in any of the frequency bands listed below:

MHz	MHz	MHz	GHz
0.090 - 0.110	16.42 - 16.423	960 - 1240	4.5 - 5.15
0.495 - 0.505	16.69475 - 16.69525	1300 - 1427	5.35 - 5.46
2.1735 - 2.1905	25.5 - 25.67	1435 - 1626.5	7.25 - 7.75
4.125 - 4.128	37.5 - 38.25	1645.5 - 1646.5	8.025 - 8.5
4.17725 - 4.17775	73 - 74.6	1660 - 1710	9.0 - 9.2
4.20725 - 4.20775	74.8 - 75.2	1718.8 - 1722.2	9.3 - 9.5
6.215 - 6.218	108 - 121.94	2200 - 2300	10.6 - 12.7
6.26775 - 6.26825	123 - 138	2310 - 2390	13.25 - 13.4
6.31175 - 6.31225	149.9 - 150.05	2483.5 - 2500	14.47 - 14.5
8.291 - 8.294	156.52475 - 156.52525	2690 - 2900	15.35 - 16.2
8.362 - 8.366	156.7 - 156.9	3260 - 3267	17.7 - 21.4
8.37625 - 8.38675	162.0125 - 167.17	3.332 - 3.339	22.01 - 23.12
8.41425 - 8.41475	167.72 - 173.2	3.3458 - 3.358	23.6 - 24.0
12.29 - 12.293	240 - 285	3.600 - 4.400	31.2 - 31.8
12.51975 - 12.52025	322 - 335.4		36.43 - 36.5
12.57675 - 12.57725	399.9 - 410		Above 38.6
13.36 - 13.41	608 - 614		

As per FCC §15.247 (d) In any 100 kHz bandwidth outside the frequency band in which the spread spectrum or digitally modulated intentional radiator is operating, the radio frequency power that is produced by the intentional radiator shall be at least 20 dB below that in the 100 kHz bandwidth within the band that contains the highest level of the desired power, based on either an RF conducted or a radiated measurement, provided the transmitter demonstrates compliance with the peak conducted power limits. If the transmitter complies with the conducted power limits based on the use of RMS averaging over a time interval, as permitted under paragraph (b)(3) of this section, the attenuation required under this paragraph shall be 30 dB instead of 20 dB. Attenuation below the general limits specified in §15.209(a) is not required. In addition, radiated emissions which fall in the restricted bands, as defined in §15.205(a), must also comply with the radiated emission limits specified in §15.209(a) (see §15.205(c)).

As per IC RSS-210 §A8.5, In any 100 kHz bandwidth outside the frequency band in which the spread spectrum or digitally modulated device is operating, the RF power that is produced shall be at least 20 dB below that in the 100 kHz bandwidth within the band that contains the highest level of the desired power, based on either an RF conducted or a radiated measurement, provided that the transmitter demonstrates compliance with the peak conducted power limits. If the transmitter complies with the conducted power limits based on the use of root-mean-square averaging over a time interval, as permitted under Section A8.4 (4), the attenuation required shall be 30 dB instead of 20 dB. Attenuation below the general field strength limits specified in RSS-Gen is not required.

6.2 Test Setup

The radiated emissions tests were performed in the 5-meter Chamber, using the setup in accordance with ANSI C63.4-2003. The specification used was the FCC 15C and IC RSS-210 limits.

The spacing between the peripherals was 10 centimeters.

External I/O cables were draped along the edge of the test table and bundle when necessary.

6.3 Test Procedure

For the radiated emissions test, the EUT host, and all support equipment power cords was connected to the AC floor outlet.

Maximizing procedure was performed on the highest emissions to ensure that the EUT complied with all installation combinations.

The EUT is set 3 meter away from the testing antenna, which is varied from 1-4 meter, and the EUT is placed on a turntable, which is 0.8 meter above ground plane, the table shall be rotated for 360 degrees to

find out the highest emission. The receiving antenna should be changed the polarization both of horizontal and vertical.

The spectrum analyzer or receiver is set as:

Below 1000 MHz:

$RBW = 100 \text{ kHz} / VBW = 300 \text{ kHz} / \text{Sweep} = \text{Auto}$

Above 1000 MHz:

- (1) Peak: $RBW = 1\text{MHz} / VBW = 1\text{MHz} / \text{Sweep} = \text{Auto}$
- (2) Average: $RBW = 1\text{MHz} / VBW = 10\text{Hz} / \text{Sweep} = \text{Auto}$

6.4 Corrected Amplitude & Margin Calculation

The Corrected Amplitude is calculated by adding the Cable Loss, and Attenuator Factor adding to the Indicated Reading. The basic equation is as follows:

$$\text{Corrected Amplitude} = \text{Indicated Reading} + \text{Cable Loss} + \text{Attenuator Factor}$$

For example, a Corrected Amplitude of 34.08 dBuV/m = Indicated Reading (23.85 dBuV) + Cable Factor (0.22 dB) + Attenuator Factor (10dB)

The “**Margin**” column of the following data tables indicates the degree of compliance within the applicable limit. For example, a margin of -7 dB means the emission is 7 dB below the maximum limit. The equation for margin calculation is as follows:

$$\text{Margin} = \text{Corrected Amplitude} - \text{Limit}$$

6.5 Test Equipment List and Details

Manufacturer	Description	Model No.	Serial No.	Calibration Date
A.H Systems	Antenna, Horn	SAS-200/571	261	2012-01-18
Hewlett Packard	Pre-amplifier	8447D	2944A06639	2011-06-09
Sunol Science Corp	Combination Antenna	JB3	A020106-2	2011-08-10
Rohde & Schwarz	EMI Test Receiver	ESCI 1166.5950K03	100337	2011-03-21
Sunol Science Corp	System Controller	SC99V	122303-1	N/R
Agilent	Spectrum Analyzer	E4440A	MY44303352	2011-05-10
HP	Pre-amplifier	8449B	3147A00400	2012-02-03

Statement of Traceability: BACL attests that all calibrations have been performed per the NVLAP requirements, traceable to NIST.

6.6 Test Environmental Conditions

Temperature:	22 °C
Relative Humidity:	33 %
ATM Pressure:	101.7kPa

The testing was performed by Quinn Jiang on 2012-02-27 in 5 meter chamber #3.

6.7 Summary of Test Results

According to the data hereinafter, the EUT complied with the FCC Part 15C and IC RSS-210 standard's radiated emissions limits, and had the worst margin of:

30-1000 MHz:

Mode: Transmitting			
Margin (dB)	Frequency (MHz)	Polarization (Horizontal/Vertical)	Channel, Range
-10.24	935.3715	Vertical	High, 30 MHz– 1 GHz

Above 1 GHz:

Mode: Transmitting			
Margin (dB)	Frequency (MHz)	Polarization (Horizontal/Vertical)	Channel, Range
-	-	-	Low, 1GHz – 25GHz
-	-	-	Mid, 1GHz – 25GHz
-	-	-	High, 1GHz – 25GHz

Note: All emissions are 20 dB below the limit or are on the noise floor level
Please refer to the following table and plots for specific test result details

6.8 Radiated Emissions Test Result Data

1) 30 MHz – 1 GHz, Radiated Spurious Emissions Measured at 3 meters

Low Channel

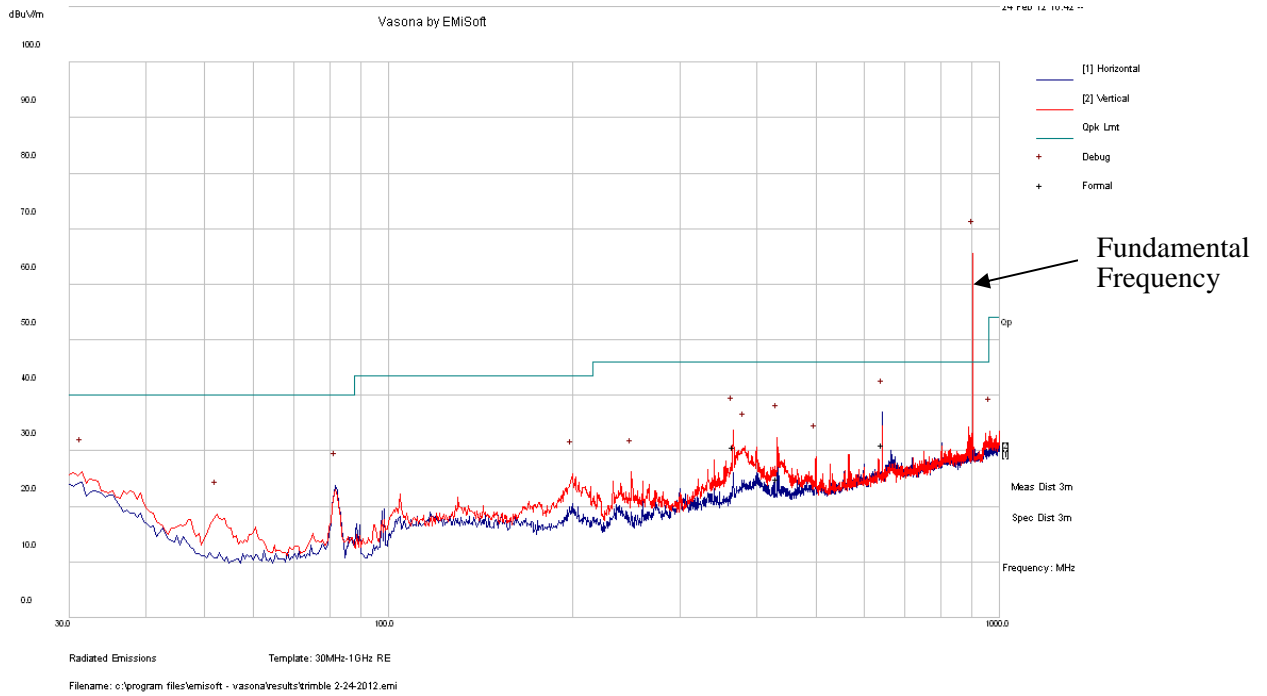

Quasi-Peak Measurement:

Frequency (MHz)	Corrected Amplitude (dB)	Antenna Height (cm)	Antenna Polarity (H/V)	Turntable Azimuth (degrees)	Limit (dB μ V/m)	Margin (dB)
642.015	31.12	100	H	16	46	-14.88
366.303	30.8	100	V	135	46	-15.20
432.1158	24.98	153	V	336	46	-21.02

Middle Channel

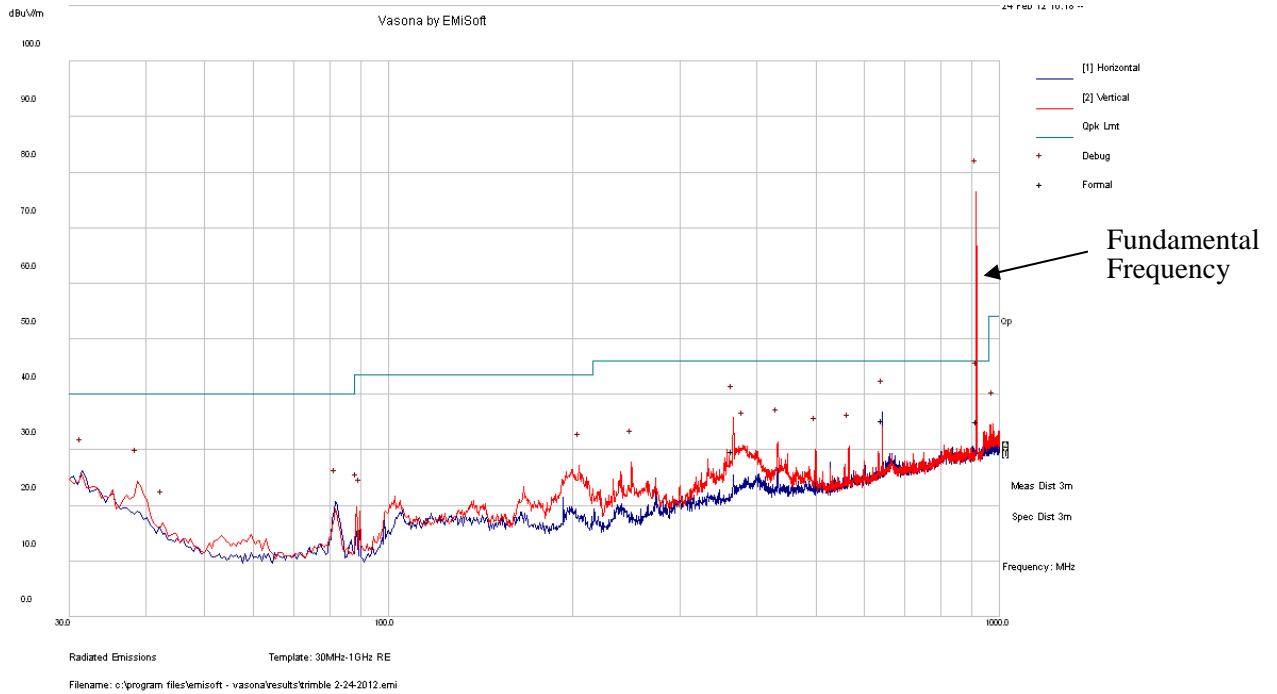

Quasi-Peak Measurement:

Frequency (MHz)	Corrected Amplitude (dB)	Antenna Height (cm)	Antenna Polarity (H/V)	Turntable Azimuth (degrees)	Limit (dB μ V/m)	Margin (dB)
641.9963	35.29	100	H	146	46	-10.71
365.681	29.78	100	V	154	46	-16.22

High Channel

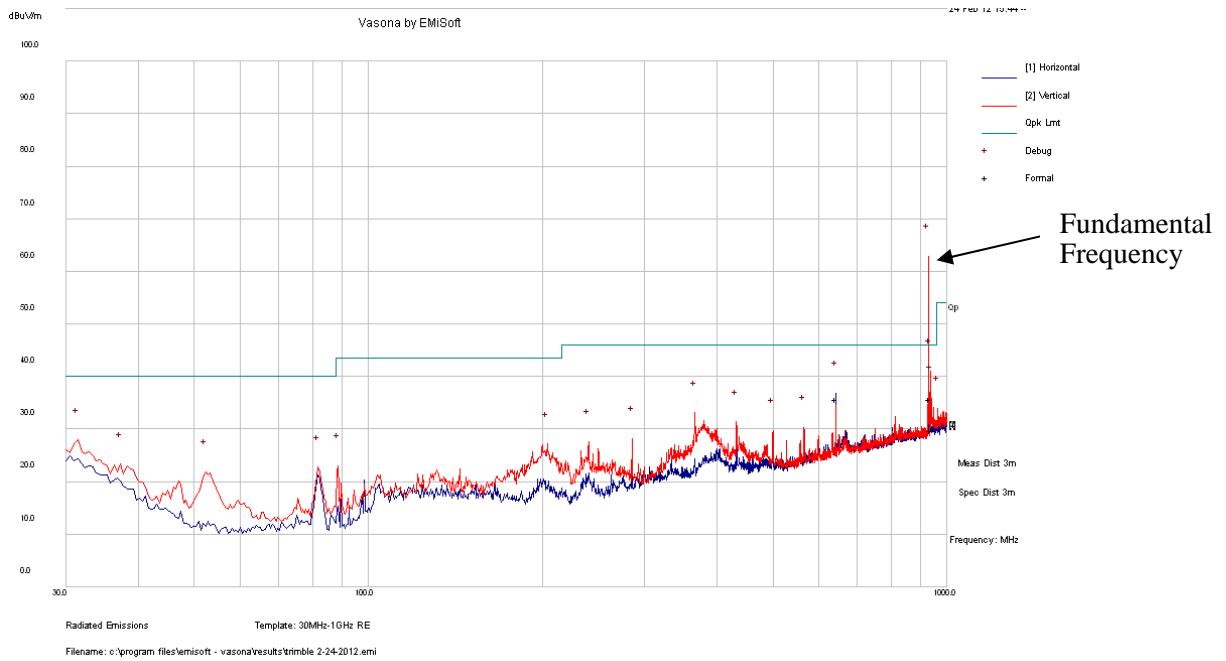

Quasi-Peak Measurement:

Frequency (MHz)	Corrected Amplitude (dB)	Antenna Height (cm)	Antenna Polarity (H/V)	Turntable Azimuth (degrees)	Limit (dBµV/m)	Margin (dB)
935.3715	35.76	100	V	201	46	-10.24
642.0103	35.69	100	H	169	46	-10.31
937.6818	29.81	101	V	303	46	-16.19

2) 1–25 GHz, Radiated Spurious Emissions Measured at 3 meters

Frequency (MHz)	S.A. Reading (dBµV)	Turntable Azimuth (degrees)	Test Antenna			Cable Loss (dB)	Pre-Amp. (dB)	Cord. Reading (dBµV/m)	FCC & IC		Comments
			Height (cm)	Polarity (H/V)	Factor (dB/m)				Limit (dBµV/m)	Margin (dB)	
Low Channel (902.6 MHz)											
-	-	-	-	-	-	-	-	-	-	-	- ¹
Middle Channel (915.4 MHz)											
-	-	-	-	-	-	-	-	-	-	-	- ¹
High Channel (927.6 MHz)											
-	-	-	-	-	-	-	-	-	-	-	- ¹

Note ¹: All spurious emissions are 20 dB below the limit or are on the noise floor level

7 FCC §15.247(a) & IC RSS-210 §A8.1 – Hopping Channel Bandwidth

7.1 Applicable Standard

According to FCC§15.247(a) (l)(i) & IC RSS-210 §A8.1 (c), the maximum 20 dB bandwidth of the hopping channel is 500 kHz.

7.2 Measurement Procedure

1. Check the calibration of the measuring instrument using either an internal calibrator or a known signal from an external generator.
2. Position the EUT without connection to measurement instrument. Turn on the EUT and set it to any one convenient frequency within its operating range. Set a reference level on the measuring instrument equal to the highest peak value.
3. Measure the frequency difference of two frequencies that were attenuated 20 dB from the reference level. Record the frequency difference as the emissions bandwidth.
4. Repeat above procedures until all frequencies measured were complete.

7.3 Test Equipment List and Details

Manufacturer	Description	Model	Serial Number	Calibration Date
Agilent	PSA Spectrum Analyzer	E4440A	MY44303352	2011-05-10

Statement of Traceability: BACL Corp. attests that all calibrations have been performed per the NVLAP requirements, traceable to the NIST.

7.4 Test Environmental Conditions

Temperature:	21 °C
Relative Humidity:	32 %
ATM Pressure:	101.7kPa

The testing was performed by Quinn Jiang on 2012-02-27 at RF test site.

7.5 Test Results

Channel	Frequency (MHz)	20 dB Emission Bandwidth (kHz)	Lmit (kHz)
Low	902.6	405.029	500
Mid	915.4	418.171	500
High	927.6	418.585	500

Please refer to the following plots.

Low Channel

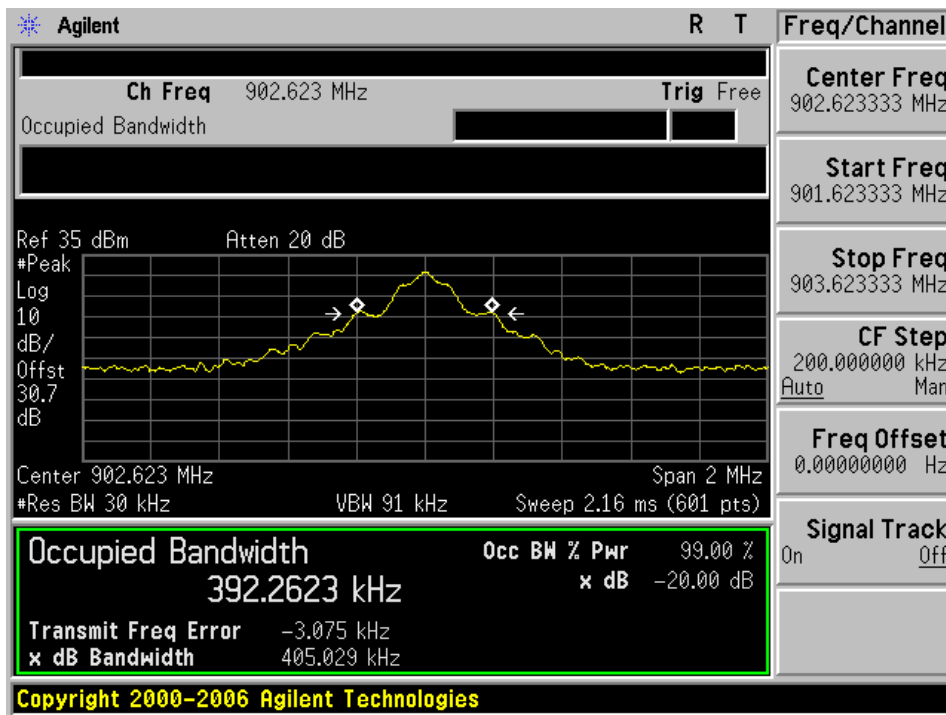

Middle Channel

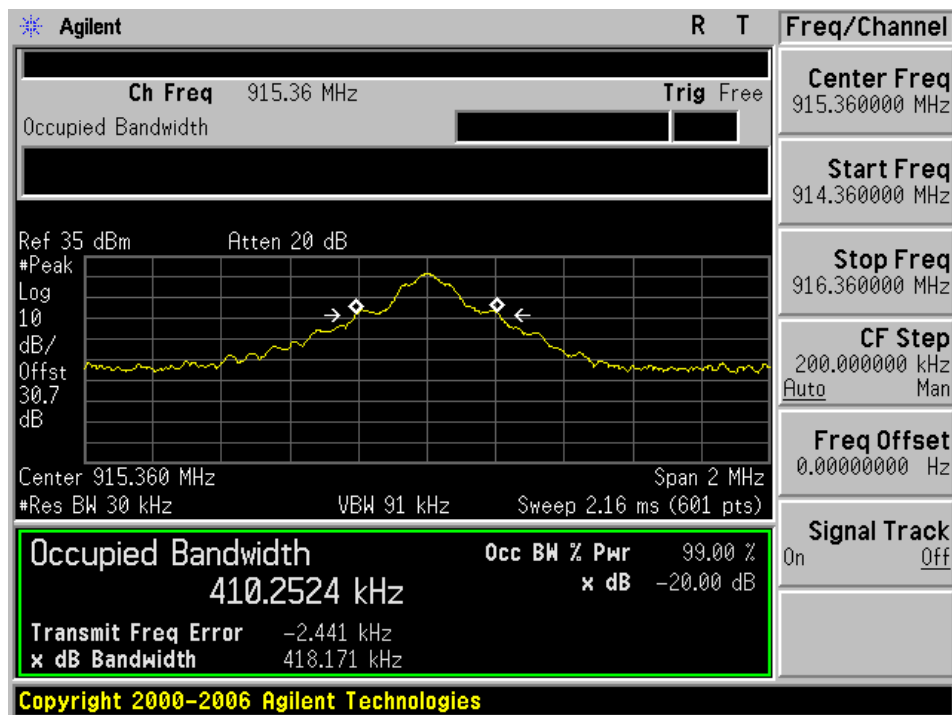

High Channel

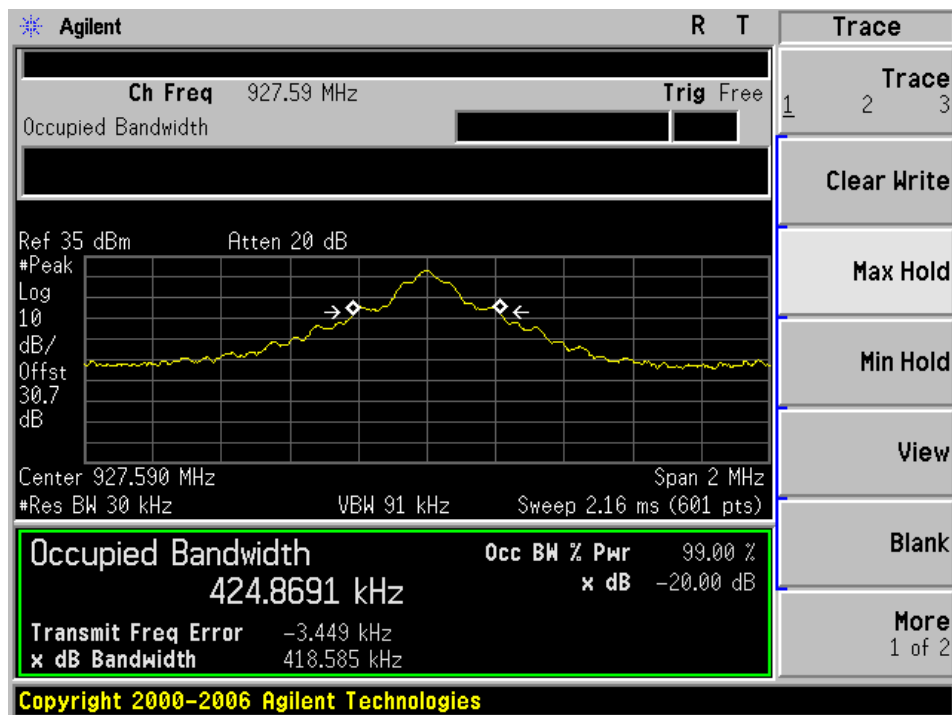

8 FCC §15.247(a) & IC RSS-210 §A8.1 – Hopping Channel Separation

8.1 Applicable Standard

According to FCC §15.247(a)(1) and IC RSS-210 §A8.1(b): Frequency hopping systems shall have hopping channel carrier frequencies separated by a minimum of 25 kHz or the 20 dB bandwidth of the hopping channel, whichever is greater.

8.2 Measurement Procedure

1. Check the calibration of the measuring instrument (SA) using either an internal calibrator or a known signal from an external generator.
2. Position the EUT on a bench without connection to measurement instrument Turn on the EUT and set it to any one convenient frequency within its operating range.
3. By using the Max-Hold function record the separation of two adjacent channels.
4. Measure the frequency difference of these two adjacent channels by SA MARK function, and then plot the result on SA screen.
5. Repeat above procedures until all frequencies measured were complete.

8.3 Test Equipment List and Details

Manufacturer	Description	Model	Serial Number	Calibration Date
Agilent	PSA Spectrum Analyzer	E4440A	MY44303352	2011-05-10

Statement of Traceability: BACL Corp. attests that all calibrations have been performed per the NVLAP requirements, traceable to the NIST.

8.4 Test Environmental Conditions

Temperature:	21 °C
Relative Humidity:	32 %
ATM Pressure:	101.7kPa

The testing was performed by Quinn Jiang on 2012-02-27 at RF test site.

8.5 Test Results

Channel	Frequency (MHz)	Channel Separation (kHz)	Limit > 20 dB OBW (kHz)
Low	902.6	514	405.029
Mid	915.4	504	418.171
High	927.6	508	418.585

Please refer to the following plots.

Low Channel

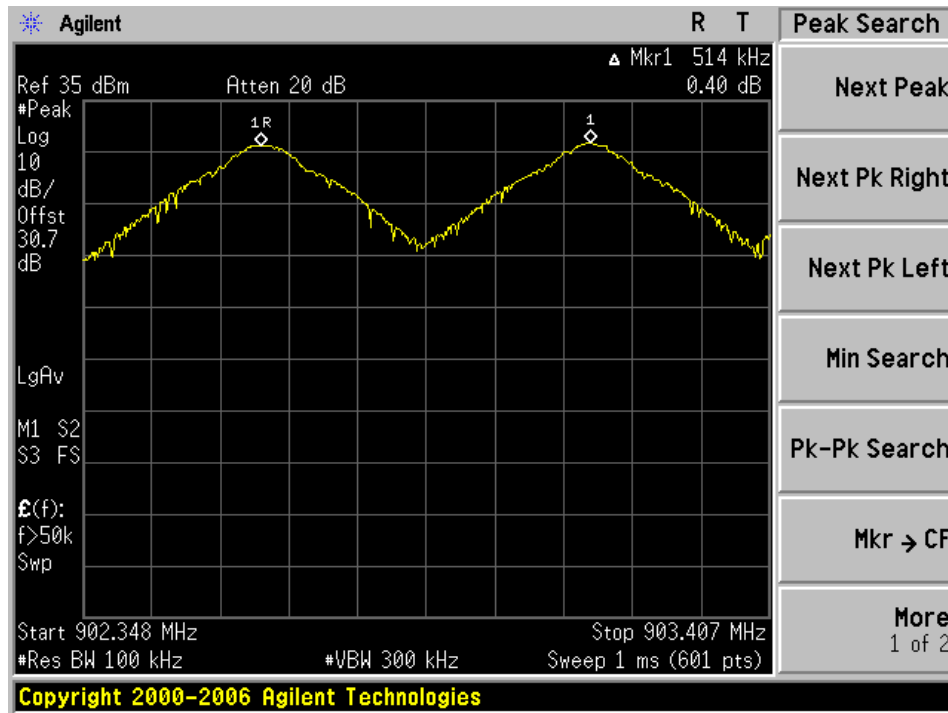

Middle Channel

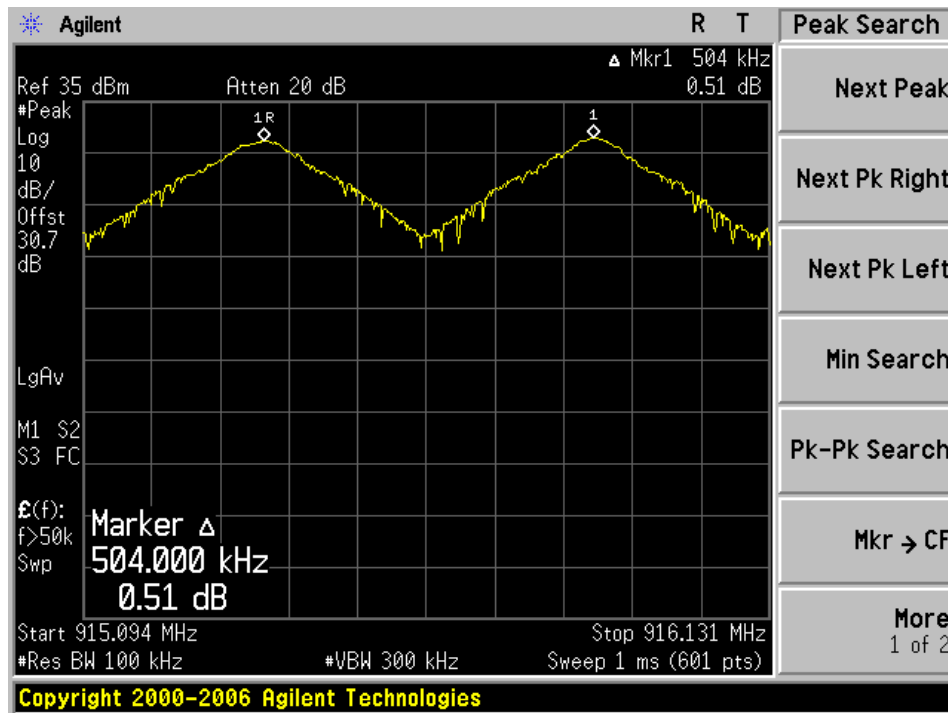

High Channel

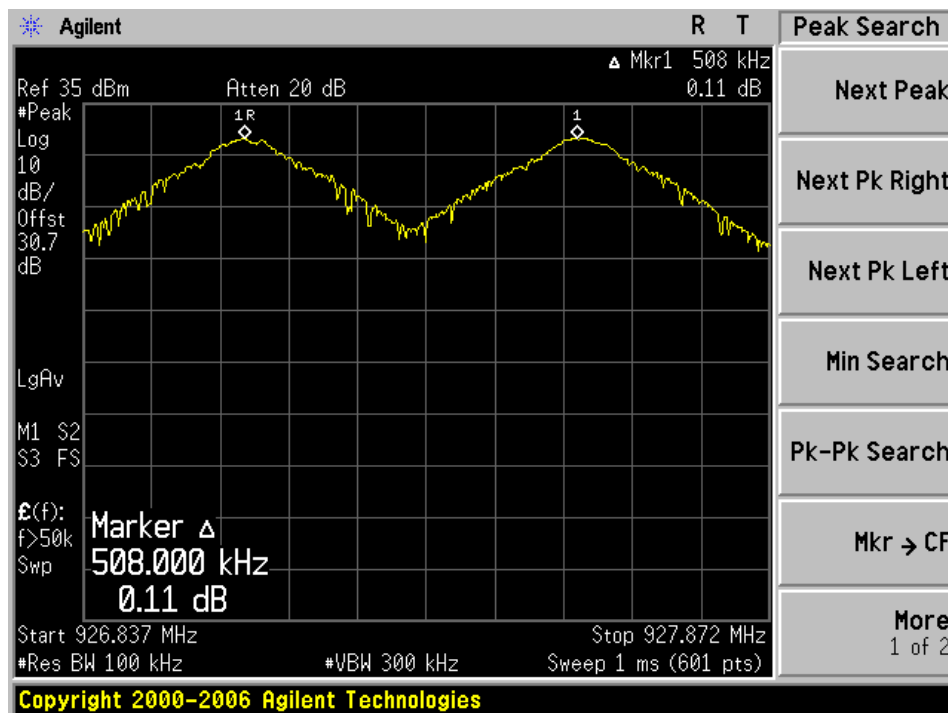

9 FCC §15.247(a) & IC RSS-210 §A8.1 - Number of Hopping Channels

9.1 Applicable Standard

According to FCC §15.247(a)(1)(i) and IC RSS-210 §A8.1(c), for frequency hopping systems operating in the 902–928 MHz band: if the 20 dB bandwidth of the hopping channel is 250 kHz or greater, the system shall use at least 25 hopping frequencies

9.2 Measurement Procedure

1. Check the calibration of the measuring instrument (SA) using either an internal calibrator or a known signal from an external generator.
2. Position the EUT on the bench without connection to measurement instrument. Turn on the EUT and set it to any one measured frequency within its operating range, and make sure the instrument is operated in its linear range.
3. Set the SA on Max-Hold Mode, and then keep the EUT in hopping mode. Record all the signals from each channel until each one has been recorded.
4. Set the SA on View mode and then plot the result on SA screen.
5. Repeat above procedures until all frequencies measured were complete.

9.3 Test Equipment List and Details

Manufacturer	Description	Model	Serial Number	Calibration Date
Agilent	PSA Spectrum Analyzer	E4440A	MY44303352	2011-05-10

Statement of Traceability: BACL Corp. attests that all calibrations have been performed per the NVLAP requirements, traceable to the NIST.

9.4 Test Environmental Conditions

Temperature:	21 °C
Relative Humidity:	32 %
ATM Pressure:	101.7kPa

The testing was performed by Quinn Jiang on 2012-02-27 at RF test site.

9.5 Test Results

Please refer to the following plot.

Hopping Channel Number: Total 50 Channels

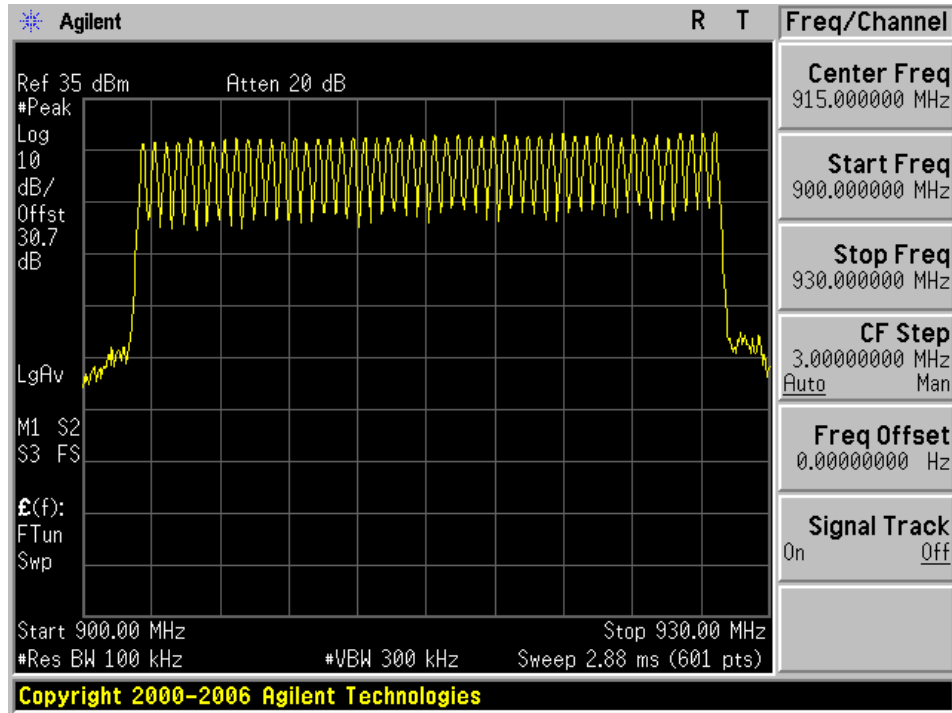

10 FCC §15.247(a) & IC RSS-210 §A8.1 - Dwell Time

10.1 Applicable Standard

According to FCC §15.247(a)(1)(i) and IC RSS-210 §A8.1 (c), for frequency hopping systems operating in the 902–928 MHz band: if the 20 dB bandwidth of the hopping channel is 250 kHz or greater, the average time of occupancy on any frequency shall not be greater than 0.4 seconds within a 10 second period

10.2 Measurement Procedure

1. Check the calibration of the measuring instrument using either an internal calibrator or a known signal from an external generator.
2. Position the EUT was set without connection to measurement instrument. Turn on the EUT and connect its antenna terminal to measurement instrument via a low loss cable. Then set it to any one measured frequency within its operating range, and make sure the instrument is operated in its linear range.
3. Adjust the center frequency of SA on any frequency be measured and set SA to zero span mode. And then, set RBW and VBW of spectrum analyzer to proper value.
4. Measure the time duration of one transmission on the measured frequency. And then plot the result with time difference of this time duration.
5. Repeat above procedures until all frequencies measured were complete.

10.3 Test Equipment List and Details

Manufacturer	Description	Model	Serial Number	Calibration Date
Agilent	PSA Spectrum Analyzer	E4440A	MY44303352	2011-05-10

Statement of Traceability: BACL Corp. attests that all calibrations have been performed per the NVLAP requirements, traceable to the NIST.

10.4 Test Environmental Conditions

Temperature:	21 °C
Relative Humidity:	32 %
ATM Pressure:	101.7kPa

The testing was performed by Quinn Jiang on 2012-02-27 at RF test site.

10.5 Test Results

Channel	Pulse Width (Sec)	Limit (Sec.)	Results
Low	0.04445	0.4	Pass
Mid	0.04444	0.4	Pass
High	0.04444	0.4	Pass

Please refer to following plots:

Low Channel

Pulse time

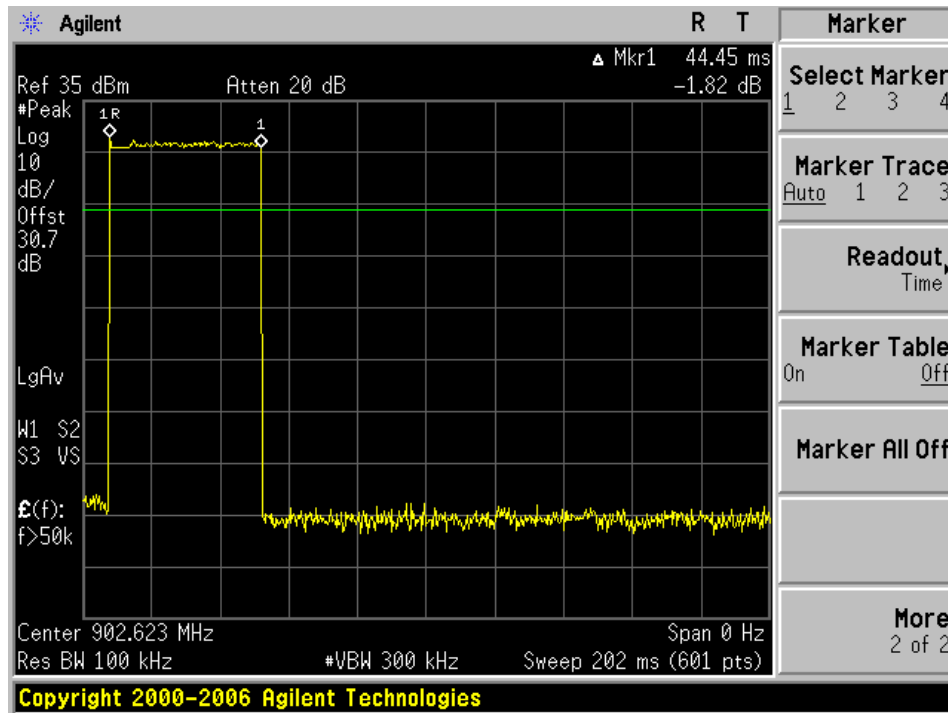

Number of pulse in 10s

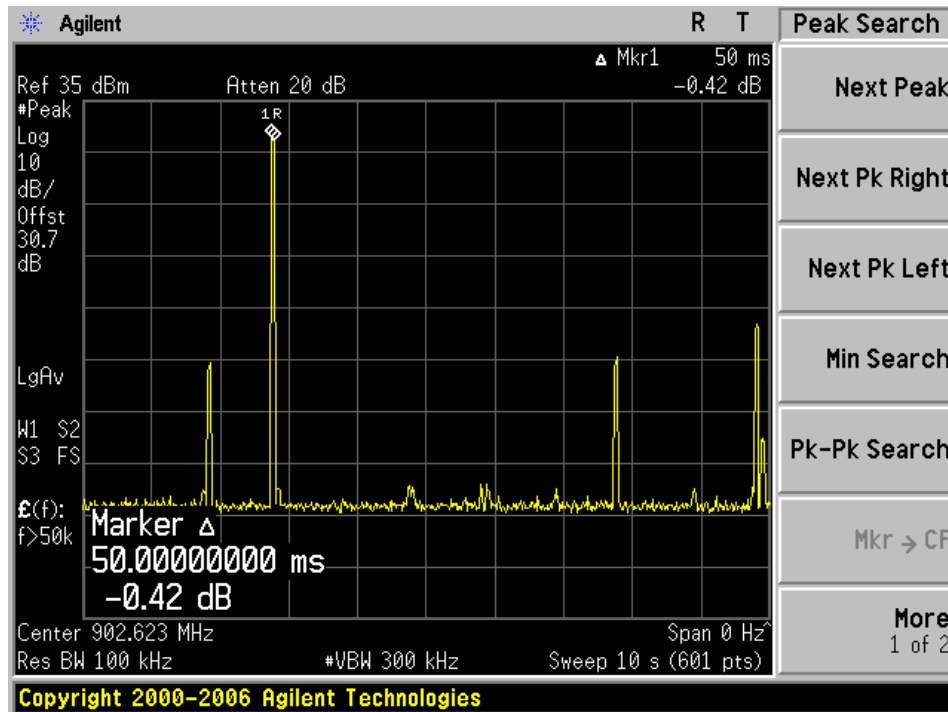

Middle Channel

Pulse time

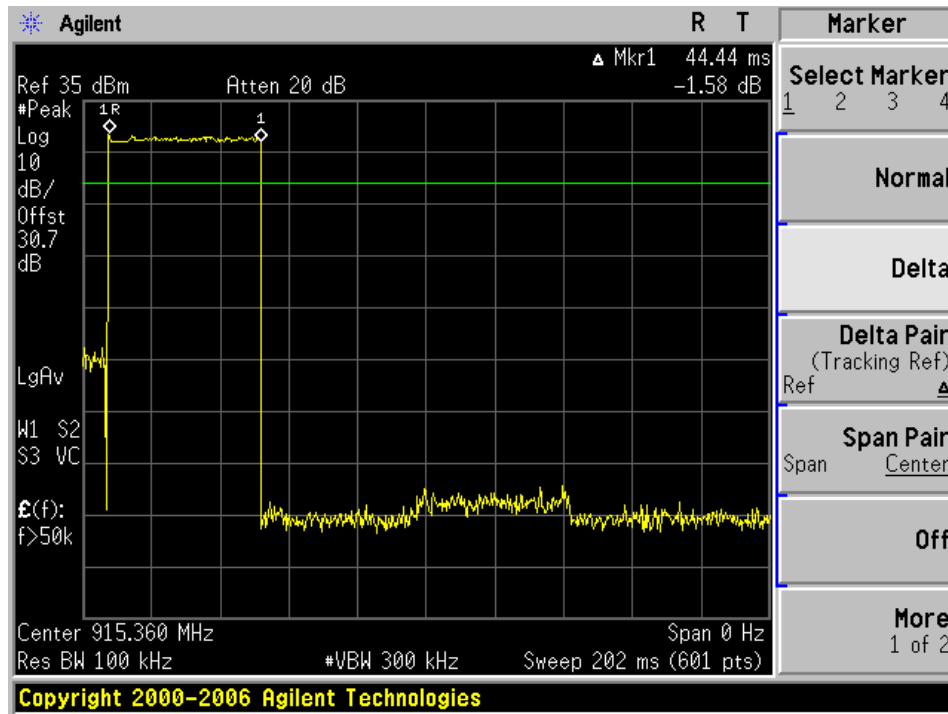

Number of pulse in 10s

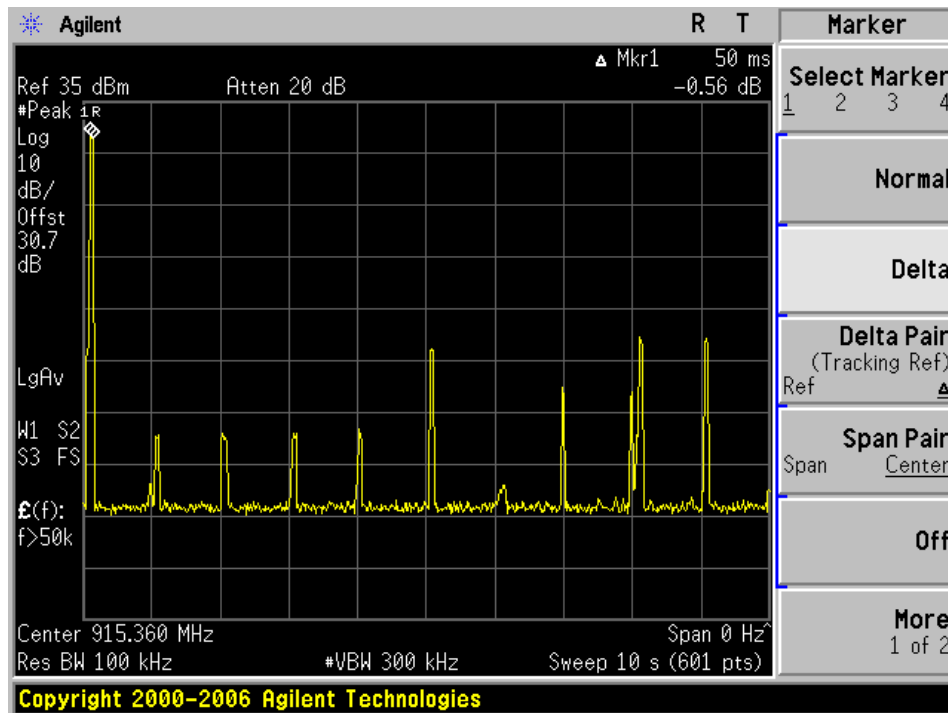

High Channel Pulse time

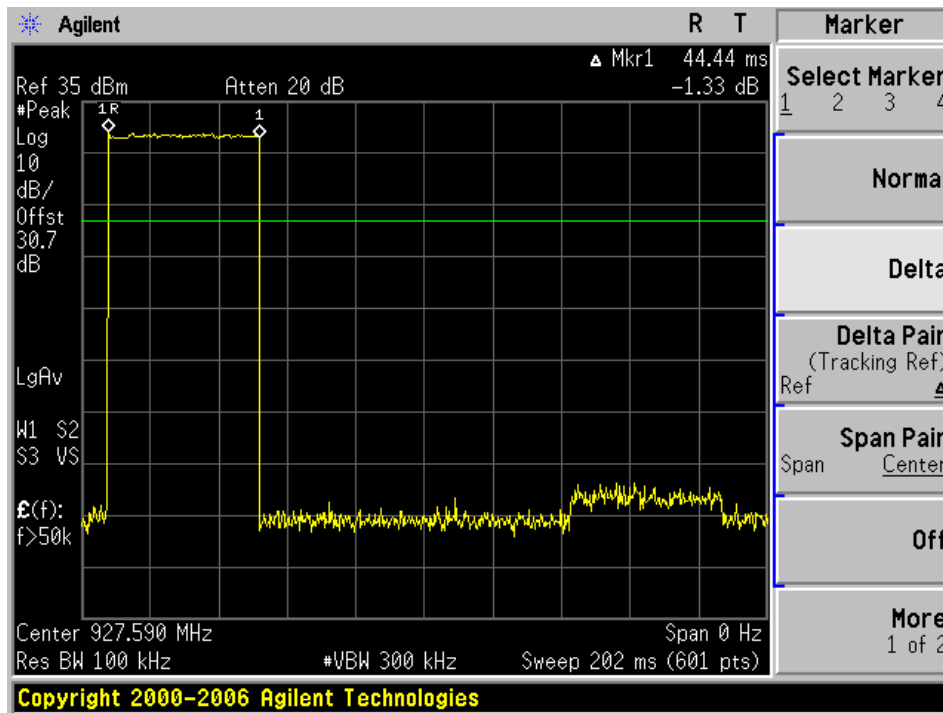

Number of pulse in 10s period

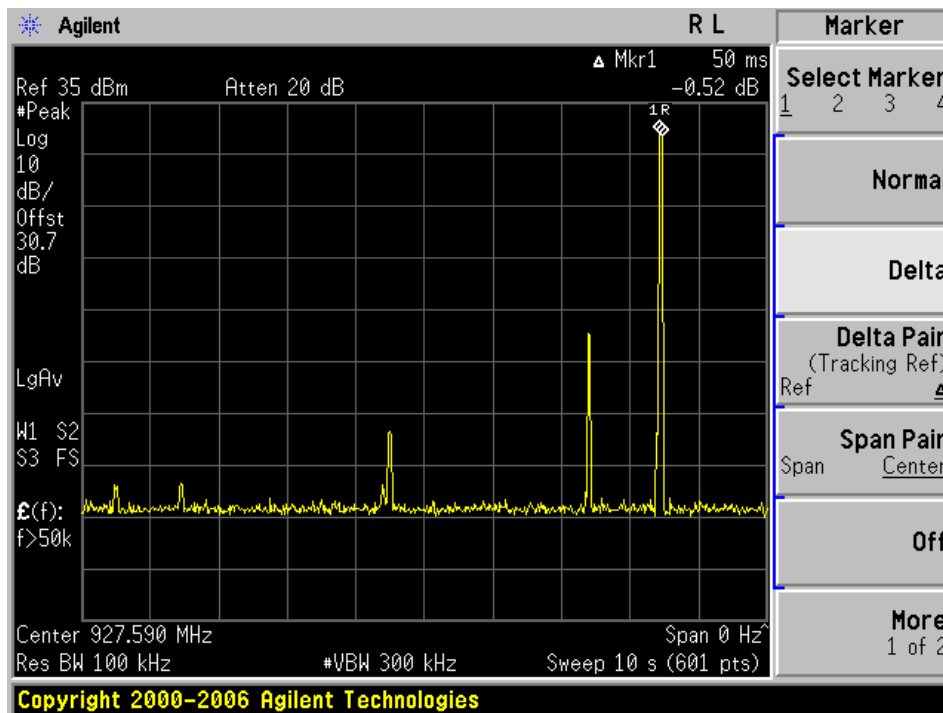

11 FCC §15.247(b) & IC RSS-210 §A8.4 – Maximum Peak Output Power

11.1 Applicable Standard

According to FCC §15.247(b) (2), for frequency hopping systems operating in the 902–928 MHz band: 1 watt for systems employing at least 50 hopping channels

According to IC RSS-210 §8.4(1), For frequency hopping systems operating in the band 902-928 MHz, the maximum peak conducted output power shall not exceed 1.0 W, and the e.i.r.p. shall not exceed 4 W if the hopset uses 50 or more hopping channels;

11.2 Measurement Procedure

1. Place the EUT on the turntable and set it in transmitting mode.
2. Remove the antenna from the EUT and then connect a low loss RF cable from the antenna port to the spectrum analyzer.

11.3 Test Equipment List and Details

Manufacturer	Description	Model	Serial Number	Calibration Date
Agilent	PSA Spectrum Analyzer	E4440A	MY44303352	2011-05-10

Statement of Traceability: BACL Corp. attests that all calibrations have been performed per the NVLAP requirements, traceable to the NIST.

11.4 Test Environmental Conditions

Temperature:	21 °C
Relative Humidity:	32 %
ATM Pressure:	101.7kPa

The testing was performed by Quinn Jiang on 2012-02-27 at RF test site.

11.5 Test Results

Channel	Frequency (MHz)	Max Peak Output Power		Limit (Watt)	Result
		(dBm)	(mw)		
Low	902.6	26.93	493.17	1.0	Pass
Mid	915.4	27.95	623.73	1.0	Pass
High	927.6	28.49	706.32	1.0	Pass

12 FCC §15.247(d) & IC RSS-210 §A 8.5 - Band Edges Emissions

12.1 Applicable Standard

According to FCC §15.247(d), in any 100 kHz bandwidth outside the frequency band in which the spread spectrum intentional radiator is operating, the radio frequency power that is produced by the intentional radiator shall be at least 20 dB below that in the 100 kHz bandwidth within the band that contains the highest level of the desired power, based on either an RF conducted or a radiated measurement. Attenuation below the general limits specified in §15.209(a) is not required.

According to IC RSS-210 §A 8.5. In any 100 kHz bandwidth outside the frequency band in which the spread spectrum or digitally modulated device is operating, the radio frequency power that is produced shall be at least 20 dB below that in the 100 kHz bandwidth within the band that contains the highest level of the desired power, based on either an RF conducted or a radiated measurement, provided the transmitter demonstrates compliance with the peak conducted power limits. If the transmitter complies with the conducted power limits based on the use of RMS averaging over a time interval, as permitted under section A8.4(4), the attenuation required shall be 30 dB instead of 20 dB. Attenuation below the general limits specified in Tables 2 and 3 is not required.

12.2 Measurement Procedure

1. Check the calibration of the measuring instrument using either an internal calibrator or a known signal from an external generator.
2. Position the EUT without connection to measurement instrument. Turn on the EUT set it to any one measured frequency within its operating range, and make sure the instrument is operated in its linear range.
3. Set both RBW and VBW of spectrum analyzer to 100 kHz with a convenient frequency span including 100kHz bandwidth from band edge.
4. Measure the highest amplitude appearing on spectral display and set it as a reference level. Plot the graph with marking the highest point and edge frequency.
5. Repeat above procedures until all measured frequencies were complete.

12.3 Test Equipment List and Details

Manufacturer	Description	Model	Serial Number	Calibration Date
Agilent	PSA Spectrum Analyzer	E4440A	MY44303352	2011-05-10

Statement of Traceability: BACL Corp. attests that all calibrations have been performed per the NVLAP requirements, traceable to the NIST.

12.4 Test Environmental Conditions

Temperature:	21 °C
Relative Humidity:	32 %
ATM Pressure:	101.7kPa

The testing was performed by Quinn Jiang on 2012-02-27 at RF test site.

12.5 Test Results

Please refer to the following plots.

Band Edge: Lowest Channel

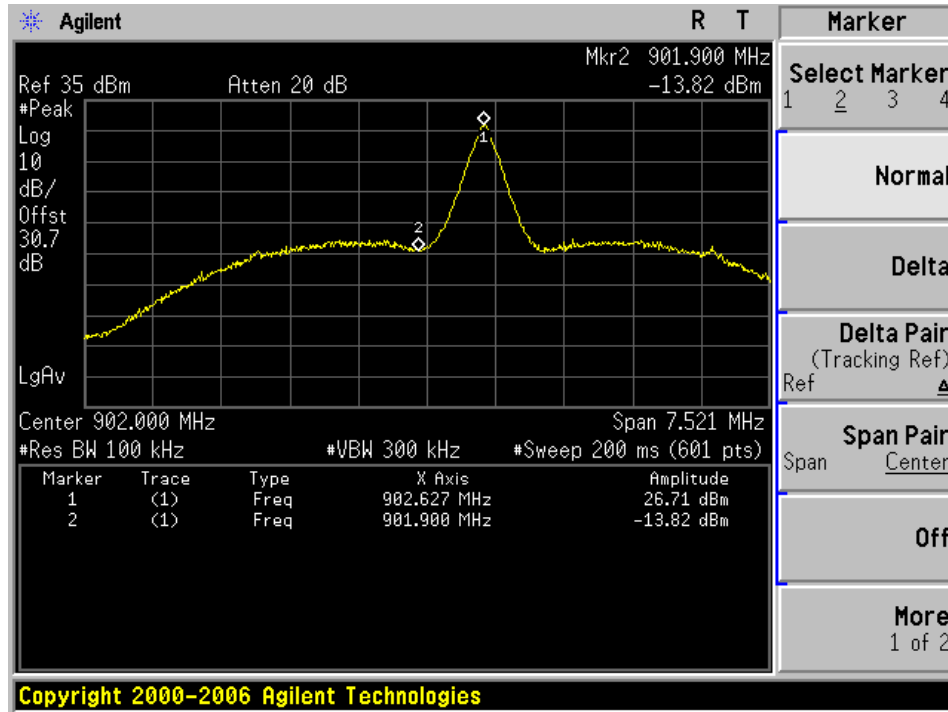

Band Edge: Highest Channel

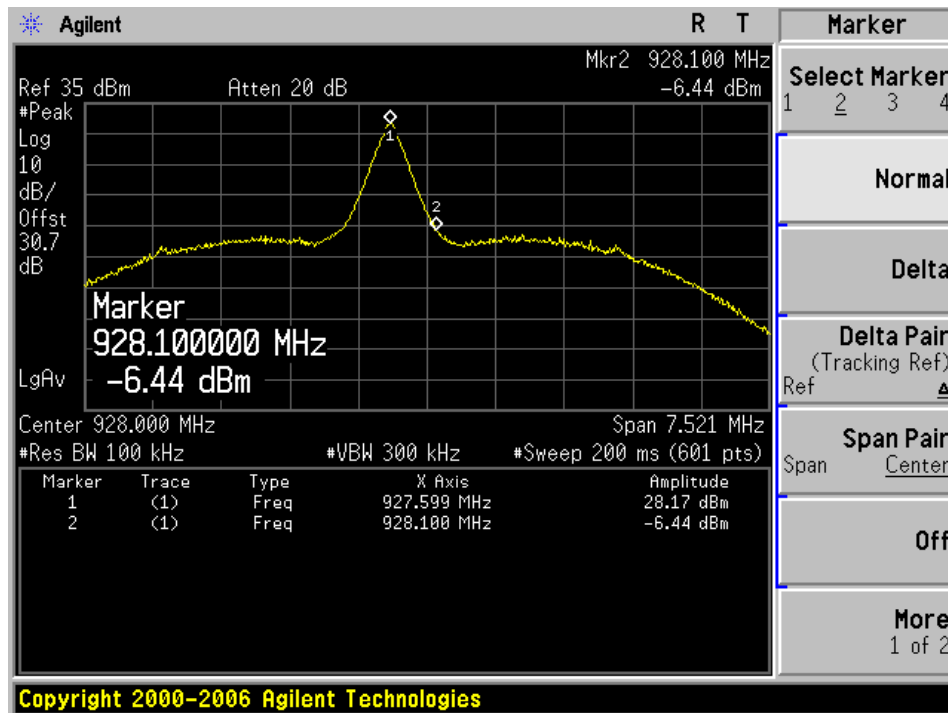

13 FCC §15.247(d) & IC RSS-210 §A8.5 - Spurious Emissions at Antenna Terminals

13.1 Applicable Standard

As per FCC §15.247(d) and IC RSS-210 § A8.5, in any 100 kHz bandwidth outside the frequency band in which the spread spectrum or digitally modulated intentional radiator is operating, the radio frequency power that is produced by the intentional radiator shall be at least 20 dB below that in the 100 kHz bandwidth within the band that contains the highest level of the desired power, based on either an RF conducted or a radiated measurement, provided the transmitter demonstrates compliance with the peak conducted power limits.

13.2 Measurement Procedure

1. Check the calibration of the measuring instrument (SA) using either an internal calibrator or a known signal from an external generator.
2. Position the EUT on a bench without connection to measurement instrument. Turn on the EUT and connect its antenna terminal to measurement instrument via a low loss cable. Then set it to any one measured frequency within its operating range, and make sure the instrument is operated in its linear range.
3. Set the SA on Max-Hold Mode, and then keep the EUT in transmitting mode. Record all the signals from each channel until each one has been recorded.
4. Set the SA on View mode and then plot the result on SA screen.
5. Repeat above procedures until all frequencies measured were complete.

13.3 Test Equipment List and Details

Manufacturer	Description	Model	Serial Number	Calibration Date
Agilent	PSA Spectrum Analyzer	E4440A	MY44303352	2011-05-10

Statement of Traceability: BACL Corp. attests that all calibrations have been performed per the NVLAP requirements, traceable to the NIST.

13.4 Test Environmental Conditions

Temperature:	21 °C
Relative Humidity:	32 %
ATM Pressure:	101.7kPa

The testing was performed by Quinn Jiang on 2012-02-27 at RF test site.

13.5 Test Results

Please refer to the following plots.

Low Channel

30 MHz – 1 GHz

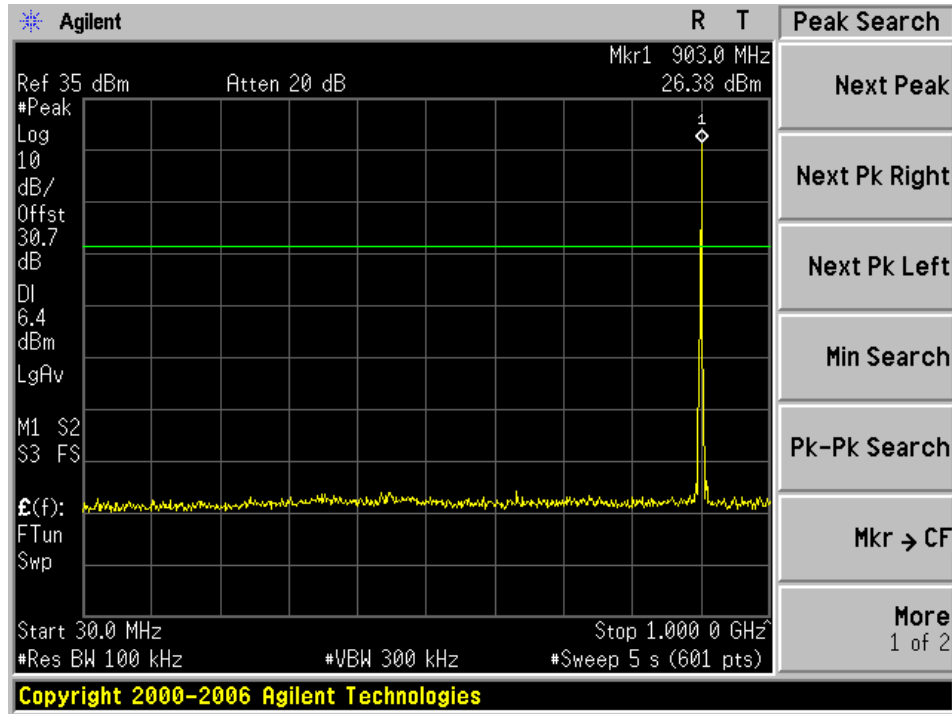

1 – 10 GHz

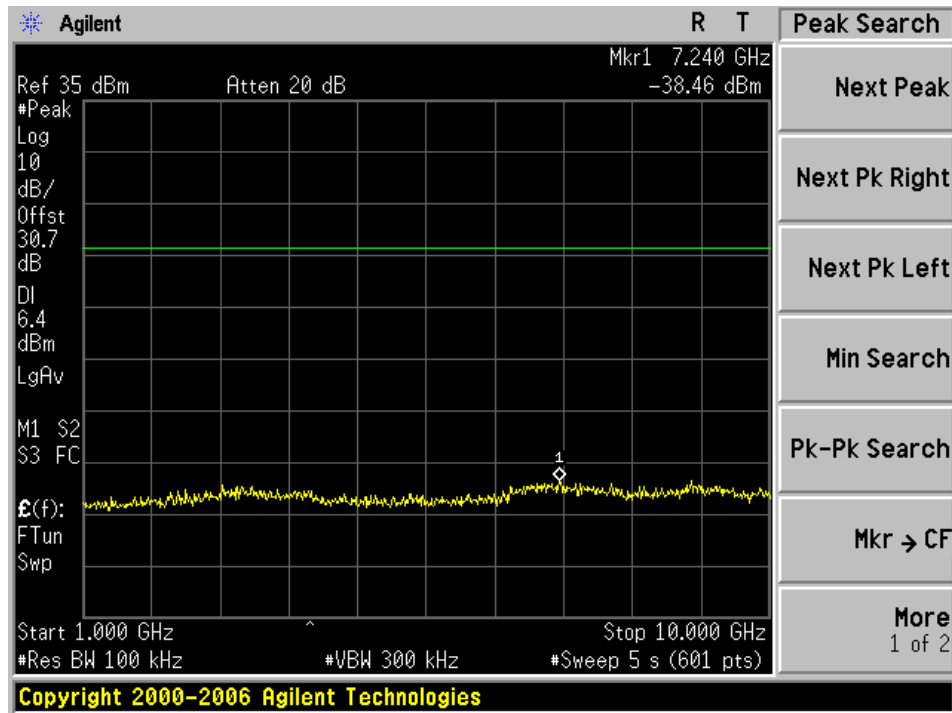

Middle Channel

30 MHz – 1 GHz

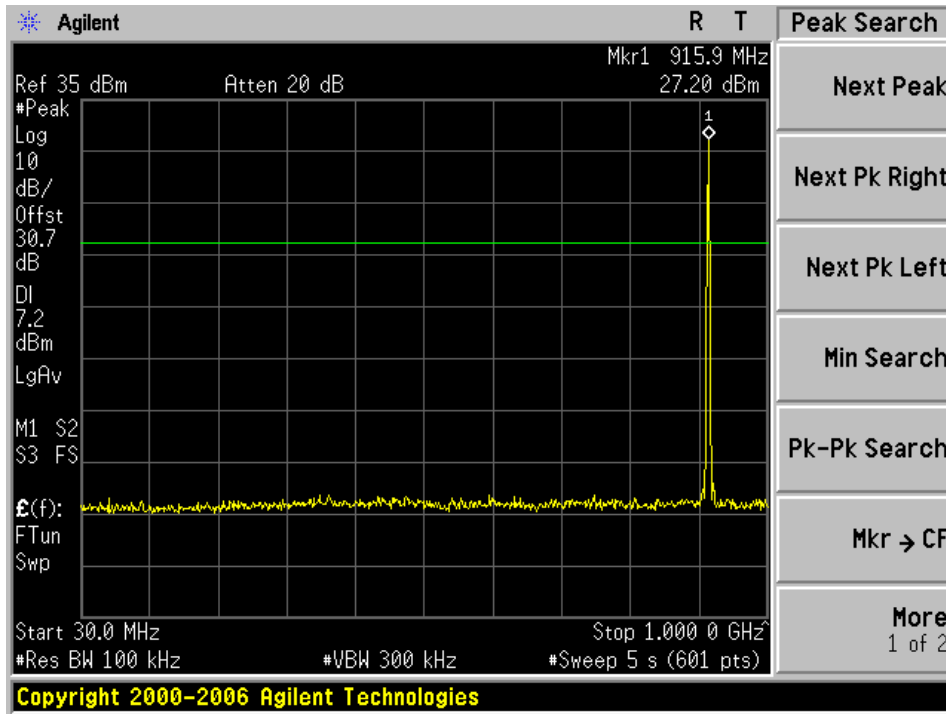

1 – 10 GHz

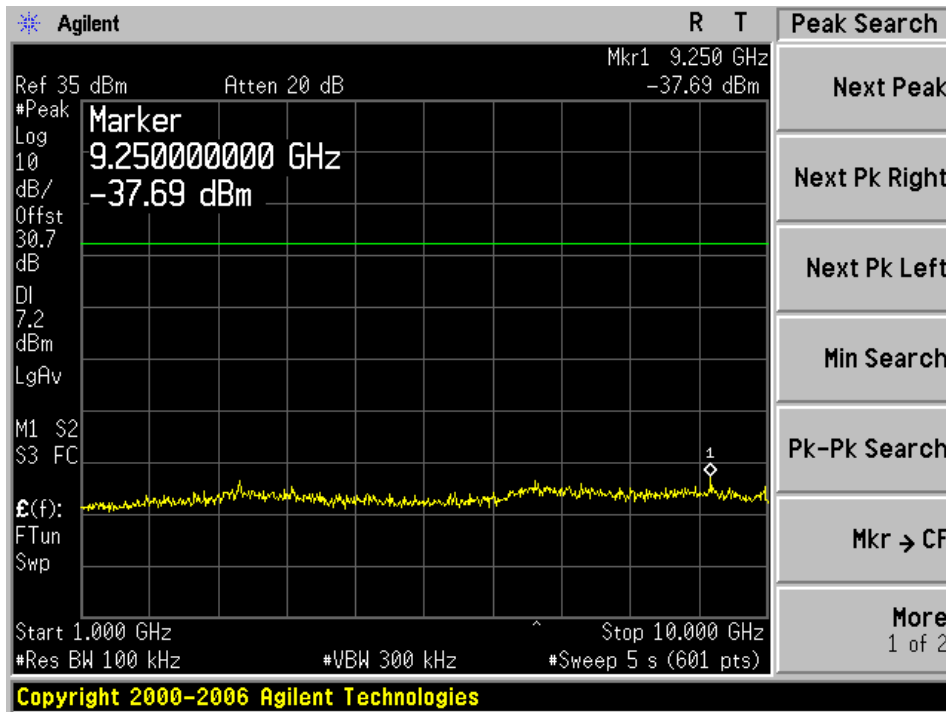

High Channel

30 MHz – 1 GHz

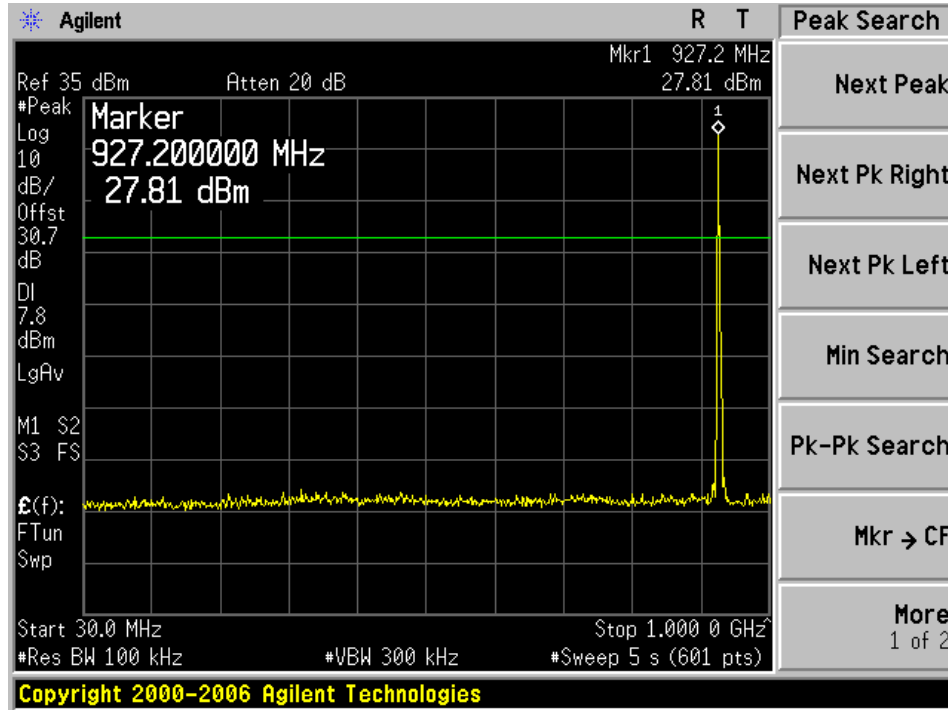

1 – 10 GHz

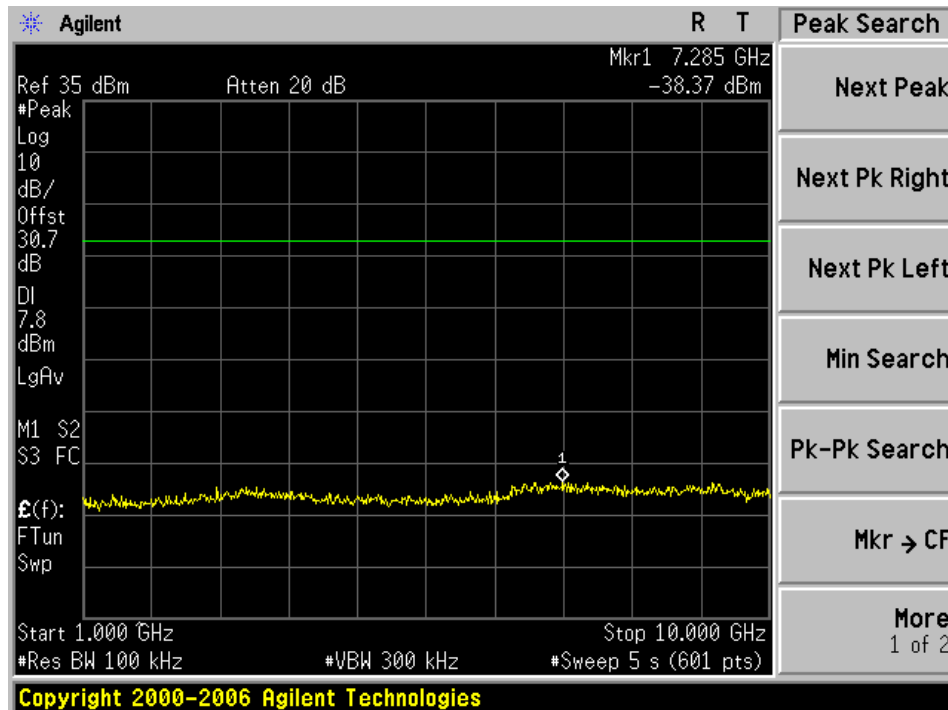

14 IC RSS-Gen §6 - Receiver Radiated Spurious Emissions

14.1 Applicable Standards

According to IC RSS-Gen §6, receiver spurious emission shall not exceed the radiated limits shown in the table below:

Frequency (MHz)	Field Strength (micro volts/meter)	Measurement Distance (meters)
30 - 88	100	3
88 - 216	150	3
216 - 960	200	3
Above 960	500	3

14.2 EUT Setup

The radiated emissions tests were performed in the 3 meter chamber, using the setup in accordance with ANSI C63.4-2003.

14.3 Test Procedure

Maximizing procedure was performed on the six (6) highest emissions to ensure EUT compliance is with all installation combinations.

All data were recorded in the peak detection mode. Quasi-peak readings was performed only when an emissions was found to be marginal (within -4 dB of specification limits), and are distinguished with a "QP" in the data table.

14.4 Corrected Amplitude & Margin Calculation

The Corrected Amplitude (CA) is calculated by adding the Antenna Factor (AF), the Cable Loss (CL), the Attenuator Factor (Atten) and subtracting the Amplifier Gain (Ga) to the indicated Amplitude (Ai) reading. The basic equation is as follows:

$$CA = Ai + AF + CL + Atten - Ga$$

For example, the Corrected Amplitude (CA) of 40.3 dBuV/m = indicated Amplitude reading (Ai) 32.5 dBuV + Antenna Factor (AF) 23.5dB + Cable Loss (CL) 3.7 dB + Attenuator (Atten) 10 dB - Amplifier Gain (Ga) 29.4 dB

The "**Margin**" column of the following data tables indicates the degree of compliance within the applicable limit. For example, a margin of -7 dB means the emission is 7 dB below the maximum limit. The equation for margin calculation is as follows:

$$\text{Margin (dB)} = \text{Corrected Amplitude (dBuV/m)} - \text{Limit (dBuV/m)}$$

14.5 Test Equipment List and Details

Manufacturer	Description	Model No.	Serial No.	Calibration Date
A.H Systems	Antenna, Horn	SAS-200/571	261	2012-01-18
Hewlett Packard	Pre amplifier	8447D	2944A06639	2011-06-09
Sunol Science Corp	Combination Antenna	JB3	A020106-2	2011-08-10
Rohde & Schwarz	EMI Test Receiver	ESCI 1166.5950K03	100337	2011-03-21
Sunol Science Corp	System Controller	SC99V	122303-1	N/R
Agilent	PSA Spectrum Analyzer	E4440A	MY44303352	2011-05-10
Mini-Circuits	Pre Amplifier	ZVA-183-S	667400960	2011-05-08

Statement of Traceability: BACL attests that all calibrations have been performed per the NVLAP requirements, traceable to NIST.

14.6 Test Environmental Conditions

Temperature:	22 °C
Relative Humidity:	33 %
ATM Pressure:	101.7kPa

The testing was performed by Quinn Jiang on 2012-02-27 in 5 meter chamber #3.

14.7 Summary of Test Results

According to the test data,, the EUT complied with the FCC Part 15.109 and IC RSS-Gen, with the closest margins from the limit listed below:

Mode: Receiving			
Margin (dB)	Frequency (MHz)	Polarization (Horizontal/Vertical)	Range
-12.44	240.002	Vertical	30 to 1000 MHz
-21.44	1331.228	Vertical	1 – 5 GHz

Please refer to the following table and plots for specific test result details

14.8 Test Results

1) 30 MHz -1 GHz, measured at 3 meters

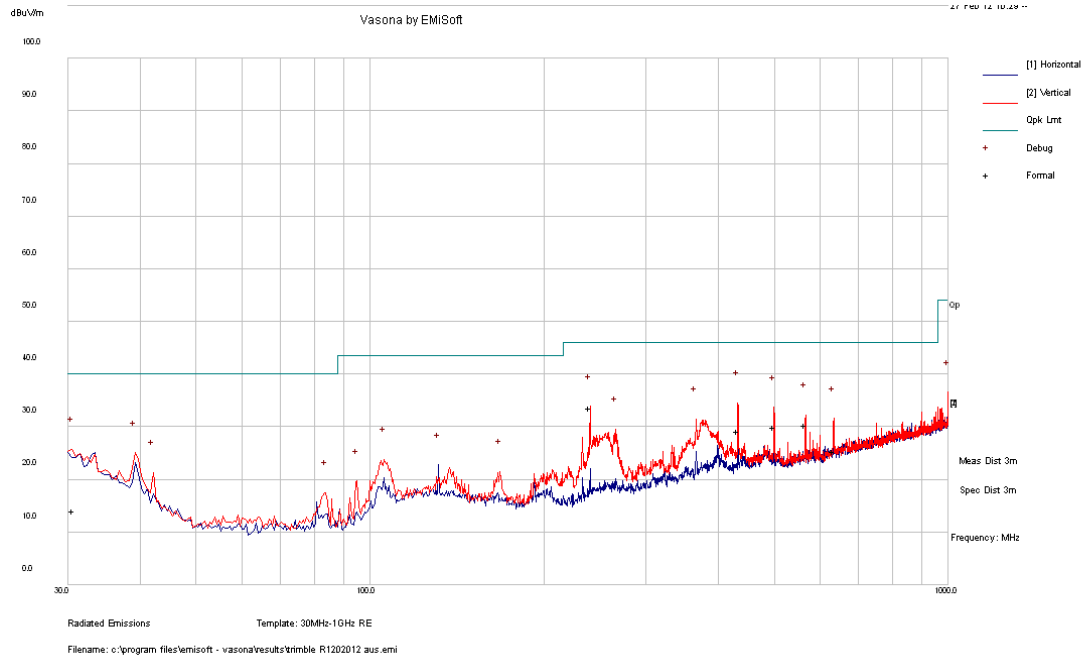

Frequency (MHz)	Corrected Amplitude (dB)	Antenna Height (cm)	Antenna Polarity (H/V)	Turntable Azimuth (degrees)	Limit (dBµV/m)	Margin (dB)
240.002	33.56	105	V	174	46	-12.44
566.4823	30.31	106	V	176	46	-15.69
498.8615	30.01	158	V	192	46	-15.99
432.108	29.22	128	V	210	46	-16.78
633.4528	25.45	121	V	208	46	-20.55
30.63625	13.99	199	V	119	40	-26.01

2) Above 1 GHz, measured at 3 meters

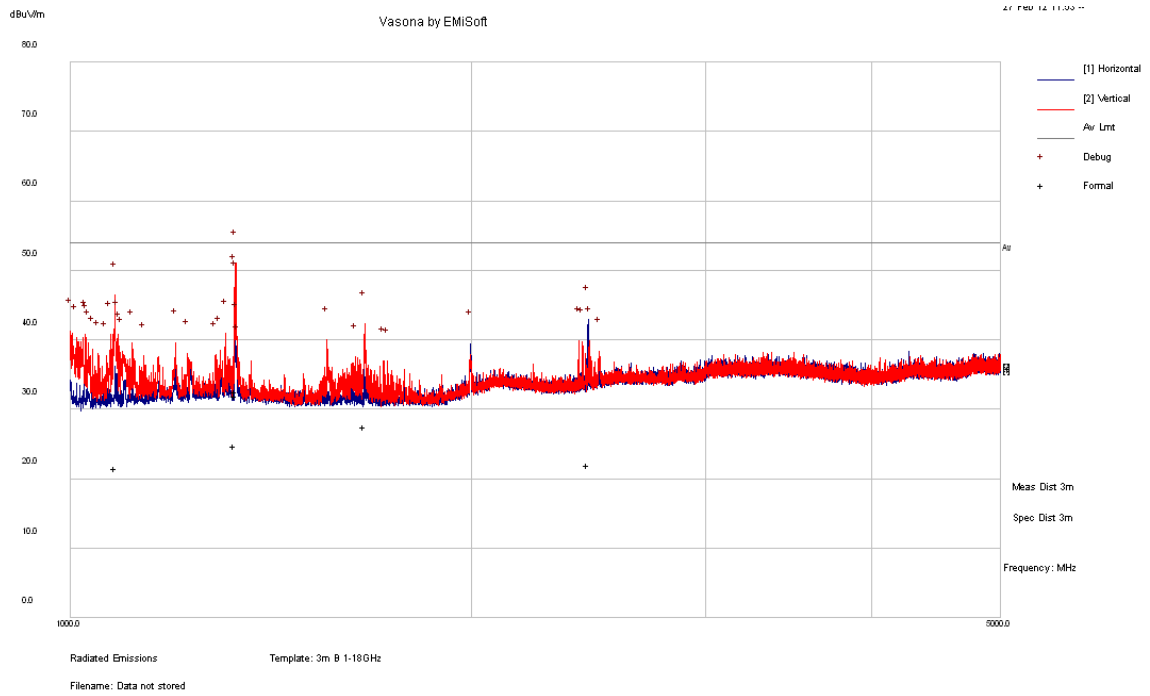

Frequency (MHz)	Corrected Amplitude (dB)	Antenna Height (cm)	Antenna Polarity (H/V)	Turntable Azimuth (degrees)	Limit (dBµV/m)	Margin (dB)
1331.228	32.56	112	V	152	54	-21.44
1330.859	32.04	99	V	158	54	-21.96
1663.556	27.53	105	V	172	54	-26.47
1328.585	24.69	107	V	152	54	-29.31
2447.198	22.06	156	H	155	54	-31.94
1080.435	21.48	150	V	230	54	-32.52

15 FCC §15.247(i), §2.1091 & IC RSS-102 - RF Exposure Information

15.1 Applicable Standards

According to FCC §15.247(i) and §1.1307(b)(1), systems operating under the provisions of this section shall be operated in a manner that ensures that the public is not exposed to radio frequency energy level in excess of the Commission's guidelines.

Limits for General Population/Uncontrolled Exposure

Frequency Range (MHz)	Electric Field Strength (V/m)	Magnetic Field Strength (A/m)	Power Density (mW/cm ²)	Averaging Time (minutes)
Limits for General Population/Uncontrolled Exposure				
0.3-1.34	614	1.63	*(100)	30
1.34-30	824/f	2.19/f	*(180/f ²)	30
30-300	27.5	0.073	0.2	30
300-1500	/	/	f/1500	30
1500-100,000	/	/	1.0	30

f = frequency in MHz

* = Plane-wave equivalent power density

Before equipment certification is granted, the procedure of IC RSS-102 must be followed concerning the exposure of humans to RF fields.

According to IC RSS-102 Issue 2 section 4.1, RF limits used for general public will be applied to the EUT.

Frequency Range (MHz)	Electric Field (V/m rms)	Magnetic Field (A/m rms)	Power Density (W/m ²)	Averaging Time (Minutes)
0.003-1	280	2.19	-	6
1-10	280/f	2.19/f	-	6
10-30	28	2.19/f	-	6
30-300	28	0.073	2*	6
300-1 500	1.585 f ^{0.5}	0.0042 f ^{0.5}	f/150	6
1 500-15 000	61.4	0.163	10	6
15 000-150 000	61.4	0.163	10	616000 / f ^{1.2}
150 000-300 000	0.158 f ^{0.5}	4.21 x 10 ⁻⁴ f ^{0.5}	6.67 x 10 ⁻⁵ f	616000 / f ^{1.2}

Note: f is frequency in MHz

* Power density limit is applicable at frequencies greater than 100 MHz

15.2 MPE Prediction

Predication of MPE limit at a given distance, Equation from OET Bulletin 65, Edition 97-01

$$S = PG/4\pi R^2$$

Where: S = power density

P = power input to antenna

G = power gain of the antenna in the direction of interest relative to an isotropic radiator

R = distance to the center of radiation of the antenna

15.3 MPE Results

1) MPE Calculation of 900 MHz Radio:

<u>Maximum peak output power at antenna input terminal (dBm):</u>	<u>28.49</u>
<u>Maximum peak output power at antenna input terminal (mW):</u>	<u>706.32</u>
<u>Prediction distance (cm):</u>	<u>20</u>
<u>Prediction frequency (MHz):</u>	<u>927.6</u>
<u>Maximum Antenna Gain, typical (dBi):</u>	<u>0</u>
<u>Maximum Antenna Gain (numeric):</u>	<u>1.0</u>
<u>Power density of prediction frequency at 20.0 cm (mW/cm²):</u>	<u>0.141</u>
<u>Power density of prediction frequency at 20.0 cm (W/m²):</u>	<u>1.41</u>
<u>MPE limit for uncontrolled exposure at prediction frequency (mW/cm²):</u>	<u>0.618</u>
<u>MPE limit for uncontrolled exposure at prediction frequency (W/m²):</u>	<u>6.18</u>

2) MPE Calculation of Co-location of 2.4 GHz Wi-Fi & Bluetooth Radio (FCC ID: JUP-76577WFBT):

Radio Type	Operating Frequency (MHz)	MPE Limit	Conducted Power (mW)	Duty Cycle	Antenna Gain (dBi)	Gain (numeric)	Power Density at 20cm (mW/cm ²)	% of MPE	Co-located % of MPE @ 20 cm
900 MHz Radio On									
900 MHz Radio	927.6	0.618	706.32	100%	0	1.0	0.141	22.82	-
900 MHz Radio with 2.4 GHz Wi-Fi Radio on									
2.4 GHz Wi-Fi Radio FCC ID: JUP-76577WFBT	2412	1	74.30	100%	4.0	2.51	0.037	3.7%	26.52
900 MHz Radio with 2.4 GHz BT Radio On									
2.4 GHz FHSS Radio FCC ID: JUP-76577WFBT	2402	1	0.92	100%	4.0	2.51	0.00046	0.046%	22.87
Note: 2.4 GHz Wi-Fi and Bluetooth is a combined radio, Wi-Fi & BT can not transmit simultaneously.									

15.4 Test Result

This device complies with the MPE limit at 20 cm for uncontrolled exposure environment.