

FCC PART 15.247

EMI MEASUREMENT AND TEST REPORT

For

Trimble Navigation Ltd.

935 Stewart Drive
Sunnyvale, CA 94085, USA

FCCID: JUP-59645
Model: CR900, SNR910

| | | | |
|---|---|----------------------|--|
| This Report Concerns: | | Product Type: | |
| <input checked="" type="checkbox"/> Original Report | | 900 MHz radio modem | |
| Test Engineer(s): | James Ma | <i>James Ma</i> | |
| | Dan Corona | <i>Dan Corona</i> | |
| Report Number: | R0703211-247 | | |
| Report Date: | 2007-03-29 | | |
| Reviewed By: | VP of Engineering: Hans Mellberg | | |
| Prepared By: (ct) | Bay Area Compliance Laboratories Corp. 1274 Anvilwood Ave. Sunnyvale, CA 94089, USA Tel: (408) 732-9162 Fax: (408) 732-9164 | | |

Note: This test report is for the customer shown above and their specific product only. It may not be duplicated or used in part without prior written consent from Bay Area Compliance Laboratories Corp. This report **must not** be used by the customer to claim product certification, approval, or endorsement by NVLAP, NIST, or any agency of the Federal Government.

TABLE OF CONTENTS

| | | |
|----------|---|-----------|
| 1 | GENERAL INFORMATION | 4 |
| 1.1 | PRODUCT DESCRIPTION FOR EQUIPMENT UNDER TEST (EUT) | 4 |
| 1.2 | ANTENNA DESCRIPTION | 4 |
| 1.3 | MECHANICAL DESCRIPTION OF EUT | 5 |
| 1.4 | EUT PHOTOGRAPH | 5 |
| 1.5 | OBJECTIVE | 5 |
| 1.6 | RELATED SUBMITTAL(S)/GRANT(S) | 5 |
| 1.7 | TEST METHODOLOGY | 5 |
| 1.8 | MEASUREMENT UNCERTAINTY | 6 |
| 1.9 | TEST FACILITY | 6 |
| 2 | SYSTEM TEST CONFIGURATION | 7 |
| 2.1 | JUSTIFICATION | 7 |
| 2.2 | EUT EXERCISE SOFTWARE | 7 |
| 2.3 | SPECIAL ACCESSORIES | 7 |
| 2.4 | EQUIPMENT MODIFICATIONS | 7 |
| 2.5 | LOCAL SUPPORT EQUIPMENT | 7 |
| 2.6 | POWER SUPPLY LINES | 7 |
| 2.7 | INTERNAL CONFIGURATION | 7 |
| 2.8 | INTERFACE PORTS AND CABLING | 8 |
| 2.9 | TEST SETUP BLOCK DIAGRAMS | 8 |
| 3 | SUMMARY OF TEST RESULTS FOR FCC PART 15 | 9 |
| 4 | §15.203 - ANTENNA REQUIREMENT | 10 |
| 4.1 | APPLICABLE STANDARD | 10 |
| 4.2 | RESULT | 10 |
| 5 | §15.205, §15.209(A) & §15.247(D) - RADIATED EMISSIONS | 11 |
| 5.1 | APPLICABLE STANDARD: FCC §15.205 (A) | 11 |
| 5.2 | APPLICABLE STANDARD: FCC §15.209 RADIATED EMISSION LIMITS, GENERAL REQUIREMENTS | 11 |
| 5.3 | APPLICABLE STANDARD: FCC §15.247 (D) RADIATED SPURIOUS EMISSION REQUIREMENTS | 12 |
| 5.4 | TEST SETUP | 12 |
| 5.5 | TEST EQUIPMENT LIST AND DETAILS | 12 |
| 5.6 | ENVIRONMENTAL CONDITIONS | 13 |
| 5.7 | TEST PROCEDURE | 13 |
| 5.8 | CORRECTED AMPLITUDE & MARGIN CALCULATION | 13 |
| 5.9 | SUMMARY OF TEST RESULTS | 13 |
| 5.10 | RADIATED SPURIOUS EMISSIONS TEST DATA, 1 GHz – 10 GHz: | 14 |
| 6 | §15.247 (D) SPURIOUS EMISSIONS AT ANTENNA TERMINALS | 17 |
| 6.1 | APPLICABLE STANDARD | 17 |
| 6.2 | MEASUREMENT PROCEDURE | 17 |
| 6.3 | TEST EQUIPMENT | 17 |
| 6.4 | TEST SETUP DIAGRAM | 17 |
| 6.5 | ENVIRONMENTAL CONDITIONS | 17 |
| 6.6 | MEASUREMENT RESULTS | 18 |
| 7 | §15.247 (A) (1) - HOPPING CHANNEL SEPARATION | 23 |
| 7.1 | APPLICABLE STANDARD | 23 |
| 7.2 | MEASUREMENT PROCEDURE | 23 |
| 7.3 | TEST EQUIPMENT | 23 |
| 7.4 | TEST SETUP DIAGRAM | 23 |
| 7.5 | ENVIRONMENTAL CONDITIONS | 23 |
| 7.6 | MEASUREMENT RESULTS | 24 |

| | | |
|-----------|--|-----------|
| 8 | §15.247 (A) (1) – HOPPING CHANNEL BANDWIDTH..... | 26 |
| 8.1 | STANDARD APPLICABLE | 26 |
| 8.2 | MEASUREMENT PROCEDURE..... | 26 |
| 8.3 | TEST EQUIPMENT LIST AND DETAILS..... | 26 |
| 8.4 | TEST SETUP DIAGRAM | 26 |
| 8.5 | ENVIRONMENTAL CONDITIONS | 26 |
| 8.6 | MEASUREMENT RESULTS..... | 27 |
| 8.7 | MEASUREMENT TEST RESULT | 27 |
| 9 | §15.247 (A) (1) (I) - NUMBER OF HOPPING FREQUENCIES USED..... | 29 |
| 9.1 | STANDARD APPLICABLE | 29 |
| 9.2 | MEASUREMENT PROCEDURE..... | 29 |
| 9.3 | TEST EQUIPMENT LIST AND DETAILS..... | 29 |
| 9.4 | TEST SETUP DIAGRAM | 29 |
| 9.5 | ENVIRONMENTAL CONDITIONS | 29 |
| 9.6 | MEASUREMENT RESULT | 30 |
| 10 | §15.247(A) (1) (I) - DWELL TIME | 31 |
| 10.1 | APPLICABLE STANDARD | 31 |
| 10.2 | MEASUREMENT PROCEDURE..... | 31 |
| 10.3 | TEST EQUIPMENT LIST AND DETAILS..... | 31 |
| 10.4 | TEST SETUP DIAGRAM | 31 |
| 10.5 | MEASUREMENT RESULTS..... | 32 |
| 11 | §15.247(B) (2) - MAXIMUM PEAK OUTPUT POWER..... | 36 |
| 11.1 | STANDARD APPLICABLE | 36 |
| 11.2 | MEASUREMENT PROCEDURE..... | 36 |
| 11.3 | TEST EQUIPMENT LIST AND DETAILS..... | 36 |
| 11.4 | TEST SETUP DIAGRAM | 36 |
| 11.5 | MEASUREMENT RESULT | 36 |
| 12 | §15.247 (D) - 100 KHZ BANDWIDTH OF BAND EDGES..... | 39 |
| 12.1 | APPLICABLE STANDARD | 39 |
| 12.2 | MEASUREMENT PROCEDURE..... | 39 |
| 12.3 | TEST EQUIPMENT LIST AND DETAILS..... | 39 |
| 12.4 | TEST SETUP DIAGRAM | 39 |
| 12.5 | PLOTS OF 100 KHZ BANDWIDTH OF BAND EDGE | 40 |

1 GENERAL INFORMATION

1.1 Product Description for Equipment Under Test (EUT)

The *Trimble Navigation Ltd.* product, FCC ID: JUP-59645, models: CR900/ SNR910, or the “EUT” as referred to in this report, is a 900 MHz radio modem transceiver used in the construction industry. Model: CR900 and Model: SNR910 are identical in electrical and mechanical construction. The only difference is the EUT external color which is for marketing purpose. It enables the user to establish a wireless data broadcast network for real-time, high-precision GPS applications. The transceiver uses 50 channels for frequency hopping in the 902 to 928 MHz band. The lowest channel is centered at 902.625 MHz. The highest channel is centered at 927.585 MHz.

The transmitter uses direct BPSK modulation.

The primary functional purpose of the Aqua radio is:

1. Receive GNSS corrections from base station and communicate to on-board control and display systems
2. Communicate two-way ATS command and location information
3. Communicate two-way data transfer from office to the machine for AccuGrade and CAES systems

The end customer benefits from this system with:

1. Accurate location of machine can be used to control or optimize machine operation.
2. Ability to load design files from the office
3. Ability to download machine files to the office to report productivity and diagnostics information

1.1.1 Features

- Transmit and receive 902-928 MHz radios
- Compatible with Trimble 900 MHz radios/base stations
- Output GNSS corrections via CAN 250K, CAN1M, RS-232 port (opt)
- Two-way IP data communications via RS-232 port
- CAN IP communications via CAN 250K

1.2 Antenna Description

The antennae used are portable, center fed monopole omni antennae.

| Item Number | Model/Type | |
|-------------|-----------------------|---|
| Antenna 1. | Model: | Antenna Mobile |
| | Manufacturer: | SAS (Signal Antenna Systems, Inc.) |
| | Frequency Range: | Dual Frequency: 902-928 MHz; 2.4 – 2.5 GHz |
| | Maximum Antenna Gain: | 2 dBi at 915 MHz; 2 dBi at 2.5 GHz |
| | Antenna Type | Monopole omni |
| | Measurement: | 23 cmH |
| Antenna 2. | Model: | SPDA17918 |
| | Manufacturer: | Radiall Larsen |
| | Frequency Range: | 890-960 MHz |
| | Maximum Antenna Gain: | 2.14 dBi |
| | Antenna Type | Monopole omni |
| | Measurement: | 23 cmH |

1.3 Mechanical Description of EUT

The *Trimble Navigation Ltd.* product, FCCID: JUP-59645, models: CR900/ SNR910, measures approximately 178 mmL x 178 mmW x 64 mmH, and weighs approximately 2.7 kg. The EUT chassis is of a metal construction.*

*The test data gathered are from production sample, serial number: 0537J00022, provided by the manufacturer.

1.4 EUT Photograph



Please refer to Exhibit C for more EUT photographs.

1.5 Objective

This type approval report is prepared on behalf of *Trimble Navigation Ltd.* in accordance with Part 2, Subpart J, Part 15, Subparts A, B, C of the Federal Communication Commissions rules.

The objective is to determine compliance with FCC 15.247 Standard's limits rules for Antenna Requirements, Conducted Emissions, Radiated Emissions, Spurious Emissions at Antenna Port, Hopping Channel Separation, Hopping Channel Bandwidth, Number of Hopping Frequencies Used, Dwell Time of Each Frequency, Maximum Peak Output Power, 100 kHz Bandwidth of Frequency Band Edge and RF Exposure.

1.6 Related Submittal(s)/Grant(s)

N/A.

1.7 Test Methodology

All measurements contained in this report were conducted in accordance with ANSI C63.4-2003.

1.8 Measurement Uncertainty

All measurements involve certain levels of uncertainties, especially in the field of EMC. The factors contributing to uncertainties are spectrum analyzer, cable loss, antenna factor calibration, antenna directivity, antenna factor variation with height, antenna phase center variation, antenna factor frequency interpolation, measurement distance variation, site imperfections, mismatch (average), and system repeatability.

Based on NIS 81, The Treatment of Uncertainty in EMC Measurements, the values ranging from ± 2.0 dB for Conducted Emissions tests and ± 4.0 dB for Radiated Emissions tests are the most accurate estimates pertaining to uncertainty of EMC measurements at BA CL Corp.

Detailed instrumentation measurement uncertainties can be found in BA CL Corp. report QAP-018.

1.9 Test Facility

The test site used by BA CL Corp. to collect radiated and conducted emissions measurement data is located at its facility in Sunnyvale, California, USA.

The test site at BA CL Corp. has been fully described in reports submitted to the Federal Communication Commission (FCC) and Voluntary Control Council for Interference (VCCI). The details of these reports have been found to be in compliance with the requirements of Section 2.948 of the FCC Rules on February 11, 1997 and December 10, 1997 and Article 8 of the VCCI regulations on December 25, 1997. The facility also complies with the test methods and procedures set forth in ANSI C63.4-2003 & TIA/EIA-603.

The Federal Communications Commission and Voluntary Control Council for Interference have the reports on file and they are listed under FCC registration number: 90464 and VCCI Registration No.: R-2463 and C-2698. The test site has been approved by the FCC and VCCI for public use and is listed in the FCC Public Access Link (PAL) database.

Additionally, BA CL Corp. is a National Institute of Standards and Technology (NIST) accredited laboratory under the National Voluntary Laboratory Accredited Program (Lab Code 200167-0). The current scope of accreditations can be found at <http://ts.nist.gov/ts/htdocs/210/214/scopes/2001670.htm>.

2 SYSTEM TEST CONFIGURATION

2.1 Justification

The EUT was configured for testing according to ANSI C63.4-2003.

The EUT was tested in the normal (native) operating mode to represent *worst*-case results during the final qualification test.

2.2 EUT Exercise Software

The software is provided by customer. The EUT exercise program used during radiated testing was designed to exercise the system components.

2.3 Special Accessories

As shown in following test block diagram.

2.4 Equipment Modifications

No modifications were made to the EUT.

2.5 Local Support Equipment

| Manufacturer | Description | Model | Serial Number |
|--------------|-------------|-------|---------------|
| Dell | Laptop | PP11L | 8273581345 |

2.6 Power Supply Lines

| Manufacturer | Description | Model | Serial Number |
|---------------------------------|---------------------------|----------|---------------|
| Samlex Electric Company Limited | Regulated DC Power Supply | RPS 1204 | 01021-0406 |

2.7 Internal Configuration

| Manufacturer | Description | Part Number | Rev |
|--------------------|---------------|-------------|-----|
| Trimble Navigation | Control Board | 58480-00-B | 4 |
| Trimble Navigation | RF Board | 56889-00-C | 1 |

2.8 Interface Ports and Cabling

| Cable Description | Length (m) | From | To |
|-------------------|------------|------|--------|
| Serial Cable | <3m | EUT | Laptop |

2.9 Test Setup Block Diagrams

Radiated Emissions

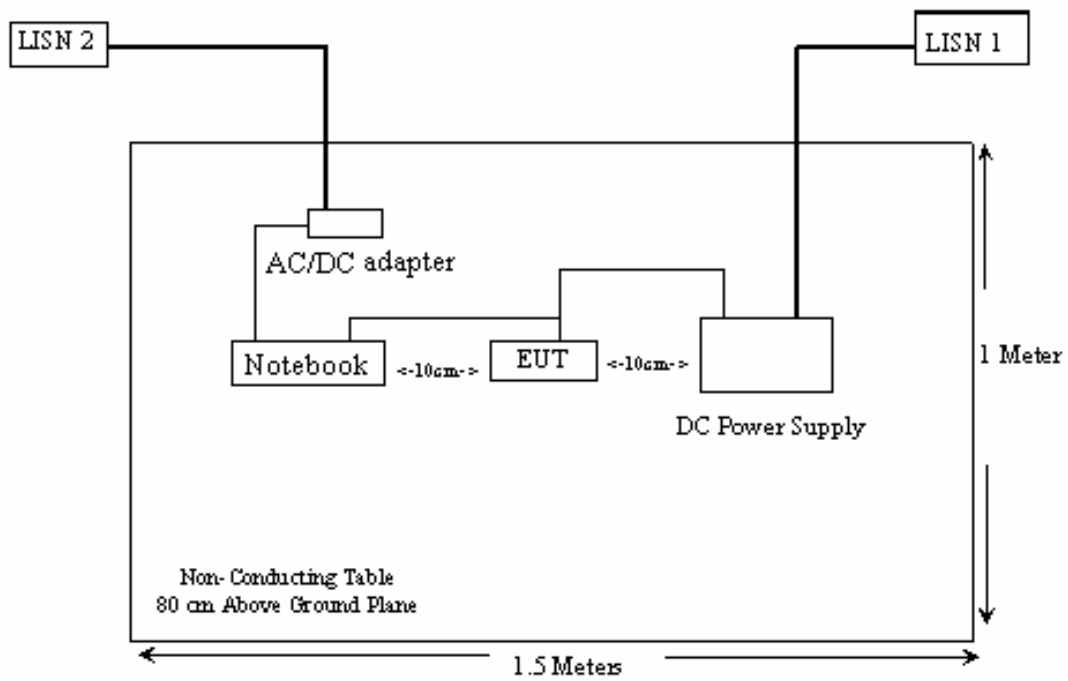

3 SUMMARY OF TEST RESULTS FOR FCC PART 15

| FCC RULES | DESCRIPTION OF TEST | RESULT |
|-------------------------------|--|-----------|
| §15.203 | Antenna Requirement | Compliant |
| § 15.207 (a) | Conducted Emissions | NA* |
| §15.205, §15.209 & §15.247(c) | Radiated Emissions | Compliant |
| §15.247(d) | Spurious Emissions at Antenna Terminals | Compliant |
| §15.247 (a) (1) | Hopping Channel Separation | Compliant |
| §15.247 (a) (1) | Channel Bandwidth | Compliant |
| §15.247 (a) (1) (i) | Number of Hopping Frequencies Used | Compliant |
| §15.247 (a) (1) (i) | Dwell Time of Each Frequency | Compliant |
| §15.247 (b)(2) | Maximum Peak Output Power | Compliant |
| § 15.247 (d) | 100 kHz Bandwidth of Frequency Band Edge | Compliant |
| §15.247(e)(i) §2.1091 | RF Exposure | Compliant |

*Note: The EUT is powered by DC power supply and does not require conducted emissions testing.

4 §15.203 - ANTENNA REQUIREMENT

4.1 Applicable Standard

According to § 15.203, an intentional radiator shall be designed to ensure that no antenna other than that furnished by the responsible party shall be used with the device. The use of a permanently attached antenna or of an antenna that uses a unique coupling to the intentional radiator shall be considered sufficient to comply with the provisions of this Section. The manufacturer may design the unit so that a broken antenna can be replaced by the user, but the use of a standard antenna jack or electrical connector is prohibited.

And according to § 15.247 (b) (4), if transmitting antennas of directional gain greater than 6 dBi are used the power shall be reduced by the amount in dB that the directional gain of the antenna exceeds 6 dBi.

4.2 Result

The antennae, model: SPDA17918 and model: Antenna Mobile for this device are, center fed monopole whip antennae with TNC connectors and a maximum gain of 2.14 dBi and 2 dBi respectively.

Compliant

N/A

Please refer to the following antenna photos for details.



2dBi Antenna Mobile



2.14 dBi PDA17918

5 §15.205, §15.209(a) & §15.247(d) - RADIATED EMISSIONS

5.1 Applicable Standard: FCC §15.205 (a)

a) As Per 15.205(a) except as show in paragraph (d) of this section, only spurious emissions are permitted in any of the frequency bands listed below:

| MHz | MHz | MHz | GHz |
|---------------------|-----------------------|-----------------|---------------|
| 0.090 – 0.110 | 16.42 – 16.423 | 960 – 1240 | 4.5 – 5.15 |
| 0.495 – 0.505 | 16.69475 – 16.69525 | 1300 – 1427 | 5.35 – 5.46 |
| 2.1735 – 2.1905 | 25.5 – 25.67 | 1435 – 1626.5 | 7.25 – 7.75 |
| 4.125 – 4.128 | 37.5 – 38.25 | 1645.5 – 1646.5 | 8.025 – 8.5 |
| 4.17725 – 4.17775 | 73 – 74.6 | 1660 – 1710 | 9.0 – 9.2 |
| 4.20725 – 4.20775 | 74.8 – 75.2 | 1718.8 – 1722.2 | 9.3 – 9.5 |
| 6.215 – 6.218 | 108 – 121.94 | 2200 – 2300 | 10.6 – 12.7 |
| 6.26775 – 6.26825 | 123 – 138 | 2310 – 2390 | 13.25 – 13.4 |
| 6.31175 – 6.31225 | 149.9 – 150.05 | 2483.5 – 2500 | 14.47 – 14.5 |
| 8.291 – 8.294 | 156.52475 – 156.52525 | 2690 – 2900 | 15.35 – 16.2 |
| 8.362 – 8.366 | 156.7 – 156.9 | 3260 – 3267 | 17.7 – 21.4 |
| 8.37625 – 8.38675 | 162.0125 – 167.17 | 3.332 – 3.339 | 22.01 – 23.12 |
| 8.41425 – 8.41475 | 167.72 – 173.2 | 3.3458 – 3.358 | 23.6 – 24.0 |
| 12.29 – 12.293 | 240 – 285 | 3.600 – 4.400 | 31.2 – 31.8 |
| 12.51975 – 12.52025 | 322 – 335.4 | | 36.43 – 36.5 |
| 12.57675 – 12.57725 | 399.9 – 410 | | Above 38.6 |
| 13.36 – 13.41 | 608 – 614 | | |

b) Except as provided in 15.205 paragraphs (d) and (e), the field strength of emissions appearing within these frequency bands shall not exceed the limits shown in Section 15.209. At frequencies equal to or less than 1000 MHz, compliance with the limits in Section 15.209 shall be demonstrated using measurement instrumentation employing a CISPR quasi-peak detector. Above 1000 MHz, compliance with the emission limits in Section 15.209 shall be demonstrated based on the average value of the measured emissions. The provisions in Section 15.35 apply to these measurements.

(c) Except as provided in paragraphs (d) and (e), regardless of the field strength limits specified elsewhere in this Subpart, the provisions of this Section apply to emissions from any intentional radiator.

Compliant

N/A

5.2 Applicable Standard: FCC §15.209 Radiated emission limits, general requirements.

a) Except as provided elsewhere in this Subpart, the emissions from an intentional radiator shall not exceed the field strength levels specified in the following table:

| Frequency (MHz) | Field Strength (micro volts/m) | Measurement Distance (meters) |
|-----------------|--------------------------------|-------------------------------|
| 0.009 - 0.490 | 2400/F(kHz) | 300 |
| 0.490 - 1.705 | 24000/F(kHz) | 30 |
| 1.705 - 30.0 | 30 | 30 |
| 30 - 88 | 100** | 3 |
| 88 - 216 | 150** | 3 |
| 216 - 960 | 200** | 3 |
| Above 960 | 500 | 3 |

** Except as provided in paragraph (g), fundamental emissions from intentional radiators operating under this Section shall not be located in the frequency bands 54-72 MHz, 76-88 MHz, 174-216 MHz or 470-806 MHz. However, operation within these frequency bands is permitted under other sections of this Part, e.g., Sections 15.231 and 15.241.

b) In the emission table above, the tighter limit applies at the band edges.

Compliant

N/A

5.3 Applicable Standard: FCC §15.247 (d) Radiated spurious emission requirements.

According to §15.247 (d) In any 100 kHz bandwidth outside the frequency band in which the spread spectrum or digitally modulated intentional radiator is operating, the radio frequency power that is produced by the intentional radiator shall be at least 20 dB below that in the 100 kHz bandwidth within the band that contains the highest level of the desired power, based on either an RF conducted or a radiated measurement, provided the transmitter demonstrates compliance with the peak conducted power limits. If the transmitter complies with the conducted power limits based on the use of RMS averaging over a time interval, as permitted under paragraph (b)(3) of this section, the attenuation required under this paragraph shall be 30 dB instead of 20 dB. Attenuation below the general limits specified in §15.209(a) is not required. In addition, radiated emissions which fall in the restricted bands, as defined in §15.205(a), must also comply with the radiated emission limits specified in §15.209(a) (see §15.205(c)).

Compliant

N/A

5.4 Test Setup

The radiated emissions tests were performed in the shielded room, using the setup in accordance with ANSI C63.4-2003. The specification used was the FCC 15 Subpart C limits.

5.5 Test Equipment List and Details

| Manufacturer | Description | Model | Serial Number | Calibration Date |
|---------------------|---|-----------|-------------------|------------------|
| Agilent | Analyzer, Spectrum | E4446A | US44300386 | 2006-04-06 |
| HP | Pre, Amplifier (1 ~ 26.5 GHz) | 8449B | 3147A00400 | 2006-08-21 |
| Sonoma Instrument | Amplifier Broadband (10 KHz - 2500 MHz) | 317 | 260407 | 2006-04-06 |
| A.R.A | Antenna, Horn, DRG | DRG-118/A | 1132 | 2005-08-17* |
| Sunol Science Corp. | 30MHz ~ 3 GHz Antenna | JB3 | A020106-3/S006628 | 2007-03-05 |

* Two years calibration cycle.

* **Statement of Traceability: BACL Corp.** attests that all calibrations have been performed per the NVLAP requirements, traceable to the NIST.

5.6 Environmental Conditions

| | |
|---------------------------|-----------|
| Temperature: | 25 °C |
| Relative Humidity: | 40 % |
| ATM Pressure: | 102.0 kPa |

*The testing was performed by James Ma on 2007-03-24 and Dan Corona on 2007-03-28.

5.7 Test Procedure

Maximizing procedure was performed on the six (6) highest emissions to ensure EUT compliance is with all installation combinations.

All data were recorded in the peak detection mode. Quasi-peak readings was performed only when an emissions was found to be marginal (within -4 dB of specification limits), and are distinguished with a "QP" in the data table.

5.8 Corrected Amplitude & Margin Calculation

The Corrected Amplitude is calculated by adding the Antenna Factor and Cable Factor, and subtracting the Amplifier Gain from the Amplitude reading. The basic equation is as follows:

$$\text{Corrected Amplitude} = \text{Indicated Reading} + \text{Antenna Factor} + \text{Cable Factor} - \text{Amplifier Gain}$$

The "Margin" column of the following data tables indicates the degree of compliance with the applicable limit. For example, a margin of -7dB means the emissions are 7dB below the maximum limit. The equation for margin calculation is as follows:

$$\text{Margin} = \text{Corrected Amplitude} - \text{Limit}$$

5.9 Summary of Test Results

According to the test data, the EUT complied with the FCC Title 47, Part 15 Subpart C sections 205, 209 and 247 standards' limits, with the closest margins from the limit listed below:

Antenna 1. (Model: Antenna Mobile)

-10.5 dB at 2707.875 MHz in the Vertical polarization, Low Channel

-11.5 dB at 2746.095 MHz in the Vertical polarization, Middle Channel

-12.0 dB at 2782.755 MHz in the Vertical polarization, High Channel

Antenna 2. (Model: SPDA17918)

-24.7 dB at 2707.8630 MHz in the Vertical polarization, Low Channel

-23.4 dB at 2746.0773 MHz in the Vertical polarization, Middle Channel

-22.5 dB at 2782.7550 MHz in the Vertical polarization, High Channel

5.10 Radiated Spurious Emissions Test Data, 1 GHz – 10 GHz:**Run#1 Radiated Harmonics and Spurious Emissions (Antenna Model: Antenna Mobile, with 2dBi gain)**

Low Channel

| Frequency (MHz) | Reading (dBµV) | Azimuth (Degrees) | Height (m) | Polarization (H / V) | Antenna Factor (dB/m) | Cable loss (dB) | Pre-Amp. Gain (dB) | Corrected Reading (dBµV/m) | FCC 15 C | | Comments |
|-----------------|----------------|-------------------|------------|----------------------|-----------------------|-----------------|--------------------|----------------------------|----------------|-------------|-----------|
| | | | | | | | | | Limit (dBµV/m) | Margin (dB) | |
| 902.625 | 126.90 | 100 | 1.4 | V | 23.6 | 0.7 | 28.4 | 122.8 | | | Fund/Peak |
| 902.625 | 126.80 | 120 | 2.0 | H | 23.6 | 0.7 | 28.4 | 122.7 | | | Fund/Peak |
| 902.625 | 126.50 | 100 | 1.2 | V | 23.6 | 0.7 | 28.4 | 122.4 | | | Ave |
| 902.625 | 126.20 | 120 | 1.2 | H | 23.6 | 0.7 | 28.4 | 122.1 | | | Ave |
| 2707.875 | 48.60 | 180 | 2.0 | V | 28.9 | 1.5 | 35.5 | 43.5 | 54 | -10.5 | Ave |
| 2707.875 | 43.00 | 90 | 2.0 | H | 28.9 | 1.5 | 35.5 | 37.9 | 54 | -16.1 | Ave |
| 1805.250 | 46.60 | 270 | 2.4 | V | 24.8 | 1.5 | 36.3 | 36.5 | 54 | -17.5 | Ave |
| 2707.875 | 50.30 | 90 | 2.0 | V | 28.9 | 1.5 | 35.5 | 45.2 | 74 | -28.8 | Peak |
| 1805.250 | 34.30 | 180 | 2.3 | H | 24.8 | 1.5 | 36.3 | 24.2 | 54 | -29.8 | Ave |
| 2707.875 | 44.10 | 180 | 2.0 | H | 28.9 | 1.5 | 35.5 | 39.0 | 74 | -35.0 | Peak |
| 1805.250 | 48.90 | 270 | 2.4 | V | 24.8 | 1.5 | 36.3 | 38.8 | 74 | -35.2 | Peak |
| 1805.250 | 43.20 | 180 | 2.3 | H | 24.8 | 1.5 | 36.3 | 33.1 | 74 | -40.9 | Peak |

Middle Channel

| Frequency (MHz) | Reading (dBµV) | Azimuth (Degrees) | Height (m) | Polarization (H / V) | Antenna Factor (dB/m) | Cable loss (dB) | Pre-Amp. Gain (dB) | Corrected Reading (dBµV/m) | FCC 15 C | | Comments |
|-----------------|----------------|-------------------|------------|----------------------|-----------------------|-----------------|--------------------|----------------------------|----------------|-------------|-----------|
| | | | | | | | | | Limit (dBµV/m) | Margin (dB) | |
| 915.365 | 126.83 | 150 | 1.3 | V | 23.2 | 0.7 | 28.4 | 122.4 | | | Fund/Peak |
| 915.365 | 126.70 | 120 | 1.2 | H | 23.2 | 0.7 | 28.4 | 122.2 | | | Fund/Peak |
| 915.365 | 126.40 | 150 | 1.3 | V | 23.2 | 0.7 | 28.4 | 121.9 | | | Ave |
| 915.365 | 126.35 | 120 | 1.2 | H | 23.2 | 0.7 | 28.4 | 121.9 | | | Ave |
| 2746.095 | 47.60 | 270 | 2.4 | V | 28.9 | 1.5 | 35.5 | 42.5 | 54 | -11.5 | Ave |
| 2746.095 | 39.40 | 180 | 2.1 | H | 28.9 | 1.5 | 35.5 | 34.3 | 54 | -19.7 | Ave |
| 1830.730 | 37.50 | 120 | 1.3 | V | 24.8 | 1.5 | 36.3 | 27.4 | 54 | -26.6 | Ave |
| 2746.095 | 49.30 | 270 | 2.4 | V | 28.9 | 1.5 | 35.5 | 44.2 | 74 | -29.8 | Peak |
| 1830.730 | 33.90 | 180 | 2.2 | H | 24.8 | 1.5 | 36.3 | 23.8 | 54 | -30.2 | Ave |
| 2746.095 | 41.20 | 180 | 2.3 | H | 28.9 | 1.5 | 35.5 | 36.1 | 74 | -37.9 | Peak |
| 1830.730 | 40.30 | 120 | 1.3 | V | 24.8 | 1.5 | 36.3 | 30.2 | 74 | -43.8 | Peak |
| 1830.730 | 38.60 | 180 | 2.2 | H | 24.8 | 1.5 | 36.3 | 28.5 | 74 | -45.5 | Peak |

High Channel

| Frequency (MHz) | Reading (dB μ V) | Azimuth (Degrees) | Height (m) | Polarization (H / V) | Antenna Factor (dB/m) | Cable loss (dB) | Pre-Amp. Gain (dB) | Corrected Reading (dB μ V/m) | FCC 15 C | | Comments |
|-----------------|----------------------|-------------------|------------|----------------------|-----------------------|-----------------|--------------------|----------------------------------|----------------------|-------------|-----------|
| | | | | | | | | | Limit (dB μ V/m) | Margin (dB) | |
| 927.585 | 126.83 | 200 | 1.0 | V | 23.4 | 0.7 | 28.3 | 122.6 | | | Fund/Peak |
| 927.585 | 126.68 | 180 | 1.2 | H | 23.4 | 0.7 | 28.3 | 122.4 | | | Fund/Peak |
| 927.585 | 126.40 | 200 | 1.0 | V | 23.4 | 0.7 | 28.3 | 122.2 | | | Ave |
| 927.585 | 126.30 | 180 | 1.2 | H | 23.4 | 0.7 | 28.3 | 122.1 | | | Ave |
| 2782.755 | 47.10 | 270 | 2.4 | V | 28.9 | 1.5 | 35.5 | 42.0 | 54 | -12.0 | Ave |
| 2782.755 | 39.30 | 90 | 2.1 | H | 28.9 | 1.5 | 35.5 | 34.2 | 54 | -19.8 | Ave |
| 1855.170 | 40.20 | 270 | 2.4 | V | 24.8 | 1.5 | 36.3 | 30.1 | 54 | -23.9 | Ave |
| 1855.170 | 38.70 | 90 | 2.1 | H | 24.8 | 1.5 | 36.3 | 28.6 | 54 | -25.4 | Ave |
| 2782.755 | 49.70 | 270 | 2.4 | V | 28.9 | 1.5 | 35.5 | 44.6 | 74 | -29.4 | Peak |
| 2782.755 | 42.30 | 90 | 2.1 | H | 28.9 | 1.5 | 35.5 | 37.2 | 74 | -36.8 | Peak |
| 1855.170 | 43.50 | 270 | 2.4 | V | 24.8 | 1.5 | 36.3 | 33.4 | 74 | -40.6 | Peak |
| 1855.170 | 41.40 | 90 | 2.1 | H | 24.8 | 1.5 | 36.3 | 31.3 | 74 | -42.7 | Peak |

Run#2 Radiated Harmonics and Spurious Emissions (Antenna Model: SPDA17918, with 2.14 dBi gain)

Low Channel

| Frequency (MHz) | Reading (dB μ V) | Azimuth (Degrees) | Height (m) | Polarization (H / V) | Antenna Factor (dB/m) | Cable loss (dB) | Pre-Amp. Gain (dB) | Corrected Reading (dB μ V/m) | FCC 15 C | | Comments |
|-----------------|----------------------|-------------------|------------|----------------------|-----------------------|-----------------|--------------------|----------------------------------|----------------------|-------------|-----------|
| | | | | | | | | | Limit (dB μ V/m) | Margin (dB) | |
| 902.6210 | 126.8 | 261 | 1.4 | V | 23.6 | 0.7 | 37.4 | 113.7 | | | Fund/Peak |
| 902.6210 | 126.8 | 292 | 1.1 | H | 23.6 | 0.7 | 37.4 | 113.7 | | | Fund/Peak |
| 902.6210 | 126.3 | 261 | 1.4 | V | 23.6 | 0.7 | 37.4 | 113.2 | | | Ave |
| 902.6210 | 126.0 | 292 | 1.1 | H | 23.6 | 0.7 | 37.4 | 112.9 | | | Ave |
| 2707.8630 | 34.0 | 247 | 1.3 | V | 28.9 | 1.5 | 35.1 | 29.3 | 54 | -24.7 | Ave |
| 1805.2420 | 37.5 | 281 | 1.3 | V | 24.8 | 1.5 | 35.9 | 27.9 | 54 | -26.1 | Ave |
| 2707.8630 | 31.3 | 293 | 1.0 | H | 28.9 | 1.5 | 35.1 | 26.7 | 54 | -27.3 | Ave |
| 1805.2420 | 32.2 | 270 | 1.9 | H | 24.8 | 1.5 | 35.9 | 22.6 | 54 | -31.5 | Ave |
| 2707.8630 | 45.7 | 247 | 1.3 | V | 28.9 | 1.5 | 35.1 | 41.0 | 74 | -33.0 | Peak |
| 2707.8630 | 45.0 | 293 | 1.0 | H | 28.9 | 1.5 | 35.1 | 40.3 | 74 | -33.7 | Peak |
| 1805.2420 | 47.0 | 281 | 1.3 | V | 24.8 | 1.5 | 35.9 | 37.4 | 74 | -36.6 | Peak |
| 1805.2420 | 45.7 | 270 | 1.9 | H | 24.8 | 1.5 | 35.9 | 36.1 | 74 | -38.0 | Peak |

Middle Channel

| Frequency (MHz) | Reading (dBµV) | Azimuth (Degrees) | Height (m) | Polarization (H / V) | Antenna Factor (dB/m) | Cable loss (dB) | Pre-Amp. Gain (dB) | Corrected Reading (dBµV/m) | FCC 15 C | | Comments |
|-----------------|----------------|-------------------|------------|----------------------|-----------------------|-----------------|--------------------|----------------------------|----------------|-------------|-----------|
| | | | | | | | | | Limit (dBµV/m) | Margin (dB) | |
| 915.3591 | 127.0 | 342 | 1.2 | V | 23.2 | 0.7 | 37.0 | 113.9 | | | Fund/Peak |
| 915.3591 | 127.0 | 298 | 1.3 | H | 23.2 | 0.7 | 37.0 | 113.9 | | | Fund/Peak |
| 915.3591 | 126.3 | 342 | 1.2 | V | 23.2 | 0.7 | 37.0 | 113.2 | | | Ave |
| 915.3591 | 126.2 | 298 | 1.3 | H | 23.2 | 0.7 | 37.0 | 113.1 | | | Ave |
| 2746.0773 | 35.30 | 284 | 1.1 | V | 28.9 | 1.5 | 35.1 | 30.6 | 54 | -23.4 | Ave |
| 1830.7182 | 38.60 | 185 | 1.3 | V | 24.8 | 1.5 | 35.9 | 29.0 | 54 | -25.0 | Ave |
| 2746.0773 | 32.80 | 196 | 1.2 | H | 28.9 | 1.5 | 35.1 | 28.1 | 54 | -25.9 | Ave |
| 1830.7182 | 33.80 | 175 | 1.4 | H | 24.8 | 1.5 | 35.9 | 24.2 | 54 | -29.8 | Ave |
| 2746.0773 | 47.60 | 284 | 1.1 | V | 28.9 | 1.5 | 35.1 | 42.9 | 74 | -31.1 | Peak |
| 2746.0773 | 47.10 | 196 | 1.2 | H | 28.9 | 1.5 | 35.1 | 42.4 | 74 | -31.6 | Peak |
| 1830.7182 | 47.30 | 185 | 1.3 | V | 24.8 | 1.5 | 35.9 | 37.7 | 74 | -36.3 | Peak |
| 1830.7182 | 46.70 | 175 | 1.4 | H | 24.8 | 1.5 | 35.9 | 37.1 | 74 | -36.9 | Peak |

High Channel

| Frequency (MHz) | Reading (dBµV) | Azimuth (Degrees) | Height (m) | Polarization (H / V) | Antenna Factor (dB/m) | Cable loss (dB) | Pre-Amp. Gain (dB) | Corrected Reading (dBµV/m) | FCC 15 C | | Comments |
|-----------------|----------------|-------------------|------------|----------------------|-----------------------|-----------------|--------------------|----------------------------|----------------|-------------|-----------|
| | | | | | | | | | Limit (dBµV/m) | Margin (dB) | |
| 927.5850 | 127.0 | 219 | 1.1 | V | 23.4 | 0.7 | 37.2 | 113.9 | | | Fund/Peak |
| 927.5850 | 127.0 | 295 | 1.2 | H | 23.4 | 0.7 | 37.2 | 113.9 | | | Fund/Peak |
| 927.5850 | 126.5 | 219 | 1.1 | V | 23.4 | 0.7 | 37.2 | 113.4 | | | Ave |
| 927.5850 | 126.2 | 295 | 1.2 | H | 23.4 | 0.7 | 37.2 | 113.1 | | | Ave |
| 2782.7550 | 36.60 | 190 | 1.4 | V | 28.9 | 1.5 | 35.5 | 31.5 | 54 | -22.5 | Ave |
| 2782.7550 | 33.70 | 185 | 1.3 | H | 28.9 | 1.5 | 35.5 | 28.6 | 54 | -25.4 | Ave |
| 1855.1700 | 38.60 | 165 | 1.3 | V | 24.8 | 1.5 | 36.3 | 28.5 | 54 | -25.5 | Ave |
| 1855.1700 | 33.75 | 133 | 1.2 | H | 24.8 | 1.5 | 36.3 | 23.7 | 54 | -30.4 | Ave |
| 2782.7550 | 48.30 | 190 | 1.4 | V | 28.9 | 1.5 | 35.5 | 43.2 | 74 | -30.8 | Peak |
| 2782.7550 | 48.00 | 185 | 1.3 | H | 28.9 | 1.5 | 35.5 | 42.9 | 74 | -31.1 | Peak |
| 1855.1700 | 47.60 | 165 | 1.3 | V | 24.8 | 1.5 | 35.9 | 38.0 | 74 | -36.0 | Peak |
| 1855.1700 | 46.90 | 233 | 1.2 | H | 24.8 | 1.5 | 35.9 | 37.3 | 74 | -36.7 | Peak |

6 §15.247 (D) SPURIOUS EMISSIONS AT ANTENNA TERMINALS

6.1 Applicable Standard

According to §15.247 (d) In any 100 kHz bandwidth outside the frequency band in which the spread spectrum or digitally modulated intentional radiator is operating, the radio frequency power that is produced by the intentional radiator shall be at least 20 dB below that in the 100 kHz bandwidth within the band that contains the highest level of the desired power, based on either an RF conducted or a radiated measurement, provided the transmitter demonstrates compliance with the peak conducted power limits. If the transmitter complies with the conducted power limits based on the use of RMS averaging over a time interval, as permitted under paragraph (b)(3) of this section, the attenuation required under this paragraph shall be 30 dB instead of 20 dB. Attenuation below the general limits specified in §15.209(a) is not required. In addition, radiated emissions which fall in the restricted bands, as defined in §15.205(a), must also comply with the radiated emission limits specified in §15.209(a) (see §15.205(c)).

6.2 Measurement Procedure

1. Check the calibration of the measuring instrument (SA) using either an internal calibrator or a known signal from an external generator.
2. Position the EUT on a bench without connection to measurement instrument. Turn on the EUT and connect its antenna terminal to measurement instrument via a low loss cable. Then set it to any one measured frequency within its operating range, and make sure the instrument is operated in its linear range.
3. Set the SA on Max-Hold Mode, and then keep the EUT in transmitting mode. Record all the signals from each channel until each one has been recorded.
4. Set the SA on View mode and then plot the result on SA screen.
5. Repeat above procedures until all frequencies measured were complete.

6.3 Test Equipment

| Manufacturer | Description | Model No. | Serial No. | Calibration Date |
|--------------|--------------------|-----------|------------|------------------|
| Agilent | Analyzer, Spectrum | E4446A | US44300386 | 2006-04-06 |

* **Statement of Traceability:** **BACL Corp.** attests that all calibrations have been performed per the NVLAP requirements, traceable to the NIST.

6.4 Test Setup Diagram

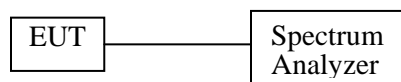

6.5 Environmental Conditions

| | |
|---------------------------|-----------|
| Temperature: | 25 °C |
| Relative Humidity: | 40 % |
| ATM Pressure: | 102.0 kPa |

*The testing was performed by James Ma on 2007-03-24.

Please refer to the following plots.

6.6 Measurement Results

Low Channel

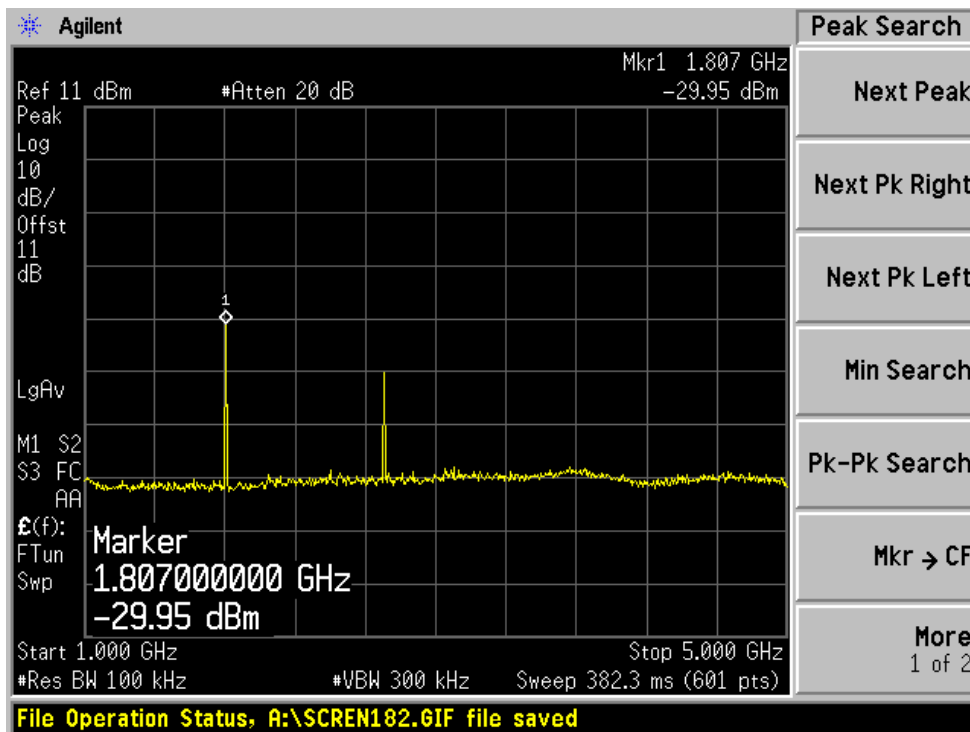
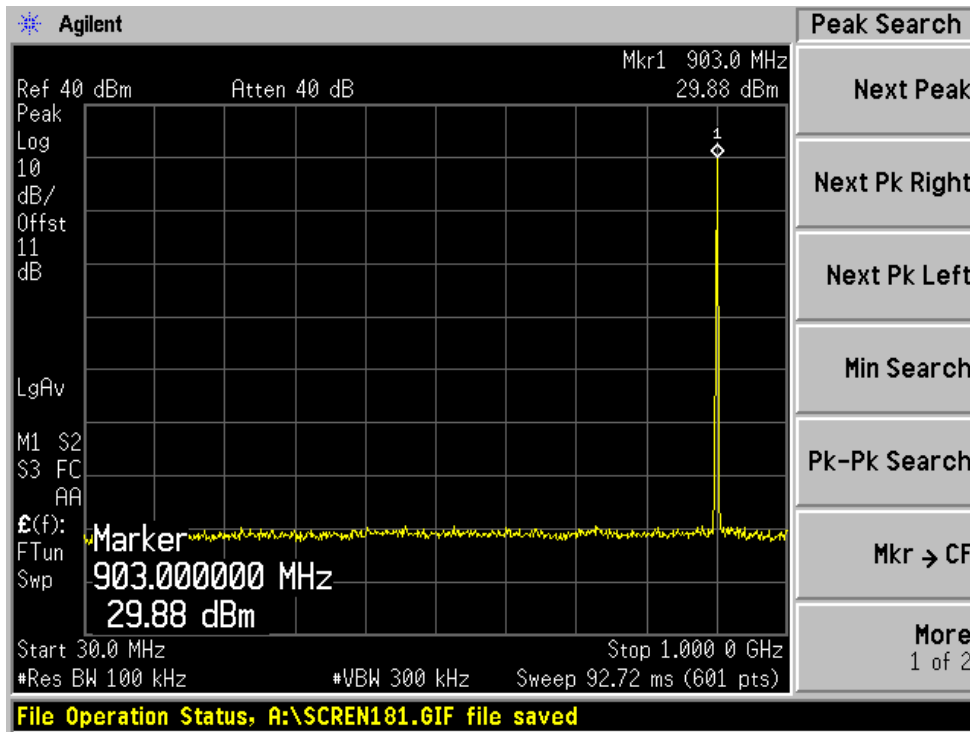

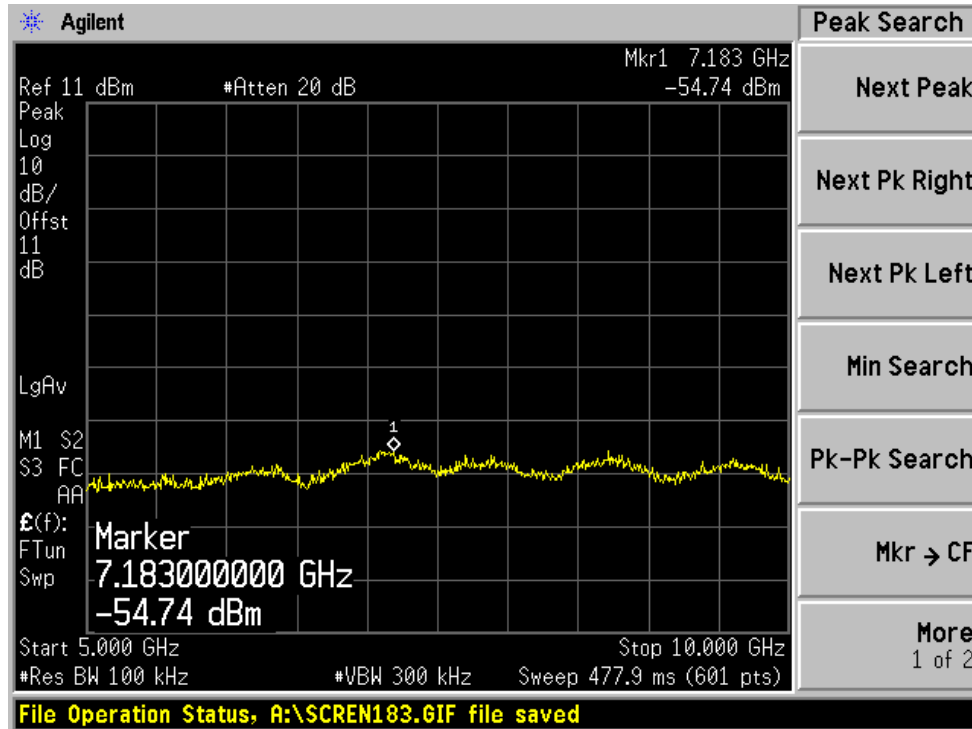

Middle Channel

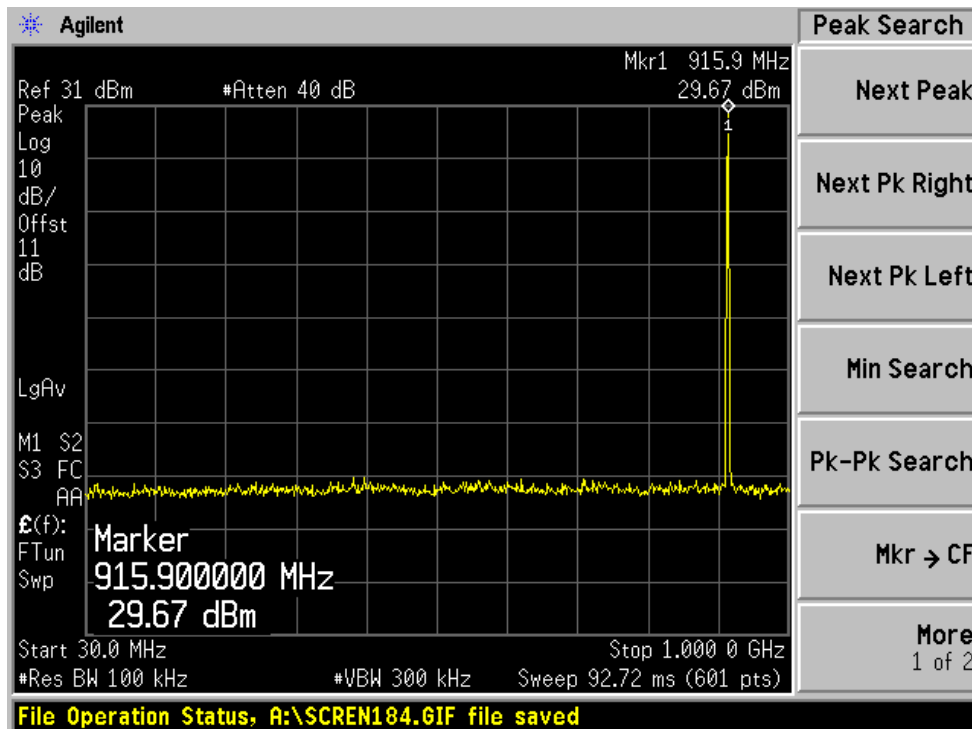

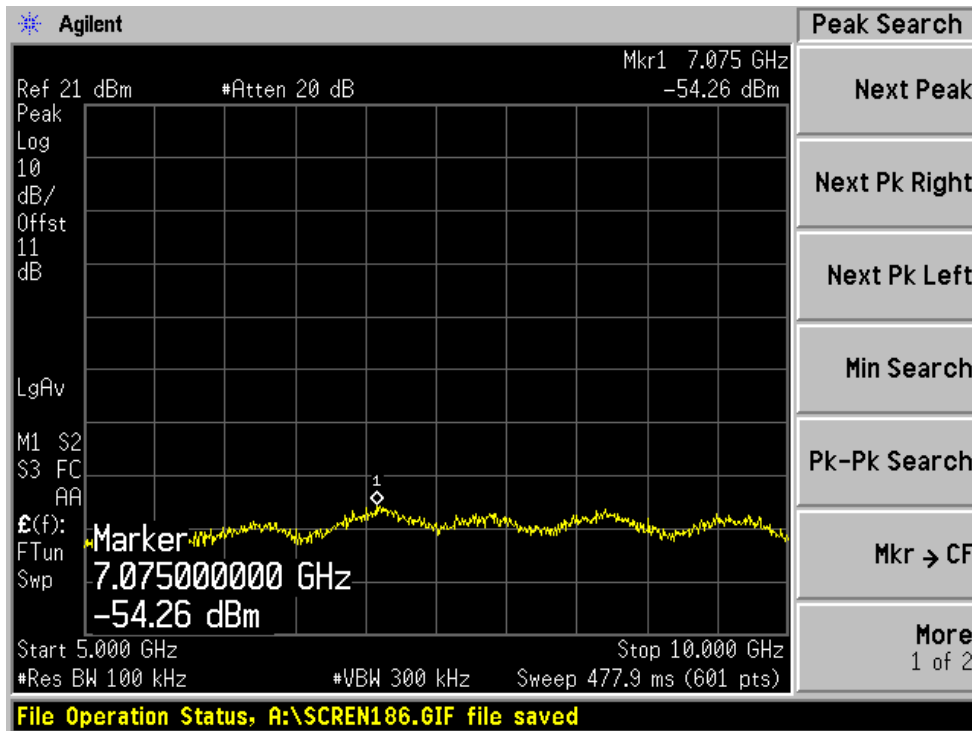
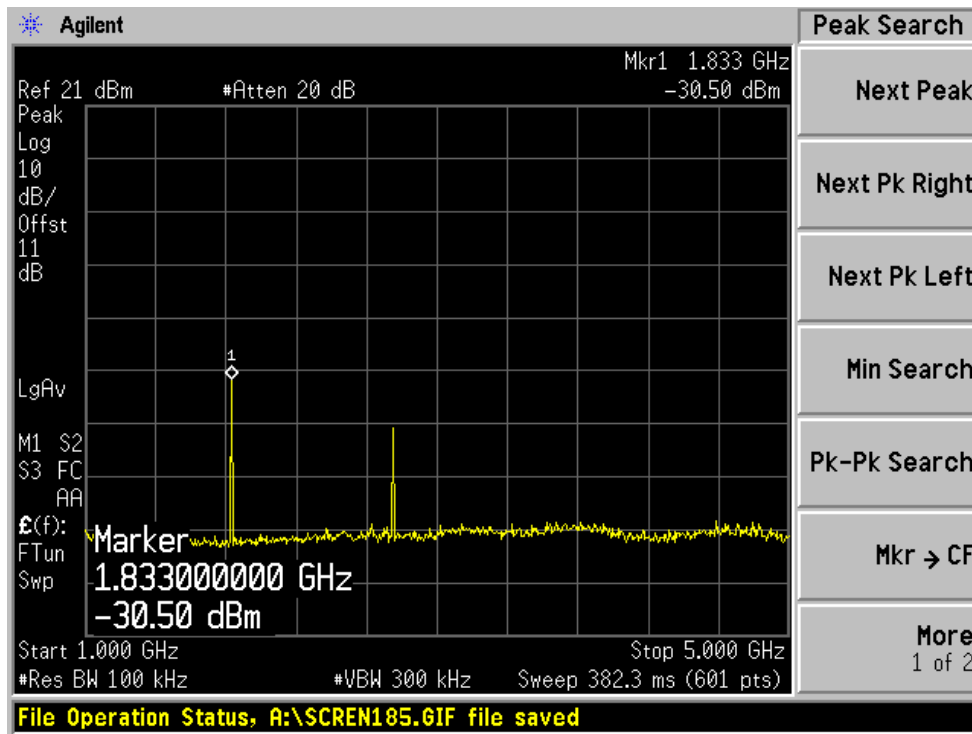

High Channel

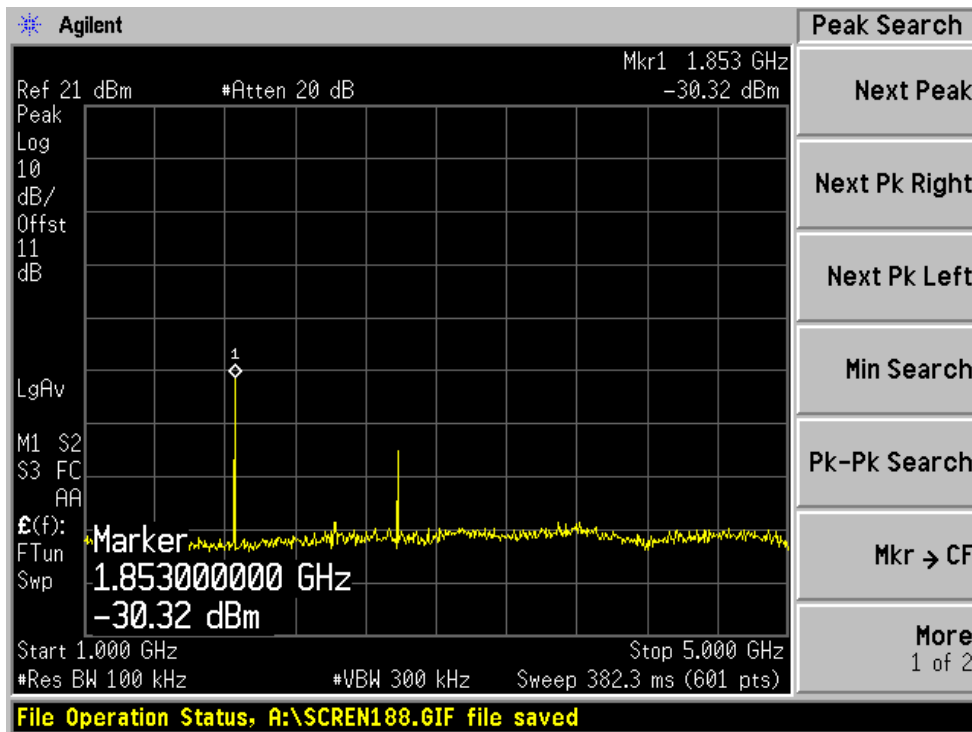
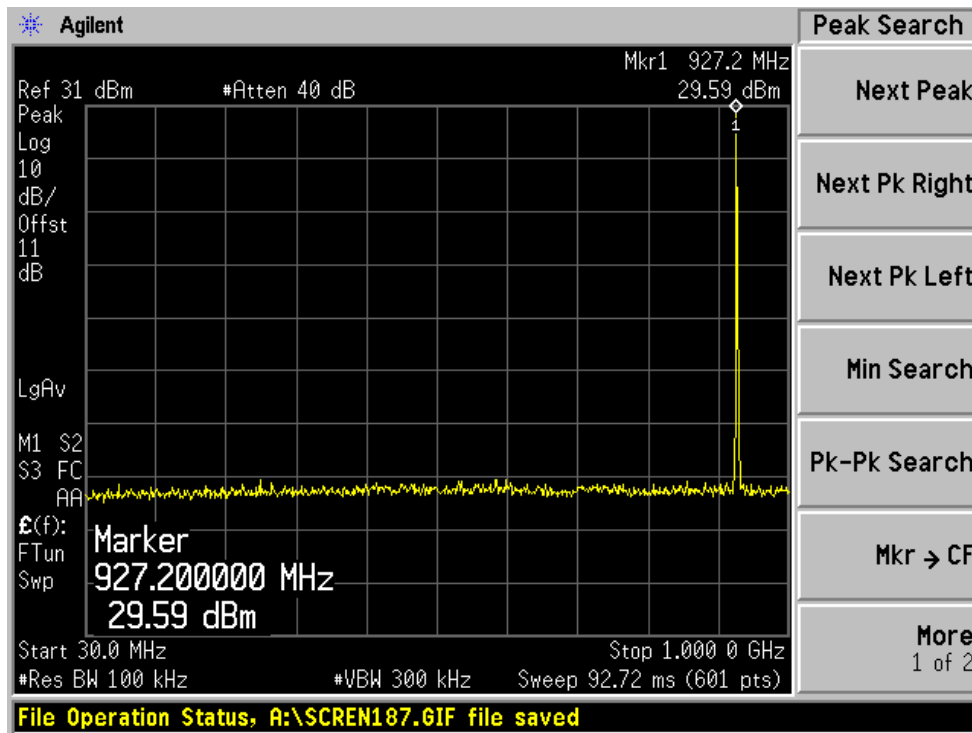

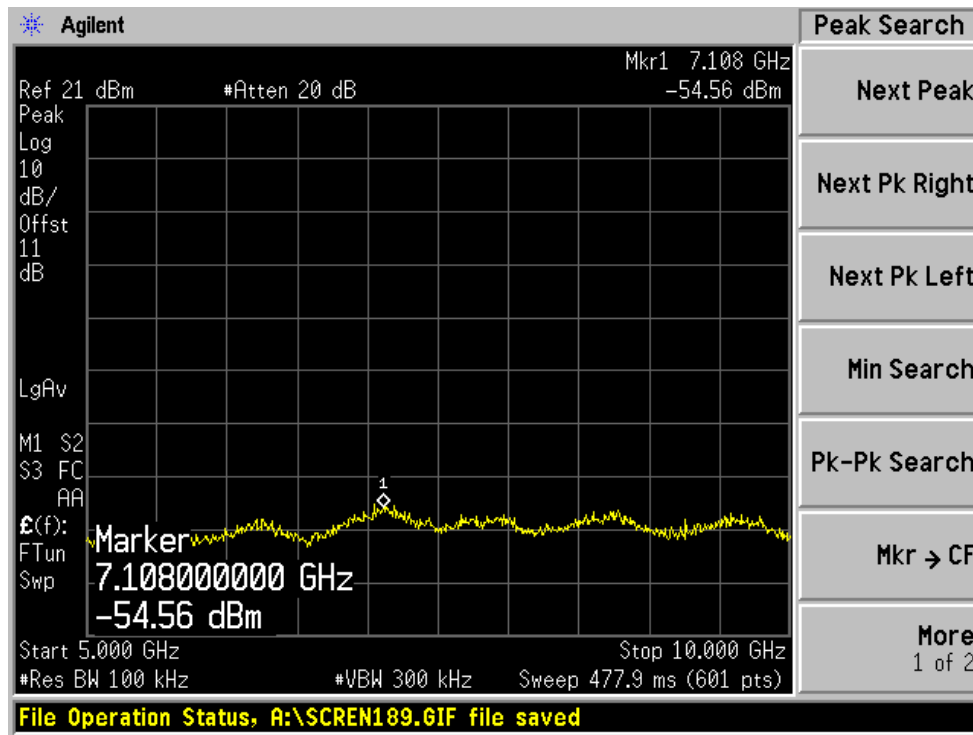

7 §15.247 (a) (1) - HOPPING CHANNEL SEPARATION

7.1 Applicable Standard

According to §15.247(a)(1), frequency hopping system shall have, hopping channel carrier frequencies separated by a minimum of 25 kHz or the 20 dB bandwidth of the hopping channel, whichever is greater. The system shall hop to channel frequencies that are selected at the system hopping rate from a pseudo randomly ordered list of hopping frequencies.

7.2 Measurement Procedure

1. Check the calibration of the measuring instrument (SA) using either an internal calibrator or a known signal from an external generator.
2. Position the EUT on a bench without connection to measurement instrument Turn on the EUT and connect it to measurement instrument. Then set it to any one convenient frequency within its operating range.
3. By using the Max-Hold function record the separation of two adjacent channels.
4. Measure the frequency difference of these two adjacent channels by SA MARK function, and then plot the result on SA screen.
5. Repeat above procedures until all frequencies measured were complete.

7.3 Test Equipment

| Manufacturer | Description | Model No. | Serial No. | Calibration Date |
|--------------|--------------------|-----------|------------|------------------|
| Agilent | Analyzer, Spectrum | E4446A | US44300386 | 2006-04-06 |

* **Statement of Traceability: BACL Corp.** attests that all calibrations have been performed per the NVLAP requirements, traceable to the NIST.

7.4 Test Setup Diagram

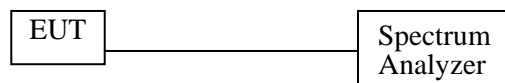

7.5 Environmental Conditions

| | |
|---------------------------|-----------|
| Temperature: | 25 °C |
| Relative Humidity: | 40 % |
| ATM Pressure: | 102.0 kPa |

*The testing was performed by James Ma on 2007-03-24.

7.6 Measurement Results

| Channel | Frequency (MHz) | Channel Separation (KHz) | Limit > 20 dB BW >(KHz) |
|---------|-----------------|--------------------------|-------------------------|
| Low | 902.625 | 510 | 411.28 |
| Mid | 915.365 | 510 | 407.72 |
| High | 927.585 | 500 | 402.59 |

Please refer to the following plots.

Low Channel

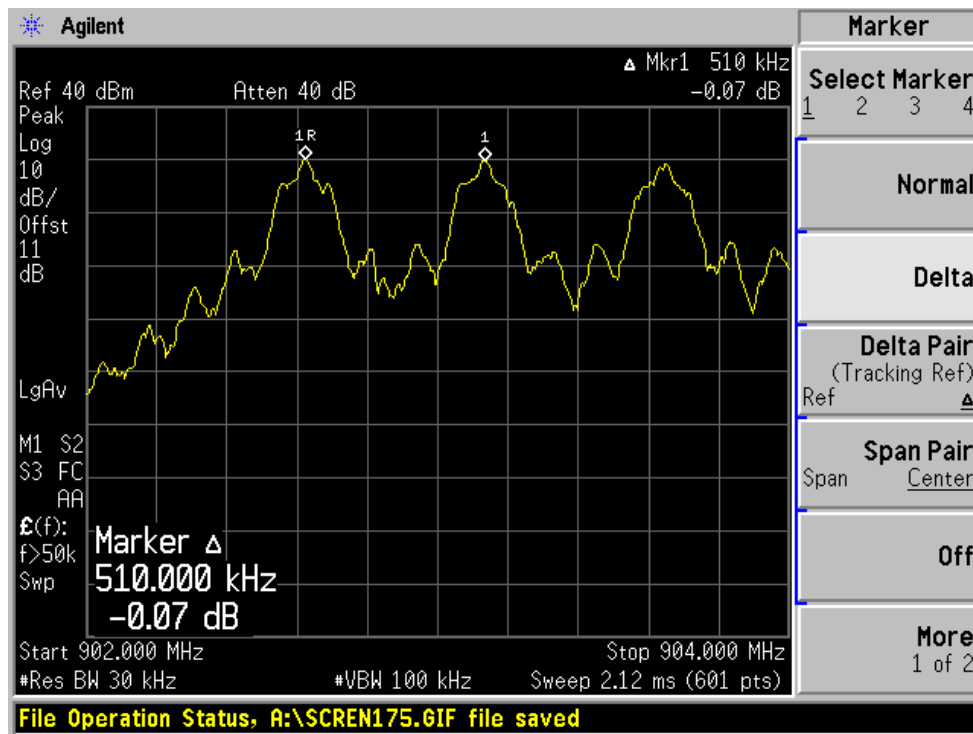

Middle Channel

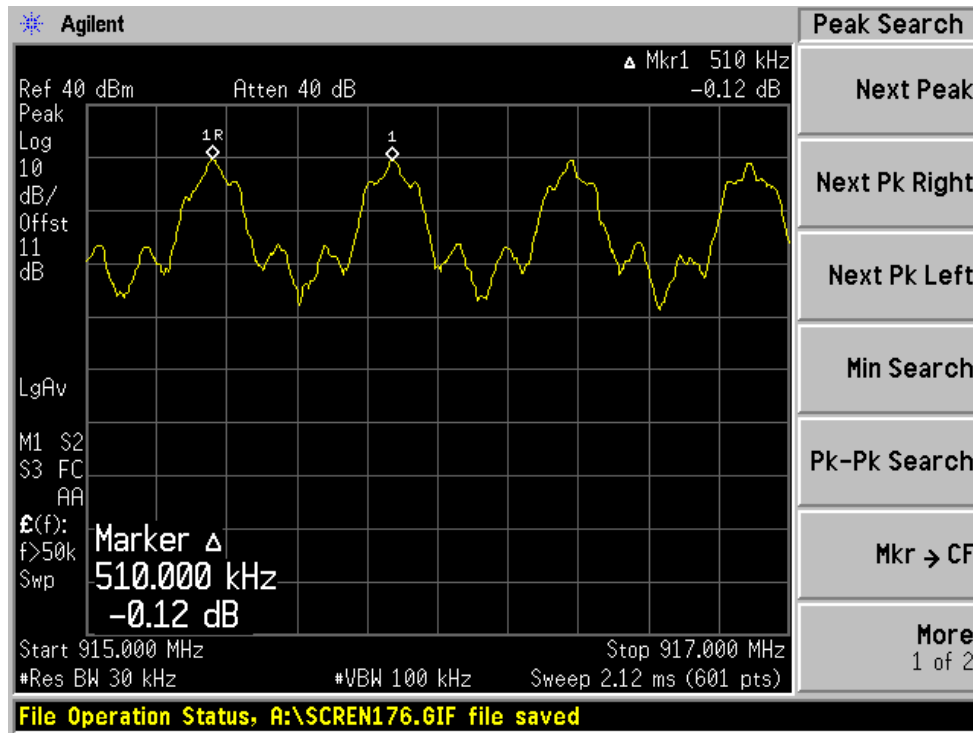

High Channel

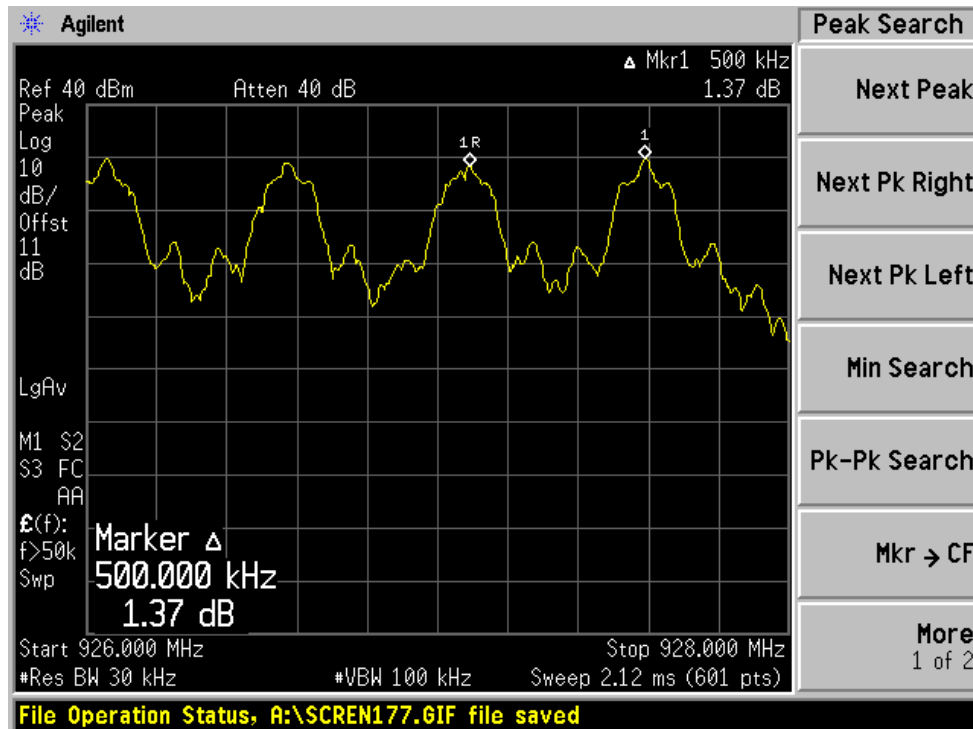

8 §15.247 (a) (1) – HOPPING CHANNEL BANDWIDTH

8.1 Standard Applicable

According to §15.247(a) (1), the maximum 20 dB bandwidth of the hopping channel shall be presented.

8.2 Measurement Procedure

1. Check the calibration of the measuring instrument using either an internal calibrator or a known signal from an external generator.
2. Position the EUT without connection to measurement instrument. Turn on the EUT and connect it to measurement instrument. Then set it to any one convenient frequency within its operating range. Set a reference level on the measuring instrument equal to the highest peak value.
3. Measure the frequency difference of two frequencies that were attenuated 20 dB from the reference level. Record the frequency difference as the emissions bandwidth.
4. Repeat above procedures until all frequencies measured were complete.

8.3 Test Equipment List and Details

| Manufacturer | Description | Model No. | Serial No. | Calibration Date |
|--------------|--------------------|-----------|------------|------------------|
| Agilent | Analyzer, Spectrum | E4446A | US44300386 | 2006-04-06 |

* **Statement of Traceability:** BACL Corp. attests that all calibrations have been performed per the NVLAP requirements, traceable to the NIST.

8.4 Test Setup Diagram

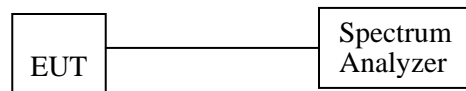

8.5 Environmental Conditions

| | |
|---------------------------|-----------|
| Temperature: | 25 °C |
| Relative Humidity: | 40 % |
| ATM Pressure: | 102.0 kPa |

*The testing was performed by James Ma on 2007-03-24.

8.6 Measurement Results

| Channel | Frequency (MHz) | 20 dB Channel Bandwidth (KHz) |
|---------|-----------------|-------------------------------|
| Low | 902.625 | 411.28 |
| Mid | 915.365 | 407.72 |
| High | 927.585 | 402.59 |

Please refer to the following plots.

8.7 Measurement Test Result

Low Channel

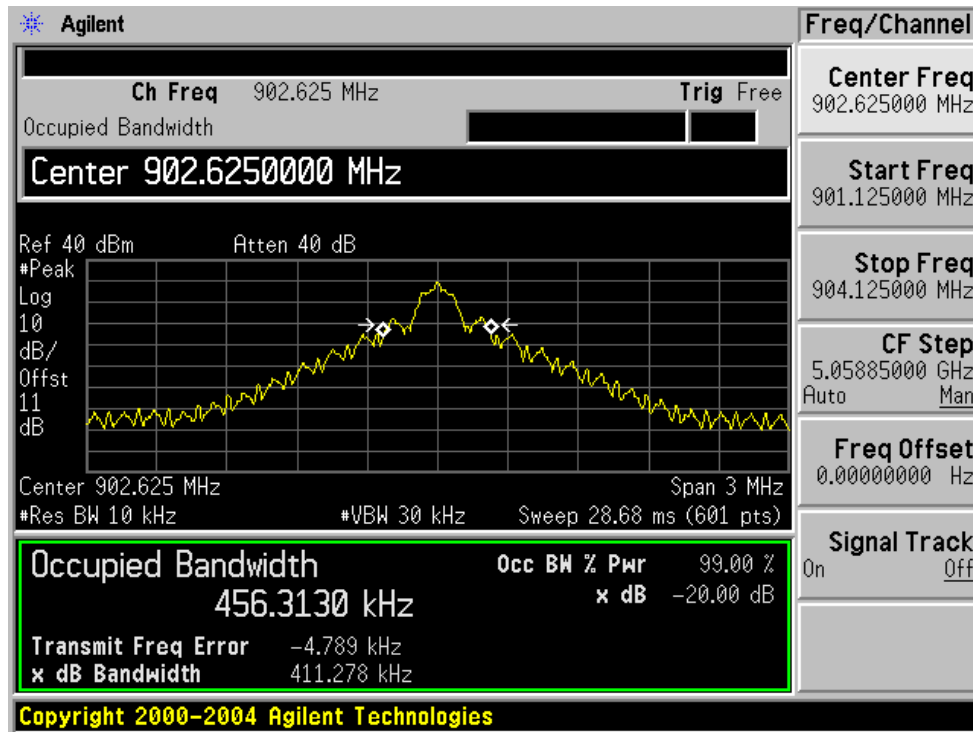

Middle Channel

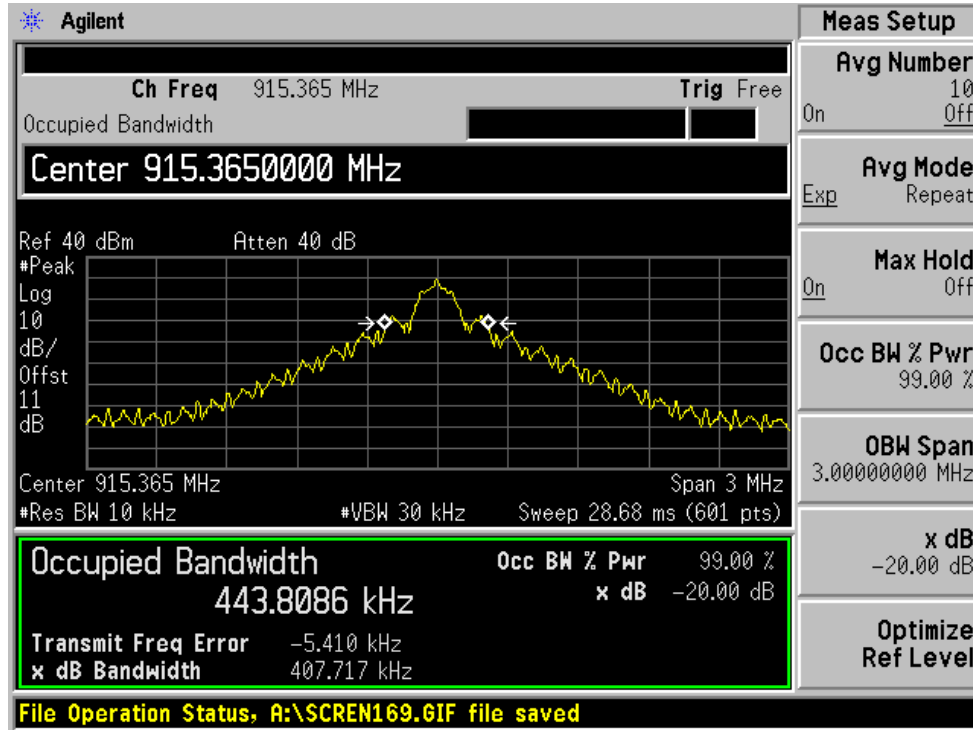

High Channel

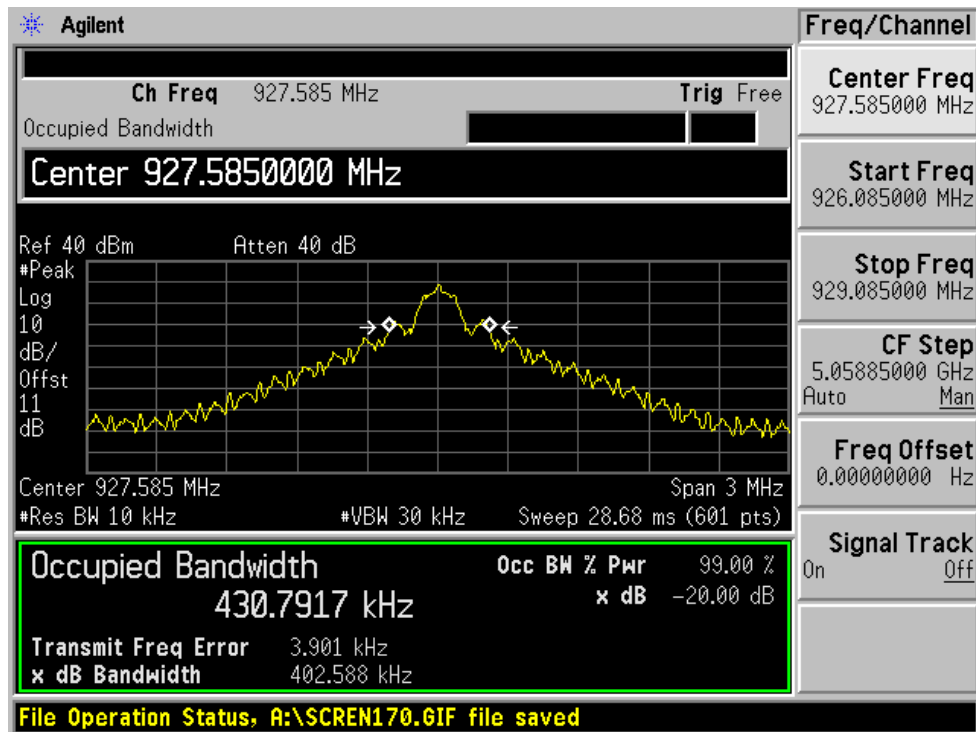

9 §15.247 (a) (1) (i) - NUMBER OF HOPPING FREQUENCIES USED

9.1 Standard Applicable

According to §15.247(a) (1)(i), For frequency hopping systems operating in the 902–928 MHz band: if the 20 dB bandwidth of the hopping channel is less than 250 kHz, the system shall use at least 50 hopping frequencies and the average time of occupancy on any frequency shall not be greater than 0.4 seconds within a 20 second period; if the 20 dB bandwidth of the hopping channel is 250 kHz or greater, the system shall use at least 25 hopping frequencies and the average time of occupancy on any frequency shall not be greater than 0.4 seconds within a 10 second period. The maximum allowed 20 dB bandwidth of the hopping channel is 500 kHz.

9.2 Measurement Procedure

1. Check the calibration of the measuring instrument (SA) using either an internal calibrator or a known signal from an external generator.
2. Position the EUT on the bench without connection to measurement instrument. Turn on the EUT and connect its antenna terminal to measurement instrument via a low loss cable. Then set it to any one measured frequency within its operating range, and make sure the instrument is operated in its linear range.
3. Set the SA on Max-Hold Mode, and then keep the EUT in hopping mode. Record all the signals from each channel until each one has been recorded.
4. Set the SA on View mode and then plot the result on SA screen.
5. Repeat above procedures until all frequencies measured were complete.

9.3 Test Equipment List and Details

| Manufacturer | Description | Model No. | Serial No. | Calibration Date |
|--------------|--------------------|-----------|------------|------------------|
| Agilent | Analyzer, Spectrum | E4446A | US44300386 | 2006-04-06 |

* **Statement of Traceability:** **BACL Corp.** attests that all calibrations have been performed per the NVLAP requirements, traceable to the NIST.

9.4 Test Setup Diagram

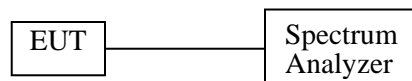

9.5 Environmental Conditions

| | |
|---------------------------|-----------|
| Temperature: | 25 °C |
| Relative Humidity: | 40 % |
| ATM Pressure: | 102.0 kPa |

*The testing was performed by James Ma on 2007-03-24.

9.6 Measurement Result

| Frequency Range (MHz) | Number of Hopping Channels | Limit |
|-----------------------|----------------------------|-------|
| 902.00-928.00 | 50 | >25 |

Please refer to the following plot:

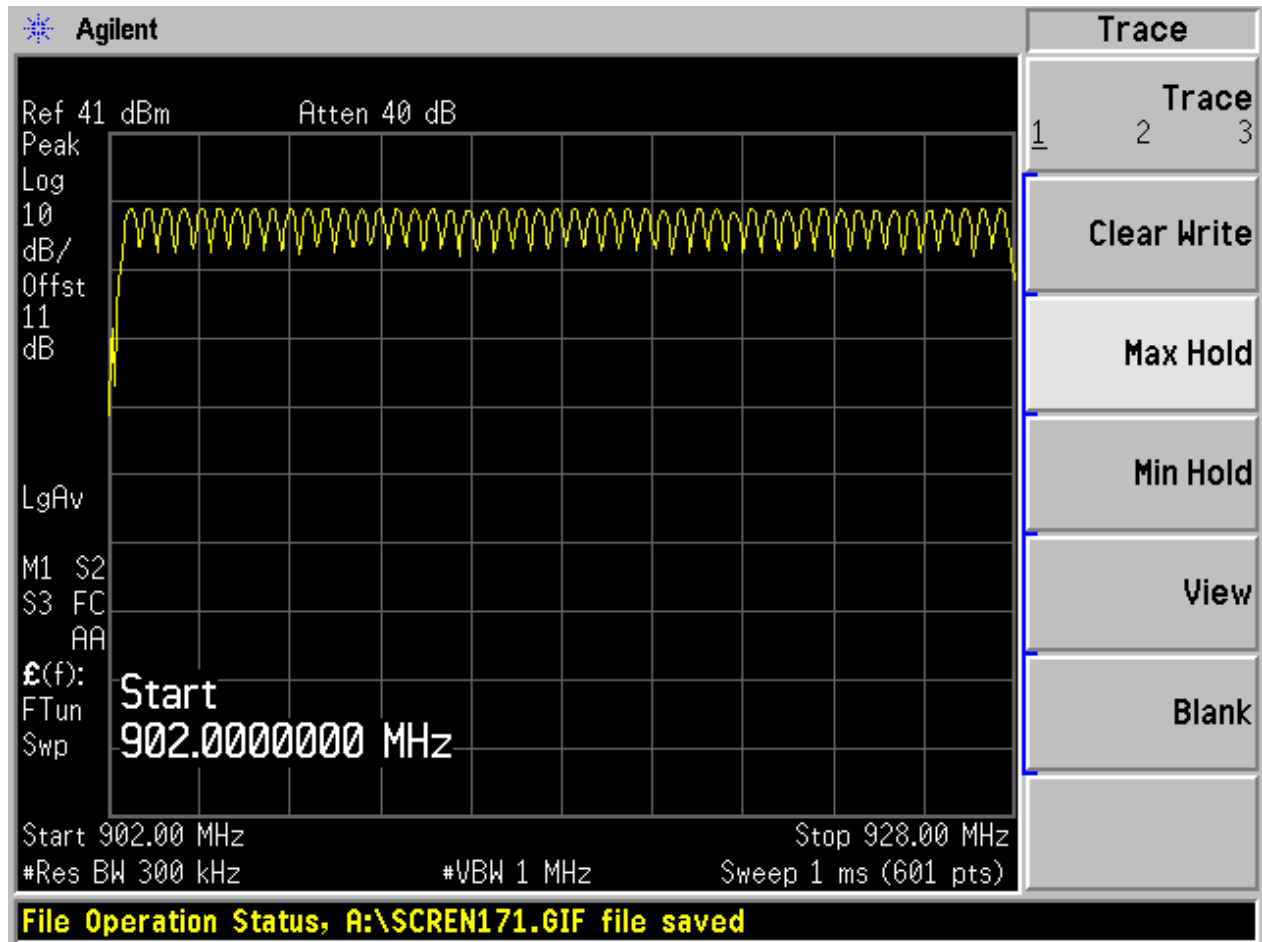

10 §15.247(a) (1) (i) - DWELL TIME

10.1 Applicable Standard

According to §15.247 (a)(1)(i), if the 20 dB bandwidth of the hopping channel is less than 250 kHz, the system shall use at least 50 hopping frequencies and the average time of occupancy on any frequency shall not be greater than 0.4 seconds within a 20 second period; if the 20 dB bandwidth of the hopping channel is 250 kHz or greater, the system shall use at least 25 hopping frequencies and the average time of occupancy on any frequency shall not be greater than 0.4 seconds within a 10 second period.

10.2 Measurement Procedure

1. Check the calibration of the measuring instrument using either an internal calibrator or a known signal from an external generator.
2. Position the EUT was set without connection to measurement instrument. Turn on the EUT and connect its antenna terminal to measurement instrument via a low loss cable. Then set it to any one measured frequency within its operating range, and make sure the instrument is operated in its linear range.
3. Adjust the center frequency of SA on any frequency be measured and set SA to zero span mode. And then, set RBW and VBW of spectrum analyzer to proper value.
4. Measure the time duration of one transmission on the measured frequency. And then plot the result with time difference of this time duration.
5. Repeat above procedures until all frequencies measured were complete.

10.3 Test Equipment List and Details

| Manufacturer | Description | Model No. | Serial No. | Calibration Date |
|--------------|--------------------|-----------|------------|------------------|
| Agilent | Analyzer, Spectrum | E4446A | US44300386 | 2006-04-06 |

* **Statement of Traceability: BACL Corp.** attests that all calibrations have been performed per the NVLAP requirements, traceable to the NIST.

10.4 Test Setup Diagram

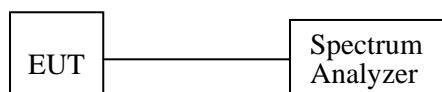

Environmental Conditions

| | |
|---------------------------|-----------|
| Temperature: | 25 °C |
| Relative Humidity: | 40 % |
| ATM Pressure: | 102.0 kPa |

*The testing was performed by James Ma on 2007-03-24.

10.5 Measurement Results

| Channel | Frequency (MHz) | Pulse Width (ms) | Pulse Quantity Per 20 Sec | Dwell Time (sec.) | Limit (Sec.) | Result |
|----------------|------------------------|-------------------------|----------------------------------|--------------------------|---------------------|---------------|
| Low | 902.625 | 46.67 | 1 | 0.0467 | 0.4 | Compliant |
| Mid | 915.365 | 47.00 | 3 | 0.1410 | 0.4 | Compliant |
| High | 927.585 | 46.33 | 1 | 0.0463 | 0.4 | Compliant |

Please refer the following plots.

Low Channel,

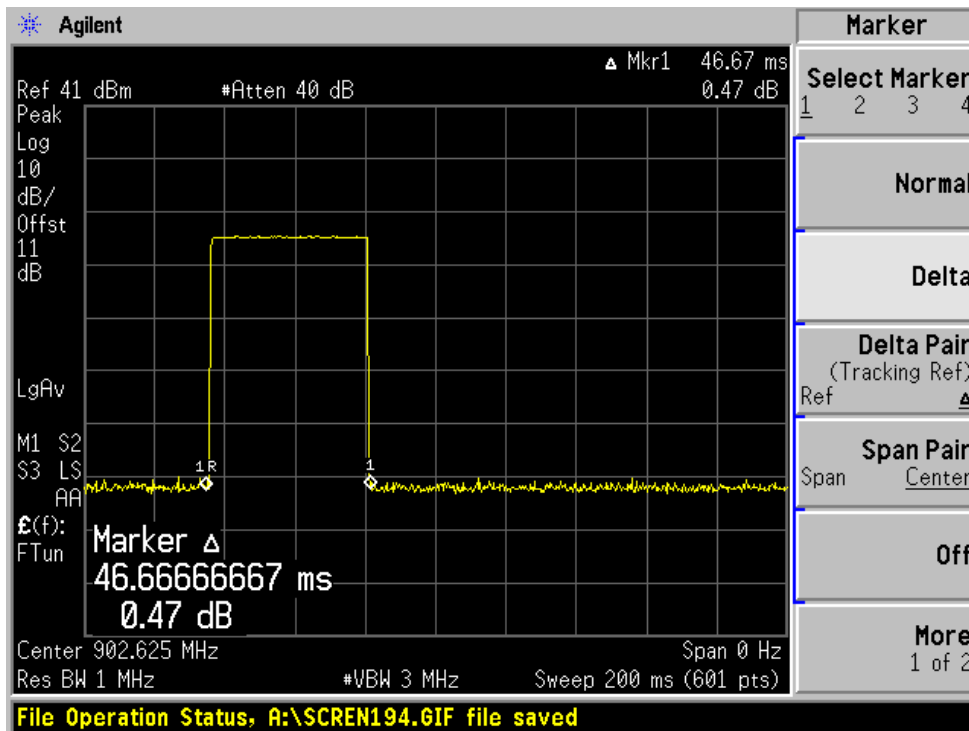
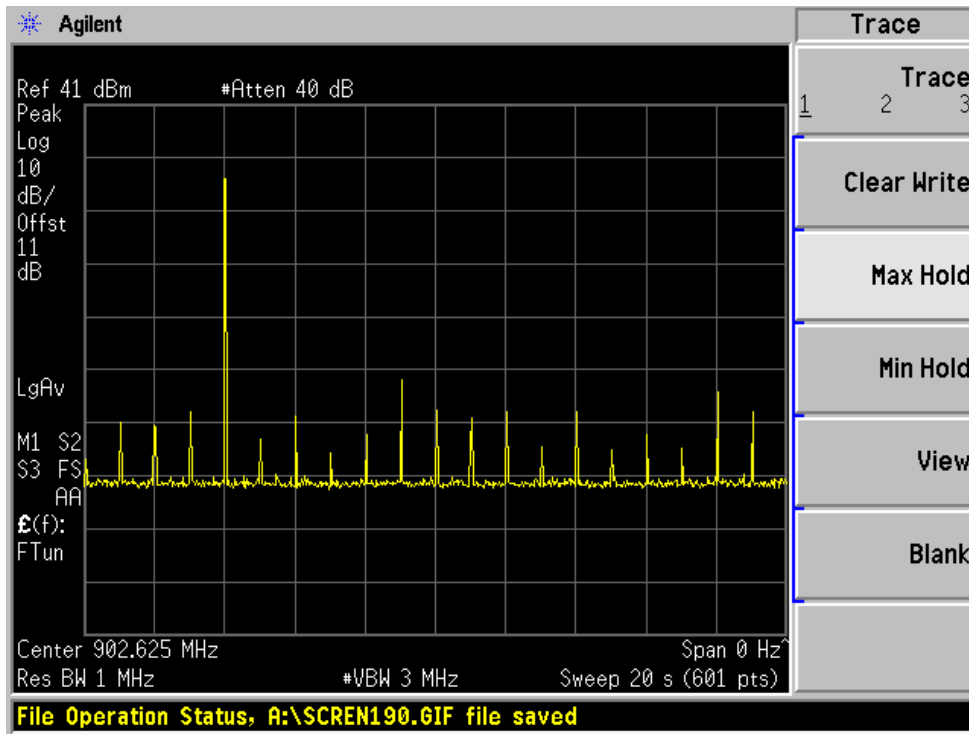

Middle Channel

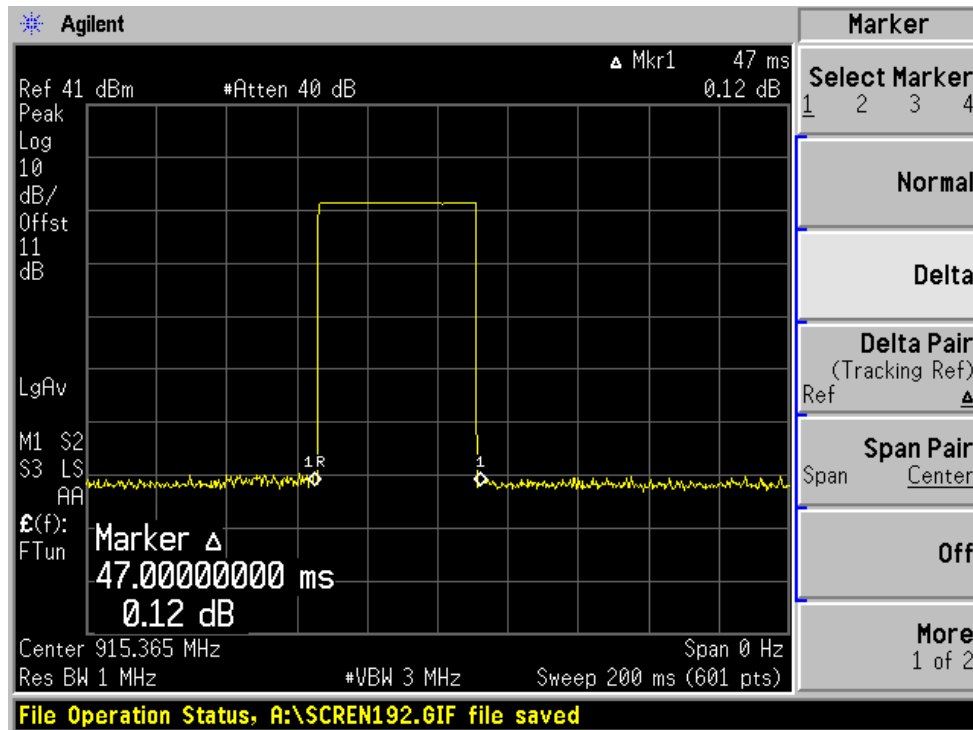
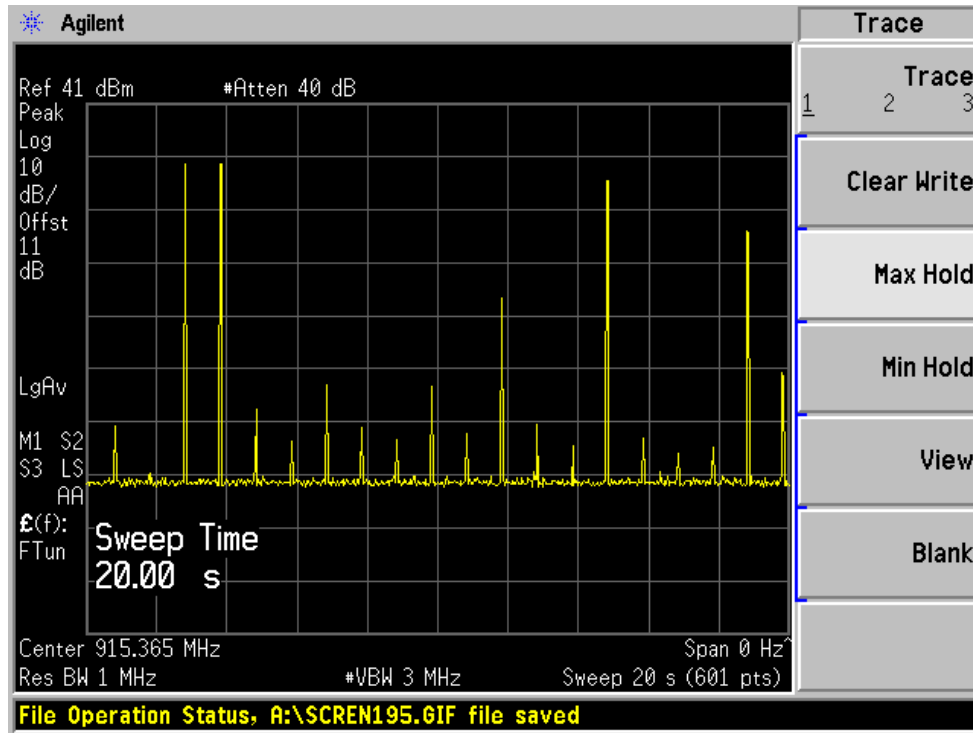

High Channel,

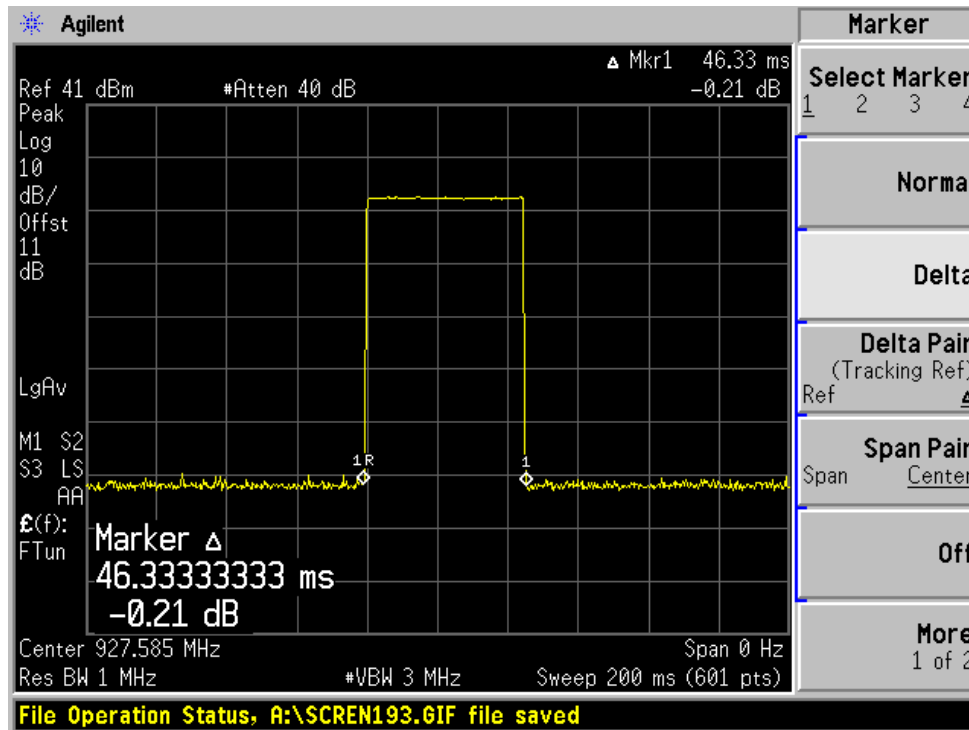
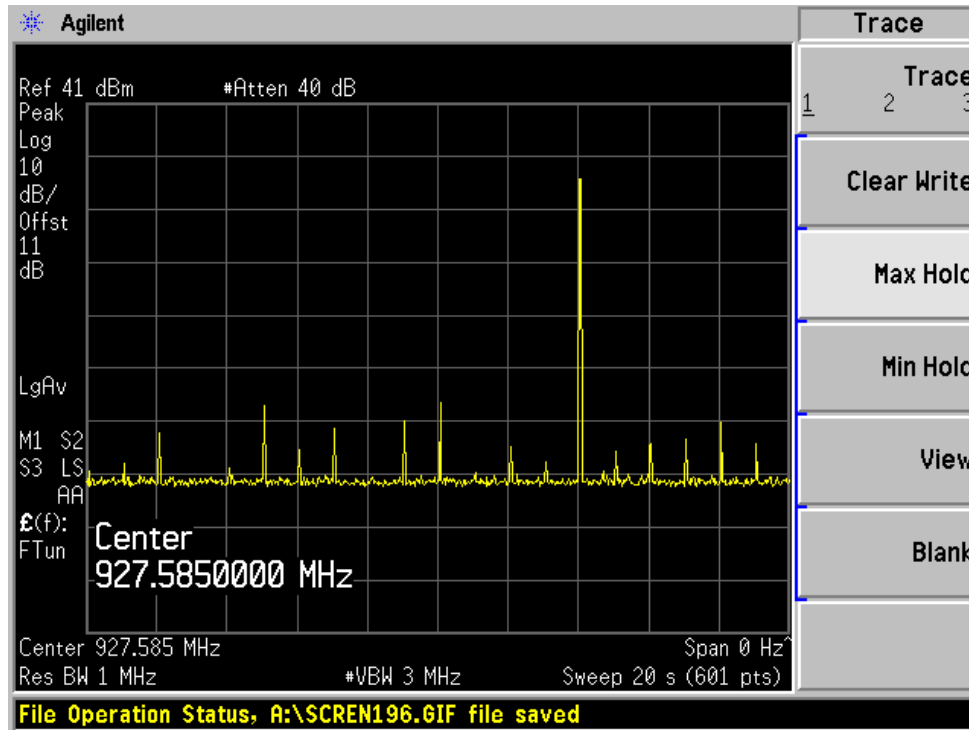

11 §15.247(B) (2) - MAXIMUM PEAK OUTPUT POWER

11.1 Standard Applicable

According to §15.247(b) (2), for frequency hopping systems operating in the 902–928 MHz band: 1 watt for systems employing at least 50 hopping channels; and, 0.25 watts for systems employing less than 50 hopping channels, but at least 25 hopping channels, as permitted under paragraph (a)(1)(i) of this section.

11.2 Measurement Procedure

1. Place the EUT on the turntable and set it in transmitting mode.
2. Remove the antenna from the EUT and then connect a low loss RF cable from the antenna port to the spectrum analyzer.

11.3 Test Equipment List and Details

| Manufacturer | Description | Model No. | Serial No. | Calibration Date |
|--------------|--------------------|-----------|------------|------------------|
| Agilent | Analyzer, Spectrum | E4446A | US44300386 | 2006-04-06 |

* **Statement of Traceability: BACL Corp.** attests that all calibrations have been performed per the NVLAP requirements, traceable to the NIST.

11.4 Test Setup Diagram

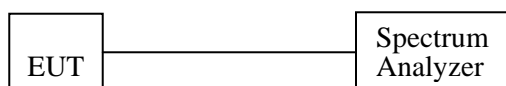

Environmental Conditions

| | |
|---------------------------|-----------|
| Temperature: | 25 °C |
| Relative Humidity: | 40 % |
| ATM Pressure: | 102.0 kPa |

*The testing was performed by James Ma on 2007-03-24.

11.5 Measurement Result

| Channel | Frequency (MHz) | Max Peak Output Power | | Limit (mw) | Result |
|---------|-----------------|-----------------------|--------|------------|-----------|
| | | (dBm) | (mw) | | |
| Low | 902.625 | 29.93 | 984.01 | 1000 | Compliant |
| Mid | 915.365 | 29.75 | 944.06 | 1000 | Compliant |
| High | 927.585 | 29.79 | 952.80 | 1000 | Compliant |

Please see the following plots:

Low Channel

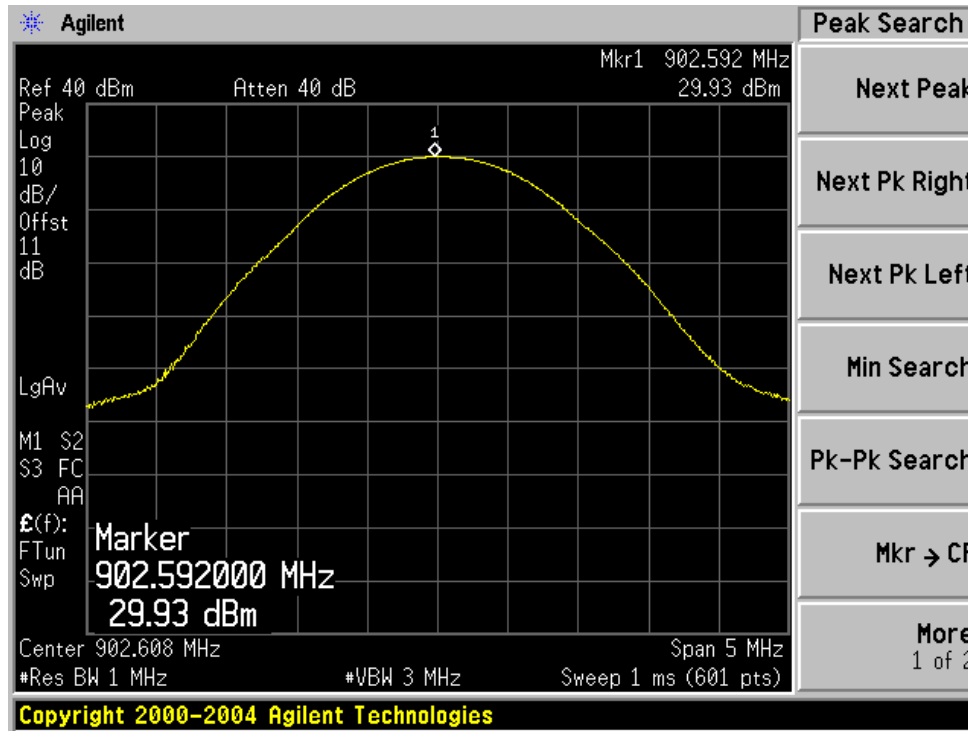

Middle Channel

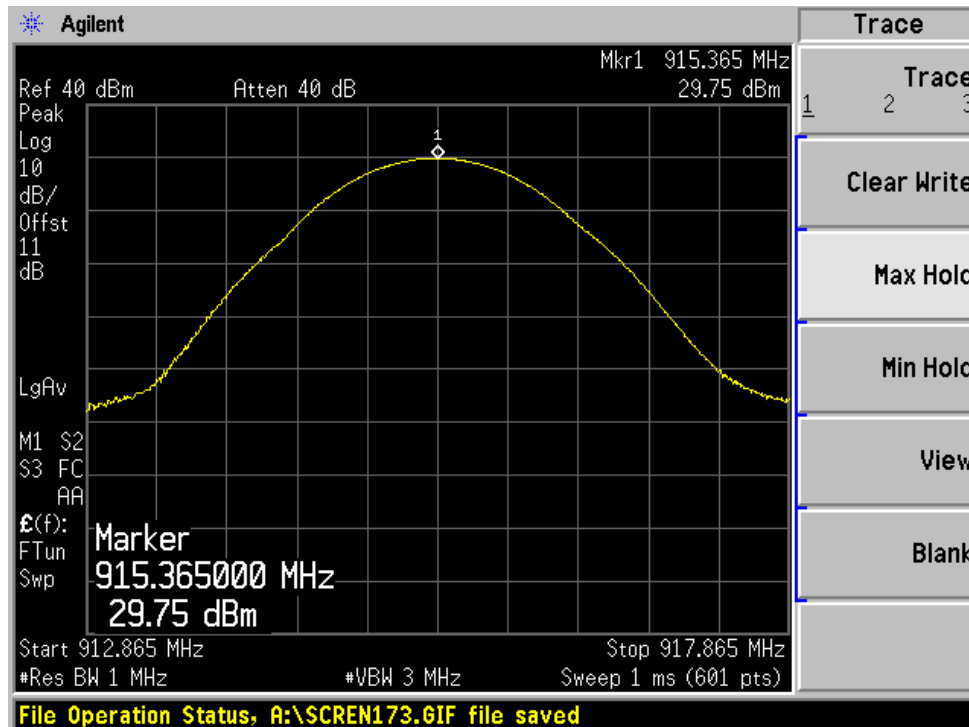

High Channel

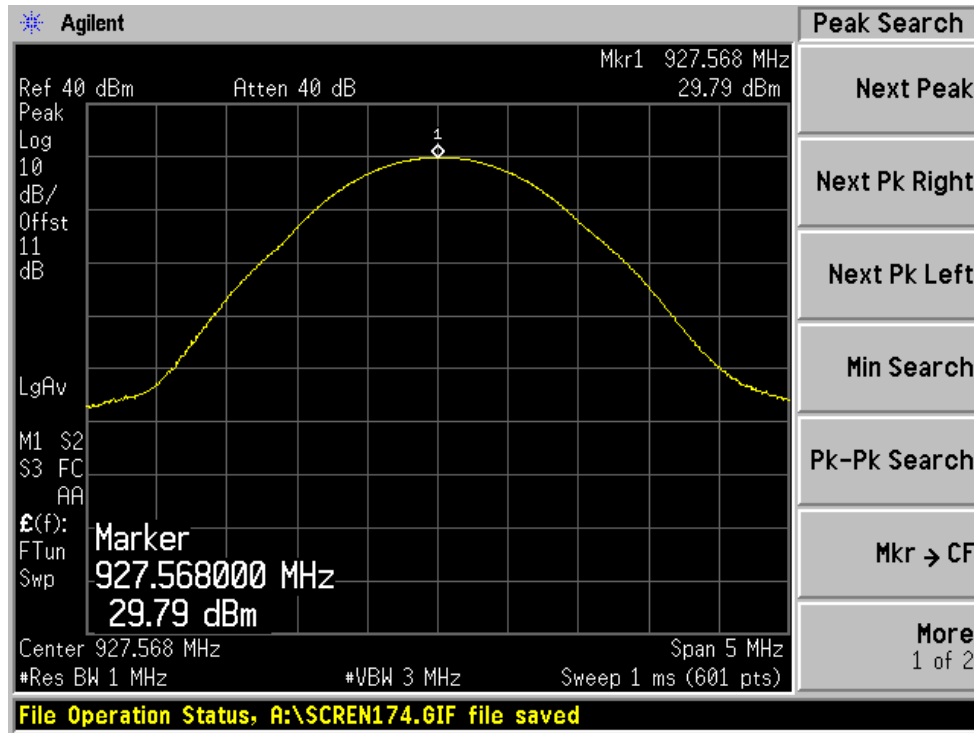

12 §15.247 (d) - 100 KHz BANDWIDTH OF BAND EDGES

12.1 Applicable Standard

According to §15.247(d), in any 100 kHz bandwidth outside the frequency band in which the spread spectrum intentional radiator is operating, the radio frequency power that is produced by the intentional radiator shall be at least 20 dB below that in the 100 kHz bandwidth within the band that contains the highest level of the desired power, based on either an RF conducted or a radiated measurement. Attenuation below the general limits specified in §15.209(a) is not required.

12.2 Measurement Procedure

1. Check the calibration of the measuring instrument using either an internal calibrator or a known signal from an external generator.
2. Position the EUT without connection to measurement instrument. Turn on the EUT and connect its antenna terminal to measurement instrument via a low loss cable. Then set it to any one measured frequency within its operating range, and make sure the instrument is operated in its linear range.
3. Set both RBW and VBW of spectrum analyzer to 100 kHz with a convenient frequency span including 100 kHz bandwidth from band edge.
4. Measure the highest amplitude appearing on spectral display and set it as a reference level. Plot the graph with marking the highest point and edge frequency.
5. Repeat above procedures until all measured frequencies were complete.

12.3 Test Equipment List and Details

| Manufacturer | Description | Model No. | Serial No. | Calibration Date |
|--------------|--------------------|-----------|------------|------------------|
| Agilent | Analyzer, Spectrum | E4446A | US44300386 | 2006-04-06 |

* **Statement of Traceability: BACL Corp.** attests that all calibrations have been performed per the NVLAP requirements, traceable to the NIST.

12.4 Test Setup Diagram

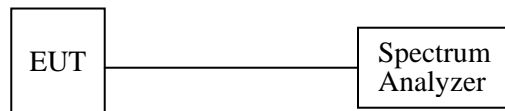

Environmental Conditions

| | |
|---------------------------|-----------|
| Temperature: | 25 °C |
| Relative Humidity: | 40 % |
| ATM Pressure: | 102.0 kPa |

*The testing was performed by James Ma on 2007-03-24.

Please refer to the following plots for results.

12.5 Plots of 100 KHz Bandwidth of Band Edge

Low Channel

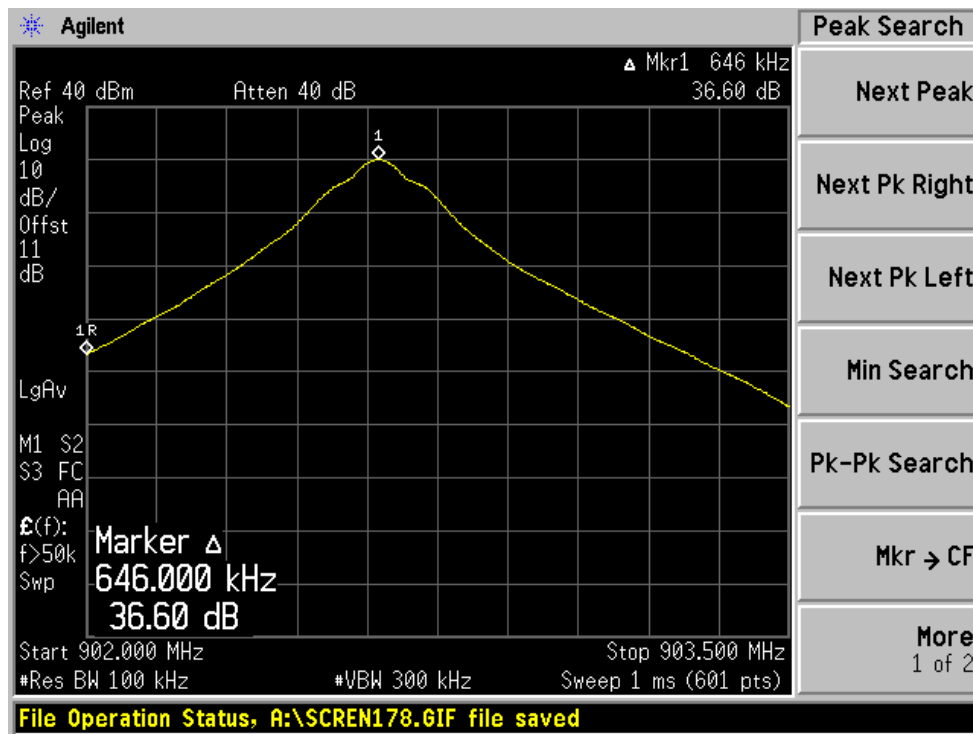

High Channel

