



FCC PART 90
TEST AND MEASUREMENT REPORT

For

Trimble Navigation Limited

510 DeGuigne Drive,
Sunnyvale, CA 94085, USA

FCC ID: KEAXDLM

Report Type: Original Report	Product type: UHF Transceiver Module
Test Engineer: <u>Quinn Jiang</u>	
Report Number: <u>R1105254-90</u>	
Report Date: <u>2012-03-09</u>	
Reviewed By: <u>RF/EMC Lead</u>	 Victor Zhang
Prepared By: (SP) Bay Area Compliance Laboratories Corp. 1274 Anvilwood Avenue, Sunnyvale, CA 94085, U.S.A. Tel: (408) 732-9162 Fax: (408) 732 9164	

Note: This test report is prepared for the customer shown above and for the device described herein. It may not be duplicated or used in part without prior written consent from Bay Area Compliance Laboratories Corp. This report **must not** be used by the customer to claim product certification, approval, or endorsement by NVLAP*, NIST, or any agency of the Federal Government.

* This report may contain data that are not covered by the NVLAP accreditation and are marked with an asterisk "*" 0002

TABLE OF CONTENTS

1. General Information.....	5
1.1 PRODUCT DESCRIPTION FOR EQUIPMENT UNDER TEST (EUT).....	5
1.2 MECHANICAL DESCRIPTION.....	5
1.3 OBJECTIVE.....	5
1.4 RELATED SUBMITTAL(S)/GRANT(S).....	5
1.5 TEST METHODOLOGY.....	6
1.6 MEASUREMENT UNCERTAINTY.....	6
1.7 TEST FACILITY.....	6
2 System Test Configuration.....	7
2.1 JUSTIFICATION.....	7
2.2 EUT EXERCISE SOFTWARE.....	7
2.3 EQUIPMENT MODIFICATIONS.....	7
2.4 INTERNAL CONFIGURATION.....	7
2.5 LOCAL SUPPORT EQUIPMENT.....	7
2.6 LOCAL SUPPORT EQUIPMENT POWER SUPPLY AND LINE FILTERS.....	7
2.7 EXTERNAL I/O CABLING LIST AND DETAILS.....	7
2.8 TEST SETUP BLOCK DIAGRAM.....	8
3 Summary of Test Results.....	10
4 FCC §2.1091 - RF Exposure Information.....	11
4.1 APPLICABLE STANDARDS.....	11
5 FCC §2.1046 & §90.205 – RF Output Power.....	13
5.1 APPLICABLE STANDARD.....	13
5.2 TEST PROCEDURE.....	13
5.3 TEST EQUIPMENT LIST AND DETAILS.....	13
5.4 TEST ENVIRONMENTAL CONDITIONS.....	13
5.5 TEST RESULT.....	13
6 FCC §2.1047 & §90.207 – Modulation Characteristic.....	14
6.1 APPLICABLE STANDARD.....	14
6.2 TEST RESULT.....	14
7 FCC §2.1049 & §90.210 – Occupied Bandwidth & Emission Mask.....	15
7.1 APPLICABLE STANDARD.....	15
7.2 TEST PROCEDURE.....	15
7.3 TEST EQUIPMENT LIST AND DETAILS.....	15
7.4 TEST ENVIRONMENTAL CONDITIONS.....	15
7.5 TEST RESULT.....	15
8 FCC §2.1051 & §90.210 - Spurious Emissions at Antenna Terminals.....	32
8.1 APPLICABLE STANDARD.....	32
8.2 TEST PROCEDURE.....	32
8.3 TEST EQUIPMENT LIST AND DETAILS.....	32
8.4 TEST ENVIRONMENTAL CONDITIONS.....	32
8.5 TEST RESULTS.....	32
9 FCC §2.1055 (d) & §90.213 - Frequency Stability.....	35
9.1 APPLICABLE STANDARD.....	35
9.2 TEST PROCEDURE.....	35

9.3	TEST EQUIPMENT LIST AND DETAILS.....	36
9.4	TEST ENVIRONMENTAL CONDITIONS.....	36
9.5	TEST RESULTS	36
10	FCC §2.1053 & §90.210 – Field Strength of Spurious Radiation	38
10.1	APPLICABLE STANDARD	38
10.2	TEST PROCEDURE	38
10.3	TEST ENVIRONMENTAL CONDITIONS.....	38
10.4	TEST EQUIPMENT LIST AND DETAILS.....	38
10.5	TEST RESULTS	39
11	FCC §90.214 - Transient Frequency Behavior.....	40
11.1	APPLICABLE STANDARD	40
11.2	TEST PROCEDURE	40
11.3	TEST EQUIPMENT LIST AND DETAILS.....	41
11.4	TEST ENVIRONMENTAL CONDITIONS.....	41
11.5	TEST RESULTS	41
12	FCC Labeling Requirements	44
12.1	FCC ID LABEL REQUIREMENT	44
12.2	FCC ID LABEL CONTENTS.....	44
12.3	FCC ID LABEL LOCATION	45
13	Exhibit B - Test Setup Photographs	46
13.1	RADIATED EMISSION – FRONT VIEW (X ORIENTATION).....	46
13.2	RADIATED EMISSION BELOW 1 GHZ – REAR VIEW (X ORIENTATION)	46
13.3	RADIATED EMISSION ABOVE 1 GHZ – REAR VIEW (X ORIENTATION).....	47
13.4	RADIATED EMISSION – FRONT VIEW (Y ORIENTATION).....	47
13.5	RADIATED EMISSION BELOW 1 GHZ – REAR VIEW (Y ORIENTATION)	48
13.6	RADIATED EMISSION ABOVE 1 GHZ – REAR VIEW (Y ORIENTATION).....	48
13.7	RADIATED EMISSION – FRONT VIEW (Z ORIENTATION)	49
13.8	RADIATED EMISSION BELOW 1 GHZ – REAR VIEW (Z ORIENTATION).....	49
13.9	RADIATED EMISSION ABOVE 1 GHZ – REAR VIEW (Z ORIENTATION).....	50
13.10	ANTENNA PORT CONDUCTED EMISSION VIEW	50
14	Exhibit C - EUT Photographs.....	51
14.1	EUT – TOP VIEW	51
14.2	EUT – BOTTOM VIEW.....	51
14.3	EUT – SIDE VIEW (1).....	52
14.4	EUT – SIDE VIEW (2).....	52
14.5	TEST SUPPORTING HOST VIEW	53
14.6	TEST SUPPORTING HOST PORT VIEW (1).....	53
14.7	TEST SUPPORTING HOST PORT VIEW (2).....	54
14.8	EUT BUILT INTO THE SUPPORTING HOST VIEW.....	54
14.9	EUT COVER OFF VIEW (1).....	55
14.10	EUT COVER OFF VIEW (2).....	55
14.11	TEST SUPPORTING HOST PCB BOARD TOP VIEW	56
14.12	TEST SUPPORTING HOST PCB BOARD BOTTOM VIEW	56
15	Appendix I – Declaration of Similarity	57

DOCUMENT REVISION HISTORY

Revision Number	Report Number	Description of Revision	Date of Revision
0	R1105254-90	Original Report	2012-03-09

1. General Information

1.1 Product Description for Equipment under Test (EUT)

This test and measurement report was prepared on behalf *Trimble Navigation Ltd* and their product, FCC ID: KEAXDLM, model: XDLM-0, which will henceforth be referred to as the EUT (Equipment Under Test). The EUT is a UHF transceiver module operates in 403-407 MHz.

The EUTs are UHF Transceivers that operates under FCC Part 90

Specifications	
Frequency Bands	403-406 MHz 406.1-430 MHz 430-473 MHz
Modulation Type	GMSK, 4FSK
Emission Designator	F1D
RF Output Power	Low: 0.5 Watt High: 2 Watts
Channel Spacing	12.5 kHz
Dual Power Supply	3.6 V

1.2 Mechanical Description

The EUT measures approximately 6.98 cm (L) x 4.66 cm (W) x 0.8 cm (H) and weighs approximately 40g.

The test data gathered are from production sample, serial number: 1413007219, provided by the manufacturer.

1.3 Objective

This type approval report is prepared on behalf of *Trimble Navigation Ltd* in accordance Part 90 of the Federal Communication Commissions rules.

The objective was to determine the RF output power, Occupied Bandwidth, Spurious Emissions, Frequency Stability and Transient Frequency Behavior are in compliance with the FCC rules.

1.4 Related Submittal(s)/Grant(s)

None.

1.5 Test Methodology

All tests and measurements indicated in this document were performed in accordance with the Code of federal Regulations Title 47 Part 2, Sub-part J as well as the following individual parts:

Part 90 – Private Land Mobile Radio Service

Applicable Standards: TIA603-C and ANSI 63.4-2003, American National Standard for Method of Measurement of Radio-Noise Emissions from Low-Voltage Electrical and Electronic Equipment in the range of 9 kHz to 40 GHz.

All emissions measurement was performed by Bay Area Compliance Laboratories Corp. The radiated testing was performed at an antenna-to-EUT distance of 3 meters.

1.6 Measurement Uncertainty

All measurements involve certain levels of uncertainties, especially in the field of EMC. The factors contributing to uncertainties are spectrum analyzer, cable loss, antenna factor calibration, antenna directivity, antenna factor variation with height, antenna phase center variation, antenna factor frequency interpolation, measurement distance variation, site imperfections, mismatch (average), and system repeatability.

Based on CISPR16-4-2: 2003, The Treatment of Uncertainty in EMC Measurements, the values ranging from +2.0 dB for Conducted Emissions tests and +4.0 dB for Radiated Emissions tests are the most accurate estimates pertaining to uncertainty of EMC measurements at BACL Corp.

1.7 Test Facility

The test site used by BACL Corp. to collect radiated and conducted emissions measurement data is located at its facility in Sunnyvale, California, USA.

The test site at BACL Corp. has been fully described in reports submitted to the Federal Communication Commission (FCC) and Voluntary Control Council for Interference (VCCI). The details of these reports have been found to be in compliance with the requirements of Section 2.948 of the FCC Rules on February 11 and December 10, 1997, and Article 8 of the VCCI regulations on December 25, 1997. The test site also complies with the test methods and procedures set forth in CISPR 22:2008 §10.4 for measurements below 1 GHz and §10.6 for measurements above 1 GHz as well as ANSI C63.4-2003, ANSI C63.4-2009, TIA/EIA-603 & CISPR 24:2010.

The Federal Communications Commission and Voluntary Control Council for Interference have the reports on file and they are listed under FCC registration number: 90464 and VCCI Registration No.: R-3729, C-4176, G-469, and T-1206. The test site has been approved by the FCC and VCCI for public use and is listed in the FCC Public Access Link (PAL) database.

Additionally, BACL Corp. is a National Institute of Standards and Technology (NIST) accredited laboratory under the National Voluntary Laboratory Accredited Program (Lab Code 200167-0). The current scope of accreditations can be found at <http://ts.nist.gov/Standards/scopes/2001670.htm>

2 System Test Configuration

2.1 Justification

The EUT was configured for testing according to TIA/EIA-603-C.

The EUT was tested in the normal (native) operating mode to represent *worst*-case results during the final qualification test.

2.2 EUT Exercise Software

The software used, MicroCONF Version V1.01.0011 and Blade Editor Version: 1.01 Build: 0011, provided by client and was verified by BACL (Quinn Jiang) to comply with the standard requirements being tested against.

2.3 Equipment Modifications

No modifications were made to the EUT.

2.4 Internal Configuration

Manufacturers	Descriptions	Models	Serial Numbers
RF Module	Pacific Crest	70954-00G9	1413007232
Support PCB	Pacific Crest	81149-B	181096-INTJ

2.5 Local Support Equipment

Manufacturer	Description	Model No.	Serial No.
Dell	Laptop	Latitude D620	G66NNC1

2.6 Local Support Equipment Power Supply and Line Filters

Manufacturer	Description	Model	Serial Number
Agilent	DC Power Supply	E3630A	-

2.7 External I/O Cabling List and Details

Cable Description	Length (m)	From	To
Serial cable	< 1.0	Laptop Serial port	EUT Serial Port

2.8 Test Setup Block Diagram

Radiated Emission Test

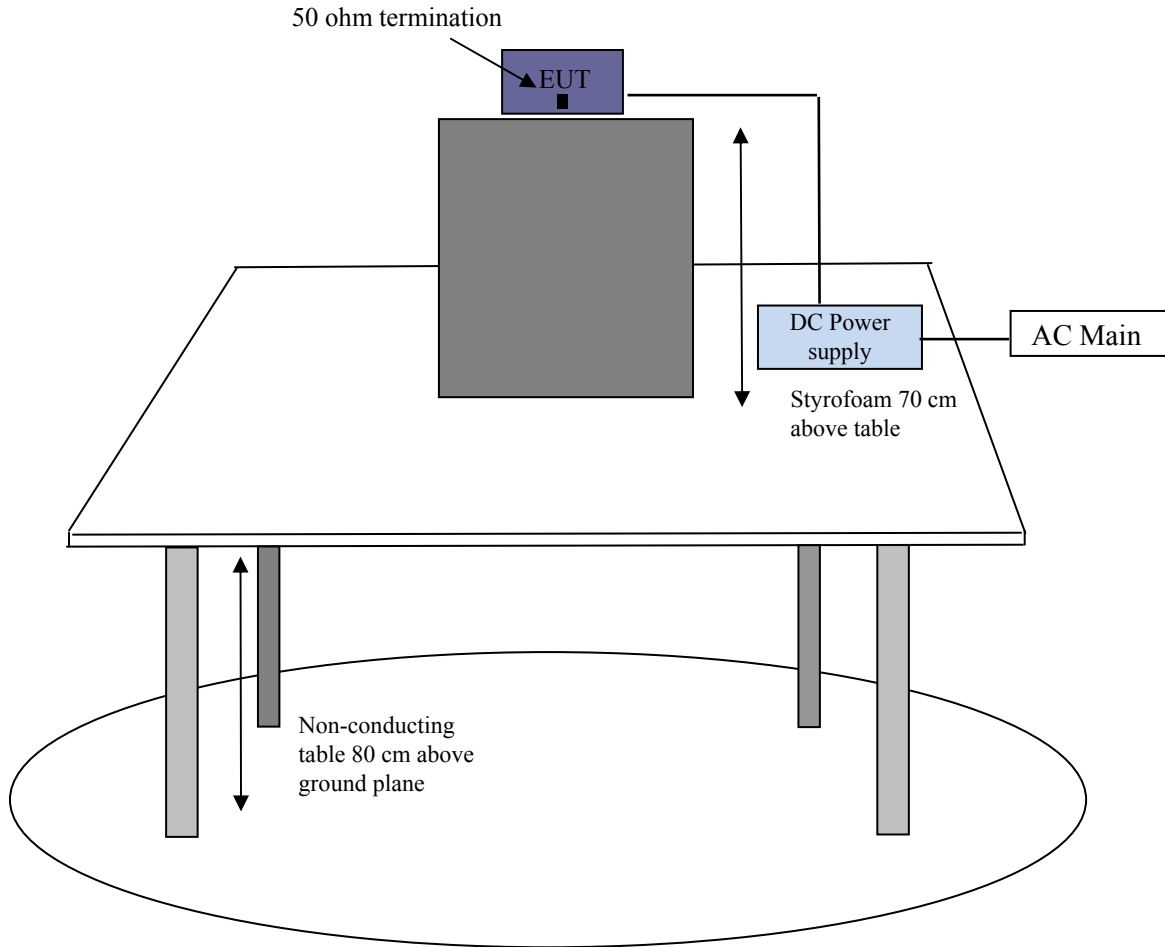

Antenna Port Conducted Emission Test

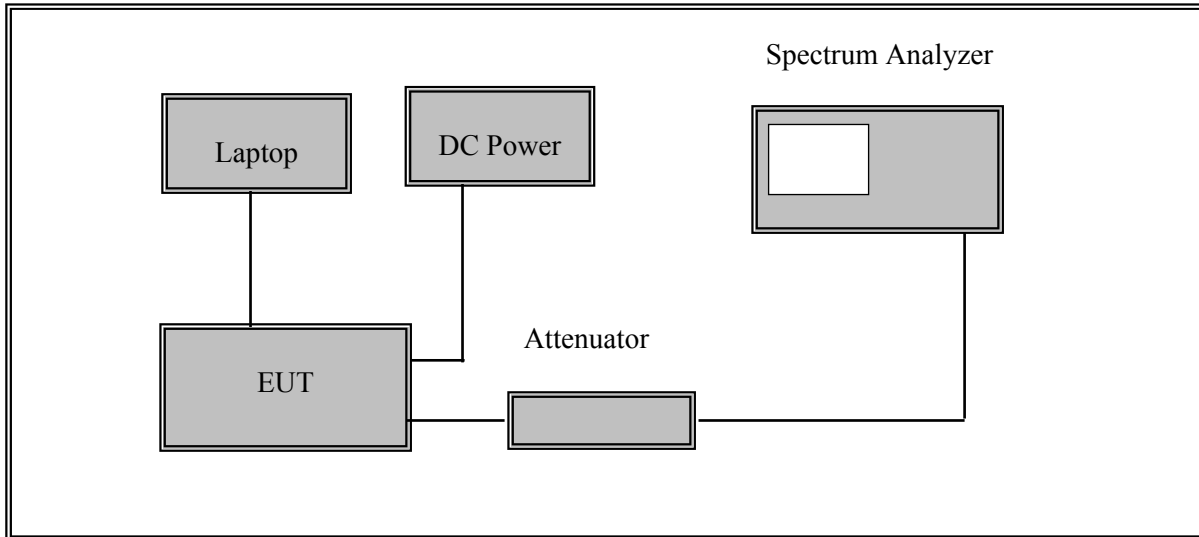

3 Summary of Test Results

FCC Rules	Description of Tests	Results
§1.1310, §2.1091	RF Exposure	Compliant
§2.1046, §90.205	RF Output Power	Compliant
§2.1047, §90.207	Modulation Characteristics, Audio Frequency Response and Audio Filter Response	N/A*
§2.1049, §90.209	Occupied Bandwidth and Emission Mask	Compliant
§2.1051, §90.210	Spurious Emissions at Antenna Terminals	Compliant
§2.1055, §90.213	Frequency Stability	Compliant
§2.1053, §90.210	Field Strength of Spurious Radiation	Compliant
§90.214	Transient Frequency Behavior	Compliant

Note: N/A*, modulation characteristic is not required for digital modulator

4 FCC §2.1091 - RF Exposure Information

4.1 Applicable Standards

FCC §2.1091, (a) Requirements of this section are a consequence of Commission responsibilities under the National Environmental Policy Act to evaluate the environmental significance of its actions. See subpart I of part 1 of this chapter, in particular §1.1307(b).

Limits for Exposure

Frequency Range (MHz)	Electric Field Strength (V/m)	Magnetic Field Strength (A/m)	Power Density (mW/cm ²)	Averaging Time (minutes)
(A) Limits for Occupational/Controlled Exposures				
0.3-3.0	614	1.63	*(100)	6
3.0-30	1842/f	4.89/f	*(900/f ²)	6
30-300	61.4	0.163	1.0	6
300-1500	/	/	f/300	6
1500-100,000	/	/	1	6
(B) Limits for General Population/Uncontrolled Exposure				
0.3-1.34	614	1.63	*(100)	30
1.34-30	842/f	2.19/f	*(180/f ²)	30
30-300	27.5	0.073	0.2	30
300-1500	/	/	f/1500	30
1500-100,000	/	/	1	30

f = frequency in MHz

* = Plane-wave equivalent power density

MPE Prediction

Predication of MPE limit at a given distance, Equation from OET Bulletin 65, Edition 97-01

$$S = PG/4\pi R^2$$

Where: *S* = power density

P = power input to antenna

G = power gain of the antenna in the direction of interest relative to an isotropic radiator

R = distance to the center of radiation of the antenna

403-430 MHz

Maximum peak output power at antenna input terminal (dBm): 33.06

Maximum peak output power at antenna input terminal (mW): 2023

Prediction distance (cm): 45

Prediction frequency (MHz): 429.95

Maximum Antenna Gain, typical (dBi): 5

Maximum Antenna Gain (numeric): 3.16

Power density of prediction frequency at 45 cm (mW/cm²): 0.2514

MPE limit for uncontrolled exposure at prediction frequency (mW/cm²): 0.2866

430-473 MHz

<u>Maximum peak output power at antenna input terminal (dBm):</u>	<u>32.94</u>
<u>Maximum peak output power at antenna input terminal (mW):</u>	<u>1967.886</u>
<u>Prediction distance (cm):</u>	<u>45</u>
<u>Prediction frequency (MHz):</u>	<u>459.075</u>
<u>Maximum Antenna Gain, typical (dBi):</u>	<u>5</u>
<u>Maximum Antenna Gain (numeric):</u>	<u>3.16</u>
<u>Power density of prediction frequency at 45 cm (mW/cm²):</u>	<u>0.2445</u>
<u>MPE limit for uncontrolled exposure at prediction frequency (mW/cm²):</u>	<u>0.30605</u>

Conclusion

The device complies with the MPE requirements by providing a safe separation distance of at least 45 cm between the antenna with maximum 5.0 dBi gain, including any radiating structure, and any persons when normally operated.

5 FCC §2.1046 & §90.205 – RF Output Power

5.1 Applicable Standard

According to FCC §2.1046, and §90.205, 421–430 MHz. Limitations on power and antenna heights are specified in §90.279. 450–470 MHz. (1) The maximum allowable station effective radiated power (ERP) is dependent upon the station's antenna HAAT and required service area and will be authorized in accordance with table 2.

5.2 Test Procedure

The RF output of the transmitter was connected to the input of the spectrum analyzer through sufficient attenuation.

5.3 Test Equipment List and Details

Manufacturer	Description	Model	Serial Number	Calibration Date
Agilent	Spectrum Analyzer	E4440A	US45303156	2010-08-09

Statement of Traceability: BACL Corp. attests that all calibrations have been performed per the NVLAP requirements, traceable to the NIST.

5.4 Test Environmental Conditions

Temperature:	20-25 °C
Relative Humidity:	44-55 %
ATM Pressure:	101-102 kPa

The testing was performed by Jack Liu on 2011-06-03 to 2011-06-10 in the RF Site.

5.5 Test Result

Test Mode: Transmitting

Bands (MHz)	Frequency (MHz)	Low Output Power (dBm)	Low Output Power (Watt)	High Output Power (dBm)	High Output Power (Watt)
403~430 MHz	403.05	27.10	0.513	31.86	1.535
	412.95	26.96	0.497	32.28	1.690
	429.95	27.05	0.507	33.06	2.023
430~473 MHz	430.05	26.87	0.486	32.43	1.750
	459.075	27.42	0.552	32.94	1.968
	472.95	26.95	0.495	31.18	1.312

6 FCC §2.1047 & §90.207 – Modulation Characteristic

6.1 Applicable Standard

FCC §2.1047 & §90.207:

- (a) Equipment which utilizes voice modulated communication shall show the frequency response of the audio modulating circuit over a range of 100 to 5000 Hz. for equipment which is required to have a low pass filter, the frequency response of the filter, or all of the circuitry installed between the modulation limited and the modulated stage shall be supplied.
- (b) Equipment which employs modulation limiting, a curve showing the percentage of modulation versus the modulation input voltage shall be supplied.

6.2 Test Result

N/A, modulation characteristic is not required for digital modulation

7 FCC §2.1049 & §90.210 – Occupied Bandwidth & Emission Mask

7.1 Applicable Standard

According to FCC §90.210: *Emission Mask D—12.5 kHz channel bandwidth equipment*. For transmitters designed to operate with a 12.5 kHz channel bandwidth, any emission must be attenuated below the power (P) of the highest emission contained within the authorized bandwidth as follows:

- (1) On any frequency from the center of the authorized bandwidth f_0 to 5.625 kHz removed from f_0 : Zero dB.
- (2) On any frequency removed from the center of the authorized bandwidth by a displacement frequency (f_d in kHz) of more than 5.625 kHz but no more than 12.5 kHz: At least $7.27(f_d - 2.88 \text{ kHz})$ dB.
- (3) On any frequency removed from the center of the authorized bandwidth by a displacement frequency (f_d in kHz) of more than 12.5 kHz: At least $50 + 10 \log(P)$ dB or 70 dB, whichever is the lesser attenuation.

7.2 Test Procedure

The RF output of the transmitter was connected to the input of the spectrum analyzer through sufficient attenuation.

The resolution bandwidth of the spectrum analyzer was set at 100 Hz and the spectrum was recorded in the frequency band ± 50 KHz from the carrier frequency.

7.3 Test Equipment List and Details

Manufacturer	Description	Model	Serial Number	Calibration Date
Agilent	Spectrum Analyzer	E4440A	US45303156	2010-08-09
HP	RF Communication test set	8920A	3438A05338	2010-05-18'

Note¹: 2-year calibration cycle

Statement of Traceability: BACL Corp. attests that all calibrations have been performed per the NVLAP requirements, traceable to the NIST.

7.4 Test Environmental Conditions

Temperature:	20-25 °C
Relative Humidity:	44-55 %
ATM Pressure:	101-102 kPa

The testing was performed by Jack Liu on 2011-06-03 to 2011-06-10 in the RF Site.

7.5 Test Result

Please refer to the hereinafter plots.

Occupied Bandwidth

High Power Level, Modulation: 4FSK, Data Rate: 9600 bps

12.5 kHz Channel Space, Middle Channel – 412.95 MHz

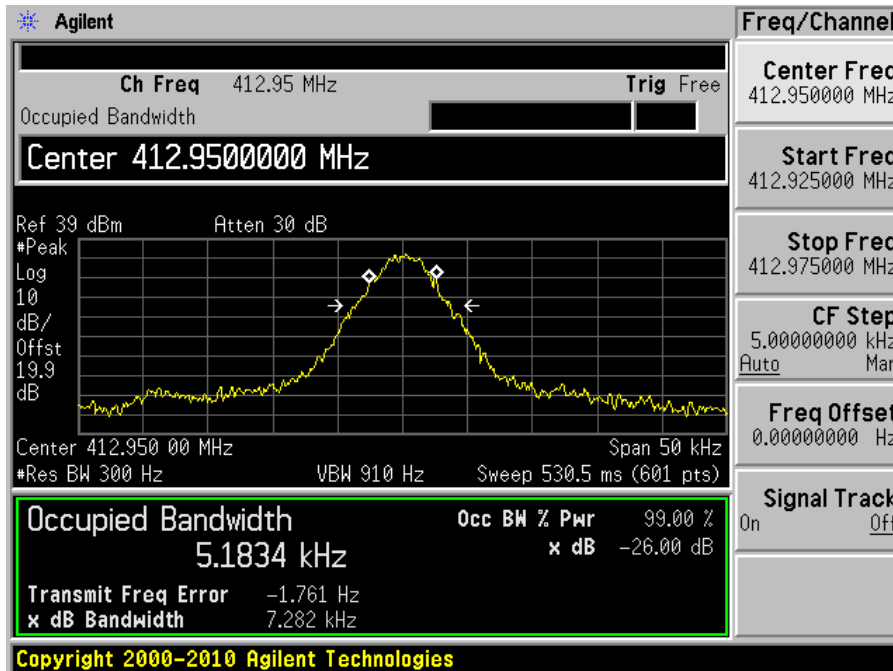

High Power Level, Modulation: GMSK, Data Rate: 4800 bps

12.5 kHz Channel Space, Middle Channel – 412.95 MHz

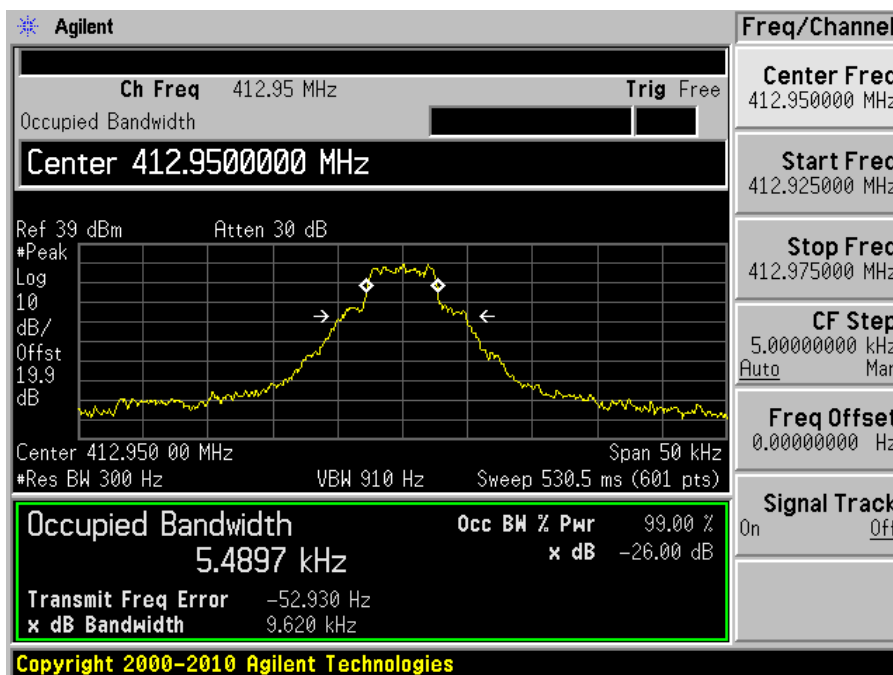

High Power Level, Modulation: GMSK, Data Rate: 8000 bps
 12.5 kHz Channel Space, Middle Channel – 412.95 MHz

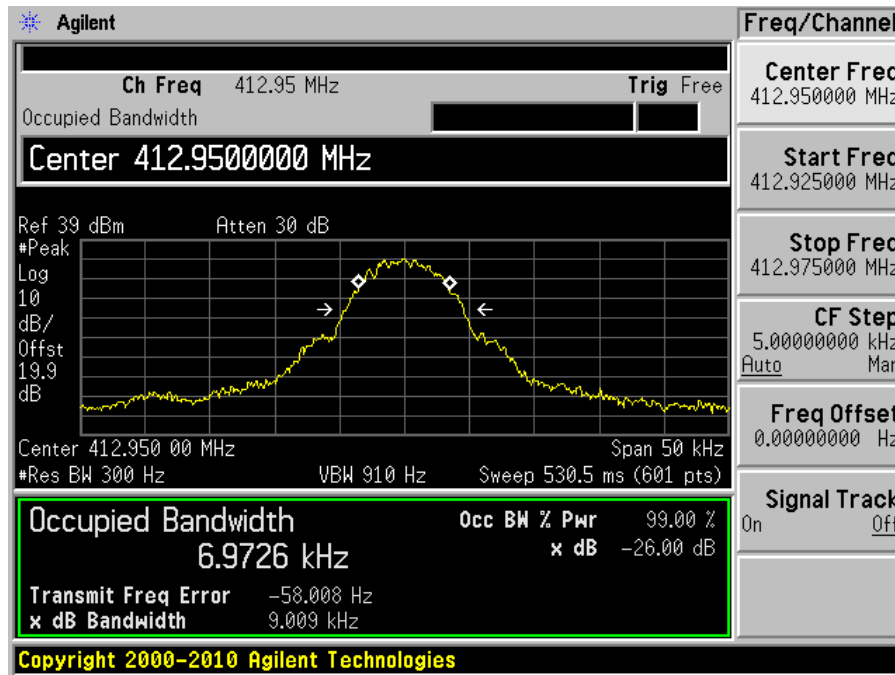

High Power Level, Modulation: GMSK, Data Rate: 9600 bps
 12.5 kHz Channel Space, Middle Channel – 412.95 MHz

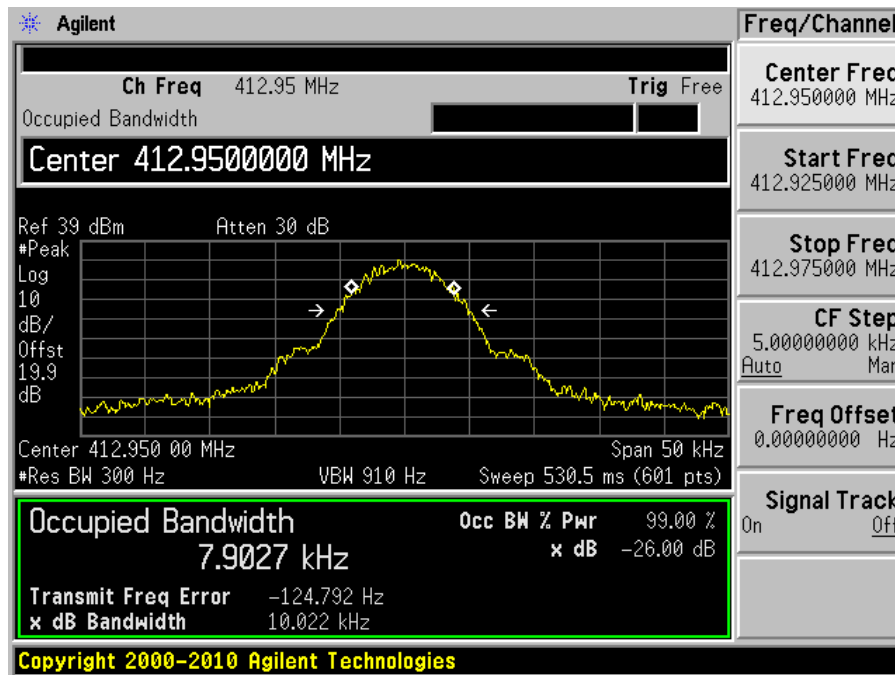

High Power Level, Modulation: 4FSK, Data Rate: 9600 bps
 12.5 kHz Channel Space, Middle Channel – 459.075 MHz

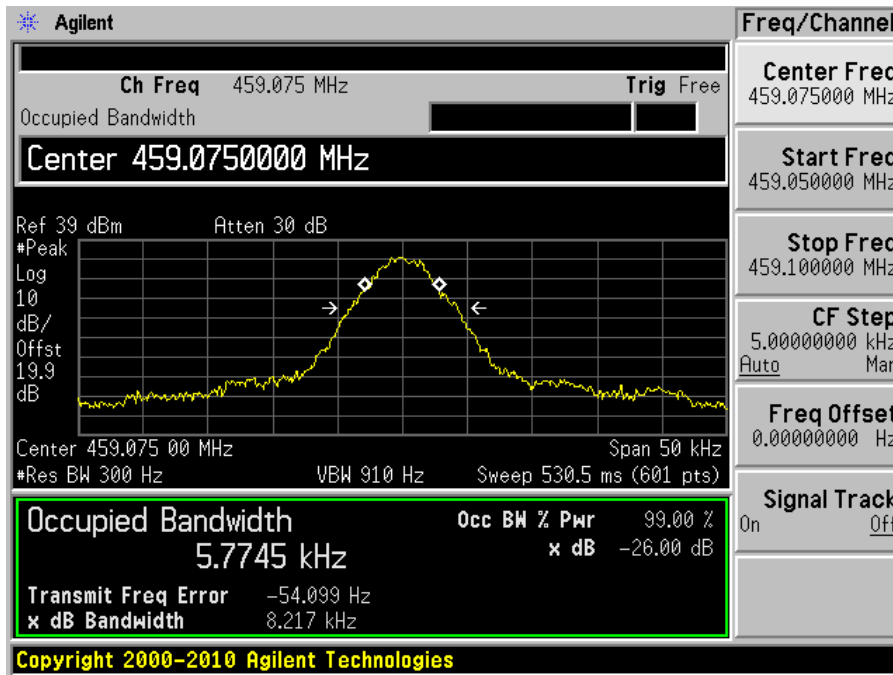

High Power Level, Modulation: GMSK, Data Rate: 4800 bps
 12.5 kHz Channel Space, Middle Channel – 459.075 MHz

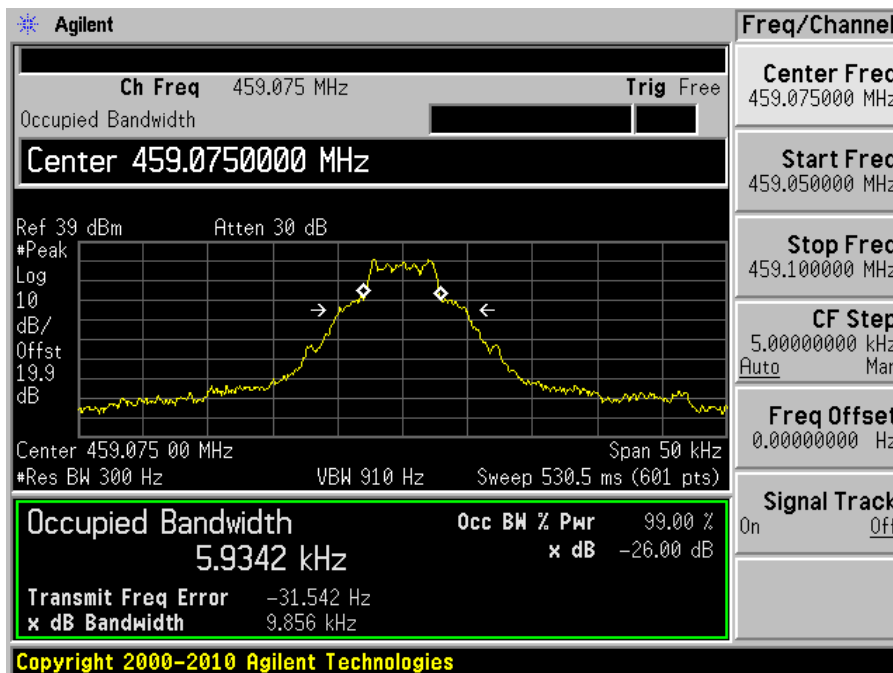

Hig Power Level, Modulation: GMSK, Data Rate: 8000 bps
 12.5 kHz Channel Space, Middle Channel – 459.075 MHz

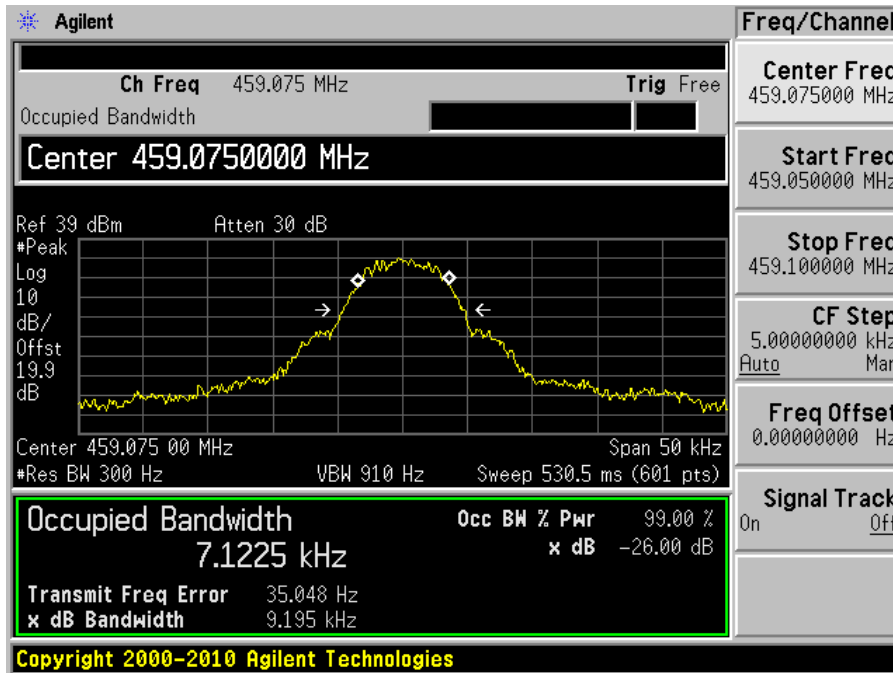

High Power Level, Modulation: GMSK, Data Rate: 9600 bps
 12.5 kHz Channel Space, Middle Channel – 459.075 MHz

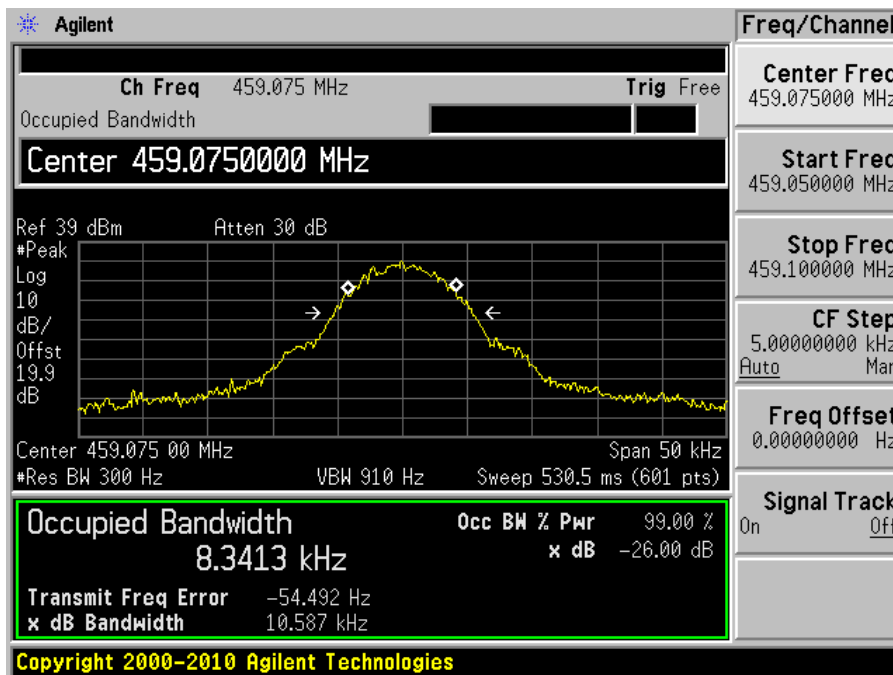

Emission Mask

High Power Level, Modulation: 4FSK, Data Rate: 9600 bps

12.5 kHz Channel Space, Low Channel – 403.05 MHz

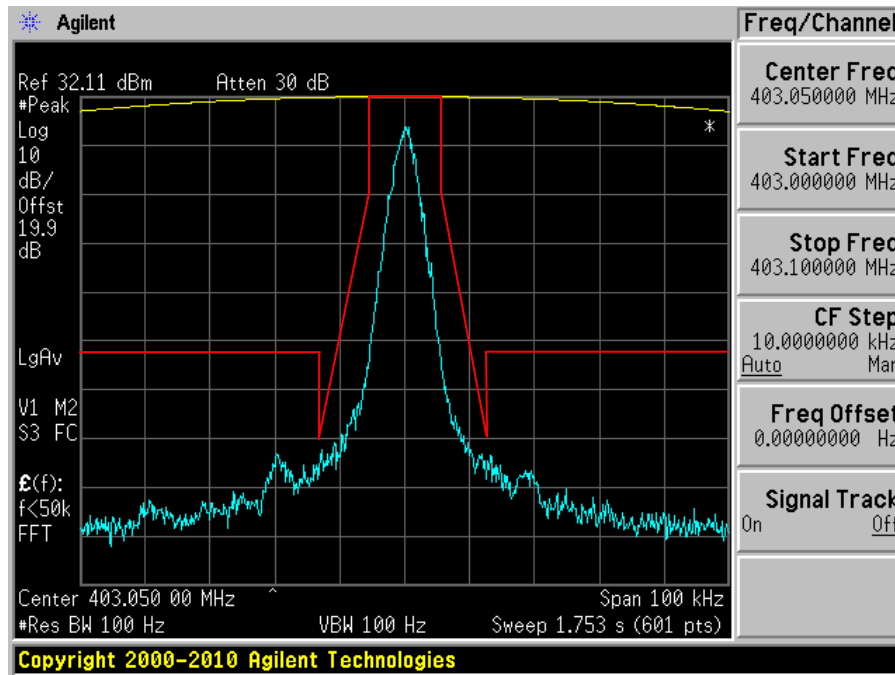

12.5 kHz Channel Space, Middle Channel – 412.95 MHz

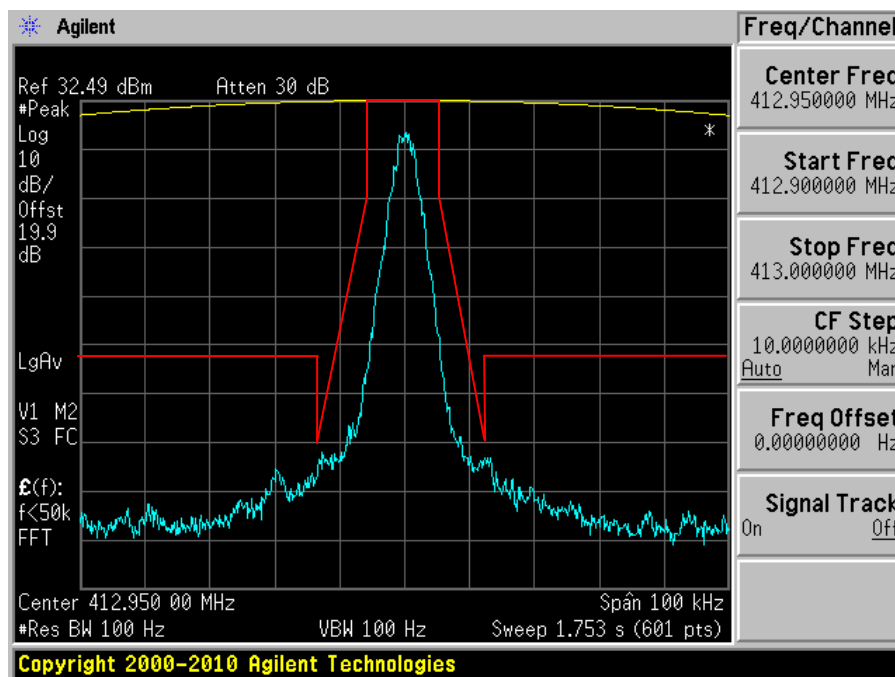

12.5 kHz Channel Space, High Channel – 429.95 MHz

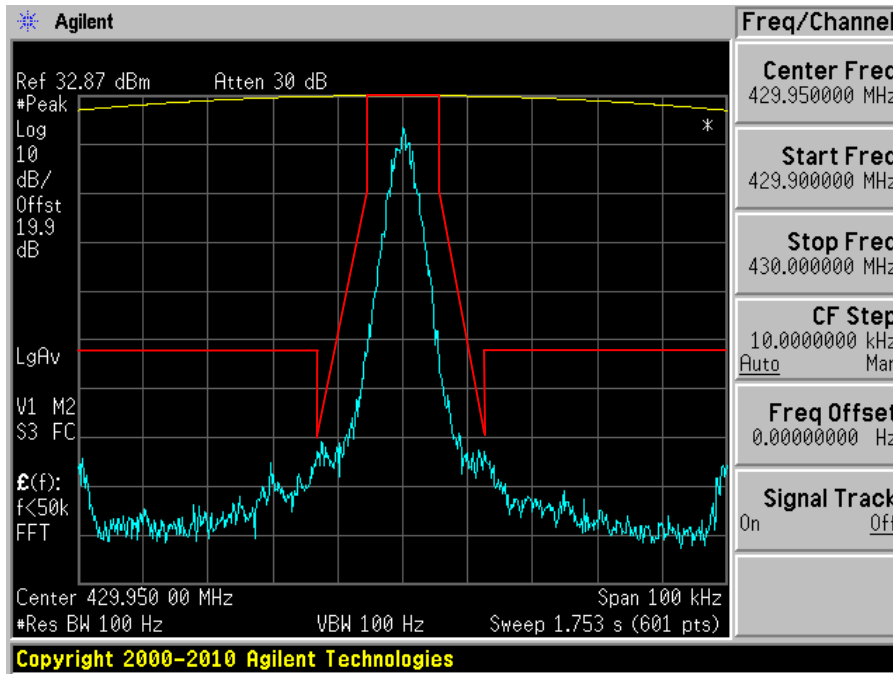

High Power Level, Modulation: GMSK, Data Rate: 4800 bps

12.5 kHz Channel Space, Low Channel – 403.05 MHz

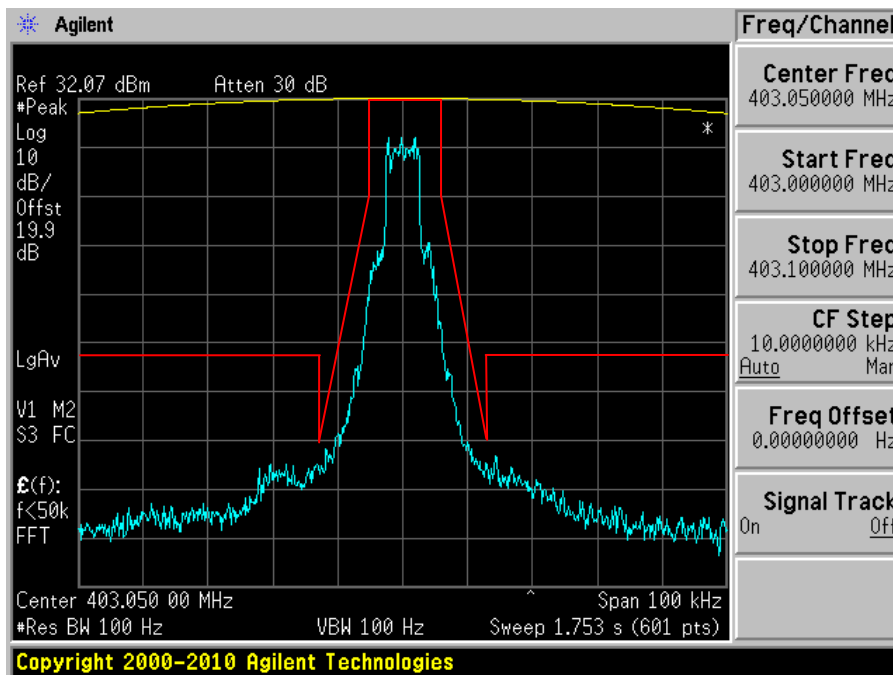

12.5 kHz Channel Space, Middle Channel – 412.95 MHz

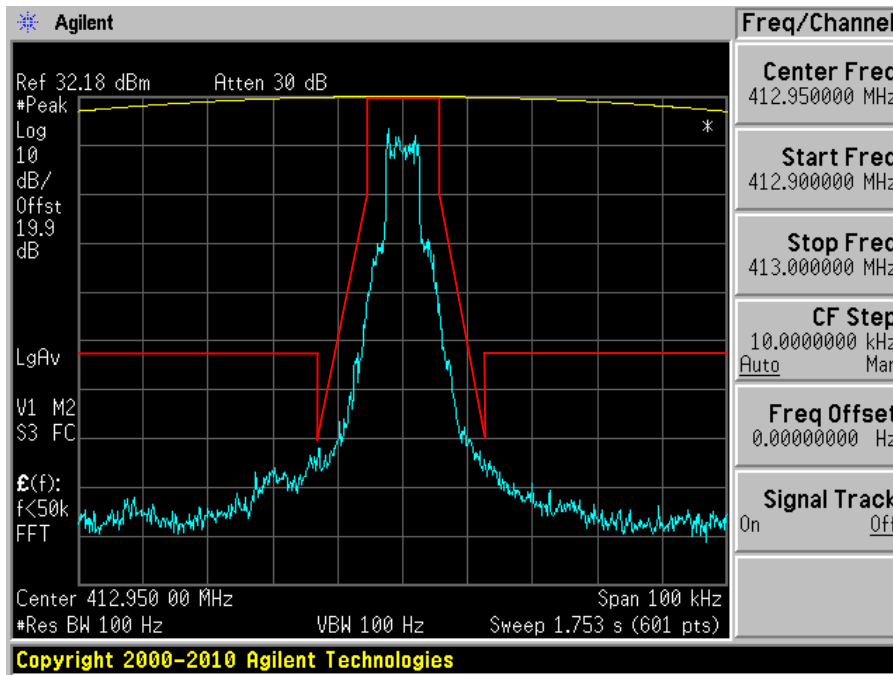

12.5 kHz Channel Space, High Channel – 429.95 MHz

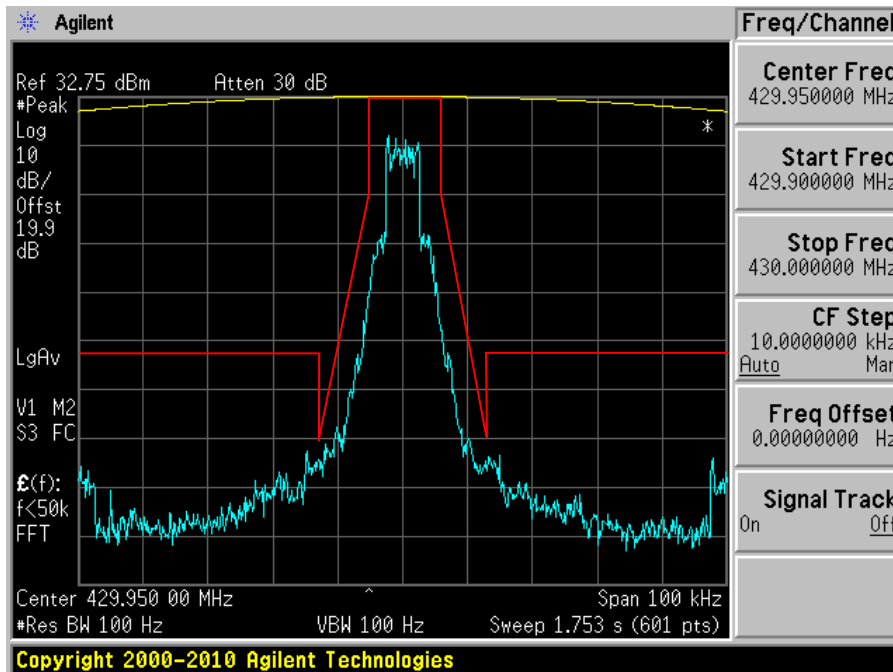

High Power Level, Modulation: GMSK, Data Rate: 8000 bps

12.5 kHz Channel Space, Low Channel – 403.05 MHz

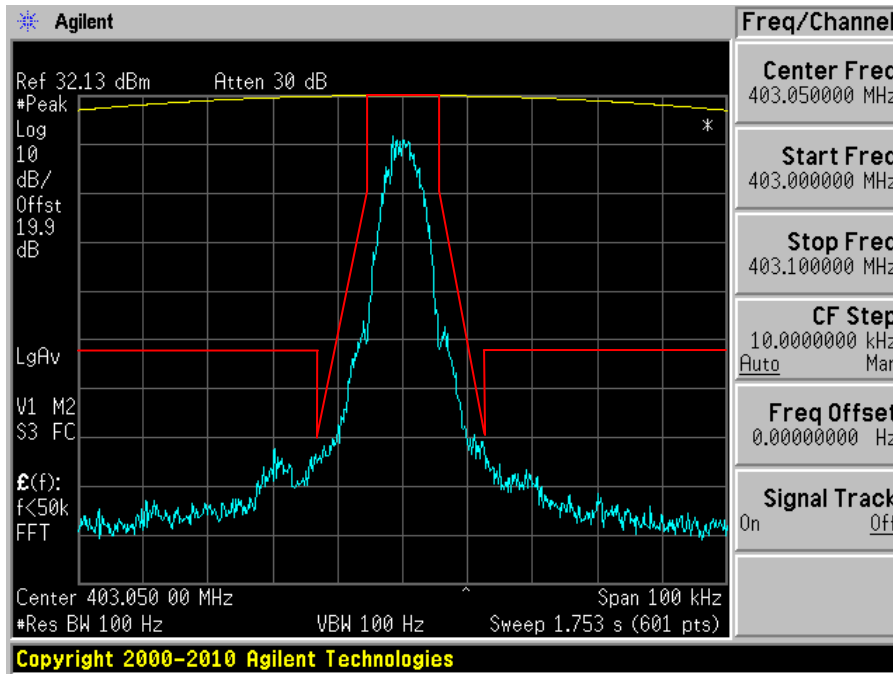

12.5 kHz Channel Space, Middle Channel – 412.95 MHz

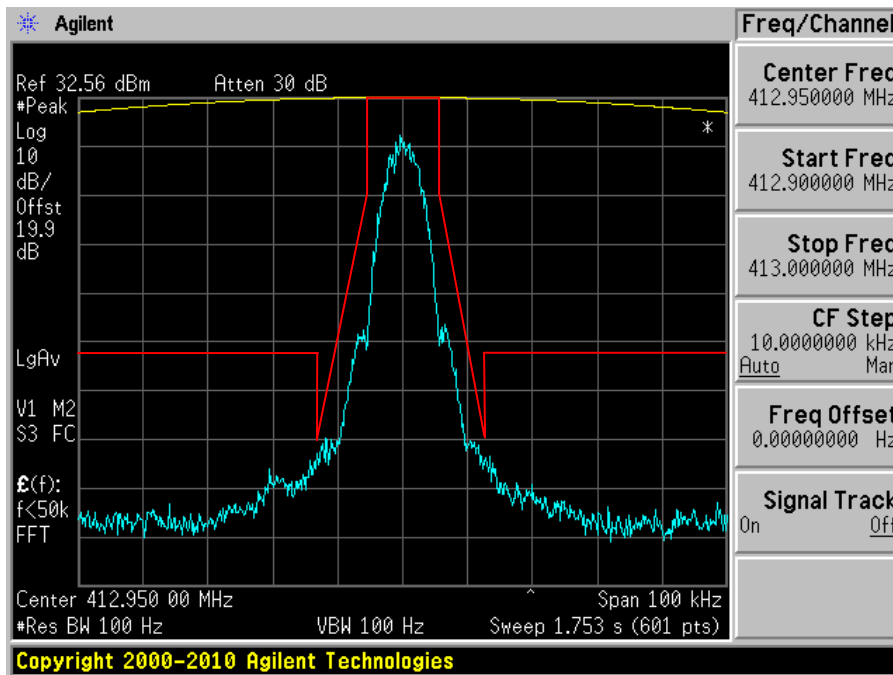

12.5 kHz Channel Space, High Channel – 429.95 MHz

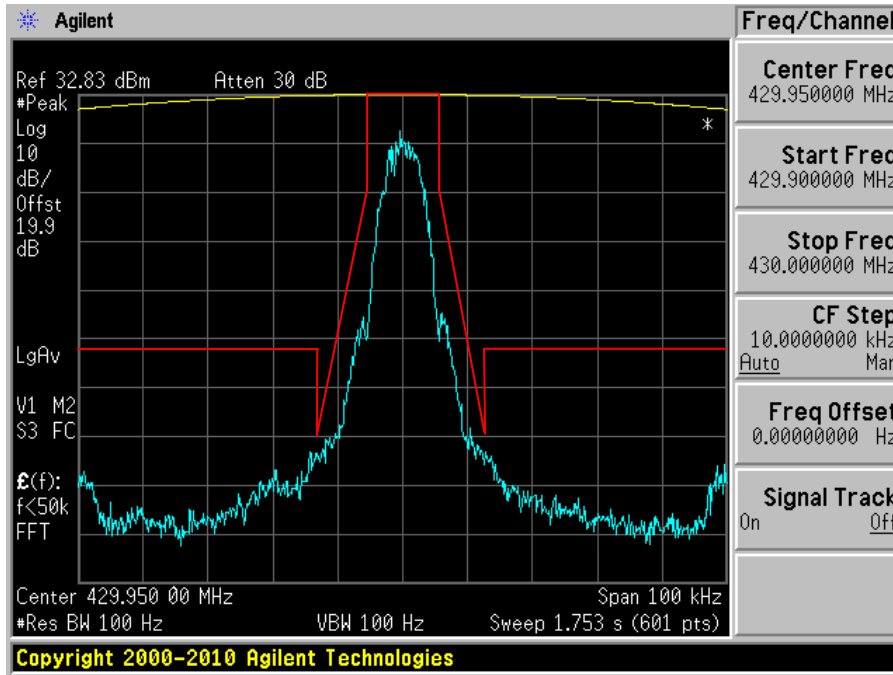

High Power Level, Modulation: GMSK, Data Rate: 9600 bps

12.5 kHz Channel Space, Low Channel – 403.05 MHz

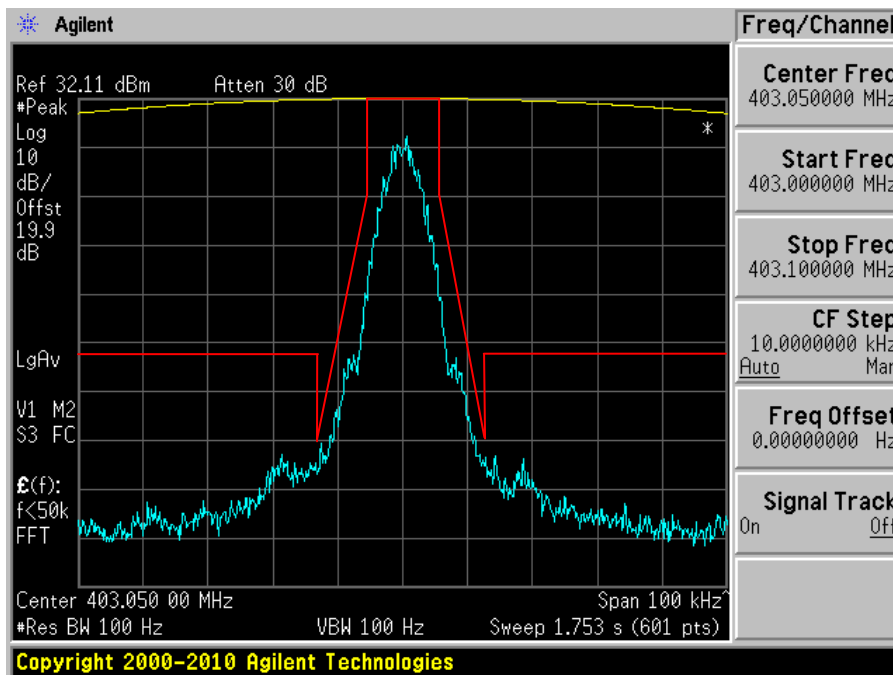

12.5 kHz Channel Space, Middle Channel – 412.95 MHz

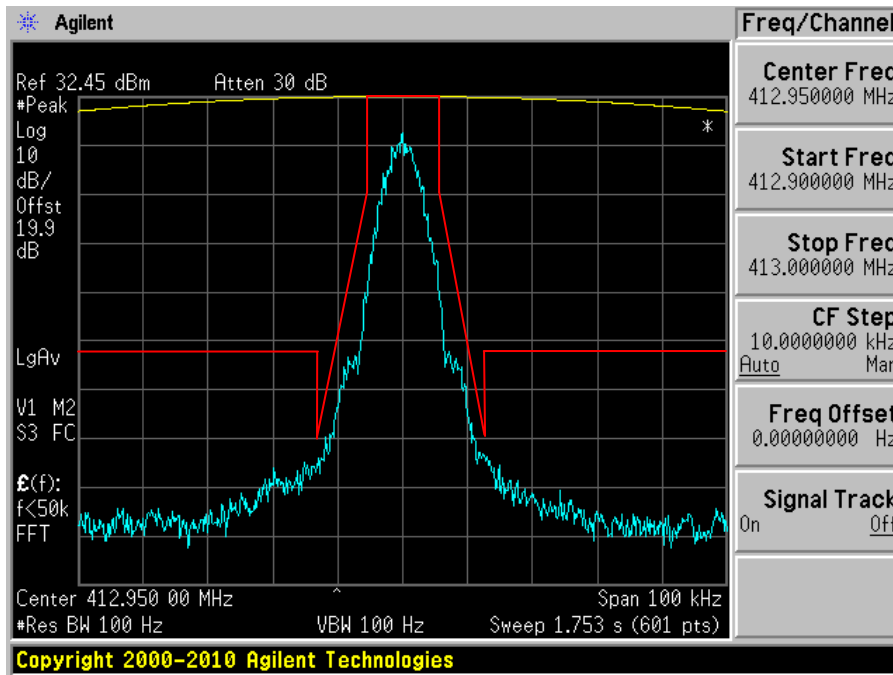

12.5 kHz Channel Space, High Channel – 429.95 MHz

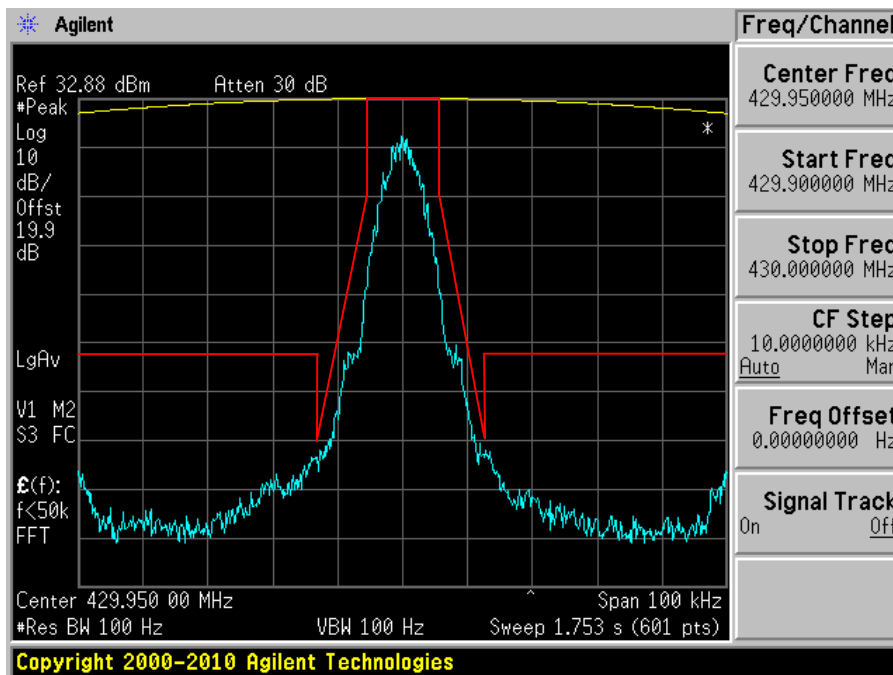

High Power Level, Modulation: 4FSK, Data Rate: 9600 bps

12.5 kHz Channel Space, Low Channel – 430.05 MHz

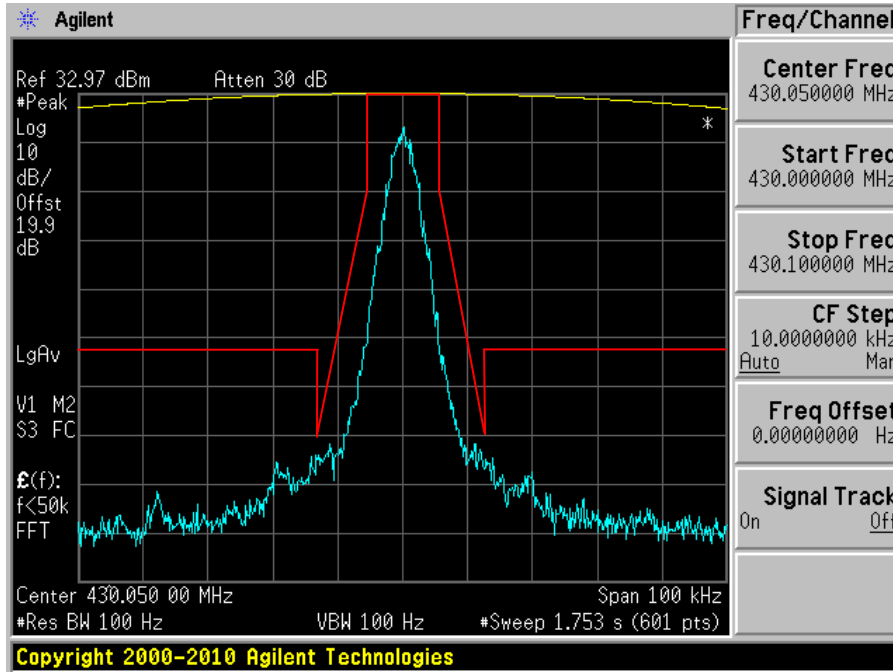

12.5 kHz Channel Space, Middle Channel – 459.075 MHz

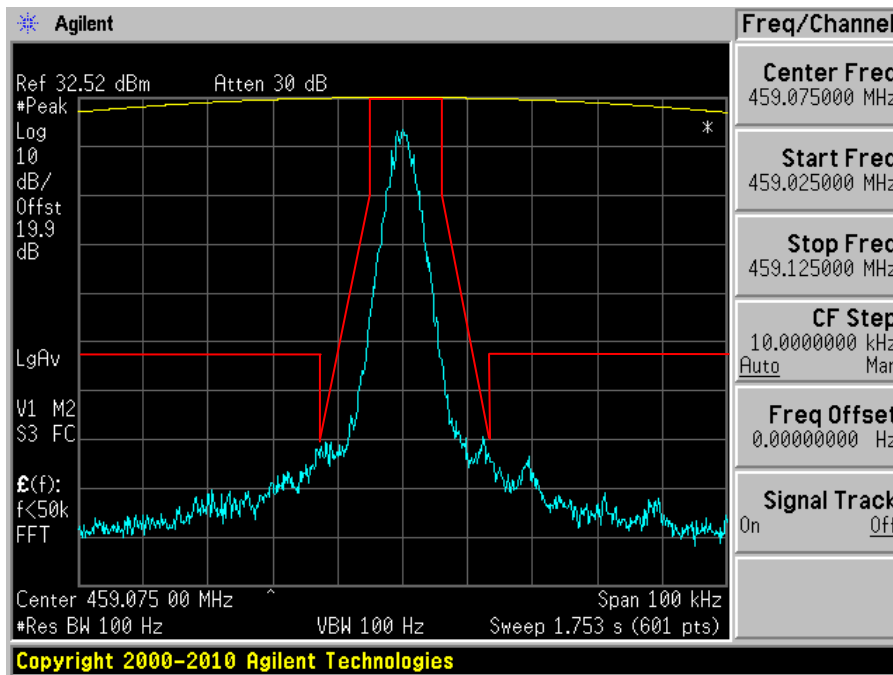

12.5 kHz Channel Space, High Channel – 472.95 MHz

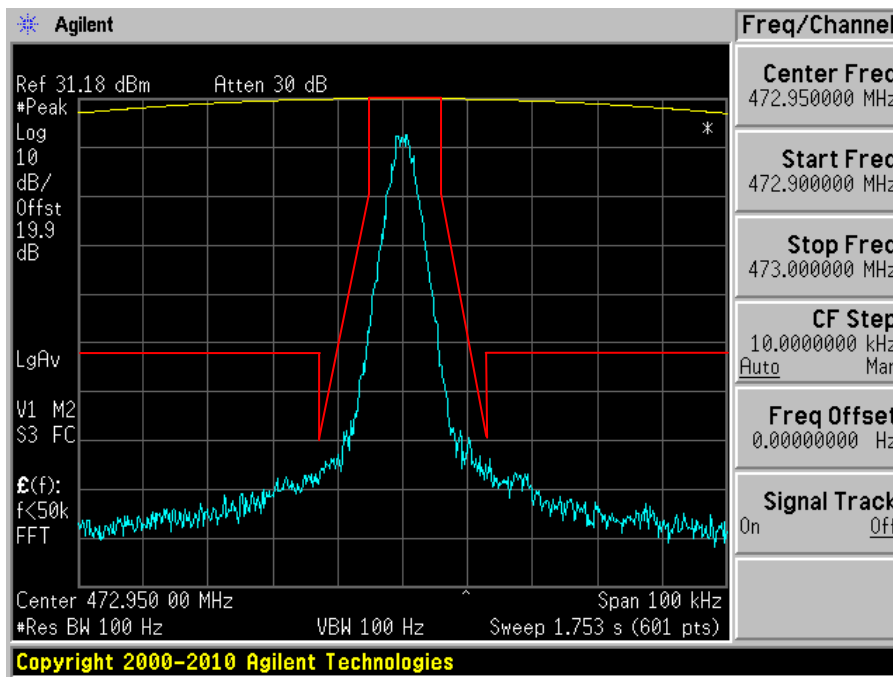

High Power Level, Modulation: GMSK, Data Rate: 4800 bps

12.5 kHz Channel Space, Low Channel – 430.05 MHz

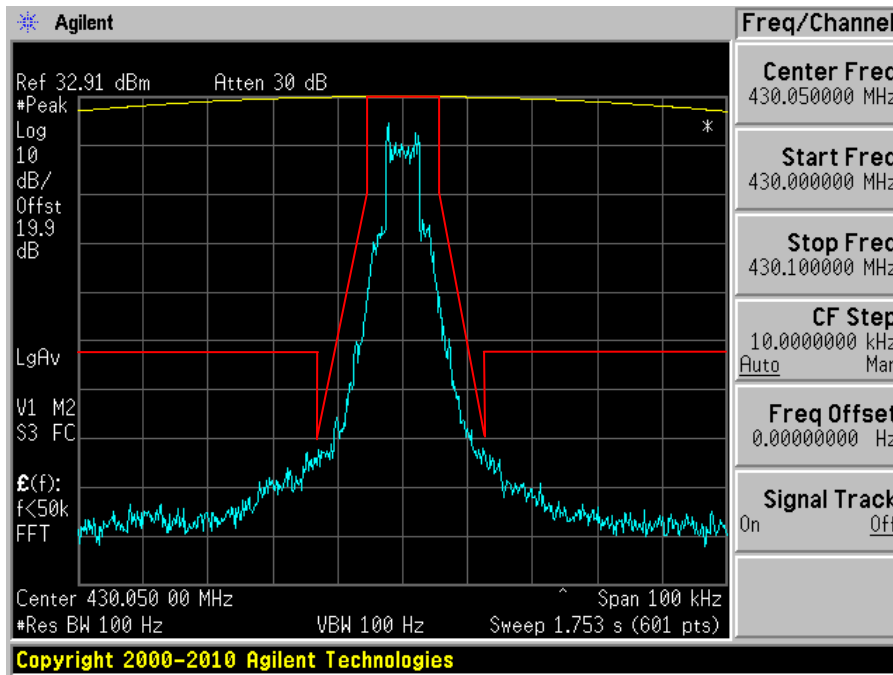

12.5 kHz Channel Space, Middle Channel – 459.075 MHz

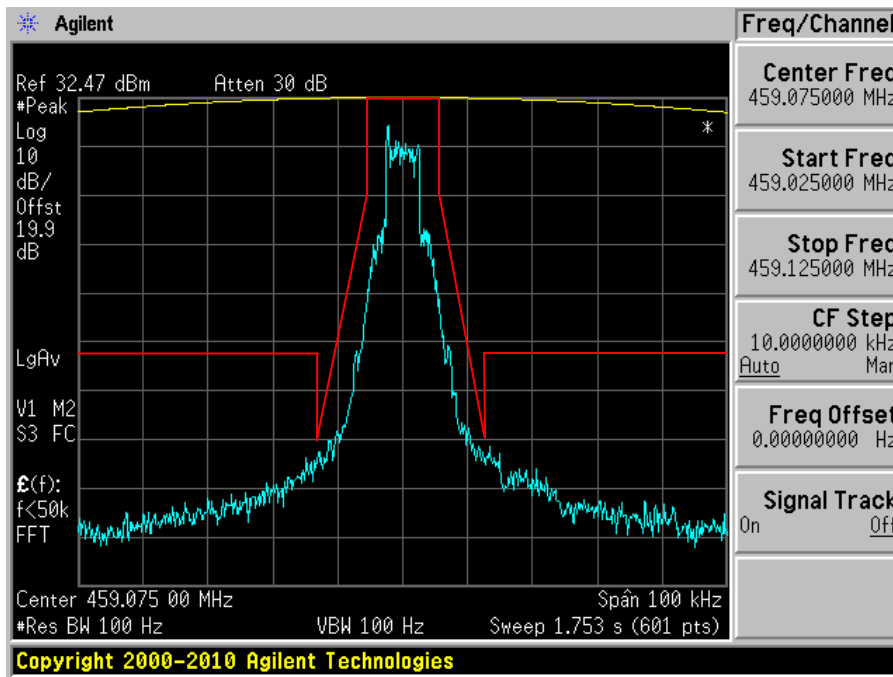

12.5 kHz Channel Space, High Channel – 472.95 MHz

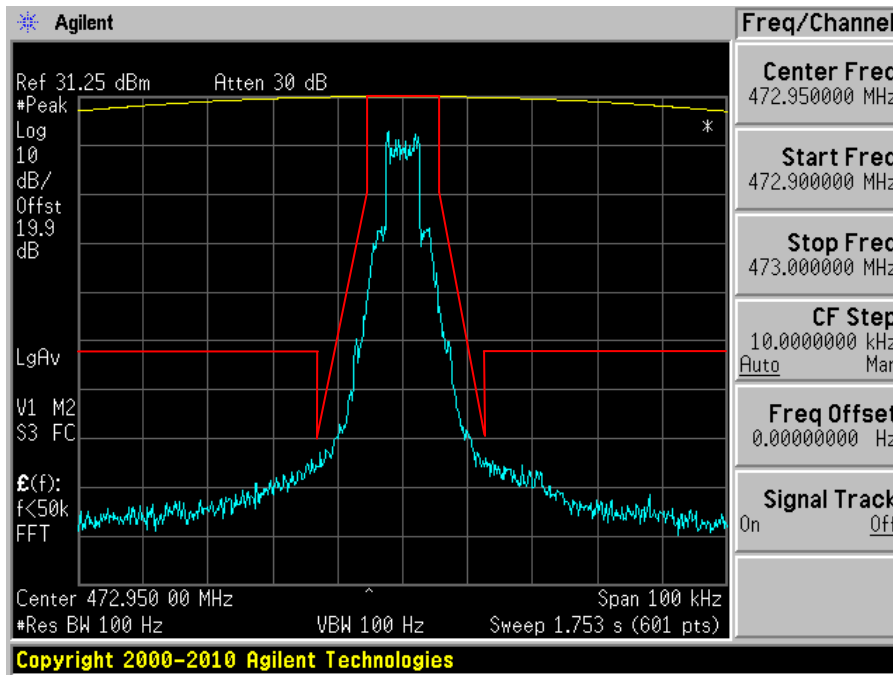

High Power Level, Modulation: GMSK, Data Rate: 8000 bps

12.5 kHz Channel Space, Low Channel – 430.05 MHz

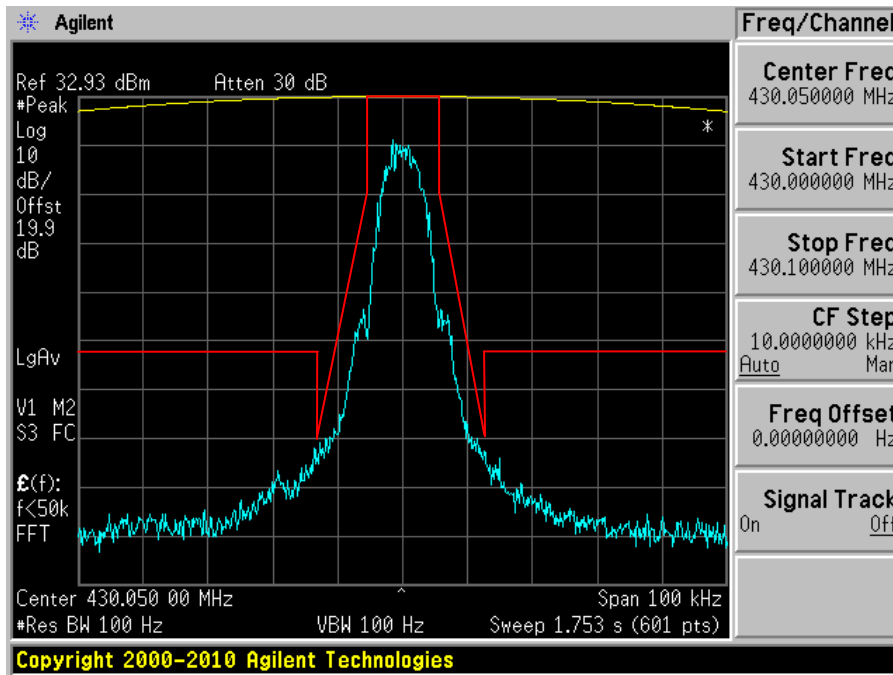

12.5 kHz Channel Space, Middle Channel – 459.075 MHz

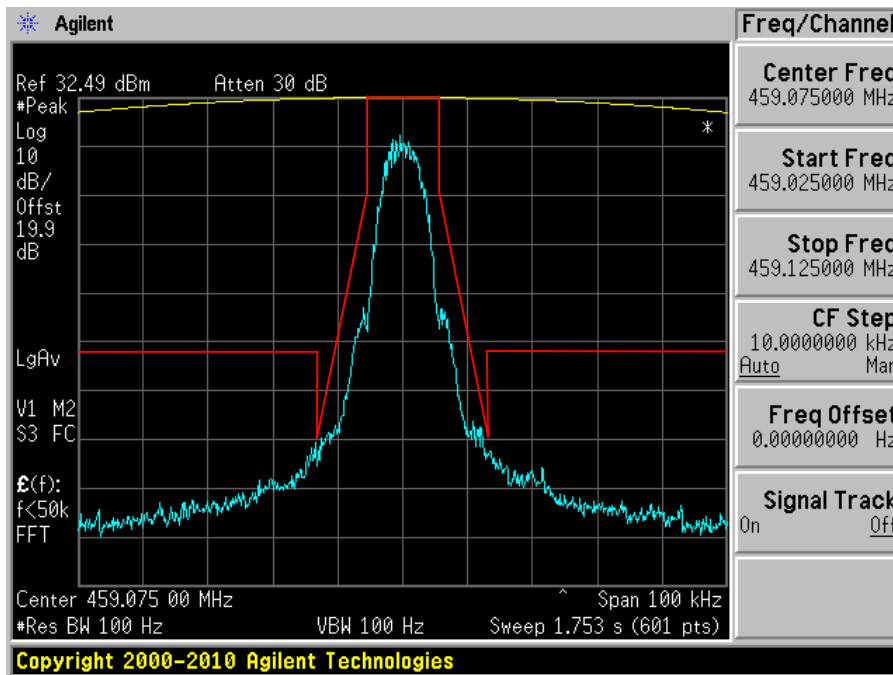

12.5 kHz Channel Space, High Channel – 472.95 MHz

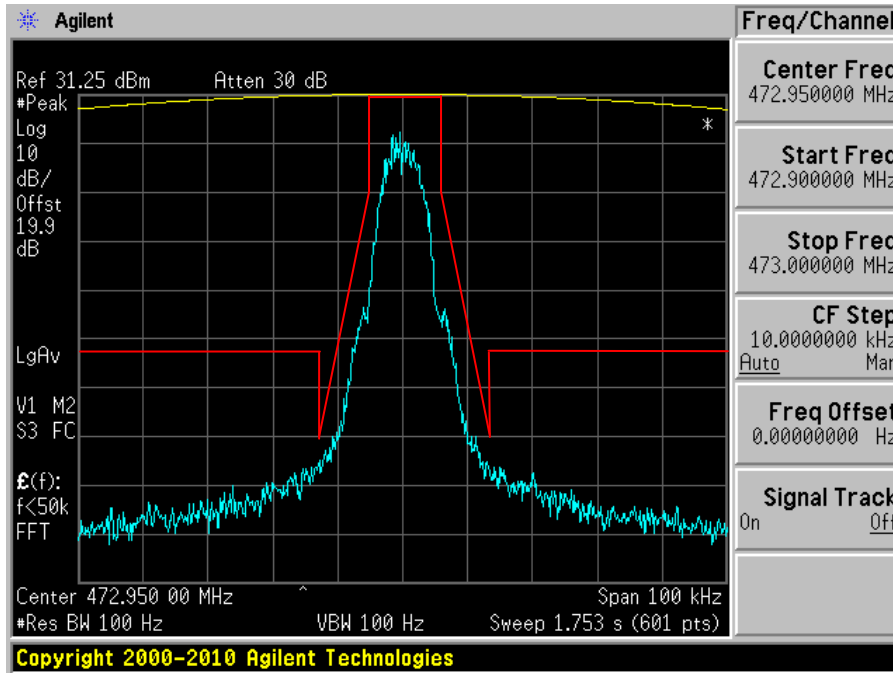

High Power Level, Modulation: GMSK, Data Rate: 9600 bps

12.5 kHz Channel Space, Low Channel – 430.05 MHz

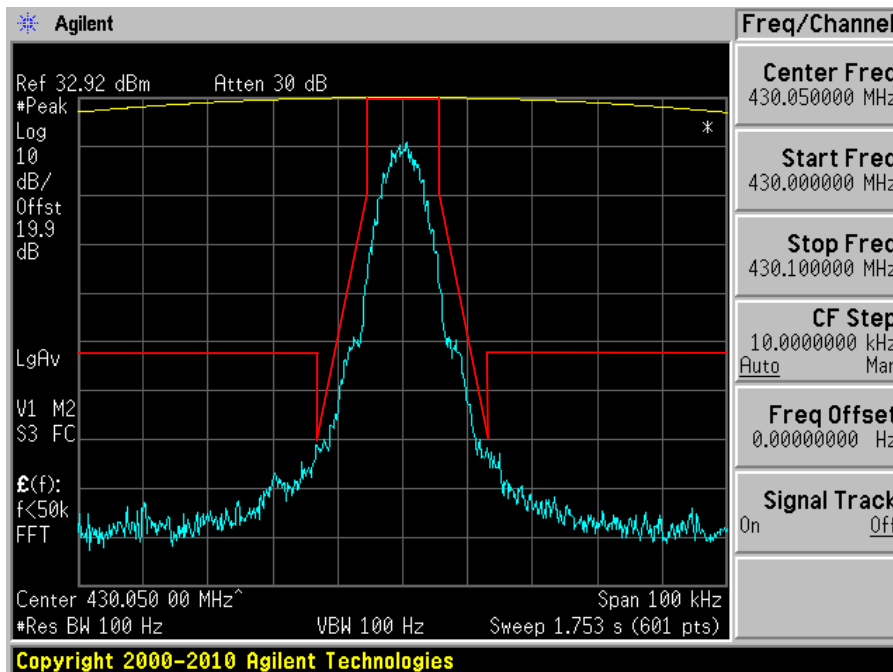

12.5 kHz Channel Space, Middle Channel – 459.075 MHz

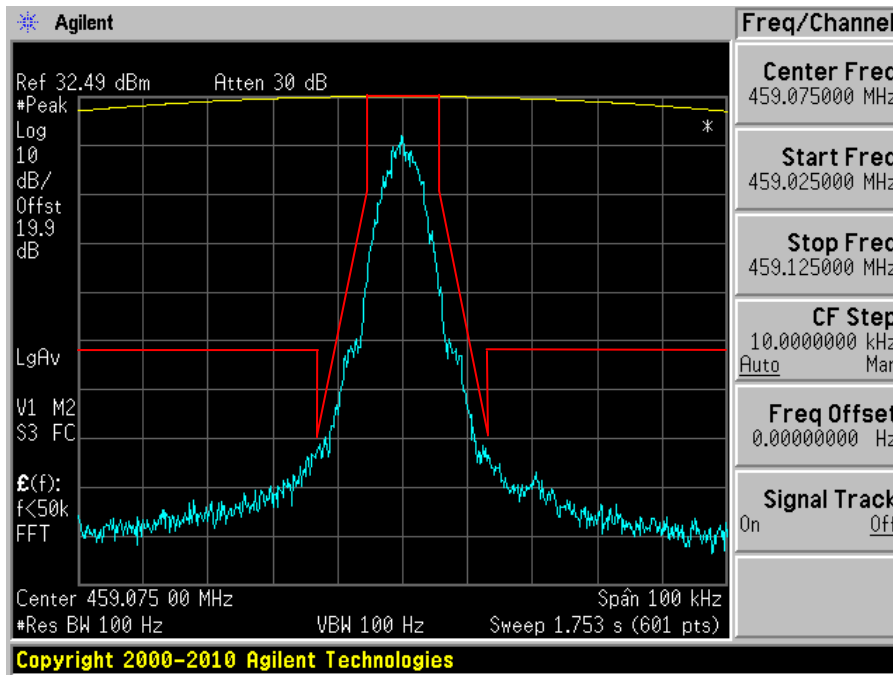

12.5 kHz Channel Space, High Channel – 472.95 MHz

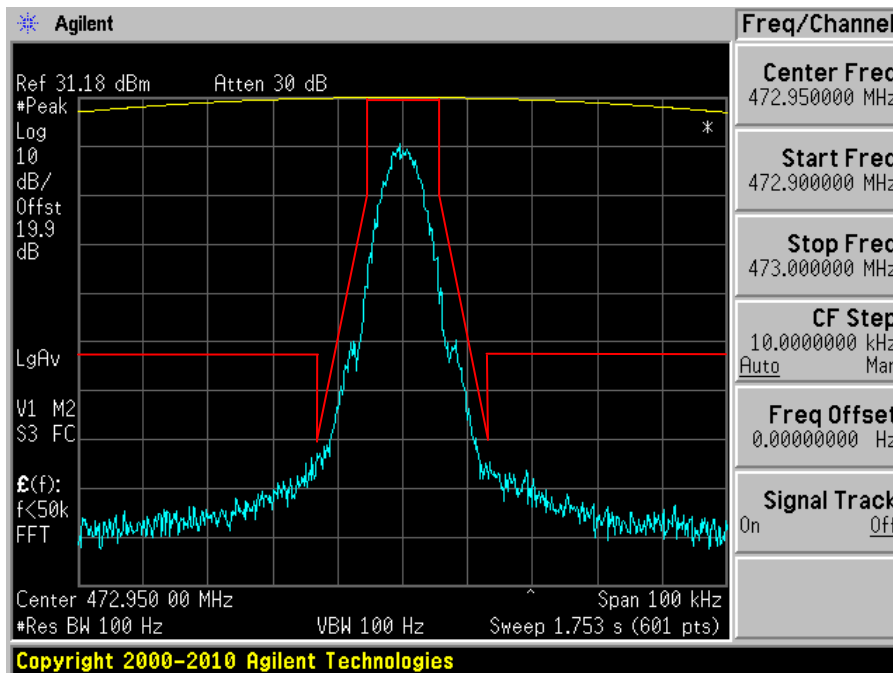

8 FCC §2.1051 & §90.210 - Spurious Emissions at Antenna Terminals

8.1 Applicable Standard

According to FCC §90.210: On any frequency removed from the center of the authorized bandwidth by more than 250 percent of the authorized bandwidth: At least $43 + 10 \log (P)$ dB.

8.2 Test Procedure

The RF output of the transceiver was connected to a spectrum analyzer through appropriate attenuation. The resolution bandwidth of the spectrum analyzer was set at 100 kHz. Sufficient scans were taken to show any out of band emissions up to 10th harmonic.

8.3 Test Equipment List and Details

Manufacturer	Description	Model	Serial Number	Calibration Date
Agilent	Spectrum Analyzer	E4440A	US45303156	2010-08-09 ¹

Note¹: 2-year calibration cycle

Statement of Traceability: BACL Corp. attests that all calibrations have been performed per the NVLAP requirements, traceable to the NIST.

8.4 Test Environmental Conditions

Temperature:	20-25 °C
Relative Humidity:	44-55 %
ATM Pressure:	101-102 kPa

The testing was performed by Jack Liu on 2011-06-03 to 2011-06-10 in the RF Site.

8.5 Test Results

Please refer to the hereinafter plots.

403-430 MHz

High Channel – 429.95 MHz

30 MHz – 1 GHz

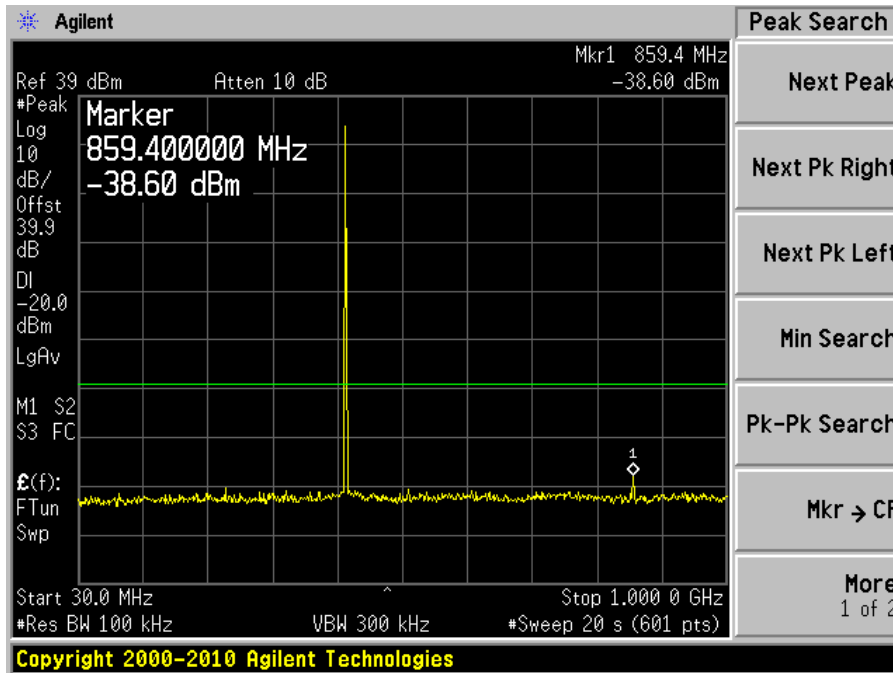

1 – 5 GHz

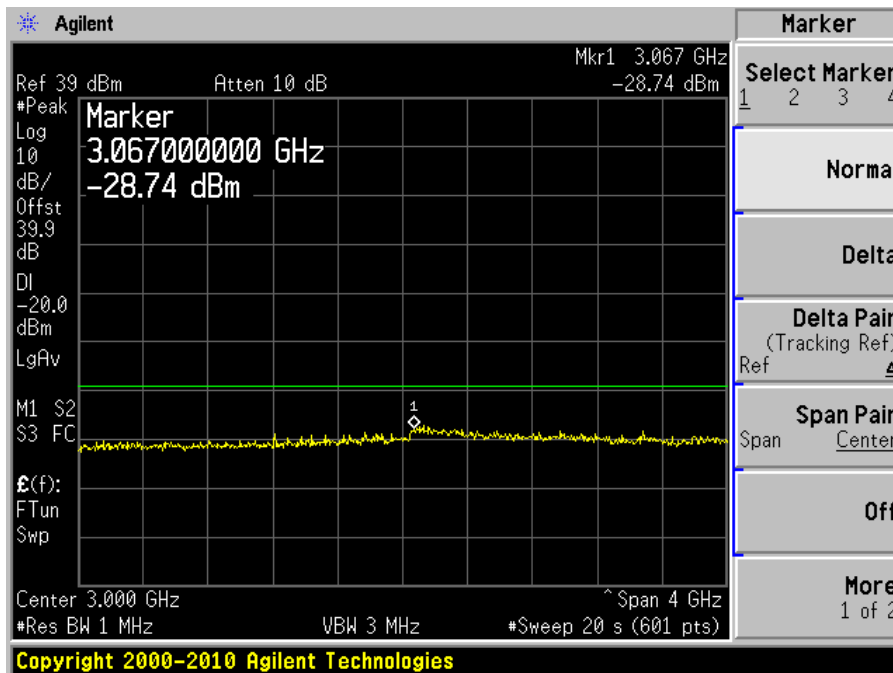

430-473 MHz

Middle Channel – 459.075 MHz

30 MHz – 1 GHz

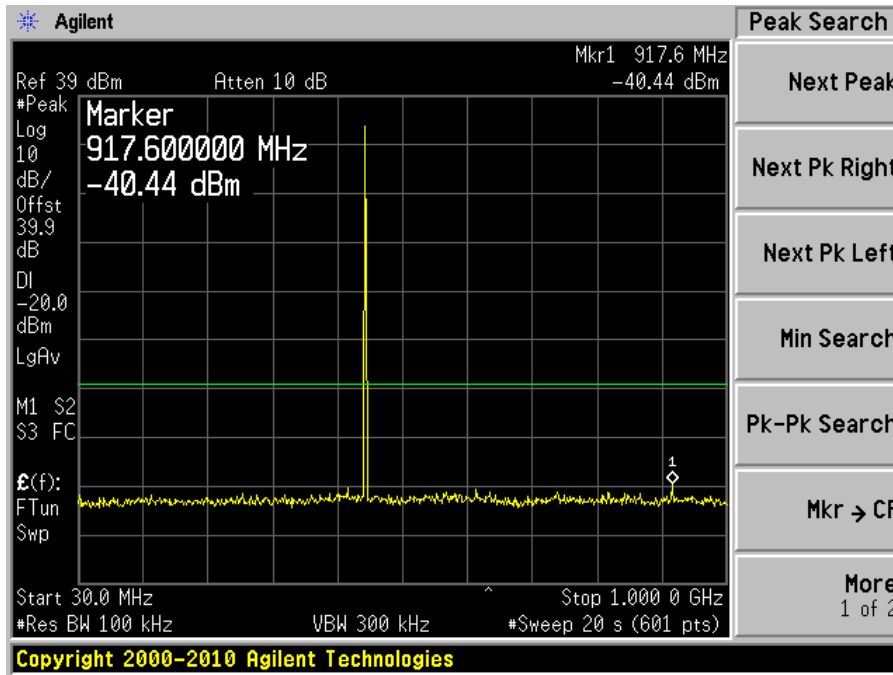

1 – 5 GHz

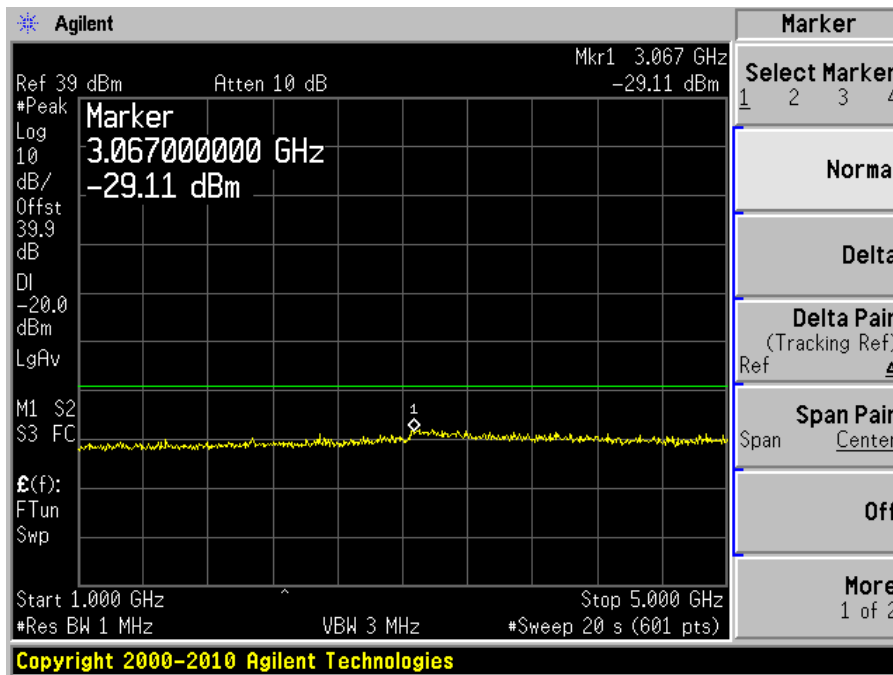

9 FCC §2.1055 (d) & §90.213 - Frequency Stability

9.1 Applicable Standard

FCC §2.1055, §90.213

Minimum Frequency Stability

[Parts per million (ppm)]

Frequency range (MHz)	Fixed and base stations	Mobile stations	
		Over 2 watts output power	2 watts or less output power
Below 25	1,2,3 100	100	200
25–50	20	20	50
72–76	5		50
150–174	5,11 5	8 5	4,6 50
216–220	1.0		1.0
220–222 ¹²	0.1	1.5	1.5
421–512	7,11,14 2.5	8 5	8 5
806–809	14 1.0	1.5	1.5
809–824	14 1.5	2.5	2.5
851–854	1.0	1.5	1.5
854–869	1.5	2.5	2.5
896–901	14 0.1	1.5	1.5
902–928	2.5	2.5	2.5
902–928 ¹³	2.5	2.5	2.5
929–930	1.5		
935–940	0.1	1.5	1.5
1427–1435	9 300	300	300
Above 2450 ¹⁰			

⁷In the 421–512 MHz band, fixed and base stations with a 12.5 kHz channel bandwidth must have a frequency stability of 1.5 ppm. Fixed and base stations with a 6.25 kHz channel bandwidth must have a frequency stability of 0.5 ppm.

9.2 Test Procedure

Frequency Stability vs. Temperature: The equipment under test was connected to an external DC power supply and the RF output was connected to the Spectrum Analyzer via feed-through attenuators. The EUT was placed inside the temperature chamber. The DC leads and RF output cable exited the chamber through an opening made for the purpose.

After the temperature stabilized for approximately 20 minutes, the frequency output was recorded from the Spectrum Analyzer.

Frequency Stability vs. Voltage: An external variable DC power supply Source. The voltage was set to 115% and 85% of the nominal value. The output frequency was recorded for each voltage.

9.3 Test Equipment List and Details

Manufacturer	Description	Model	Serial Number	Calibration Date
Agilent	Spectrum Analyzer	E4440A	US45303156	2010-08-09 ¹
Agilent	DC Power Supply	E3630A	Agilent	N/A
ESPEC	Oven, Temperature	ESL-4CA	18010	N/A

Note¹: 2-year calibration cycle

Statement of Traceability: BACL Corp. attests that all calibrations have been performed per the NVLAP requirements, traceable to the NIST.

9.4 Test Environmental Conditions

Temperature:	20-25 °C
Relative Humidity:	44-55 %
ATM Pressure:	101-102 kPa

The testing was performed by Jack Liu on 2011-06-03 to 2011-06-10.

9.5 Test Results

Reference Frequency: 412.95 MHz

Test Condition		Reference Frequency (MHz)	Measured Frequency (MHz)	Frequency Error (PPM)	Limit (PPM)
Voltage (Vdc)	Temperature (°C)				
Frequency vs. Temperature					
3.6	50	412.95	412.949982	-0.044	± 5
3.6	40	412.95	412.949994	-0.015	± 5
3.6	30	412.95	412.950036	0.087	± 5
3.6	20	412.95	412.950040	0.097	± 5
3.6	10	412.95	412.950048	0.116	± 5
3.6	0	412.95	412.950024	0.058	± 5
3.6	-10	412.95	412.949994	-0.015	± 5
3.6	-20	412.95	412.949988	-0.029	± 5
Frequency vs. Voltage					
4.14	20	412.95	412.950032	0.077	± 5
3.06	20	412.95	412.949426	-1.389	± 5

Reference Frequency: 459.075 MHz

Test Condition		Reference Frequency (MHz)	Measured Frequency (MHz)	Frequency Error (PPM)	Limit (PPM)
Voltage (Vdc)	Temperature (°C)				
Frequency vs. Temperature					
3.6	50	459.075	459.074970	-0.065	± 5
3.6	40	459.075	459.074982	-0.039	± 5
3.6	30	459.075	459.075030	0.065	± 5
3.6	20	459.075	459.075060	0.131	± 5
3.6	10	459.075	459.075066	0.144	± 5
3.6	0	459.075	459.075048	0.105	± 5
3.6	-10	459.075	459.074952	-0.105	± 5
3.6	-20	459.075	459.074976	-0.052	± 5
Frequency vs. Voltage					
4.14	20	459.075	459.075008	0.017	± 5
3.06	20	459.075	459.074410	-1.285	± 5

10 FCC §2.1053 & §90.210 – Field Strength of Spurious Radiation

10.1 Applicable Standard

According to FCC §90.210: On any frequency removed from the center of the authorized bandwidth by more than 250 percent of the authorized bandwidth: At least $43 + 10 \log (P)$ dB.

10.2 Test Procedure

The transmitter was placed on a Styrofoam with wooden turntable, and it was normal transmitting with 50ohm termination which was also placed on the turntable.

The measurement antenna was placed at a distance of 3 meters from the EUT. During the tests, the antenna height and polarization as well as EUT azimuth were varied in order to identify the maximum level of emissions from the EUT. The test was performed by placing the EUT on 3-orthogonal axis.

The frequency range up to tenth harmonic of the fundamental frequency was investigated.

Remove the EUT and replace it with substitution antenna. A signal generator was connected to the substitution antenna by a non-radiating cable. The absolute levels of the spurious emissions were measured by the substitution.

Spurious emissions in dB = $10 \lg (\text{TXpwr in Watts}/0.001)$ – the absolute level

10.3 Test Environmental Conditions

Temperature:	18-24 °C
Relative Humidity:	35-50 %
ATM Pressure:	101-102 kPa

The testing was performed by Quinn Jiang on 2011-12-06 - 2011-12-09 in the 5 meter chamber 3.

10.4 Test Equipment List and Details

Manufacturer	Description	Model	Serial Number	Calibration Date
Agilent	Spectrum Analyzer	E4440A	MY44303352	2011-05-10
Sunol Science Corp	System Controller	SC99V	122303-1	N/R
Sunol Science Corp	Combination Antenna	JB3	A020106-2	2011-08-10
Sunol Sciences	Horn antenna	DRH-118	A052704	2011-02-23
Hewlett Packard	Pre amplifier	8447D	2944A06639	2011-06-09
Mini-Circuits	Pre Amplifier	ZVA-183-S	667400960	2011-05-08
Hewlett Packard	Generator, Signal	83650B	3614A00276	2010-06-21 ¹

Note¹: 2-year calibration cycle

Statement of Traceability: BACL attests that all calibrations have been performed per the NVLAP requirements, traceable to NIST.

10.5 Test Results

Frequency: 403-430 MHz:

Worst Margin: -25.08 dB at 4542 MHz in the Vertical polarization.

Frequency: 430-473 MHz:

Worst Margin: -18.25 dB at 1377 MHz in the Horizontal polarization.

403-430 MHz, High Power Level:

12.5 kHz Channel Spacing, High Channel – 429.95 MHz

Indicated		Turntable Azimuth Degrees	Test Antenna		Substituted					Limit (dBm)	Margin (dB)
Freq. (MHz)	Amp. (dBuV)		Height (m)	Polar (H/V)	Freq. (MHz)	Level (dBm)	Ant. Cord. (dBi)	Cable Loss (dB)	Absolute Level (dBm)		
859.7	42.58	360	271	V	825.9	-53.16	0	0.7	-53.86	-13	-40.86
859.7	45.54	69	191	H	825.9	-50.2	0	0.7	-50.9	-13	-37.9
1289.55	52.38	57	162	V	1289.55	-51.89	7.3	1	-45.59	-13	-32.59
1289.55	50.01	213	161	H	1289.55	-54.26	7.3	1	-47.96	-13	-34.96
4542	47.92	300	137	V	4542	-48.23	11.2	1.8	-38.83	-13	-25.83
4542	45.67	50	177	H	4542	-50.48	11.2	1.8	-41.08	-13	-28.08

450-473 MHz, High Power Level:

12.5 kHz Channel Spacing, Middle Channel – 459.075 MHz

Indicated		Turntable Azimuth Degrees	Test Antenna		Substituted					Limit (dBm)	Margin (dB)
Freq. (MHz)	Amp. (dBuV)		Height (m)	Polar (H/V)	Freq. (MHz)	Level (dBm)	Ant. Cord. (dBi)	Cable Loss (dB)	Absolute Level (dBm)		
918.15	46.86	322	198	V	918.15	-45.94	0	0.9	-46.84	-13	-33.84
918.15	50.68	310	122	H	918.15	-42.12	0	0.9	-43.02	-13	-30.02
1377	62.55	79	176	V	1377	-40.45	8.1	1	-33.35	-13	-20.35
1377	64.65	92	200	H	1377	-38.35	8.1	1	-31.25	-13	-18.25
2755	50.82	360	165	V	2755	-49.36	9.9	1.3	-40.76	-13	-27.76
2755	48.45	214	216	H	2755	-51.73	9.9	1.3	-43.13	-13	-30.13

Note: measurement was taken with EUT at X orientation (worst case)

11 FCC §90.214 - Transient Frequency Behavior

11.1 Applicable Standard

FCC §90.214: Transmitters designed to operate in the 150–174 MHz and 421–512 MHz frequency bands must maintain transient frequencies within the maximum frequency difference limits during the time intervals indicated:

Time intervals ^{1,2}	Maximum frequency difference ³	All equipment
		421 to 512 MHz
Transient Frequency Behavior for Equipment Designed to Operate on 25 kHz Channels		
t_1^4	± 25.0 kHz	10.0 ms
t_2	± 12.5 kHz	25.0 ms
t_3^4	± 25.0 kHz	10.0 ms
Transient Frequency Behavior for Equipment Designed to Operate on 12.5 kHz Channels		
t_1^4	± 12.5 kHz	10.0 ms
t_2	± 6.25 kHz	25.0 ms
t_3^4	± 12.5 kHz	10.0 ms

¹_{on} is the instant when a 1 kHz test signal is completely suppressed, including any capture time due to phasing.

t_1 is the time period immediately following t_{on} .

t_2 is the time period immediately following t_1 .

t_3 is the time period from the instant when the transmitter is turned off until t_{off} .

t_{off} is the instant when the 1 kHz test signal starts to rise.

²During the time from the end of t_2 to the beginning of t_3 , the frequency difference must not exceed the limits specified in §90.213.

³Difference between the actual transmitter frequency and the assigned transmitter frequency.

⁴If the transmitter carrier output power rating is 6 watts or less, the frequency difference during this time period may exceed the maximum frequency difference for this time period.

11.2 Test Procedure

TIA/EIA-603-C 2.2.19

11.3 Test Equipment List and Details

Manufacturer	Description	Model	Serial Number	Calibration Date
Agilent	Spectrum Analyzer	E4440A	MY44303352	2011-05-10
Tektronix	Digital Phosphor Oscilloscope	TDS7104	B020557	2011-06-09
Agilent	Generator, Signal	E4438C	MY45091309	2011-04-28
HP	RF Communication test set	8920A	3438A05338	2010-05-18 ¹

Note¹: 2-year calibration cycle

Statement of Traceability: BACL attests that all calibrations have been performed per the NVLAP requirements, traceable to NIST.

11.4 Test Environmental Conditions

Temperature:	20-25 °C
Relative Humidity:	44-55 %
ATM Pressure:	101-102 kPa

The testing was performed by Jack Liu on 2011-06-03 to 2011-06-10 in the RF Site.

11.5 Test Results

Please refer to the hereinafter plots.

403-430 MHz, High Power Level:

Middle Channel: 412.95 MHz

Powering Up

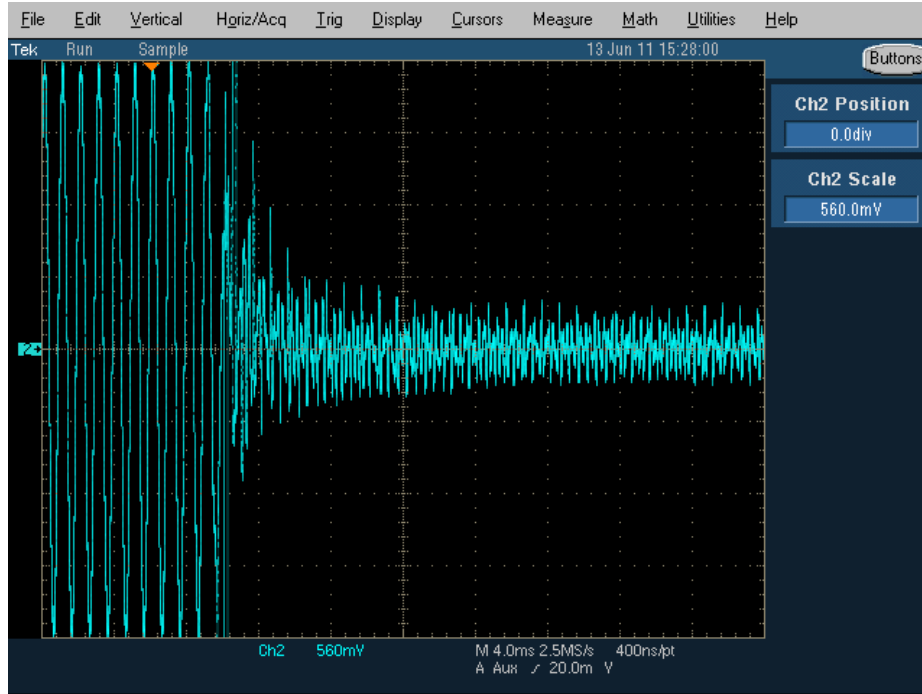

Powering Down

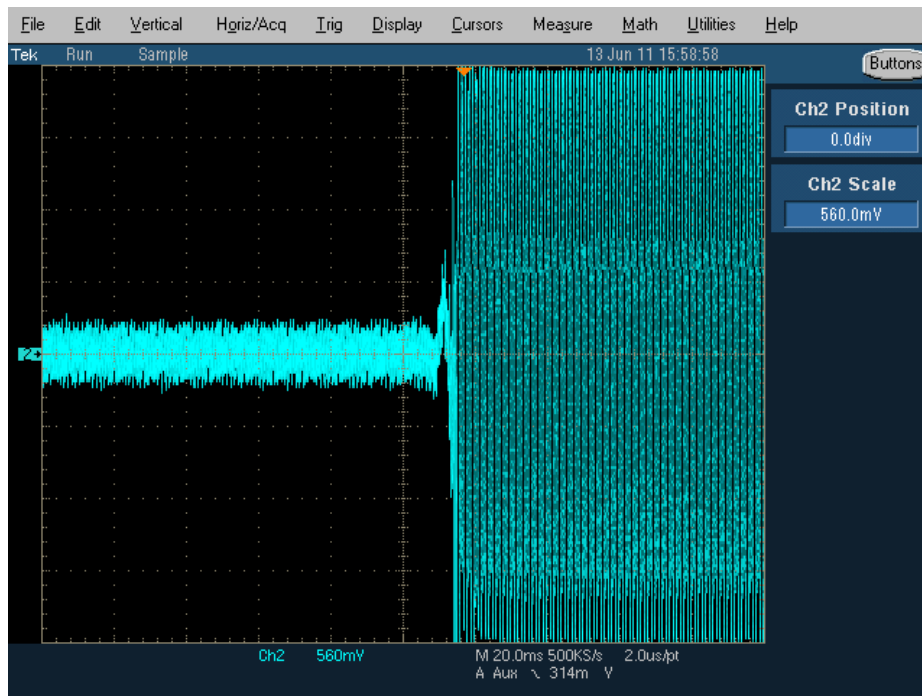

430-473 MHz, High Power Level:

Middle Channel: 459.075

Powering Up

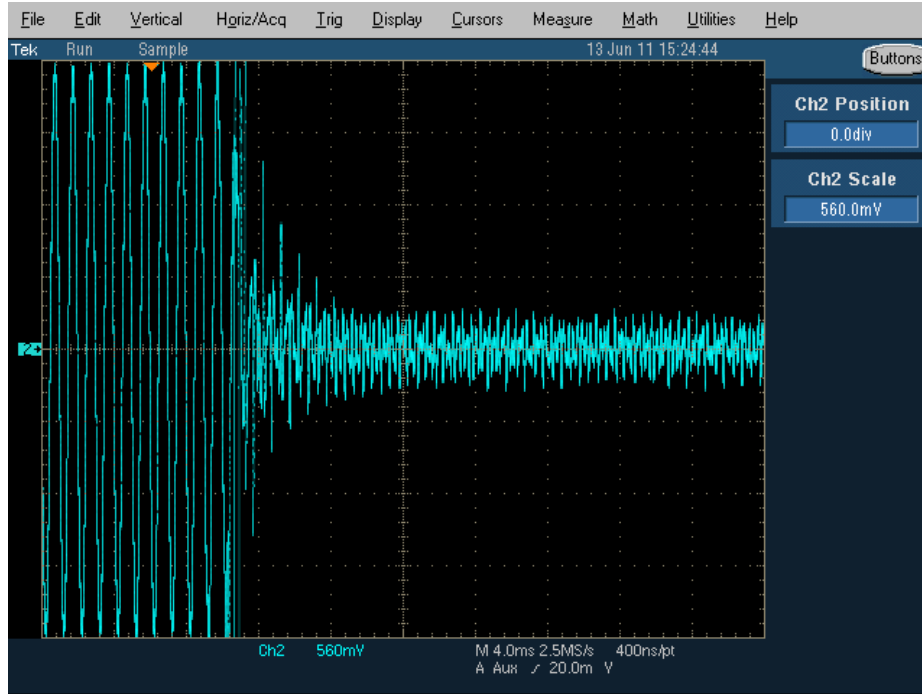

Powering Down

