

JANUS® MULTI-PROTOCOL READER VER. 2

OPERATOR AND MAINTENANCE MANUAL

QMS EDITION - ISO9001:2008

DOCUMENT: UM 360450-210

REVISION:C

DATE: August 17, 2015

Editor: Michael Kleiza

Reviewer Title	Reviewer Name	Reviewer Signature
<i>Systems Engineering</i>	Stuart Lewis	Stuart Lewis
<i>Project Manager</i>	Ed Rolo	Ed Rolo
<i>Product Manager</i>	Jaymin Patel	Jaymin Patel
<i>Software Engineering Manager</i>	Dan Terrier	Dan Terrier
<i>Hardware Engineering Manager</i>	Ed Rolo	Ed Rolo
<i>Technical Services</i>	Tim Oaks	Tim Oaks
Approval		
<i>VP Research & Development</i>	Ed Rolo	Ed Rolo
<i>VP Systems Engineering</i>	Chris Hopkins	Chris Hopkins

Confidential

UM 360450-210 Revision: C

Kapsch TrafficCom Canada Inc. 2015

These drawings and specifications contain confidential and proprietary information and are the property of Kapsch TrafficCom Canada Inc. and are issued in strict confidence and will be kept confidential and used solely for the purpose intended and for no other purpose and shall not be transmitted, reproduced, copied, and/or used as the basis for manufacture or sale of apparatus unless otherwise agreed to in writing by Kapsch TrafficCom Canada Inc.

JANUS® MULTI-PROTOCOL READER VER. 2

OPERATOR AND MAINTENANCE MANUAL

QMS EDITION - ISO9001:2008

DOCUMENT: UM 360450-210

REVISION:C

DATE: August 17, 2015

Kapsch TrafficCom:

6020 AMBLER DRIVE	8201 GREENSBORO DRIVE , SUITE 1002
MISSISSAUGA, ON L4W 2P1	MCLEAN, VA 22102
TEL: (905) 624-3025	TEL: (703) 885-1976
FAX: (905) 624-4572	FAX: (703) 790-9100

This Page Intentionally Left Blank

FCC License Notice:

This equipment emits RF signals. In order to operate this equipment the customer must obtain a separate FCC Part 90 Site license for each location. In addition, the FCC ID component identification **JQU802295** must appear on a label on the front of the RF Modules installed in these Readers.

The power output of a module at ambient ($P_{out(amb)}$) shall be constrained using internal or external Tx attenuation so that the following is satisfied:

$$P_{out(amb)} \leq 43.77 \text{ dBm} - G_{fund};$$

Where G_{fund} is the net gain from antenna connector on the RF module to the antenna radiated signal. The antenna gain is expressed in **dBd**.

The Power output from the amplifier assembly of a module plus external amplifier at ambient (AmpOut(amb)) shall be constrained using module internal TX attenuation so that the following are both satisfied:

$$\text{AmpOut(amb)}: \leq 39 \text{ dBm}; \text{ and}$$

$$\text{AmpOut(amb)}: \leq 43.77 \text{ dBm} - G_{fund};$$

where G_{fund} is the net gain at fundamental frequency from the antenna connection on the amplifier assembly to the antenna radiated signal where the antenna gain is expressed in dBd.

The net gain at the second harmonic from the antenna connection on the amplifier assembly to the antenna radiated signal shall be:

$$G_{2nd} \leq G_{fund} - 14 \text{ dB}.$$

NOTE: This device complies with Part 15 of the FCC Rules. Operation is subject to the condition that this device does not cause harmful interference.

NOTE: This equipment has been tested and found to comply with the limits for a Class A digital device, pursuant to Part 15 of the FCC Rules. These limits are designed to provide reasonable protection against harmful interference when the equipment is operated in a commercial environment. This equipment generates, uses, and can radiate radio frequency energy and, if not installed and used in accordance with the instruction manual, may cause harmful interference to radio communications. Operation of this equipment in a residential area is likely to cause harmful interference in which case the user will be required to correct the interference at their expense.

Changes or modifications not expressly approved by Kapsch TrafficCom could void FCC compliance and the authority to operate the equipment.

NOTE: IEC 60950-1 and/or EN60950-1, First Edition, Information Technology Equipment – Safety – Part 1: General Requirements require that this equipment must be located in a RESTRICTED ACCESS LOCATION (RAL). Only authorized personnel can have access to the equipment.

MODEL 802295AA PART 2 of 2 RF AMPLIFIER ASSEMBLY
The amplifier is only approved for use with the corresponding module (part 1 of this model)
115VAC, 2A, 60Hz

SOFTWARE/FIRMWARE NOTE

The current software set is identified in the Software Release document.

The active Reader firmware version is displayed in the Reader browser

FACTORY SUPPORT SERVICE

For Return Material Authorization (RMA) numbers please telephone: 905 624-3020.

NOTICE

The information presented in this document is current although it is subject to change. As such, **Kapsch TrafficCom** assumes no liability on behalf of the USER with respect to interpretation based on the use of this information

Kapsch TrafficCom ©2014

COPYRIGHT STATEMENT

This technical manual contains confidential and proprietary information and is the property of

Kapsch TrafficCom

and is issued in strict confidence and will be kept confidential and used solely for the purpose intended and for no other purpose and shall not be transmitted, reproduced, copied, and/or used as the basis for manufacture or sale of apparatus

IMPORTANT!**NOTICE OF PATENTS:**

Kapsch TrafficCom

has patented or has patents pending on critical design features of the item or items described herein. Contact Kapsch TrafficCom for all queries regarding patents.

Note sur la license FCC:

Cet équipement émet des signaux de radiofréquence. Afin d'utiliser cet équipement, l'utilisateur est dans l'obligation d'obtenir une License de site FCC partie 90 distincte pour chaque lieu d'utilisation. De plus, l'identifiant des composants FCC ID **JQU802295** doit apparaître sur le label installé sur la face avant des modules RF installé dans le châssis-lecteur.

La puissance de sortie d'un module à ambient ($P_{out(amb)}$) doit être limitée en utilisant une atténuation interne ou externe Tx de manière à ce que l'équation suivante soit satisfaite :

$$P_{out(amb)} \leq 43.77 \text{ dBm} - G_{fund};$$

où G_{fund} est le gain net du connecteur de l'antenne au niveau du module RF au signal rayonné par l'antenne. Le gain d'antenne est exprimé en **dBd**.

La puissance de sortie d'un ensemble amplificateur d'un module plus l'amplificateur externe à ambient (AmpOut(amb)) doit être limité en utilisant une atténuation interne TX de manière à ce que les équations suivantes soient toutes deux satisfaites :

$$\text{AmpOut(amb): } \leq 39 \text{ dBm; et}$$

$$\text{AmpOut(amb): } \leq 43.77 \text{ dBm} - G_{fund};$$

où G_{fund} est le gain net à la fréquence fondamentale de la connexion d'antenne au niveau de l'ensemble amplificateur au signal rayonnée par l'antenne , où le gain d'antenne est exprimé en dBd.

Le gain net au second harmonique de la connexion d'antenne au niveau de l'ensemble amplificateur au signal rayonnée par l'antenne doit être :

$$G_{2nd} \leq G_{fund} - 14\text{dB}.$$

NOTE: Cet appareil est conforme à la partie 15 des Règles de la FCC. Son utilisation est sujette à la condition qu'il ne puisse pas causer d'interférences nuisibles

NOTE: Cet appareil a été testé et reconnu conforme aux normes applicables aux appareils informatiques de Classe A, en vertu de l'article 15 des réglementations de la FCC. Cette réglementation vise à assurer une protection suffisante contre les interférences nuisibles lorsque l'équipement est utilisé dans un environnement commercial. Cet appareil génère, utilise et rayonne de l'énergie de fréquences radio et peut, en cas d'installation ou d'utilisation non conforme aux instructions, engendrer des interférences nuisibles au niveau des communications radio. L'utilisation de cet appareil dans une installation résidentielle entraînerait probablement des interférences nuisibles, lesquelles devront être corrigées aux frais de l'utilisateur.

Tout changement ou modification n'ayant pas été expressément approuvé(e) par Kapsch TrafficCom pourrait rendre nul la conformité aux règles de la FCC ainsi que le droit de l'utilisateur d'utiliser cet équipement.

NOTE: IEC 60950-1 and/or EN60950-1, First Edition, Information Technology Equipment – Safety – Part 1: Les exigences générales stipulent que cet équipement doit être situé dans une ZONE d'ACCES RESTREINT. Seul le personnel autorisé peut avoir accès à cet équipement.

**MODEL 802295AA PART 2 of 2 Ensemble Amplificateur RF
L'amplificateur est uniquement pour un usage avec le module correspondant (part 1 of
this model)
115VAC, 2A, 60Hz**

NOTE A PROPOS DU LOGICIEL/FIRMWARE

Le logiciel actuellement installé est identifié dans le document « Software Release document ».

La version du firmware installé sur le lecteur est identifié sur la page web du lecteur.

SUPPORT TECHNIQUE

Pour obtenir des numéros d'autorisation de retours de marchandises, veuillez téléphoner au : 905 624-3020.

NOTE

L'information présentée dans ce document est actuelle bien qu'elle soit sujette à changement. Pour cette raison, **Kapsch TrafficCom** ne pourra pas être tenu responsable de la manière dont l'utilisateur interprète et utilise cette information.

Kapsch TrafficCom ©2014

COPYRIGHT STATEMENT

Ce manuel technique contient des informations confidentielles et propriétaires et est la propriété de

Kapsch TrafficCom

et est édité dans la plus stricte confidentialité et sera gardé confidentiel et uniquement utilisé dans le but prévu et non pour d'autres buts, et ne doit pas être transmis, reproduit, copié et/ou utilisé comme modèle pour la fabrication ou la vente d'appareils sauf dans le cas d'une autorisation écrite de Kapsch TrafficCom IVHS Corp.

IMPORTANT !**AVIS sur les BREVETS**

Kapsch TrafficCom

A breveté ou possède des brevets en attente concernant des caractéristiques principales du ou des composants décrit dans ce document. Contactez Kapsch TrafficCom pour tout requête concernant des brevets.

Document Revision Control

Version Date	Revision	Editor	Changes
2015-08-17	C	E. Rolo	ECN 15059 Updates to the provide the FCC License Note and the Software/Firmware Note in both French and English to satisfy the Industry Canada requirements. Effectively adding pages 6, 7, and 8. Change formula on Pages 3 and 6 as follows, G2nd <= Gfund - 14dB
2015-07-15	B	E. Rolo	Initial Release

Table of Contents

1. ABOUT THIS MANUAL..... 20

Technical Background..... 20

Assumptions..... 20

Warnings and Cautions..... 20

 Warnings..... 20

 Cautions 22

 Conventions used in this manual..... 23

 How to use this manual 24

2. OVERVIEW 27

Introduction 27

How the JANUS MPR2 Electronic Toll Collection (ETC) Subsystem works 27

 Active OBU 27

 Passive OBU 27

JANUS MPR system components..... 27

 Antenna 29

 IAG Antenna specifications 30

 Module Descriptions..... 32

 CTM MC..... 36

 CTM CGC 36

 The CTM web interface..... 42

3. OPERATING PROCEDURES..... 45

Starting up the Reader 45

Shutting down the Reader..... 45

Manually switching a Reader to the redundant side 46

Connecting a service laptop to the Reader 47

 Changing the service laptop IP address 47

 Testing the connection to the reader 47

Accessing the CTM web interface 47

Logging out of the CTM web interface51

Changing your password51

Resetting a forgotten password51

Configuring the Reader to recover automatically to the primary side52

Monitoring the Reader.....53

- Reader status 53

 - Communications 54
 - Power Supply Module 55
 - RF Modules..... 56
 - Miscellaneous Information 58

- RF Channel Statistics 60

 - Reports by channel..... 60
 - Uptime / CPU Load 62
 - Faults 63
 - Transaction Buffering 64
 - Handshakes 65

Monitoring OBU transactions as they occur via the Diagnostics page 65

Continuously logging transactions to a USB flash drive 66

Continuously logging transactions using the Ethernet..... 68

OBU Programming70

- Configuring OBU programming for Traffic Management Applications 72
- Configuring OBU programming for Toll Collection applications..... 72

Configuring Toll charges75

- BAT 1 tolling (deducting charges based on lane and vehicle type) 75
- BAT 2 tolling (deducting charges based on entry and exit location) 75

Configuring Protocols.....76

Configuration.....78

4. THEORY OF OPERATIONS 153

- Active OBUs153**
- Passive OBUs153**

Capture zones	153
Superframes.....	154
Multi-protocol RF Module Smart.....	154
Power Supply Module (PSM).....	154
Lane Controller Port Module (LPM).....	157
Sync Port Module (SPM).....	157
Controller Module (CTM)	157
Main Controller (MC).....	157
Channel Group Controller Module (CGC)	158
Configuration Module (CFM).....	158
Distribution Module (DSM)	158
Synchronization.....	158
How Reader synchronization operates at the toll location	159
The Sync Recovery Process.....	159
Log files	160
Transaction logs.....	160
Transaction Buffering	162
Event Logs.....	162
Trouble Logs.....	163
 5. INSTALLATION.....	 164
Introduction	164
The earth ground system.....	164
Lightning protectors	165
Installing the Reader hardware	166
Installing a Lane Kit	169
Installing an Antenna	169
Installing the MRFM-S Modules.....	172
Installing the RF cables	172

Performing Lane Tuning 175

The Synchronization circuit 176
 Installing a synchronization circuit 176

Synchronization between MPR2 Readers..... 179
 Configuring synchronization 180

Synchronization between JANUS® Readers and BADGER Readers 181
 Configuring Synchronization 181

The Ethernet Network 183
 Installing an Ethernet network 183

Reader connections to the LC via the LPM serial ports 185
 Configuring reader connections 185

IP addresses 186
 Setting the IP addresses..... 187
 Configuring an LC Ethernet network..... 187
 Configuring the Ethernet 1 IP address via the Diagnostic Port..... 189

Lane Assignment voting for ORT applications 189
 Selecting the correct communication method 189
 Configuring Lane Voting over an Inter-Reader (IR) network 189
 Configure how multiple transactions are reported to the LC: 190
 Configuring Badger-style Cross Reader Algorithm (CRA) communication..... 191
 Selecting the Voting Algorithm 193
 Configuring Voting Time 193
 Manually set the voting time for a channel 193
 Allowing the Reader to calculate the optimum voting time using Dynamic Voting Control 195
 Configuring Channel Weight for straddle antennas 196

6. TROUBLESHOOTING AND TESTING 199

Troubleshooting Methodology..... 199

LED Statuses 201

Troubleshooting tree: LC Ethernet 1 Port communications not working 204

Troubleshooting tree: Ethernet 2 Port communications not working..... 205

Troubleshooting tree: LPM Serial Port communications not working 206

Troubleshooting tree: MRFM-S not working 207

Troubleshooting tree: Synchronization not working..... 208
 Constant busy state on sync bus..... 209
 Sync board Failure Indicator for incomplete cable connections 209

Troubleshooting tree: Reader does not automatically switch back to Primary side after fault recovery 210

Troubleshooting tree: Simultaneous faults on Primary and Secondary CTMs 211

Identifying failures on the primary and/or secondary side 212
 Primary and/or Secondary side failure is indicated by any of the following conditions: 212
 Primary side failure is indicated by any of the following conditions 212
 Secondary side failure is indicated by any of the following conditions:..... 212

Events that cause an automatic switchover..... 212

Reader recovery actions 214

Testing the CTM Ethernet 1 port 215

Testing an LPM COM port..... 215

Testing the Synchronization Circuit 217
 Testing the SPM and CTM..... 217
 Testing the Synchronization hub cabling..... 218

Testing the MRFM-S slots 218

7. MAINTENANCE PROCEDURES 220

Corrective maintenance procedures..... 220

Preventive maintenance procedures and scheduling 221
 Once a year: 221
 With power off: 221
 Every 4.5 years:..... 221

MRFM-S replacement..... 222
 Removing an MRFM-S 222
 Installing an MRFM-S..... 224

Antenna replacement..... 225
 Removing an antenna..... 225
 Installing an antenna 226

RF cable or connector replacement.....	227
Removing RF cable/connector	227
Installing an RF cable/connector	228
CTM replacement	229
Removing a CTM	230
Installing a CTM	230
SPM replacement.....	231
Removing an SPM	231
Installing an SPM	231
LPM replacement.....	231
Removing an LPM	231
Installing an LPM.....	232
PSM replacement.....	232
Removing a PSM	232
Installing a PSM.....	233
CFM replacement.....	233
Removing a CFM	233
Installing a CFM.....	233
Replacing a PSM fuse	234
Rebooting the CTM	235
Rebooting using CTM ON/OFF switch.....	235
Rebooting from the browser interface	235
Configuring events that cause a switchover	237
Manually select the active side and disable switchover	238
Letting the Reader automatically choose the active side	238
Enabling the Reader to recover automatically to the primary side	238
Configuring the Reader to switch over automatically when an LC link is down	238
Configuring the Reader to switch over when the Ethernet IR link is down	241
Configuring the Reader to switchover based on Test tag feedback (if present)	241
New firmware	241
Uploading new firmware	242
Activating new firmware.....	243
On the Primary side:	244
On the Secondary side:	245
Deleting firmware	245
Saving the Reader configuration.....	246
Uploading a saved configuration	246

Resetting the Reader configuration to the factory default 247

Administration 248

 Creating a new user 248

 Changing a user’s access permissions 249

 Deleting a user..... 250

 Verifying a computer is communicating with a specific CTM..... 250

Using an NTP Server to synchronize the clocks of Readers in an IR network..... 250

Manually setting the Reader time and date 251

Logging transactions remotely via an Ethernet connection 252

Monitoring OBU transactions as they occur via the DIAGNOSTIC PORT..... 252

Saving Reader log files to a computer 252

Manually saving a Reader log file to a USB flash drive..... 253

APPENDIX A MISCELLANEOUS255

Using PuTTY to connect to the DIAGNOSTIC PORT 255

Using HyperTerminal to connect to the DIAGNOSTIC PORT 255

Using RealTerm to connect to the MRFM-S..... 256

Accessing Documentation 257

Technical Specifications and Pin outs 258

Antenna Specifications 264

 Antenna Environmental Specifications..... 265

RF Cable Specifications 265

 Synchronization cable specifications 266

 Maximum Sync Cable Length..... 266

 Sync Cable Requirements 266

Terminal Block..... 267

Spares and Tools 267

 Test Equipment..... 268

 Test Vehicles 268

Reference Documents	269
Other commercial Documents	269
Acronyms and Synonyms	270
Glossary	278
Differences between the Badger and JANUS® Readers	281
APPENDIX B NON-REDUNDANT READER	287

List of Figures

FIGURE 2-1: A REDUNDANT READER	29
FIGURE 2-2: IAG 3 ANTENNA	30
FIGURE 4-1: READER POWER DISTRIBUTION	156
FIGURE 5-1: EARTH GROUND SYSTEM (WITH RECOMMENDED LIGHTNING PROTECTORS SHOWN)	165
FIGURE 5-2: AC MAINS	167
FIGURE 5-3: LC DATA CABLE INSTALLATION	168
FIGURE 5-4: INLINE ANTENNA INSTALLATION	170
FIGURE 5-5: STAGGERED ANTENNA INSTALLATION	171
FIGURE 5-6: RF CABLE INSTALLATION SCHEMATIC BI-STATIC OPERATION	174
FIGURE 5-7: RF CABLE INSTALLATION SCHEMATIC BI-STATIC OPERATION WITH RF AMPLIFIER	175
FIGURE 5-8: RF CABLE INSTALLATION SCHEMATIC BI-STATIC TDM/6C ONLY OPERATION	175
FIGURE 5-9: SYNCHRONIZATION CIRCUIT SCHEMATIC FOR THREE READERS	179
FIGURE 5-10: SCHEMATIC OF A THREE-READER IR NETWORK	184
FIGURE 5-11: SCHEMATIC OF A THREE-READER LC NETWORK	184
FIGURE 5-12: TWO READERS COMMUNICATING WITH ONE OBU	189
FIGURE 5-13: THREE READERS COVERING ONE DIRECTION OF WIDE LANE ORT TRAFFIC	191
FIGURE 5-14: THREE WIDE ORT LANES WITH TWO STRADDLE ANTENNAS	198
FIGURE 6-1: SIGNAL FLOW DIAGRAMS	200
FIGURE 6-2: TYPICAL MRFM-S HEARTBEAT MESSAGE	215
FIGURE 7-1: PSM FUSE AND FUSE HOLDER	234

List of Tables

TABLE 2-1: IAG ANTENNA SPECIFICATIONS	30
TABLE 3-1: COMMUNICATIONS FIELDS	54
TABLE 3-2: POWER SUPPLY MODULE FIELDS	56
TABLE 3-3: RF MODULES FIELDS	57
TABLE 3-4: MISCELLANEOUS INFORMATION FIELDS	59
TABLE 3-5: REPORTS BY CHANNEL	62

TABLE 3-6: COMMANDS AND CONTROLS	78
TABLE 4-1: MRFM-S SIGNALS TO AND FROM DSM	154
TABLE 4-2: BOOLEAN LOGIC TRUTH TABLE FOR SYNCHRONIZATION OF TWO READERS	159
TABLE 4-3: LIST OF AVAILABLE LOG FILES	160
TABLE 4-4: LIST OF FIELDS IN A TRANSACTION LOG REPORT	160
TABLE 5-1: LOCATIONS FOR THE INSTALLATION OF LIGHTNING PROTECTORS	166
TABLE 5-2: ANTENNA MOUNTING FOR THE IAG 3 ANTENNA AND LANE CONFIGURATION	169
TABLE 5-3: SYNCHRONIZATION COMPATIBILITY MATRIX – JANUS® AND BADGER	183
TABLE 6-1: CTM LED STATES EXPLAINED.....	202
TABLE 6-2: PSM LED STATES EXPLAINED.....	203
TABLE 6-3: MRFM-S LED STATES EXPLAINED	203
TABLE 6-4: SWITCHOVER TRIGGERS.....	212
TABLE 6-5: FAILURES AND THE READER RECOVERY ACTIONS THEY TRIGGER.....	214
TABLE 6-6: MRFM-S FAULT CODES.....	215
TABLE 7-1: IMPORTANT DIFFERENCES BETWEEN THE BADGER READER AND THE JANUS READER	281

This Page Intentionally Left Blank

1. ABOUT THIS MANUAL

The JANUS® Multi-Protocol Reader Ver. 2 Operations and Maintenance Manual consists of two main parts :

- Operations
- Maintenance

Sections and subsections within these main parts are used to present theoretical as well as practical and procedural information. See the table of contents for more details on each section.

This manual is the main reference document used during training. Training is provided by Kapsch TrafficCom for the following personnel.

- Operations
- Installations
- Maintenance
- Service

This manual is also used as a reference by Kapsch TrafficCom for its service-certified technical service personnel in the field once training has been completed.

Technical Background

Personnel must have an electrical/electronic technical background and some prior experience using web browsers.

Assumptions

A redundant JANUS® Multi-Protocol Reader Ver. 2 used for Electronic Toll Collection (ETC) is assumed throughout the manual.

Warnings and Cautions

Warnings

Warnings indicate a risk of bodily harm and include a symbol indicating the type of injury risked.

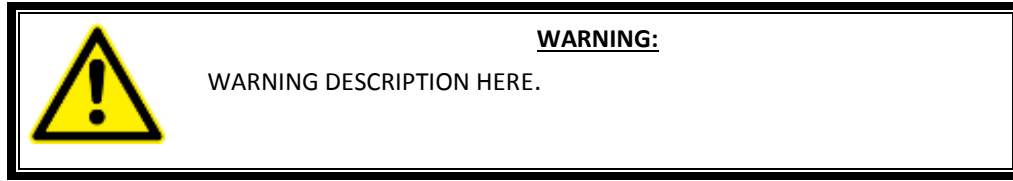

The following warnings appear in the manual:



AN IMPROPERLY GROUNDED READER COULD RESULT IN ELECTRIC SHOCK. ENSURE A HIGH CURRENT EARTH GROUND CONNECTION IS ESTABLISHED BEFORE CONNECTING SUPPLY POWER TO THE READER.



THE MODULES MAY HAVE SHARP EDGES. HANDLE THE MODULES CAREFULLY. WHENEVER POSSIBLE, USE A MODULE EXTRACTION TOOL TO REMOVE A MODULE.



THE MRFM-S MAY BECOME HOT UNDER NORMAL OPERATING CONDITIONS. ENSURE THE MRFM-S HAS COOLED DOWN OR WEAR GLOVES WHEN HANDLING THE MRFM-S.



THE PSM MAY BECOME HOT UNDER NORMAL OPERATING CONDITIONS. ENSURE THE PSM HAS COOLED DOWN OR WEAR GLOVES WHEN HANDLING THE PSM.



EXPOSED HIGH VOLTAGE IS PRESENT IN THE PSM. ENSURE THAT THE POWER SWITCH IS SET TO THE OFF POSITION AND THAT THE AC INPUT POWER CORD IS DISCONNECTED BEFORE REMOVING THE PSM.



INSTALLING A FUSE OF THE WRONG TYPE OR RATING MAY CAUSE A FIRE. ENSURE A TIME-LAG FUSE RATED FOR 10A, 250VAC IS INSTALLED.

Cautions

Cautions indicate a risk of damage to equipment or loss of data.



The following cautions appear in the manual:

Improper modification of configuration parameters may adversely affect system operation. The default values may not be appropriate for the specific application. It is the system integrator's responsibility to tailor the configuration parameters to the specific operating environment.

Both CTMs in a redundant Reader must be properly configured. Each CTM has its own browser interface and is configured independently. Ensure any configuration changes made to one CTM are applied to the other CTM.

Log file formats are not under ICD control and the format may change without prior notification. Log files are for diagnostic purposes only and are not guaranteed to be maintained in non-volatile storage.

Excessive bending or kinking can damage the RF feedline cables. Do not excessively bend or kink the RF feedline cables when installing them between the antennas to the Reader enclosure.

Removing a powered CTM from the Reader rack can damage the CTM. Before removing a CTM from the Reader, ensure that power on the affected side of the Reader is turned off, i.e. the power switch on the PSM is in the off position, or the PSM AC input power cord is disconnected.

To avoid damaging the modules, ensure that the connector on the module is properly aligned with the connector on the DSM back plane before the module is securely plugged into the DSM.

Activating inactive factory firmware on a running system is not recommended. The factory firmware may not be appropriate for the specific application.

During firmware activation (typically less than 60 seconds), the Reader will switch over to the other side to process and report transactions, regardless of the position of the mode switch on the SPM module. Ensure that the other side is running normally and all lane controller links are functioning. The Reader will be unable to process or report transactions if it is unable to switch over to the other side.

During firmware activation (typically less than 60 seconds), a non-redundant Reader is unable to process or report transactions.

The factory default configuration should not be restored on a running Reader. The factory firmware may not be appropriate for the specific application. Save the current Reader configuration before resetting the Reader configuration to the factory default.

On one redundant reader of a synchronization network, the synchronization connection should be looped back and this reader will declare sync even if it is disconnected from the other readers

To avoid damaging the RF adaptor cables, ensure they do not protrude to where items on the back of the cabinet doors can damage or press on them. Use 90-degree SMA adaptors where required.

Keep at least 100 cm away from the radiating face of the antenna when the RF module is connected and operating.

Conventions used in this manual

The following information is provided to the user to aid in understanding and readability.

Highlighting and callouts are used in the guide to indicate importance, or to indicate a change to the user.

Bolding of words is used in the following cases:

- To indicate that an action is required (example: Click the **Next** button.)
- To indicate a main menu item and/or a menu option (example: From the **Tag Programming** screen, select the **Enable TMP** check box.

When required, tables listing screen fieldnames and/or column headings and their definitions or meanings are placed below selected screens to aid in understanding technical terms.

Decision tables are used when procedures have more than one option from which to choose.

Example:

IF you logged into an account that ...	THEN ...
has User Admin permissions,	navigate to the Change Password tab on the User Management page. Go to step 3.
does NOT have User Admin permissions,	from ANY page, click Change Password in the navigation sidebar. Result: The User Management Change Password page appears. Go to step 3.

How to use this manual

The JANUS® Multi-Protocol Reader Ver. 2 Operations and Maintenance Manual requires no special instructions on how to use it.

Topics can be found in the Table of Contents at the beginning of the manual to help with navigation.

If an online version of the guide is used, both the Table of Contents topics, and page and subject cross-references within the body of the document are hyperlinked to their associated subject matter.

OPERATING INSTRUCTIONS

This Page Intentionally Left Blank

2. OVERVIEW

Introduction

The JANUS® Multi-Protocol Reader Ver. 2 (MPR2) is part of the Electronic Toll Collection (ETC) Subsystem. Toll collection is the primary use of the Reader.

How the JANUS MPR2 Electronic Toll Collection (ETC) Subsystem works

The MPR2 reader can interact with both active and passive OBUs.

Active OBU

For an active OBU, overhead antennas send out RF signals. As a vehicle equipped with an active OBU approaches a toll zone, the OBU receives an RF signal from the antenna. The OBU then starts transmitting data, which is received by the antenna and passed on to the Reader via an MRFM-S module. The Reader processes and logs the OBU data, and then sends the information to the Lane Controllers (LCs). The Reader can also send data back to the OBU, such as an updated toll account balance.

Passive OBU

For a passive OBU, the antenna sends out a command or a continuous wave via an RF signal. As a vehicle equipped with a passive OBU approaches a toll zone, the OBU receives an RF signal from the antenna. If commanded, the OBU then starts transmitting data, which is received by the antenna and passed on to the Reader via an MRFM-S module. The Reader processes and logs the OBU data, and then sends the information to the Lane Controllers (LCs). The Reader can also send data back to the OBU.

JANUS MPR2 is factory configured to enable the specific protocols requested at the time of order. While multiple protocols may be displayed on the Web interface, only those protocols factory configured at the time of order are active. To activate additional protocols after delivery, contact Kapsch Sales.

JANUS MPR system components

Figure 2-1: A Redundant Reader shows a rack equipped with eight Smart MRF modules (MRFM-S).

A Lane Kit consists of:

- An antenna (see Figure 2-2)
- An MRFM-S (② in Figure 2-1: A Redundant Reader)
- Two feedline adapter cables
- One Circulator

- One Circulator adapter cable. (3'5" for 902-904MHz, 3'3" for all other frequencies)

The redundant Reader consists of:

Note: Numbers in the list below refer to those associated with Figure 2-1: A Redundant Reader. The DSM, and CFM are not shown in the figure.

- One rack and Distribution Module ①
- Two Controller Modules (CTM) ③, each equipped with an internal Main Controller (MC) and one Channel Group Controller (CGC)
- Two Configuration Modules (CFMs) attached directly to the DSM
- One Synchronization Port Module (SPM) ④
- Two Lane Port Modules (LPM) ⑤
- One secondary Power Supply Module (PSM) ⑥
- One primary Power Supply Module (PSM) ⑦
- AC Power cords for the PSM's ⑧

Note: Non-redundant Readers contain one CTM, one CFM, one LPM, and one PSM. For an illustration of a non-redundant reader, see Appendix B.

Additional installation components required are:

- Two RF cables from Reader to Circulator (type N male to type N female)
- Sealing tapes for RF connectors exposed to weather
- Lightning arrestors
- Optional Ethernet switch modules (ESMs)
- Sync and inter-reader Ethernet cabling (if required)
- Ethernet cables if ESMs used
- 300 CFM fan tray for operation above 131°F (55°C)

Additional Site requirements are:

- Cabinet with AC power, grounding, including reader ground bar,
- Mounting structure for antenna
- Ethernet or Serial cables to connect to the lane Controller(s)

Figure 2-1: A Redundant Reader

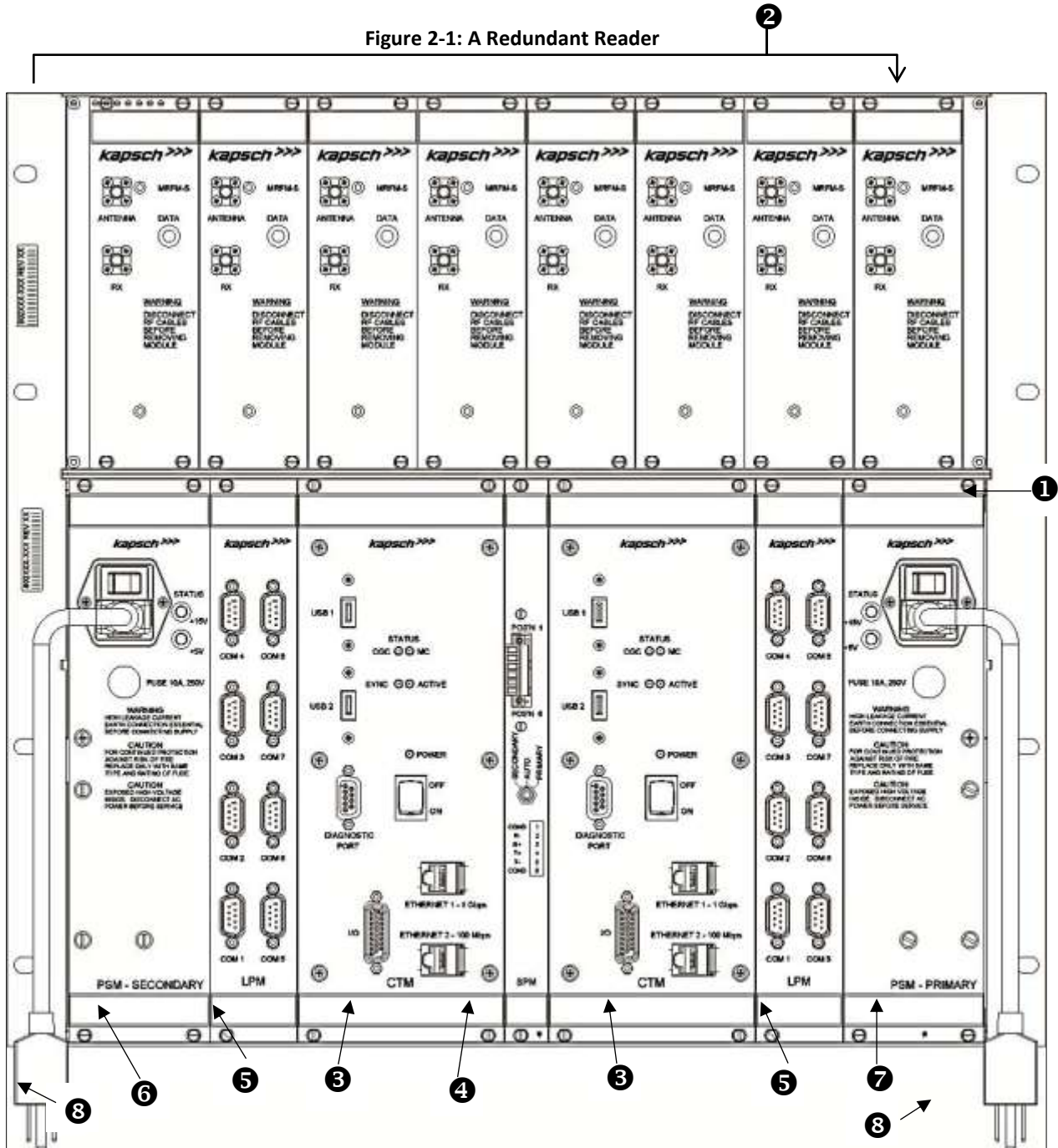

Antenna

The antenna sends and receives RF signals to and from the vehicle On Board Units (OBUs). The IAG 3 antenna is recommended for the MPR2 reader. See Antenna Specifications, page 264 for more details. Figure 2-2 shows an illustration of the IAG 3 antenna, one of the recommended antennas for the Multi-protocol Reader.

Figure 2-2: IAG 3 Antenna

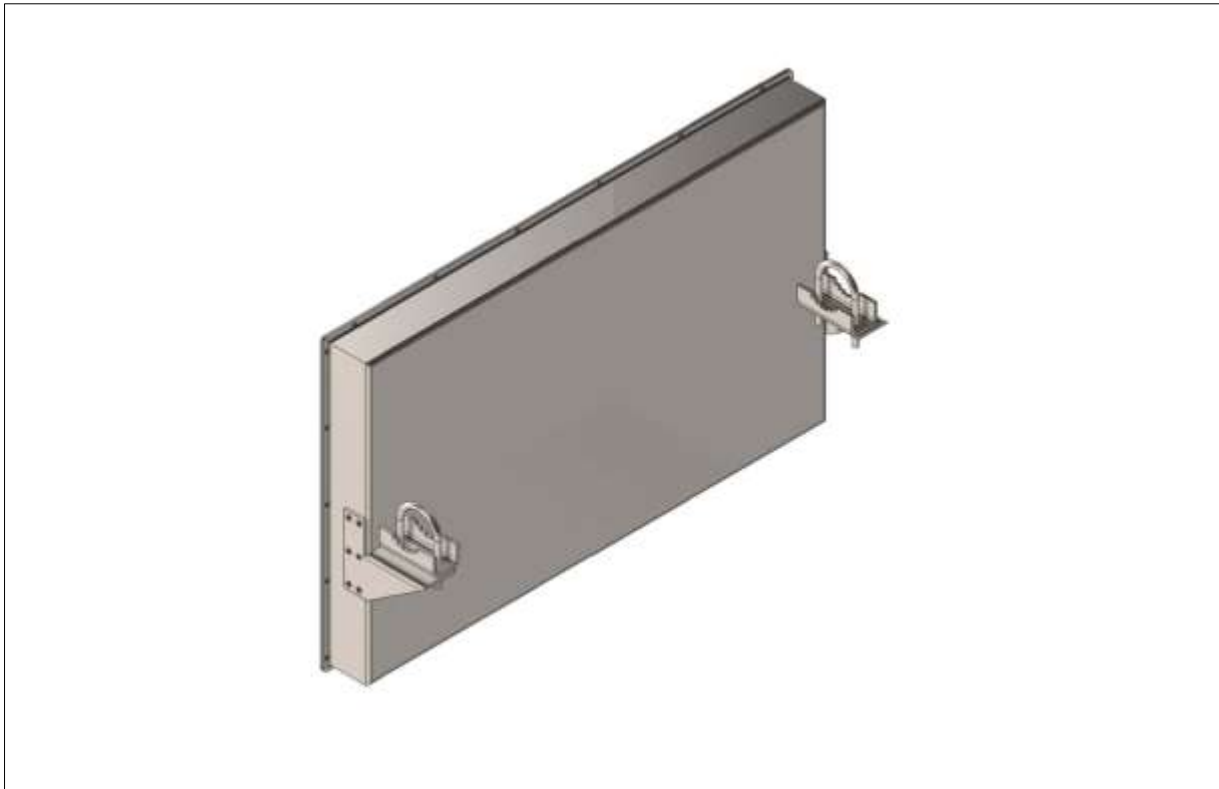

IAG Antenna specifications

Table 2-1: IAG Antenna Specifications

P/N	Lane Kit #	Description	Width (in inches)	Length (in inches)	Depth (in inches)	Weight ¹ (in lbs)	Mounting
800260-015	802344-TAB	3x4 dipole array	34.5	21.25	3.13	19	horizontal
800260-011	802344-TAB	3x3 Patch	34.5	31.75	2.3	28	horizontal

Note: Mounting information is provided as a guideline.

Weight specified is applicable to the antenna structure only, that is, it does not include mounting hardware.

Module Descriptions

Smart Multi-protocol RF Module (MRFM-S)	
Function	<p>Converts digital data from the Reader to an analog RF signal that is sent to the OBU via the antenna.</p> <p>Converts the analog RF signal collected from the OBU via the antenna into a digital signal that is sent to the CGC module via the DSM.</p>
Units per Redundant Reader	One MRFM-S for each antenna. A maximum of 8 MRFM-S per Reader.
Redundant	No
Normal State	The DATA LED 1 illuminates solid green when RF data is being transmitted.
Connections	<p>The MRFM-S module can support bi-static output configurations.</p> <p>In bi-static output configurations, both connections 2 and 3 are connected by an RF cable to the antenna.</p>

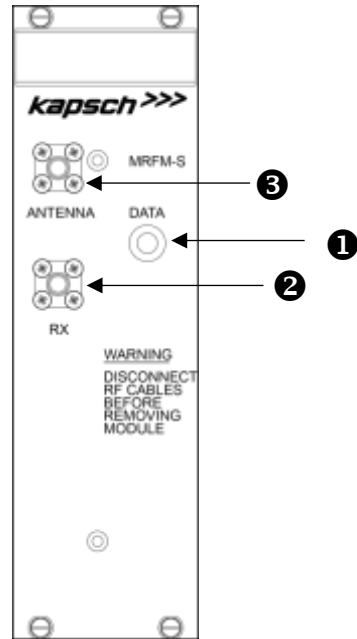

Distributions Module (DSM) and Rack	
Function	The DSM is the back plane of the Reader rack.
Units per Redundant Reader	One DSM and one Rack
Connections	<p>The MRFM-S, PSM, LPM, CTM, and SPM modules slide into the Rack and connect to the DSM.</p> <p>The CFMs attach directly to the DSM.</p>

Configuration Module (CFM)		
<p>Function</p>	<p>Stores the Reader configuration file so that the Reader configuration is retained when the CTMs fail or are removed.</p>	<p style="text-align: center;">Configuration Module</p>
<p>Units per Redundant Reader</p>	<p>One CFM on the secondary side 1, One CFM on the primary side 2</p>	
<p>Connections</p>	<p>The CFMs attach directly to the DSM in the secondary location 1 and the primary location 2.</p> <p>CFMs should not be swapped between readers or within the reader.</p>	

Control Module (CTM)										
Function	<p>Contains the Reader processor (MC), the Channel Group Controller module (CGC).</p> <p>Allows the CTM to be reset with the CTM ON/OFF switch 7.</p> <p>Controls when the RF modules are interrogated.</p>	X								
Units per Redundant Reader	<p>One CTM on primary side, One CTM on secondary side</p>									
Normal State	<p>The POWER LED 8 illuminates green when the CTM is on and is receiving power from the PSM.</p> <p>The STATUS LEDs 9 illuminate green to indicate SYNC is functional, CTM is active, CGC is functional and MC is functional.</p>									
Connections	<table border="1" style="width: 100%; border-collapse: collapse;"> <thead> <tr> <th style="width: 30%;">Port</th> <th style="width: 70%;">Function</th> </tr> </thead> <tbody> <tr> <td>ETHERNET 1 - 1 Gbps 1</td> <td>One option for connecting a service laptop directly to the Reader, or, for creating a network to connect the Readers and LCs together.</td> </tr> <tr> <td>ETHERNET 2 – 100 Mbps 2</td> <td>For connecting several Readers together to create an Inter-Reader (IR) network, or for connecting a service laptop when Ethernet 1 is connected to the Lane Controller.</td> </tr> <tr> <td>DIAGNOSTIC PORT 3</td> <td>A second option for connecting a service laptop directly to the Reader. The browser interface cannot be accessed from this port.</td> </tr> </tbody> </table>	Port	Function	ETHERNET 1 - 1 Gbps 1	One option for connecting a service laptop directly to the Reader, or, for creating a network to connect the Readers and LCs together.	ETHERNET 2 – 100 Mbps 2	For connecting several Readers together to create an Inter-Reader (IR) network, or for connecting a service laptop when Ethernet 1 is connected to the Lane Controller.	DIAGNOSTIC PORT 3	A second option for connecting a service laptop directly to the Reader. The browser interface cannot be accessed from this port.	
Port	Function									
ETHERNET 1 - 1 Gbps 1	One option for connecting a service laptop directly to the Reader, or, for creating a network to connect the Readers and LCs together.									
ETHERNET 2 – 100 Mbps 2	For connecting several Readers together to create an Inter-Reader (IR) network, or for connecting a service laptop when Ethernet 1 is connected to the Lane Controller.									
DIAGNOSTIC PORT 3	A second option for connecting a service laptop directly to the Reader. The browser interface cannot be accessed from this port.									

Control Module (CTM)	
I/O ④	Reserved for future use.
Port	Function
USB 1 ⑤	A third option for connecting a service laptop, via an Ethernet adapter, directly to the Reader, or for saving the Reader configuration to a flash drive, Or for automatically or manually copying the Reader log files to a flash drive.
USB 2 ⑥	

CTM MC

The MC is a single-board computer that runs the Reader firmware. The MC is mounted in the CTM.

CTM CGC

The CGC handles the communications between the MC and the RF modules. It also handles the serial communications between the reader and the Lane Controller via the serial connections on the LPM. The CGC is mounted in the CTM.

The CGC hardware supports the following functions.

- Controls the protocol frame timing for each protocol
- Controls the RF channel scanning as per configuration
- Handles the data communication exchange with the transponder via the RF link
- Handles inter-reader frame synchronization
- Provides hardware interface for redundancy operation
- Provides hardware interface for supporting up to eight (8) MRFM-S
- Provides in-system program capability via the Master interface, for firmware and hardware configuration where applicable
- Provides connections for eight Lane Controller Ports
- Provides pass-through provisional connections for the Host Port .

Synchronization Port Module (SPM)	
Function	<p>Sends out the status of the Reader (ready or busy) to the other Readers in the synchronization network.</p> <p>Signals to the CTM when all other Readers in the synchronization network are ready.</p> <p>Allows the switchover mode to be set to SECONDARY—AUTO—PRIMARY by the Redundancy Mode switch 2 on the SPM.</p>
Units per Redundant Reader	One
Normal State	N/A (no status indicators on module)
Connections	<p>The SPM terminal block 1 is connected to the other Readers in the synchronization network via the sync terminal block hub.</p>

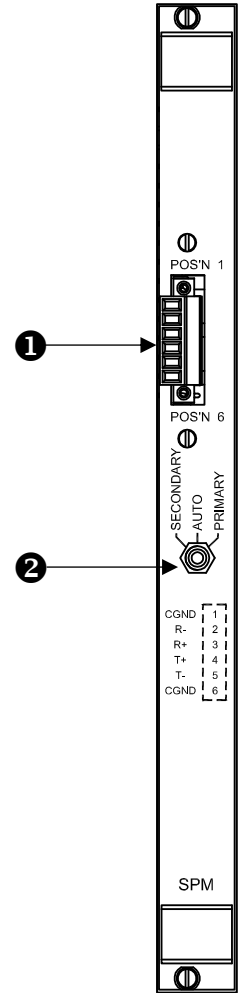

Lane Port Module (LPM)	
Function	Provides a serial interface between the LCs and CTM. All OBU Data processing is done by the CTM.
Units per Redundant Reader	One LPM on primary side, One LPM on secondary side
Normal State	N/A (no status indicators on module)
Connections	The Reader can send real-time OBU transactions to the LCs via the eight serial ports 1 on the LPM. The LC can also update the Reader configuration via these ports.

Power Supply Module (PSM)	
<p>Function</p> <p>Provides DC power to the modules in the Reader rack.</p> <p>Allows each side (primary or secondary) to be powered on and off via a power switch 2.</p>	
<p>Units per Redundant Reader</p> <p>One secondary PSM on the secondary side</p> <p>One primary PSM on the primary side</p> <p>The secondary and primary PSMs are not interchangeable since they are mirror images of each other. The secondary PSM is keyed to insert in the leftmost rack slot and the primary PSM is keyed to insert in the rightmost rack slot.</p>	
<p>Normal State</p> <p>A +15V STATUS LED 4 illuminates green to indicate that 15V DC is being supplied to the Reader.</p> <p>A +5V STATUS LED 5 illuminates green to indicate that 5V DC is being supplied to the Reader.</p>	

Connections	A power cable plugs into a socket 1 to supply 120VAC to the PSMs. Each PSM is equipped with a replaceable 10A fuse 3 .	
--------------------	--	--

Ethernet Switch Module (ESM)	
Function	<p>Can connect an IR network with up to three Readers for Open Road Tolling (ORT) applications via the Ethernet 2 port on the CTMs. The IR network is used to improve the accuracy of the voting that determines the lane assignment between Readers covering adjacent lanes.</p> <p>Can connect an LC network with all Readers to a Lane Controller and host computer via the Ethernet 1 port on the CTMs. The host computer can be used to access the browser interface for each Reader CTM in the network.</p> <p>The Ethernet switch Module, if used, shall be mounted in a reader cabinet.</p>
Units per Redundant Reader	Two per Ethernet network
Normal State	See the manufacturer's documentation for details.
Connections	See the manufacturer's documentation for details.

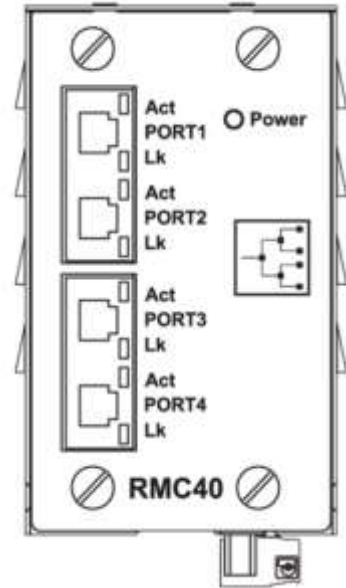

The CTM web interface

You can use a service laptop equipped with a web browser to access the CTM web interface, shown below. After entering your user name and password, you can monitor and configure the Reader depending on the permissions assigned to your user account.

Note: Depending on the permissions given a user by the administrator, the menu can have different options. For instance, the menu in brackets below is what an administrator would see.

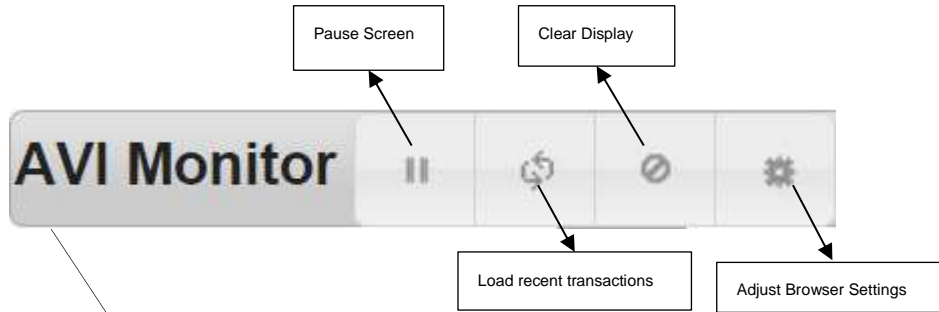

Menu for Administrators

Transactions in real-time

Show/hide columns: click to select columns to display

CSV: click to create a spread sheet

Graph showing number of tags per day per protocol (e.g., ATA and IAG)

Date	Protocol	AVI Reports
2015-01-30	ATA	2
2015-02-13	ATA	17
2015-02-14	ATA	10
2015-02-17	ATA	24
2015-02-17	IAG	1
2015-02-18	IAG	1
2015-02-18	ATA	1
2015-02-19	IAG	7
2015-02-19	ATA	24
2015-02-20	ATA	30
2015-02-22	ATA	12
2015-02-23	ATA	5

Each CTM has its own browser interface. Changing configuration settings while connected to the primary CTM, for example, does not change the configuration settings for the secondary CTM.

Note: Any changes applied to one CTM in a redundant Reader must then be applied to the other CTM.

3. OPERATING PROCEDURES

CAUTION:



Improper modification of configuration parameters may adversely affect system operation. The default values may not be appropriate for the specific application. It is the system integrator's responsibility to tailor the configuration parameters to the specific operating environment, with the aid of the Kapsch Operations Group.

CAUTION: Redundant Reader



Both CTMs in a redundant Reader must be properly configured. Each CTM has its own browser interface and is configured independently. Ensure any configuration changes made to one CTM are applied to the other CTM, as required.

Starting up the Reader

This procedure outlines the correct way to power on and boot up a Reader.

Prerequisites: PSM power switches set to the off (0) position.

1. CTM ON/OFF switches set to OFF.
2. Set the Redundancy Mode switch on the SPM to AUTO.
3. Set the secondary and primary PSM power switches to the **on** (I) position.
Result: The +15V STATUS LED and the +5 STATUS LED on the PSMs illuminate solid green.
4. Set the CTM ON/OFF switch to the ON position, and wait for the CTM to complete its power up cycle (approximately 120 Seconds).

Result: The POWER LED illuminates green. The STATUS LEDs illuminate green to indicate SYNC is functional, CTM is active, CGC is functional and MC is functional.

Note: If any CTM STATUS LEDs indicate an abnormal state, (see Table 6-1: CTM LED states explained on page 202) perform the necessary troubleshooting procedure. See Troubleshooting Methodology on page 199 for more information.

Shutting down the Reader

This procedure outlines the correct way to power down a Reader.

Prerequisites: None.

1. Click the  icon on the manage software page on the left side panel.

Result: The following dialog screen appears.

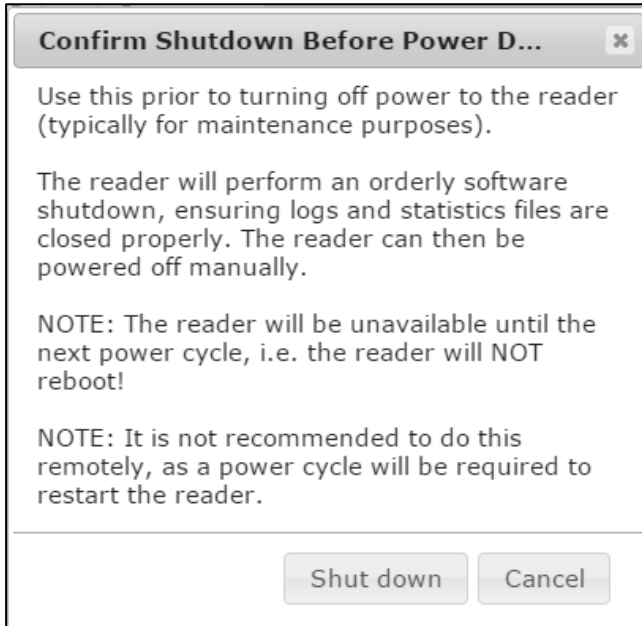

2. Click the **Shut down** button.
3. When the reader has completed an orderly software shut down set both CTM ON/OFF switches to OFF.
4. Set both PSM power switches to the **off** (0) position.

Manually switching a Reader to the redundant side

The Reader is manually switched between the primary and secondary sides. This is necessary, for example, when recovering a Reader back to the Primary side when automatic recovery is not enabled.

Prerequisites: Ensure no faults exist on the side being activated.

1. Set the SPM redundancy mode switch to either SECONDARY or PRIMARY, as applicable.

Result: The ACTIVE LED on the CTM of the selected side illuminates green, indicating the selected side is active.

Note: If the redundancy mode switch is set to PRIMARY, the Reader stays in Primary mode and does not switch operation to the secondary side unless the primary side fails.

Note: If the switch is set to SECONDARY, the Reader stays in Secondary mode and does not switch operation to the primary side unless the secondary side fails or the primary side recovers.

Connecting a service laptop to the Reader

You can use a service laptop to access the CTM web interface interface by connecting directly to one of the CTM USB ports or the ETHERNET 1 port.

Changing the service laptop IP address

1. In Windows, go to **Start → Settings → Control Panel → Network Connections → Local Area Connection → Properties → Internet Protocol (TCP/IP) → Properties**.
2. Select **Use the following IP address**, then enter the IP address using the Reader network number in the first three fields (ex. 192.168.1._) followed by a unique host number in the fourth field.
3. Enter 225.225.225.0 in the subnet mask and leave the default gateway blank.

Testing the connection to the reader

1. In Windows, go to **Start → Run**.
2. Type 'ping', followed by the ETHERNET 1 port IP address or the USB adapter address, depending on what the laptop is connected.
3. Click **OK**.

Result: Several replies from the Reader IP address display momentarily in a DOS window. You are ready to access the CTM web interface (see Accessing the CTM web interface page 47).

Note: If a reply is not received during the test, check the cable, connections, and IP addresses, then repeat step 1.

Accessing the CTM web interface

The CTM web interface interface monitors and configures the CTM.

Prerequisites: A service laptop connected to one of the CTM USB ports or the ETHERNET 1 port of the Reader.

1. Launch the web browser on the computer.

Note: You can use a recent versions any popular browser.

ATTENTION: When using certain versions of Internet Explorer, you may experience missing strings of text when a CTM screen displays. Press control and F5 (Ctrl F5) simultaneously. This action clears the buffer and refreshes the screen.

Note: The default IP address of the primary and secondary CTM ETHERNET 1 port is 192.168.1.50. The IP address may change during installation.

2. Consult the record of system IP addresses maintained by the system integrator to determine the correct IP address by using the **hypertrm** command. See Using HyperTerminal to connect to the DIAGNOSTIC PORT on page 255.

Note: The default IP addresses of the primary and secondary CTM ETHERNET 2 port are 192.168.0.50 and 192.168.0.51 respectively. The IP addresses may change during installation.

3. Consult the record of system IP addresses to determine the correct IP address by using the **hypertrm** command. See Using HyperTerminal to connect to the DIAGNOSTIC PORT on page 255.
4. In the address bar of the web browser, type: **https://** followed by the IP address of the ETHERNET 1 Port or USB Adapter.
5. Use the following decision table to continue the procedure.

IF ...	THEN ...
you click the Login button and a dialog box requesting a username and password appears,	go to step 6.
a 403 Forbidden error message appears,	ensure the IP address entered in the address bar is correct and that the IP address is preceded by https://
a web browser message indicating there is a connection problem appears,	confirm that the IP address entered in step 2 is the correct record of system IP addresses.
a security warning appears	follow the instructions the web browser provides.

Note: Usernames and passwords are case-sensitive.

6. Enter your username and password.

Result: The following Home page appears.

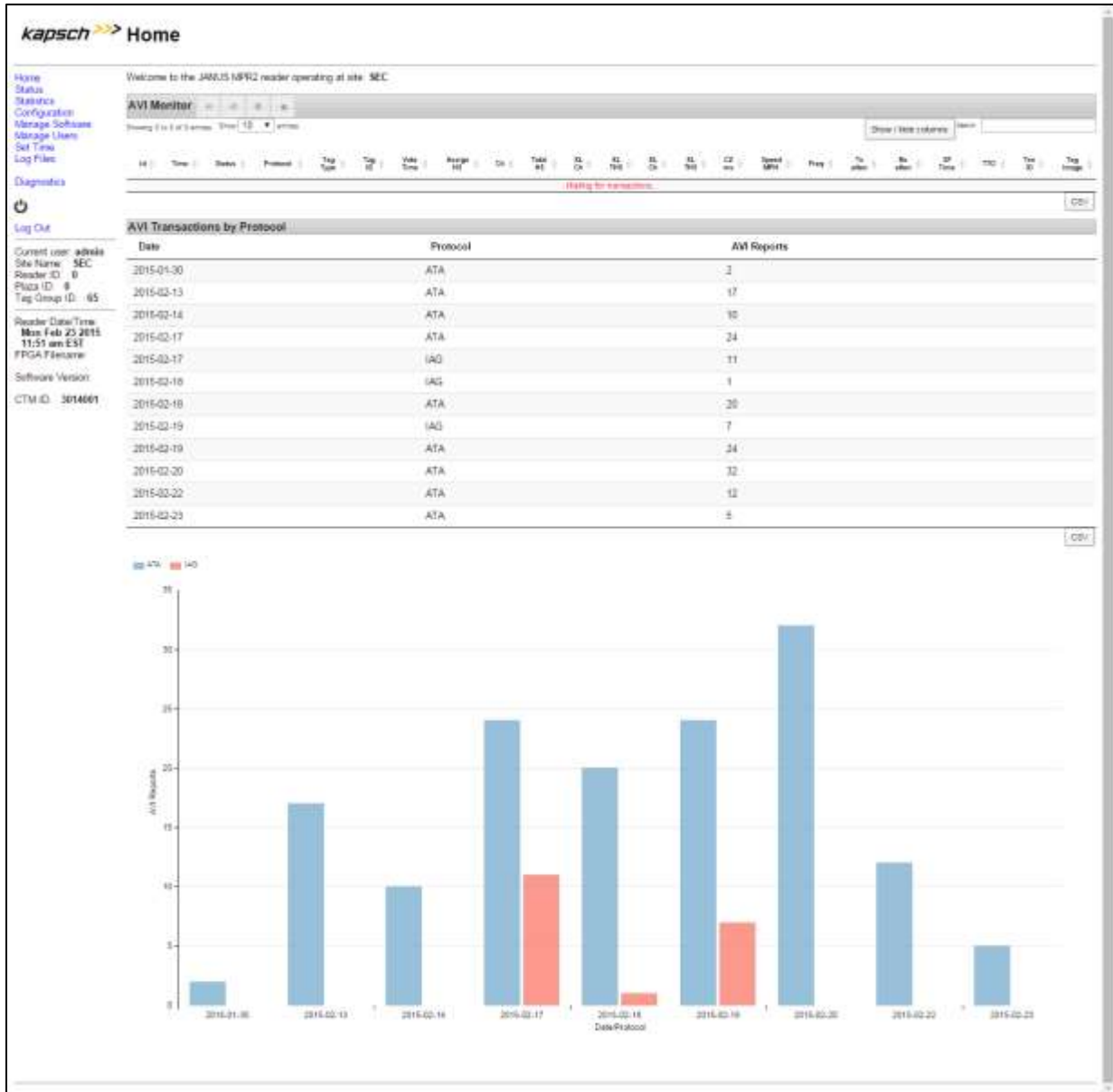

- Click the **Status** link located on the left panel.
Result: The following Status page appears.

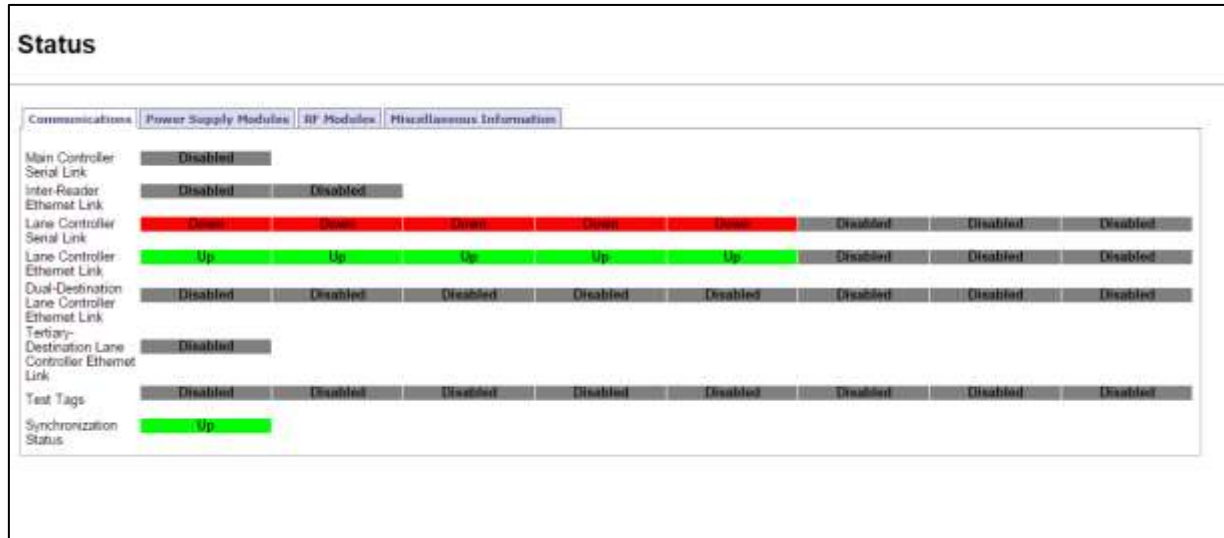

8. Select the **Miscellaneous Information** tab.

Result: The following screen appears.

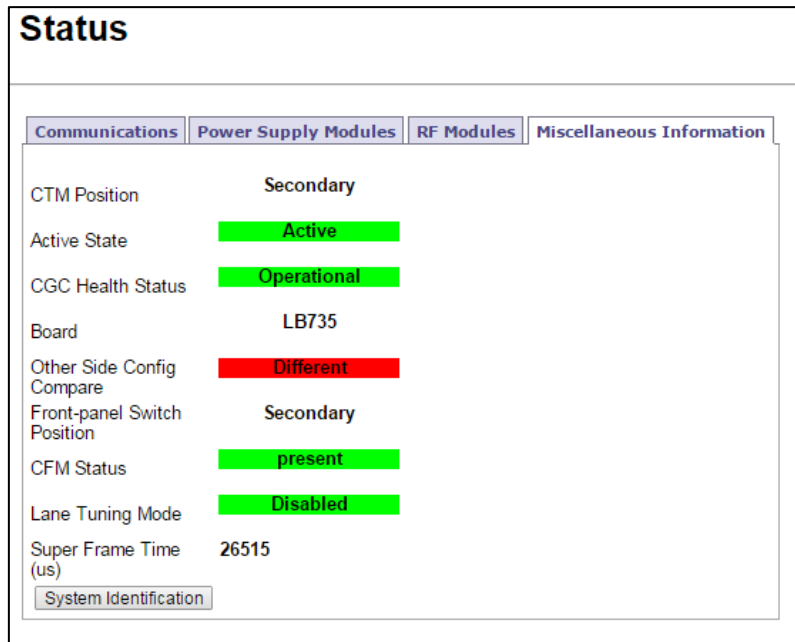

9. Click the **System Identification** button to confirm which Reader CTM web interface you are viewing, and that the computer is communicating successfully.

Result: The MC LED of the CTM flashes: green – red – amber – green three times to indicate communication.

Logging out of the CTM web interface

Logging out of the CTM web interface terminates the connection between the service laptop and the CTM web interface.

Prerequisites: Connect the service laptop to the Reader configuration port to access the CTM web interface. Refer to Connecting a service laptop to the Reader, page 47.

1. Click **Log Out** from the navigation side bar.

Result: You are immediately logged out from the CTM web interface.

Changing your password

Any user can change their own password, although the procedure is different for users with User Admin permissions. This procedure outlines how to change a password for users with User Admin permissions and for those without.

Prerequisites: Connect the service laptop to the Reader configuration port to access the CTM web interface. Refer to Connecting a service laptop to the Reader, page 47.

1. Login to the user account that requires a password change.
2. Use the following decision table to continue the procedure.

IF you logged into an account that ...	THEN ...
has User Admin permissions,	navigate to the Change Password tab on the User Management page. Go to step 3.
does NOT have User Admin permissions,	from ANY page, click Change Password in the navigation sidebar. Result: The User Management Change Password page appears. Go to step 3.

3. Enter your new password in the **New Password** and **Confirm New Password** fields.
4. Click the **Submit** button.
Result: Your password is now changed
5. If, after you have changed your password, an authentication window appears, enter your user name and new password to return to the browser interface.

Resetting a forgotten password

If a user forgets their password, the password can be cleared by another user with User Admin permissions. The Reader accepts any password from the user until the password is changed. This procedure requires two users; a user with User Admin permissions and the user requiring a reset password.

Prerequisites: The user clearing the password must have User Admin permissions.

Note: The User Administrator should ensure that the user sets a new password after the password is cleared. Otherwise, the Reader will continue to accept any password for that user account.

1. Navigate to the **User Management** tab on the User Management page.
2. Use the following decision table to continue the procedure.

IF you logged into an account that ...	THEN ...
has User Admin permissions,	go to step 3 and continue to step 5.
does NOT have User Admin permissions,	go to step 6 and continue to step 8.

3. Click the corresponding **Clear Password** button of the user whose password needs resetting.
4. Click **Yes** to confirm.
5. Log out (see Logging out of the CTM web interface, page 51).
6. Select **Change Password** from the navigation sidebar.
7. Enter your user name and compose a password.
Note: This password does not become your new password.
8. Change your password (see Changing your password on page 51).

Result: Your password resets.

Configuring the Reader to recover automatically to the primary side

The Reader can be configured to automatically activate the primary side once a failure causing a switchover to the secondary side has cleared.

Prerequisites: Connect the service laptop to the Reader configuration port to access the CTM web interface. Refer to Connecting a service laptop to the Reader, page 47.

Note: You must have **Advanced User** permissions.

1. Set the SPM redundancy mode switch to the **AUTO** position.
2. From the CTM web **Home** page, select the **Configuration** link on the left panel of the screen.
3. Select the **Auto Recovery To Prime** check box if it is not already selected.

Example: The following Configuration page is shown.

Configuration	
General Test Data License Assignment Tag Programming OBU Feedback Toll Rate/Balance Channel RF Attenuation LC LC-Extended Serial Group Manage	
Config Changes Compare	
Site Name:	SEC
Ethernet 1 (LC 1Gbps) IP Address:	148.198.226.198
Ethernet 1 (LC 1Gbps) Subnet Mask:	255.255.0.0
Ethernet 2 (RJ45 100Mbps) IP Address:	192.168.0.51
Reader IP Address:	10.0.0.50
USB Adapter or Bluetooth IP Address:	192.168.2.50
Default Gateway IP:	0.0.0.0
Suppress Non-AG Tags:	<input checked="" type="checkbox"/>
Diagnostics Port Baud Rate:	115200
Reader configuration Auto-backup & Recovery:	<input checked="" type="checkbox"/>
Reader Sync:	
Enable Reader Sync:	<input checked="" type="checkbox"/>
Superframe Sync Skip:	<input type="radio"/> Sync to every superframe <input checked="" type="radio"/> Sync to every other superframe
Add 2 Dummy Frames:	<input checked="" type="radio"/> No <input type="radio"/> Yes
Type Of Reader Syncing Tr:	Janus
Report Latency by Tag Type:	
0 - Interior FPT Delay [ms]	0
1 - Exterior FPT Delay [ms]	0
2 - Exterior LPT Delay [ms]	0
3 - LCD Display Delay [ms]	0
4 - Commercial Vehicle (CVD) Delay [ms]	0
5 - OBU Feedback Tag Delay [ms]	0
6 - HOT Tag Delay [ms]	0
Primary/Secondary:	
Redundant Mode:	<input checked="" type="checkbox"/>
Dual Reporting Mode:	<input type="checkbox"/>
Auto Recovery To Prime:	<input checked="" type="checkbox"/>
Switchover on Ethernet LC Link Down:	<input type="checkbox"/>
Reader Statistics:	
Use database:	<input checked="" type="checkbox"/>
Database (Tags) Maximum records:	10000
Database (Summary) Retention period [7-90 days]:	30
Database (Summary) Interval [1-30 minutes]:	15
Dashboard:	
Transaction Summary dashboard:	<input checked="" type="checkbox"/>

Monitoring the Reader

You can monitor and gather information about the Reader from the CTM web interface using the Status option in the left panel of the screen.

Note: For all of the following procedures, a laptop or desktop computer with a monitor needs to be connected to the CTM Ethernet 1 port or USB port.

Reader status

The Status page in the CTM web interface displays the state of the communication links, the power supply modules, and the CTM/CGC, and is useful for troubleshooting the Reader.

Communications

Table 3-1 lists and describes the fields in the Communications tab on the Status page.

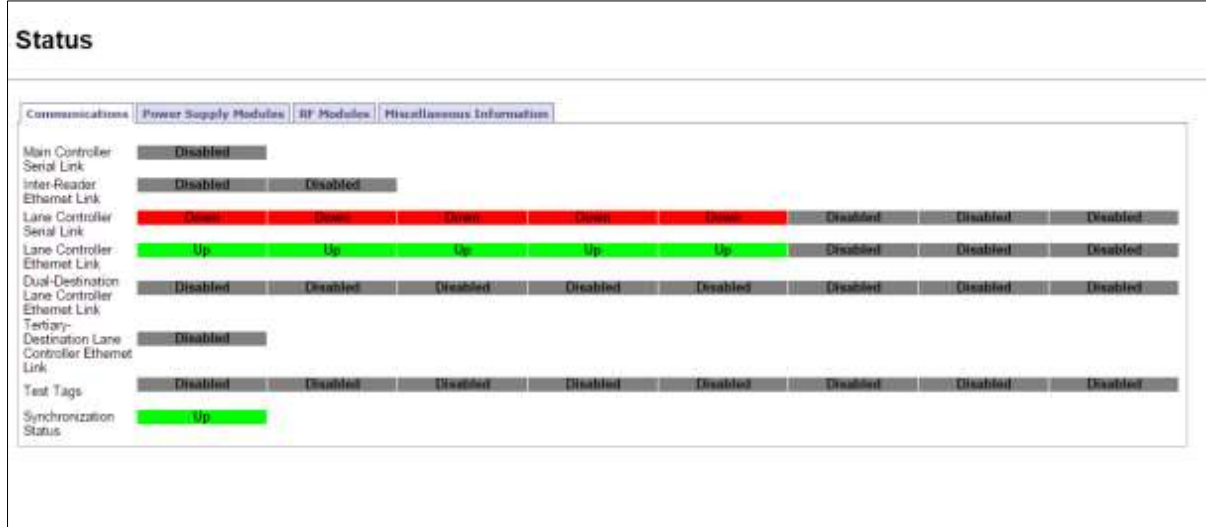

Table 3-1: Communications fields

Communications tab		
Field	Status	Description
Main Controller Serial link	Up	successful link connection between redundant CTMs
	Down	link failure or disabled (always Down on non-redundant Readers)
Inter-Reader Ethernet link	Up	successful link connection
	Down	link failure
	Disabled	link not enabled
Lane Controller Serial link	Up	successful link connection between CTM (via LPM) and LC
	Down	link failure
	Disabled	link not enabled
Lane Controller Ethernet link	Up	successful link connection
	Down	link failure

Communications tab		
Field	Status	Description
	Disabled	link not enabled
Dual-Destination Lane Controller Ethernet Link		
Tertiary-Destination Lane Controller Ethernet Link		
Test Tags	Responding	test tag enable, tag seen.
	Not Detected	test tag enabled, tag not being read.
	Disabled	test tags are not used to confirm RF Channel health
Synchronization	Up	successful link connection
	Down	link failure
	Disabled	synchronization not enabled

Power Supply Module

Table 3-2 lists and describes the fields in the Power Supply Module tab on the Status page.

Status

Communications
Power Supply Modules
RF Modules
Miscellaneous Information

5V (primary)	On
5V (secondary)	On
15V (primary)	On
15V (secondary)	On

Table 3-2: Power Supply Module fields

Power Supply Modules tab		
Field	Status	Description
5V (primary)	On	DC input operational
	Off	DC input failure
5V (secondary)	On	DC input operational
	Off	DC input failure
15V (primary)	On	DC input operational
	Off	DC input failure
15V (secondary)	On	DC input operational
	Off	DC input failure

RF Modules

Table 3-3 lists and describes the fields in the RF Modules tab on the Status page.

Status								
Communications Power Supply Modules RF Modules Miscellaneous Information								
	Ch #1	Ch #2	Ch #3	Ch #4	Ch #5	Ch #6	Ch #7	Ch #8
Module Presence:	Present	Unknown	Unknown	Absent	Absent	Absent	Absent	Absent
Firmware Version:	2014Mar19-1320-01	Unknown	Unknown	Unknown	Unknown	Unknown	Unknown	Unknown
Serial No.:	Unknown	Unknown	Unknown	Unknown	Unknown	Unknown	Unknown	Unknown
Comm. Status:	OK	Failure	Failure	Unknown	Unknown	Unknown	Unknown	Unknown
Antenna Status:	OK	Unknown	Unknown	Unknown	Unknown	Unknown	Unknown	Unknown

Table 3-3: RF Modules fields

RF Modules tab		
Field	Status	Description
Module Presence	Absent	Not installed
	Present	Installed
	Unknown	Status not known
Serial No	Unknown	Status not known
	serial number shown	xxxxx
Comm Status	Unknown	Status not known
	OK	Comm States working
	Failure	Fault in one of more Comm States
Firmware Version	Date with part number shown	yyyymmdd-xxxx-xx
	Unknown	Status not known
Antenna Status	OK	Receiving and/or transmitting
	Failure	Fault in receiving and/or transmitting
	Unknown	Status not known

Miscellaneous Information

Table 3-4 lists and describes the fields in the Miscellaneous Information tab on the Status page.

Status

Communications	Power Supply Modules	RF Modules	Miscellaneous Information
CTM Position	Secondary		
Active State	Active		
CGC Health Status	Operational		
Board	LB735		
Other Side Config Compare	Different		
Front-panel Switch Position	Secondary		
CFM Status	present		
Lane Tuning Mode	Disabled		
Super Frame Time (us)	26515		
System Identification			

Table 3-4: Miscellaneous information fields

Miscellaneous Information tab		
Field	Status	Description
CTM Position	Primary	The CTM is installed on the primary side
	Secondary	The CTM is installed on the secondary side
Active State	Active	CTM is active
	Inactive	CTM is not active
CGC Health Status	Operational	CGC is operational
	Failed	CGC Failure
	Unknown	CGC Health status unknown
Board	Example: LB800, LB735	Provides information on the model of the single board computer (SBC) board installed Type of Board installed
Other Side Config Compare	Communication Down; Same; Different	(BETA) Provides an indication as to configuration state of peer CTM Communication Down (peer CTM is not running so configuration state is unknown) Same (peer CTM configuration is identical to this CTM's configuration) Different (peer CTM configuration is different that this CTM's configuration)

Miscellaneous Information tab		
Field	Status	Description
Front-panel switch position	Auto; Primary; Secondary	Auto, Primary (switch set to Primary side), Secondary (switch set to Secondary side). For a redundant system, the switch would normally be set to Auto
CFM Status	Present	Indicates normal status
	Not Detected	Indicates a problem; call Kapsch Service
Lane Tuning Mode	Disabled	'Disabled' is normal status
	Enabled	"Enabled" is not normal status
Super Frame Time (μs)	Numerical read	Reader timing information In microseconds

RF Channel Statistics

The Statistics page displays performance information for each MRFM-S channel. The statistics displayed do not update automatically as transactions occur. Update the statistics with the latest data by navigating away from, and then returning to the Statistics page, or by refreshing/reloading your browser window.

Updates to the statistics pages commence when the Reader begins processing OBU transactions after startup.

Statistics continue being appended until the system is either stopped and re-started, rebooted, or the Reset Transaction Statistics button is clicked, which sets the statistics values to zero and updates commence again.

Reports by channel

This screen lists and graphs reports on channel activity. You can chose to display daily or weekly reports by clicking the available buttons.

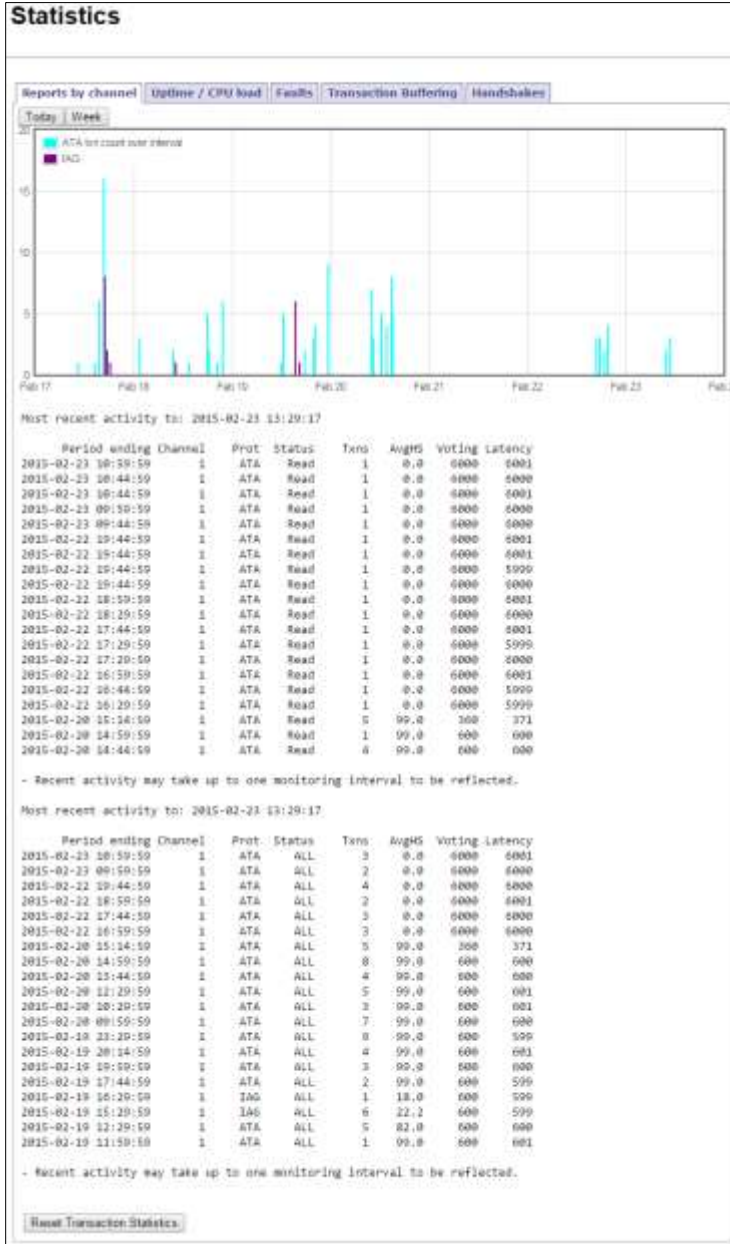

You can reset the values of the report by clicking the Reset Transaction Statistics button.

Table 3-5: Reports by Channel

Reports by Channel tab	
Field	Description
Period ending	The date and time that the statistics in the browser window were updated. Navigate away from and then return to the Statistics page, or refresh/reload your browser screen to update the statistics.
Channel	The RF Channel that the statistics in that row represent.
Prot	Protocol being used by the Reader
Status	AVI Report Status (e.g., PGM, PU, PF, Read)
Txns	The number of transactions performed in a period
AvgHS	The average number of handshakes over the total transactions with the primary or secondary side active
Voting	Average voting: time over period
Latency	The average latency time to report transactions

Uptime / CPU Load

This report lists and graphs the date and time of the reader activity measured in HoursUp and the number of CPU Loads involved.

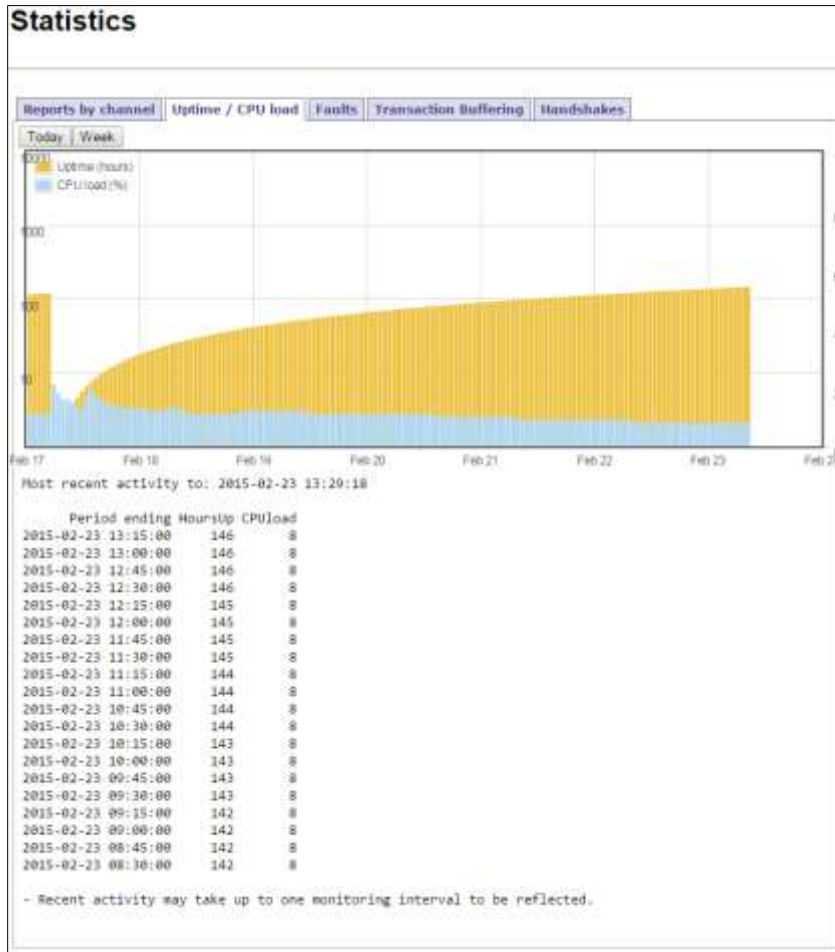

Faults

This screen lists and graphs faults and reports them by type according to a color code.

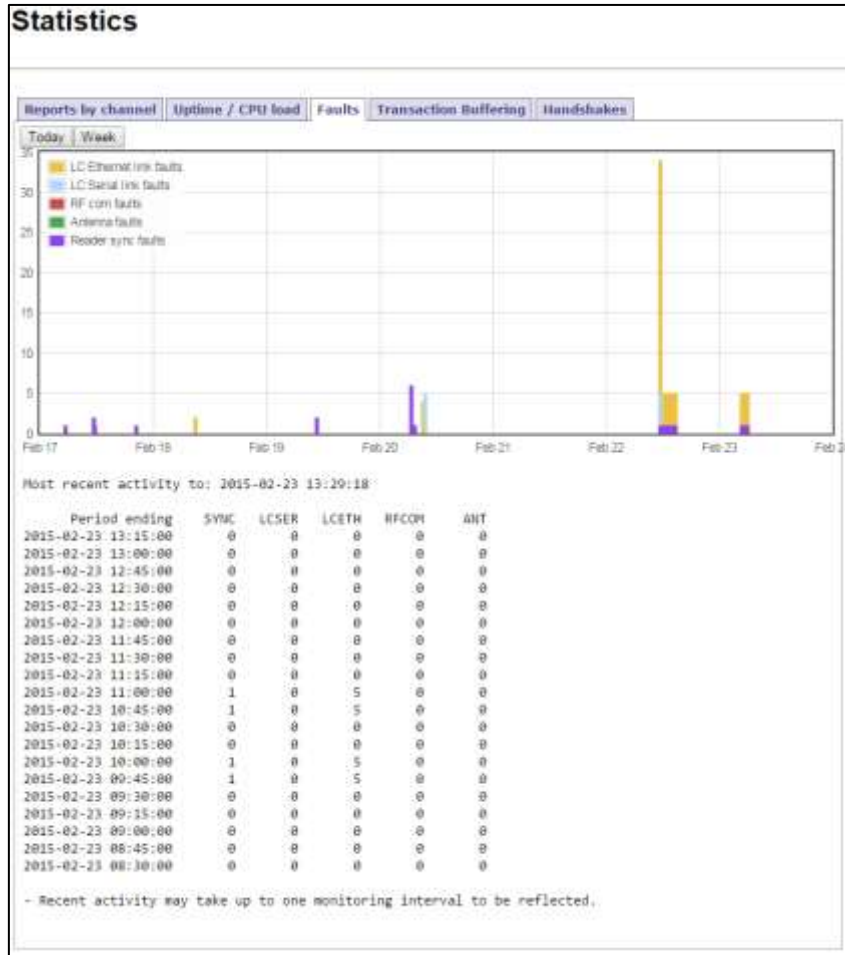

Transaction Buffering

Transaction buffering shows the user how much each channel is using for buffering. The following screen shows an example.



Note: Each side reports transactions that occurred while being active.

Handshakes

Handshakes shows the average number of handshakes that occur daily. The following screen shows an example.

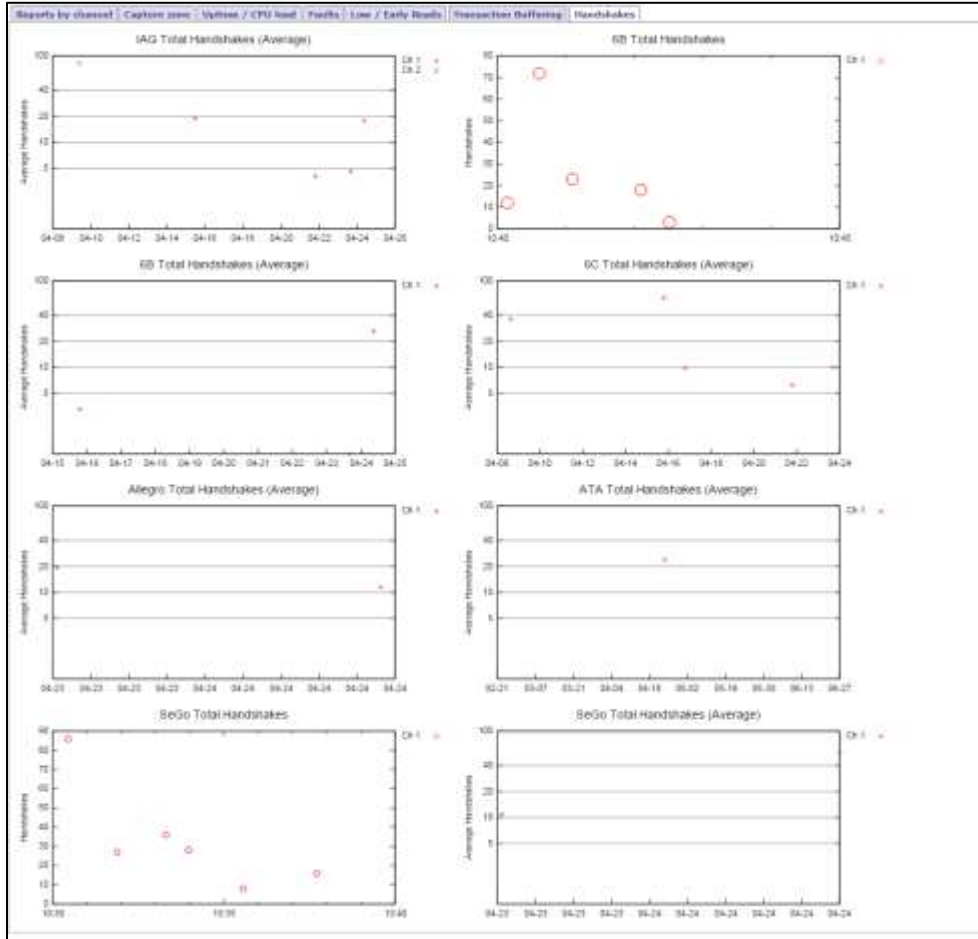

Monitoring OBU transactions as they occur via the Diagnostics page

Monitoring OBU transactions from the Diagnostics page is a better alternative to viewing transactions from a transaction log on the Log Files page because the transactions on the Diagnostics page are updated automatically. However, transactions that occurred before the Diagnostics page was accessed can only be viewed from the transaction log.

The Display Transactions option displays both active and passive transactions.

Prerequisites: Connect the service laptop to the Reader configuration port to access the CTM web Refer to Connecting a service laptop to the Reader, page 47. You must have Advanced User permissions.

Note: The computer must have Java version 6.0 installed (see www.java.com).

1. Select the **Diagnostics** link from the left side panel.

Result: The following Diagnostics Page appears.

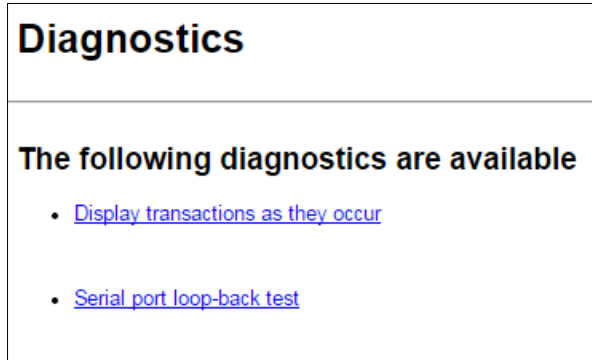

2. An authentication window may appear on the **Diagnostics Page** when accessed the first time. If it appears, enter a valid user name and password.

Note: To avoid having to re-enter authentication information on the Diagnostics Page, click the Save this password in your password list button.

Result: After the Java program starts, the Tag Transaction window appears. All OBU transactions for the Reader display automatically. The display update stops if someone updates the Reader software or reboots the Reader.

Note: If a second computer or second browser window is used to access the Diagnostics Page, new transactions will no longer be displayed in the first browser window.

Continuously logging transactions to a USB flash drive

This procedure outlines how to have transaction log files automatically saved and continuously updated on a USB flash drive.

Prerequisites: A USB flash drive is inserted into one of the CTM USB ports.

Connect the service laptop to the Reader configuration port to access the CTM web interface. Refer to Connecting a service laptop to the Reader, page 47. You must have View Log Files and Manage Log Files permissions.

1. Select the **Log Files** link on the left side panel of the screen.

Result: The following Log Files page appears.

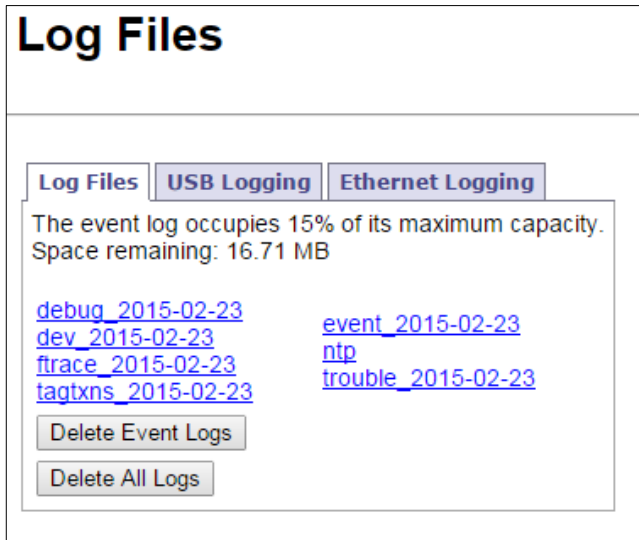

2. Click the **USB Logging** tab.

Result: The following screen appears.

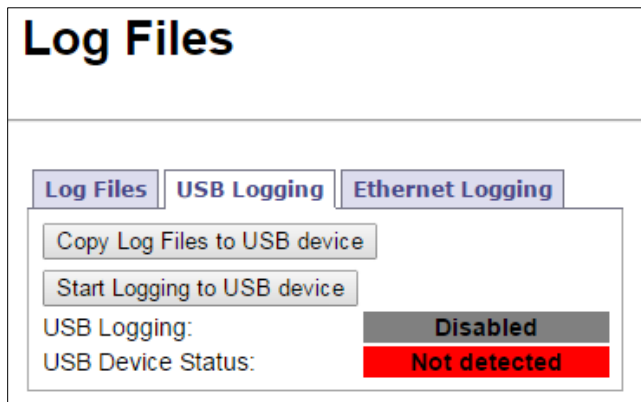

3. Click the **Start Logging to USB Device** button.

Result: The following screen message appears.

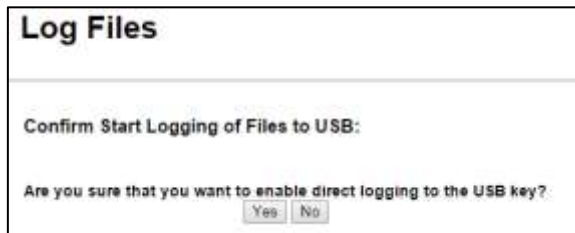

4. Click the **Yes** button.

Result: The following screen message appears.



Note: The USB Logging changes its display from Disabled to Enabled, and USB Device Status remains at Available to indicate that a connection between the Reader and the USB flash drive and log files can get copied and updated to the USB device in realtime when required.

Note: You can click the Copy Log Files to USB device button if you just want to copy the present list of log files to the USB device.

Continuously logging transactions using the Ethernet

This procedure outlines how to have transaction log files automatically saved and continuously updated through an ethernet connection..

Prerequisites: A ethernet connection is plugged into the laptop.

Connect the service laptop to the Reader configuration port to access the CTM web interface. Refer to Connecting a service laptop to the Reader, page 47. You must have View Log Files and Manage Log Files permissions.

1. Select the **Log Files** link on the left side panel of the screen.
2. Click the **Ethernet Logging** tab.

Result: The following screen appears.

Log Files

Log Files | **USB Logging** | **Ethernet Logging**

Ethernet Logging:

Destination IP/Port: Port:

Ethernet Protocol:

- tcp
- udp

Select Logs:

- trouble
- tag
- event
- developer
- debug
- fifo

3. Enable the Ethernet Logging checkbox.
4. Enter a Destination IP address and Port.
5. Select the appropriate Ethernet Protocol.
6. Select the required logs.

Example: The following example screen is shown.

Log Files

Log Files | USB Logging | Ethernet Logging

Ethernet Logging:

Destination IP/Port: Port:

Ethernet Protocol:

tcp
 udp

Select Logs:

trouble
 tag
 event
 developer
 debug
 fifo

OBU Programming

The Reader can write data to an OBU as it passes through a toll plaza. The following procedures outline how to enable OBU programming and how to configure the data that is written to the OBUs.

Prerequisites: Connect the service laptop to the Reader configuration port to access the CTM web interface. Refer to Connecting a service laptop to the Reader, page 47.

1. Select the **Configuration** link on the left side panel of the screen.

Result: The following screen appears.

Configuration

General	Test Tags	Line Assignment	Tag Programming	OBU Feedback	Toll Rate/Balance	Channel	RF Attenuation	LC	LC-Extended	Serial	Group	Manage
<p>Site Name: SEC</p> <p>Ethernet 1 (LC 1Gbps) IP Address: 148.198.225.198</p> <p>Ethernet 1 (LC 1Gbps) Subnet Mask: 255.255.0.0</p> <p>Ethernet 2 (RIF 100Mbps) IP Address: 192.168.0.51</p> <p>Reader IP Address: 10.0.0.50</p> <p>USB Adapter or Bluetooth IP Address: 192.168.2.50</p> <p>Default Gateway IP: 0.0.0.0</p> <p>Suppress Non-IAG Tags: <input checked="" type="checkbox"/></p> <p>Diagnostics Port Baud Rate: 115200</p> <p>Reader configuration Auto-backup & Recovery: <input checked="" type="checkbox"/></p>												
<p>Reader Sync:</p> <p>Enable Reader Sync: <input checked="" type="checkbox"/></p> <p>Superframe Sync Skip: <input type="radio"/> Sync to every superframe <input checked="" type="radio"/> Sync to every other superframe</p> <p>Add 2 Dummy Frames: <input checked="" type="radio"/> No <input type="radio"/> Yes</p> <p>Type Of Reader Syncing To: Janus</p>												
<p>Report Latency by Tag Type:</p> <p>0 - Interior FPT Delay [ms]: 0</p> <p>1 - Exterior FPT Delay [ms]: 0</p> <p>2 - Exterior LPT Delay [ms]: 0</p> <p>3 - LCD Display Delay [ms]: 0</p> <p>4 - Commercial Vehicle (CVO) Delay [ms]: 0</p> <p>5 - OBU Feedback Tag Delay [ms]: 0</p> <p>6 - HOT Tag Delay [ms]: 0</p>												
<p>Primary/Secondary:</p> <p>Redundant Mode: <input checked="" type="checkbox"/></p> <p>Dual Reporting Mode: <input type="checkbox"/></p> <p>Auto Recovery To Frame: <input checked="" type="checkbox"/></p> <p>Switchover on Ethernet LC Link Down: <input type="checkbox"/></p>												
<p>Reader Statistics:</p> <p>Use database: <input checked="" type="checkbox"/></p> <p>Database (Tms) Maximum records: 10000</p> <p>Database (Summary) Retention period [7-90 days]: 30</p> <p>Database (Summary) Interval [1-30 minutes]: 15</p>												
<p>Dashboard:</p> <p>Transaction Summary dashboard: <input checked="" type="checkbox"/></p>												

2. Click the **Tag Programming** tab.

Result: The following screen appears.

Configuration	
General Test Tags Lane Assignment Tag Programming OBU Feedback Toll Rate/Balance Channel RF Attenuation LC LC-Extended Serial Group Manage	
Config Changes Compare	
Lane Number: <input type="text"/> 1 <input type="text"/> 2 <input type="text"/> 3 <input type="text"/> 4 <input type="text"/> 5 <input type="text"/> 6 <input type="text"/> 7 <input type="text"/> 8	
Plaza ID: <input type="text"/>	
Agency ID: <input type="text"/>	
6C Read-Only Mode: <input checked="" type="checkbox"/>	
IAG Read-Only Mode: <input type="checkbox"/>	
Traffic Management Programming (TMP)	
Enable TMP:	<input checked="" type="checkbox"/>
Toll Collection Programming (TCP)	
Enable TCP:	<input type="checkbox"/>

Configuring OBU programming for Traffic Management Applications

1. From the **Tag Programming** screen, select the **Enable TMP** check box.

Result: The following screen appears.

Configuration	
General Test Tags Lane Assignment Tag Programming OBU Feedback Toll Rate/Balance Channel RF Attenuation LC LC-Extended Serial Group Manage	
Config Changes Compare	
Lane Number: <input type="text"/> 1 <input type="text"/> 2 <input type="text"/> 3 <input type="text"/> 4 <input type="text"/> 5 <input type="text"/> 6 <input type="text"/> 7 <input type="text"/> 8	
Plaza ID: <input type="text"/>	
Agency ID: <input type="text"/>	
6C Read-Only Mode: <input checked="" type="checkbox"/>	
IAG Read-Only Mode: <input type="checkbox"/>	
Traffic Management Programming (TMP)	
Enable TMP:	<input checked="" type="checkbox"/>
Reader ID: <input checked="" type="checkbox"/> <input type="text"/>	
TM Date/Time: <input checked="" type="checkbox"/>	
Toll Collection Programming (TCP)	
Enable TCP:	<input type="checkbox"/>

2. Select the **Reader ID** check box to enable writing the Reader ID to OBUs.
3. Enter a unique Reader ID.
4. Select the **TM Date/Time** check box to write the Reader TM time to OBUs.

Configuring OBU programming for Toll Collection applications

1. From the above **Tag Programming** screen, select the **Enable TCP** check box.

Result: The following screen appears.

Configuration

General | Test Apps | Lane Assignment | Tag Programming | OBU Feedback | Toll Rate/Balance | Channel | RF Attenuation | LC | LC-Extended | Serial | Group | Manage

Line Number: 1 2 3 4 5 6 7 8

Plaza ID: 0

Agency ID: 0

EC Read-Only Mode:

IAG Read-Only Mode:

Traffic Management Programming (TMP)

	R/W
Enable TMP:	<input type="checkbox"/>

Toll Collection Programming (TCP)

	R/W
Enable TCP:	<input checked="" type="checkbox"/>
Plaza ID:	<input checked="" type="checkbox"/>
Agency ID:	<input checked="" type="checkbox"/>
Transaction Number Programming:	<input checked="" type="checkbox"/> Reprogram with 16 bit sequential transaction number
OBU Feedback:	<input type="checkbox"/>
Toll Rate / Balance Adjustment:	<input type="checkbox"/>
TC Date/Time:	<input checked="" type="checkbox"/>
RW Format:	<input checked="" type="checkbox"/>
Lane Number:	<input checked="" type="checkbox"/>

Note: If not already enabled, check and configure the Plaza ID before enabling OBU feedback. The Plaza ID field is not accessible once OBU feedback is enabled.

2. Enter the **Plaza ID** and **Agency ID** in the fields.
3. Select the **Transaction Number Programming** check box to choose how the Reader determines the toll transaction number.
4. Click the **Transaction Number Programming** drop-down box

Result: The following screen appears.

Configuration

General | Test Tags | Lane Assignment | Tag Programming | OBU Feedback | Toll Rate/Balance | Channel | RF Attenuation | LC | LC-Extended | Serial | Group | Manage

Config | Changes | Complete

Lane Number: 1 2 3 4 5 6 7 8

Plaza ID: 0

Agency ID: 0

OC Read-Only Mode:

IAG Read-Only Mode:

Traffic Management Programming (TMP)

	R/W
Enable TMP:	<input type="checkbox"/>

Toll Collection Programming (TCP)

	R/W
Enable TCP:	<input checked="" type="checkbox"/>
Plaza ID	<input checked="" type="checkbox"/>
Agency ID	<input checked="" type="checkbox"/>
Transaction Number Programming:	<input checked="" type="checkbox"/> Reprogram with 16 bit sequential transaction number
OBU Feedback:	<input type="checkbox"/> Don't reprogram transaction field
Toll Rate / Balance Adjustment	<input type="checkbox"/> Reprogram with 16 bit random number
TC Date/Time	<input type="checkbox"/> Reprogram with 16 bit sequential transaction number
R/W Format	<input type="checkbox"/> Reprogram with 8 bit random number and 8 bit sequential number
Lane Number	<input checked="" type="checkbox"/>

5. Select the desired transaction numbering calculation from the drop-down box.
6. Select the **TC Date/Time** check box to write the transaction time to the OBU.
7. Select the **RW Format** check box to determine how the scratchpad data is encoded when written to OBUs.

Note: Before proceeding to the next step, ensure that you first enable and configure the Plaza ID.

8. Select the **OBU Feedback** check box to enable OBU feedback.
9. Assign a Lane Number to each RF channel.

Note: When a transaction occurs between an OBU and a channel, the Lane Number specified here will be used when recording the transaction in OBU memory.

10. Select the **OBU Feedback** tab.

Result: The following screen appears.

Configuration

General | Test Tags | Lane Assignment | Tag Programming | OBU Feedback | Toll Rate/Balance | Channel | RF Attenuation | LC | LC-Extended | Serial | Group | Manage

Config | Changes | Complete

OBU Feedback Type: Type 1 Type 2

OBU Audible Feedback: Off

OBU Visual Feedback: Off

11. Select either **Type 1** or **Type 2** feedback.
12. Select the desired audible feedback to control OBU beeping when a transaction occurs.

13. Select the desired visual feedback to control OBU LED flashing when a transaction occurs.

Configuring Toll charges

The Reader can deduct toll charges from a toll/balance OBU based on a number of parameters. BAT 1 tolling deducts charges based on the vehicle type and the lane the vehicle is in when it passes through the toll plaza. BAT 2 tolling deducts charges based on distance by determining the toll plazas the vehicle entered and exited on the highway.

Prerequisites: You must have Advanced User permissions.

BAT 1 tolling (deducting charges based on lane and vehicle type)

1. Select the **Configuration** link on the left side panel of the screen.
2. Select the **Toll/Rate Balance** tab

Result: The following screen appears.



3. Select **BAT 1 - Fixed Toll** as the TRBA BAT Processing Type.
4. Select one of four Toll Rate Tables for each channel, which determines the charge for the lane associated with each channel.
5. Select the **Enforce Adjustment ID Checking** check box to limit how frequently the balance can be updated.

BAT 2 tolling (deducting charges based on entry and exit location)

1. Select the **Configuration** link on the left side panel of the screen.
2. Select the **Toll Rate/Balance** tab
3. Select **BAT 2 - Variable Toll** as the TRBA BAT Processing Type.

Result: The following screen appears.

Configuration												
General	Test Tags	Lane Assignment	Tag Programming	OBU Feedback	Toll Rate/Balance	Channel	RF Attenuation	LC	LC-Extended	Serial	Group	Manage
Config	Changes	Compare										
TRBA BAT Processing Type:						<input type="radio"/> BAT 1-Fixed Toll <input checked="" type="radio"/> BAT 2-Variable Toll						
BAT 2 - Variable Toll Parameters:												
Entry / Exit Reader:						<input checked="" type="radio"/> Entry Reader <input type="radio"/> Exit Reader						
Enforce Adjustment ID Checking:						<input type="checkbox"/>						

Note: For Readers at entry locations, select Entry Reader; for Readers at exit locations, select Exit Reader.

4. Select the **Enforce Adjustment ID Checking** check box to limit how frequently the balance can be updated.

Configuring Protocols

Configure the Reader to interact with various protocol tags.

Prerequisites: You must have Advanced User permissions.

1. After selecting the **Configuration** link on the left side, select the **Channel** tab,

Result: The following screen appears.

Configuration

General | End Type | Lane Assignment | Tag Programming | OBU Feedback | Toll Rate/Balance | Channel | RF Attenuation | LC | LC-Extended | Serial | Group | Manage

Config | Changes | Compare

TDM Enable

	Ch #1	Ch #2	Ch #3	Ch #4	Ch #5	Ch #6	Ch #7	Ch #8
TDM RF State:	Active	Active	Active	Stop				
TDM Tag Protocol:	<input checked="" type="checkbox"/> IAG <input type="checkbox"/> Allegro	<input checked="" type="checkbox"/> IAG <input type="checkbox"/> Allegro	<input checked="" type="checkbox"/> IAG <input type="checkbox"/> Allegro					

FDM Enable

	Ch #1	Ch #2	Ch #3	Ch #4	Ch #5	Ch #6	Ch #7	Ch #8
FDM RF State:	Active	Active	Active	Active	Active	Active	Active	Active
FDM Frequency [MHz]:	913.05	915.75	902.50	910.05	902.50	902.50	902.50	902.50
FDM Tag Protocol:	<input type="radio"/> (off) <input type="radio"/> SeGo <input type="radio"/> 6B <input type="radio"/> 6C <input checked="" type="radio"/> ATA <input type="radio"/> SeGo+6C <input type="radio"/> 6B+6C							
ATA Super-Frame Skip Count:	<input type="text" value="0"/>							

	Ch #1	Ch #2	Ch #3	Ch #4	Ch #5	Ch #6	Ch #7	Ch #8
Channel Weight [%]	100	100	100	100	100	100	100	100
Group ID	0	0	0	0	0	0	0	0
LPT/FME Voting Time [ms]	200	300	300	300	200	300	300	300
Voting Time (all other tag types) [ms]	600	200	300	400	100	100	100	100
Dynamic Voting Control	Disabled	Disabled	Disabled	Disabled	Disabled	Disabled	Disabled	Disabled

Set all RF channels to: Active

Set RF State of all channels to the same configuration as channel:

Set voting time / dynamic voting of all channels to the same configuration as channel:

Note: When the reader leaves the factory, protocols will be unavailable.

2. Select each channel and use the **TDM RF State** and **FDM RF State** to enable or disable a channel.
3. Select the frequency for each channel by using the FDM Frequency (MHZ) selection.

Note: This should only be performed with Kapsch Technical Support.

4. Select the specific combination of protocols desired.

Note: This should only be performed with Kapsch Technical Support.

Configuration

The following table lists and describes the commands and controls that can be deployed in the various Configuration screens that are available to a user.

Table 3-6: Commands and Controls

Command	How is this command executed?	Who can execute this command?	Parameter Name	Default Parameter Value	Parameter Range/Options	What does this command do?	What is the purpose of this command?
Home	In the navigation side bar: Click Home .	anyone	N/A	N/A	N/A	displays the Main Page in the CTM web interface.	Used to return to the main page.
Status	In the navigation side bar: Click Status .	anyone	N/A	N/A	N/A	displays the Status page in the CTM web interface.	Used to monitor communication, power supply, CTM status and CGC health See System Identification for more explanation of the button.

Command	How is this command executed?	Who can execute this command?	Parameter Name	Default Parameter Value	Parameter Range/Options	What does this command do?	What is the purpose of this command?
Statistics	In the navigation side bar: Click Statistics .	anyone	N/A	N/A	N/A	displays the Statistics page in the CTM web interface.	Used to view Reports by channel , Low/Early Reads, Transaction Buffering statistics. Note: The Reset Transaction Statistics button is used to start a new statistical record.
Configuration	In the navigation side bar: Click Configuration .	anyone	N/A	N/A	N/A	displays the Configuration page in the CTM web interface.	Used to access a variety of Reader configuration parameters.
Manage Software	In the navigation side bar: Click Manage Software	user with Manage Software permissions	N/A	N/A	N/A	displays the Software Management page in the CTM web interface.	Used to access upload and verify, activate, and delete software commands and the Reboot button to reboot the Reader.

Command	How is this command executed?	Who can execute this command?	Parameter Name	Default Parameter Value	Parameter Range/Options	What does this command do?	What is the purpose of this command?
Manage Users	In the navigation side bar: Click Manage Users .	user with User Admin permissions	N/A	N/A	N/A	displays the User Management page in the CTM web interface	Used to access user profiles, create new users, delete users, change permissions, change passwords.
Change Password	In the navigation side bar: Click Change Password .	user WITHOUT User Admin permissions	N/A	N/A	N/A	displays a User Management page limited to commands for changing passwords	to change the password of the user currently logged into the CTM web interface
Set Time	In the navigation side bar: Click Set Time .	anyone	N/A	N/A	N/A	displays the Time Management page in the CTM web interface	to Disable/Enable Network Time Protocol (NTP) access NTP servers IPv4 addresses and select a new time zone

Command	How is this command executed?	Who can execute this command?	Parameter Name	Default Parameter Value	Parameter Range/Options	What does this command do?	What is the purpose of this command?
Log Files	In the navigation side bar: Click Log Files .	user with View Log Files permission	N/A	N/A	N/A	displays the Log Files page in the CTM web interface. Also displays the USB Logging tab and the Ethernet Logging tab.	to view , manage or copy log files, depending on user permissions
Diagnostics	In the navigation side bar: Click Diagnostics .	user with Advanced User permissions	N/A	N/A	N/A	displays the Diagnostic Page in the CTM web interface	Used for the following Diagnostics: <ul style="list-style-type: none"> • Static and Dynamic Margin Maps (Note: Only accessible to Kapsch web user) • Displaying transactions as they occur • Serial port loop-back test

Command	How is this command executed?	Who can execute this command?	Parameter Name	Default Parameter Value	Parameter Range/Options	What does this command do?	What is the purpose of this command?
	In the navigation side bar: Click to activate.	anyone	N/A	N/A	N/A	Controlled Reader shutdown	Used to shut down the Reader in a controlled manner so that a clean, manual power down can then proceed.
Log Out	In the navigation side bar: Click Log Out .	anyone	N/A	N/A	N/A	immediately logs the current user out of the CTM web interface	Used to log out of the CTM web interface
System Identification	From the Miscellaneous Information tab on the Status page: Click the System Identification button.	anyone	N/A	N/A	N/A	causes the CTM MC LED to flash green-red-amber-green three times	Used to confirm which CTM web interface is being viewed and that the computer is successfully communicating with the CTM

Command	How is this command executed?	Who can execute this command?	Parameter Name	Default Parameter Value	Parameter Range/Options	What does this command do?	What is the purpose of this command?
Reset Transaction Statistics	From the Reports by channel tab on the Statistics page: Click Reset Transaction Statistics button	user with Advanced User permissions	N/A	N/A	N/A	sets all statistical values at 0	Used to allow statistics to be tracked from a known starting point
General Tab							
Site Name	From the General tab on the Configuration page: Type a Reader name in Site Name text.	anyone	SITENM	no default value	String length: 32	sets the site name used in the log file strings and is used in the name of the configuration files	Highly recommend to enter a descriptive name, as this name is used in various log files. Used to identify which Reader the log files and configuration files originated from

Command	How is this command executed?	Who can execute this command?	Parameter Name	Default Parameter Value	Parameter Range/Options	What does this command do?	What is the purpose of this command?
Ethernet 1 (LC 1Gbps) IP Address	From the General tab on the Configuration page: Type an ETHERNET 1 port IP address in Ethernet 1 (LC 1Gbps) IP Address field..	anyone	LETHIF	192.168.1.50	N/A	Sets the IP address of the Lane Controller ethernet interface	Used to specify an appropriate ETHERNET 1 IP address when configuring an LC network
Ethernet 1 (LC 1Gbps) Subnet mask	From the General tab on the Configuration page: Type the subnet mask address in the Ethernet 1 (LC 1Gbps) Subnet Mask field	anyone	LETHNM	255.255.255.0:0	N/A	Initializes this field to a subnet mask for sites that utilize subnet addressing.	Required by sites that utilize subnet addressing.
Ethernet 2 (IRIF 100Mbps) IP Address:	From the General tab on the Configuration page: Type an ETHERNET 2 port IP address in the Ethernet 2 (IRIF 100Mbps) IP Address field..	anyone	PRIMIP	192.168.0.50 Primary 192.168.0.51 Secondary	N/A	Used to assign a unique IPv4 address (e.g. 192.168.0.50) to the right hand side (prime) side of the reader.	Used to specify an appropriate ETHERNET 2 IP address when configuring an IR network. Note: This address should be provided by the SI network planner.

Command	How is this command executed?	Who can execute this command?	Parameter Name	Default Parameter Value	Parameter Range/Options	What does this command do?	What is the purpose of this command?
IP Address	From the General tab on the Configuration page: Type an IP address in IP Address .	user with Advanced User permissions	SCNDIP	192.168.0.51	N/A	sets a unique IP address to the secondary side of the reader.	Assigns a unique IPv4 address (e.g. 192.168.0.51) to the secondary side of the reader. Note: This address should be provided by the SI network planner.
Reader IP address	From the General tab on the Configuration page: Type a Reader IP address in Reader IP Address field	user with Advanced User permissions	READIP	10.0.0.50.0	N/A	sets the IP address for the Reader	Used to specify a unique IP address for the Reader when configuring an IR network

Command	How is this command executed?	Who can execute this command?	Parameter Name	Default Parameter Value	Parameter Range/Options	What does this command do?	What is the purpose of this command?
USB Adapter IP or Bluetooth IP Address	From the General tab on the Configuration page: Type an IP address in the USB Adapter IP Address field	user with Advanced User permissions	USB_IP	192.168.2.50	N/A	sets the IP address for the USB-to-Ethernet adapter connected to one of the CTM USB ports	only needed if a USB to Ethernet or Bluetooth dongle is anticipated to be plugged in to one of the USB ports. Assign an IPv4 address to this interface. Note: Please do not use a USB-to-Ethernet and Bluetooth dongle at the same time
Default Gateway IP	From the General tab on the Configuration page: Type an IP address in the Default Gateway IP Address field	Anyone Note: Initialize this field to a IPv4 address if IP traffic needs to be routed via a gateway.	DFGWIP	0.0.0.0	N/A	tells the Reader the default gateway IP address of the gateway device	Used to allow the Reader on a network to connect to a larger network (such as the Internet) via a gateway device (such as a router)

Command	How is this command executed?	Who can execute this command?	Parameter Name	Default Parameter Value	Parameter Range/Options	What does this command do?	What is the purpose of this command?
Suppress Non-IAG Tags	From the General tab on the Configuration page: Select Suppress Non-IAG Tags check box	anyone	NONIAG	(Enabled)	Disabled) (Enabled)	Disabled: All transactions are reported Enabled: Suppresses reporting of OBUs not matching the Group ID with which the Reader is provisioned	Used to prevent incompatible report formats from being sent to the LC
Diagnostics Port Baud Rate	From the General tab on the Configuration page: Select a baud rate from the Diagnostics Port Baud Rate drop-down box	anyone	DIAGBD	(9600)	9600 19200 38400 57600 115200	sets baud rate of DIAGNOSTICS PORT on the CTM	Used to establish a baud rate for connecting a service laptop computer to the Reader via the CTM DIAGNOSTICS PORT
Reader configuration Auto-backup & Recovery	From the General tab on the Configuration page: Select the Reader configuration Auto-backup & Recovery checkbox to enable (if necessary).	anyone	CNF_BU	(Enabled)	(Disabled) (Enabled)	Enables or disables backup of configuration parameters on compact flash.	If enabled the reader can auto-recover from NV configuration checksum failures on startup and avoid a reset to factory defaults.

Command	How is this command executed?	Who can execute this command?	Parameter Name	Default Parameter Value	Parameter Range/Options	What does this command do?	What is the purpose of this command?
Reader Sync							
Enable Reader Sync	From the General tab on the Configuration page: Select the Enable Reader Sync check box	anyone	RFSYNC	Disabled)	Disabled) (Enabled)	Disabled: Reader RF interrogation is not synchronized with other Readers Enabled: Reader RF interrogation is synchronized with other Readers in the sync network	Used to synchronize superframes between Readers connected together in a synchronization network
Superframe Sync Skip	From the General tab on the Configuration page: Select either Sync to superframe or Sync to every other superframe .	user with Advanced User permissions	RFSKSK	(Sync to every superframe enabled)	(Sync to every superframe) (Sync to every other superframe)	specifies whether the Reader tries to sync every superframe or every other superframe	Used to allow Readers with different superframe sizes to sync after the same number of frames
Add 2 Dummy Frames	From the General tab on the Configuration page: Select either No or Yes	user with Advanced User permissions	RFADD2	(No)	(No) (Yes)	No: dummy frames are not added to superframe Yes: dummy frames are added to superframe.	Used to allow Readers with different superframe sizes to sync after the same number of frames

Command	How is this command executed?	Who can execute this command?	Parameter Name	Default Parameter Value	Parameter Range/Options	What does this command do?	What is the purpose of this command?
Type Of Reader Syncing To	From the General tab on the Configuration page: Select either JANUS or Badger from the drop-down box	anyone	SYNCTO	(JANUS)	(JANUS) (Badger)	JANUS: normal frame rate is used for synchronization Badger: Reader synchronization is adjusted to Badger frame rate	Used to cause JANUS® Readers to adjust to the same frame rate as BADGER Readers Note: Badger to Janus sync supported: 8-channel Badger with 8-channel Janus
Report Latency by Tag Type							
0 - Interior FPT Delay [ms]	From the General tab on the Configuration page: Enter a time (in milliseconds) in the 0-Interior FPT Delay field	user with Advanced User permissions	LYCTLO	0	0-5000	sets report delay time in milliseconds for Interior FTP OBUs (Type 0)	Used to slow down the transaction report of Type 0 OBUs to the LC for those legacy sites where the LC is expecting BADGER Reader timing

Command	How is this command executed?	Who can execute this command?	Parameter Name	Default Parameter Value	Parameter Range/Options	What does this command do?	What is the purpose of this command?
1 - Exterior FPT Delay [ms]	From the General tab on the Configuration page: Enter a time (in milliseconds) in the Exterior FPT Delay field	user with Advanced User permissions	LYCTL1	0	0-5000	sets report delay time in milliseconds for Exterior FTP OBUs (Type 1).	Used to slow down the transaction report of Type 1 OBUs to the LC for those legacy sites where the LC is expecting BADGER Reader timing
2 - Exterior LPT Delay [ms]	From the General tab on the Configuration page: Enter a time (in milliseconds) in the Exterior LPT Delay field..	user with Advanced User permissions	LYCTL2	0	0-5000	sets report delay time in milliseconds for Exterior LPT OBUs (Type 2).	Used to slow down the transaction report of Type 2 OBUs to the LC for those legacy sites where the LC is expecting BADGER Reader timing

Command	How is this command executed?	Who can execute this command?	Parameter Name	Default Parameter Value	Parameter Range/Options	What does this command do?	What is the purpose of this command?
3 - LCD Display Delay [ms]	From the General tab on the Configuration page: Enter a time (in milliseconds) in the LCD Display Delay field..	user with Advanced User permissions	LYCTL3	0	0-5000	sets report delay time in milliseconds for LCD Display OBUs (Type 3).	Used to slow down the transaction report of Type 3 OBUs to the LC for those legacy sites where the LC is expecting BADGER Reader timing
4 - Commercial Vehicle (CVO) Delay [ms]	From the General tab on the Configuration page: Enter a time (in milliseconds) in the Commercial Vehicle (CVO) Delay field..	user with Advanced User permissions	LYCTL4	0	0-5000	sets report delay time in milliseconds for CVO OBUs (Type 4).	Used to slow down the transaction report of Type 4 OBUs to the LC for those legacy sites where the LC is expecting BADGER Reader timing

Command	How is this command executed?	Who can execute this command?	Parameter Name	Default Parameter Value	Parameter Range/Options	What does this command do?	What is the purpose of this command?
5 - OBU Feedback Tag Delay [ms]	From the General tab on the Configuration page: Enter a time (in milliseconds) in the OBU Feedback Tag Delay field..	user with Advanced User permissions	LYCTL5	0	0-5000	sets report delay time in milliseconds for CVO OBUs (Type 5).	Used to slow down the transaction report of Type 5 OBUs to the LC for those legacy sites where the LC is expecting BADGER Reader timing
6 - HOT Tag Delay [ms]	From the General tab on the Configuration page: Enter a time (in milliseconds) in the HOT Tag Delay field..	user with Advanced User permissions	LYCTL6	0	0-5000	sets report delay time in milliseconds for CVO OBUs (Type 6).	Used to slow down the transaction report of Type 6 OBUs to the LC for those legacy sites where the LC is expecting BADGER Reader timing

Command	How is this command executed?	Who can execute this command?	Parameter Name	Default Parameter Value	Parameter Range/Options	What does this command do?	What is the purpose of this command?
Primary/Secondary							
Redundant Mode	From the General tab on the Configuration page: Select the Redundant Mode check box..	user with Advanced User permissions	RDNDNT	1 (Redundant Mode enabled)	0 (Disabled) Enabled)	Disabled: Reader does not attempt to switch to redundant side when a failure occurs. Enabled: Reader attempts to switch to redundant side when a failure occurs (depending on configuration)	Used to enable the Reader to automatically switch over to the redundant side when a failure occurs
Dual Reporting Mode	From the General tab on the Configuration page: Select the Dual Reporting Mode check box..	user with Advanced User permissions	DUALRP	Dual Reporting Mode disabled)	Dual Reporting Mode disabled) Dual Reporting Mode enabled)	sets Reader to Dual Reporting mode	Used to gather reports from both the primary and secondary sides of the Reader
Auto Recovery To Prime	From the General tab on the Configuration page: Select the Auto Recovery To Prime check box.	user with Advanced User permissions	A_RCVR	Auto Recovery to Prime Enabled)	Disabled) Enabled)	Disabled: Reader does not attempt to recover to Primary side when failure clears. Enabled: Reader automatically attempts to recover to Primary side when a Primary failure clears.	to enable the Reader to automatically switch back to the primary side once a primary side failure has cleared

Command	How is this command executed?	Who can execute this command?	Parameter Name	Default Parameter Value	Parameter Range/Options	What does this command do?	What is the purpose of this command?
Switchover on Serial Link Down	From the General tab on the Configuration page: With Serial communications enabled, select the Switchover on Serial Link Down check box.	user with Advanced User permission	SOSERL	0	0-1	Disabled: switchover does not occur when the Serial link is down. Enabled: Enable means switch-over to secondary side if the reader determines a serial link to the lane controller is down. Has no meaning on secondary side.	NOTE: If enabled, you MUST also disable all unused COM ports (see SERIAL tab) as well as unused LC destinations (see LC tab).
Switchover on Ethernet LC Link Down	From the General tab on the Configuration page: With Ethernet LC communications enabled, select the Switchover on Ethernet LC Link Down check box.	user with Advanced User permissions	SO_ETH	Disabled	Disabled Enabled	Disabled: switchover does not occur when the Ethernet LC link is down. Enabled: to enable the Reader to switchover from the primary side to the secondary side when an Ethernet link to the LC is down	N/A

Command	How is this command executed?	Who can execute this command?	Parameter Name	Default Parameter Value	Parameter Range/Options	What does this command do?	What is the purpose of this command?
Switchover on Ethernet IRIF Link Down	From the General tab on the Configuration page: With Ethernet LC communications enabled, select the Switchover on Ethernet IRIF Link Down check box.	user with Advanced User permissions	SOIRIF	0	0-1	Disabled: switchover does not occur when the Ethernet IRIF link is down. Enabled: Enable means switch-over if a connection to an adjacent reader over the Ethernet interface is down.	N/A
Reader Statistics							
Use database	From the General tab on the Configuration page: Select the Use Database checkbox or leave it unselected	user with Advanced User permissions	STATDB	Enabled	Disabled Enabled	If checked (enabled) the reader uses non-volatile database for statistics for all protocols. If unchecked (disabled), use legacy volatile counters.	N/A
Database (Txns) Maximum records	From the General tab on the Configuration page: Enter the appropriate quantity in the Database (Txns) Maximum records field	user with Advanced User permissions	SDBMAX	10000	min: 100 max: 50000	Use to indicate the quantity of transaction records.	Maximum statistics database record count. Suggest 10,000 records for typical use. Note: Higher values increase CPU load.

Command	How is this command executed?	Who can execute this command?	Parameter Name	Default Parameter Value	Parameter Range/Options	What does this command do?	What is the purpose of this command?
Database (Summary) Retention period [7–90 days]	From the General tab on the Configuration page: Enter the appropriate quantity in the Database (Summary) Retention period [7–90 days] field	user with Advanced User permissions	SDSRET	30	min: 7 max: 90	Use to specify how many days transaction summary data is retained.	N/A
Database (Summary) Interval [1–30 minutes]	From the General tab on the Configuration page: Enter the appropriate quantity in the Database (Summary) Interval [1–30 minutes] field	user with Advanced User permissions	SDSINT	15	min: 1 max: 30	Generates transaction summary records into database at specified time interval. Values below 5 minutes for testing only. May be automatically adjusted by reader based on load and retention period	Generates transaction summary records into database at specified time interval

Command	How is this command executed?	Who can execute this command?	Parameter Name	Default Parameter Value	Parameter Range/Options	What does this command do?	What is the purpose of this command?
Dashboard							
Transaction Summary dashboard	From the General tab on the Configuration page: Select the Transaction Summary dashboard checkbox or leave it unselected	user with Advanced User permissions	DSHTXN	Enabled	Disabled Enabled	Show a transaction summary dashboard on the home page, including a daily tag transaction count by tag protocol.	

Command	How is this command executed?	Who can execute this command?	Parameter Name	Default Parameter Value	Parameter Range/Options	What does this command do?	What is the purpose of this command?
Test Tags tab							
Test Tag Single Fault Threshold	From the Test Tags tab on the Configuration page: Enter a number in the Test Tag Single Fault Threshold field.	user with Advanced User permissions	SFT____	6	1-99	sets the number of consecutive test tag faults before a channel is considered bad	to continuously monitor channel quality and set a failure threshold
Test Tag Multiple Fault Threshold	From the Test Tags tab on the Configuration page: Enter a number in the Test Tag Multiple Fault Threshold field, then, press Enter or select a different tab.	user with Advanced User permissions	MFT____	8	1-8	sets the number of bad channels that trigger a switchover	to continuously monitor channel quality and set a failure threshold for triggering a switchover
Test Tag Period	From the Test Tags tab on the Configuration page: Enter a time, in seconds, in the Test Tag Period field, then.	user with Advanced User permissions	TTP____	30	10-99	sets the test tag period	to set the frequency of test tag checks

Command	How is this command executed?	Who can execute this command?	Parameter Name	Default Parameter Value	Parameter Range/Options	What does this command do?	What is the purpose of this command?
Test Tag State	From the Test Tags tab on the Configuration page: Enter a time, in seconds, in the Test Tag Period field, then.	user with Advanced User permissions	RFTTST	Disable	Disable Enable	Enable means start checking for test tags and switch-over if the Multiple Fault Threshold has been reached.	N/A
Lane Assignment tab							
IAG 6B 6C Allegro ATA SeGo	From the Lane Assignment tab on the Configuration page: Select First to Read/Program , Majority , or Interpolated from the Lane Assignment Algorithm box.	user with Advanced User permissions	VTALGO VTAG6B VTAG6C VTAGAG VTAGAA VTAGSG	Majority	First to read program Majority 2-Interpolated	runs the selected tag assignment algorithm	to set which algorithm is used for determining OBU lane assignment between multiple Readers

Command	How is this command executed?	Who can execute this command?	Parameter Name	Default Parameter Value	Parameter Range/Options	What does this command do?	What is the purpose of this command?
Interpolated Handshake Equalization Ratio (%)	From the Lane Assignment tab on the Configuration page: Select Interpolated from the Lane Assignment Algorithm box. When Interpolated Handshake Equalization Ratio (%) field appears, enter a value in the field.	user with Advanced User permissions	HSEQUR	25	1-100	Assigns a numerical value to the Handshake equalization ratio field used in interpolated voting	used in interpolated voting
Communication Method	From the Lane Assignment tab on the Configuration page: Select Disabled , Badger-style CRA , or Ethernet from Communication Method drop-down box.	user with Advanced User permissions	MULTRD	Disabled	Disabled Badger-Style CRA Ethernet	Disabled: Reader is not set to communicate with other Readers. Badger-Style CRA: Voting between Readers relies on vote counts. Ethernet: Voting between Readers relies on algorithms.	sets how Readers communicate when determining lane assignments between multiple Readers

Command	How is this command executed?	Who can execute this command?	Parameter Name	Default Parameter Value	Parameter Range/Options	What does this command do?	What is the purpose of this command?
Cross-Reader Reporting	From the Lane Assignment tab on the Configuration page, with Badger-style CRA or Ethernet communication method enabled: Select Disabled , Report All , or Report Non-Zero from the Cross-Reader Reporting drop-down box.	user with Advanced User permissions	CRARPT	Disabled	Disabled Report All Report Non-Zero	Disabled: Reader is not set to communicate with other Readers. Report All results in all transactions being sent to the LC Report Non-Zero informs the LC of suppressed transactions	to set which transactions are sent to LC in multi-reader configurations
IRIF Timeout [ms] (make sure the TTO values of all IRIF readers are the same)	From the Lane Assignment tab on the Configuration page, with Ethernet communication method enabled: Enter a time, in milliseconds, in the IRIF Timeout field.	user with Advanced User permissions	IRIFTO	50	30-5000	sets IRIF timeout time	sets the threshold for determining an IR network problem and enable a switchover if enabled

Command	How is this command executed?	Who can execute this command?	Parameter Name	Default Parameter Value	Parameter Range/Options	What does this command do?	What is the purpose of this command?
Enable Left Reader	From the Lane Assignment tab on the Configuration page, with Ethernet communication method enabled: Select the Enable Left Reader check box.	user with Advanced User permissions	LEFTRD	Disabled	Disabled Enabled	Disabled: Reader does not coordinate voting with Reader covering lanes to the left. Enabled: Reader coordinated lane assignment voting with Reader covering lanes to the left.	tells this Reader if there is another Reader in the IR network that is covering ORT lanes that are to the left of the lanes this Reader is covering (see Figure 5-13, page 191)
Left Reader IP	From the Lane Assignment tab on the Configuration page, with the Left Reader enabled, Enter the IP address of the left Reader in the Left Reader IP field.	user with Advanced User permissions	LEFTIP	0,0,0,0,50	N/A	informs the Reader what the IP address is of the Reader covering lanes to the left of this Reader.	to provide the Reader with the IP address of the left Reader in the IR network (see Figure 5-13, page 191)

Command	How is this command executed?	Who can execute this command?	Parameter Name	Default Parameter Value	Parameter Range/Options	What does this command do?	What is the purpose of this command?
Enable Right Reader	From the Lane Assignment tab on the Configuration page, with Ethernet communication method enabled: Select the Enable Right Reader check box.	user with Advanced User permissions	RGHTRD	Disabled)	Disabled) Enabled)	Disabled: Reader does not coordinate voting with Reader covering lanes to the right. Enabled: Reader coordinated lane assignment voting with Reader covering lanes to the right.	tells this Reader if there is another Reader in the IR network that is covering ORT lanes that are to the right of the lanes this Reader is covering (see Figure 5-13, page 191)
Right Reader IP	From the Lane Assignment tab on the Configuration page, with the Right Reader enabled, Enter the IP address of the right Reader in the Right Reader IP field.	user with Advanced User permissions	RGHTIP	0,0,0,0,50	N/A	informs the Reader what the IP address is of the Reader covering lanes to the right of this Reader.	to provide the Reader with the IP address of the right Reader in the IR network (see Figure 5-13, page 191)

Command	How is this command executed?	Who can execute this command?	Parameter Name	Default Parameter Value	Parameter Range/Options	What does this command do?	What is the purpose of this command?
Tag Programming tab							
Lane Number (channel assignment)	From the Tag Programming tab on the Configuration page: With Lane Number R/W enabled, enter a value from 0 to 31 in each channel number field.	anyone	RFLNUM	Per-instance defaults. Instance:0 value:1 instance:1 value:2 . . . instance:30 value:31	0-31	assigns a lane number to each channel. ATTENTION: this field should be used with care as the value may not reflect the channel on which the tag was reported.	to indicate in OBU data which lane an OBU was in when a transaction occurred
Plaza ID	From the Tag Programming tab on the Configuration page: With Plaza ID enabled, enter a numeric Plaza ID.	anyone	PID__	0	0-127	sets Plaza ID	to keep a record in OBUs of the Plaza ID

Command	How is this command executed?	Who can execute this command?	Parameter Name	Default Parameter Value	Parameter Range/Options	What does this command do?	What is the purpose of this command?
Agency ID	From the Tag Programming tab on the Configuration page: With Agency ID enabled, enter a numeric Agency ID.	anyone	AID____	0	0 - 127	sets the agency ID	to keep a record in OBUs of the agency ID
6C Read-Only Mode	From the Tag Programming tab on the Configuration page:	anyone	6CROLY	Enable	Disable Enable	Controls whether the reader writes or does not write to 6C tags.	N/A
6C Try-To-Program Timeout [sec]	From the Tag Programming tab on the Configuration page: Ensure 6C Read-Only Mode checkbox is unchecked. Enter time quantity in seconds in the 6C Try-To-Program Timeout [sec] field	anyone	6C_TTP	500	min: 0 max: 4294967295	Specifies, in seconds, the duration after which additional programming attempts will be made with an existing 6C tag.	N/A
IAG Read-Only Mode	From the Tag Programming tab on the Configuration page:	anyone	RDONLY	Disable	Disable Enable	Controls whether the reader writes or does not write to IAG tags.	

Command	How is this command executed?	Who can execute this command?	Parameter Name	Default Parameter Value	Parameter Range/Options	What does this command do?	What is the purpose of this command?
Traffic Management Programming (TMP)							
Enable TMP	From the Tag Programming tab on the Configuration page: Enable the Enable TMP checkbox	anyone	TMP___	Enable	Enable Disable	Enable means write a timestamp and Reader ID in transponder memory. Disabled means the reader does not update those fields.	N/A
Reader ID	From the Tag Programming tab on the Configuration page: Enable or disable the Reader ID checkbox	anyone	rw_RID	Enable	Enable Disable	Determines whether or not to program the TM-DATA reader ID field of the tag's R/W area	N/A
Reader ID	From the Tag Programming tab on the Configuration page: Enter a value in the Reader ID field. Note: Make sure a unique Reader ID is used when there are multiple readers at a plaza.	anyone	RID___	0	min: 0 max: 4095	Use to enter a value which is written into the transponder if either Traffic Management or Cross Reader Algorithm (Classic) is enabled.	N/A

Command	How is this command executed?	Who can execute this command?	Parameter Name	Default Parameter Value	Parameter Range/Options	What does this command do?	What is the purpose of this command?
TM Date/Time	From the Tag Programming tab on the Configuration page: Either enable or disable the TMP checkbox.	anyone	rwTMDT	Enabled	Disabled Enabled	Determines whether or not to program the TM-DATA date/time fields of the tag's R/W area	N/A
TM Date/Time	From the Tag Programming tab on the Configuration page: With TMP enabled, select TM Date/Time .	anyone	TMDTTM	Disabled	Disabled Enabled	Disabled: the Reader date and time is not written to OBUs Enabled: the Reader date and time is written to OBUs	to keep a record in OBUs of the TM transaction time
Toll Collection Programming (TCP)							
Enable TCP	From the Tag Programming tab on the Configuration page: With the Read-Only Mode check box cleared, select the Enable TCP check box.	anyone	TCP___	1 (Enabled)	0 (Disabled) 1 (Enabled)	Disabled: Reader is not permitted to update toll collection fields in OBUs Enabled: Reader is permitted to update toll collection fields in OBUs	to control if toll collection fields can be written to OBUs and to access TCP settings in the Tag Programming tab

Command	How is this command executed?	Who can execute this command?	Parameter Name	Default Parameter Value	Parameter Range/Options	What does this command do?	What is the purpose of this command?
R/W Enable Plaza ID	From the Tag Programming tab on the Configuration page: With TCP enabled, select the Plaza ID check box.	anyone	rw_PZID	N/A	N/A	enables Plaza ID to be written to OBUs	to write Plaza ID to OBUs and access the Plaza ID field
Agency ID (enable)	From the Tag Programming tab on the Configuration page: With TCP enabled, select the Agency ID check box.	anyone	rw_AID	Enabled	Enabled Disabled	enables Agency ID to be written to OBUs	to write the agency ID to OBUs and access the Agency ID field
Transaction number programming (enable)	From the Tag Programming tab on the Configuration page: With TCP enabled, select the Transaction number programming check box.	anyone	rw_TXN	Enabled	Enabled Disabled	enables a transaction number to be written to the OBU	to write a transaction number to OBUs and to access the transaction number programming options

Command	How is this command executed?	Who can execute this command?	Parameter Name	Default Parameter Value	Parameter Range/Options	What does this command do?	What is the purpose of this command?
Transaction number programming	From the Tag Programming tab on the Configuration page: With Transaction number programming enabled, select the appropriate calculation type from the Transaction number programming drop-down box.	anyone	TFRM__	Reprogram with 16 bit sequential transaction number	Don't reprogram transaction field Reprogram with 16 bit random number Reprogram with 16 bit sequential transaction number Reprogram with 8 bit random number and 8 bit sequential number	sets the way the Reader creates an OBU transaction number	to choose how the Reader determines OBU transaction numbers

Command	How is this command executed?	Who can execute this command?	Parameter Name	Default Parameter Value	Parameter Range/Options	What does this command do?	What is the purpose of this command?
OBU Feedback	<p>From the Tag Programming tab on the Configuration page:</p> <p>Select the OBU feedback check box.</p> <p>Note: If the checkbox is grayed out, it is because the Toll Rate/Balance Adjustment checkbox is checked. Uncheck to activate the OBU feedback checkbox</p>	anyone	rw_OBU	Disabled	Disabled Enabled	<p>Disabled: programs feedback-type OBUs to not provide feedback</p> <p>Enabled: programs feedback-type OBUs to provide feedback</p>	to configure feedback-type OBUs to notify when an ETC transaction has occurred.
Toll Rate / Balance Adjustment	<p>From the Tag Programming tab on the Configuration page:</p> <p>Select the Toll Rate / Balance Adjustment check box.</p> <p>Note: If the checkbox is grayedout, it is because the OBU feedback checkbox is checked. Uncheck to activate the Toll Rate/Balance Adjustment checkbox.</p>	anyone	rw_TRB	Disabled	Disabled Enabled	<p>Disabled: blanks out the Toll Rate / Balance Adjustment tab.</p> <p>Enabled: Reader is responsible for adjusting Toll Rate and Balance in OBU.</p>	to allow the Toll/Rate Balance adjustment to be made by the Reader and access configuration settings.

Command	How is this command executed?	Who can execute this command?	Parameter Name	Default Parameter Value	Parameter Range/Options	What does this command do?	What is the purpose of this command?
TC Date/Time	From the Tag Programming tab on the Configuration page: With TCP enabled, select TC Date/Time .	anyone	TCDTTM	Disabled	Disabled Enabled	Disabled: Reader Date/Time not written to OBU TC data fields. Enabled: Reader Date/Time written to OBU TC data fields.	to keep a record in OBUs of the TC transaction time
RW Format	From the Tag Programming tab on the Configuration page: With TCP enabled, select the RW Format check box.	anyone	rw__RW	Disabled	Disabled Enabled	Disabled: RW Format not affected Enabled: Reader controls how OBU scratchpad memory is encoded	determines how the data stored in OBU scratchpad memory is encoded
Lane Number (enable)	From the Tag Programming tab on the Configuration page: With TCP enabled, select the Lane Number R/W check box, then, press Enter or select a different tab.	anyone	rwLANE	Enabled	Disabled Enabled	enables lane number programming	to enable ability to set a specific lane number for each RF channel

Command	How is this command executed?	Who can execute this command?	Parameter Name	Default Parameter Value	Parameter Range/Options	What does this command do?	What is the purpose of this command?
OBU Feedback tab							
OBU Feedback type	From the OBU Feedback tab on the Configuration page: With OBU feedback enabled, select Type 1 or Type 2 .	anyone	OBUTYP	Type 1	Type 1 Type 2	Specifies which type of OBU feedback to employ: TYPE1 : all tags provide the same feedback TYPE2 : determine what feedback to use based on a table lookup choose one of: 0 - Type 1 1 - Type 2	to turn on and specify which type of feedback an OBU provides
OBU Feedback Type 1							
OBU Audible Feedback	From the OBU Feedback tab on the Configuration page: With OBU feedback enabled and Type 1 selected, select a feedback option from the OBU Audible Feedback drop-down box.	anyone	OBUAUD	Off	Off 4 cycles: 0.25s ON, 0.25s OFF 1 cycle: 1.5s ON 3 cycles: 0.5s ON, 0.2s OFF	turns on and specifies the type of audible feedback an OBU provides	to configure how long and how many times an OBU beeps to indicate a successful transaction

Command	How is this command executed?	Who can execute this command?	Parameter Name	Default Parameter Value	Parameter Range/Options	What does this command do?	What is the purpose of this command?
OBU Visual Feedback	From the OBU Feedback tab on the Configuration page: With OBU feedback enabled and Type 1 selected, select a feedback option from the OBU Visual Feedback drop-down box.	anyone	OBUVIS	Off	Off Green: 2s Red: 2s Yellow: 2s	turns on and specifies the type of visual feedback an OBU provides	to configure how long and what color an OBU LED flashes to indicate a successful transaction
OBU Feedback Type 2							
Valid Tag: Audible	From the OBU Feedback tab on the Configuration page: With OBU feedback enabled, and Type 2 selected, select a feedback option from the OBU Audible Feedback drop-down box.	anyone	O2VLDA	Off	Off 4 cycles: 0.25s ON, 0.25s OFF 1 cycle: 1.5s ON 3 cycles: 0.5s ON, 0.2s OFF	Specifies the audible feedback to provide for a valid tag	to configure how long and how many times an OBU beeps to indicate a successful transaction

Command	How is this command executed?	Who can execute this command?	Parameter Name	Default Parameter Value	Parameter Range/Options	What does this command do?	What is the purpose of this command?
Valid Tag: Visual	From the OBU Feedback tab on the Configuration page: With OBU feedback enabled, and Type 2 selected, select a feedback option from the OBU Visual Feedback drop-down box.	anyone	O2VLDV	Off	Off Green: 2s Red: 2s Yellow: 2s	Specify the visual feedback to provide in the case of a valid tag	to configure how long and what color an OBU LED flashes to indicate a successful transaction
Invalid Tag: Audible	From the OBU Feedback tab on the Configuration page: With OBU feedback enabled, and Type 2 selected, select a feedback option from the OBU Audible Feedback drop-down box.	anyone	O2IVDA	Off	Off 4 cycles: 0.25s ON, 0.25s OFF 1 cycle: 1.5s ON 3 cycles: 0.5s ON, 0.2s OFF	Specify the audible feedback to provide for an invalid tag	to configure how long and how many times an OBU beeps to indicate a successful transaction

Command	How is this command executed?	Who can execute this command?	Parameter Name	Default Parameter Value	Parameter Range/Options	What does this command do?	What is the purpose of this command?
Invalid Tag: Visual	From the OBU Feedback tab on the Configuration page: With OBU feedback enabled, and Type 2 selected, select a feedback option from the OBU Visual Feedback drop-down box.	anyone	O2IVDV	Off	Off Green: 2s Red: 2s Yellow: 2s	Specify the visual feedback to provide in the case of an invalid tag	to configure how long and what color an OBU LED flashes to indicate a successful transaction
Lost/Stolen Tag: Audible	From the OBU Feedback tab on the Configuration page: With OBU feedback enabled, and Type 2 selected, select a feedback option from the OBU Audible Feedback drop-down box.	anyone	O2LSTA	Off	Off 4 cycles: 0.25s ON, 0.25s OFF 1 cycle: 1.5s ON 3 cycles: 0.5s ON, 0.2s OFF	Specify the audible feedback to provide for a lost/stolen tag	to configure how long and how many times an OBU beeps to indicate a successful transaction

Command	How is this command executed?	Who can execute this command?	Parameter Name	Default Parameter Value	Parameter Range/Options	What does this command do?	What is the purpose of this command?
Lost/Stolen Tag: Visual	From the OBU Feedback tab on the Configuration page: With OBU feedback enabled, and Type 2 selected, select a feedback option from the OBU Visual Feedback drop-down box.	anyone	O2LSTV	Off)	Off) 1 (Green: 2s) 2 (Red: 2s) 3 (Yellow: 2s)	Specify the visual feedback to provide in the case of a lost/stolen tag	to configure how long and what color an OBU LED flashes to indicate a successful transaction
Low Balance Tag: Audible	From the OBU Feedback tab on the Configuration page: With OBU feedback enabled, and Type 2 selected, select a feedback option from the OBU Audible Feedback drop-down box.	anyone	O2LBLA	Off)	Off) 1 (4 cycles: 0.25s ON, 0.25s OFF) 2 (1 cycle: 1.5s ON) 3 (3 cycles: 0.5s ON, 0.2s OFF)	Specify the audible feedback to provide for a low balance tag	to configure how long and how many times an OBU beeps to indicate a successful transaction

Command	How is this command executed?	Who can execute this command?	Parameter Name	Default Parameter Value	Parameter Range/Options	What does this command do?	What is the purpose of this command?
Low Balance Tag: Visual	From the OBU Feedback tab on the Configuration page: With OBU feedback enabled, and Type 2 selected, select a feedback option from the OBU Visual Feedback drop-down box.	anyone	O2LBLV	Off)	Off) 1 (Green: 2s) 2 (Red: 2s) 3 (Yellow: 2s)	Specify the visual feedback to provide in the case of a low balance tag	to configure how long and what color an OBU LED flashes to indicate a successful transaction
Not Available / Internal Error: Audible	From the OBU Feedback tab on the Configuration page: With OBU feedback enabled, and Type 2 selected, select a feedback option from the OBU Audible Feedback drop-down box.	anyone	O2NA_A	Off)	Off) 1 (4 cycles: 0.25s ON, 0.25s OFF) 2 (1 cycle: 1.5s ON) 3 (3 cycles: 0.5s ON, 0.2s OFF)	Specify the audible feedback to provide for a not available / internal error	to configure how long and how many times an OBU beeps to indicate a successful transaction

Command	How is this command executed?	Who can execute this command?	Parameter Name	Default Parameter Value	Parameter Range/Options	What does this command do?	What is the purpose of this command?
<p>Not Available / Internal Error: Visual</p>	<p>From the OBU Feedback tab on the Configuration page: With OBU feedback enabled, and Type 2 selected, select a feedback option from the OBU Visual Feedback drop-down box.</p>	<p>anyone</p>	<p>O2NA_V</p>	<p>Off)</p>	<p>Off) 1 (Green: 2s) 2 (Red: 2s) 3 (Yellow: 2s)</p>	<p>Specify the visual feedback to provide in the case of a not available / internal error</p>	<p>to configure how long and what color an OBU LED flashes to indicate a successful transaction</p>

Command	How is this command executed?	Who can execute this command?	Parameter Name	Default Parameter Value	Parameter Range/Options	What does this command do?	What is the purpose of this command?
Toll Rate / Balance adjustment tab							
Toll Rate/Balance adjustment	From the Tag Programming tab on the Configuration page: with OBU Feedback disabled, select the Toll Rate/Balance adjustment check box.	anyone	rw_TRB	Disabled)	Disabled) 1 (Enabled)	Disabled: Reader does not adjust Toll Rate or Balance Enabled: Reader is responsible for adjusting Toll Rate and Balance in OBU.	to allow the Toll/Rate Balance adjustment to be made by the Reader and access configuration settings
TRBA BAT Processing Type	From the Toll Rate/Balance tab on the Configuration page: with Toll Rate/Balance adjustment enabled, select BAT 1-Fixed Toll or BAT 2-Variable Toll, then, click the Update TRBA Configuration button	anyone	TRBTYP	BAT 1-Fixed Toll)	0 (BAT 1-Fixed Toll) 1 (BAT 2-Variable Toll)	BAT 1-Fixed Toll: the Reader charges a toll based on the RF Channel(i.e. lane) and type of vehicle BAT 2 –VariablT Toll: the Reader charges a toll based on whether the Reader is at an entry or exit	to enable either fixed toll or variable toll charges and provide access to related toll options

Command	How is this command executed?	Who can execute this command?	Parameter Name	Default Parameter Value	Parameter Range/Options	What does this command do?	What is the purpose of this command?
Toll Rate Table Select	From the Toll Rate/Balance tab on the Configuration page: with BAT 1 enabled, select one of four toll rates from the Toll Rate Table Select drop-down box for each RF channel click the Update TRBA Configuration button	anyone	TRBATS	Table 1)	Table 1) (Table 2) (Table 3) 3 (Table 4)	sets the toll rate for each RF Channel based on the table selected	to allow a Reader to charge different rates, depending on which lane a vehicle is in
Entry/Exit Reader	From the Toll Rate/Balance tab on the Configuration page: with BAT 2 enabled, select Entry Reader or Exit Reader click the Update TRBA Configuration button	anyone	TRBAER	Entry Reader)	Entry Reader) 1 (Exit Reader)	Entry Reader: This Reader location is used as the highway entry point when calculating the toll Exit Reader: This Reader location is used as the highway exit point when calculating the toll	to allow a Reader to charge a different rate on entry and exit

Command	How is this command executed?	Who can execute this command?	Parameter Name	Default Parameter Value	Parameter Range/Options	What does this command do?	What is the purpose of this command?
Enforce Adjustment ID Checking	From the Toll Rate/Balance tab on the Configuration page: select the Enforce Adjustment ID Checking check box click the Update TRBA Configuration button	anyone	TRBEAI	Disabled)	Disabled) 1 (Enabled)	Disabled: no limits on how often Reader can update OBU balance Enabled: limits how often Reader can update OBU balance	to set limits on how frequently the balance stored in a toll/balance OBU can be updated.
Channel tab							
TDM Enable	From the Channel tab on the Configuration page: Select the TDM Enable checkbox.	anyone	TDMEBL	Disabled)	Disabled) 1 (Enabled)	Disabled: TDM selections not available to configure. Enabled: TDM selections available for configuration.	Enables TDM RF scanning. Note: At least one of 'TDM Enable' or 'FDM Enable' must be enabled at all times.

Command	How is this command executed?	Who can execute this command?	Parameter Name	Default Parameter Value	Parameter Range/Options	What does this command do?	What is the purpose of this command?
TDM RF State	From the Channel tab on the Configuration page: Select one of the choices offered from the drop down menu for every appropriate channel.	anyone	RF_STS	0 (Offline)	0 (Offline) 1 Active 2 Guard 3 Skip	Offline means the MRFM-S module is off. Active means the MRFM-S module is on and reports transactions on this channel. Guard means MRFM-S module is on, but transactions assigned to this channel are not reported. Skip controls the scanning rate and should be used only for channels 5 or higher.	Used for IAG, Allegro protocols,
TDM Tag Protocol	From the Channel tab on the Configuration page: Select one or both of the checkboxes for every appropriate channel.	anyone	TDMPT	0	0-3	Specifies which TDM protocols are to be interrogated per channel. Select any or none of the following by adding selected values together: 0x00000001 - IAG 0x00000002 - Allegro	Used for IAG, Allegro protocols,

Command	How is this command executed?	Who can execute this command?	Parameter Name	Default Parameter Value	Parameter Range/Options	What does this command do?	What is the purpose of this command?
FDM Enable	From the Channel tab on the Configuration page: Select the FDM Enable checkbox.	anyone	FDMEBL	Disabled)	Disabled) 1 (Enabled)	Disabled: FDM selections not available to configure. Enabled: FDM selections available for configuration.	Used for ATA, 6B, 6C, Sego protocols
FDM RF State	From the Channel tab on the Configuration page: Select one of the choices offered from the drop down menu for every appropriate channel.	anyone	RFFSTS	0 (Offline)	0 (Offline) 1 Active 2 Guard	Offline means the frame timing for this channel is preserved, but the MRFM-S module is off. Active means the MRFM-S module is on and reports transactions on this channel. Guard means the MRFM-S module is on, but transactions assigned to this channel are not reported.	Used for ATA, 6B, 6C, Sego protocols

Command	How is this command executed?	Who can execute this command?	Parameter Name	Default Parameter Value	Parameter Range/Options	What does this command do?	What is the purpose of this command?
FDM Frequency (MHz)	From the Channel tab on the Configuration page: Select one of the choices offered from the drop down menu for every appropriate channel.	anyone	FDMFRQ	0	0-27	FDM tag protocol frequency. Note: Some bands are restricted based on protocol. 902.50 915.75 903.00 916.00 903.50 916.50 910.00 917.00 910.50 917.50 911.00 918.00 911.50 918.50 912.00 919.00 912.50 919.50 913.00 920.00 913.50 920.50 914.00 921.00 914.50 921.50 915.00 915.50	Used for ATA, 6B, 6C, Sego protocols

Command	How is this command executed?	Who can execute this command?	Parameter Name	Default Parameter Value	Parameter Range/Options	What does this command do?	What is the purpose of this command?
FDM Tag Protocol	From the Channel tab on the Configuration page: Select one of the choices of protocol offered from the list.	anyone	FDMPRT	0	0-5	Specify which FDM protocol to use. choose one of: Off SeGo (UID) 6B (UID) 6C (EPC) ATA SeGo (UID)+6C(EPC) 6B(UID,eATA)+6C(TID,EPC)	N/A
6C Skip Count	From the Channel tab on the Configuration page: When 6B+6C FDM Tag Protocol is selected.	Anyone	6CSKIP	3	1-10	Defines how many times the reader will attempt to read 6B tags before attempting to read a 6C tag.	This allows the reader to weight 6B tag reads versus 6C tag reads.

Command	How is this command executed?	Who can execute this command?	Parameter Name	Default Parameter Value	Parameter Range/Options	What does this command do?	What is the purpose of this command?
ATA Super-Frame Skip Count	From the Channel tab on the Configuration page:	anyone	ATASKP	0	0-15	This value defines the ON and OFF times for the ATA protocol FDM frames. I.E. how many super-frames should be generated without doing ATA before a super-frame with ATA should be created. 0 means 'do ATA on every super-frame' 1 means 'do ATA every other super-frame', etc...	Used by 6B, 6C, SeGo protocols
Channel Weight [%]	From the Channel tab on the Configuration page: Type the Channel Weight as a percent in the appropriate fields.	user with Advanced User permissions	RFWGHT	100	0-100	Enter a value from 0 to 100. At lane assignment time, the reader applies the weighting factor to all channels seeing the same transponder in a group. A channel weight of 50 means only half of the handshakes are used in comparing with adjacent channels. Typically a value other than 100 is used only for channels that straddle two physical lanes.	Used by all protocols

Command	How is this command executed?	Who can execute this command?	Parameter Name	Default Parameter Value	Parameter Range/Options	What does this command do?	What is the purpose of this command?
Group ID	From the Channel tab on the Configuration page: Type the Group ID in the appropriate fields.	user with Advanced User permissions	RFGPID	0	0-7	By default all channels are in one group, such that any cross lane reads within the group generate only one transaction. By specifying different group IDs, multiple independent coverage zones can be created. This is useful for certain applications.	Used by all protocols
LPT/FME Voting time [ms]	From the Channel tab on the Configuration page: Type the voting time in the appropriate fields.	user with Advanced User permissions	LPTVTO	300	0-9999	Specify the time after the initial entry of the transponder into the capture zone after which a report is generated. This is a trade-off between lane assignments versus latency. A value of 0 means no voting, subject to the Programming Timeout parameter. Specific to [L]icense [P]late [T]ags only.	Used by all protocols

Command	How is this command executed?	Who can execute this command?	Parameter Name	Default Parameter Value	Parameter Range/Options	What does this command do?	What is the purpose of this command?
Voting Time (all other tag types) [ms]	From the Channel tab on the Configuration page: Type the Voting Time for all other tag types in the appropriate fields.	user with Advanced User permissions	VOTETO	100	0-9999	Specify the time after the initial entry of the transponder into the capture zone, subject to the Programming Timeout parameter.	Used by all protocols
Dynamic Voting Control	From the Channel tab on the Configuration page: Select Disabled or Reader from the Dynamic voting control drop-down box (LC Speed and LC Ends are not supported).	user with Advanced User permissions	DVCTRL	Disabled	Disabled Reader LC Speed LC End	Disabled: no voting control Reader: the Reader monitors the average time an OBU is in the capture zone and uses this time to determine an appropriate voting time LC Speed: not currently supported LC End: not currently supported	to set type of voting control

Command	How is this command executed?	Who can execute this command?	Parameter Name	Default Parameter Value	Parameter Range/Options	What does this command do?	What is the purpose of this command?
Dynamic Voting Sample Size	From the Channel tab on the Configuration page: With Dynamic Voting Control set to Reader, enter the desired number of samples.	user with Advanced User permissions	DVSPSZ	20	1-50	Sets the sample size used in the Dynamic Voting Calculation	to configure the Dynamic Voting Control calculation. The number entered here is the number of previous transactions used when calculating the average voting time
Dynamic Voting Threshold [%]	From the Channel tab on the Configuration page: With Dynamic Voting Control set to Reader, enter the voting threshold percentage in the Dynamic Voting Threshold field.	user with Advanced User permissions	DVTHSD	20	5-100	sets the voting threshold percentage	to configure when the average Voting time is adjusted. The Voting time will only be updated when the Reader determines the percent change is larger than the threshold entered here

Command	How is this command executed?	Who can execute this command?	Parameter Name	Default Parameter Value	Parameter Range/Options	What does this command do?	What is the purpose of this command?
Dynamic Voting Capture Zone Span Multiplier	From the Channel tab on the Configuration page: With Dynamic Voting Control set to Reader, enter a voting time multiplier in the Dynamic Voting Capture Zone Span Multiplier field.	user with Advanced User permissions	DVCZTM	2	1-5	sets the Capture Zone Span Time multiplier	to determine how long an OBU has to be out of a capture zone before re-entry is considered a new transaction. This number is a multiple of the Average Voting time
LC tab							
Allow Remote LC Configuration	From the LC tab on the Configuration page: Select the Allow Remote LC Configuration check box.	user with Advanced User permissions	RMOTLC	1 (Enabled)	Disabled) 1 (Enabled)	Disabled: LC is not permitted to Configure Reader Enabled: allows the LC to configure the Reader remotely	allows changes to the Reader configuration from the LC

Command	How is this command executed?	Who can execute this command?	Parameter Name	Default Parameter Value	Parameter Range/Options	What does this command do?	What is the purpose of this command?
Status message buffering	From the LC tab on the Configuration page: Enable or disable the Status message buffering checkbox.	user with Advanced User permissions	LcStBf	Disable	Disable Enable	If enabled, instructs the Reader to buffer status messages in the event of a communications link loss with the Lane Controller.	N/A
LC Ethernet TCP-Socket Local Port	From the LC tab on the Configuration page	user with Advanced User permissions	LcEtPn	default: 6666	min: 1024 max: 65535	Use to select the local TCP Protocol Port Number that the Reader will listen on to accept incoming TCP connections from the Lane Controller.	
LC Ethernet TCP-Socket Timeout	From the LC tab on the Configuration page: With at least one RF Channel configured to send data to the LC via Ethernet, type a time, in milliseconds, in the LC Ethernet TCP-Socket Timeout check box.	user with Advanced User permissions	LcEtTo	500	100-5000	sets the timeout for a response from the LC via the LC Ethernet network	to determine if there is an Ethernet communication problem between the Reader and the LC

Command	How is this command executed?	Who can execute this command?	Parameter Name	Default Parameter Value	Parameter Range/Options	What does this command do?	What is the purpose of this command?
Send Heartbeat Messages	From the LC tab on the Configuration page: Select the Send Heartbeat Messages check box.	anyone	LCHTBT	1 (Enabled)	Disabled) 1 (Enabled)	Disabled: No heartbeat messages are sent to LC. Enabled: causes the Reader to send heartbeat messages to the LC via serial link	to detect communication problems between the Reader and the LC in the absence of OBU data
Heartbeat Interval	From the LC tab on the Configuration page: With heartbeat messages enabled, enter a time, in seconds, in the Heartbeat Interval check box.	anyone	LCHBTM	2	1-30	sets the heartbeat message interval	to configure how often heartbeat messages are sent from the Reader to the LC
Use RFP-Compliant Message Format	From the LC tab on the Configuration page: Select the Use RFP-Compliant Message Format check box.	user with Advanced User permissions	RfpMsg	Disabled	Disabled Enabled	enables the RFP-compliant message format	allows the Reader to report transactions to the LC in the new E-ZPass-specified format

Command	How is this command executed?	Who can execute this command?	Parameter Name	Default Parameter Value	Parameter Range/Options	What does this command do?	What is the purpose of this command?
Toll Rate / Balance Adjustment Tag Report Format:	From the LC tab on the Configuration page:	user with Advanced User permissions	TrLcFm	Toll Rate / Balance Adjustment Format	Toll Rate / Balance Adjustment Format IAG Standard Format	Specifies what format to use when issuing reports for Toll Rate / Balance Adjustment tags to the Lane Controller.	Set to ' TRBA Format ' to issue reports to the Lane Controller using the Toll Rate / Balance Adjustment Format. Set to ' IAG Standard Format ' to issue reports to the Lane Controller using the IAG Standard format.
ATA Transponder Data Format	From the LC tab on the Configuration page	user with Advanced User permissions	AtaFmt	8-bit ASCII HEX	8-bit ASCII HEX 8-bit ASCII Alphanumeric	Specify the type of ATA report formatting to employ	N/A

Command	How is this command executed?	Who can execute this command?	Parameter Name	Default Parameter Value	Parameter Range/Options	What does this command do?	What is the purpose of this command?
Report Filtering							
ATA Tag Report Filtering/Threshold:	From the LC tab on the Configuration page, select the ATA Tag Report Filtering/Threshold checkbox	user with Advanced User permissions	ATAFLT	Disabled	Disabled Enabled:1Read Enabled:2Read Enabled:3Read	Use this option to perform filtering of ATA tag reports (Voting, Post Capture) based on a set handshake count threshold. Sets the minimum number of ATA tag reads that must occur on any given channel before a given tag is processed and/or reported to the Lane Controller.	Set appropriately, this feature can help reduce the incidence of ATA 'Phantom' reads/reports.
Verify ATA Data CRC:	From the LC tab on the Configuration page	user with Advanced User permissions	ATAVDC	Enabled	Disabled Enabled	If enabled, instructs the Reader to perform a CRC validation check on the received ATA data. If the incoming data does not pass the CRC check, handshake messages, Note: if enabled, may be flagged as invalid, or suppressed entirely.	N/A

Command	How is this command executed?	Who can execute this command?	Parameter Name	Default Parameter Value	Parameter Range/Options	What does this command do?	What is the purpose of this command?
Reporting							
Voting Report	From the LC tab on the Configuration page	user with Advanced User permissions	VOTRPT	per-instance defaults: IAG: enabled all others: disabled	Disabled Enabled	Used to choose to send a voting report	N/A
Generate Initial Report	From the LC tab on the Configuration page	user with Advanced User permissions	INIRPT	Disabled	Disabled Enabled	Used to choose to send or not to send an initial report the first time a new tag is seen	N/A
Raw Handshake Report	From the LC tab on the Configuration page	user with Advanced User permissions	RAWRPT	per-instance defaults: IAG: disabled all others: enabled	Disabled Enabled	Used to send a handshake to the LC for every tag read	N/A
Generate Post-Capture-Zone Report	From the LC tab on the Configuration page	user with Advanced User permissions	PCZRPT	Disabled	Disabled Enabled	Used to choose to generate and potentially send a post-capture-zone report	N/A
Generate Estimated-Vehicle-Speed Report	From the LC tab on the Configuration page	user with Advanced User permissions	EVS RPT	Disabled	Disabled Enabled	Used to choose to generate and send an Estimated Vehicle Speed report	N/A

Command	How is this command executed?	Who can execute this command?	Parameter Name	Default Parameter Value	Parameter Range/Options	What does this command do?	What is the purpose of this command?
Minimum Speed Report sample count	From the LC tab on the Configuration page	user with Advanced User permissions	EVSMSS	1	min: 1 max: 10	The reader sets the ZC field in EVS Report to 9999 when the sample count	N/A
Destination	From the LC tab on the Configuration page: Select the Serial and/or Ethernet check box for each RF channel	anyone	LCDEST	1	min: 0 max: 15	Serial: sets channel to communicate with the LC by a serial connection Ethernet: sets channel to communicate with the LC by an Ethernet connection	sets how individual RF channels communicate with the LC

Command	How is this command executed?	Who can execute this command?	Parameter Name	Default Parameter Value	Parameter Range/Options	What does this command do?	What is the purpose of this command?
Serial Port	From the LC tab on the Configuration page: With serial communications enabled, select the appropriate LPM COM Port from the Serial Port drop-down	anyone	LCSERL	per-instance defaults: instance:0 value:0 instance:1 value:1 instance:2 value:2 instance:3 value:3 instance:4 value:4 instance:5 value:5 instance:6 value:6	min: 0 max: 7	Specify the physical serial port on which to send transaction reports. Note: Channels can report on separate serial ports, or can be multiplexed onto a single serial port.	to configure which LPM COM Port sends data for a specific MRFM-S channel
Destination IP Address	From the LC tab on the Configuration page:	anyone	LCIPPT	N/A	N/A	this specifies the destination IP address and port.	N/A
Dual Destination IP Address	From the LC tab on the Configuration page:	anyone	LC2IPP	N/A	N/A	this specifies the Dual Destination IP address and port.	N/A

Command	How is this command executed?	Who can execute this command?	Parameter Name	Default Parameter Value	Parameter Range/Options	What does this command do?	What is the purpose of this command?
Tertiary Ethernet Destination IP Address (IREADs only)	From the LC tab on the Configuration page:	anyone	LC3IPP	N/A	N/A	this specifies the Tertiary Destination IP address and port. Note: Only IREADs are sent over this link	N/A
Status Reports	From the LC-extended tab on the Configuration page:	anyone	EIR_SR	Disabled	Disabled Enabled	Specifies which Extended Information values are to be included in Status Reports sent to the Lane Controller.	N/A
Transaction Reports (Initial-Read, Voting, Post-Capture, Est.Veh.Speed)	From the LC-extended tab on the Configuration page:	anyone	EIR_TN	Disabled	Disabled Enabled	Specifies which Extended Information values are to be included in Transaction Reports (Initial Read, Voting, Post-Capture, and/or Estimate Vehicle Speed) reports sent to the Lane Controller.	N/A
Raw Handshake Reports	From the LC-extended tab on the Configuration page	anyone	EIR_RH	0	min: 0 max: 31	Specifies which Extended Information values are to be included in Raw Handshake reports sent to the Lane Controller.	N/A

Command	How is this command executed?	Who can execute this command?	Parameter Name	Default Parameter Value	Parameter Range/Options	What does this command do?	What is the purpose of this command?
LC Retry Timeout	From the Serial tab on the Configuration page: Enter a time, in milliseconds, in the LC Retry Timeout field.	user with Advanced User permissions	PROTO	1000	50-1000	sets the LC retry timeout	to set the time that the Reader waits for LC confirmation before resending data
Serial Port State	From the Serial tab on the Configuration page: Select the Serial Port State check box for the required LPM COM port.	anyone	COM_ST	Enabled	Disabled Enabled	Disabled: LCM COM port disabled Enabled: LCM COM port enabled to communicate with LC	to enable or disable communications on each LPM COM port
Baud Rate	From the Serial tab on the Configuration page: With the Serial Port State enabled, select the desired Baud Rate from the drop-down box.	anyone	COM_BR	19200	9600 19200 38400 57600 115200	sets the LPM baud rate for individual COM ports	to configure the LPM baud rate on a port by port basis

Command	How is this command executed?	Who can execute this command?	Parameter Name	Default Parameter Value	Parameter Range/Options	What does this command do?	What is the purpose of this command?
Data Bits	From the Serial tab on the Configuration page: With the Serial Port State enabled, select the desired Data Bits from the drop-down box.	anyone	COMBTZ	8	5 6 7 8	sets the LPM data bits for individual COM ports	to configure the LPM data bits on a port by port basis
Parity	From the Serial tab on the Configuration page: With the Serial Port State enabled, select the desired Parity from the drop-down box.	anyone	COMPTY	None	None Even Odd	sets the LPM parity for individual COM ports	to configure the LPM parity on a port by port basis
Stop Bits	From the Serial tab on the Configuration page: With the Serial Port State enabled, select the desired Stop Bits from the drop-down box.	anyone	COMSTP	1	1-2	sets the LPM stop bits for individual COM ports	to configure the LPM stop bits on a port by port basis

Command	How is this command executed?	Who can execute this command?	Parameter Name	Default Parameter Value	Parameter Range/Options	What does this command do?	What is the purpose of this command?
Transponder Timeout	From the Group tab on the Configuration page: Enter a time, in seconds, in the Transponder Timeout field.	anyone	GRPTTO	300	1-300	set the transponder timeout time	to set the amount of time an OBU must be out of a capture zone before communication with the OBU is reported as a new transaction
Save Config	From the Manage Config tab on the Configuration page: Click the Save Config button.	anyone	N/A	N/A	N/A	Saves a configuration file. Note: Different ways of saving the file appear, depending on the browser you use,	to allow Reader configuration file to be saved. The file can then be reloaded later or used to configure other Readers
Browse (select configuration file to upload)	From the Manage Config tab on the Configuration page: Click the Browse button.	anyone	N/A	N/A	N/A	opens the File Upload window	to select a saved configuration file to upload

Command	How is this command executed?	Who can execute this command?	Parameter Name	Default Parameter Value	Parameter Range/Options	What does this command do?	What is the purpose of this command?
Upload Config (without changing IP addresses)	From the Manage Config tab on the Configuration page: With the correct configuration file displayed in the Filename field above, click the upper Upload Config button.	anyone	N/A	N/A	N/A	uploads the selected configuration file to the Reader without overwriting the IP addresses	to upload a saved Reader configuration without changing the IP address settings
Upload Config (including the IP addresses)	From the Manage Config tab on the Configuration page: With the correct configuration file displayed in the Filename field above, click the bottom Upload Config button.	anyone	N/A	N/A	N/A	uploads the selected configuration file to the Reader including any IP addresses	to upload a saved Reader configuration
Reset Parameters to Default Values	From the Manage Config tab on the Configuration page: Click the bottom Reset Parameters to Default Values button.	anyone	N/A	N/A	N/A	restores all Reader configuration settings to the factory default values except for the IP address	to reset the Reader configuration, usually while performing specific field service tests

Command	How is this command executed?	Who can execute this command?	Parameter Name	Default Parameter Value	Parameter Range/Options	What does this command do?	What is the purpose of this command?
Browse (select Reader Firmware to upload)	From the Manage Config tab on the Configuration page: Click the Browse button.	anyone	N/A	N/A	N/A	opens the File Upload window	to select a saved configuration file to upload
Upload File	From the Software Update page: Click the Upload File button.	user with Software Management permissions	N/A	N/A	N/A	uploads a firmware version	to upload a firmware version to the Reader so it can be activated
Reboot	From the Software Update page: Click the Reboot button.	user with Software Management permissions	N/A	N/A	N/A	reboots the Reader	to remotely reboot a Reader
Activate	From the Software Update page: Click the Activate button.	user with Software Management permissions	N/A	N/A	N/A	activates the selected firmware version	to deactivate the firmware version currently running and activate a new version once the new firmware version has been uploaded to the Reader

Command	How is this command executed?	Who can execute this command?	Parameter Name	Default Parameter Value	Parameter Range/Options	What does this command do?	What is the purpose of this command?
Delete (firmware)	From the Software Update page: Click the Delete button.	user with Software Management permissions	N/A	N/A	N/A	deletes the selected firmware version	to delete an inactive, non-factory firmware version that is no longer required to free up space for newer firmware versions
Change Permissions	From the User Management tab on the User Management page: Click the Change Permissions button.	user with User Admin permissions	N/A	N/A	N/A	enables any permission changes	to add or remove permissions for a given user
Clear Password	From the User Management tab on the User Management page: Click the Clear Password button.	user with User Admin permissions	N/A	N/A	N/A	clears a user's password	to allow a user to create a new password if they have forgotten their existing password

Command	How is this command executed?	Who can execute this command?	Parameter Name	Default Parameter Value	Parameter Range/Options	What does this command do?	What is the purpose of this command?
Delete (user)	From the User Management tab on the User Management page: Click the Delete button.	user with User Admin permissions	N/A	N/A	N/A	deletes a user	to remove users who no longer require access to the CTM web interface
Create New User	From the User Management tab on the User Management page: Click the Create New User button.	user with User Admin permissions	N/A	N/A	N/A	creates a new user	to create a user account
Submit (new password)	From the Change Password tab on the User Management page: Click the Submit button.	user with User Admin permissions	N/A	N/A	N/A	submits a new password	to change the password of the user currently logged into the CTM web interface
Network Time Protocol	From the Time Management page: select Disable or Enable, then, Click the Update NTP Settings button.	user with Advanced User permissions	NTP__	Disabled	Disabled Enabled	enables or disables setting the Reader time via an NTP server	to ensure readers are time synced to a time server

Command	How is this command executed?	Who can execute this command?	Parameter Name	Default Parameter Value	Parameter Range/Options	What does this command do?	What is the purpose of this command?
NTP Server 1, 2 and 3	From the Time Management page: enter three different valid NTP server IP address in the NTP Server fields, then, Click the Update NTP Settings button.	user with Advanced User permissions	NTP__1 NTP__2 NTP__3	N/A	N/A	sets the NTP server IP addresses	to provide the Reader with three NTP servers it can access to accurately maintain time with other Readers in an IR network
Set Time	From the Time Management page: enter the date and time in the format MMDDYY<sp>HHMMSS, then, Click the Set Time button.	anyone	N/A	N/A	N/A	manually sets the Reader time	to manually set the time
Delete Event Logs	From the Log Files tab on the Log Files page: Click the Delete Event Logs button.	user with View Log Files and Manage Log Files permissions	N/A	N/A	N/A	deletes all event logs	to free up memory for more logs

Command	How is this command executed?	Who can execute this command?	Parameter Name	Default Parameter Value	Parameter Range/Options	What does this command do?	What is the purpose of this command?
Delete All Logs	From the Log Files tab on the Log Files page: Click the Delete All Logs button.	user with View Log Files and Manage Log Files permissions	N/A	N/A	N/A	deletes all logs	to free up memory for more logs
Copy Log Files to USB disk	From the USB Logging tab on the Log Files page: Click the Copy Log Files to USB disk button.	user with View Log Files and Manage Log Files permissions	N/A	N/A	N/A	copies all log files to a USB flash drive inserted in an CTM USB port	to save a copy of the Reader log files for analysis or for backup
Start Logging to USB disk	From the USB Logging tab on the Log Files page: Click the Start Logging to USB disk button.	user with View Log Files and Manage Log Files permissions	N/A	N/A	N/A	continuously copies log files as they are created and updated to a USB flash drive inserted in an CTM USB port	to automatically create a backup copy of all logs
Ethernet Logging (enable)	From the Ethernet Logging tab on the Log Files page: Select the Ethernet check box, then, click the Update Ethernet Logging Configuration button.	user with View Log Files and Manage Log Files permissions	ETHLOG	Disabled)	Disabled (Enabled	Disabled: No Ethernet logging Enabled: the Reader sends a copy of log files to a destination computer via the ETHERNET 1 port	can remotely access log files Use this option only under the recommendation of Kapsch Service.

Command	How is this command executed?	Who can execute this command?	Parameter Name	Default Parameter Value	Parameter Range/Options	What does this command do?	What is the purpose of this command?
Destination IP/Port	From the Ethernet Logging tab on the Log Files page: Enter the IP address and port number of the computer to receive log files, then, click the Update Ethernet Logging Configuration button.	user with View Log Files and Manage Log Files permissions	ELDTIP	0.0.0.0	N/A	provides the IP address and port of the computer to receive log files	to allow the Reader to know the IP address of a remote computer so log files can be sent
Ethernet Protocol	From the Ethernet Logging tab on the Log Files page: Select either TCP or UDP, then, click the Update Ethernet Logging Configuration button.	user with View Log Files and Manage Log Files permissions	ELPROT	TCP	TCP UDP	TCP: use TCP protocol for sending log files via Ethernet UDP: use UDP protocol for sending log files via Ethernet	to choose an Ethernet protocol that focuses on speed (UDP) or quality of data (TCP)

Command	How is this command executed?	Who can execute this command?	Parameter Name	Default Parameter Value	Parameter Range/Options	What does this command do?	What is the purpose of this command?
Select Logs	From the Ethernet Logging tab on the Log Files page: Select the check boxes of the log files to be sent, then, click the Update Ethernet Logging Configuration button.	user with View Log Files and Manage Log Files permissions	ELLOGS	trouble	trouble tag event developer debug fifo	sets which log files are sent via Ethernet	to select only the log files you want to receive
Perform Tests (serial comms)	From the Diagnostics Page : Select the LPM COM port to be tested from the Test Enable/Disable drop-down box, then, click the Perform Test(s) button.	user with Advanced User permissions	N/A	N/A	N/A	tests the specified LPM serial port	to ensure that a specified LPM port is functioning properly when troubleshooting communication problems with the LC
Custom sync timing	N/A	N/A	CHCSTE	0	min: 0 max: 1	Enables/disables custom sync timing	N/A
Sync Frame Timeout [us]	N/A	N/A	CHSFTO	338	min: 0 max: 65535	Specifies how long the Reader waits for the sync pulse during the normal sync process.	N/A

Command	How is this command executed?	Who can execute this command?	Parameter Name	Default Parameter Value	Parameter Range/Options	What does this command do?	What is the purpose of this command?
Sync Recovery Timeout [ms]	N/A	N/A	CHSRTO	120	min: 0 max: 65535	Specifies how long the Reader waits for the sync pulse during the sync recovery process.	Specifies how long the Reader waits.
Sync Frame Start Delay [us]	N/A	N/A	CHSFSD			Specifies the time delay from the rising edge of the sync pulse to the falling edge of the IAG trigger pulse in the frame.	Specifies the time delay

MAINTENANCE INSTRUCTIONS

This Page Intentionally Left Blank

4. THEORY OF OPERATIONS

This section offers a more detailed overview of the Reader components than the introductory overview provided in Overview Section 2 page 27.

Multi-protocol Readers can communicate with both active and passive OBUs. The Reader uses a combination of Time Division Multiplexed (TDM) and Frequency Division Multiplexed (FDM) periods to read active and passive OBUs respectively.

Each MRFM-S and antenna pair create a RF coverage zone on the roadway. The antennas are situated to create overlapping coverage zones between channels. For high speed lanes, one reader can support 5 channels. When required, multiple readers can be synced together to support additional channels.

The reader processes the OBU information and provides transaction reports to the Lane Controller interfaces. When required, the reader can write data to the OBU.

Active OBUs

Active OBUs are battery powered and transmit a signal to the Reader antennas. As a vehicle equipped with an active OBU approaches a toll plaza, the OBU receives a trigger signal from the Tx antenna. The OBU then starts transmitting data, which is received by the Rx antenna.

The MRFM-S decode the active OBU signal and passes the data to the CTM, which processes and logs the OBU data and then sends the information to the Lane Controllers (LCs). The Reader may also send data back to the active OBUs, such as an updated toll account balance.

Passive OBUs

Passive tags are not battery powered and cannot transmit a signal. As a vehicle equipped with a passive OBU approaches the antenna, the OBU receives a transmit signal from the antenna. This signal is then reflected from the passive OBU back to the antenna. The reflected signal is uniquely modulated by each passive OBU, allowing the OBU to be identified.

The MRFM-S decodes the passive OBU signal and passes the data to the CTM which processes and logs the OBU data and then sends the information to the Lane Controllers (LCs). The Reader may also send data back to the active OBUs, such as an updated toll account balance..

Capture zones

The capture zone is the area of antenna RF coverage. An antenna can communicate with an OBU once the OBU enters the antenna's capture zone. These capture zones and the number of antennas required per lane varies depending on the lane configuration.

Note: Installation on these type of lanes is assessed by Kapsch Personnel prior to deployment in order to validate customer expectations and performance.

Superframes

The available RF Air time is divided into frames. A series of frames is assembled into a superframe which can be used to sync multiple readers together. In some configurations, a series of superframes is assembled into a megafame which is used to sync multiple readers together. A frame can be either a TDM or FDM period. A superframe can be a collection of TDM and/or FDM frames.

Multi-protocol RF Module Smart

The Multi-protocol RF Module Smart (MRFM-S) can handle multiple passive tag protocols; 6B (ISO 18000-6 Type B), 6C (ISO 18000-6 Type C), ATA (10374/ATA/AAR S-918) SeGo and Allegro, as well as the active protocol IAG.

The MRFM-S design includes a software command for adjusting the transmitter peak output power.

When installing or replacing an MRFM-S, the lane must be retuned.

The MRFM-S transmits a message to the CGC. After the message is processed by the CTM, a message is sent to the LC.

The signals between the MRFM-S and the DSM are shown in Table 4-1.

Table 4-1: MRFM-S signals to and from DSM

Signal	Description
data input from DSM	Tx DA \pm signals, RS422 bi-polar AM envelope modulation signals
data output to DSM	Rx DA \pm signals, RS422 bi-polar AM envelope demodulation signals
RF control	Rx EN \pm and Tx EN \pm , RS422 bi-polar transceiver enable signals
RF control	A0 \pm and A1 \pm , RS422 bi-polar data address enable signals
power input from DSM	+5VDC (Vcc), +15VDC

The serial communication settings for the LC COM port are configurable through the web interface.

Power Supply Module (PSM)

The PSM AC mains power requirement is 95-135VAC (60Hz \pm 2 Hz) at 10A max input current.

The PSM is field replaceable and provides:

- A power switch and a 10A fuse

- +5V and +15V DC power outputs
- +5V and +15V LEDs to indicate power supply output status

In the redundant configuration, both the primary and secondary PSMs are normally powered on. The primary PSM provides power to the primary CTM and the secondary PSM provides power to the secondary CTM. Both PSMs share the RF module load.

In the event of failure of one PSM, an automatic switchover will occur and the redundant PSM provides all the power for the RF module load.

The PSMs are not interchangeable. The Primary and Secondary power supplies have different part numbers; a result of being physical mirror images of each other.

Each PSM has a mains power fuse on the front panel: Time lag, 10 A @ 250 V, UL rated.

The power supply distribution is shown in Figure 4-1, page 156.

Figure 4-1: Reader Power distribution

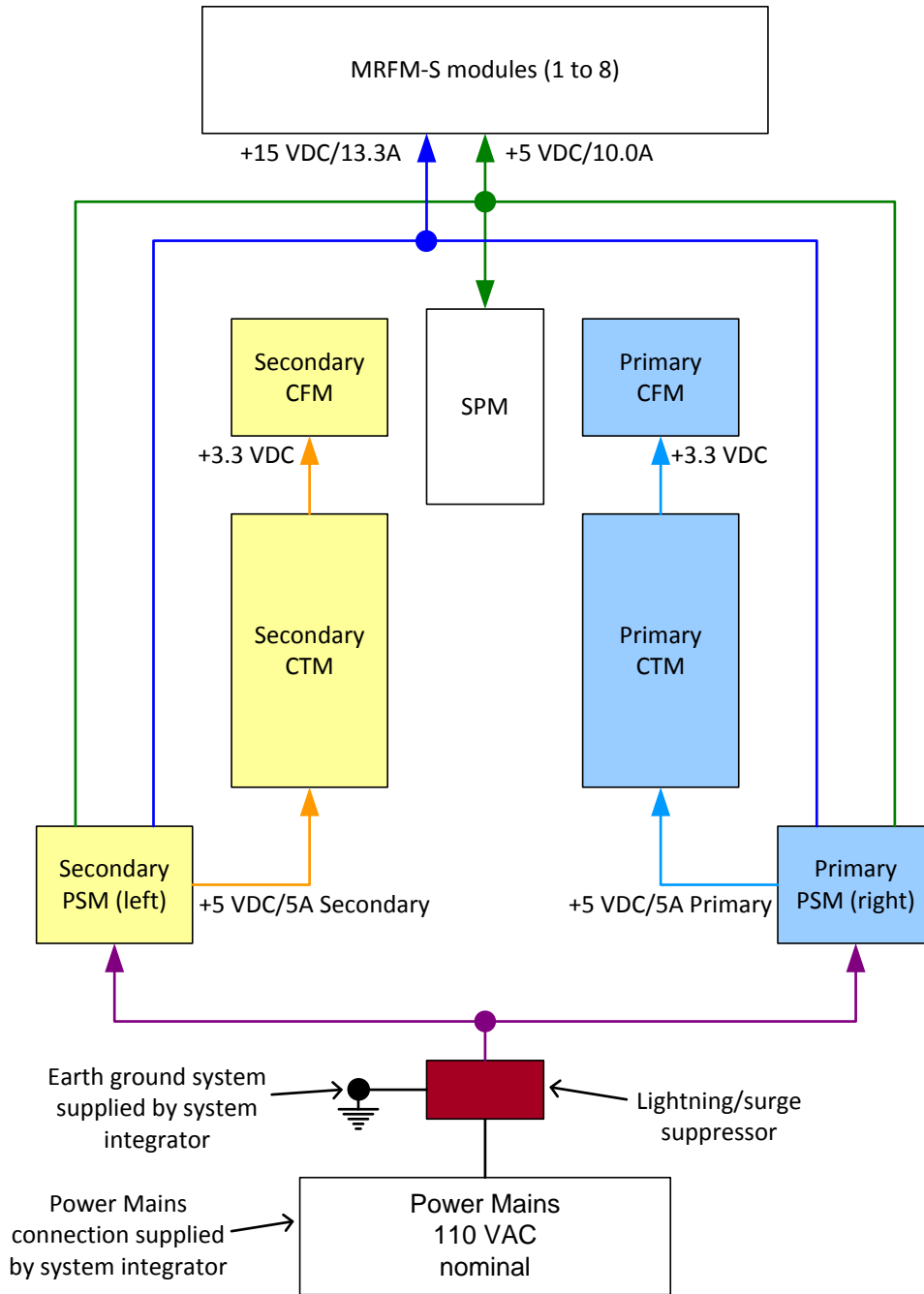

Note: Surge suppressor supplied by system integrator.

Lane Controller Port Module (LPM)

The LPM provides the serial communications connections between the CTM and the LC. The LC serial communication signals travel to/from the CTM CGC board via the Distribution Module (DSM) to the LPM serial port connectors. The LPM provides the 8 serial port connectors and integrated lighting protection. The LPM is field replaceable.

The JANUS® Multi-Protocol Reader Ver. 2 is factory configured to support either an RS-232 or RS-422 interface. The data rate is configurable to standard rates up to 115.2 kbps.

Normally, each MRFM-S channel is assigned a unique LPM COM port; however, the MRFM-S channels can be multiplexed by assigning multiple RF channels to one LC serial port, as necessary.

For a description of the serial interface protocol and file formats exchanged between a Lane Controller and a Reader, refer to ICD 360450-111.

Sync Port Module (SPM)

The SPM provides a pathway for synchronization signals to and from both primary and secondary CTM MC boards via the DSM to the SPM 6-terminal block connector where the synchronization STAR network cables connect. The SPM is field replaceable.

A 4-Wire RS422 electrical connection at the front panel terminal block connects the SPM to the synchronization network.

There are no active components installed on the SPM.

A three-position toggle switch mounted on the SPM provides Auto, Primary and Secondary redundancy mode control signals via the DSM to the CTM.

Controller Module (CTM)

The CTM performs the Reader's digital signal processing for OBUs. The CTMs may be swapped without having to save the configuration file since the configuration data is stored in the CFMs mounted on the DSM.

The CTM as a whole unit is field replaceable.

Main Controller (MC)

The MC is an off-the-shelf EBX form-factor industrial single-board computer. This unit contains the CPU, memory and I/Os and is used to run the Reader software.

The MC receives OBU information from its associated CGC and performs a lane assignment for each tag passing through the system via voting logic. It communicates with the LCs to report tag transactions, accepts configuration messages, and provides status messages via a legacy LC serial interface and/or an LC Ethernet interface. It detects and reports faults and can perform a switchover. It offers Reader configuration via a browser interface, storage for transaction buffering, event logging, and tag transaction and performance monitoring. It also supports remote software downloads. It provides Inter-Reader communications with up to two other Readers, saves Reader configuration

parameters to the primary and secondary CFM, manages the OBU Account Status file, and keeps log files for OBU transactions, system events, and trouble reports.

For a description of the ethernet interface protocol and file formats exchanged between a Lane Controller and a Reader, refer to ICD 360450-112.

Channel Group Controller Module (CGC)

The CGC is used as a scheduler and a controller. It schedules when the MRFM-S operates and routes the data from the MRFM-S to the MC.

Configuration Module (CFM)

The CFM is a field replaceable PWA board. These non-volatile memory cards store the Reader configuration file. They are field-replaceable without using any tools.

Distribution Module (DSM)

The DSM back plane provides interconnections between the plug-in modules in the Reader rack. It is not field-replaceable.

The DSM is responsible for the following.

- Provides locations for all plug-in Reader modules and the Lane Kit RF modules
- Distributes DC power from the PSMs to the necessary modules in the Reader rack
- Carries RF data and control signals between primary and secondary CTMs and all MRFM-Ss
- Carries synchronization and redundancy mode signals between primary and secondary CTMs and the SPM
- Carries data between primary and secondary CTMs and primary and secondary CFMs
- Carries data between primary and secondary CTMs and primary and secondary LPMs

Synchronization

	CAUTION: On one redundant reader of a synchronization network, the synchronization connection should be looped back and this reader will declare sync even if it is disconnected from the other readers.
---	--

Readers must be synchronized if they have overlapping capture zones, are connected in an IR network, or if Reader-to-Reader RF interference is present.

If unsynchronized Readers are located within a 200 meter (660 feet) radius, tests for in-band RF interference should be carried out to ensure that no Reader-to-Reader interference occurs. This test should be carried out under live traffic conditions to ensure that RF signal reflections off moving vehicles do not exceed the in-band limits. If Reader-to-Reader RF interference exceeds the in-band limits then the Readers must be synchronized.

How Reader synchronization operates at the toll location

After interrogating all of the assigned MRFM-S slots in the rack, each Reader will provide a 'sync ready' signal on its SPM terminal block. Only when the configuration parameter Enable Reader Sync is set ON for all Readers in the sync network does synchronization occur.

As busy Readers become ready they will not send any more RF trigger signals until the sync bus indicates that all Readers are ready. Once the last Reader in the network generates its ready signal, all Readers on the sync bus simultaneously generate OBU trigger pulses starting with the RF module in slot 1. This can be seen in the truth table shown below for synchronization circuit consisting of two Readers.

Table 4-2: Boolean Logic Truth Table for Synchronization of two Readers

Reader 1 sync port Tx	Reader 2 sync port Tx	Reader 1 or 2 sync port Rx
0 (<i>ready</i>)	0 (<i>ready</i>)	0 (<i>ready</i>)
0 (<i>ready</i>)	1 (<i>busy</i>)	1 (<i>busy</i>)
1 (<i>busy</i>)	0 (<i>ready</i>)	1 (<i>busy</i>)
1 (<i>busy</i>)	1 (<i>busy</i>)	1 (<i>busy</i>)

The truth table above demonstrates the following rule of synchronization operation:

The sync bus will only be in the ready state when all Readers in the group are in the ready state.

The last Reader to acquire a ready state controls the system synchronization. Most of the time (greater than 95%), the sync bus will be in the busy state. If operating correctly, the sync bus will normally be in the ready state for about 100 µSec.

The Sync Recovery Process

When a Reader detects it is out of synchronization, it attempts to re-establish synchronization at the beginning of every superframe. During this time, the CTM SYNC LED flashes green/orange (the orange is a mix of green and red due to the short amount of time in red).

Note: Connection of other equipment or external synchronization devices is not supported and may cause Reader errors.

Log files

The log files for OBU transactions are saved on the CFM. Once space is filled on the respective memory partition, the oldest file from the same file type is deleted to create memory space for the new data.

A listing of the main log file types appears below. Other log files that may be present are for Kapsch TrafficCom use only.

Table 4-3: List of Available Log Files

Log File Type	Description
tagtxns_YYYY-MM-DD	Daily tag Transaction log.
eventlog_YYYY-MM-DD	Daily event log files. Event log contain a periodic report of system health and transaction count totals.
trouble_YYYY-MM-DD	Trouble Log. Content lists any unusual system anomaly (e.g. switchover).

Transaction logs

	<p>CAUTION:</p> <p>Log file formats are not under ICD control and the format may change without prior notification. Log files are for diagnostic purposes only and are not guaranteed to be maintained in non-volatile storage.</p>
---	--

Each transaction generates a two-line report containing the fields described in the table below.

Table 4-4: List of Fields in a Transaction Log Report

Field	Description
IREAD	Optional initial read report when transponder first enters capture zone. Informational report
VOTE	Transaction report at voting time
POST	Optional post-capture zone report if lane assignment or programming status has changed. Informational report

Field	Description
An	Antenna number (present only if in interpolated lane assignment mode)
Master Set	The set of three (3) inter-Reader channels that have the most tag reads (C = center Reader, L = left Reader, R = right Reader). Present only if in interpolated lane assignment mode or when IR network is enabled.
Zone	Sub-zone information (a – f). (Present only if in interpolated lane assignment mode)
Ch	Channel number. Indicates the assigned channel (1-8). Channel 1 corresponds to the leftmost RF module in the RF rack.
St	Transaction status. Pgm indicates successful transponder programming. PU indicates transponder programming status is Unknown (tag left zone before verify could complete). PF indicates transponder was not programmed successfully. Read indicates the Reader is in read only mode. CrossR indicates an informational report (not a transaction).
Txn	Transaction number. Note that transaction numbers may appear to skip when using 2 or more Readers with Ethernet connection between them.
Ag	Agency ID of transponder in capture zone.
Sn	Serial number of transponder in capture zone.
Ahs	Number of handshakes up to voting time.
THs	Total Handshakes for previous transaction assigned to this channel.
GUARD	Shown for a transaction assigned to a RF channel set to Guard. These transactions will show ILC to indicate that no report for the LC is generated. Tag programming is disabled for Guard channels.
?LA	In a POST report, indicates that a lane assignment change was detected between the voting time report and the post time report. May be an indication that voting time is not optimal.
?PS	In a POST report, indicates that a programming status change was detected between the voting time report and the post time report.
>LC	>LC indicates transaction is to be reported to lane controller (connection present or not). Only appears on the Active CTM
!LC	!LC indicates transaction is suppressed (e.g. GUARD lane or CrossR transactions or CTM is Inactive).
Cx-HS	HS tag handshakes seen up to voting/post time on the MasterSet center Reader.
Lx-HS	HS tag handshakes seen up to voting/post time on the MasterSet left Reader.
Rx-HS	HS tag handshakes seen up to voting/post time on the MasterSet right Reader.

Transaction Buffering

Transactions from OBUs, are processed by the CTM. When a Reader CTM loses communications with an Lane Controller (LC), the Reader buffers OBU transactions and error messages (up to a combined total of 400,000) in non-volatile memory (i.e. buffered messages will not be lost during power interruptions or Reader resets). When the memory is full, new transactions overwrite the oldest buffered transactions. The memory available for buffering is shared by all RF channels.

When the communication link between an LC and the Reader is re-established, the Reader begins to upload the buffered transactions to the LC. The Reader will pause uploading buffered transactions to the LC to report any new transactions as they occur. Buffered transaction reporting resumes after the new transactions have been reported. Messages from the LC will continue to be acknowledged and acted upon during the upload process.

Event Logs

The event log is generated to record any reader events or changes (for example, if the power supply status changes). During service, the technician should first examine the event log files to see if there are any reported events with the reader.

The following list depicts the possible sources of event messages found in the event log.

- Changes to the reader configuration
- Changes to the reader configuration at power up
- Reader status changes, such as PSM status, etc.
- Reader faults detected

Trouble Logs

Unusual Reader issues generate trouble logs (for example, if a switchover has occurred). During service, the technician should first examine these trouble log files to see if there are any reported issues with the Reader.

Examine the Log Files page for instances of one or more trouble <date> file in the list of log files.

A typical report in a trouble log is:

```
2010-05-31T10:52:35.723+00:00 [lab3_5] SYNCR: Reader SYNC lost
```

Note: As an alternative, Kapsch Service can remotely connect to the Reader and examine the trouble log to quickly identify and resolve any issues. It is up to the system administrator or integrator to determine when to grant Kapsch Service remote access to the LC network IP addresses.

The following list depicts the possible sources of trouble messages found in the trouble <date> file.

- No detection of a CFM backplane memory module.
- The Status file integrity check fails. Possible cause: there may be data for up to 40 million OBUs in a Status file.
- The Reader software forced a switchover on detection of:
 - Failed CGC health
 - Failed serial LC link (when enabled). Possible cause: a fault external to the Reader
 - Failed Ethernet LC link (when enabled). Possible cause: a fault external to the Reader
 - Failed Ethernet inter-Reader link (when enabled). Possible cause: a fault external to the Reader

5. INSTALLATION

Introduction

The Reader is shipped with the required power, communications, and logic modules. The Lane Kits, separate from the Reader, each consist of an antenna, an MRFM-S, a feedline cable adapter and a circulator. After the equipment is installed, the Reader must be configured via the browser interface. After configuration is complete, the Reader configuration should be saved (see Saving the Reader configuration, page 246) for future reference.

The toll agency and/or system integrator must select the configuration and setup that is suitable for the application and the desired system performance.

CAUTION:



Improper modification of configuration parameters may adversely affect system operation. The default values may not be appropriate for the specific application. It is the system integrator's responsibility to tailor the configuration parameters to the specific operating environment.

CAUTION: Redundant Reader



Configure both CTMs in a redundant Reader. Each CTM has its own browser interface and is configured independently. Ensure any configuration changes made to one CTM are applied to the other CTM, as required.

The earth ground system

WARNING:



AN IMPROPERLY GROUNDED READER COULD RESULT IN ELECTRIC SHOCK. ENSURE A HIGH CURRENT EARTH GROUND CONNECTION IS ESTABLISHED BEFORE CONNECTING SUPPLY POWER.

The system integrator supplies the earth ground system for the Reader mains power as per the IEEE 142-2007 standard, particularly; *chapter 5: Sensitive Electronic Equipment Grounding*; and *chapter 3* pertaining to lightning protection; and all other chapter sections describing bonding applications.

The system integrator is responsible for ensuring the grounding and power conforms to local regulatory and safety requirements. The recommendations herein are those to ensure bad grounding does not degrade the reader performance.

In accordance with IEEE 142-2007 all of the following building/site elements (if available) must be bonded together:

- metal frame of the building (if effectively grounded)
- metal underground water pipe
- ground ring, concrete encased electrode

The Reader ground bar (supplied by the system integrator) is bonded to the above-mentioned elements. If none of these elements are available on site, only then a grounding electrode is installed as per NEC to which the Reader ground bar is bonded. The Reader components ground wires are then connected to the ground bar clamps as shown in Figure 5-1.

Lightning arrestors should be installed on the interfaces where lightning induced surges can occur.

Figure 5-1: Earth Ground System (with recommended lightning protectors shown)

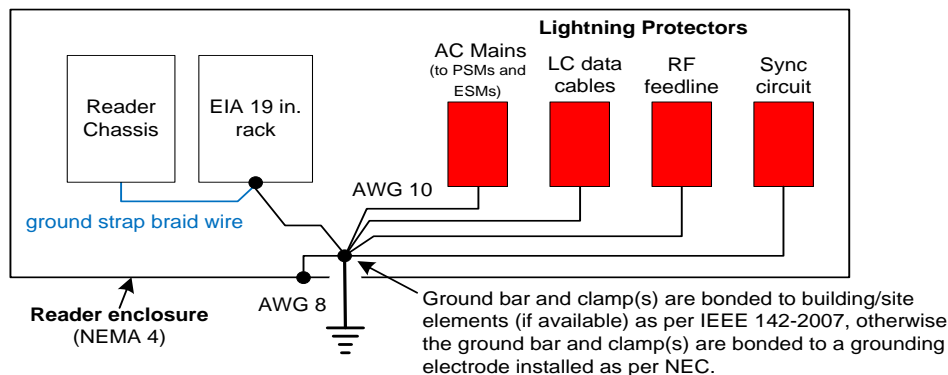

Note: The toll plaza installation may not have a NEMA 4 enclosure. The earth ground system and all other ground connections to Reader components at the toll plaza are identical to those shown in the figure below.

Lightning protectors

Note: It is the system integrator's responsibility to determine the necessity of installing lightning/surge protection equipment between the data inputs and the earth ground system at the Lane Controller (LC).

Table 5-1: Locations for the Installation of Lightning Protectors

Location required	Schematic Figure number
In-line with antenna RF feed	Figure 5-1: Earth Ground System (with recommended lightning protectors shown), page 165
PSM power	Figure 5-2: AC Mains, page 167
LC Data inputs	Figure 5-3: LC Data Cable Installation, page 168
ESM power	Figure 5-10: Schematic of a three-Reader IR network, page 184
Synchronization circuit	Figure 5-9: Synchronization circuit schematic for three Readers, page 179

Installing the Reader hardware

Prerequisites: The Reader cabinet is commissioned and the earth ground system has been installed as per IEEE 142-2007 (see The earth ground system on page 164).

Install the AC receptacle for the Reader mains power connections within three (3) feet of the front of the Reader.

Note: When handling Reader modules and hardware, always follow accepted Electrostatic Discharge (ESD) practices and standards.

1. Using clip nuts, mount the Reader in the EIA 19-inch rack in a NEMA 4 cabinet.
2. Connect the EIA 19-inch rack ground lug to earth ground:
3. Connect one end of a braided ground strap to the ground lug on the EIA 19-inch rack.
4. Neatly position the ground strap along the Reader and apply a light film of tuner lube to the ground lug on the rear of the Reader rack to ensure good grounding contact.
5. Secure the other end of the braided ground strap to the Reader ground lug.



CAUTION:

To avoid damaging the modules, ensure that alignment of both the connector on the module and the connector on the DSM (back plane) is correct before securely plugging the module into the DSM.

6. Install the Reader modules in the Reader, ensuring the modules seat properly in their sockets. The installation of the MRFM-S is outlined in Installing a Lane Kit on page 169.
7. Install the power cords for the primary and secondary PSMs. Appropriate lightning/surge protection equipment should be installed between the power mains input and the earth ground system at the Reader (see Figure 5-2 on page 167).

Figure 5-2: AC Mains

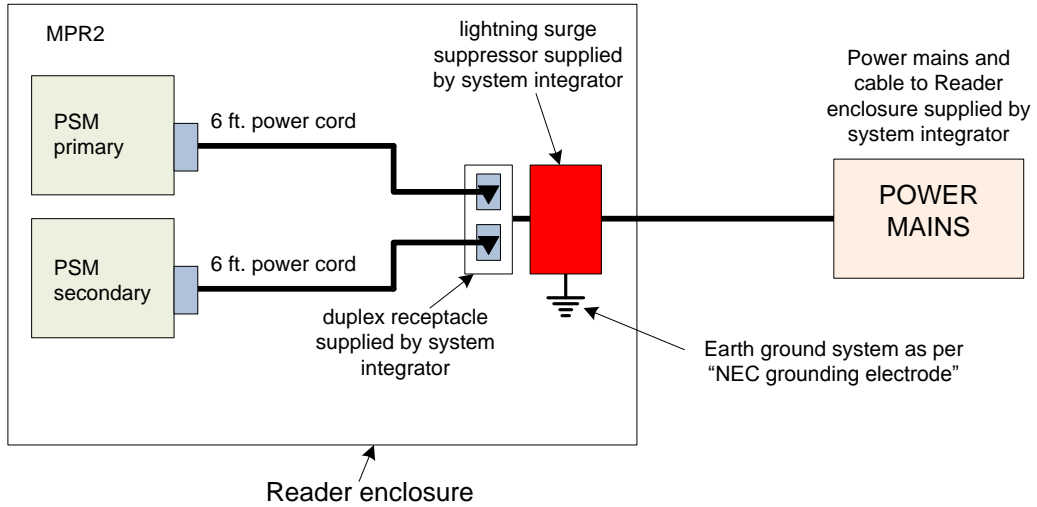

Connect the appropriate cables from the Reader to the LC as shown in Figure 5-3 on page 168.

LC data cable installation – ETHERNET 1 port, patch cable to solid conductor

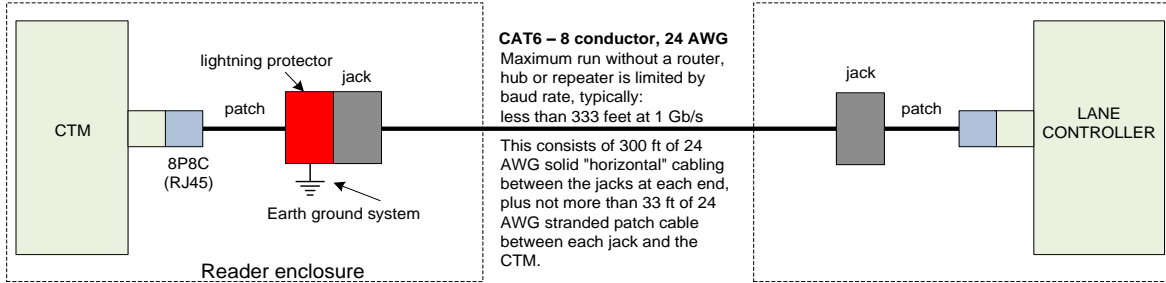

LC data cable installation – ETHERNET 1 port, patch cable to fiber optic

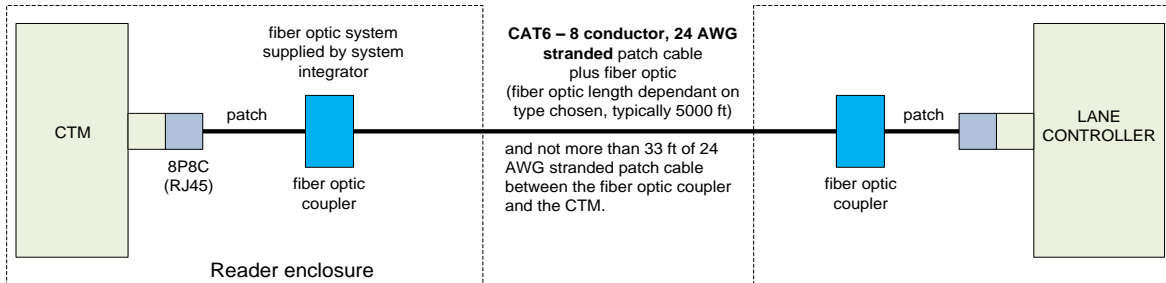

LC data cable installation from LPM – RS422

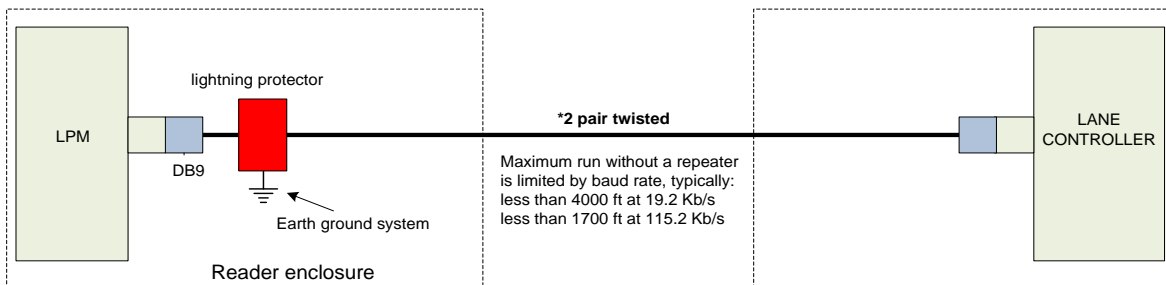

LC data cable installation from LPM – RS232C

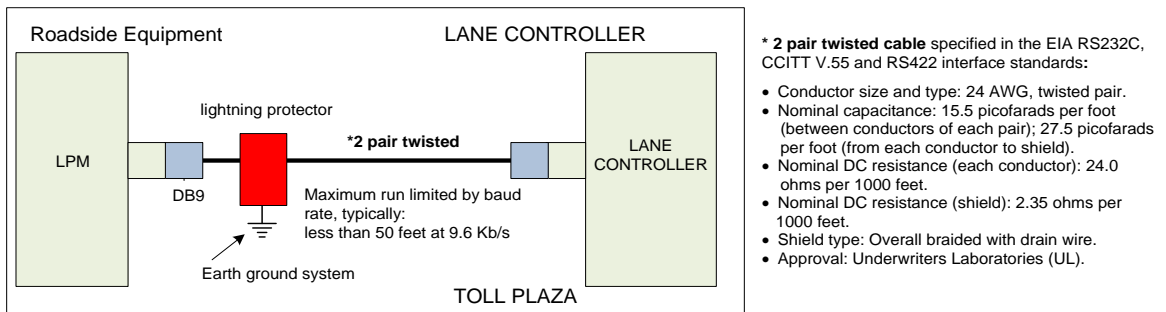

Figure 5-3: LC Data Cable Installation

Installing a Lane Kit

Installing an Antenna

1. The antenna mounts on a frame using 2-inch diameter galvanized pipe clamps. Position the center antenna at lane center of the defined lane. For wide ORT applications, the straddle antenna must be at the midpoint between the left and right antennas. Note straddle min/max measurements in Table 5-2.
2. Orient the weep holes down, such that the radome is facing oncoming traffic.
3. Using a tilt meter, measure the road pitch and cross lane slope directly under each IAG antenna. Record the results.
4. Using a tilt meter, align each antenna plate to the tilt angle specified in Table 5-2, in relation to the road pitch measured in step 3 (e.g., If the road pitch is 2 degrees, and the antenna tilt must be 15 degrees, mount the antenna at 17 degrees.)
5. Ensure that the height of the antenna's lower edge as tilted falls within the height range given Table 5-2. Please contact Kapsch Technical Service when considering mounting the antennas outside the specified heights.
6. Adjust the roll angle of the antenna equal to 0 degrees with respect to the cross lane slope obtained in step 3.
7. For TDM only protocol, the antenna installation may be all antennas (IAG 1 or IAG 2 or IAG 3) inline across the roadway as shown in Figure 5-3
8. For TDM protocol, and/or ISO18000-6C protocol (read only) only, the antenna installation may be all antennas IAG 3 only) inline across the roadway as shown in Figure 5-3.
9. For all passive protocols (other than ISO18000-6C read only) the antenna installation must be all antennas (IAG 3 only) staggered across the roadway as shown in Figure 5-3.

Table 5-2: Antenna mounting for the IAG 3 antenna and lane configuration

Antenna	Application	Lane Width	Height	Tilt (off horizontal)	Straddle (min/max c to c)
IAG-3	ORT or Plaza	12 ft.	17 ft. ±1 ft.	10 deg.	5.5 ft./6.5ft.
IAG-1	ORT or Plaza	12 ft.	16 ft. ±1 ft.	10 deg.	5.5 ft./6.5ft.

Figure 5-4: Inline Antenna Installation

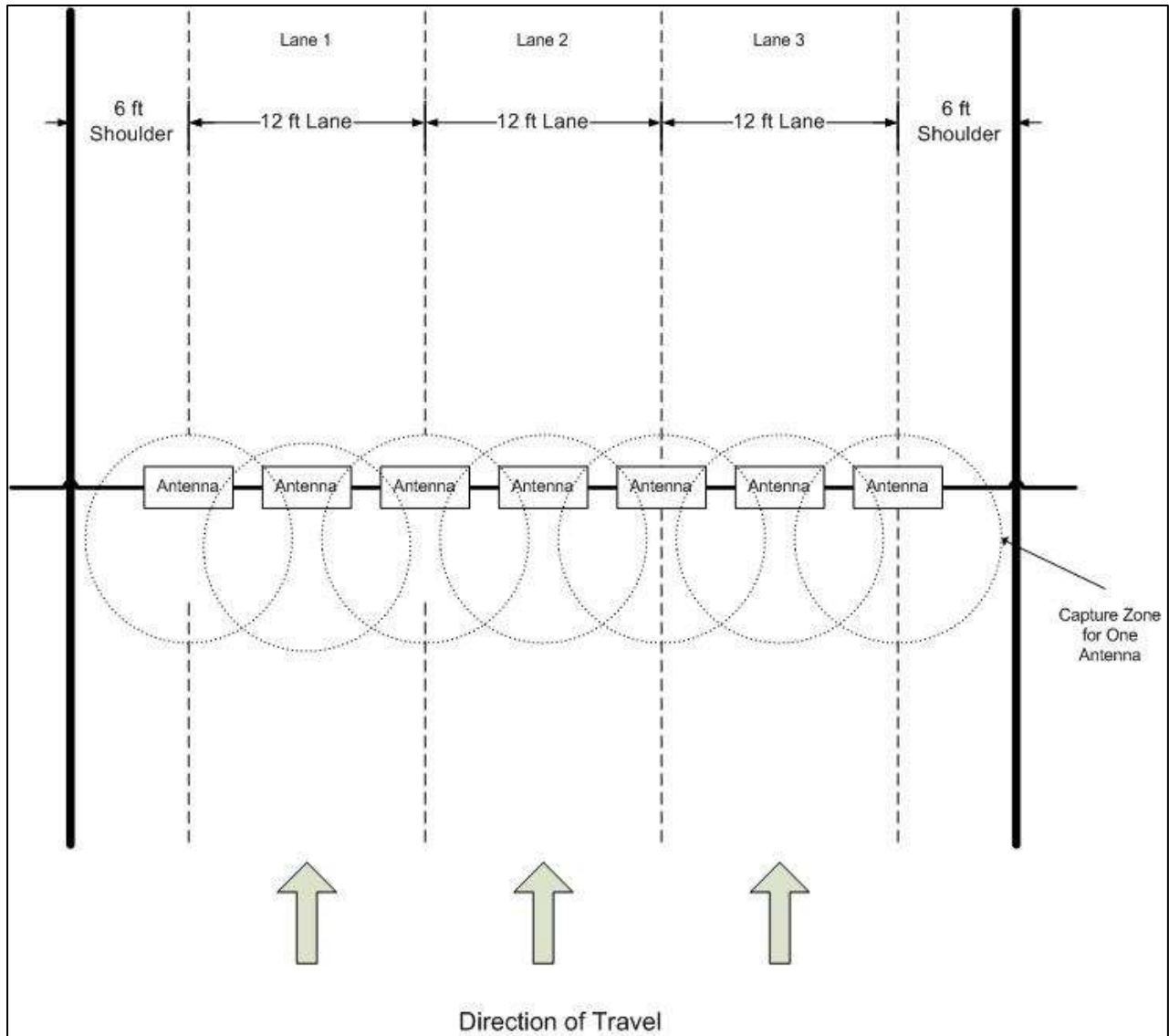
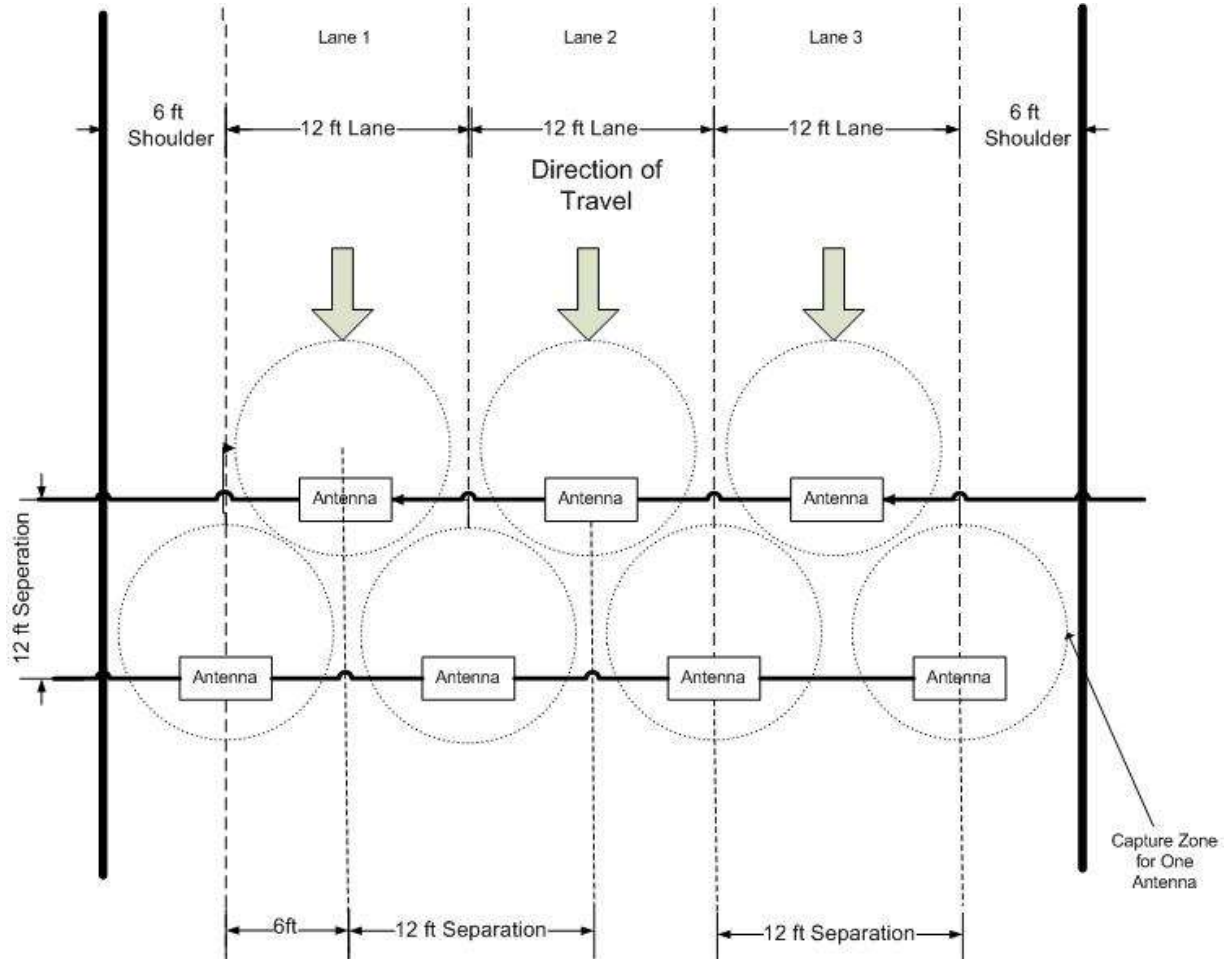

Figure 5-5: Staggered Antenna Installation



The JANUS reader system and antennas in the lane kits are optimized for applications using 12 foot lane widths. The antenna placement requirements and support for this and other lane widths are as follows.

- The lane centerline is the mid-point between the lane markings.
- The antenna boresite should be on the lane centerline and lane markings.
- Physical lane widths below 12 ft are not an issue provided the separation between lane centers is 12 ft or greater.
 - If separations are below this there is a higher risk of reports from multiple lanes for the same tag. Note the use of the voting algorithms will correctly assign the tag to the

correct lane). There may also be some reduction in the read performance for passive protocols.

- If the physical lane width exceeds 15 ft, the lane should be treated as a multi-lane free flow configuration and multiple lane kits used per lane.

Where multiple readers are on a site, the following additional guidelines apply:

- The readers must be synchronized and running the same configuration.
- The same FDM channel frequency should not be used on adjacent lanes (including straddle and shoulder).
- The same active channel from two (2) synchronized readers should not be used on adjacent lanes (including straddle and shoulder).

Installing the MRFM-S Modules

**CAUTION:**

To avoid damaging the modules, ensure that alignment of both the connector on the module and the connector on the DSM (back plane) is correct before securely plugging the module into the DSM.

1. Insert the required number of MRFM-S Modules into the Reader and secure in place.
2. Label the front panel of each MRFM-S Module with the corresponding lane number and antenna type.

Installing the RF cables

**CAUTION:**

Excessive bending or kinking can damage the RF feedline cables. Do not excessively bend or kink the RF feedline cables while fishing them through the rigid conduit from the antenna to the Reader enclosure.

1. Place the RF feedline cable(s) in position. Use an appropriate cable type (coaxial or Heliac) to ensure the RF feedline cable does not produce a signal loss greater than permitted, see section 8 RF Cable Specification. Use flexible cable (LMR400 preferred) for the short feedline cable between the circulator and the antenna
2. Using tie wraps, create a service loop of 6 feet at both ends of the RF feedline cable(s). Trim the excess cable length.
3. Install spiral wraps on the RF feedline cable(s) where necessary to protect it from abrasion.
4. Using marker tie wraps and label sets, label the Reader end of each RF feedline (ex. TX Lane 1 or RX Lane 1), each antenna RF feedline (ex. Tx lane 1 or Rx lane 1).
5. Attach the N-Type male connector to the antenna end of the RF feedline cable(s). Firmly crimp the male connector.

For Bi-Static Operation

See Figure 5-6: RF Cable Installation Schematic Bi-Static Operation

1. Using a 10in-lb torque wrench, connect the first RF feedline cable to the Circulator (Port 1). Using self-amalgamating tape, wrap the connection to ensure water cannot enter.
2. Using a 10in-lb torque wrench, connect the second RF feedline cable to the Circulator (Port 3). Using self-amalgamating tape, wrap the connection to ensure water cannot enter.
3. Using a 10in-lb torque wrench, connect a third (3.0 foot long) RF feedline cable to the Circulator (Port 2). Using self-amalgamating tape, wrap the connection to ensure water cannot enter.
4. Attach the N-Type male connector to the antenna end of the third (3.0 foot long) RF feedline cable. Firmly crimp the male connector.
5. Using a 10in-lb torque wrench, connect the other end of the third (3.0 foot long) RF feedline cable that is connected to Port 2 of the Circulator, to the antenna. Using self-amalgamating tape, wrap the connection to ensure water cannot enter.
6. Attach the N-Type female connector to the reader end of the first RF feedline cable. Firmly crimp the female connector.
7. Using a 10in-lb torque wrench, connect the other end of the first RF Feedline cable that is connected to Port 1 of the Circulator, to the RF Adaptor Cable (800125-001), that will be connected to the "Antenna" Port of the MRFMS.
8. Attach the N-Type female connector) to the reader end of the second RF feedline cable. Firmly crimp the female connector.
9. Using a 10in-lb torque wrench, connect the other end of the second RF Feedline cable that is connected to Port 3 of the Circulator, to the RF Adaptor Cable (800125-001), that will be connected to the "RX" Port of the MRFMS.
10. Using an SMA wrench, connect each RF Adapter Cable(s) (800125-001) SMA connector to the assigned MRFM-S module port(s).
11. Tie all RF Adapter cables neatly and label both ends of each adapter cable, using marker tie wraps.
12. Secure the service loop portion of the feedline to the antenna-mounting bracket using the tie wraps. Do not severely bend or kink the RF feedline cable.

Note: For a TDM and/or 6C only protocol configuration (i.e., no other passive protocols), the Circulator can be located in the cabinet with the reader and one RF feedline cable is connected between port 2 of the Circulator and the antenna. Ports 1 and 3 of the circulator are then connected to the RF modules using the RF Adaptor Cables (800125-001); see Figure 5-8: RF Cable Installation Schematic Bi-Static TDM/6C Only Operation

Figure 5-6: RF Cable Installation Schematic Bi-Static Operation

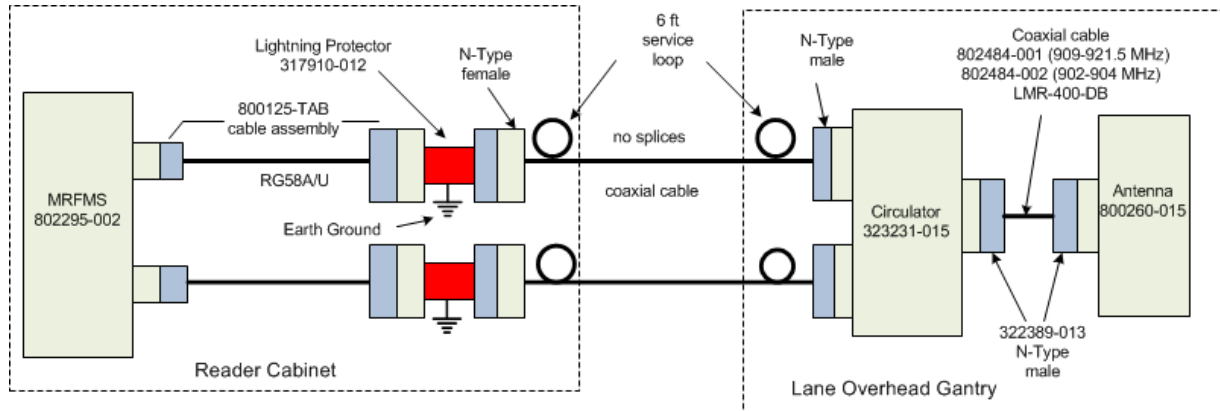

Use of the RF amplifier

The maximum cable loss and associated maximum cable length, as defined in the RF Cable Specifications on page 265, is based on the output power of the MRFM-S module and the sensitivity of the transponders. When the site specific application exceeds the limits defined on page 265, an amplifier assembly can be used to effectively increase the output power of the MRFM-S module an additional 6dB. This 6dB is then used to increase the maximum cable loss permitted as defined on Page 265.

Use of this amplifier should be reviewed with Kapsch personnel before implementation. Figure 5-7 shows a typical installation that includes the use of the power amplifiers.

Figure 5-7: RF Cable Installation Schematic Bi-Static Operation with RF Amplifier

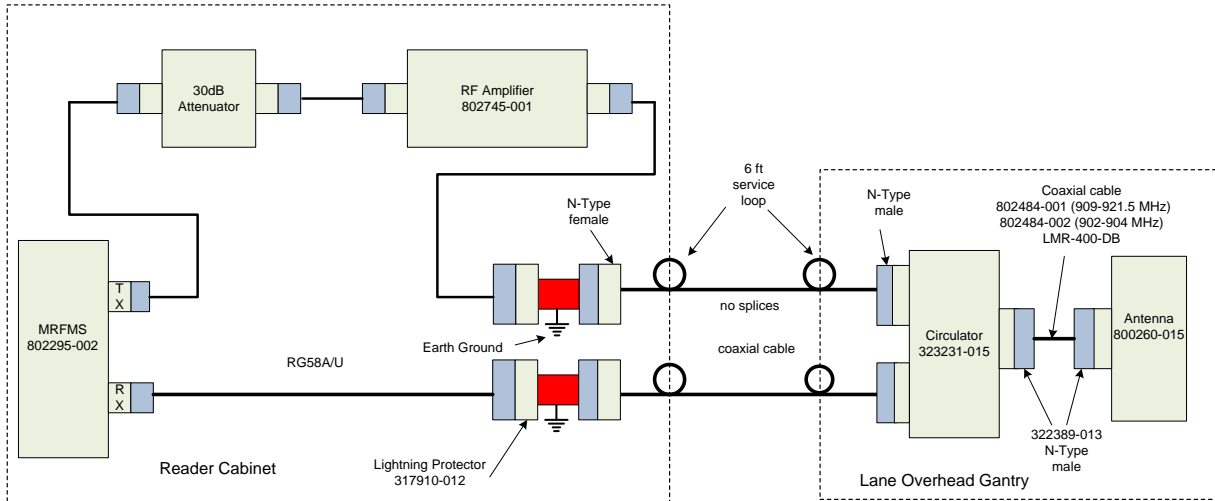
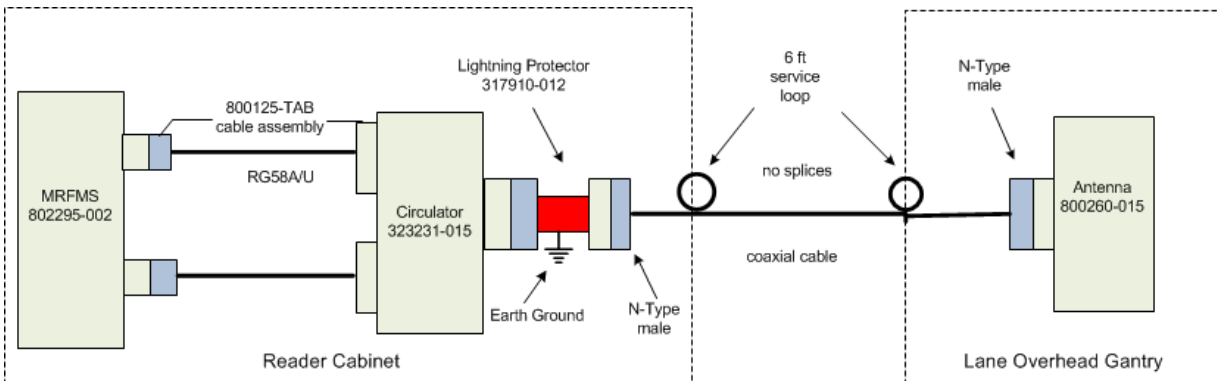

Figure 5-8: RF Cable Installation Schematic Bi-Static TDM/6C Only Operation



Performing Lane Tuning

Lane Tuning consists of selecting the frequencies to be used on the channels and setting the attenuation for the channels to control the ERP of the reader. These are configured using the web interface. It is recommended that Kapsch Operations Group perform lane tuning to properly configure a site. If the integrator/operator wishes to perform the lane tuning, the following guidelines apply:

- The same FDM channel frequency should not be used on adjacent lanes (including straddle and shoulder).
- The same TDM channel from 2 synchronized readers should not be used on adjacent lanes (including straddle and shoulder).

- The TX attenuation should be adjusted to obtain capture zones nominally 8-12 ft along direction of vehicle traffic.

Attention: When installing or replacing a MRFM-S, RF cables, circulator, or antenna, the lane must be re-tuned.

The Synchronization circuit

Reader synchronization ensures antennas from different Readers do not attempt to communicate simultaneously with the same on-board unit (OBU). The synchronization circuit connects SPMs together in a star network. The CTM does the synchronization of the RF module interrogation.

Prerequisites: Sync hub terminal block mounted in a location central to the Readers. The exact location of this terminal block should be marked on a site map to aid system maintenance.

- Readers arranged so that no Reader is farther than 1500 feet from the sync hub terminal block
- Readers arranged so that the total synchronization network cable length is no greater than 2000 feet
- No more than six (6) Readers in the synchronization circuit

Note: It is recommended that each synchronization cable have two or more spare conductors to support future service repair calls.

Installing a synchronization circuit

1. Connect the Readers to the Sync hub terminal block as in Figure 5-9 on page 179.

Attention: Ensure that cables do not connect from the GND terminal on the SPM to the Sync hub terminal block, as this can create a ground loop and affect synchronization performance.

Note: Before you continue, you will need to gain access to the CTM web Interface through a computer or service laptop connected to the Ethernet 1 port or the USB port of the Reader. See the following procedures for more information.

- Connecting a service laptop to the Reader on page 47
- Changing the service laptop IP address on page 47
- Testing the connection to the reader on page 47
- Accessing the CTM web interface on page 47

2. Select the **Configuration** link on the left side panel.

Result: The following screen appears.

Configuration

General | Test Tags | Lane Assignment | Tag Programming | OBU Feedback | Toll Rate/Balance | Channel | RF Attenuation | LC | LC-Extended | Serial | Group | Manage

Config | Changes | Programs

Site Name: SEC

Ethernet 1 (LC 10Gbps) IP Address: 148.198.225.198

Ethernet 1 (LC 10Gbps) Subnet Mask: 255.255.0.0

Ethernet 2 (RJ45 10Mbps) IP Address: 102.168.0.51

Reader IP Address: 10.0.0.50

USB Adapter or Bluetooth IP Address: 102.168.2.50

Default Gateway IP: 0.0.0.0

Suppress Non-IAG Tags:

Diagnostics Port Baud Rate: 115200

Reader configuration Auto-backup & Recovery:

Reader Sync:

Enable Reader Sync:	<input checked="" type="checkbox"/>
Superframe Sync Skip:	<input type="radio"/> Sync to every superframe <input checked="" type="radio"/> Sync to every other superframe
Add 2 Dummy Frames:	<input checked="" type="radio"/> No <input type="radio"/> Yes
Type Of Reader Syncing To:	Janus

Report Latency by Tag Type:

0 - Interior FPT Delay [ms]	0
1 - Exterior FPT Delay [ms]	0
2 - Exterior LPT Delay [ms]	0
3 - LCD Display Delay [ms]	0
4 - Commercial Vehicle (CVO) Delay [ms]	0
5 - OBU Feedback Tag Delay [ms]	0
6 - HOT Tag Delay [ms]	0

Primary/Secondary:

Redundant Mode:	<input checked="" type="checkbox"/>
Dual Reporting Mode:	<input type="checkbox"/>
Auto Recovery To Prime:	<input checked="" type="checkbox"/>
Switchover on Ethernet LC Link Down:	<input type="checkbox"/>

Reader Statistics:

Use database:	<input checked="" type="checkbox"/>
Database (Txns) Maximum records:	10000
Database (Summary) Retention period [7-90 days]:	30
Database (Summary) Interval [1-30 minutes]:	15

Dashboard:

Transaction Summary dashboard:	<input checked="" type="checkbox"/>
--------------------------------	-------------------------------------

3. Select the **Enable Reader Sync** check box, if necessary.

Result: The following screen appears.

Note: Expanded Enable Reader Sync outlined in overlaid box below.

Configuration

General | Test Tools | Lane Assignment | Tag Programming | OBU Feedback | Toll Rate/Balances | Channel | RF Attenuation | LC | LC Extended | Serial | Group | Message Config

Site Name: LB000.179

Ethernet 1 (LC 1Gbps) IP Address: 148.198.225.179

Ethernet 2 (IRF 100Mbps) IP Address: 192.168.0.61

Reader IP Address: 192.168.0.101

USB Adapter or Bluetooth IP Address: 192.168.2.58

Default Gateway IP: 0.0.0.0

Suppress Non-IAG Tags:

Diagnostics Port Band Rate: 115200

Reader Sync:

Enable Reader Sync:

Superframe Sync Skip: Sync to every superframe
 Sync to every other superframe

Add 2 Dummy Frames: No
 Yes

Type Of Reader Syncing To: None

Report Latency by Tag Type:

0 - Internet EPT Delay [ms]	0
1 - Exterior EPT Delay [ms]	0
2 - Exterior LPT Delay [ms]	0
3 - LCD Display Delay [ms]	0
4 - Commercial Vehicle (CVO) Delay [ms]	0
5 - OBU Feedback Tag Delay [ms]	0
6 - HOT Tag Delay [ms]	0

Primary/Secondary:

Recharge Mode:

Dual Reporting Mode:

Auto Recovery To Prime:

Switchover on Ethernet LC Link Down:

Reader Statistics:

Use database:

Maximum record count: 10000

Figure 5-9: Synchronization circuit schematic for three Readers

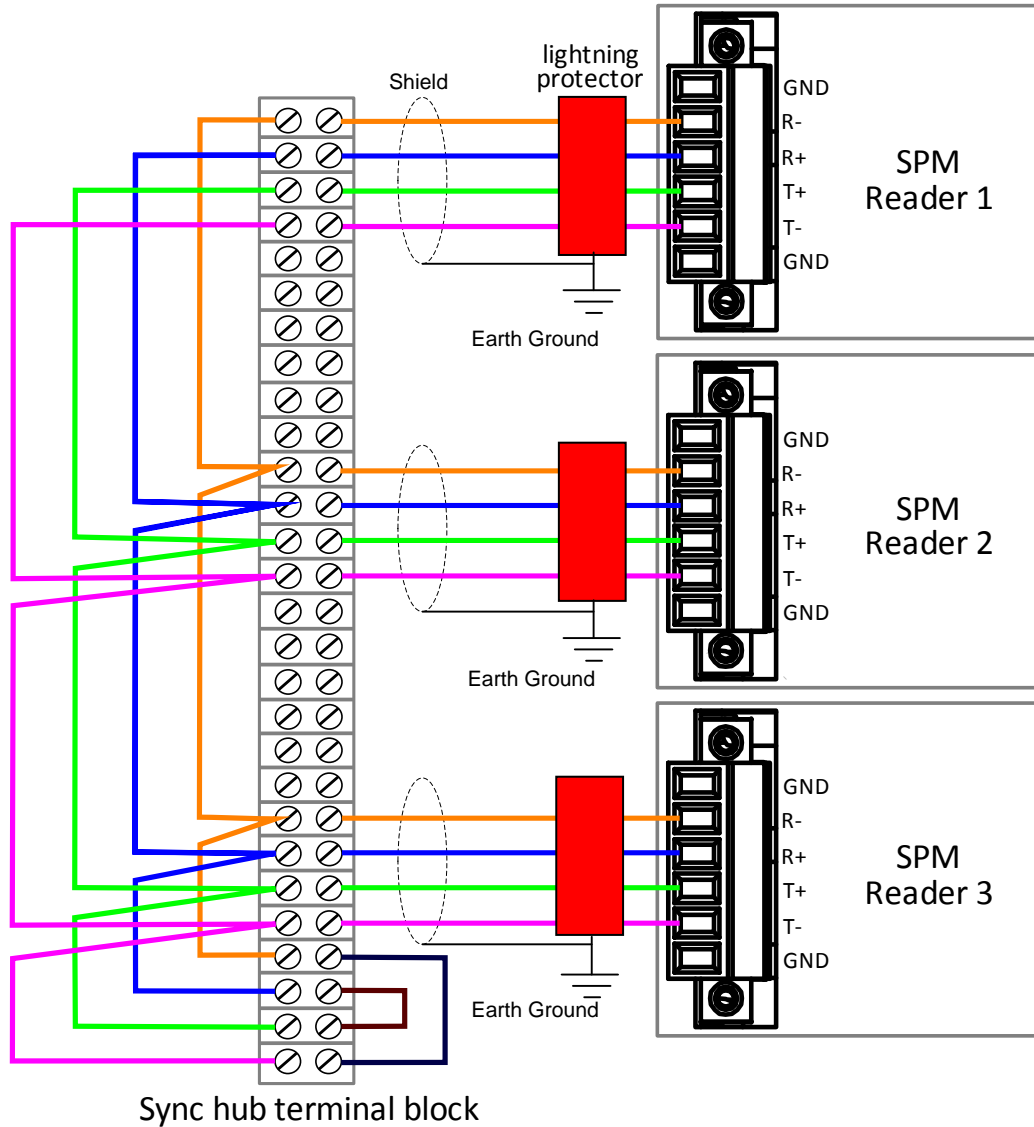

Synchronization between MPR2 Readers

All Readers in a synchronization circuit must be configured correctly for Synchronization to work. Also, the number of frames per superframe must be equal between MPR2 Readers in the synchronization circuit.

Configuring synchronization

Prerequisites: Connect the service laptop to the Reader configuration port to access the CTM web interface. Refer to Connecting a service laptop to the Reader, page 47.

Note: Reader synchronization also enabled remotely by the LC if the Remote LC Configuration is enabled.

1. Select the **Configuration** link on the left side panel.
2. Select the **Enable Reader Sync** check box, if necessary.

Result: The synchronization settings appear.



The screenshot shows the 'Configuration' page in the Kapsch web interface. The 'Reader Sync' section is expanded, showing the following settings:

Field	Value
Enable Reader Sync:	<input checked="" type="checkbox"/>
Superframe Sync Skip:	<input checked="" type="radio"/> Sync to every superframe <input type="radio"/> Sync to every other superframe
Add 2 Dummy Frames:	<input checked="" type="radio"/> No <input type="radio"/> Yes
Type Of Reader Syncing To:	JANUS

Other visible settings include:

- Site Name: 18000179
- Ethernet 1 (LC 1Gbps) IP Address: 148.196.225.179
- Ethernet 2 (BRF 100Mbps) IP Address: 192.168.0.01
- Reader IP Address: 192.168.0.01
- USB Adapter or Bluetooth IP Address: 192.166.2.30
- Default Gateway IP: 0.0.0.0
- Suppress Non-LAG Tags:
- Diagnostics Port Band Rate: 115200

Under 'Report Latency by Tag Type', several delay fields are set to 0:

- 0 - Interior FRT Delay [ms]: 0
- 1 - Exterior FRT Delay [ms]: 0
- 2 - Interior LFT Delay [ms]: 0
- 3 - LCD Display Delay [ms]: 0
- 4 - Commercial Vehicle (CVO) Delay [ms]: 0
- 5 - OBU Feedback Tag Delay [ms]: 0
- 6 - HOT Tag Delay [ms]: 0

Under 'Primary/Secondary', the following settings are visible:

- Reckon Mode:
- Dual Reporting Mode:
- Auto Recovery To Prime:
- Switchover on Ethernet LC Link Down:

Under 'Reader Statistics':

- Use database:
- Maximum record count: 10000

3. Select **Sync to Every Superframe** in the **Superframe Sync Skip** row.
4. Select **No** in the **Add 2 Dummy Frames** row.
5. Select **JANUS** from the drop-down box in the **Type of Reader Syncing To** row.
6. Repeat these steps for all Readers in the Synchronization circuit.

Synchronization between JANUS® Readers and BADGER Readers

JANUS® and BADGER Readers in the same synchronization network can be configured as in step 1 in the procedure Synchronization between MPR2 Readers. However, JANUS® and BADGER Readers can also have the superframe configurations shown in Table 5-3 on page 183.

Configuring Synchronization

Prerequisites: Connect the service laptop to the Reader configuration port to access the CTM web interface. Refer to Connecting a service laptop to the Reader, page 47.

Note: Reader synchronization can also be enabled remotely by the LC if Remote LC Configuration is enabled.

1. Select the **Configuration** link on the left side panel.
2. Select the **Enable Reader Sync** check box, if necessary.

Result: The synchronization settings appear.



The screenshot shows the 'Configuration' page of the Kapsch web interface. The left sidebar contains navigation links: Home, Status, Statistics, Configuration (selected), Manage Software, Manage Users, Set Time, Log Files, Diagnostics, Log Out. The main content area has a top navigation bar with tabs: General, Test Tags, Lane Assignment, Tag Programming, OBU Feedback, Toll Rate/Balances, Channel, RF Attenuation, LC, LC Extended, Serial, Group, Message Config. The 'General' tab is active, showing various configuration fields. The 'Reader Sync' section is expanded, showing the following settings:

Site Name:	LB800.179
Ethernet 1 (LC 1Gbps) IP Address:	148.196.225.179
Ethernet 2 (BRF 100Mbps) IP Address:	192.168.0.11
Reader IP Address:	192.168.0.101
USB Adapter or Bluetooth IP Address:	192.168.2.90
Default Gateway IP:	0.0.0.0
Suppress Non-IAG Tags:	<input type="checkbox"/>
Diagnostics Port Baud Rate:	115200
Reader Sync:	
Enable Reader Sync:	<input checked="" type="checkbox"/>
Superframe Sync Skip:	<input checked="" type="checkbox"/> Sync to every superframe <input type="checkbox"/> Sync to every other superframe
Add Dummy Frames:	<input checked="" type="checkbox"/> No <input type="checkbox"/> Yes
Type Of Reader Syncing To:	Janus
Report Latency by Tag Type:	
0 - Interior EPT Delay (ms):	0
1 - Exterior EPT Delay (ms):	0
2 - Exterior LPT Delay (ms):	0
3 - LCD Display Delay (ms):	0
4 - Commercial Vehicle (CVO) Delay (ms):	0
5 - OBU Feedback Tag Delay (ms):	0
6 - HOT Tag Delay (ms):	0
Primary/Secondary:	
Redundant Mode:	<input checked="" type="checkbox"/>
Dual Reporting Mode:	<input type="checkbox"/>
Auto Recovery To Primary:	<input checked="" type="checkbox"/>
Switchover on Ethernet LC Link Down:	<input type="checkbox"/>
Reader Statistics:	
Use database:	<input checked="" type="checkbox"/>
Maximum record count:	10000

On the left sidebar, the current user is 'admin'. The site name is 'LB800.17...', Reader ID is '0', Plaza ID is '0', and Tag Group ID is '45'. The reader date/time is 'Mon Feb 10 2014 03:06 pm'. The software version is 'CTM ID: 813158'.

3. If the configuration is not already set, then set Superframe **Sync Skip** to **Select Sync** to **Every Superframe**, set **Add 2 Dummy Frames** to **No**, set **Type of Reader Syncing to** to **JANUS** or **BADGER**, as applicable.
4. If the superframes for all Readers will be equal (4, 5, 8 or 10 frames) go to Synchronization between MPR2 Readers and perform step 1.
5. If the superframes will be configured as shown in Table 5-3, configure the **Superframe Sync Skip** and **Add 2 Dummy Frames** parameters in the **General** tab on the **Configuration** page as outlined in Table 5-3 on page 183.

Table 5-3: Synchronization Compatibility Matrix – JANUS® and BADGER

JANUS® Reader superframe size	Superframe Sync Skip Setting	Add two dummy frames Setting	BADGER Reader superframe size	Badger Sync (fixed)	Badger dummy frames (fixed)
8 frames	sync to every superframe	No	4 frames	sync to every other superframe	No
10 frames	sync to every superframe	Yes (with 8 active or offline RF channels)	5 frames	sync to every other superframe	No

The Ethernet Network

These are general instructions for using Ethernet Switch Modules (ESMs) to create an Inter-Reader (IR) Ethernet network or a Lane Controller (LC) Ethernet network.

Installing an Ethernet network

Prerequisites: ESMs mounted according to the manufacturer's instructions.

1. Use CAT 6 Ethernet cables to connect the components in the Ethernet network together as shown in the examples in Figure 5-10. Consult the ESM manufacturer's instructions for more details.

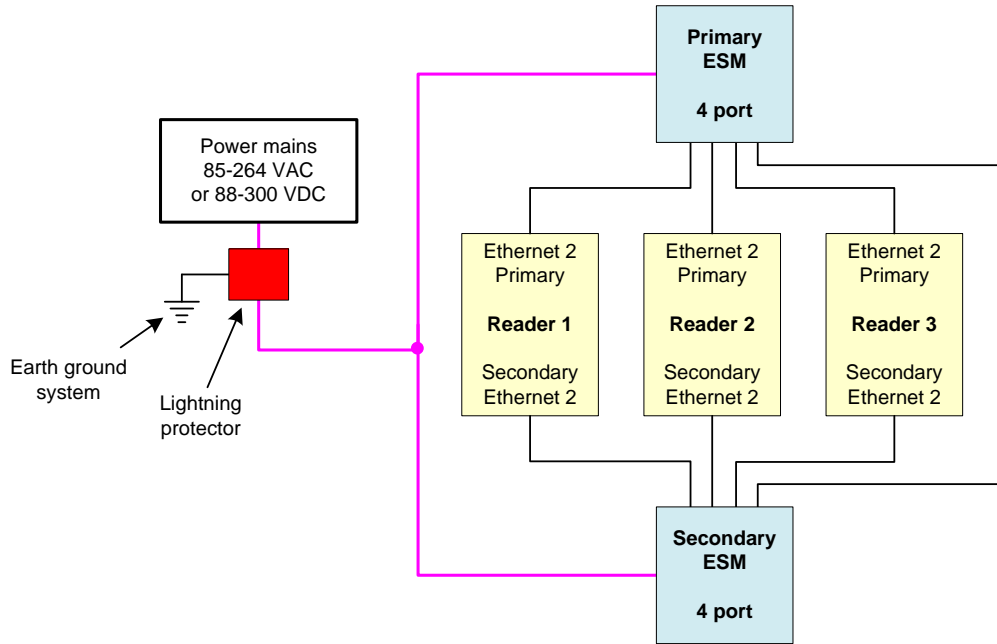

Figure 5-10: Schematic of a three-Reader IR network

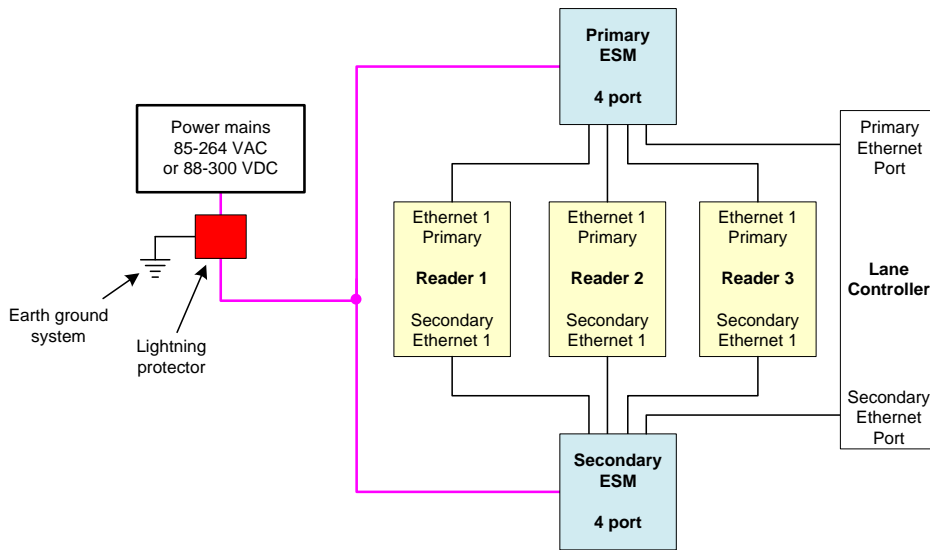

Figure 5-11: Schematic of a three-Reader LC network

Reader connections to the LC via the LPM serial ports

Each of the RF channels has an associated serial port on the LPM that connects to an LC.

Configuring reader connections

The following steps provide information on configuring the reader connections to the LC via the LPM serial ports.

Prerequisites: Connect the service laptop to the Reader configuration port to access the CTM web interface. Refer to Connecting a service laptop to the Reader, page 47. You must have Advanced User permissions.

1. Determine your Reader's communications protocol. It will be either RS-232 or RS-422.
2. Select the **Configuration** link on the left side panel.
3. Click the **LC** tab.

Result: The following screen appears.

The screenshot shows the 'Configuration' page with the 'LC' tab selected. The configuration options include:

- Allow Remote LC Configuration:
- Status Message Buffering:
- LC Ethernet TCP-Socket Local Port: 8889
- LC Ethernet TCP-Socket Timeout (ms): 500
- Heartbeat Message: Send Heartbeat Messages:
- Reporting Formats: Use RFP-Compliant Message Format: ; Tail Rate / Balance Adjustment Tag Report Format: IAG Standard Format; ATA Transponder Data Format: 8-bit ASCII HEX
- Report Filtering: ATA Tag Report Filtering/Threshold: Disabled; Verify ATA Data CRC:
- Reporting: Voting Report, Generate Initial Report, Raw Handshake Report, Generate Post-Capture-Zone Report, Generate Estimated-Vehicle-Speed Report. Each has checkboxes for IAG, SE, 6C, Allegro, ATA, and SeGo.
- Destination: A table with 8 columns (Ch #1 to Ch #8) and 3 rows (Serial, Ethernet, Tertiary Ethernet). Each cell contains a radio button and the corresponding protocol name.
- Destination IP Address: 148.136.225.115; Port: 8889
- Set destination IP addresses of all LCs to be same as: Duplicate

4. In the **Destination** row, select the **Serial** check box for each RF channel that will communicate with the LC via an LPM COM Port.

Example: The following screen shows an example of the assignments.

	Ch #1	Ch #2	Ch #3	Ch #4	Ch #5	Ch #6	Ch #7	Ch #8	
Destination	<input checked="" type="checkbox"/> Serial <input checked="" type="checkbox"/> Ethernet <input type="checkbox"/> Dual Ethernet <input type="checkbox"/> Tertiary Ethernet	<input checked="" type="checkbox"/> Serial <input checked="" type="checkbox"/> Ethernet <input type="checkbox"/> Dual Ethernet <input type="checkbox"/> Tertiary Ethernet	<input checked="" type="checkbox"/> Serial <input checked="" type="checkbox"/> Ethernet <input type="checkbox"/> Dual Ethernet <input type="checkbox"/> Tertiary Ethernet	<input checked="" type="checkbox"/> Serial <input checked="" type="checkbox"/> Ethernet <input type="checkbox"/> Dual Ethernet <input type="checkbox"/> Tertiary Ethernet	<input checked="" type="checkbox"/> Serial <input checked="" type="checkbox"/> Ethernet <input type="checkbox"/> Dual Ethernet <input type="checkbox"/> Tertiary Ethernet	<input type="checkbox"/> Serial <input type="checkbox"/> Ethernet <input type="checkbox"/> Dual Ethernet <input type="checkbox"/> Tertiary Ethernet	<input type="checkbox"/> Serial <input type="checkbox"/> Ethernet <input type="checkbox"/> Dual Ethernet <input type="checkbox"/> Tertiary Ethernet	<input type="checkbox"/> Serial <input type="checkbox"/> Ethernet <input type="checkbox"/> Dual Ethernet <input type="checkbox"/> Tertiary Ethernet	<input type="checkbox"/> Serial <input type="checkbox"/> Ethernet <input type="checkbox"/> Dual Ethernet <input type="checkbox"/> Tertiary Ethernet
Serial Port	COM1	COM2	COM3	COM4	COM5				
Destination IP Address	148.196.225.115 Port: 8080	148.196.225.127 Port: 8080	148.196.225.127 Port: 8080	148.196.225.127 Port: 8080	148.196.225.127 Port: 8080				

Set destination IP addresses of all LCs to be same as

- From the **Serial Port** dropdowns, select an LPM port for each RF channel to use to communicate with the LC.

Note 1: By default, RF Channel 1 communicates with the LC via LPM COM 1, RF Channel 2 communicates with the LC via LPM COM 2 and so on, up to RF Channel 8.

Note 2: More than one RF Channel can communicate via one LPM COM port, if necessary.

- Click the **Serial** tab on the **Configuration** page.

Result: The following screen appears.

	COM1	COM2	COM3	COM4	COM5	COM6	COM7	COM8
Serial Port State	<input type="checkbox"/>	<input type="checkbox"/>	<input type="checkbox"/>	<input type="checkbox"/>	<input type="checkbox"/>	<input type="checkbox"/>	<input type="checkbox"/>	<input type="checkbox"/>

- Ensure all the COM Ports selected in step 5 are enabled by selecting the corresponding **Serial Port State** check box.
- Select the **Baud Rate**, **Data Bits**, **Parity**, and **Stop Bits** to match the LC communication settings.

Example: An example of what your screen may look like follows.

	COM1	COM2	COM3	COM4	COM5	COM6	COM7	COM8
Serial Port State	<input checked="" type="checkbox"/>	<input checked="" type="checkbox"/>	<input checked="" type="checkbox"/>	<input checked="" type="checkbox"/>	<input checked="" type="checkbox"/>	<input type="checkbox"/>	<input type="checkbox"/>	<input type="checkbox"/>
Baud Rate	19200	19200	19200	19200	19200			
Data Bits	8	8	8	8	8			
Parity	None	None	None	None	None			
Stop Bits	1	1	1	1	1			

Refer to the Configuring the Reader to switch over automatically when an LC link is down procedure on page 238 to configure the Reader to switch over when the connection from the LPM to the LC is down.

IP addresses

Each ethernet port in an IR or LC network must have a unique IP address. The IP addresses should be set as required for the site network topology. Default IP addresses are:

- Primary and secondary Ethernet 1 port: 192.168.1.50

- Primary side Ethernet 2 port: 192.168.0.50
- Secondary side Ethernet 2 port: 192.168.0.51

Setting the IP addresses

Prerequisites: Connect the service laptop to the Reader configuration port to access the CTM web interface. Refer to Connecting a service laptop to the Reader, page 47.

Note: A secure record of the IP addresses should be maintained to aid network troubleshooting. The primary and secondary Ethernet 1 IP addresses will be required if requesting remote assistance from Kapsch Service.

1. Select the **Configuration** link on the left side panel.
2. Assign an IP address to the parameter **Ethernet 1 (LC 1Gbps) IP Address** so that the Primary CTM is accessible on the LC network, if necessary.
3. Assign an IP address to the parameter **Ethernet 2 (IRIF 100Mbps) IP Address** so that the Primary CTM is accessible on the IR network, if necessary.
4. Assign an IP address to the parameter **Reader IP Address** for both primary and secondary CTMs on a given Reader so that the Reader is accessible on the IR network, if necessary. This IP address is the same for both CTMs in a Reader.
5. Assign an IP address to the parameter **USB Adapter or Bluetooth IP Address** if a USB adapter is being used to connect a CTM USB port to an Ethernet network.
6. Assign the gateway IP address to the parameter **Default Gateway IP** so that the Reader can communicate via a gateway device such as a router, if necessary.
7. Repeat steps 1 through 6 for the secondary CTM.

Configuring an LC Ethernet network

The Reader data can also be sent to the LC via an Ethernet network.

Prerequisites: The service laptop connects to the port and the CTM web accessed. . Refer to Connecting a service laptop to the Reader, page 47. You must have Advanced User permissions.

1. Select the **Configuration** link on the left side panel.
2. Click the **LC** tab.

Result: The following screen appears.

Configuration

General | Tool Types | Lane Assignment | Tag Programming | OBU Feedback | Toll Rate/Balance | Channel | RF Attenuation | LC | LC-Extended | Serial | Group | Message Config | Changes | Compare

Allow Remote LC Configuration:

Status Message Buffering:

LC Ethernet TCP-socket Local Port:

LC Ethernet TCP-socket Timeout (ms):

Heartbeat Message:
Send Heartbeat Messages:

Reporting Formats:
Use RFP-Compliant Message Format:

Toll Rate / Balance Adjustment Tag Report Format:

ATA Transponder Data Format:

Report Filtering:
ATA Tag Report Filtering/Threshold:

Verify ATA Data CRC:

Reporting:

	IAG	SB	GC	Allegis	ATA	SeGo
Voting Report:	<input checked="" type="checkbox"/>	<input checked="" type="checkbox"/>	<input checked="" type="checkbox"/>	<input checked="" type="checkbox"/>	<input checked="" type="checkbox"/>	<input checked="" type="checkbox"/>
Generate Initial Report:	<input type="checkbox"/>	<input type="checkbox"/>	<input type="checkbox"/>	<input type="checkbox"/>	<input type="checkbox"/>	<input type="checkbox"/>
Raw Handshake Report:	<input type="checkbox"/>	<input type="checkbox"/>	<input type="checkbox"/>	<input type="checkbox"/>	<input type="checkbox"/>	<input type="checkbox"/>
Generate Post-Capture-Zone Report:	<input type="checkbox"/>	<input type="checkbox"/>	<input type="checkbox"/>	<input type="checkbox"/>	<input type="checkbox"/>	<input type="checkbox"/>
Generate Estimated-Vehicle-Speed Report:	<input type="checkbox"/>	<input type="checkbox"/>	<input type="checkbox"/>	<input type="checkbox"/>	<input type="checkbox"/>	<input type="checkbox"/>

	Ch #1	Ch #2	Ch #3	Ch #4	Ch #5	Ch #6	Ch #7	Ch #8	
Destination:	<input type="checkbox"/> Serial <input checked="" type="checkbox"/> Ethernet <input type="checkbox"/> Dual Ethernet <input type="checkbox"/> Tertiary Ethernet	<input type="checkbox"/> Serial <input checked="" type="checkbox"/> Ethernet <input type="checkbox"/> Dual Ethernet <input type="checkbox"/> Tertiary Ethernet	<input type="checkbox"/> Serial <input checked="" type="checkbox"/> Ethernet <input type="checkbox"/> Dual Ethernet <input type="checkbox"/> Tertiary Ethernet	<input type="checkbox"/> Serial <input checked="" type="checkbox"/> Ethernet <input type="checkbox"/> Dual Ethernet <input type="checkbox"/> Tertiary Ethernet	<input type="checkbox"/> Serial <input checked="" type="checkbox"/> Ethernet <input type="checkbox"/> Dual Ethernet <input type="checkbox"/> Tertiary Ethernet	<input type="checkbox"/> Serial <input checked="" type="checkbox"/> Ethernet <input type="checkbox"/> Dual Ethernet <input type="checkbox"/> Tertiary Ethernet	<input type="checkbox"/> Serial <input checked="" type="checkbox"/> Ethernet <input type="checkbox"/> Dual Ethernet <input type="checkbox"/> Tertiary Ethernet	<input type="checkbox"/> Serial <input checked="" type="checkbox"/> Ethernet <input type="checkbox"/> Dual Ethernet <input type="checkbox"/> Tertiary Ethernet	<input type="checkbox"/> Serial <input checked="" type="checkbox"/> Ethernet <input type="checkbox"/> Dual Ethernet <input type="checkbox"/> Tertiary Ethernet
Destination IP Address:	<input type="text" value="146.198.225.115"/> <input type="text" value="Port: 8889"/>								

Set destination IP addresses of all LCs to be same as:

- In the **Destination** row, select the **Ethernet** check box for each RF channel that will communicate with the LC via Ethernet.
- Enter the LC IP address and Port number for each RF channel.
- If all the RF channels will be communicating with the LC at the same IP address, enter the number of a configured channel in the field beside the **Duplicate** button and then click **Duplicate**.

Result: All RF channels selected to communicate over Ethernet will now have the same destination LC IP.

Note: When setting the LC Retry Timeout, consider the baud rate used to communicate with the LC and the processing speed of the LC to avoid false failure reports.

- Enter a time, in milliseconds, in the **LC Ethernet TCP-Socket Timeout** field.

Note: If an LC does not respond within this time, the Reader will consider Ethernet communications to the LC to be down and could trigger a switchover, depending on the redundancy settings.

Configuring the Ethernet 1 IP address via the Diagnostic Port

Attention: Contact Kapsch Service to set the ETHERNET 1 port IP address via the Diagnostic Port if the IP address has been lost or cannot be determined.

Lane Assignment voting for ORT applications

ORT lanes allow OBUs to cross multiple capture zones. The Readers must assign an OBU to one RF channel to prevent duplicate transactions.

Selecting the correct communication method

The communication method determines how Readers communicate with each other to share information for determining lane assignments. This is important for situations similar to that shown in Figure 5-12, where, to assign the OBU to a lane, Reader 1 and Reader 2 need to share handshaking information.

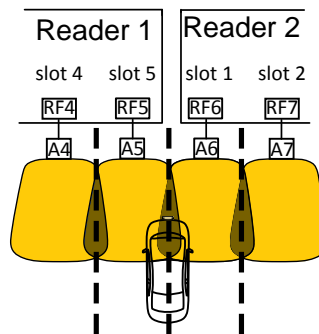

Figure 5-12: Two Readers communicating with one OBU

Configuring Lane Voting over an Inter-Reader (IR) network

This procedure allows you to configure the Reader correctly to ensure accurate lane assignment and to prevent duplicate reports.

Prerequisites: Connect the service laptop to the Reader configuration port to access the CTM web interface. Refer to Connecting a service laptop to the Reader, page 47. You must have Advanced User permissions.

Note: Badger-Style CRA: there is no physical link between the Readers, such as an IR Network. Instead, the first Reader to contact an OBU programs the OBU; all other Readers that subsequently contact the OBU will see that it was recently programmed and ignore the OBU.

Ethernet: An IR Ethernet network connects the Readers together and handshaking information is shared between Readers. The Readers assign the OBU to one channel and all other transaction reports from other Readers are suppressed.

1. Select the **Configuration** link on the left side panel.

- Click the **Lane Assignment** tab.

Result: The following screen appears.

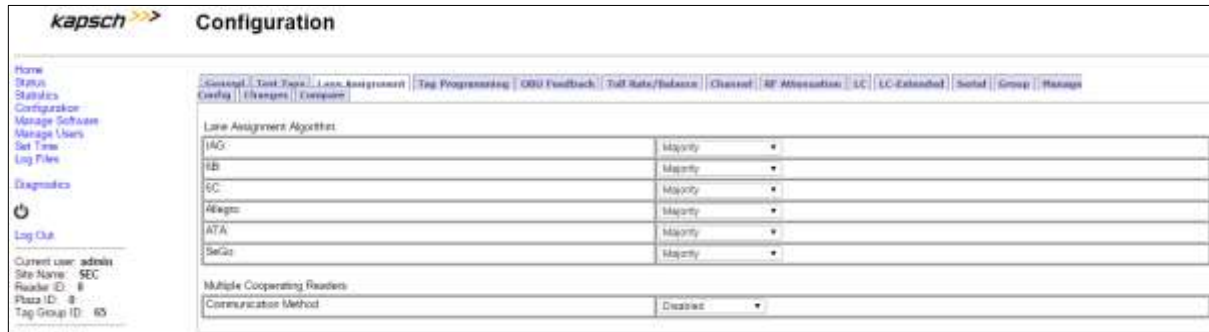

Configuration

Home | Status | Statistics | Configuration | Manage Software | Manage Users | Set Times | Log Files | Diagnostics | Log Out

Current user: admin
Site Name: SEC
Reader ID: 1
Plaza ID: 1
Tag Group ID: 65

General | Test Types | Lane Assignment | Tag Programming | OBU Feedback | Toll Rate/Balance | Channel | RF Attenuation | LC | LC-Extended | Serial | Group | Manage

Config | Changes | Compare

Lane Assignment Algorithm:

IAG:	Majority
IB:	Majority
EC:	Majority
Allegro:	Majority
ATA:	Majority
SeGo:	Majority

Multiple Cooperating Readers:

Communication Method:	Disabled
-----------------------	----------

- Select **Ethernet** from the **Communication Method** drop-down box.

Result: The following screen appears.

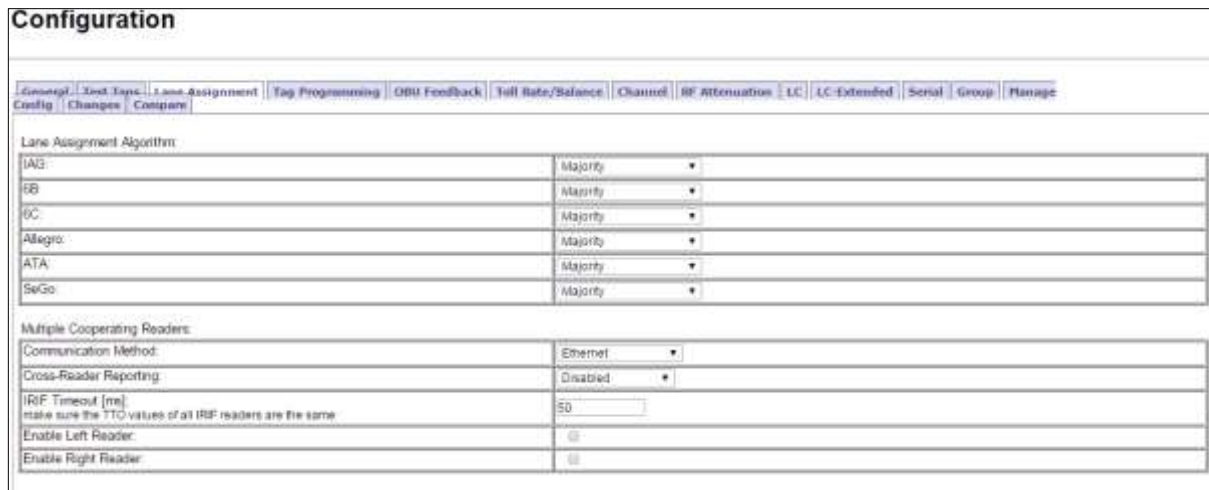

Configuration

General | Test Types | Lane Assignment | Tag Programming | OBU Feedback | Toll Rate/Balance | Channel | RF Attenuation | LC | LC-Extended | Serial | Group | Manage

Config | Changes | Compare

Lane Assignment Algorithm:

IAG:	Majority
IB:	Majority
EC:	Majority
Allegro:	Majority
ATA:	Majority
SeGo:	Majority

Multiple Cooperating Readers:

Communication Method:	Ethernet
Cross-Reader Reporting:	Disabled
IRIF Timeout [ms] <small>make sure the TTC values of all IRIF readers are the same</small>	50
Enable Left Reader:	<input type="checkbox"/>
Enable Right Reader:	<input type="checkbox"/>

Configure how multiple transactions are reported to the LC:

- To send one transaction report per OBU to the LC without informing the LC of suppressed reports, select **Disabled** from the **Cross-Reader Reporting** drop-down box.
- To send all transaction reports for an OBU to the LC, select **Report All** from the **Cross-Reader Reporting** drop-down box.
- To send one transaction report per OBU to the LC and also inform the LC of suppressed reports, select **Report Non-zero** from the **Cross-Reader Reporting** drop-down box.

- Configure the IR network by determining where the Reader sits in the IR network.

Example: Reader 1 in Figure 5-13 has a Reader on its right (Reader 2) but no Reader on the left. Reader 2 in Figure 5-13 has a Reader on its right (Reader 3) and a Reader on its left (Reader 1). Reader 3 in Figure 5-13 does not have a Reader on its right but has one on its left (Reader 2).

Figure 5-13: Three readers covering one direction of wide lane ORT traffic

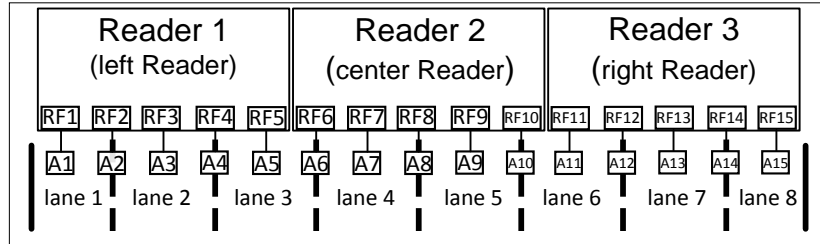

Note: The Reader IP address applies to the whole Reader and not individual Ethernet ports. You can view the Reader IP address in the General tab of the Configuration page.

2. If there is a Reader on the left, select the **Enable Left Reader** check box.
3. Enter the Reader IP address of the left Reader.
4. Press Enter or select a different tab.
5. If there is a Reader on the right, select the **Enable Right Reader** check box.
6. Enter the Reader IP address of the right Reader.
7. Press Enter or select a different tab.
8. TTO values for the grouped IDs must be the same across all readers.
9. A reader restart is required when the IR network configuration is complete
10. To set the Reader to switchover when an IR link is down, see the Configuring events that cause a switchover procedure, page 237.
11. Configure **Tag Programming** (see OBU Programming on page 67) ensuring that:
 - TMP and TCP are enabled
 - The Plaza IDs of all Readers at the plaza match
 - The Reader ID for each Reader is different
12. Configure the Reader clocks in the IR network to have the same time (see Using an NTP Server to synchronize the clocks of Readers in an IR network, page 250).

Note: Multiple group IDs are not supported across multiple readers.
13. From the **Channel** tab on the **Configuration** page, ensure all channels covering one direction of traffic have the same Group ID.

Configuring Badger-style Cross Reader Algorithm (CRA) communication

Prerequisites: Connect the service laptop to the Reader configuration port to access the CTM web interface. Refer to Connecting a service laptop to the Reader, page 47.

1. Select the **Configuration** link on the left side panel.
2. Click the **Lane Assignment** tab.

Result: The following screen appears.



Configuration

Home | Status | Statistics | Configuration | Manage Schedules | Manage Users | Set Time | Log Files | Diagnostics | Log Out

Current user: admin
Site Name: SDC
Reader ID: 8
Plaza ID: 8
Tag Group ID: 85

General | Test Type | Lane Assignment | Tag Programming | OBU Feedback | Toll Rate/Balance | Channel | RF Attenuation | LC | LC-Extended | Serial | Group | Manage Config | Changes | Compare

Line Assignment Algorithm:

IAG:	Majority
RB:	Majority
EC:	Majority
Allegro:	Majority
ATA:	Majority
SeGo:	Majority

Multiple Cooperating Readers:

Communication Method:	Disabled
-----------------------	----------

3. Select **Badger-Style CRA** from the **Communication Method** drop-down box.

Result: The following screen appears.

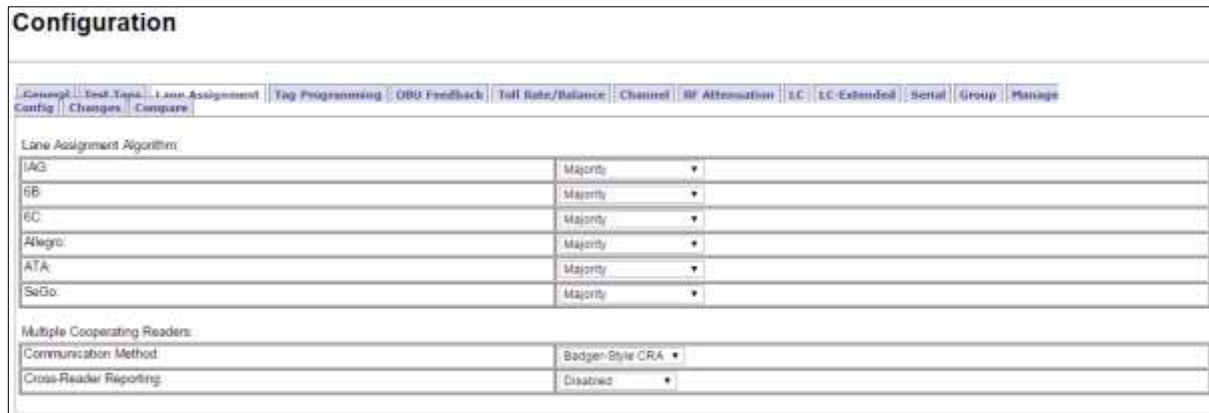

Configuration

General | Test Type | Lane Assignment | Tag Programming | OBU Feedback | Toll Rate/Balance | Channel | RF Attenuation | LC | LC-Extended | Serial | Group | Manage Config | Changes | Compare

Line Assignment Algorithm:

IAG:	Majority
RB:	Majority
EC:	Majority
Allegro:	Majority
ATA:	Majority
SeGo:	Majority

Multiple Cooperating Readers:

Communication Method:	Badger-Style CRA
Cross-Reader Reporting:	Disabled

4. Configure how multiple transactions are reported to the LC:
 - To send one transaction report per OBU to the LC without informing the LC of suppressed reports, select **Disabled** from the **Cross-Reader Reporting** drop-down box.
 - To send one transaction report per OBU to the LC and also inform the LC of suppressed reports, select **Report Non-zero** from the **Cross-Reader Reporting** drop-down box.
5. Configure **Tag Programming** (see OBU Programming on page 67) ensuring that:
 - TMP and TCP are enabled
 - the Plaza IDs of all Readers at the plaza match
 - the Reader ID for each Reader is different

Note: Multiple group IDs are not supported across multiple Readers.
6. From the **Channel** tab on the **Configuration** page, ensure all channels covering one direction of traffic have the same Group ID.

Note: The transponder timeout, set in the Group tab on the Configuration page, must be greater than the time difference between all Reader clocks in the network.
7. Manually set the Reader clocks to within 2 seconds of the same time (refer to the Manually setting the Reader time and date procedure on page 251).

Selecting the Voting Algorithm

Prerequisites: Connect the service laptop to the Reader configuration port to access the CTM web interface. Refer to Connecting a service laptop to the Reader, page 47.

- **Majority:** The OBU is assigned to the channel with the most handshakes.
- **Interpolated:** The Reader determines which set of three adjacent channels has the highest handshake count. The OBU is then assigned to the channel within this set with the most handshakes.

1. Select the **Configuration** link on the left side panel.
2. Click the **Lane Assignment** tab.

Result: The following screen appears.



3. Select either **Majority** or **Interpolated** from the drop-down box of the required protocol located in the **Lane Assignment Algorithm** box.

Note: If Interpolated is selected from the drop-down box, channels with handshake counts that differ less than the Handshake Equalization Ratio will be considered to have an equal handshake count since the difference is not considered significant.

4. If **Interpolated** was selected in step 1, enter a percentage in the **Handshake Equalization Ratio** field.

Configuring Voting Time

Manually setting a voting time gives a fixed voting time to each channel. Dynamic voting time allows the Reader to calculate and base the voting time on the average capture zone span time (the time it takes for an OBU to pass through a capture zone).

Manually set the voting time for a channel

Prerequisites: Connect the service laptop to the Reader configuration port to access the CTM web interface. Refer to Connecting a service laptop to the Reader, page 47.

1. Select the **Configuration** link on the left side panel.
2. Click the **Channel** tab.

Result: The following screen appears.

Configuration

General | Test Tags | Lane Assignment | Tag Programming | OBU Feedback | Toll Rate/Balance | Channel | RF Attenuation | LC | LC-Extended | Serial | Group | Manage

Config | Changes | Compare

TDM Enable

	Ch #1	Ch #2	Ch #3	Ch #4	Ch #5	Ch #6	Ch #7	Ch #8
TDM RF State:	Active	Active	Active	Stop				
TDM Tag Protocol:	<input checked="" type="radio"/> IAG <input type="radio"/> Alegro	<input checked="" type="radio"/> IAG <input type="radio"/> Alegro	<input checked="" type="radio"/> IAG <input type="radio"/> Alegro					

FDM Enable

	Ch #1	Ch #2	Ch #3	Ch #4	Ch #5	Ch #6	Ch #7	Ch #8
FDM RF State:	Active	Active	Dynamic	Dynamic	Dynamic	Dynamic	Dynamic	Dynamic
FDM Frequency [MHz]:	913.05	915.75	902.50	910.05	902.50	902.50	902.50	902.50
FDM Tag Protocol:	<input type="radio"/> (off) <input type="radio"/> SeGo <input type="radio"/> RB <input type="radio"/> SC <input checked="" type="radio"/> ATA <input type="radio"/> SeGo+6C <input type="radio"/> RB+6C							
ATA Super-Frame Skip Count:	<input type="text" value="0"/>							

	Ch #1	Ch #2	Ch #3	Ch #4	Ch #5	Ch #6	Ch #7	Ch #8
Channel Weight [%]:	<input type="text" value="100"/>	<input type="text" value="100"/>	<input type="text" value="100"/>	<input type="text" value="100"/>	<input type="text" value="100"/>	<input type="text" value="100"/>	<input type="text" value="100"/>	<input type="text" value="100"/>
Group ID:	<input type="text" value="0"/>	<input type="text" value="0"/>	<input type="text" value="0"/>	<input type="text" value="0"/>	<input type="text" value="0"/>	<input type="text" value="0"/>	<input type="text" value="0"/>	<input type="text" value="0"/>
LPT/FME Voting Time [ms]:	<input type="text" value="200"/>	<input type="text" value="300"/>	<input type="text" value="300"/>	<input type="text" value="300"/>	<input type="text" value="300"/>	<input type="text" value="300"/>	<input type="text" value="300"/>	<input type="text" value="300"/>
Voting Time (all other tag types) [ms]:	<input type="text" value="600"/>	<input type="text" value="200"/>	<input type="text" value="300"/>	<input type="text" value="400"/>	<input type="text" value="100"/>	<input type="text" value="100"/>	<input type="text" value="100"/>	<input type="text" value="100"/>
Dynamic Voting Control:	Disabled	Disabled	Disabled	Disabled	Disabled	Disabled	Disabled	Disabled

Set all RF channels to: Active

Set RF State of all channels to the same configuration as channel:

Set voting time / dynamic voting of all channels to the same configuration as channel:

3. Select **Disabled** from the drop-down menu in the **Dynamic Voting Control** row .
4. Enter a voting time, in milliseconds, in the **LPT/FME Voting Time** field to set the voting time for LPT and FME OBUs.
5. Enter a voting time, in milliseconds, in the **Voting Time (all other tags)** field to set the voting time for all OBUs that are not LPT or FME.
6. If a voting time of 0 was entered in step 4 and step 5 and **Dynamic Voting Control** is disabled (effectively disabling voting), click on the **Group** tab.

Result: The following screen appears.

Configuration

General | Test Tags | Lane Assignment | Tag Programming | OBU Feedback | Toll Rate/Balance | Channel | RF Attenuation | LC | LC-Extended | Serial | Group | Manage

Config | Changes | Compare

NOTE: Inter-reader operation and grouping are not mutually compatible.
Do not simultaneously enable grouping and inter reader operation.

	Group #1	Group #2	Group #3	Group #4	Group #5	Group #6	Group #7	Group #8
Transponder Timeout [s]:	<input type="text" value="3"/>	<input type="text" value="300"/>	<input type="text" value="300"/>	<input type="text" value="300"/>	<input type="text" value="300"/>	<input type="text" value="300"/>	<input type="text" value="300"/>	<input type="text" value="300"/>
Programming Timeout [ms]:	<input type="text" value="100"/>							

7. Enter a time, in seconds (s), in the **Transponder Timeout** field

Note: This specifies an amount of time a transponder must be away from a capture zone before it is reported again as a new transaction when it is detected.

8. Repeat steps 4 through 7 to individually configure the other channels, or enter the number of a configured channel in the field beside the **Duplicate** button on the Channel screen.
9. Click the **Duplicate** button to configure automatically the remaining channels.

Allowing the Reader to calculate the optimum voting time using Dynamic Voting Control

Prerequisites: Connect the service laptop to the Reader configuration port to access the CTM web interface. Refer to Connecting a service laptop to the Reader, page 47.

1. Select the **Configuration** link on the left side panel.
2. Click the **Channel** tab.

Result: The following screen appears.

The screenshot shows the 'Configuration' page with the 'Channel' tab selected. It displays settings for TDM and FDM across eight channels (Ch #1 to Ch #8).

	Ch #1	Ch #2	Ch #3	Ch #4	Ch #5	Ch #6	Ch #7	Ch #8
TDM Enable	☑							
TDM RF State	Active	Active	Active	Stop				
TDM Tag Protocol	☑ IAG ☐ Allegro	☑ IAG ☐ Allegro	☑ IAG ☐ Allegro					
FDM Enable	☑							
FDM RF State	Active	Active	Disabled	Disabled	Disabled	Disabled	Disabled	Disabled
FDM Frequency (MHz)	913.05	915.75	902.50	910.05	902.50	902.50	902.50	902.50
FDM Tag Protocol	<input type="radio"/> (off) <input type="radio"/> SeGo <input type="radio"/> 6B <input type="radio"/> 6C <input checked="" type="radio"/> ATA <input type="radio"/> SeGo+6C <input type="radio"/> 6B+6C							
ATA Super-Frame Skip Count	0							
Channel Weight (%)	100	100	100	100	100	100	100	100
Group ID	0	0	0	0	0	0	0	0
LPT/FME Voting Time (ms)	200	300	300	300	300	300	300	300
Voting Time (all other tag types) (ms)	600	200	300	400	100	100	100	100
Dynamic Voting Control	Disabled	Disabled	Disabled	Disabled	Disabled	Disabled	Disabled	Disabled

At the bottom of the form, there are three summary rows with 'Duplicate' buttons:

- Set all RF channels to: Active [Set]
- Set RF State of all channels to the same configuration as channel: [Ch #1] [Duplicate]
- Set voting time / dynamic voting of all channels to the same configuration as channel: [Ch #1] [Duplicate]

2. Set the **Dynamic Voting Control** to **Reader** to allow the Reader to automatically set the voting time by calculating the average capture zone span time.
3. Enter a sample size in the **Dynamic Voting Sample Size** field.

Note 1: This is the number of previous transactions the Reader includes when calculating the average capture zone span time.

Note 2: The Reader calculates the capture zone span time after each OBU transaction. The Reader will not update the Dynamic Voting Time unless the capture zone span time changes more than the Dynamic Voting Threshold percentage.

4. Enter a percentage in the **Dynamic Voting Threshold** field.

Result: The following screen appears.

Configuration

General | Test Tools | Lane Assignment | Tag Programming | OBU Feedback | Toll Rate/Balance | Channel | RF Allocation | LC | LC-Extended | Serial | Group | Manage

Config | Changes | Compare

TDM Enable:

	Ch #1	Ch #2	Ch #3	Ch #4	Ch #5	Ch #6	Ch #7	Ch #8
TDM RF State:	Active	Active	Active	Stop				
TDM Tag Protocol:	<input checked="" type="checkbox"/> IAS <input type="checkbox"/> Allegro	<input checked="" type="checkbox"/> IAS <input type="checkbox"/> Allegro	<input checked="" type="checkbox"/> IAS <input type="checkbox"/> Allegro					

FDM Enable:

	Ch #1	Ch #2	Ch #3	Ch #4	Ch #5	Ch #6	Ch #7	Ch #8
FDM RF State:	Active	Active	Active	Active	Active	Active	Active	Active
FDM Frequency (MHz):	913.00	915.75	902.50	910.00	902.50	902.50	902.50	902.50
FDM Tag Protocol:	<input type="radio"/> (off) <input type="radio"/> SeGo <input type="radio"/> 6B <input type="radio"/> 6C <input checked="" type="radio"/> ATA <input type="radio"/> SeGo+6C <input type="radio"/> 6B+6C							
ATA Super-Frame Skip Count:	0							

	Ch #1	Ch #2	Ch #3	Ch #4	Ch #5	Ch #6	Ch #7	Ch #8
Channel Weight [%]:	100	100	100	100	100	100	100	100
Group ID:	0	0	0	0	0	0	0	0
LPT/FME Voting Time [ms]:	2000	3000	0	0	0	0	0	0
Voting Time (all other tag types) [ms]:	6000	2000	0	0	0	0	0	0
Dynamic Voting Control:	Reader	Reader	Disabled	Disabled	Disabled	Disabled	Disabled	Disabled
Dynamic Voting Sample Size:	20	20						
Dynamic Voting Threshold [%]:	20	20						
Dynamic Voting Capture Zone Span Multiplier:	2	2						

Set all RF channels to: Active | Set

Set RF State of all channels to the same configuration as channel: | Duplicate

Set voting time / dynamic voting of all channels to the same configuration as channel: | Duplicate

Configuring Channel Weight for straddle antennas

The handshake count of straddle channels (channels 2 and 4 in Figure 5-14) typically have less weight assigned to them than non-straddle channels (channels 1, 3, and 5 in Figure 5-14).

Prerequisites: Connect the service laptop to the Reader configuration port to access the CTM web interface. Refer to Connecting a service laptop to the Reader, page 47.

1. Select the **Configuration** link on the left side panel.
2. Click the **Channel** tab.

Result: The following screen appears.

Configuration

General | Test Type | Lane Assignment | Tag Programming | OBU Feedback | Toll Rate/Balance | Channel | RF Attenuation | LC | LC-Extended | Serial | Group | Manage

Config | Changes | Compare

TDM Enable

	Ch #1	Ch #2	Ch #3	Ch #4	Ch #5	Ch #6	Ch #7	Ch #8
TDM RF State	Active	Active	Active	Stop				
TDM Tag Protocol	<input checked="" type="radio"/> IAG <input type="radio"/> Allegro	<input checked="" type="radio"/> IAG <input type="radio"/> Allegro	<input checked="" type="radio"/> IAG <input type="radio"/> Allegro					

FDM Enable

	Ch #1	Ch #2	Ch #3	Ch #4	Ch #5	Ch #6	Ch #7	Ch #8
FDM RF State	Active	Active	Disable	Disable	Disable	Disable	Disable	Disable
FDM Frequency (MHz)	913.05	915.75	902.50	910.00	902.50	902.50	902.50	902.50
FDM Tag Protocol	<input type="radio"/> (off) <input type="radio"/> SeGo <input type="radio"/> 6B <input type="radio"/> 6C <input checked="" type="radio"/> ATA <input type="radio"/> SeGo+6C <input type="radio"/> 6B+6C							
ATA Super-Frame Skip Count	0							

	Ch #1	Ch #2	Ch #3	Ch #4	Ch #5	Ch #6	Ch #7	Ch #8
Channel Weight (%)	100	100	100	100	100	100	100	100
Group ID	0	0	0	0	0	0	0	0
LPT/FME Voting Time (ms)	200	300	300	300	300	300	300	300
Voting Time (all other tag types) (ms)	600	200	300	400	100	100	100	100
Dynamic Voting Control	Disabled	Disabled	Disabled	Disabled	Disabled	Disabled	Disabled	Disabled

Set all RF channels to: Active | Set

Set RF State of all channels to the same configuration as channel: | Duplicate

Set voting time / dynamic voting of all channels to the same configuration as channel: | Duplicate

3. Enter a percentage in the **Channel Weight** field for each channel.

Example: A channel weight of 100% means the full handshake count is considered at voting time, while a channel weight of 50% means only half the handshake count is considered at voting time.

	Ch #1	Ch #2	Ch #3	Ch #4	Ch #5	Ch #6	Ch #7	Ch #8
Channel Weight (%)	100	50	100	100	100	100	100	100
Group ID	0	0	0	0	0	0	0	0
LPT/FME Voting Time (ms)	2000	3000	0	0	0	0	0	0
Voting Time (all other tag types) (ms)	6000	2000	0	0	0	0	0	0
Dynamic Voting Control	Disabled	Disabled	Disabled	Disabled	Disabled	Disabled	Disabled	Disabled

Set all RF channels to: Active | Set

Set RF State of all channels to the same configuration as channel: | Duplicate

Set voting time / dynamic voting of all channels to the same configuration as channel: | Duplicate

Figure 5-14: Three Wide ORT lanes with two straddle antennas

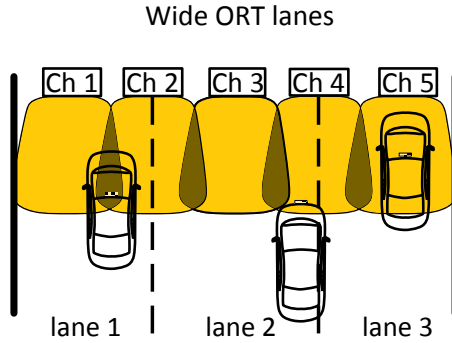

6. TROUBLESHOOTING AND TESTING

Troubleshooting Methodology

Troubleshooting trees are provided for resolving the most common Reader issues. A Test and Replace methodology is used for servicing the Reader system. The general steps are:

1. **Test** all symptoms that may have attributed to the reported system fault. Use the following suggestions to reveal faults:
 - Examine the Reader status on the Reader browser STATUS page (see Reader status, page 53).
 - Examine the RF channel statistics (page 60).
 - Examine the trouble log files for any reported issues with the Reader (page 162).
 - Observe the status LEDs on the Reader front panel (see LED Status, page 201).

Replace a suspected faulty component.

Continue with symptom testing and component replacement until there are no fault symptoms.

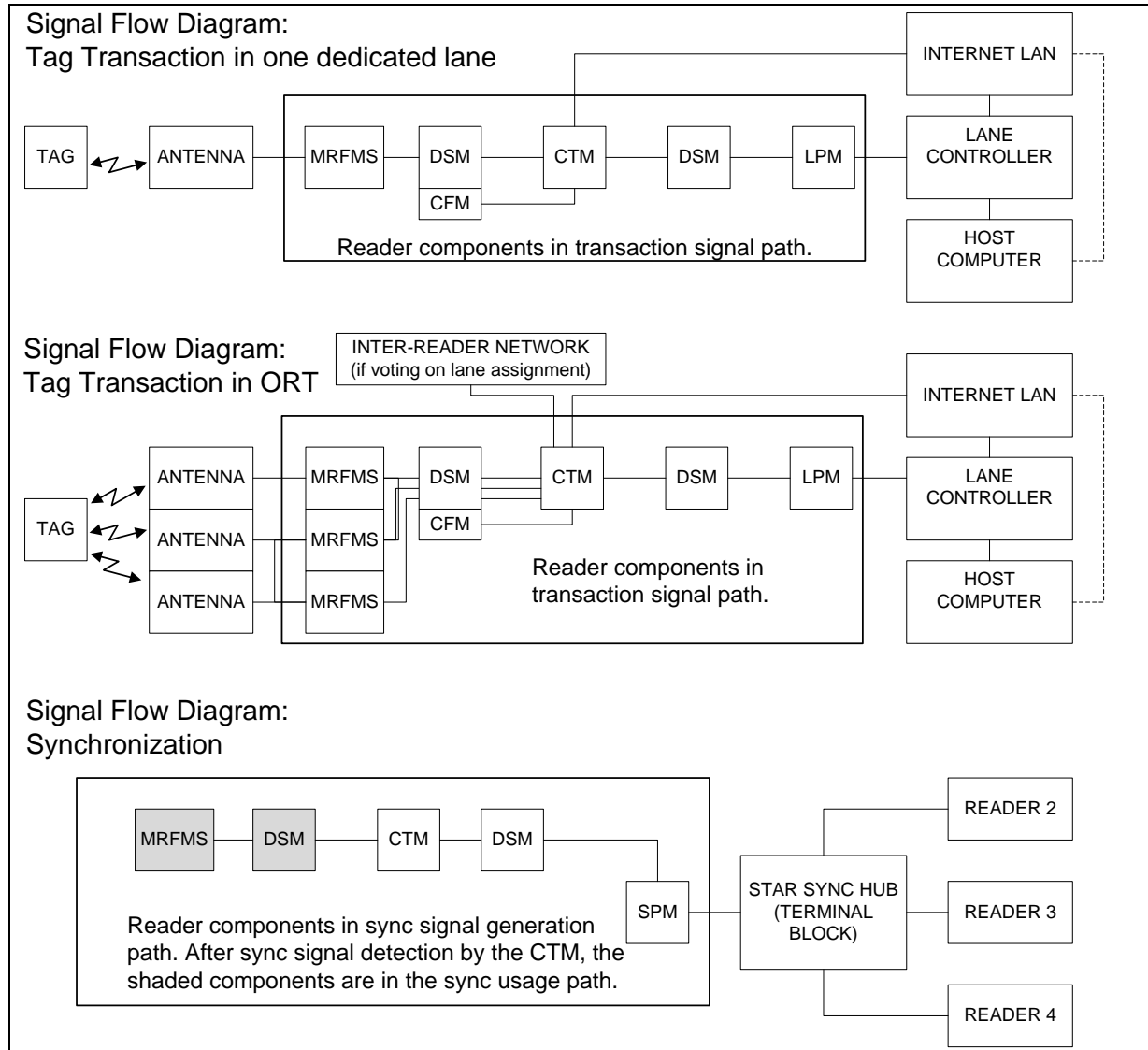

Figure 6-1: Signal Flow Diagrams

LED Statuses

The following table gives an overview of all the LEDs on the Reader. See the Troubleshooting Trees beginning on page 204 to resolve any issues.

Table 6-1: CTM LED states explained

CTM LEDs		
LED	State	Meaning
CGC	solid green	CGC is functional
	solid red	CGC has failed
MC	solid green	MC is functional
	solid red	MC has failed
SYNC	solid green	Reader is synchronized
	flashing red	Reader out of sync, or,
		No activity on the Rx port on the terminal block of the SPM (R+ and R- on the connector).
		another Reader in sync network is stuck in the busy state
	flashing green/orange	Reader is out of sync and attempting recovery
off	Synchronization is disabled	
ACTIVE	solid green	the CTM is active and in control. This indicates if the primary or secondary side is active.
	solid red	the CTM is not active
POWER	solid green	CTM is receiving power from PSM
	off	CTM is not receiving power from PSM, or,
		CTM reset switch is OFF

Table 6-2: PSM LED states explained

PSM LED		
LED	State	Meaning
+15 STATUS	solid green	PSM is supplying +15VDC via DSM
	off	PSM is not supplying +15VDC
+5 STATUS	solid green	PSM is supplying +5VDC via DSM
	off	PSM is not supplying +5VDC

Table 6-3: MRFM-S LED states explained

MRFM-S LED		
LED	State	Meaning
DATA	solid green	MRFM-S is functional
	off	MRFM-S is not enabled

Troubleshooting tree: LC Ethernet 1 Port communications not working

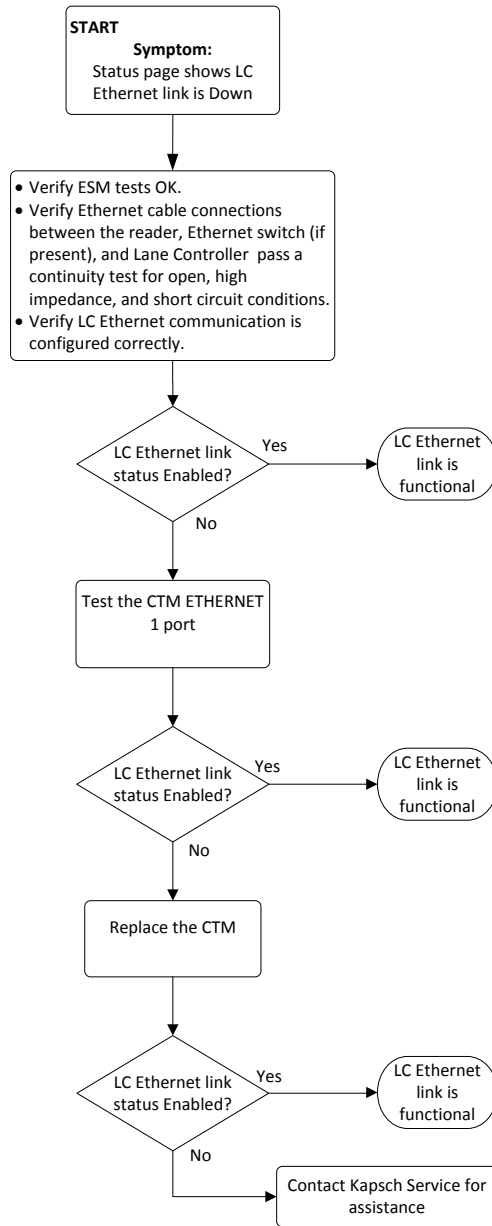

Troubleshooting tree: Ethernet 2 Port communications not working

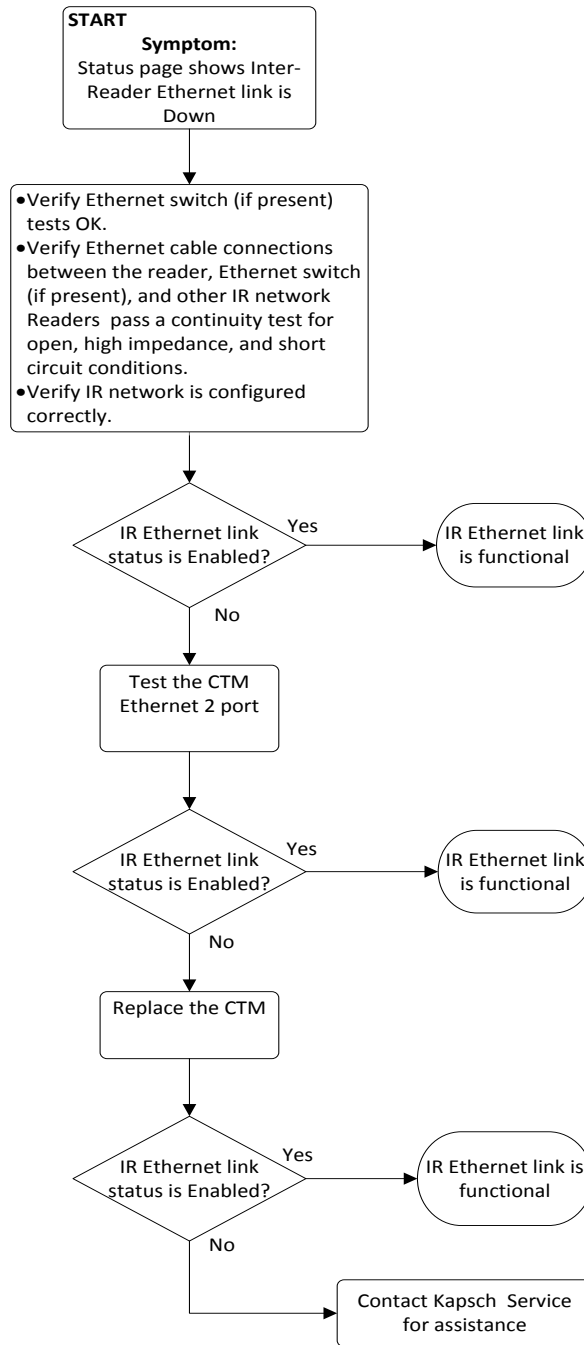

Troubleshooting tree: LPM Serial Port communications not working

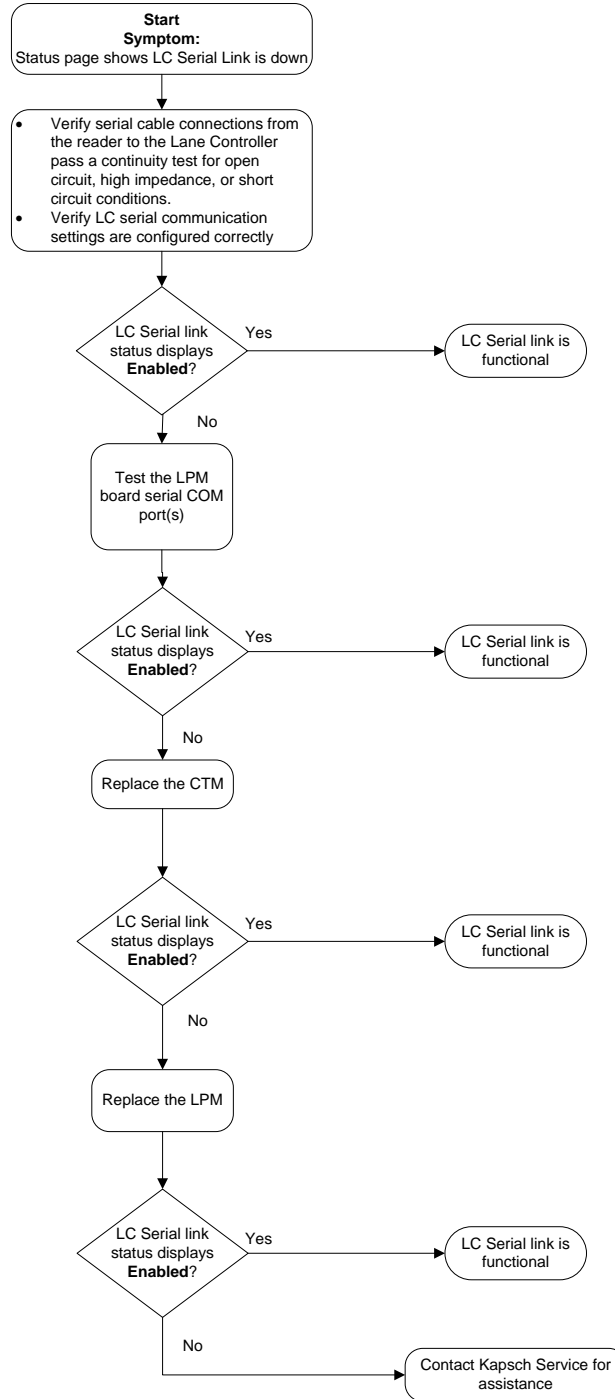

Troubleshooting tree: MRFM-S not working

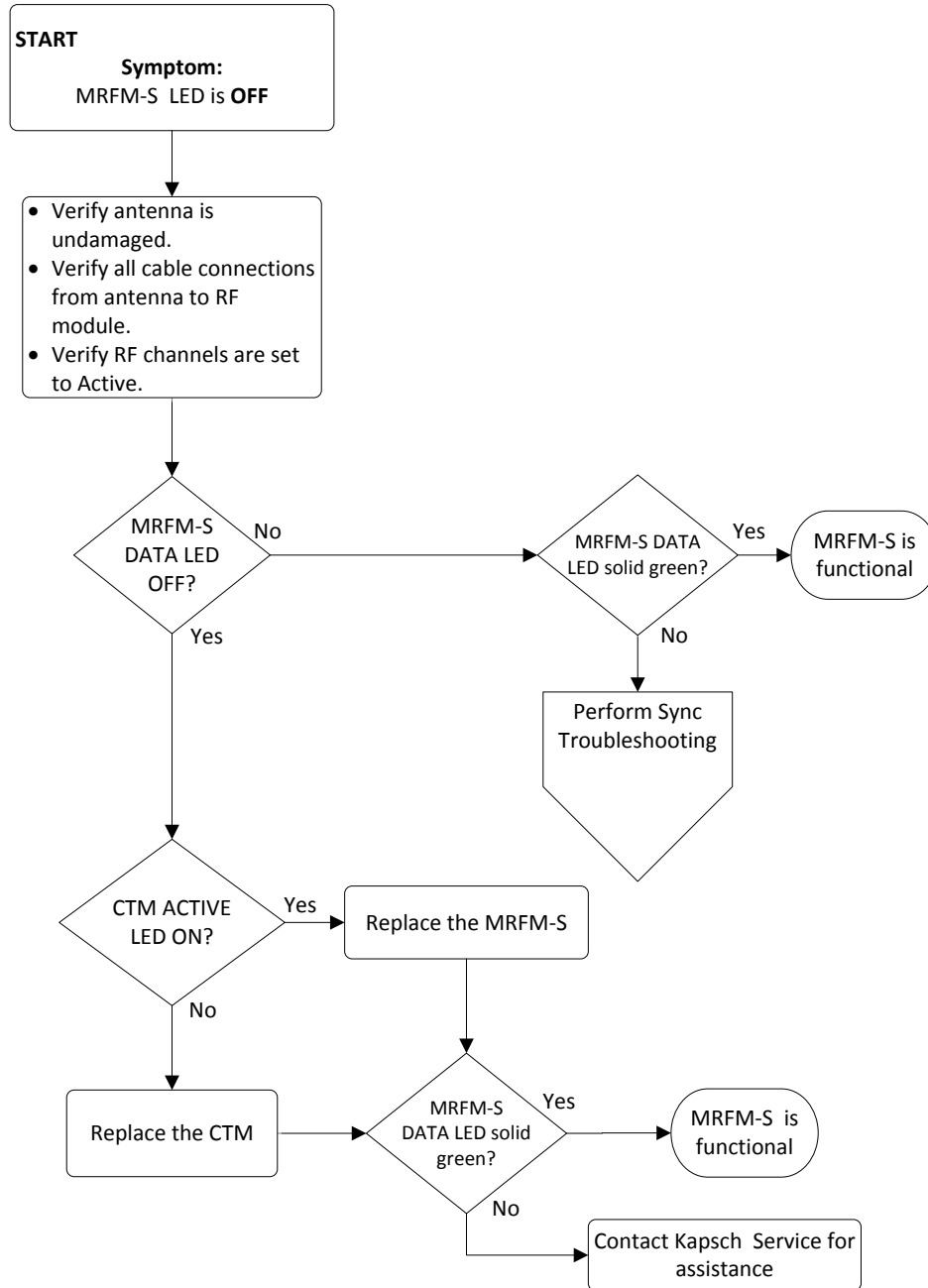

Troubleshooting tree: Synchronization not working

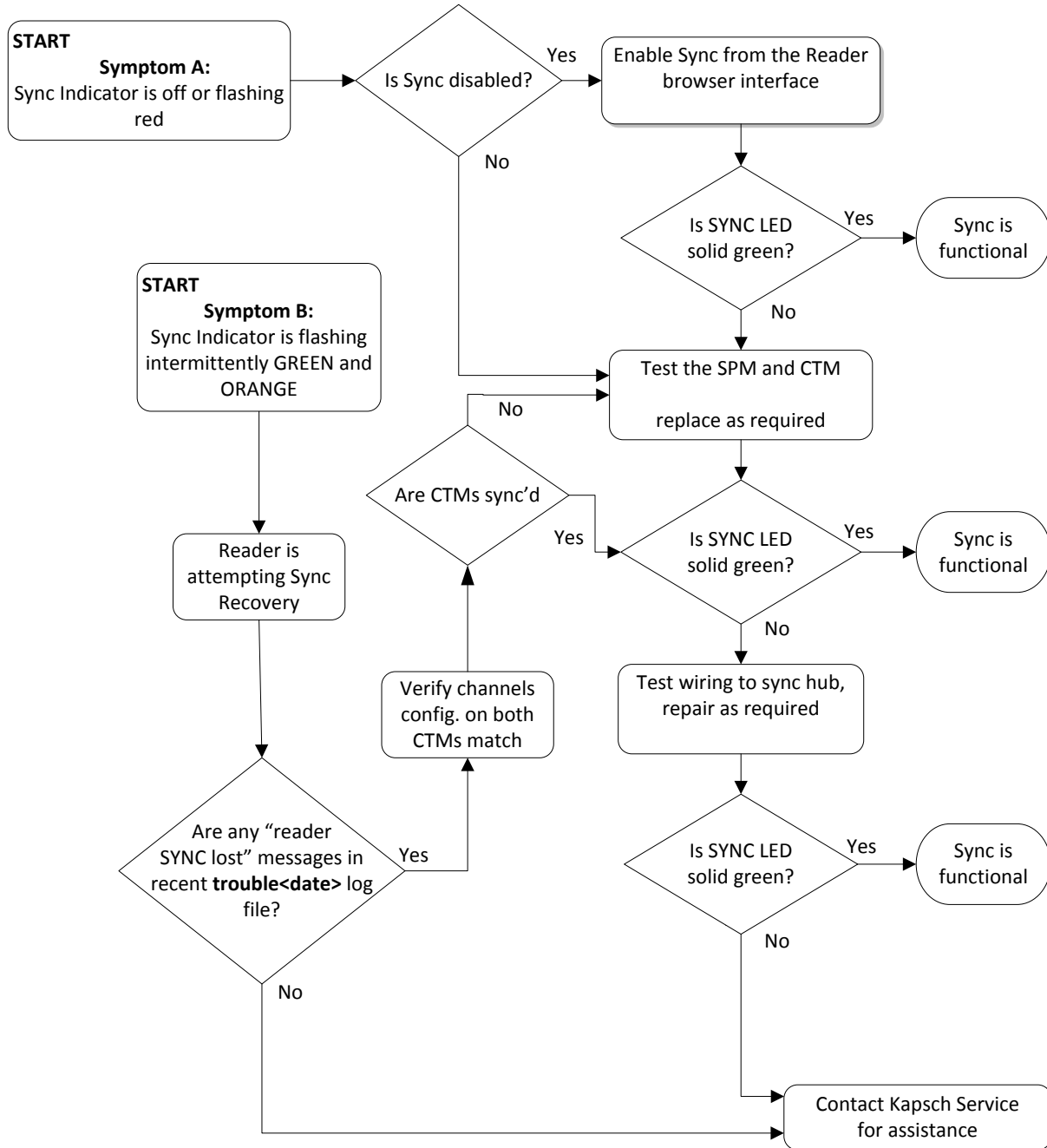

Constant busy state on sync bus

A Reader that erroneously holds the sync bus in a BUSY state causes all other Readers connected to the bus to time-out while waiting for the READY state. As a result, all of their CTM SYNC LEDs will be flashing red. Disconnect each Reader one at a time from the sync hub until the fault clears then reconnect each Reader in the order of removal until the fault reappears. Service each faulty Reader.

Sync board Failure Indicator for incomplete cable connections

The CTM SYNC LED will flash steadily red if there is no activity on the Rx port on the terminal block of the SPM (R+ and R- on the connector). If both transmit and receive connections are cut off from the sync hub the indicator will flash red. If only the transmit connection is disconnected and there are other Readers in the synchronization network, the CTM SYNC LED stays green.

Troubleshooting tree: Reader does not automatically switch back to Primary side after fault recovery

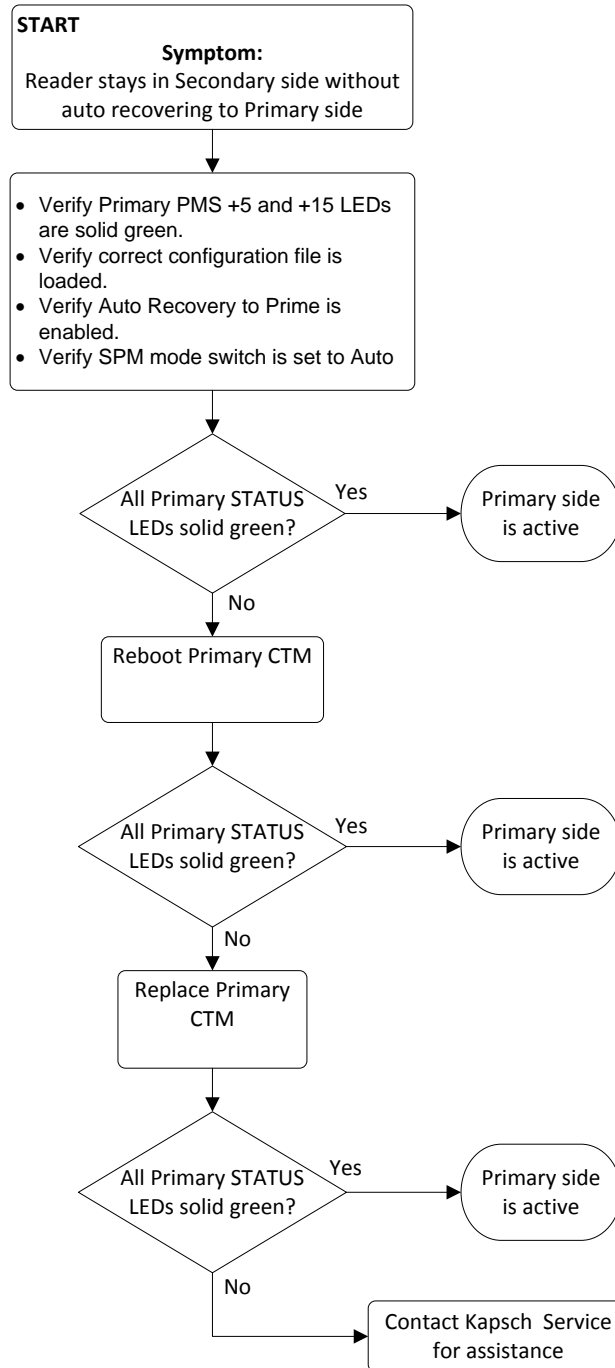

Troubleshooting tree: Simultaneous faults on Primary and Secondary CTMs

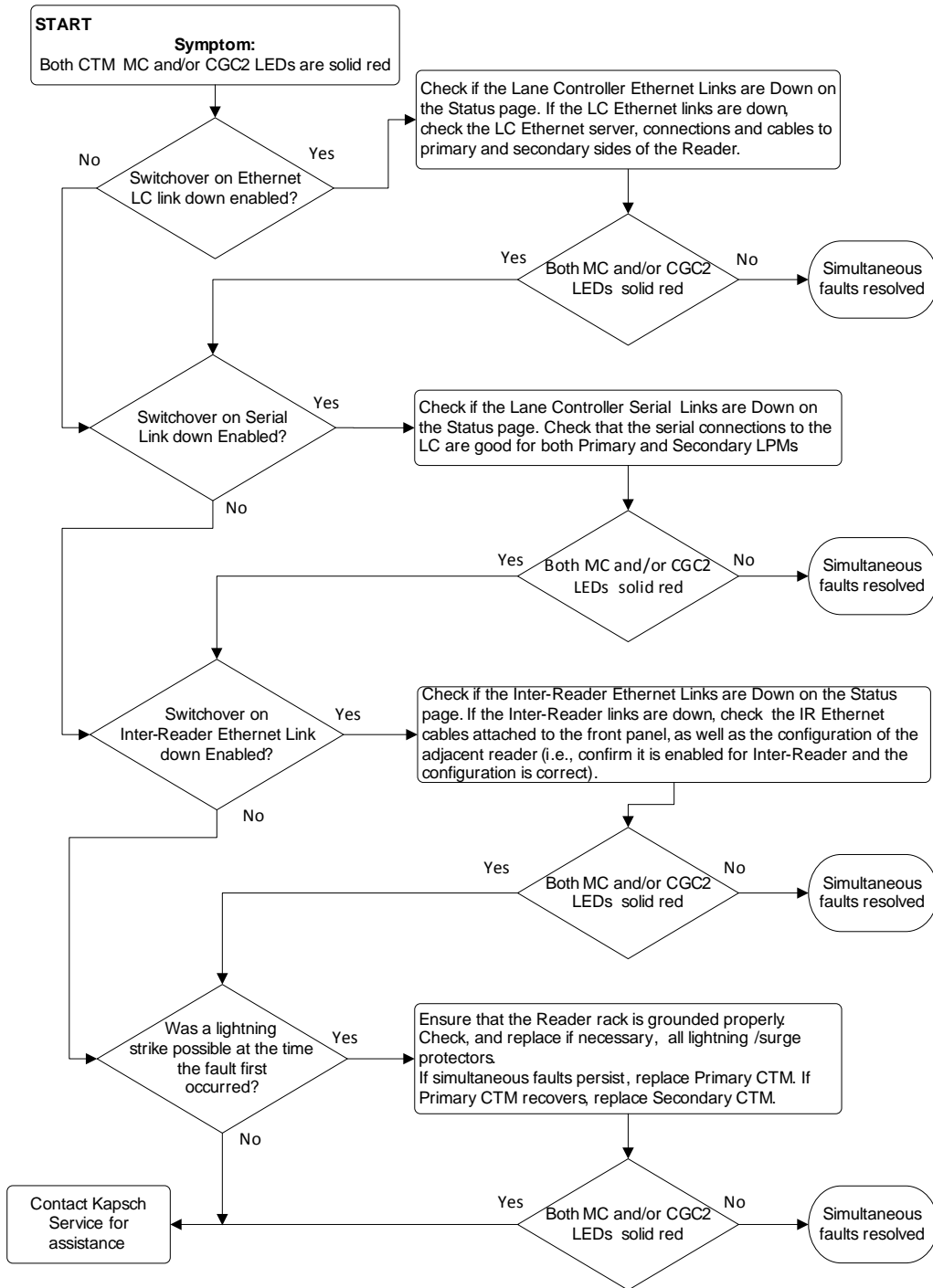

Identifying failures on the primary and/or secondary side

Primary and/or Secondary side failure is indicated by any of the following conditions:

- Ethernet LC link down, as indicated on the Reader browser Status page.
- Ethernet IR network link down, as indicated on the Reader browser Status page.
- Primary CTM MC or CGC LEDs are red
- Serial LC link down, as indicated on the Reader browser STATUS page

Primary side failure is indicated by any of the following conditions

- SPM switch is in PRIMARY position: primary CTM ACTIVE LED is red
- SPM switch is in AUTO position: primary CTM ACTIVE LED is red

Secondary side failure is indicated by any of the following conditions:

- SPM switch in any position: secondary MC or CGC LEDs are red
- SPM switch is in SECONDARY position: secondary CTM ACTIVE LED is red
- SPM switch is in AUTO position: primary CTM ACTIVE LED is red and secondary CTM ACTIVE LED is red.

Events that cause an automatic switchover

Table 6-4 outlines the situations that can cause an automatic switchover and what settings need to be configured for the trigger to be enabled.

Table 6-4: Switchover triggers

Event	Cause	Enabling
Failed CGC Health	The Reader continuously monitors the CGC health and forces a switchover if health fails.	Automatic
Failed Serial Lane Controller Link	<p>The Reader forces a switchover when an enabled serial link from the LPM to the LC has been interrupted. Usually a downed link is due to external conditions.</p> <p>Only the lack of OBU transactions in outgoing messages to the LC allows a downed link to be detected. To detect serial cable issues in the absence of OBU transactions, the operator must enable Heartbeat messages</p>	<p>Must enable Switchover on Serial Link Down from General tab on Configuration page</p> <p>Must set LC Retry Timeout from Serial tab on Configuration page</p> <p>Set Heartbeat messages from LC tab on Configuration page</p>

Event	Cause	Enabling
Failed Ethernet Lane Controller Link	The Reader forces a switchover when an enabled Ethernet link has failed. Usually a downed link is due to external conditions. A downed link is detected regardless of whether OBU transactions are being generated or not.	Must enable Switchover on Ethernet LC Link Down from General tab on Configuration page User must set LC Ethernet TCP-Socket Timeout from LC tab on the Configuration page
Failed Inter-Reader Ethernet Link	The Reader continuously checks the link status of the IR network and forces a switchover if it fails.	User must set IRIF Timeout from Lane Assignment tab on Configuration page
Reader Software Update	During activation of a different firmware version, the Reader switches automatically to the redundant side if the redundant side is running and has no switchover conditions present. If the redundant side is not functioning, the Reader warns the operator of potential revenue loss and allows the operator to either continue or abort the update.	Automatic
Lane Controller Reboot	The lane controller protocol allows it to send a reboot request to the Reader. The Reader switches to the redundant side if the redundant side is running and has no switchover conditions present. If the redundant side is not functioning, the reboot is ignored.	User must enable Remote LC Configuration from LC tab on Configuration page
Web Interface Reboot	The web interface provides a reboot button. The Reader switches automatically to the redundant side if the redundant side is running and has no switchover conditions present. If the redundant side is not functioning, the Reader warns the operator of potential revenue loss and allows the operator to either continue or abort the reboot.	Automatic
Reboot using CTM ON/OFF switch	When the CTM ON/OFF switch is manually switched from ON to OFF, the Reader will automatically switch over	Automatic when the switch on the CTM is manually set to OFF

Event	Cause	Enabling
Test Tag failure	When the number of RF channels with failed test tag reaches the set threshold, the Reader will switch over to the redundant side if the redundant side is running and has no switchover conditions present. If the redundant side is not functioning, the test tag failure is ignored.	User must enable Test Tag State for each RF channel from the Test Tag tab on the Configuration page

Reader recovery actions

For certain failures, the Reader will automatically initiate the recovery actions outlined in Table 6-5.

Table 6-5: Failures and the Reader Recovery Actions they trigger

Failure	Reader Recovery Action
CGC Health failure	reinitializes CGC on failed side
Serial LC link down	re-attempts connection on failed side once every second
Ethernet LC link down	re-attempts connection on failed side once every second or up to 10 seconds based on load
Inter-Reader Ethernet link down	switches to Badger style CRA on failed side to re-attempt connection

Viewing MRFM-S fault codes

The MRFM-S sends binary fault codes from its LC COM port as part of a heartbeat message every 5 seconds. These fault codes are Byte 4 and 3 of the heartbeat message and can be viewed on a computer connected to the reader LC COM port.

Prerequisites: A computer equipped with RealTerm (or equivalent).

1. Connect the computer to the MRFM LC COM port using RealTerm (see Using RealTerm to connect to the MRFM, page 256). Data from the MRFM will be visible in the RealTerm window.
2. If several messages appear in the RealTerm program, identify the heartbeat message by identifying Byte 9. The value of Byte 9 is always 10111011.
3. Note the values of Byte 4 and Byte 3. Check Table 6-6 to determine if there is an MRFM fault.

Figure 6-2: Typical MRFM-S Heartbeat message

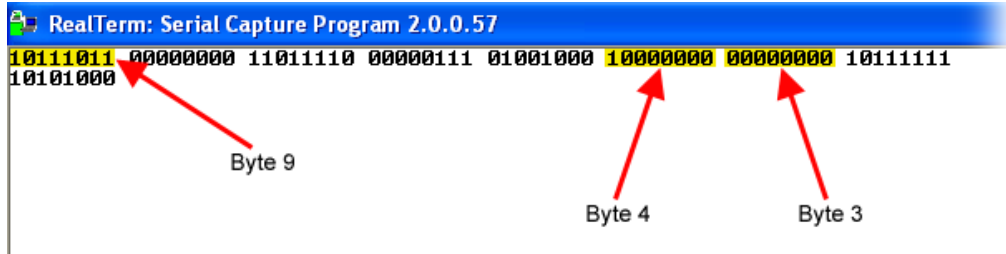

Byte number	Value	Meaning
Byte 4	10000000	normal lane operation
Byte 4	10000001	lane hardware fault
Byte 3	00000000	normal lane operation

Table 6-6: MRFM-S fault codes

Testing the CTM Ethernet 1 port

This test verifies that a CTM Ethernet 1 port is working properly.

Prerequisites: A service laptop.

1. Connect a service laptop directly to CTM Ethernet 1 port being tested (see Connecting a service laptop to the Reader, page 47).

Note: Ensure that you can access the CTM web interface with the service laptop (see Accessing the CTM web interface, page 47). This confirms the Ethernet port is functional.

Testing an LPM COM port

This test verifies that an LPM port is working properly and requires a simple loop-back connector.

Prerequisites: Connect the service laptop to the Reader configuration port to access the CTM web interface. Refer to Connecting a service laptop to the Reader, page 47. You must have Advanced User permissions.

Note: All OBU transactions on this port are buffered while the LC is disconnected from the LPM ports to perform the test.

1. Disconnect the serial cable from the LPM COM port being tested.

Note: The LPM is either RS-232 or RS-422. The loop-back test will only work if the appropriate loop-back connector is used.

2. Connect the appropriate loop-back connector to the COM port. In the RS-232 loop-back connector, the Tx and Rx signals are connected. In the RS-422 loop-back connector, the Tx+ and Rx+ signals are connected and the Tx- and Rx- signals are connected. The LPM RS-232 pin outs are shown on page 262; the LPM RS-422 pin outs are shown on page 263.
3. Select the **Diagnostics** link on the left side panel of the CTM web interface.

Result: The following screen appears.

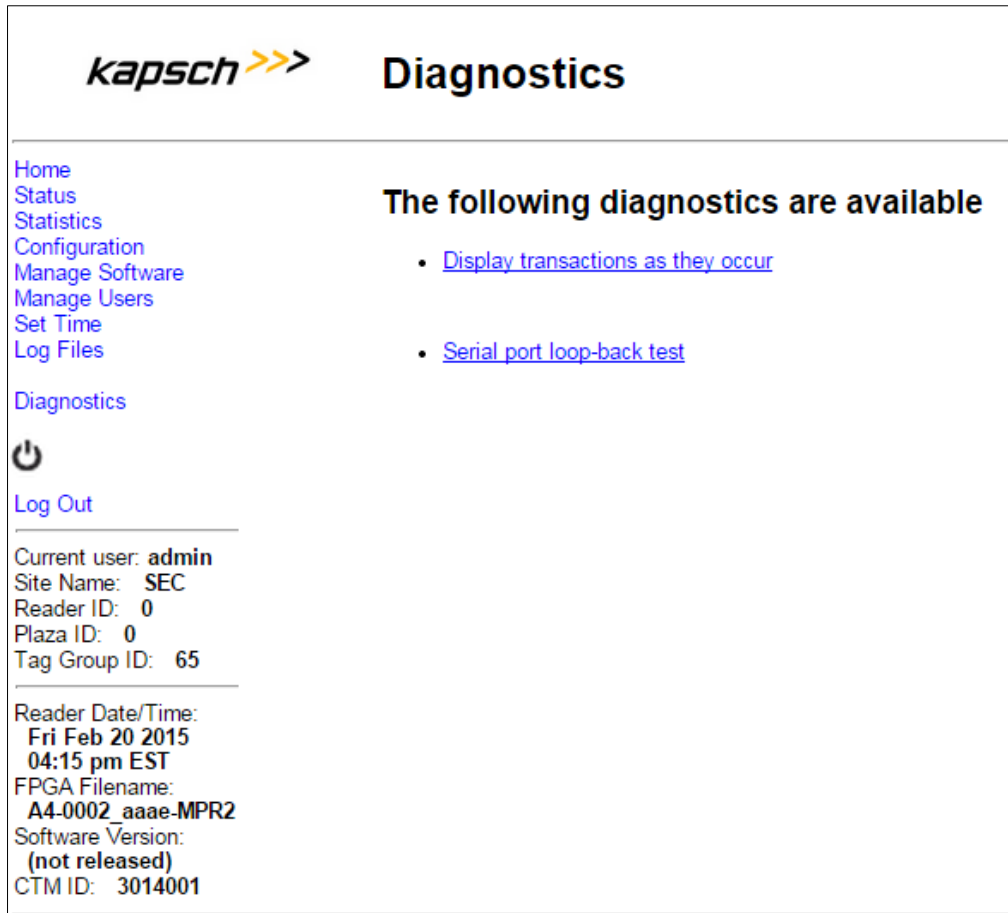

kapsch >>> Diagnostics

Home
Status
Statistics
Configuration
Manage Software
Manage Users
Set Time
Log Files
Diagnostics
Log Out

Current user: **admin**
Site Name: **SEC**
Reader ID: **0**
Plaza ID: **0**
Tag Group ID: **65**

Reader Date/Time:
Fri Feb 20 2015
04:15 pm EST
FPGA Filename:
A4-0002_aaa-MPR2
Software Version:
(not released)
CTM ID: **3014001**

The following diagnostics are available

- [Display transactions as they occur](#)
- [Serial port loop-back test](#)

4. Select the Serial port loop-back test link.

Result: The following screen appears.



Diagnostics

[Home](#)

[Status](#)

[Statistics](#)

[Configuration](#)

[Manage Software](#)

[Manage Users](#)

[Set Time](#)

[Log Files](#)

[Diagnostics](#)

 [Log Out](#)

Current user: **admin**

Site Name: **SEC**

Reader ID: **0**

Plaza ID: **0**

Tag Group ID: **65**

Serial Port Diagnostics

Test Enable/Disable:	COM1 ▾
Test Result:	N/A

NOTE: Serial diagnostic tests take approx. 3 seconds to complete. Please wait until the process has finished.

5. Select the **LPM COM** port from the **Test Enable/Disable** drop-down box.
6. Click the **Perform Test(s)** button.
Result: The test result displays.
7. If the test passes, the LPM COM port is functional.
8. If the test fails, ensure the correct loop-back connector was used, then, replace the CTM and repeat steps 4 and 6.
9. If the test fails again, record under what conditions the LPM failed.
10. Replace the LPM.
11. Return failed LPM under the RMA agreement.

Testing the Synchronization Circuit

This first part of this test checks the functionality of one Reader's SPM. The second part of this test checks the Synchronization wiring from one Reader's SPM to the synchronization circuit terminal block

Prerequisites:

- At least one RF module installed in the Reader
- Both Primary and Secondary CTMs are configured the same
- Synchronization enabled

Testing the SPM and CTM

1. Disconnect the Synchronization circuit wiring from the SPM terminal block
2. Using two short jumper wires connect Tx+ to Rx+ and Tx- to Rx- on the SPM terminal block, leaving the GND terminals unconnected (see SPM terminal block connections, page 261).
3. If the SYNC LED on both CTM's illuminates solid green, the SPM and CTM's are functioning properly.
4. Reconnect the synchronization circuit to the SPM terminal block.

Testing the Synchronization hub cabling

- If the SYNC LED on the CTM does not illuminate solid green with a functional SPM and CTM connected to the Synchronization circuit, the problem is with the wiring between the SPM and the synchronization hub terminal block.

Testing the MRFM-S slots

The following test is to verify that all MRFM-S slots in the upper portion of the Reader rack are functional.

Prerequisites: Connect the service laptop to to access the CTM web interface. Refer to Connecting a service laptop to the Reader, page 47. One functional MRFM-S is installed in the RF slot 1 of the Reader rack.

- Select the **Configuration** link on the left side panel.
- Click the **Channel** tab.

Result: The following screen appears.

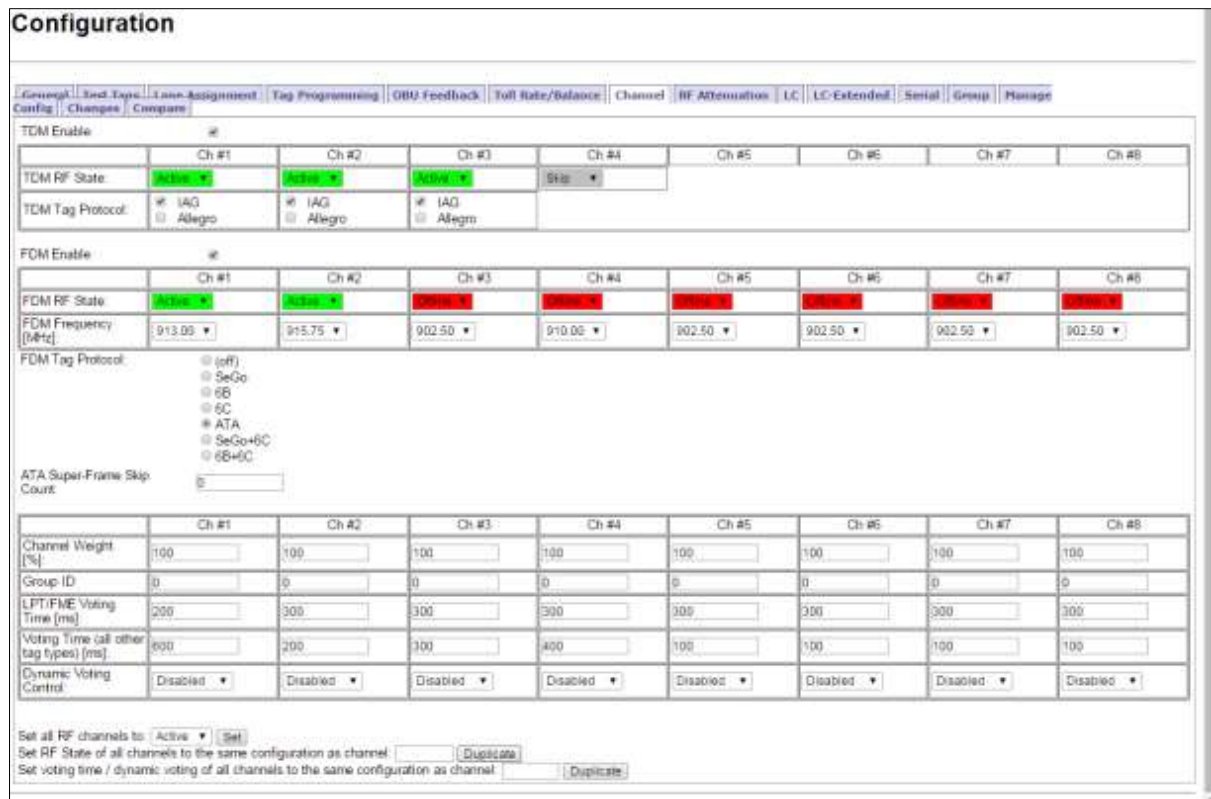

Configuration

Overview | End Type | Lane Assignment | Tag Programming | OBU Feedback | Toll Rate/Balance | Channel | RF Attenuation | LC | LC-Extended | Serial | Group | Manage

Config | Changes | Compare

TDM Enable

	Ch #1	Ch #2	Ch #3	Ch #4	Ch #5	Ch #6	Ch #7	Ch #8
TDM RF State:	Active	Active	Active	Off				
TDM Tag Protocol:	<input checked="" type="radio"/> IAG <input type="radio"/> Allegro	<input checked="" type="radio"/> IAG <input type="radio"/> Allegro	<input checked="" type="radio"/> IAG <input type="radio"/> Allegro					

FDM Enable

	Ch #1	Ch #2	Ch #3	Ch #4	Ch #5	Ch #6	Ch #7	Ch #8
FDM RF State:	Active	Active	Off	Off	Off	Off	Off	Off
FDM Frequency [MHz]:	913.05	915.75	902.50	910.05	902.50	902.50	902.50	902.50
FDM Tag Protocol:	<input type="radio"/> off <input type="radio"/> SeGo <input type="radio"/> 6B <input type="radio"/> 6C <input checked="" type="radio"/> ATA <input type="radio"/> SeGo+6C <input type="radio"/> 6B+6C							
ATA Super-Frame Skip Count:	0							

	Ch #1	Ch #2	Ch #3	Ch #4	Ch #5	Ch #6	Ch #7	Ch #8
Channel Weight [%]:	100	100	100	100	100	100	100	100
Group ID:	0	0	0	0	0	0	0	0
LPTIME Voting Time [ms]:	200	300	300	300	300	300	300	300
Voting Time (all other tag types) [ms]:	600	200	100	400	100	100	100	100
Dynamic Voting Control:	Disabled	Disabled	Disabled	Disabled	Disabled	Disabled	Disabled	Disabled

Set all RF channels to: Active | Set

Set RF State of all channels to the same configuration as channel: | Duplicate

Set voting time / dynamic voting of all channels to the same configuration as channel: | Duplicate

- Set Ch# (where the RF module is installed) to **Active**.
- Ensure that the DATA LED on the RF module illuminates solid green.
- From the **Channel** tab on the **Configuration** page, select **Offline** from the **RF State** drop-down box.

6. Ensure that the DATA LED on the RF module is off.
7. Move the RF module to the next slot and repeat steps 1 and 5.

7. MAINTENANCE PROCEDURES

**WARNING:**

THE MODULES MAY HAVE SHARP EDGES. HANDLE THE MODULES CAREFULLY. WHENEVER POSSIBLE, USE A MODULE EXTRACTION TOOL TO REMOVE A MODULE.

**CAUTION:**

Improper modification of configuration parameters may adversely affect system operation. The default values may not be appropriate for the specific application. It is the system integrator's responsibility to tailor the configuration parameters to the specific operating environment.

**CAUTION: Redundant Reader**

Both CTMs in a redundant Reader must be properly configured. Each CTM has its own browser interface and is configured independently. Ensure any configuration changes made to one CTM are applied to the other CTM, as required.

Corrective maintenance procedures

Note: When removing or installing ESD sensitive equipment always follow the accepted practices for ESD protection.

The inspect, clean and system re-test methodology is used for all system maintenance. This type of maintenance consists of the following general steps.

1. Inspect all Reader sub-system components and connections.
 - Inspect the PSM fuses; they should not appear darkened or burned.
 - Make sure that all plug-in components are properly seated in their mating connectors.

Determine if the components and/or connections require cleaning. To clean component assemblies, use a portable vacuum cleaning tool with a non-conductive tip/brush. To clean component connector contacts, use a contact cleaner spray that does not contain a trichloroethylene based solvent or a Freon® based propellant.

Attention: Pre-authorized lane closure is required if the MRFM-S modules need to be cleaned.

If cleaning is required:

2. Activate the side of the Reader not being cleaned (see Manually switching a Reader to the redundant side page 46).
3. Power down the side of the Reader to be cleaned.
4. Clean the components and connections and then Power up and activate this Reader side.
5. Power down the remaining Reader side.
6. Clean the components and connections then Power up and activate, if necessary, this Reader side.
7. Test all system functions (see Troubleshooting and Testing, page 199).

Preventive maintenance procedures and scheduling

Attention: Only Kapsch Service-trained service maintenance personnel are to perform these tasks.

Once a year:

1. Perform RF measurements to verify the cables and MRFM-S. It is recommended a commercial off-the shelf instrument is used which supports Cable Analyzer Testing, to show faults inside cables, and Voltage Network Analysis, to verify connection integrity and end to end connectivity and gain.
2. Verify module output power and power at antenna using a commercial off-the shelf spectrum analyzer.

With power off:

1. Inspect and clean the Reader cabinet as needed, depending on the site environmental conditions, such as contamination by dust. As a minimum, inspect and clean the cabinet interior and components once per year.
2. Inspect the antenna waterproofing and ensure that any seal is secure.
3. Inspect the antenna weep hole. Remove any dust, dirt or other obstructions.
4. Check ground connectivity for exterior ground connection to reader system ground

Attention: Pre-authorized lane closure is required before continuing with this procedure.

Note: For each channel, go into the web interface and disable the channel to be tested.

1. Disconnect and inspect in-line lightning suppressor.
2. Disconnect and inspect the exterior RF feedline cable and connectors exposed to the elements.
3. If corrosion is visible, replace the corroded connector and, if necessary, cut out the entire corroded portion of the feedline cable. The antenna may require replacement if the mating female connector is corroded.
4. When reconnecting connectors after inspection is complete, discard and replace self-amalgamating tape.

Every 4.5 years:

Note: The CMOS battery is not field-replaceable.

1. Replace the CTM CMOS battery.

Note: If a Kapsch TrafficCom maintenance agreement is in place, the CTM needing a new battery can be replaced by a spare CTM. The CTM is then sent to Kapsch Service to have its battery replaced.

MRFM-S replacement

The Reader does not need to be shut down to replace an MRFM-S.

Prerequisites: Connect the service laptop to the Reader configuration port to access the CTM web interface. Refer to Connecting a service laptop to the Reader, page 47.



WARNING:

THE MODULES MAY HAVE SHARP EDGES. HANDLE THE MODULES CAREFULLY. WHENEVER POSSIBLE, USE A MODULE EXTRACTION TOOL TO REMOVE A MODULE.



WARNING:

THE MRFM-S MAY BECOME HOT UNDER NORMAL OPERATING CONDITIONS. ENSURE THE MRFM-S HAS COOLED DOWN OR WEAR GLOVES WHEN HANDLING THE MRFM-S.

Removing an MRFM-S

1. Select the **Configuration** link on the left side panel of the CTM web interface.
2. Click the **Channel** tab.

Result: The following screen appears.

Configuration

General | Tool Types | Lane Assignment | Tag Programming | OBU Feedback | Toll Rate/Balance | Channel | RF Attenuation | LC | LC-Extended | Serial | Group | Manage

Config | Changes | Compare

TDM Enable

	Ch #1	Ch #2	Ch #3	Ch #4	Ch #5	Ch #6	Ch #7	Ch #8
TDM RF State	Active	Active	Active	Guard	Guard	Off		
TDM Tag Protocol	<input checked="" type="radio"/> IAG <input type="radio"/> Allegro	<input checked="" type="radio"/> IAG <input type="radio"/> Allegro	<input checked="" type="radio"/> IAG <input type="radio"/> Allegro	<input checked="" type="radio"/> IAG <input type="radio"/> Allegro	<input checked="" type="radio"/> IAG <input type="radio"/> Allegro			

FDM Enable

	Ch #1	Ch #2	Ch #3	Ch #4	Ch #5	Ch #6	Ch #7	Ch #8
FDM RF State	Active	Active	Active	Guard	Guard	Guard	Guard	Guard
FDM Frequency [MHz]	913.00	915.75	902.50	910.00	902.50	902.50	902.50	902.50
FDM Tag Protocol:	<input type="radio"/> (off) <input type="radio"/> SeGo <input checked="" type="radio"/> 6B <input type="radio"/> 6C <input type="radio"/> ATA <input type="radio"/> SeGo+6C <input type="radio"/> 6B+6C							

	Ch #1	Ch #2	Ch #3	Ch #4	Ch #5	Ch #6	Ch #7	Ch #8
Channel Weight [%]	100	50	100	100	100	100	100	100
Group ID	0	0	0	0	0	0	0	0
LPT/FME Voting Time [ms]	N/A	2000	N/A	0	N/A	0	N/A	0
Voting Time (all other tag types) [ms]	N/A	8000	N/A	0	N/A	0	N/A	0
Dynamic Voting Control	N/A	Disabled	N/A	Disabled	N/A	Disabled	N/A	Disabled
Dynamic Voting Sample Size	N/A		N/A		N/A		N/A	

Set all RF channels to: Active | Sat

Set RF State of all channels to the same configuration as channel: Duplicate

Set voting time / dynamic voting of all channels to the same configuration as channel: Duplicate

- From the **Channel** tab on the **Configuration** page, set the **TDM** and **FDM RF State** of the active MRFM-S to **Offline**.

Result: The following screen appears.

Configuration

[General](#) | [Ext. Tags](#) | [Lane Assignment](#) | [Tag Programming](#) | [DBI Feedback](#) | [Toll Rate/Balance](#) | **Channel** | [RF Attenuation](#) | [LC](#) | [LC-Extended](#) | [Serial](#) | [Snap](#) | [Manage](#)
[Config](#) | [Changes](#) | [Compare](#)

TDM Enable:

	Ch #1	Ch #2	Ch #3	Ch #4	Ch #5	Ch #6	Ch #7	Ch #8
TDM RF State	Active	Active	Active	Active	Active	Stop		

FDM Enable:

	Ch #1	Ch #2	Ch #3	Ch #4	Ch #5	Ch #6	Ch #7	Ch #8
FDM RF State	Active	Active	Active	Active	Active	Active	Active	Active
FDM Frequency [MHz]	913.00	915.75	902.50	910.05	902.50	902.50	902.50	902.50

FDM Tag Protocol:

- (off)
- SeCo
- SB
- SC
- ATA
- SeCo+SC
- SB+SC

	Ch #1	Ch #2	Ch #3	Ch #4	Ch #5	Ch #6	Ch #7	Ch #8
Channel Weight [%]	100	50	100	100	100	100	100	100
Group ID	0	0	0	0	0	0	0	0
LPT/FME Voting Time [ms]	2000	3000	0	0	0	0	0	0
Voting Time (all other tag types) [ms]	6000	2000	0	0	0	0	0	0
Dynamic Voting Control	Disabled	Disabled	Disabled	Disabled	Disabled	Disabled	Disabled	Disabled

Set all RF channels to: Active | Stop
 Set RF State of all channels to the same configuration as channel: Duplicate
 Set voting time / dynamic voting of all channels to the same configuration as channel: Duplicate

Note: Disconnect the RF cable(s) from the MRFM-S appropriate port.

- Loosen the screws securing the MRFM-S module to the Reader rack, and then remove the MRFM-S from the Reader.

Installing an MRFM-S

CAUTION:

To avoid damaging the modules, ensure that the connector on the module is properly aligned with the connector on the DSM back plane before the module is securely plugged into the DSM.

- Insert the MRFM-S module into the Reader. Tighten the screws to secure the MRFM-S to the Reader rack.
- Connect the RF cable(s) to the MRFM-S appropriate port and tighten with a proper torque wrench.
- Select the **Configuration** link on the left side panel of the CTM web interface.
- Click the **Channel** tab.

Result: The following screen appears.

Configuration

[General](#) | [Ext. Tags](#) | [Lane Assignment](#) | [Tag Programming](#) | [OBU Feedback](#) | [Full Rate/Balance](#) | **Channel** | [RF Attenuation](#) | [LC](#) | [LC-Extended](#) | [Serial](#) | [Group](#) | [Manage](#)
[Config](#) | [Changes](#) | [Compare](#)

TDM Enable: #

	Ch #1	Ch #2	Ch #3	Ch #4	Ch #5	Ch #6	Ch #7	Ch #8
TDM RF State:	Offline	Offline	Offline	Offline	Offline	Offline	Offline	Offline

FDM Enable: #

	Ch #1	Ch #2	Ch #3	Ch #4	Ch #5	Ch #6	Ch #7	Ch #8
FDM RF State:	Offline	Offline	Offline	Offline	Offline	Offline	Offline	Offline
FDM Frequency [MHz]:	913.00	915.75	902.50	910.00	902.50	902.50	902.50	902.50

FDM Tag Protocol:

(off)
 SeCo
 SB
 SC
 ATA
 SeGo+SC
 SB+SC

	Ch #1	Ch #2	Ch #3	Ch #4	Ch #5	Ch #6	Ch #7	Ch #8
Channel Weight [%]:	100	50	100	100	100	100	100	100
Group ID:	0	0	0	0	0	0	0	0
LPT/FME Voting Time [ms]:	2000	3000	0	0	0	0	0	0
Voting Time (all other tag types) [ms]:	6000	2000	0	0	0	0	0	0
Dynamic Voting Control:	Disabled	Disabled	Disabled	Disabled	Disabled	Disabled	Disabled	Disabled

Set all RF channels to: Active | Set
 Set RF State of all channels to the same configuration as channel: Duplicate
 Set voting time / dynamic voting of all channels to the same configuration as channel: Duplicate

- Set the **TDM** and **FDM RF State** of the **Offline** MRFM-S channels back to **Active**.
- Verify the DATA LED illuminates solid green.
 Note: If the DATA LED does not illuminate solid green, see Troubleshooting tree: MRFM-S not working, page 207.
- Verify module output power and power at antenna using a commercial off-the-shelf spectrum analyzer.
- Ensure the RF channel is capturing OBU data (see Troubleshooting tree: MRFM-S not working page 207).

Antenna replacement

Note: The Reader does not need shutting down to replace an antenna.

Prerequisites: Connect the service laptop to the Reader configuration port to access the CTM web interface. Refer to Connecting a service laptop to the Reader, page 47.

Removing an antenna

- Select the **Configuration** link on the left side panel of the CTM web interface.
- Click the **Channel** tab.

Result: The following screen appears.

Configuration

General | Tool Tips | Lane Assignment | Tag Programming | OBU Feedback | Toll Rate/Balance | Channel | RF Attenuation | LC | LC Extended | Serial | Group | Manage

Config | Changes | Compare

TDM Enable

	Ch #1	Ch #2	Ch #3	Ch #4	Ch #5	Ch #6	Ch #7	Ch #8
TDM RF State	Active	Active	Active	Guard	Guard	Spa		
TDM Tag Protocol	# IAG <input type="checkbox"/> Alegre	# IAG <input type="checkbox"/> Alegre	# IAG <input type="checkbox"/> Alegre	# IAG <input type="checkbox"/> Alegre	# IAG <input type="checkbox"/> Alegre			

FDM Enable

	Ch #1	Ch #2	Ch #3	Ch #4	Ch #5	Ch #6	Ch #7	Ch #8
FDM RF State	Active	Active	Active	Guard	Guard	Guard	Guard	Guard
FDM Frequency [MHz]	913.00	915.75	902.50	910.00	902.50	902.50	902.50	902.50
FDM Tag Protocol:	<input type="radio"/> (off) <input type="radio"/> SeGo <input checked="" type="radio"/> 6B <input type="radio"/> 6C <input type="radio"/> ATA <input type="radio"/> SeGo+6C <input type="radio"/> 6B+6C							

	Ch #1	Ch #2	Ch #3	Ch #4	Ch #5	Ch #6	Ch #7	Ch #8
Channel Weight (%)	100	50	100	100	100	100	100	100
Group ID	0	0	0	0	0	0	0	0
LPT/FM/E Voting Time [ms]	N/A	2000	N/A	0	N/A	0	N/A	0
Voting Time (all other tag types) [ms]	N/A	8000	N/A	0	N/A	0	N/A	0
Dynamic Voting Control	N/A	Disabled	N/A	Disabled	N/A	Disabled	N/A	Disabled
Dynamic Voting Sample Size	N/A		N/A		N/A		N/A	

Set all RF channels to: Active | Sat

Set RF State of all channels to the same configuration as channel: | Duplicate

Set voting time / dynamic voting of all channels to the same configuration as channel: | Duplicate

3. Set the **TDM** and **FDM RF State** of the MRFM-S connected to the antenna to **Offline**.
4. Remove the antenna.

Installing an antenna

1. Install the antenna (see Installing an Antenna, page 169).
2. Select the **Configuration** link on the left side panel of the CTM web interface.
3. Click the **Channel** tab.

Result: The following screen appears.

Configuration

[General](#) | [Ext. Tags](#) | [Lane Assignment](#) | [Tag Programming](#) | [OBU Feedback](#) | [Toll Rate/Balance](#) | **Channel** | [RF Attenuation](#) | [LC](#) | [LC-Extended](#) | [Serial](#) | [Group](#) | [Manage](#)
[Config](#) | [Changes](#) | [Compare](#)

TDM Enable: #

	Ch #1	Ch #2	Ch #3	Ch #4	Ch #5	Ch #6	Ch #7	Ch #8
TDM RF State:	Offline	Offline	Offline	Offline	Offline	Offline	Offline	Offline

FDM Enable: #

	Ch #1	Ch #2	Ch #3	Ch #4	Ch #5	Ch #6	Ch #7	Ch #8
FDM RF State:	Offline	Offline	Offline	Offline	Offline	Offline	Offline	Offline
FDM Frequency [MHz]:	913.00	915.75	902.50	910.00	902.50	902.50	902.50	902.50

FDM Tag Protocol:

(off)
 SeCo
 SB
 SC
 ATA
 SeGo+SC
 SB+SC

	Ch #1	Ch #2	Ch #3	Ch #4	Ch #5	Ch #6	Ch #7	Ch #8
Channel Weight [%]:	100	50	100	100	100	100	100	100
Group ID:	0	0	0	0	0	0	0	0
LPT/FME Voting Time [ms]:	2000	3000	0	0	0	0	0	0
Voting Time (all other tag types) [ms]:	6000	2000	0	0	0	0	0	0
Dynamic Voting Control:	Disabled	Disabled	Disabled	Disabled	Disabled	Disabled	Disabled	Disabled

Set all RF channels to: Active | Set
 Set RF State of all channels to the same configuration as channel: Duplicate
 Set voting time / dynamic voting of all channels to the same configuration as channel: Duplicate

4. Set the **Offline MRFM-S TDM** and **FDM RF State** back to **Active**.
5. Verify the DATA LED illuminates solid green.
6. Verify module output powers and power at antenna using a commercial off-the shelf spectrum analyzer .
7. Ensure the MRFM-S is capturing OBU data (see Monitoring OBU transactions as they occur via the Diagnostics page, page 65).

RF cable or connector replacement

Note: The Reader does not need shutting down to replace an RF cable or connector.

Prerequisites: Connect the service laptop to the Reader configuration port to access the CTM web interface.

Removing RF cable/connector

1. Select the **Configuration** link on the left side panel.
2. Click the **Channel** tab.

Result: The following screen appears.

Configuration

General | Tool Tips | Lane Assignment | Tag Programming | OBU Feedback | Toll Rate/Balance | Channel | RF Attenuation | LC | LC Extended | Serial | Group | Manage

Config | Changes | Compare

TDM Enable

	Ch #1	Ch #2	Ch #3	Ch #4	Ch #5	Ch #6	Ch #7	Ch #8
TDM RF State	Active	Active	Active	Guard	Guard	Off		
TDM Tag Protocol	IAG <input type="checkbox"/> Alegre	IAG <input type="checkbox"/> Alegre	IAG <input type="checkbox"/> Alegre	IAG <input type="checkbox"/> Alegre	IAG <input type="checkbox"/> Alegre			

FDM Enable

	Ch #1	Ch #2	Ch #3	Ch #4	Ch #5	Ch #6	Ch #7	Ch #8
FDM RF State	Active	Active	Active	Guard	Guard	Guard	Guard	Guard
FDM Frequency [MHz]	913.00	915.75	902.50	910.00	902.50	902.50	902.50	902.50
FDM Tag Protocol:	<input type="radio"/> (off) <input type="radio"/> SeGo <input checked="" type="radio"/> 6B <input type="radio"/> 6C <input type="radio"/> ATA <input type="radio"/> SeGo+6C <input type="radio"/> 6B+6C							

	Ch #1	Ch #2	Ch #3	Ch #4	Ch #5	Ch #6	Ch #7	Ch #8
Channel Weight (%)	100	50	100	100	100	100	100	100
Group ID	0	0	0	0	0	0	0	0
LPT/FM/E Voting Time [ms]	N/A	2000	N/A	0	N/A	0	N/A	0
Voting Time (all other tag types) [ms]	N/A	8000	N/A	0	N/A	0	N/A	0
Dynamic Voting Control	N/A	Disabled	N/A	Disabled	N/A	Disabled	N/A	Disabled
Dynamic Voting Sample Size	N/A		N/A		N/A		N/A	

Set all RF channels to: Active | Sat

Set RF State of all channels to the same configuration as channel: Duplicate

Set voting time / dynamic voting of all channels to the same configuration as channel: Duplicate

3. Set the **RF State** of the MRFM-S whose cable or connector is being replaced to **Offline**.
4. Remove the RF cables or connectors.

Installing an RF cable/connector

Prerequisites: Self-amalgamating tape for connections. Connect the service laptop to the Reader configuration port to access the CTM web interface. Refer to Connecting a service laptop to the Reader, page 47.

1. Install the RF cables or connectors.
2. Apply new self-amalgamating tape to the connections.
3. Select the **Configuration** link on the left side panel of the CTM web interface.
4. Click the **Channel** tab.

Result: The following screen appears.

Configuration

General | Test Tags | Lane Assignment | Tag Programming | OBU Feedback | Toll Rate/Balance | Channel | RF Attenuation | LC | LC-Extended | Serial | Group | Manage
 Config | Changes | Compare

TDM Enable:

	Ch #1	Ch #2	Ch #3	Ch #4	Ch #5	Ch #6	Ch #7	Ch #8
TDM RF State:	Offline	Active	Active	Guard	Guard	Ship		
TDM Tag Protocol:		<input checked="" type="checkbox"/> IAG <input type="checkbox"/> Allegro	<input checked="" type="checkbox"/> IAG <input type="checkbox"/> Allegro	<input checked="" type="checkbox"/> IAG <input type="checkbox"/> Allegro	<input checked="" type="checkbox"/> IAG <input type="checkbox"/> Allegro			

FDM Enable:

	Ch #1	Ch #2	Ch #3	Ch #4	Ch #5	Ch #6	Ch #7	Ch #8
FDM RF State:	Offline	Active	Active	Guard	Guard	Guard	Guard	Guard
FDM Frequency [kHz]:	913.00	915.75	902.50	910.00	902.50	902.50	902.50	902.50
FDM Tag Protocol:	<input type="radio"/> Ioff <input type="radio"/> SeGo <input checked="" type="radio"/> 6B <input type="radio"/> 6C <input type="radio"/> ATA <input type="radio"/> SeGo+6C <input type="radio"/> 6B+6C							

	Ch #1	Ch #2	Ch #3	Ch #4	Ch #5	Ch #6	Ch #7	Ch #8
Channel Weight [%]	100	50	100	100	100	100	100	100
Group ID:	0	0	0	0	0	0	N/A	0
LPT/FINE Voting Time [ms]:	N/A	2000	N/A	0	N/A	0	N/A	0
Voting Time (all other tag types) [ms]:	N/A	5000	N/A	0	N/A	0	N/A	0
Dynamic Voting Control:	N/A	Disabled	N/A	Disabled	N/A	Disabled	N/A	Disabled
Dynamic Voting Sample Size:	N/A		N/A		N/A		N/A	

Set all RF channels to: Active [Set]
 Set RF State of all channels to the same configuration as channel: [] Duplicate
 Set voting time / dynamic voting of all channels to the same configuration as channel: [] Duplicate

5. Set the **Offline MRFM-S RF State** back to **Active**.
6. Verify that the DATA LED illuminates solid green.
7. Verify module output powers and power at antenna using a commercial off-the shelf spectrum analyzer.
8. Ensure the MRFM-S is capturing OBU data (see Monitoring OBU transactions as they occur via the Diagnostics page, page 65).

CTM replacement

WARNING:



THE MODULES MAY HAVE SHARP EDGES. HANDLE THE MODULES CAREFULLY. WHENEVER POSSIBLE, USE A MODULE EXTRACTION TOOL TO REMOVE A MODULE.

**CAUTION:**

Removing a powered CTM from the Reader rack can damage the CTM. Before removing a CTM from the Reader, ensure that power on the affected side of the Reader is turned off, i.e. the power switch on the PSM is in the off position, or the PSM AC input power cord is disconnected.

Removing a CTM

1. Switch the Reader over to the side with the CTM that is **not** being replaced (see Manually switching a Reader to the redundant side, page 46).
2. Set the PSM powering the CTM being replaced to the **off** position.
3. Label and then disconnect any communication cables connected to the CTM.
4. Remove the faulty CTM from the Reader rack.

Installing a CTM**CAUTION:**

To avoid damaging the modules, ensure that the connector on the module is properly aligned with the connector on the DSM back plane before the module is securely plugged into the DSM.

1. Install a new CTM in the Reader Rack.
2. Reconnect the communication cables to the CTM.
3. Set the PSM and CTM to the **on** position.
4. Switch the Reader to the new CTM side (see Manually switching a Reader to the redundant side, page 46).
5. If the CTM is in an IR network, reboot the CTM (see Rebooting the CTM, page 235).

SPM replacement

WARNING:



THE MODULES MAY HAVE SHARP EDGES. HANDLE THE MODULES CAREFULLY. WHENEVER POSSIBLE, USE A MODULE EXTRACTION TOOL TO REMOVE A MODULE.

Removing an SPM

1. Without disconnecting any of the sync wiring from the SPM terminal block, disconnect the SPM terminal block from the SPM.
2. Remove the SPM from the Reader rack.

Installing an SPM

CAUTION:



To avoid damaging the modules, ensure that the connector on the module is properly aligned with the connector on the DSM back plane before the module is securely plugged into the DSM.

1. Install a new SPM in the Reader Rack.
2. Reconnect the SPM terminal block.
3. Test the SPM (see Testing the Synchronization Circuit, page 217).

LPM replacement

WARNING:



THE MODULES MAY HAVE SHARP EDGES. HANDLE THE MODULES CAREFULLY. WHENEVER POSSIBLE, USE A MODULE EXTRACTION TOOL TO REMOVE A MODULE.

Removing an LPM

1. Switch the Reader over to the side with the LPM that is not being replaced (see Manually switching a Reader to the redundant side, page 46).
2. Remove the faulty LPM from the Reader rack.

Installing an LPM

1. Install a new LPM in the Reader rack.
2. Switch the Reader back over to the new LPM side (see Manually switching a Reader to the redundant side, page 46).
3. Test all the LPM COM ports (see Testing an LPM COM port, page 217).

PSM replacement

WARNING:



THE MODULES MAY HAVE SHARP EDGES. HANDLE THE MODULES CAREFULLY. WHENEVER POSSIBLE, USE A MODULE EXTRACTION TOOL TO REMOVE A MODULE.

WARNING:



THE PSM MAY BECOME HOT UNDER NORMAL OPERATING CONDITIONS. ENSURE THE PSM HAS COOLED DOWN OR WEAR GLOVES WHEN HANDLING THE PSM.

WARNING:



EXPOSED HIGH VOLTAGE IS PRESENT IN THE PSM. ENSURE THAT THE POWER SWITCH IS SET TO THE OFF POSITION AND THAT THE AC INPUT POWER CORD IS DISCONNECTED BEFORE REMOVING THE PSM.

Removing a PSM

1. Switch the Reader over to the side with the PSM that is not being replaced (see Manually switching a Reader to the redundant side, page 46).
2. Set the PSM power switch to the off position.
3. Remove the faulty PSM from the Reader rack.

Installing a PSM**CAUTION:**

To avoid damaging the modules, ensure that the connector on the module properly aligns with the connector on the DSM back plane before the module is securely plugged into the DSM.

1. Install a new PSM in the Reader Rack.
2. Set the power switch of the new PSM to the on position.
3. Ensure that the new PSM +5 and +15 LEDs illuminate solid green.
4. Switch the Reader back over to the new PSM side (see Manually switching a Reader to the redundant side, page 39).

CFM replacement**WARNING:**

THE MODULES MAY HAVE SHARP EDGES. HANDLE THE MODULES CAREFULLY. WHENEVER POSSIBLE, USE A MODULE EXTRACTION TOOL TO REMOVE A MODULE.

Removing a CFM

1. If possible, save the configuration file of the CFM being replaced (see Saving the Reader configuration, page 246).
2. Remove the CTM on the side of the faulty CFM (see CTM, page 229).
3. While pushing on plastic clips, pull CFM straight out from DSM.

Installing a CFM

1. Push CFM straight into connector on DSM until an audible click is heard.
2. Install the CTM removed in step 2 (see CTM, page 229).
3. Load the configuration file saved in step 1 to the new CFM (see Uploading a saved configuration, page 246), or locate and upload the latest saved Reader configuration.

Replacing a PSM fuse

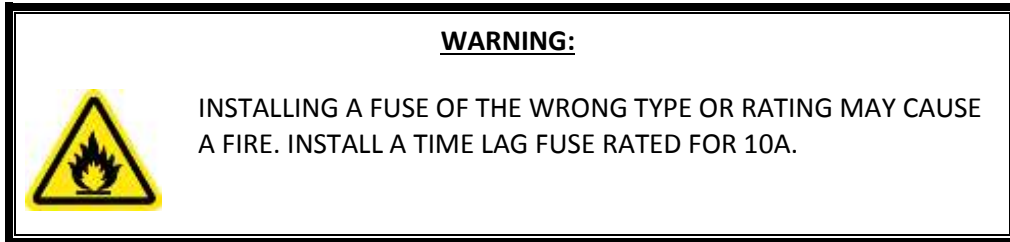

1. Set the PSM power switch to the off position.
2. Disconnect the AC power cord.
3. Using a flat-tipped screwdriver, rotate the fuse holder counter-clockwise 180 degrees. Slide out the fuse holder as shown in Figure 7-1.

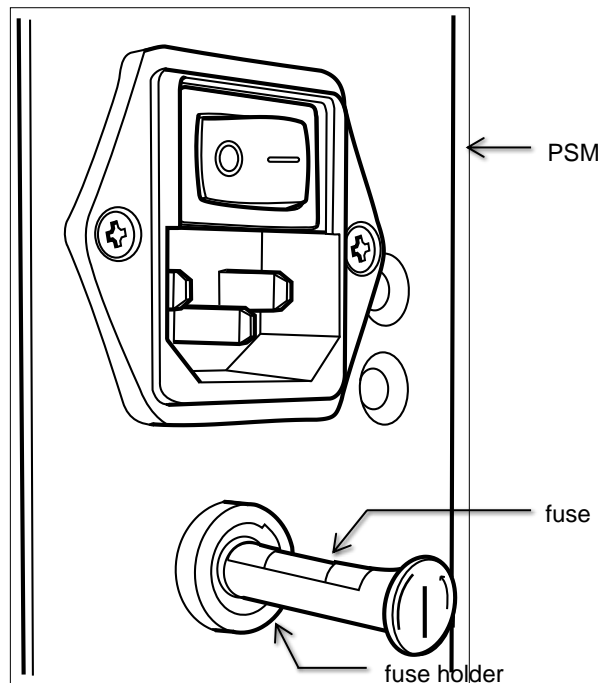

Figure 7-1: PSM fuse and fuse holder

4. Rotate the fuse holder clockwise to allow the old fuse to fall free of the fuse holder.
5. Place the new fuse in the fuse holder then slide the fuse holder into the PSM.
6. Using a flat-tipped screwdriver, rotate the fuse holder 180 degrees to secure the fuse holder in the PSM.

Rebooting the CTM

This procedure outlines two ways of rebooting the CTM; using the ON/OFF switch on the CTM, and using the Reboot button from the CTM web interface.

Prerequisites: To reboot from the browser interface, you must have Software Management permissions.

Rebooting using CTM ON/OFF switch

1. Set the CTM ON/OFF switch to OFF.
2. After five seconds, set the CTM ON/OFF switch back to ON. The CTM POWER LEDs immediately illuminate solid green. After 90 – 120 sec., the CTM STATUS LEDs illuminate their normal state (see LED Status, page 201).

Rebooting from the browser interface

1. Login to the CTM web Interface.
Result: The following Home page appears.

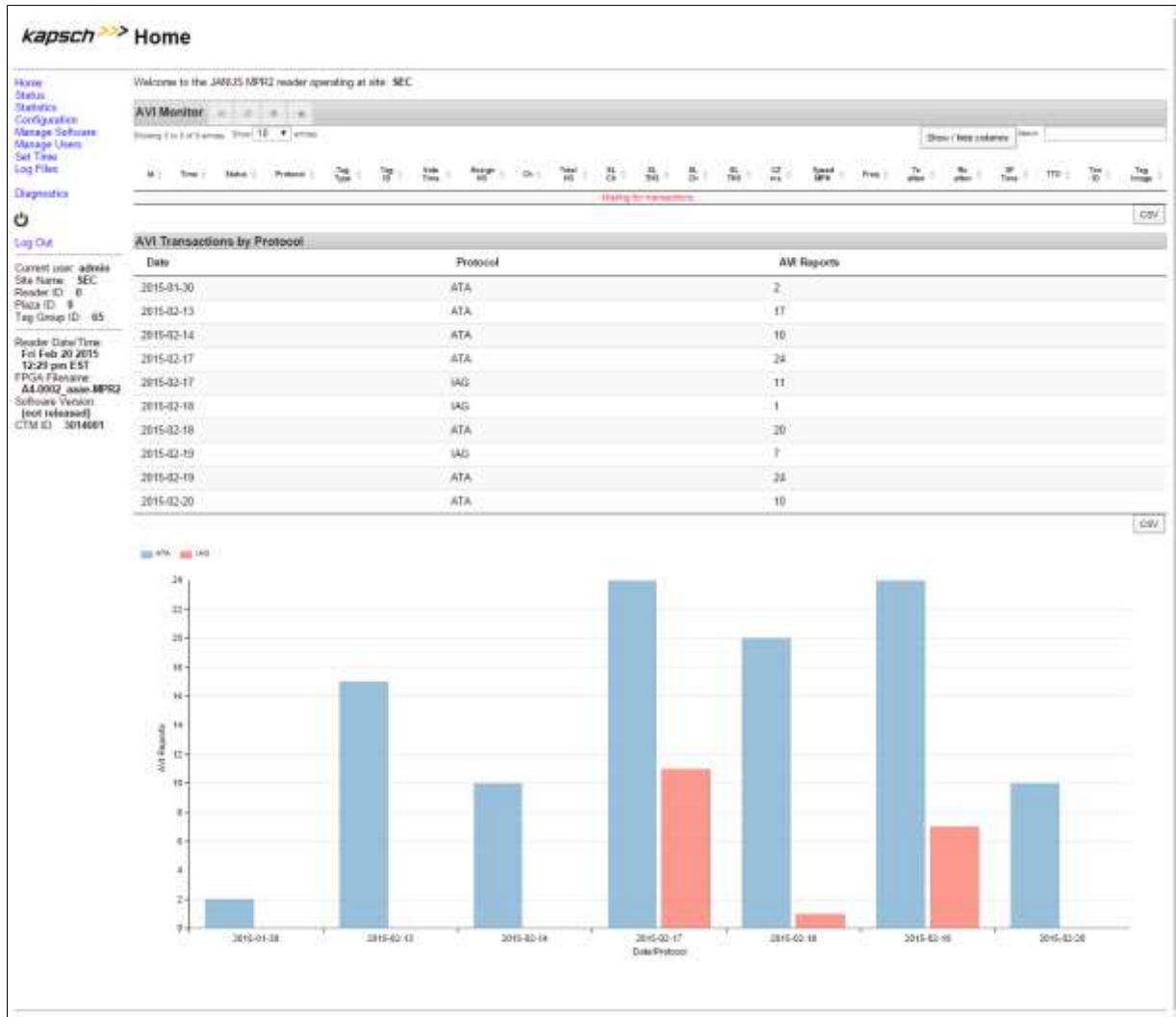

2. Select the **Manage Software** link on the left side panel of the CTM web interface.

Result: The following screen appears.

Software Update

Upload Software Updates:

Filename: No file chosen

Activate Software Updates:

The software update files currently occupy 77% of the maximum allocated space.
Space remaining: 4.24 MB

Available Firmware Versions	Status	Actions
2014jan28a-MPR2.en.sign	FACTORY, INACTIVE	<input type="button" value="Activate"/>
2014nov28a-MPR2.en.sign	INACTIVE	<input type="button" value="Activate"/> <input type="button" value="Delete"/>
2015jan08a-MPR2.en.sign	INACTIVE	<input type="button" value="Activate"/> <input type="button" value="Delete"/>
2015jan29a-MPR2.en.sign	ACTIVE	

Software Update History:

2014-12-16T15:11:16	2014nov28a-MPR2.en.sign
2015-01-06T09:32:09	2015jan06a-MPR2.en.sign
2015-01-14T16:02:48	2014jan28a-MPR2.en.sign
2015-01-15T11:00:25	2015jan08a-MPR2.en.sign
2015-01-29T16:53:17	2015jan29a-MPR2.en.sign
2015-02-12T16:52:32	2015jan08a-MPR2.en.sign
2015-02-12T16:54:40	2015jan29a-MPR2.en.sign

Reboot Reader:

3. Click the **Reboot** button

Configuring events that cause a switchover

Redundant Readers need to be configured in order to:

- Determine whether the Reader switches over when there is a failure
- Determine what failures cause a switchover
- Determine if the Reader switches back to the primary side once a failure has cleared.

Prerequisites: The primary and secondary sides are both powered up. You must have Advanced User permissions to configure redundancy settings in the browser interface.

Manually select the active side and disable switchover**CAUTION:**

If the primary or secondary side is forced active via the SPM redundancy mode switch and that side fails, the Reader will not switch to the other side and data could be lost.

1. Set the toggle switch on the SPM to the side to stay active, either SECONDARY or PRIMARY.
Result: This side is now active and no switchover will occur unless a failure occurs.

Letting the Reader automatically choose the active side

1. Set the SPM toggle switch to **AUTO**.
Result: The primary side is now active by default, until a primary failure occurs.

Enabling the Reader to recover automatically to the primary side

1. Select the Auto Recovery to Prime check box then click the **Update General Configuration** button.
Result: The Reader will now automatically switch back to the primary side once a primary failure has cleared.

Configuring the Reader to switch over automatically when an LC link is down

1. Select the **Configuration** link on the left side panel.
2. Click the **LC** tab.

Result: The following screen appears.

Configuration

[General](#) | [Test Tags](#) | [Lane Assignment](#) | [Tag Programming](#) | [OBU Feedback](#) | [Toll Rate/Balance](#) | [Channel](#) | [RF Attenuation](#) | [LC](#) | [LC-Extended](#) | [Serial](#) | [Group](#) | [Manage](#)
[Config](#) | [Changes](#) | [Compare](#)

Allow Remote LC Configuration:
 Status Message Buffering:
 LC Ethernet TCP-socket Local Port:
 LC Ethernet TCP-socket Timeout [ms]:

Heartbeat Message:
 Send Heartbeat Messages:
 Heartbeat Interval [sec]:

Reporting Formats:
 Use RFP-Compliant Message Format:
 Toll Rate / Balance Adjustment Tag Report Format: IAG Standard Format
 ISO 18000-6B Transponder Data Format: Standard UID

Reporting:

	IAG	6B	6C	Alegro	ATA	SeGo
Writing Report	<input checked="" type="checkbox"/>	<input type="checkbox"/>	<input type="checkbox"/>	<input type="checkbox"/>	<input checked="" type="checkbox"/>	<input checked="" type="checkbox"/>
Generate Initial Report	<input type="checkbox"/>	<input type="checkbox"/>	<input type="checkbox"/>	<input type="checkbox"/>	<input type="checkbox"/>	<input type="checkbox"/>
Raw Handshake Report	<input type="checkbox"/>	<input type="checkbox"/>	<input type="checkbox"/>	<input type="checkbox"/>	<input type="checkbox"/>	<input type="checkbox"/>
Generate Post-Capture-Zone Report	<input type="checkbox"/>	<input type="checkbox"/>	<input type="checkbox"/>	<input type="checkbox"/>	<input type="checkbox"/>	<input type="checkbox"/>
Generate Estimated-Vehicle-Speed Report	<input type="checkbox"/>	<input type="checkbox"/>	<input type="checkbox"/>	<input type="checkbox"/>	<input type="checkbox"/>	<input type="checkbox"/>

	Ch #1	Ch #2	Ch #3	Ch #4	Ch #5	Ch #6	Ch #7	Ch #8	
Destination	<input type="checkbox"/> Serial <input checked="" type="checkbox"/> Ethernet <input type="checkbox"/> Dual Ethernet <input type="checkbox"/> Tertiary Ethernet	<input type="checkbox"/> Serial <input checked="" type="checkbox"/> Ethernet <input type="checkbox"/> Dual Ethernet <input type="checkbox"/> Tertiary Ethernet	<input type="checkbox"/> Serial <input checked="" type="checkbox"/> Ethernet <input type="checkbox"/> Dual Ethernet <input type="checkbox"/> Tertiary Ethernet	<input type="checkbox"/> Serial <input checked="" type="checkbox"/> Ethernet <input type="checkbox"/> Dual Ethernet <input type="checkbox"/> Tertiary Ethernet	<input type="checkbox"/> Serial <input checked="" type="checkbox"/> Ethernet <input type="checkbox"/> Dual Ethernet <input type="checkbox"/> Tertiary Ethernet	<input type="checkbox"/> Serial <input checked="" type="checkbox"/> Ethernet <input type="checkbox"/> Dual Ethernet <input type="checkbox"/> Tertiary Ethernet	<input type="checkbox"/> Serial <input checked="" type="checkbox"/> Ethernet <input type="checkbox"/> Dual Ethernet <input type="checkbox"/> Tertiary Ethernet	<input type="checkbox"/> Serial <input checked="" type="checkbox"/> Ethernet <input type="checkbox"/> Dual Ethernet <input type="checkbox"/> Tertiary Ethernet	<input type="checkbox"/> Serial <input checked="" type="checkbox"/> Ethernet <input type="checkbox"/> Dual Ethernet <input type="checkbox"/> Tertiary Ethernet
Destination IP Address:	148.198.225.115 Port: 8889	148.198.225.115 Port: 8889	148.198.225.115 Port: 8889	148.198.225.115 Port: 8889	148.198.225.115 Port: 8889				

Set destination IP addresses of all LCs to be same as

3. Ensure that LC communications is configured, that is, the appropriate **Ethernet** and **Serial** selections are made in the **Destinations** field.
4. Select the **Send Heartbeat messages** check box to enable sending heartbeat messaging, as required.
5. Enter a time, in seconds, in the **Heartbeat Interval** field. This number must be lower than the LC communication error threshold.
6. Click the **General** tab.

Result: The following screen appears.

Configuration	
General Tag Types License Assignment Tag Programming OBU Feedback Toll Rate/Balance Channel RF Attenuation LC LC-Extended Serial Group Message Config Changes Compare	
Site Name:	SEC
Ethernet 1 (LC 1Gbps) IP Address:	148.198.225.198
Ethernet 1 (LC 1Gbps) Subnet Mask:	255.255.0.0
Ethernet 2 (IRIF 100Mbps) IP Address:	192.168.0.51
Reader IP Address:	10.0.0.50
USB Adapter or Bluetooth IP Address:	192.168.2.50
Default Gateway IP:	0.0.0.0
Suppress Non-ICG Tags:	<input checked="" type="checkbox"/>
Diagnostics Port Baud Rate:	115200
Reader configuration Auto-backup & Recovery:	<input checked="" type="checkbox"/>
Reader Sync:	
Enable Reader Sync:	<input checked="" type="checkbox"/>
Superframe Sync Skip:	<input type="radio"/> Sync to every superframe <input checked="" type="radio"/> Sync to every other superframe
Add 2 Dummy Frames:	<input checked="" type="radio"/> No <input type="radio"/> Yes
Type Of Reader Syncing To:	Janus
Report Latency by Tag Type:	
0 - Interior FPT Delay [ms]:	0
1 - Exterior FPT Delay [ms]:	0
2 - Exterior LPT Delay [ms]:	0
3 - LCD Display Delay [ms]:	0
4 - Commercial Vehicle (CVI) Delay [ms]:	0
5 - OBU Feedback Tag Delay [ms]:	0
6 - HOT Tag Delay [ms]:	0
Primary/Secondary:	
Redundant Mode:	<input checked="" type="checkbox"/>
Dual Reporting Mode:	<input type="checkbox"/>
Auto Recovery To Prime:	<input checked="" type="checkbox"/>
Switchover on Serial Link Down:	<input type="checkbox"/>
Switchover on Ethernet LC Link Down:	<input type="checkbox"/>
Reader Statistics:	
Use database:	<input checked="" type="checkbox"/>
Database (Trans) Maximum records:	10000
Database (Summary) Retention period [7-90 days]:	30
Database (Summary) Interval [1-30 minutes]:	15
Dashboard:	
Transaction Summary dashboard:	<input checked="" type="checkbox"/>

- Select the Switchover on Serial Link Down and/or Switchover on Ethernet LC Link Down check box, as required.

Note: When setting the LC Retry Timeout, consider the baud rate used to communicate with the LC and the processing speed of the LC to avoid false failure reports.

- If **Switchover on Serial Link Down** is enabled, from the **Serial** tab on the **Configuration** page, enter a time, in milliseconds, in the **LC Retry Timeout** field. If an LC does not respond within this time, the Reader will consider serial communications to the LC to be down and will trigger a switchover if the SPM redundancy mode switch is in **AUTO**.
- If **Switchover on Ethernet LC Link Down** is enabled, enter a time, in milliseconds, in the **LC Ethernet TCP-socket Timeout** text box. If an LC does not respond within this time, the Reader will consider Ethernet communications to the LC to be down and could trigger a switchover if the SPM redundancy mode switch is in **AUTO**.

Configuring the Reader to switch over when the Ethernet IR link is down

Prerequisites: Multiple Reader communication method set to Ethernet in the Lane Assignment tab of the Configuration page.

1. Select the **Configuration** link on the left side panel.
2. Click the **General** tab.
3. Select the Switchover on Ethernet IRIF Link Down check box.
4. From the **Lane assignment** tab on the **Configuration** page, enter an **IRIF timeout**, in milliseconds, in the **IRIF** text box.

Result: The Reader now continuously checks the IRIF link and switches over whenever a downed Ethernet IRIF link is detected.

Configuring the Reader to switchover based on Test tag feedback (if present)

Note: Test tags are used to continuously check and confirm the operation of the antennas.

1. Select the **Configuration** link on the left side panel.
2. Click the **Test Tags** tab.

Result: The following screen appears.

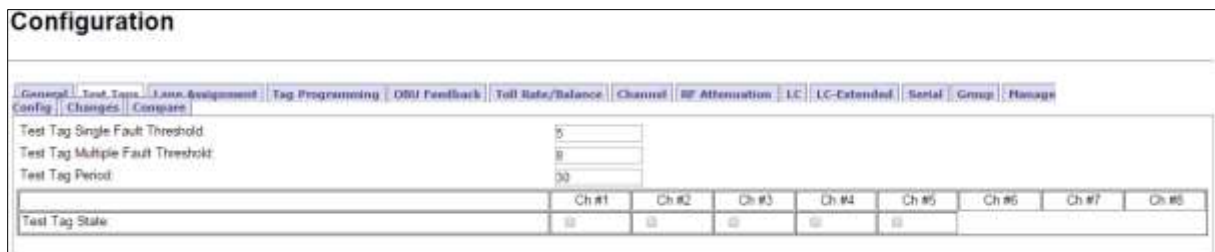

	Ch #1	Ch #2	Ch #3	Ch #4	Ch #5	Ch #6	Ch #7	Ch #8
Test Tag State	<input type="checkbox"/>	<input type="checkbox"/>	<input type="checkbox"/>	<input type="checkbox"/>	<input type="checkbox"/>	<input type="checkbox"/>	<input type="checkbox"/>	<input type="checkbox"/>

3. Select the **Test Tag State** check box to enable tag testing for the appropriate RF channel(s).
4. Enter the number of consecutive test tag faults that cause a channel to be considered bad in the **Test Tag Single Fault Threshold** text box.

Note: This should be set to 5 or higher.

5. Enter the number of bad channels that will trigger an automatic switchover, if the SPM redundancy switch is in AUTO, in the **Test Tag Multiple Fault Threshold** text box.

Note: This value must be less than or equal to the number of RF channels equipped with test tags.

6. Enter the period of time between test tag checks, in seconds, in the **Test Tag Period** check box.

Note: This should be set between 30 and 90 seconds.

7. Press Enter or select a different tab to accept .

New firmware

Periodically, Kapsch Service will release a new version of the Reader firmware. The firmware name indicates the year, month, day, and revision number of the release.

This procedure outlines how to upload the new firmware to the Reader so it can then be activated.

Uploading new firmware

Prerequisites: A service laptop containing a copy of the latest firmware is connected to either the Ethernet 1 or a USB port and then logged into the CTM web interface.

You must have Software Management permissions.



CAUTION:

On a redundant Reader, ensure that the redundant side has no fault conditions and all lane controller links are functioning

1. Select the **Manage Software** link from the left panel of the screen.

Result: The following Software Update page appears.

Software Update

Upload Software Updates:

Filename: No file chosen

Activate Software Updates:

The software update files currently occupy 77% of the maximum allocated space.
Space remaining: 4.24 MB

Available Firmware Versions	Status	Actions
2014jan28a-MPR2.en.sign	FACTORY, INACTIVE	<input type="button" value="Activate"/>
2014nov28a-MPR2.en.sign	INACTIVE	<input type="button" value="Activate"/> <input type="button" value="Delete"/>
2015jan08a-MPR2.en.sign	INACTIVE	<input type="button" value="Activate"/> <input type="button" value="Delete"/>
2015jan29a-MPR2.en.sign	ACTIVE	

Software Update History:

2014-12-16T15:11:16	2014nov28a-MPR2.en.sign
2015-01-06T09:32:09	2015jan06a-MPR2.en.sign
2015-01-14T16:02:48	2014jan28a-MPR2.en.sign
2015-01-15T11:00:25	2015jan08a-MPR2.en.sign
2015-01-29T16:53:17	2015jan29a-MPR2.en.sign
2015-02-12T16:52:32	2015jan08a-MPR2.en.sign
2015-02-12T16:54:40	2015jan29a-MPR2.en.sign

Reboot Reader:

Note: Ensure that the new firmware version is more recent than the active firmware version

2. Check the **Space remaining** to ensure there is enough Reader memory to load the new firmware.

3. If there is not enough Reader memory, delete an older, inactive version of the firmware (see Deleting firmware, page 245).
4. Click the **Browse** button to select the new firmware file saved on the computer.
5. Click the **Upload and Verify Software Update** button, then click **Yes** to confirm.

Result: The firmware will upload from the computer to the Reader. After the firmware has finished uploading to the Reader, the firmware appears in the table of available firmware versions as INACTIVE.

To begin using the new firmware, activate the firmware (see Activating new firmware).

Activating new firmware

The currently active firmware version becomes inactive once another firmware version is activated. All numbered callouts in parenthesis refer to **Error! Reference source not found.**

The following procedures outline the steps for activating an inactive firmware version stored on the Reader.

Prerequisites: You must have Software Management permissions.

The primary and secondary sides of the Reader are running normally.

The required firmware is uploaded to the Reader (see New firmware , page 241).



CAUTION:

Activating inactive factory firmware on a running system is not recommended. The factory firmware may not be appropriate for the specific application.



CAUTION: Redundant Reader

During firmware activation (typically less than 60 seconds) the Reader will switch over to the other side to process and report transactions, regardless of the position of the mode switch on the SPM module. Ensure that the other side is running normally and all lane controller links are functioning. The Reader will be unable to process or report transactions if it is unable to switch over to the other side.



CAUTION: Non-Redundant Reader

During firmware activation (typically less than 60 seconds), a non-redundant Reader is unable to process or report transactions.

On the Primary side:

1. Save the current configuration file, (see Saving the Reader configuration, page 246).
2. From the **Software Management** page, identify the inactive firmware version to be activated in the firmware version table.
3. Click the corresponding **Activate** button to activate the firmware. Click to acknowledge there will be a delay before the firmware becomes active.
4. If necessary, restore the configuration file saved in step 1 (see Uploading a saved configuration, page 246).

On the Secondary side:

1. Repeat steps 1 through 4 for the secondary side, ensuring the same firmware version is active for the primary and secondary side.

Deleting firmware

The Factory firmware and active firmware cannot be deleted. All callouts refer to **Error! Reference source not found.** This procedure outlines the steps for deleting an inactive firmware version stored on the Reader.

Prerequisites: You must have Software Management permissions.

1. From the **Software Management** page, identify the inactive firmware version to be deleted in the firmware version table.
2. Click the corresponding **Delete** button.
3. Click **Yes** to confirm.

Result: The firmware will be deleted and will no longer appear in the firmware version table.

Saving the Reader configuration

Each CTM has a unique configuration file stored on its CFM. This configuration file can be downloaded and saved to a computer. Use a saved configuration file to do the following.

- Quickly configure another Reader requiring the same or similar configuration.
- Restore the Reader to a known configuration.
- Troubleshoot problems by comparing the current configuration to past configurations.

This procedure outlines the steps for saving the Reader configuration to a service laptop which is logged into a CTM.

Prerequisites: A service laptop connected to Ethernet 1 or a USB port of the CTM and accessing the CTM web interface. Refer to Connecting a service laptop to the Reader, page 47.

1. Click the **Configuration** link on the left side panel.
2. Click the **Manage Config** tab on the **Configuration** page.

Result: The following screen appears.



3. Click the **Save config** button to save the new configuration.

Note: Different ways to save the configuration file appear depending on the web browser you use.

Uploading a saved configuration

Uploading a saved configuration will overwrite the current Reader configuration. There are two options for uploading a saved configuration: updating all configuration settings except for the IP settings, or updating all configuration settings including the IP settings. All callouts refer to **Error! Reference source not found.**

Prerequisites: A service laptop connected to Ethernet 1 or a USB port of the CTM and accessing the CTM web interface. Refer to Connecting a service laptop to the Reader, page 47. A version of the configuration file to be loaded is saved on a service laptop connected to the Reader.

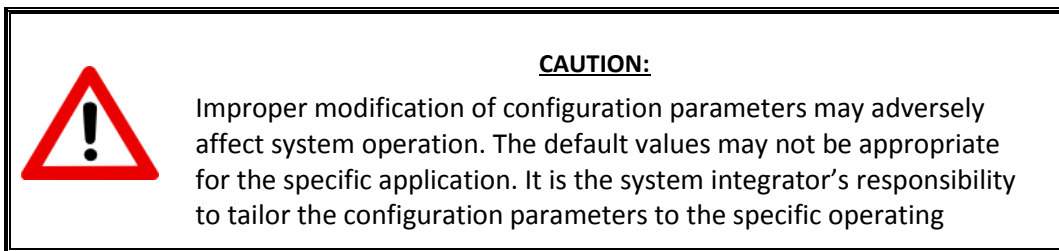

environment.

1. From the **Manage Config** tab on the **Configuration** page, click the **Browse** button to locate the configuration file on the service laptop to be uploaded.
2. If uploading all configuration settings to the Reader without changing the IP addresses settings, click the first **Upload Config** button.
3. If uploading all configuration settings to the Reader, including the IP addresses, click the second **Upload Config** button.

Resetting the Reader configuration to the factory default

Certain field service tests use the factory default configuration. This procedure outlines how to restore the factory default values without changing the Reader IP addresses.

Prerequisites: A service laptop connected to Ethernet 1 or a USB port of the CTM and accessing the CTM web interface. Refer to Connecting a service laptop to the Reader, page 47. Save the current Reader configuration (Saving the Reader configuration, page 246).

CAUTION:



The factory default configuration should not be restored on a running Reader. The factory firmware may not be appropriate for the specific application. Save the current Reader configuration before resetting the Reader configuration to the factory default.

1. Click on the **Configuration** link on the left side panel of the CTM web Interface.
2. Click the **Manage Config** tab.

Result: The following screen appears.



3. Click the **Reset Parameters to Default Values** button.

Result: All configuration values, except for the Reader IP addresses, will change to the factory defaults.

Administration

User administration permissions are needed when a new user account needs to be created, when an account needs to be changed, or deleted. The user can be given access to any combination of the five following access areas.

- User
- Advanced user
- Software management
- User admin
- Manage log files

Creating a new user

This procedure outlines how to create a new user account, create a password, and set the user permissions.

Prerequisites: A service laptop connected to either the Ethernet 1 or a USB port of the CTM. Refer to Connecting a service laptop to the Reader, page 47. You must have User Admin permissions.

1. Click on the **Manage Users** link on the left side panel

Result: The following screen appears.

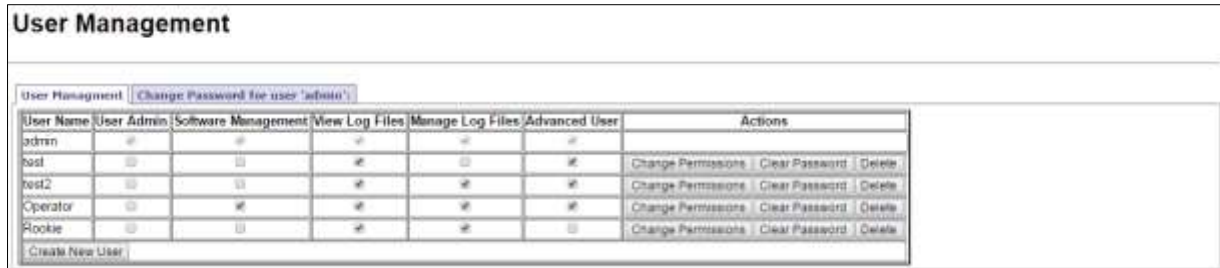

The screenshot shows the 'User Management' interface. At the top, there is a tab labeled 'User Management' and a button 'Change Password for user 'admin''. Below this is a table with columns for 'User Name', 'User Admin', 'Software Management', 'View Log Files', 'Manage Log Files', 'Advanced User', and 'Actions'. The table lists five users: 'admin', 'post', 'post2', 'Operator', and 'Rookie'. Each user has a set of checkboxes for permissions and a set of action buttons (Change Permissions, Clear Password, Delete). At the bottom left of the table area, there is a 'Create New User' button.

User Name	User Admin	Software Management	View Log Files	Manage Log Files	Advanced User	Actions
admin	<input checked="" type="checkbox"/>	<input checked="" type="checkbox"/>	<input checked="" type="checkbox"/>	<input checked="" type="checkbox"/>	<input checked="" type="checkbox"/>	
post	<input type="checkbox"/>	<input type="checkbox"/>	<input checked="" type="checkbox"/>	<input type="checkbox"/>	<input checked="" type="checkbox"/>	Change Permissions Clear Password Delete
post2	<input type="checkbox"/>	<input type="checkbox"/>	<input checked="" type="checkbox"/>	<input checked="" type="checkbox"/>	<input checked="" type="checkbox"/>	Change Permissions Clear Password Delete
Operator	<input type="checkbox"/>	<input checked="" type="checkbox"/>	<input checked="" type="checkbox"/>	<input checked="" type="checkbox"/>	<input checked="" type="checkbox"/>	Change Permissions Clear Password Delete
Rookie	<input type="checkbox"/>	<input type="checkbox"/>	<input checked="" type="checkbox"/>	<input checked="" type="checkbox"/>	<input type="checkbox"/>	Change Permissions Clear Password Delete

2. A **Create New User** form will appear on the **User Management** tab.
3. Click the **Create New User** button.

Result: The following screen appears.



4. Enter a unique user name in the **User Name** text box.
5. Enter the new user's password in the **Password** and **Confirm Password** text boxes.
6. Select **Enabled** for any of the five access areas to give the user the appropriate permissions.
7. Click **Submit** to create the new user account and return to the **User Management** tab.

Note: If you decide not to create the user at this time, click Cancel to return to the User Management tab

Changing a user's access permissions

A user's access permissions are set when the user account is created. As a user's responsibilities change, they may need access to more or fewer areas of the Reader configuration. This procedure outlines how to change the access permissions of an existing user.

Prerequisites: A service laptop connected to Ethernet 1 or a USB port of the CTM. Refer to Connecting a service laptop to the Reader, page 47. You must have User Admin permissions.

1. Click on the **Manage Users** link on the left side panel

Result: The following screen appears.

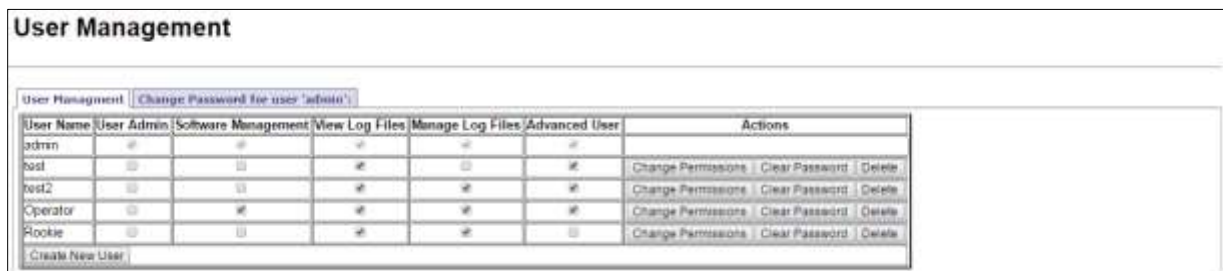

User Name	User Admin	Software Management	View Log Files	Manage Log Files	Advanced User	Actions
admin	<input checked="" type="checkbox"/>	<input checked="" type="checkbox"/>	<input checked="" type="checkbox"/>	<input checked="" type="checkbox"/>	<input checked="" type="checkbox"/>	Change Permissions Clear Password Delete
root	<input type="checkbox"/>	<input type="checkbox"/>	<input checked="" type="checkbox"/>	<input checked="" type="checkbox"/>	<input checked="" type="checkbox"/>	Change Permissions Clear Password Delete
test2	<input type="checkbox"/>	<input type="checkbox"/>	<input checked="" type="checkbox"/>	<input checked="" type="checkbox"/>	<input checked="" type="checkbox"/>	Change Permissions Clear Password Delete
Operator	<input type="checkbox"/>	<input checked="" type="checkbox"/>	<input checked="" type="checkbox"/>	<input checked="" type="checkbox"/>	<input checked="" type="checkbox"/>	Change Permissions Clear Password Delete
Rookie	<input type="checkbox"/>	<input type="checkbox"/>	<input checked="" type="checkbox"/>	<input checked="" type="checkbox"/>	<input type="checkbox"/>	Change Permissions Clear Password Delete

2. Identify the user whose access permissions need changing.
3. Select the corresponding check box to give access to a particular area; clear the corresponding check box to deny access.

Note: If you navigate away from the User Management page before clicking the Change Permissions button, the access changes are not saved.

4. After the appropriate access changes are made, click the user's corresponding **Change Permissions** button.

Result: The following screen appears.

User Management

Confirm 'change' for user 'Rookie':

Are you sure that you want to 'change' for user 'Rookie'?

- Click **Yes** to confirm.

Result: The user access permissions update.

Deleting a user

Note: A deleted user will no longer be able to access the CTM web interface.

Prerequisites: A service laptop connected to Ethernet 1 or a USB port of the CTM. Refer to Connecting a service laptop to the Reader, page 47. You must have User Admin permissions.

- Click on the **Manage Users** link on the left side panel.

Result: The following screen appears.

User Management

User Management | Change Password for user 'admin'

User Name	User Admin	Software Management	View Log Files	Manage Log Files	Advanced User	Actions
admin	<input type="checkbox"/>	<input type="checkbox"/>	<input type="checkbox"/>	<input type="checkbox"/>	<input type="checkbox"/>	Change Permissions Clear Password Delete
test	<input type="checkbox"/>	<input type="checkbox"/>	<input type="checkbox"/>	<input type="checkbox"/>	<input type="checkbox"/>	Change Permissions Clear Password Delete
test2	<input type="checkbox"/>	<input type="checkbox"/>	<input type="checkbox"/>	<input type="checkbox"/>	<input type="checkbox"/>	Change Permissions Clear Password Delete
Operator	<input type="checkbox"/>	<input type="checkbox"/>	<input type="checkbox"/>	<input type="checkbox"/>	<input type="checkbox"/>	Change Permissions Clear Password Delete
Rookie	<input type="checkbox"/>	<input type="checkbox"/>	<input type="checkbox"/>	<input type="checkbox"/>	<input type="checkbox"/>	Change Permissions Clear Password Delete

- Click the corresponding **Delete** button.
- Result:** A dialog box appears for delete confirmation.
- Click **Yes** to confirm.

Verifying a computer is communicating with a specific CTM

Note: This test verifies the CTM that is being communicated with while using the web interface.

Prerequisites: A service laptop connected to Ethernet 1 or a USB port of the CTM and accessing the CTM web interface.

Refer to Connecting a service laptop to the Reader, page 47.

Using an NTP Server to synchronize the clocks of Readers in an IR network

Readers can use NTP servers to accurately regulate the time of all Readers in an IR network. This procedure outlines how to enable NTP time synchronization, set IP addresses for the NTP servers, and select the time zone for display purposes.

Note: NTP time sync can be used when a single reader is in use, as well as multiple readers.

Prerequisites: The Reader must be on a network connected to the Internet. A service laptop connected to Ethernet 1 or a USB port of the CTM and accessing the CTM web interface. Refer to Connecting a service laptop to the Reader, page 47. You must have Advanced User permissions.

1. Visit <http://support.ntp.org/bin/view/Servers/StratumTwoTimeServers> to see a list of NTP servers.
2. Identify an NTP server in your geographic region (the **ISO** column) that has an **OpenAccess** policy (the **AccessPolicy** column).
3. Click on the host name of the NTP server (the **HostName** column). The **ServerForm** table appears.
4. Record the IP address of the NTP server.

Note: The following step is optional.

5. Repeat steps 2 through 4 to obtain a total of three (3) IP addresses, each from a different NTP server.
6. Click on the **Set Time** link on the left side panel of the CTM web interface.

Result: The following screen appears.

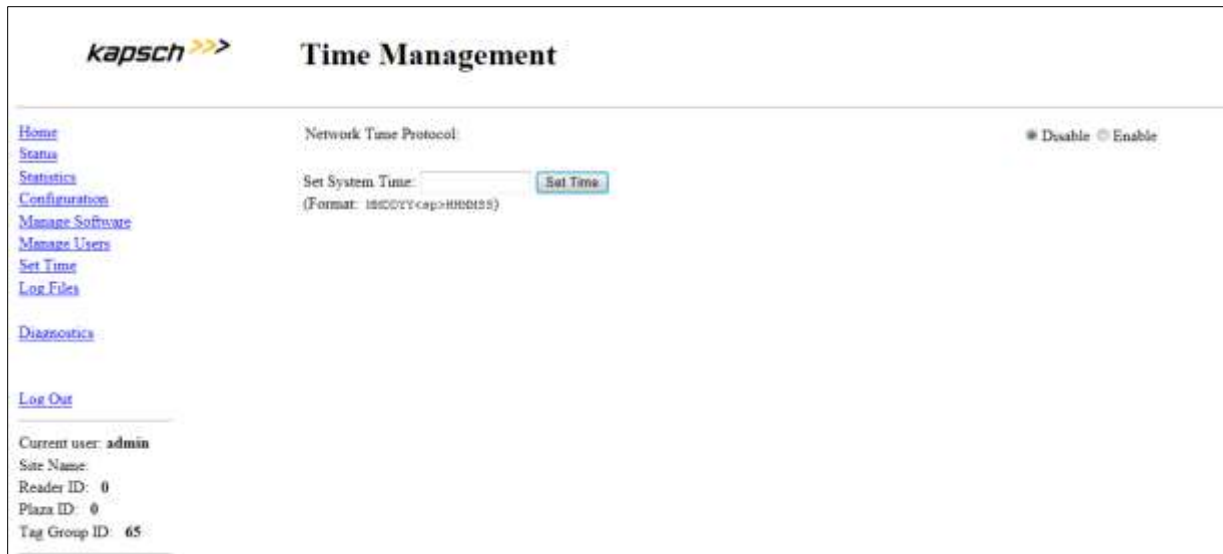

7. From the **Time Management** screen, select **Enable** to enable the Reader time updates from an NTP server.
8. Enter the three unique IP addresses recorded in step 4 in the **NTP Server 1, 2 and 3** text boxes.
9. Select the appropriate time zone from the **Time Zone** drop-down box. This is for display purposes only.
10. Click the **Update NTP Setting** button.

Result: The first available NTP server updates the Reader time.

Manually setting the Reader time and date

The Reader time can be set manually when it is not part of an Inter-Reader network. This procedure outlines how to set manually the Reader time.

Prerequisites: A service laptop connected to Ethernet 1 or a USB port of the CTM and accessing the CTM web interface. Refer to Connecting a service laptop to the Reader, page 47.

Note: Anyone can set the time.

1. Click the **Set Time** link on the left side of the panel.

Note: If Network Time Protocol is enabled, you will have to disable it to set the time manually.

Result: The following screen appears.



2. Select a time zone.
3. Enter a numeric value for the date and time in the **Set System Time** field. The format is 'MMDDYY<space>HHMMSS', using a 24-hour clock.
4. Click the **Set Time** button.

Result: The Reader updates to the time entered in the field.

Logging transactions remotely via an Ethernet connection

Attention: Use this function only under the direction of Kapsch Service.

Monitoring OBU transactions as they occur via the DIAGNOSTIC PORT

Use the Diagnostics port to view OBU transactions as they occur. This can also be done from the CTM web interface Diagnostics page.

Prerequisites: A service laptop connected to the Reader DIAGNOSTIC PORT using PuTTY or HyperTerminal. Refer to Connecting a service laptop to the Reader, page 47.

see Using PuTTY to connect to the DIAGNOSTIC PORT, page 255, or,

see Using HyperTerminal to connect to the DIAGNOSTIC PORT, page 255.

Note: The operator must ensure that there is only one active connection to diag1 for any given CTM. Having more than one simultaneous diag1 connection per CTM is not supported.

1. Press the **Enter** key a few times until the command prompt is displayed.
2. At the login: prompt, enter **diag1** as the user id and **diag1** as the password.

Note: Any OBU transactions will be displayed as they occur.

Saving Reader log files to a computer

This procedure outlines how to save any log file currently saved on the Reader to a computer.

Prerequisites: A service laptop connected to Ethernet 1 or a USB port of the CTM and accessing the CTM web interface. Refer to Connecting a service laptop to the Reader, page 47. You must have View Log Files and Manage Log Files permissions.

1. Select the **Log Files** link on the left side panel of the CTM web interface.

Result: The following screen appears.

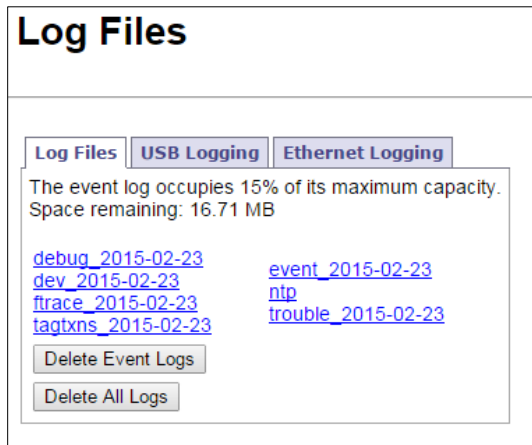

2. Right-click on the log file you want to save from the list.

Result: The following screen appears.



3. Click **Save Target As...** (Internet Explorer), **Save Link As...** (Firefox), or **Save Link As...** (Chrome) as applicable.
4. In the pop-up window, select a save location, and then click the **Save** button.

Result: The file downloads to the computer.

Manually saving a Reader log file to a USB flash drive

This procedure outlines how to save any log file currently saved on the Reader to a USB memory stick.

Prerequisites: A USB memory stick is inserted into one of the CTM USB ports.

You must have View Log Files and Manage Log Files permissions.

From the USB Logging tab on the Log Files page:

1. Click the Copy Log Files to USB device button.
2. Click the **Safely Remove Hardware** and **Eject Media** icon on the taskbar tray and select **Eject USB device**.
3. Remove the USB memory stick.

Appendix A Miscellaneous

Using PuTTY to connect to the DIAGNOSTIC PORT

1. Launch PuTTY.
2. Select **Serial** as your Connection Type.
3. Select the computer COM port that is connected to the Diagnostic Port.
4. Enter **115200** in the **Speed** text box.
5. Click **Open**.

Result: The following configuration screen appears.

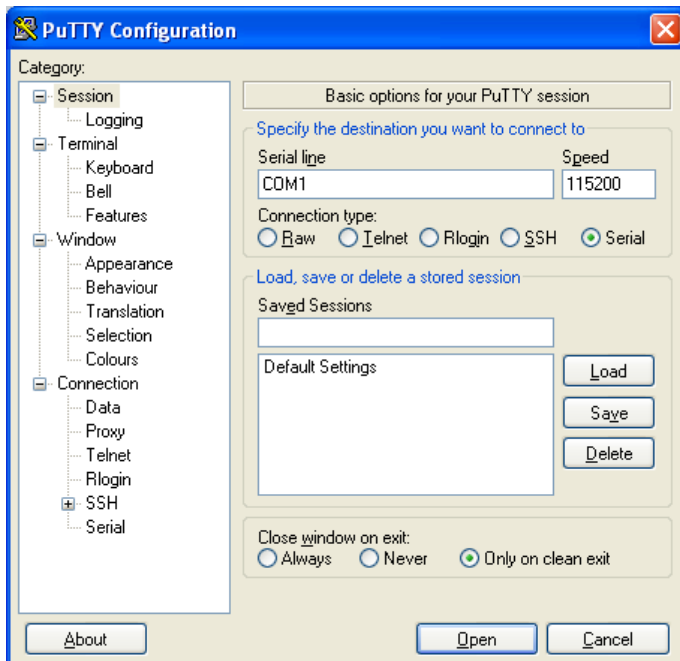

6. Press **Enter** a few times until the login prompt appears.

Using HyperTerminal to connect to the DIAGNOSTIC PORT

1. Go to **Start** → **Run**.
2. Type **hypertrm**, and then click **OK**.
3. In the **Connection Description** pop-up, enter a session name and then click **OK**.
4. In the **Connect To** pop-up, select the COM port that is connected to the Diagnostic Port from the **Connect Using** drop-down box.
5. Click **OK**.

Using RealTerm to connect to the MRFM-S

1. Connect a serial cable from the MRFM LC COM port to a port on your computer.
2. Launch RealTerm.
3. From the **Port** tab, select 115200 from the **Bits per second** drop-down box, set **Data Bits** to 8, set **Parity** to **None**, **Stop Bits** to 1, **Flow Control** to **None**.

Example: The following example is shown.

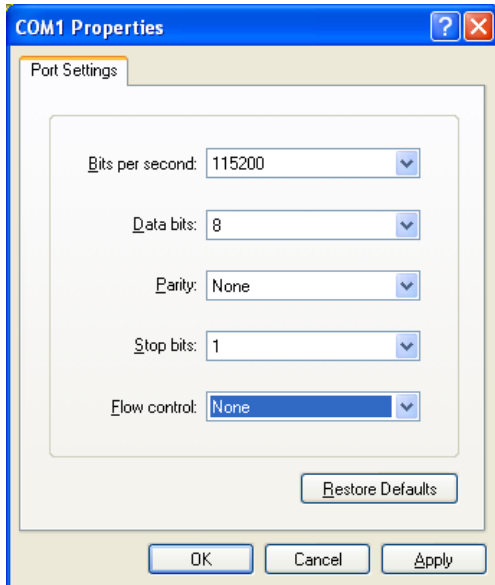

4. Select the COM port number of the computer port you connected to in Step 1 from the **Port** drop-down box.
5. Click the **Change** button.

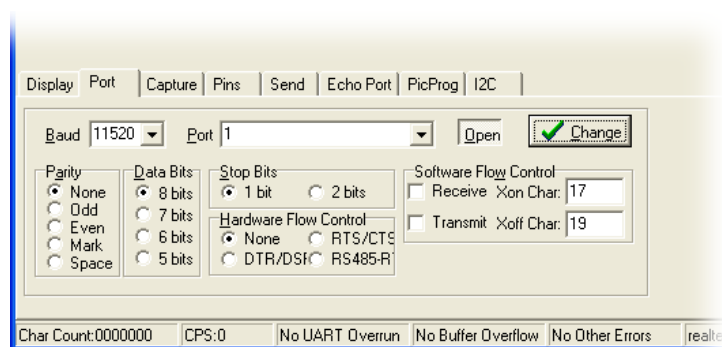

6. From the **Display** tab, select Binary from the Display As column.
7. MRFM-S data now displays in the display pane in the upper half of the **RealTerm** window.

Accessing Documentation

You can access the documentation package for the JANUS® Multi-Protocol Reader Ver. 2 online at <http://dds.kapsch.ca>

A Username and Password can be obtained from Kapsch Service.

The documentation package includes the following.

- Bill of Materials
- Assembly Drawings
- Schematic Drawings
- Parts Specifications (for purchased items)
- Operator and Maintenance Manuals
- Installation Instructions
- Training slides
- Software Design Documents: Context Diagrams, Data Flows
- As-built installation drawings (services)

Technical Specifications and Pin outs

JANUS® Multi-Protocol Reader Ver. 2 Technical Specifications		
Operation subject to FCC Site licensing (per FCC Part 90, Subpart M)		
Dimensions (excluding enclosure)		
Height = 17.5 inch	Width = 19.06 inch	Depth = 11.30 inch
Weight (excluding enclosure)		
Redundant Reader, with all slots filled: 63 lbs. (Not including MRFM-S)		
Enclosure Requirements		
NEMA 4 rated		
Operating Temperature Range		
-29.2°F to +165.2°F (-34°C to +74°C) For operation above 131°F (55°C) a 300CFM fan tray is required.		
Power Requirements		
300W @ 110VAC, UL/CSA power supply. Minimum of two, 3-prong IEC-320 receptacles (not supplied).		
PSM Ratings		
95-135 VAC, 60 +/- 2 Hz, 5A. One capable of supplying full load on redundant systems.		
Software		
Latest release available at delivery. Reader ships with default configuration settings.		
Memory Capacity		
1,000,000 buffered transactions.		
RF Channel Capacity		
Lane-based channels: maximum of 8. ORT channels: maximum of 5.		

NEMA 4 Enclosure Specifications		
Kapsch TrafficCom Field Cabinet Part Numbers		
Left hinged: 800127-101	Right hinged: 800127-102	
Dimension		
Height = 36 inch	Width = 30 inch	Depth = 20 inch
Enclosure Requirements		
<p>A 6 to 8-inch clearance between the top and bottom of the Reader and enclosure.</p> <p>Located for ready maintenance access.</p> <p>Location limited by maximum RF and Synchronization cable run length.</p>		
Construction		
-Aluminum with stainless steel components	-Neoprene gasket	
-Installed a 19-inch equipment rack for Reader mounting	-Universally keyed lock	
Penetrations		
<p>Must not allow moisture or condensation to run onto electronics or power cables.</p> <p>Kapsch TrafficCom warranty extends to manufacturer defects as delivered but does not cover environments, locations, or penetrations that invalidate the NEMA 4 rating.</p> <p>Deference is made to any specifications used by the agency to govern NEMA 4 enclosures on its roadways.</p>		
Grounding		
Use AWG 8 wire to connect to the earth – ground system.		

CTM Diagnostic Port pin out			
Connector Type			
Data Communications Equipment (DCE) pin assignment, 9-pin male connector.			
Lightning Suppression			
Not required.			
Pin Number	Signal	Description	Diagram
1	DCD	Carrier Detect input	
2	RXD	Receive Data input	
3	TXD	Transmit Data output	
4		n/c	
5	GND	Logic Ground	
6		n/c	
7	RTS	Request to Send output	
8	CTS	Clear to Send input	
9		n/c	

CTM Ethernet Ports 1 and 2 pin out			
Connector Type			
8 pin RJ45 female			
Lightning Suppression			
Recommended on all pins.			
Pin Number	Signal	Description	Diagram
1	BI_DA+	Bi-directional pair A +	
2	BI_DA-	Bi-directional pair A -	
3	BI_DB+	Bi-directional pair B +	
4	BI_DC+	Bi-directional pair C +	
5	BI_DC-	Bi-directional pair C -	
6	BI_DB-	Bi-directional pair B -	
7	BI_DD+	Bi-directional pair D +	
8	BI_DD-	Bi-directional pair D -	

SPM terminal block connections			
Connector Type			
Terminal block			
Lightning Suppression			
Recommended for all signal wires.			
Terminal Number	Signal	Description	Diagram
1	CGND	chassis ground, shield	
2	R-	Sync Rx (RS-422 -)	
3	R+	Sync Rx (RS-422 +)	
4	T+	Sync Tx (RS-422 +)	
5	T-	Sync Tx (RS-422 -)	
6	CGND	chassis ground, shield	

LPM RS-232 COM Port pin out			
Connector Type			
Data Terminal Equipment (DTE) pin assignment, DB9			
Lightning Suppression			
Recommended on pins 2, 3, 7, 8.			
Pin Number	Signal	Description	Diagram
1	DCD	Data Carrier Detect	<p>The diagram shows a DB9 connector with nine pins. Pin 1 is at the top right, pin 5 is at the bottom right, pin 6 is on the left side, and pin 9 is at the bottom left. The pins are arranged in a 3-2-2-2 pattern.</p>
2	TXD	Transmit data output	
3	RXD	Receive data input	
4	DTR	Data Terminal Ready	
5	SGND	Signal ground	
6	DSR	Data Set Ready	
7	RTS	Ready to Send	
8	CTS	Clear To Send	
9	CGND	Chassis ground	

LPM RS-422 COM Port pin out			
Connector Type			
Data Terminal Equipment (DTE) pin assignment, DB9			
Lightning Suppression			
Recommended on pins 1, 2, 3, 4.			
Pin Number	Signal	Description	Diagram
1	TXD+	Transmit data output	
2	TXD-	Transmit data output	
3	RXD+	Receive data output	
4	RXD-	Receive data input	
5	NC		
6	NC		
7	NC		
8	NC		
9	NC		

Antenna Specifications

Antenna	IAG-1	IAG-3
P/N	800260-011	800260-015
Lane Kit #	802344-TAB	802344-TAB
Description	3x3 patch	3x4 dipole array
Width (inches)	34.75	34.5
Length (inches)	31.75	21.25
Thickness (inches)	2.3	3.13
Weight ¹ (lbs)	33	19
Mounting	horizontal	horizontal
Application	standard width or ORT lane	Standard Width or ORT lane
Straddle (feet) (min/max c to c)	5.5/6.5	5.5/6.5

Note: Mounting information is provided as a guideline.

Weight specified is applicable to the antenna structure only i.e. it does not include mounting hardware.

Antenna Environmental Specifications

Operating Temperature: -34C to 74C

Vibration:

Frequency	Displacement
Below 1 Hz	10 inch sway
1-4 Hz	1 inch sway
4-10 Hz	0.1 amplitude
11-15 Hz	0.03 amplitude
16-25 Hz	0.02 amplitude
26-30 Hz	0.01 amplitude
31-40 Hz	0.005 amplitude
41-50 Hz	0.003 amplitude
Shock (all direction):	15 G, 11 ms saw tooth
Wind:	160 mph
Peak Displacement:	6 inches

RF Cable Specifications

Kapsch TrafficCom IVHS recommends the following options for RF feedline cables.

Cable P/N	Manufacturer	Loss/100ft (dB)
LMR-400DB	Times Microwave	3.966
LMR-600DB	Times Microwave	2.542
LMR 900DB	Times Microwave	1.725
LDF4-50A	Andrews	2.1

The maximum cable length is limited by the permitted cable signal loss. The maximum cable signal loss is based on the protocols selected and is limited to the lowest value in the table below of all protocols enabled.

Protocol	Maximum cable loss (dB)
TDM - IAG	8
ISO18000-6C	8
ISO18000-6B	4
SeGo	4
Allegro	4
10374/ATA/AAR S-918	4

Connectors: Use cable assembly tools recommended by the cable manufacturer.

Cable splicing: No splices are allowed, must be a continuous run

Minimum Bend Radius: See Manufacturers recommendation

Finished connection must be weatherproofed using self-amalgamating tape

Cable that run underground or may be submersed in water must be installed in conduit with no other cables capable of inducing RFI or EMI.

Synchronization cable specifications

Belden 9730 or 89730 cable or equivalent as determined by Kapsch TrafficCom engineering. Detailed specifications available from manufacturer.

An example of the wiring detail is shown in Figure 5-9: Synchronization circuit schematic for three Readers, page 179. This cable must be run in conduit and should not be run with other cables capable of inducing RFI or EMI.

Maximum Sync Cable Length

2000 feet (607 meters) max length, sum of all Readers cable segments to hub

1500 feet (457 meters) max length, any one Reader cable segment to hub

Sync Cable Requirements

Temperature: as required for operating environment

Environmental: as required for operating environment (must be waterproof if immersion is possible)

Capacitance: 30 pF/ft or less

Sync Wire: 3 twisted pairs (2 active, 1 spare), shielded, single or multiple drain

Wire gauge: 24 AWG (minimum)

Terminal Block

Temperature and Environmental: as required for operating environment

Number of terminals: [4 X (number of Readers in the sync group) plus 4] e.g. 3 Readers require $(4 \times 3) + 4 = 16$

Connection: See the example diagram of a three-Reader sync hub connection in Figure 5-9, page 179.

Spares and Tools

The following table lists the recommended spares for the JANUS reader and the Lane Kits.

Part Number	Description
801638-001	Configuration module - CFM
801701-003	Lane port module, RS422 - LPM
801701-002	Lane port module, RS232 - LPM
802311-001	Power supply module, primary - PSM
802311-002	Power supply module, secondary - PSM
307865-020	Fuse, time lag, 10A, 500V, power supply main input
801693-001	Sync port module, 2-wire RS485-SPM
801693-002	Sync port module, 4-wire RS485 - SPM
801693-003	Sync port module, 4-wire RS422 - SPM
802284-TAB	Controller module, RS422 - CTM
802284-TAB	Controller module, RS232 - CTM

Part Number	Description
802344-TAB	Lane kit, IAG-3
800260-011	Antenna, IAG-1
800260-015	Antenna, IAG-3
800125-001	Adapter cable, RF
802295-TAB	MRFM-S module

Test Equipment

- Two-way radios
- Measuring device (Tape rule, Wheel)
- Lane marking materials (paint or other)
- Plumb bob (25ft. line length)
- Electronic Level (digital display)
- Tool kits, appropriate cables, connectors etc.

Test Vehicles

- Bucket / Lift Platform Truck
- Passenger Vehicle (Type to be determined by Kapsch Engineering)

Reference Documents

Doc number	Title
ICD 360430-111	Interface Control Document for the Next Generation Reader External Hardware Interface
322704-TAB	Calibration Procedures
322710-077	Gold Transponder and Production Tester Calibration and Maintenance Procedure
801850-002	Front Mount Exterior (FME) Transponder Mounting Instructions for passenger vehicles
801850-004	G4 Interior Transponder Mounting Instructions
801850-005	Front Mount Exterior (FME) Transponder Roof Mounting Instructions for trucks and buses
801850-006	Motorcycle Front Mount Exterior (FME) Transponder Mounting Instructions
801850-008	G4F Feedback Interior Transponder Mounting Instructions
801850-012	G4 Transponder Secure Mount Bracket Mounting Instructions
801850-014	G4P Permanent Interior Transponder Mounting Instructions
801850-015	Flat Pack Transponder (FPT) Mounting Instructions
801850-016	Roof-Mount Flat Pack Transponder (FPT) Mounting Instructions for trucks and buses
801850-018	Commercial Vehicle Operator (CVO) Self-Test Transponder Mounting Instructions
801850-019	Front Mount Exterior (FME) Transponder Front Mounting Instructions for trucks and buses
801850-020	Motorcycle Flat Pack Transponder (FPT) Mounting Instructions

Other commercial Documents

RuggedMC™ RMC40 Installation Guide

Belden 89730 Multi-Conductor - Multi-Pair Snake Cable Detailed Specifications and Technical Data

Belden 9730 Paired - Multi-Pair Snake Cable Detailed Specifications and Technical Data

Acronyms and Synonyms

Term	Meaning	Reference or example
AC	Alternating current	
AM	Amplitude modulation	
AWG	American wire gauge	
BGR	Badger	a Kapsch TrafficCom manufactured Reader assembly
BOM	Bill Of Material	A parts list identifying individual components in the assembly of a system module
BPS	Bits per second	Data rate, or transmission speed
CAT	Category	an Ethernet cable type
CF	Compact flash	a memory storage type
CFM	Configuration Module	Non-volatile storage device containing the Reader configuration
CGC	Channel Group Controller Module	PWA board to handle the Manchester encoded RF protocol between the transponder and the Reader
CGND	Chassis ground	Common grounding mechanism for components within an enclosure or chassis. Typically earth grounded. The earth ground system must comply with the U.S. National Electrical Code (NEC) requirements for a grounding electrode.
CMOS	complementary metal-oxide semiconductor	a technology for manufacturing ICs
COM	communications	ex. COM port
COM	Communication module	In the Badger Reader, the Communication module provides the RS232/RS422 interface between the Reader and the Lane Controller. Note: Replaced by the LPM in the JANUS Reader..
computer	the service laptop computer or the LC host computer	
CPS	Cycles per second	Hertz

Term	Meaning	Reference or example
CPU	Central processing unit	
CRA	Cross Reader Algorithm	Badger Reader legacy algorithm (tag based) used to suppress duplicate transaction reporting to the Lane Controller
CTM	Controller Module	A plug-in module containing an assembly of CGC and MC
CTS	Clear to send	RS232 pin assignment
DA	data	
DB or dB	decibel(s)	unit of measurement of RF signal strength
DC	direct current	
DCD	Data carrier detect	RS232 pin assignment
DCE	Data communications equipment	RS232 port configuration, transmit is pin 2
deg.	degrees	
DIN	Deutsches Institut für Normung	German national standards organization
DSM	Distribution Module	Reader's back plane carrying DC power distributions to each module and signal connectivity between modules.
DSR	Data set ready	RS232 pin assignment
DTE	Data terminal equipment	RS232 port configuration, transmit is pin 3
DTR	Data terminal ready	RS232 pin assignment
EBX	embedded board expandable form factor	compatible with legacy PC104 form factor
EIA	Electronic Industry Association	
EMI	Electromagnetic Interference	Disturbance to radio signals and electronic circuits due to undesirable B-field emissions from an external source. See also RFI.

Term	Meaning	Reference or example
EMP	Electromagnetic Pulse	Strong disturbance that negates the ability of all exposed electronics in the affected area.
EN	enable	
ESD	electro-static discharge	
ESM	Ethernet Switch Module	Used to create an inter-Reader network of up to 3 Readers in ORT installations, improves Voting
ETC	Electronic Toll Collection	Collection of tolls using electronic mechanisms such as RFID tags and Readers
FCC	Federal Communications Commission	
FDM	Frequency Division Multiplexing	An RF module that is able to scan multiple OBUs from the frequency being emitted by them.
FME	Front Mount Exterior	An exterior tag in a weatherproof package mounted using the front license plate mounting holes. This item replaces the LPT tag
FPGA	Field Programmable Gate Array	the FPGA file defines the bit stream
FPT	Flat Pack Transponder	An interior tag in flat package mounted on the inside of the windshield
GND	ground	
HS	handshake	
HTTPS	Hypertext Transfer Protocol Secure	
Hz	Hertz	Cycles per second
I/O	input/output	
IAG	Inter-Agency Group	A group of toll highway agencies regulating common tag content and use
IC	Integrated circuit	

Term	Meaning	Reference or example
ICD	Interface Control Document	Specification of the physical interface, protocol and file formats used for messages sent between two communications components.
ID	Identity or Identifier	Group ID in RF Channel configuration
IEC	International Electrotechnical Commission	
IEEE	Institute of Electrical and Electronic Engineers	Worldwide non-profit professional organization that makes voluntary, consensus-based, standards
IF	Interface	
IP	Intellectual Property or Internet Protocol	reference an asset or reference an address
IR	Inter-Reader	
IRIF	Inter-Reader interface	An Ethernet network of Readers at an ORT site
ISO	International Organization for Standardization	International standards body. Members are the national standards bodies for each country.
JRE	Java Runtime Environment	Required for some JANUS® functions
LA	lane assignment	
LAN	Local Area Network	A local computer network for communication between computers
LC	Lane Controller	Controls Readers and receives data and alerts from Readers.
LCD	Liquid Crystal Display	Thin flat display device, using multi-colored pixels in front of a light source
LED	Light Emitting Diode	Used as status indicators on JANUS® Multi-Protocol Reader Ver. 2
LPM	Lane Controller Port Module	In the JANUS® Multi-Protocol Reader Ver. 2, this module provides a serial interface between the Reader and the Lane Controller

Term	Meaning	Reference or example
LPT	License Plate Transponder	An exterior tag in a weatherproof package mounted using the front license plate mounting holes (a legacy product now replaced by the FME)
MC	Main Controller	Intel-x86 based single-board computer that runs the Reader software
MRFM-S	Smart RF Module	The analog portion of the Reader and the termination point for coaxial cables from the antennas with command driven Tx and Rx attenuation.
N/A	not available	
NEC	National Electric Code	
NEMA	National Electrical Manufacturers Association	Sets standards for electrical components. Equipment enclosures with a NEMA rating meet a certain standard. NEMA-4 is generally considered watertight.
NTP	Network Time Protocol	
OBU	On Board Unit	Transponder or tag
ORT	Open Road Tolling	ETC from high speed vehicles that do not slow down and may straddle lanes
PC	Personal computer	
PF	Programming failure	transponder programming by the Reader
Pgm	Program or programmed or programming	context related usage
PID	Plaza ID	a configurable Reader parameter
PS	Power supply	
PSM	Power Supply Module	PWA board to provide AC/DC power to the Reader
PTO	Programming timeout	
PU	Programming unverified	transponder programming by the Reader
PWA	printed wiring assembly	All of the digital rack plug-in boards have PWAs

Term	Meaning	Reference or example
QMS	Quality management system	
R/W	Read / Write	
RAL	Restricted Access Location	Physical security enforced for safety and system integrity.
RAM	Random Access Memory	Data stored in this type of memory can be accessed in any order
Reader	JANUS® Multi-Protocol Reader Ver. 2	
RF	radio frequency	Broadcast band transmission frequencies
RFI	Radio Frequency Interference	Disturbance to radio signals and electronic circuits due to undesirable E-field emissions from an external source. See also EMI.
RFID	RF Identification	An automatic Identification methodology relying on storing and retrieving data remotely using OBUs or RFID Tags (transponders) and Readers.
RFIF	RF Interface	Internal connection from the CTM via the DSM to the RF modules
RID	Reader ID	a configurable Reader parameter
ROM	Read Only Memory	Data, such as software, in this type of storage device cannot be modified
RSE	Roadside Equipment	The collection of all AVI equipment at the roadside, including Reader, antennas, Ethernet switches, power supplies, cables and connectors. (incorrect, only includes Reader rack)
RTS	Ready to send	RS232 pin assignment
RX or Rx	receive or receiver	Communications or RF Module functions
RXD	Transmit data	RS232 pin assignment
SGND	System ground	
SMA	Sub-miniature version A	An RF connector type

Term	Meaning	Reference or example
SNR or S/N	Signal to noise ratio	A comparison of desired signal to the level of background noise.
SPM	Sync Port Module	PWA board to provide sync signals to the Reader via the termination network
SSH	Secure shell	
SSL	Secure sockets layer	Internet site security access via certificates
Sync	Synchronization	
TAB	Tabulation	System of indexing used for variations of assembly drawings. A drawing number ending in the suffix “-TAB” will have a list of all other variations of the drawing (can be from -001 to -999).
TC	Toll collection	a Reader application
TCP	Toll Collection Programming	Software modules used to collect tolls
TCP/IP	Transmission Control Protocol/Internet Protocol	The Internet Protocol Suite is the set of protocols used for the Internet, and other systems or Intranets
TDM	Time Division Multiplexing	An RF module that is able to scan OBUs through time sequencing by using time difference between one OBU and another.
TM	Traffic management	a Reader application
TMP	Traffic Management Programming	Software modules used for traffic management
TTO	Transponder timeout	
TX or Tx	transmit or transmitter	Communications or RF Module functions
TXD	Transmit data	RS232 pin assignment
UDP	User Datagram Protocol	an Internet protocol that is faster than TCP but offers no error correction
UL	Underwriter Laboratories	Underwriter Laboratories Inc.
URL	Uniform resource locator	

Term	Meaning	Reference or example
USB	Universal Serial Bus	Standard protocol for peripherals, enables plug-and-play
UTC	Coordinated Universal Time	the time standard used to regulate time around the world
VAC	Voltage AC	
VDC	Voltage DC	
VSWR	Voltage Standing Wave Ratio	

Glossary

Name Term or Component	Alias or explanation
Baud Rate	Physical transmission speed: bits, or changes in state, per second
Capture Zone	An area wherein an OBU is detected by the MRFM-S.
Capture Zone Span Time	The amount of time it takes an OBU to pass through a capture zone
Channel	One RF channel or one lane of traffic
Dynamic Voting	Channel tab Voting algorithm. If the dynamic voting algorithm is set to anything other than "Disabled", the Reader generates a transaction report at some period in time (called the "Voting timeout") after the initial read of an OBU. The voting timeout is configured on the web interface Configuration page - Channel tab. The voting timeout is either; <ol style="list-style-type: none"> 1. Set manually by the operator, or 2. dynamically set according to prevailing traffic speeds on a channel-by-channel basis.
Earth ground system	The earth ground system must comply with the U.S. National Electrical Code (NEC) requirements for a grounding electrode.
Express Lane - Wide	No barriers between lanes, straddle antennas required. Same as ORT
feedline	The cable that carries the RF signal to or from the antenna. Also called transmission line.
frame	one scan of an RF Channel. There can be a maximum of eight frames for one Reader
Format Incompatible report	A report sent to the Lane controller, generated when a non-IAG tag is seen by the Reader.
Host Computer	Not supplied by Kapsch TrafficCom. Computer used to monitor/control the LC within the Toll Plaza. The Reader is accessible to a Toll Plaza Host computer (if available) via the web interface.
Interpolated (Voting)	Lane Assignment tab Voting algorithm,

Name Term or Component	Alias or explanation
Inter-Reader network	An Ethernet network of Readers at an ORT site used for ORT installations having more than 8 regular width lanes (or 5 wide lanes) in one direction
Lane assignment	The process of providing a transaction report to the lane controller, with the intent of correctly identifying the lane of travel of the transponder equipped vehicle. The overall goal is high programming success rate, high lane assignment accuracy, and low consistent reporting latency.
Majority (Voting)	Lane Assignment tab Voting algorithm
Non-Redundant Reader	A Reader having only the Secondary Reader, used for Vehicle Identification or Traffic Control Management applications
Plaza	Structure for toll collection, typically with barriers between lanes and canopy overhead. Vehicles slow for ETC.
Primary Side	Primary CTM (or the set of Primary Reader components)
Reader	Generic term for the JANUS® redundant Reader in this manual
Redundant Reader	A toll collection Reader having both Primary and Secondary controller modules.
Redundant Side	Secondary CTM (or the set of Secondary Reader components)
Service Laptop Computer	Service tool used to configure, setup, troubleshoot, and monitor the Reader.
Superframe	The total number of frames that can be scanned in a Reader.
Status File	OBU Account Status File supplied by the client and made available in the lane controller for download to the Reader.
Tag	Transponder or OBU
Transponder	Tag or OBU
Voting Time	Represents the time delay after the initial read of the tag, at which point the Reader determines the lane assignment for the OBU in the transaction report sent to the lane controller.
Wide lane	A standard-width lane is 10 to 12 feet wide. Wide lanes are 12 to 14 feet wide.

Differences between the Badger and JANUS[®] Readers

ATTENTION: A JANUS[®] Multi-protocol Reader Ver. 2 (MPR2) that is non-redundant uses primary-side hardware components whereas the JANUS[®] non-redundant reader uses secondary-side hardware components.

ATTENTION: The software of a JANUS[®] Multi-protocol Reader Ver. 2 (MPR2) that is non-redundant is locked in Primary mode; the mode switch mechanical position is ignored. The software of a JANUS[®] non-redundant reader is locked in Secondary mode; the mode switch mechanical position is ignored.

Users familiar with the Badger Reader application for ORT must note the following changes with respect to the use of Kapsch TrafficCom's JANUS[®] ETC Subsystem:

Note 1: Connection of the JANUS[®] Readers in an inter-Reader network allows adjacent Readers to vote on the lane assignment used for the transaction report.

Note 2: Shared antennas are no longer required between Readers.

Note 3: The 4-channel scan configuration is no longer needed.

Note 4: Reporting latency has been reduced to 5 ms for the JANUS[®] Reader. It was 35 ms for the Badger Reader. Use the configuration parameter Report Latency by Tag Type 0 – 4 to slow down the transaction reports to the LC for those legacy sites where the LC is expecting Badger Reader timing.

Note 5: There is no theoretical upper limit to the number of ORT lanes that can be supported with multiple co-located Readers.

Note 6: The IAG-3 antenna is recommended for use in JANUS[®] ORT applications. (The IAG-2 antenna currently used in toll plaza lanes is not recommended.)

The JANUS[®] and Badger Reader features are compared in Table 7-1.

Table 7-1: Important Differences between the Badger Reader and the JANUS Reader

Feature	JANUS	Badger	Notes
Performance Features			
Synchronization	Y	Y	Compatible performance with Badger Reader 4 wire sync circuit.(Not compatible with IAG Reader 2 wire sync circuit). Only syncs on 8 or 10 channel scan.
Reader redundancy	Y	Y	Automatic switchover upon failure to the redundant Reader without data loss.
Variable channel scan configuration	Y	Y	Improve handshakes per channel for ORT
Cross Reader Algorithm (via tag)	Y	Y	Dependent on successful tag programming.

Feature	JANUS	Badger	Notes
Cross Reader Voting (via Ethernet link)	Y		
Fixed Voting within Reader	Y	Y	Based on tag/Reader handshakes
Dynamic Voting	Y		Per channel, Separate voting time for FME/LPT (tag type 2) Update voting time using a configurable time interval. Improve lane assignment
Channel weighting	Y	Y	Option to de-emphasize straddle antenna (ORT)
Interpolated voting	Y		interpolated voting includes adjacent Readers
Early read voting delay	Y		Handshaking is continued for a longer period of time to include both sides of any gap in reading individual tags
Low read voting delay	Y		
Adjacent channel programming	Y		
Look for tags on adjacent channels	Y		Improve read performance
Implied Channel Groups		Y	global voting time (BGR), TTO
Configurable channel groups	Y		separate voting time, TTO, etc per group
Interleaved programming mode	Y	Y	
Non-interleaved programming mode	Y		
Read/Write Operation	Y	Y	Compatible handshake performance.
Improvement of Write performance	Y		Continue write attempts after voting ends
No tag programming on a Guard channel	Y	Y	
Dual read per frame	Y		Performance improvement
Tx/Rx Attenuation Control	Y		Power on each antenna is configurable

Feature	JANUS	Badger	Notes
Lane Controller & Reporting Features			
Filter out Non-IAG tags	Y		Non-IAG tags are not reported – configurable feature
Lane Assignment	Y	Y	Compatible performance (capture rate, read/write operation)
Support 8 LC Serial ports	Y	Y	
Max Serial port speed (kbps)	115.2	57.6	BGR max is on 5 ports
Support LC Ethernet interface	Y		Configurable 10/100/1000 Mbps
Support Inter-Reader Ethernet interface	Y		Configurable 10/100 Mbps for ORT use
Handshaking with Adjacent Readers	Y		Adjacent Readers are included in voting. Also, conflicts in configurations of adjacent Readers are identified.
Host Port support		Y	
Multiplex transactions to single COM	Y	Y	Compatible transaction report and format
Re-Report	Y		re-report a tag in zone
Initial Read Report	Y		
Post capture zone report	Y		
Transaction buffering	Y	Y	JANUS: 400K non-volatile BGR: 80K IAG: 1K
Reset transaction number	Y		Accept a Lane Controller command to reset OBU transaction number to zero
Latency measurement & reporting	Y		
Write protect transponder scratchpad fields	Y		
Status File Download for Feedback OBUs	Y		up to 40 million OBUs in the file

Feature	JANUS	Badger	Notes
Feedback OBU support	Y		Beeper and LED on OBU supported
Maintenance Features			
Web interface for local/remote Reader HTTPS access and control	Y		Viewing/modify Reader configuration, view status, download/run software, manage OBU Status file
Real time reporting of transactions on web interface	Y		
Advanced / Simple parameter presentation	Y		each web page has a functional group
Multiple users & permissions per user	Y		
Zero re-configuration upon processor module (CTM) replacement	Y		When a CTM is swapped, Reader configuration parameters are retained in the CFM (a non-volatile memory off board from the CTM).
Save Reader Configuration File to laptop (also IP addresses and permissions passwords)	Y		Transition process is made easier. During service process, reload the original instead of manual setting many parameters.
Remote reset (reboot)	Y		reset via a lane controller or the web interface
Firmware download	Y		
Maintain multiple firmware images	Y		At least 6 versions, including factory image.
Automatic switchover recovery	Y		Reader will return control to Primary without operator intervention.
USB stick transaction logging	Y		
Diagnostics			
Diagnostic Port	Y	Y	
Test Tag Support	Y	Y	

Feature	JANUS	Badger	Notes
Load monitoring (CPU/Mem)	Y		Allows anomaly detection.
High Speed Margin Diagnostic	Y		Proof of concept for channels with MRFM-S.
Trouble Log	Y		Separate trouble items from transaction log
Transaction Log	Y		Temporary transaction log
Event log	Y	Y	JANUS: number of events limited only by CF partition size. BGR & IAG: 10 events
Lane Controller serial interface check	Y		Via a loop-back adapter
Self-Test issued by Lane Controller	Y		LC commands a Reader to initiate/report self-test.
Controller (CGC) serial number reported	Y		S/N of controller board is sent to Web IF and log
Other			
Network Time Protocol	Y		Allows NTP to sync date and time for all Readers in a network
Feedback OBU activation – Option 1	Y	Y	BGR205 firmware
Dual Reporting Mode (Redundancy Reporting)	Y		Improved processing redundancy handling (JANUS® Reader Phase 2).
HARDWARE			
The JANUS® non-redundant Reader uses the secondary side components. The JANUS non-redundant MPR2 reader uses the primary side components.	Y		The Badger non-redundant Reader uses the primary side components

Feature	JANUS	Badger	Notes
The JANUS® non-redundant Reader software is locked in Secondary mode; the mode switch mechanical position is ignored. The JANUS non-redundant MPR2 reader software is locked in Primary mode; the mode switch mechanical position is ignored.	Y		The Badger non-redundant Reader mode switch is mechanically locked in the “primary” position.

Appendix B Non-redundant reader

The non-redundant Reader consists of:

Note: Numbers in the list below refer to those associated with the illustration below. The DSM, and CFM are not shown.

- One rack and Distribution Module ❶
- MRFM-S modules (up to 4 modules can be installed) ❷
- One Power Supply Module (PSM) and AC Power Cord ❸
- One Lane Port Modules (LPM) ❹
- One Controller Module (CTM), ❺ equipped with one Main Controller (MC), one Channel Group Controller (CGC)
- One Configuration Module (CFM) that attach directly to the DSM (not shown)
- One Synchronization Port Module (SPM) ❻

The following illustration shows the non-redundant reader setup with the right hand configuration. A left hand configuration is also available.

