



Canada

RF Test Report

As per

RSS-137 Issue 2:2009 & FCC Part 90 Subpart M

Location and Monitoring Service (LMS)
Operation in the 902 -928 MHz Band

on the

Model: 802155B-TAB

Issued by:

TÜV SÜD Canada Inc.
11 Gordon Collins Dr,
Gormley, ON, L0H 1G0
Canada
Ph: (905) 883-7255

Testing produced for



Prepared by

Min Xie,
Sr. EMC Engineer

See Appendix A for full client &
EUT details.

Reviewed by

Amir Emami,
Project Engineer



Registration #
6844A-3



Testing Laboratory
Certificate #2955.02



R-4023, G-506
C-4498, T-1246



Registration #
CA6844

Client	Kapsch TrafficCom Canada Inc	
Product	802155B-TAB	
Standard(s)	RSS 137 Issue 2:2009 FCC Part 90 Subpart M	

Table of Contents

Table of Contents	2
Report Scope	3
Summary	4
Test Results Summary	5
Notes, Justifications, or Deviations	6
Sample Calculation(s).....	7
Applicable Standards, Specifications and Methods.....	8
Document Revision Status	9
Definitions and Acronyms	10
Testing Facility	11
Calibrations and Accreditations	11
Testing Environmental Conditions and Dates	12
Detailed Test Results Section	13
Output Power and Antenna Heights	14
Occupied Bandwidth.....	17
Emission Mask.....	20
Transmitter Spurious Radiated Emissions	25
Temperature Frequency Stability.....	31
Appendix A – EUT Summary.....	33

Client	Kapsch TrafficCom Canada Inc	
Product	802155B-TAB	
Standard(s)	RSS 137 Issue 2:2009 FCC Part 90 Subpart M	

Report Scope

This report addresses the EMC verification testing and test results of the Kapsch TrafficCom Canada Inc.'s **802155B-TAB** and is herein referred to as EUT (Equipment Under Test). The EUT was tested for compliance against the following standards:

RSS-137 Issue 2:2009

FCC Part 90 Subpart M

Test procedures, results, justifications, and engineering considerations, if any, follow later in this report.

The results contained in this report relate only to the item(s) tested.

This report does not imply product endorsement by any government, accreditation agency, or TÜV SÜD Canada Inc.

Opinions or interpretations expressed in this report, if any, are outside the scope of TÜV SÜD Canada Inc. accreditations. Any opinions expressed do not necessarily reflect the opinions of TÜV SÜD Canada Inc., unless otherwise stated.

Client	Kapsch TrafficCom Canada Inc	
Product	802155B-TAB	
Standard(s)	RSS 137 Issue 2:2009 FCC Part 90 Subpart M	

Summary

The results contained in this report relate only to the item(s) tested.

EUT:	802155B-TAB
FCC Certification #, FCC ID:	JQU802155B
ISED Canada Certification #, IC:	2665A-802155B
EUT passed all tests performed	Yes
Tests conducted by	Min Xie

For testing dates, see "Testing Environmental Conditions and Dates".

Client	Kapsch TrafficCom Canada Inc	
Product	802155B-TAB	
Standard(s)	RSS 137 Issue 2:2009 FCC Part 90 Subpart M	

Test Results Summary

Standard/Method	Description	Limit	Result
FCC 90.205 RSS-137 Clause 6.4	Output Power	30 W	Pass
FCC 90.207 RSS-137 Clause 6.2	Types of Modulation	--	Pass See Justifications
FCC 90.209 RSS-137 Clause 6.1.2	Occupied Bandwidth	902 - 904 MHz: 2 MHz 909.75 – 921.75 MHz 12 MHz	Pass
FCC 90.210 (K) RSS-137 Clause 6.5.3	Spurious antenna port conducted emissions	Attenuation By: $55 + 10 \log_{10}(P_{max})$ dB.	Pass
FCC 90.210 RSS-137 Clause 6.5.3	Spurious radiated emissions	Attenuation By: $55 + 10 \log_{10}(P_{max})$ dB.	Pass
FCC 90.213 RSS-137 Clause 6.3	Frequency stability	2.5 ppm	N/A See Justification
FCC 90.214	Transient Behavior	--	N/A See Justifications
Overall Result			Pass

If the product as tested or otherwise complies with the specification, the EUT is deemed to comply with the requirement and is deemed a 'PASS' grade. If not 'FAIL' grade will be issued. Note that 'PASS' / 'FAIL' grade is independent of any measurement uncertainties. A 'PASS' / 'FAIL' grade within measurement uncertainty is marked with a '*'.

Client	Kapsch TrafficCom Canada Inc	
Product	802155B-TAB	
Standard(s)	RSS 137 Issue 2:2009 FCC Part 90 Subpart M	

Notes, Justifications, or Deviations

The following notes, justifications for tests not performed or deviations from the above listed specifications apply:

The EUT uses Shaped ON-OFF Keying to transmit information. According to FCC 90.207, the EUT is classified as K1D type of emission.

For FCC 90.214, the EUT operates in the 902-928 MHz band, and this requirement is not applicable.

For FCC 90.213, the EUT is an intermittently operated mobile transponder and therefore is not subject to frequency tolerance restrictions. The test was performed for information purpose.

For the requirements of FCC 90.210 (K) and FCC 2.1053 Measurements required: Field strength of spurious radiation. Spurious radiated emissions of the EUT was performed at 3 meters. The limit specified in FCC 90.210 (K) is: On any frequency outside the licensee's sub-band edges, the peak power of any emission shall be attenuated by $55 + 10 \log(P)$ where P is the highest emission (Watts) of the transmitter. For all intents and purposes, the limit is -25 dBm ERP. The 3 meter field strength limit for the EUT is given below:

$$E(\text{dB}\mu\text{V}/\text{m}) = \text{EIRP}(\text{dBm}) + 95.2$$

$$\text{Where EIRP} = \text{ERP} + 2.15$$

$$E(\text{dB}\mu\text{V}/\text{m}) = \text{ERP}(\text{dBm}) + 97.35$$

$$E(\text{dB}\mu\text{V}/\text{m}) = -25 \text{ dBm} + 97.35 = 72.35 \text{ dBuV}$$

This limit is applicable to all emission at 3 meter measurement distance.

Client	Kapsch TrafficCom Canada Inc	
Product	802155B-TAB	
Standard(s)	RSS 137 Issue 2:2009 FCC Part 90 Subpart M	

Sample Calculation(s)

Radiated Emission Test

Margin = Limit – (Received Signal + Antenna Factor + Cable Loss – Pre-Amp Gain)

Margin = 50.5dB μ V/m – (50dB μ V + 10dB/m + 2.5dB – 20dB)

Margin = 8.0 dB (pass)

Client	Kapsch TrafficCom Canada Inc	
Product	802155B-TAB	
Standard(s)	RSS 137 Issue 2:2009 FCC Part 90 Subpart M	

Applicable Standards, Specifications and Methods

- ANSI C63.4:2009 Methods of Measurement of Radio-Noise Emissions from Low-Voltage Electrical and Electronic Equipment in the Range of 9 kHz to 40 GHz
- ANSI C63.26:2015 American National Standard for Compliance Testing of Transmitters Used in Licensed Radio Services
- CFR 47 FCC Part 2 Code of Federal Regulations – Equipment Authorization
Subpart J Procedure
- CFR 47 FCC Part 90 Code of Federal Regulations – Private Land Mobile Radio Services
- FCC KDB 412172 D01 Determining ERP and EIRP v01
- RSS 137 Issue 2:2009 Spectrum Management and Telecommunications. Radio Standards Specification, Location and Monitoring Service in the Band 902-928 MHz.
- RSS-GEN Issue 5 General Requirements and Information for the Certification of
2018 Radio Apparatus
- ISO 17025:2005 General Requirements for the Competence of Testing and Calibration Laboratories

Client	Kapsch TrafficCom Canada Inc	
Product	802155B-TAB	
Standard(s)	RSS 137 Issue 2:2009 FCC Part 90 Subpart M	

Document Revision Status

Revision	Date	Description
000	Jan 21, 2022	Initial Release
001	Feb 07, 2022	Updated power measurement.

Client	Kapsch TrafficCom Canada Inc	
Product	802155B-TAB	
Standard(s)	RSS 137 Issue 2:2009 FCC Part 90 Subpart M	

Definitions and Acronyms

The following definitions and acronyms are applicable in this report.
See also ANSI C63.14.

AE – Auxiliary Equipment. A digital accessory that feeds data into or receives data from another device (host) that in turn, controls its operation.

BW – Bandwidth. Unless otherwise stated, this refers to the 6 dB bandwidth.

EMC – Electro-Magnetic Compatibility. The ability of an equipment or system to function satisfactorily in its electromagnetic environment without introducing intolerable electromagnetic disturbances to anything in that environment.

EMI – Electro-Magnetic Immunity. The ability to maintain a specified performance when the equipment is subjected to disturbance (unwanted) signals of specified levels.

EUT – Equipment Under Test. A device or system being evaluated for compliance that is representative of a product to be marketed.

ITE – Information Technology Equipment with a primary function(s) of entry, storage, display, retrieval, transmission, processing, switching, or control, of data.

LISN – Line Impedance Stabilization Network

NCR – No Calibration Required

RF – Radio Frequency

Client	Kapsch TrafficCom Canada Inc	
Product	802155B-TAB	
Standard(s)	RSS 137 Issue 2:2009 FCC Part 90 Subpart M	

Testing Facility

Testing for EMC on the EUT was carried out at TÜV SÜD Canada testing lab near Toronto, Ontario. The testing lab has a calibrated 3m semi-anechoic chamber which allows measurements on a EUT that has a maximum width or length of up to 2m and a height of up to 3m. The chamber is equipped with a turntable that is capable of testing devices up to 3300lb in weight. This facility is capable of testing products that are rated for 120Vac and 240Vac single phase, or devices that are rated for a 208Vac 3 phase input. DC capability is also available for testing. The chamber is equipped with a mast that controls the polarization and height of the antenna. Control of the mast occurs in the control room adjoining the shielded chamber. Radiated emission measurements are performed using a BiLog antenna and a Horn antenna where applicable. Conducted emissions, unless otherwise stated, are performed using a LISN and using the Vertical Ground plane if applicable.

Calibrations and Accreditations

The 3m semi-anechoic chamber is registered with Federal Communications Commission (FCC, CA6844), ISED Canada (IC, 6844A-3) and Voluntary Control Council for Interference (VCCI, R-4023, G-506, C-4498, and T-1246). This chamber was calibrated for Normalized Site Attenuation (NSA) using test procedures outlined in ANSI C63.4 "Methods of Measurement of Radio-Noise Emissions from Low-Voltage Electrical and Electronic Equipment in the Range of 9 kHz to 40 GHz". The chamber is lined with ferrite tiles and absorption cones to minimize any undesired reflections. The NSA data is kept on file at TÜV SÜD Canada. For radiated susceptibility testing, a 16 point field calibration has been performed on the chamber. The field uniformity data is kept on file at TÜV SÜD Canada. TÜV SÜD Canada Inc. is accredited to ISO 17025 by A2LA with Testing Certificate #2955.02. The laboratory's current scope of accreditation listing can be found as listed on the A2LA website. All measuring equipment is calibrated on an annual or bi-annual basis as listed for each respective test.

Client	Kapsch TrafficCom Canada Inc	
Product	802155B-TAB	
Standard(s)	RSS 137 Issue 2:2009 FCC Part 90 Subpart M	

Testing Environmental Conditions and Dates

Following environmental conditions were recorded in the facility during time of testing

Date	Test	Initials	Temperature (°C)	Humidity (%)	Pressure (kPa)
2021/12/9	Radiated Emissions	MX	22.1	22.2	101.3
2021/12/10	ERP	MX	22.3	22.7	101.4
2021/12/9	Antenna Conducted Emissions	MX	22.1	22.2	101.3

Client	Kapsch TrafficCom Canada Inc	
Product	802155B-TAB	
Standard(s)	RSS 137 Issue 2:2009 FCC Part 90 Subpart M	

Detailed Test Results Section

Client	Kapsch TrafficCom Canada Inc	
Product	802155B-TAB	
Standard(s)	RSS 137 Issue 2:2009 FCC Part 90 Subpart M	

Output Power and Antenna Heights

Purpose

The purpose of this test is to ensure that the maximum power conducted to the radiating element does not exceed the limits specified.

Limits

The limits are defined in FCC Part 90.205 (1) and RSS 137 Clause 6.4 as per the following paragraph:

902-928 MHz. LMS systems operating pursuant to subpart M of this part in the 902-927.25 MHz band will be authorized a maximum of 30 watts ERP. LMS equipment operating in the 927.25-928 MHz band will be authorized a maximum of 300 watts ERP. ERP must be measured as peak envelope power. Antenna heights will be as specified in §90.353(h).

Results

The EUT passed.

The EUT supports one protocols and operates only on a single channel. The EUT has a PCB antenna. Thus, antenna height is not applicable.

Radiated measurements were performed because the antenna is a PCB trace; the antenna gain is not accurately known and due to the impedance mismatch between the spectrum analyzer and the modified unit with antenna connector. KDB 412172 is used to determine the ERP of the EUT from a measured field.

$$P = \frac{(E*d)^2}{30}$$

Where:

P is the EIRP in Watts

E is the Electric Field in V/m

d is distance is meters

$P(\text{dBm}) = E (\text{dBuV/m}) - 95.23$ for a measurement distance of 3 m.

and

$ERP = EIRP - 2.15$

Client	Kapsch TrafficCom Canada Inc	
Product	802155B-TAB	
Standard(s)	RSS 137 Issue 2:2009 FCC Part 90 Subpart M	

The EUT was tested in horizontal and vertical positions. Radiated emission maximization procedures were followed to obtain the highest emission. The worst-case result provided in table:

Frequency	Raw Reading (dBuV)	Antenna Factor (dB)	Attenuator Factor (dB)	Cable Factor (dB)	E-Field (dBuV/m)	ERP (dBm)	ERP (mW)
915	61.36	29.8	10	5.7	106.9	9.5	8.9

Graph(s)

The graph shown below are maximized peak measurement graphs measured with a resolution bandwidth greater OBW of the EUT over a full 0-360° and the polarity of the measuring antenna in the same polarity as the EUT's antenna.

Peak E-Field

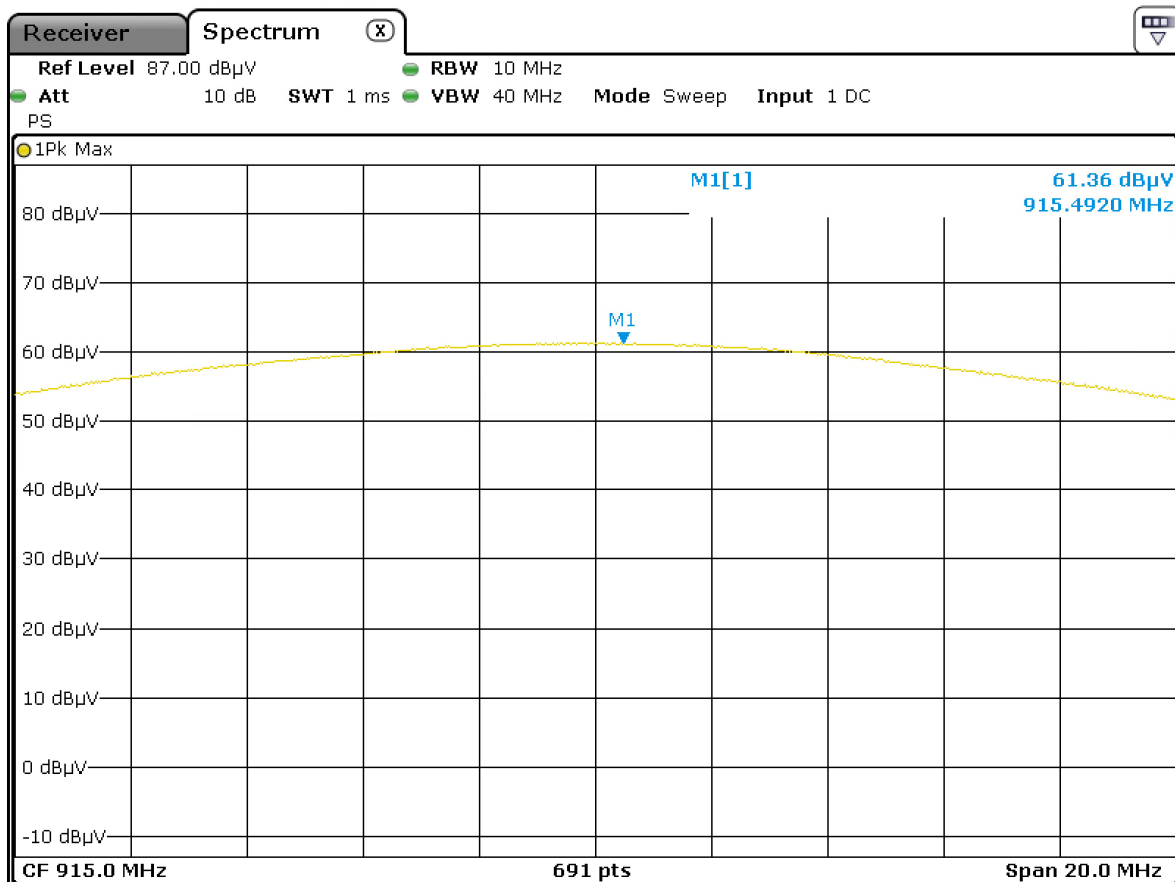

Date: 10.DEC.2021 10:35:14

Client	Kapsch TrafficCom Canada Inc	
Product	802155B-TAB	
Standard(s)	RSS 137 Issue 2:2009 FCC Part 90 Subpart M	

Note: See 'Appendix B – EUT & Test Setup Photographs' for photos showing the test set-up.

Test Equipment List

Equipment	Model No.	Manufacturer	Last Calibration Date	Next Calibration Date	Asset #
Spectrum Analyzer	ESR 26	Rohde & Schwarz	Mar. 6, 2020	Mar. 6, 2022	GEMC 341
BiLog Antenna	3142-C	ETS-Lindgren	Nov. 25, 2020	Nov. 25, 2022	GEMC 8
Attenuator 10 dB	612-10-1	Meca Electronics, Inc	NCR	NCR	GEMC 224
Attenuator 6 dB	6N5W-06	Inmet	NCR	NCR	GEMC 345
RF Cable <1GHz	LMR-400	LexTec	NCR	NCR	GEMC 274
RF Cable <1GHz	Sucoflex 104A	Huber+Suhner	NCR	NCR	GEMC 271

Note: GEMC 287 is part of GEMC 8's calibration.

Client	Kapsch TrafficCom Canada Inc	
Product	802155B-TAB	
Standard(s)	RSS 137 Issue 2:2009 FCC Part 90 Subpart M	

Occupied Bandwidth

Purpose

The purpose of this test is to ensure that the bandwidth occupied exceeds a stated minimum. This helps ensure the utilization of the frequency allocation is sufficiently wide. This also helps prevent corruption of data by ensuring adequate data separation to distinguish the reception of the intended information.

Limits

The Limit is as specified in FCC Part 90.209 and RSS-137 Clause 6.1.2.

The maximum authorized bandwidth shall be 12 MHz for non-multilateration LMS operations in the band 909.75-921.75 MHz and 2 MHz in the band 902.00-904.00 MHz. The maximum authorized bandwidth for multilateration LMS operations shall be 5.75 MHz in the 904.00-909.75 MHz band; 2 MHz in the 919.5-921.75 MHz band; 5.75 MHz in the 921.75-927.25 MHz band and its associated 927.25-927.50 MHz narrowband forward link; and 8.00 MHz if the 919.75-921.75 MHz and 921.75-927.25 MHz bands and their associated 927.25-927.50 MHz and 927.50-927.75 MHz narrowband forward links are aggregated.

Results

The EUT passed

Frequency (MHz)	99% Bandwidth (MHz)	20 dB BW (MHz)
915.0	7.31	5.10

Client	Kapsch TrafficCom Canada Inc	
Product	802155B-TAB	
Standard(s)	RSS 137 Issue 2:2009 FCC Part 90 Subpart M	

Graph(s)

The graphs showed below shows the OBW during the operation of the device. This is measured by a max hold on the spectrum analyzer and the highest resolution bandwidth that is sufficiently low to exhibit the 99% bandwidth of a channel during operation of the EUT. This measurement is a peak measurement. Max hold is performed for a duration of not less than 1 minute

99 % Bandwidth

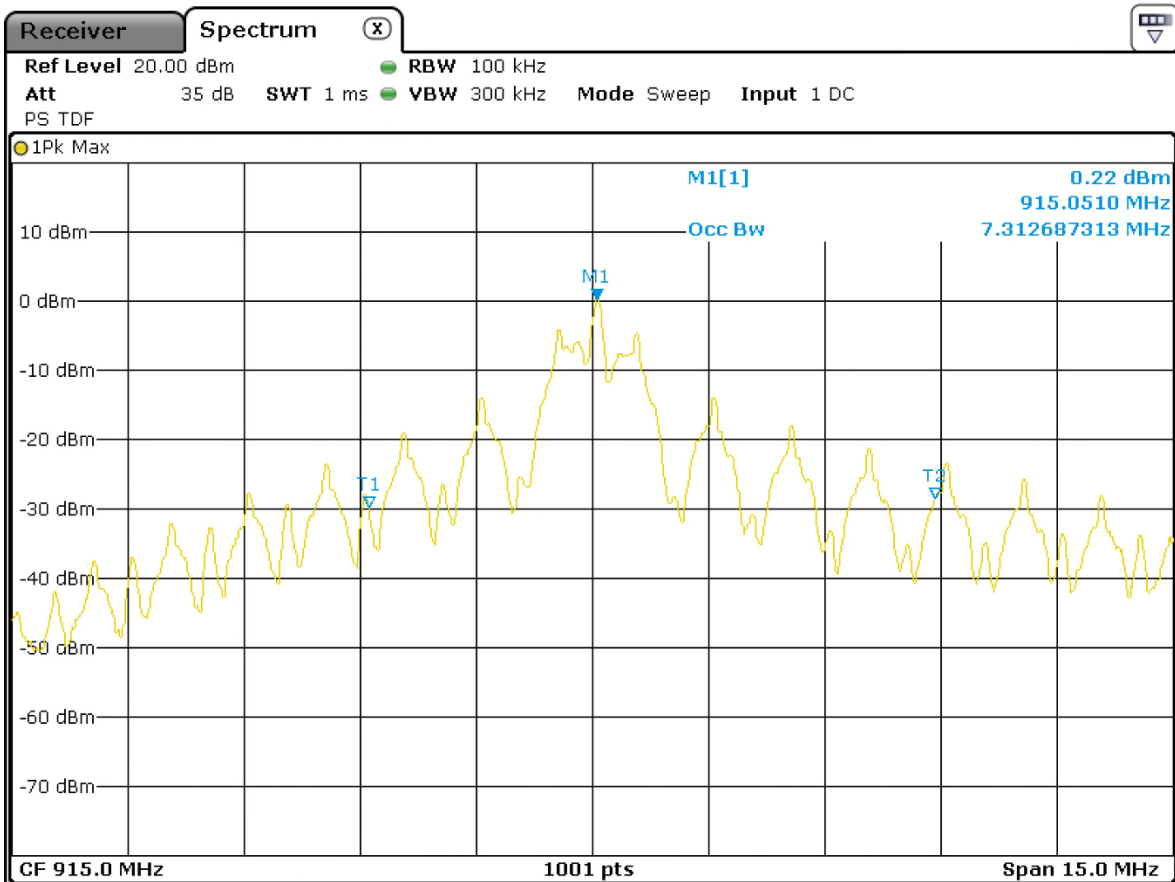

Date: 9.DEC.2021 15:26:59

Client	Kapsch TrafficCom Canada Inc	
Product	802155B-TAB	
Standard(s)	RSS 137 Issue 2:2009 FCC Part 90 Subpart M	

20 dB Bandwidth

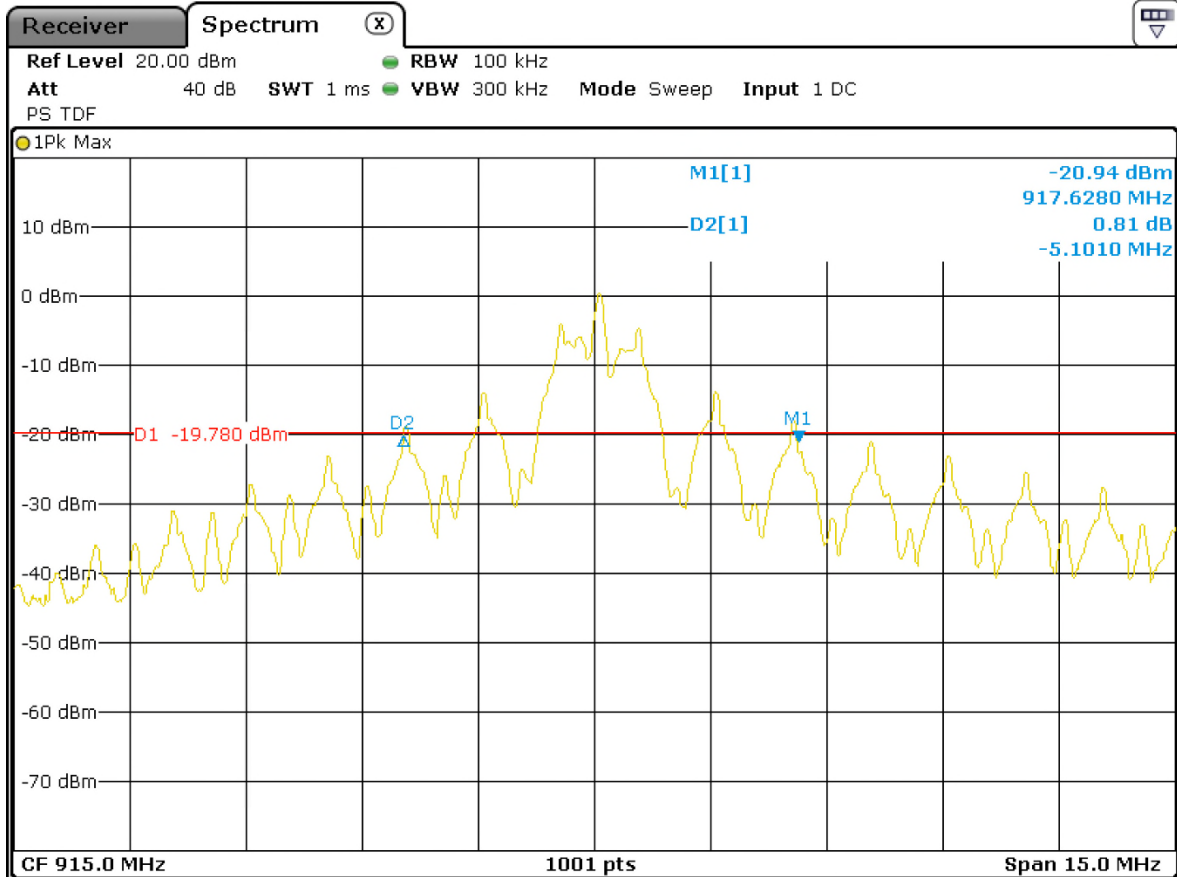

Date: 9.DEC.2021 15:31:02

Note: See 'Appendix B – EUT & Test Setup Photographs' for photos showing the test set-up.

Test Equipment List

Equipment	Model No.	Manufacturer	Last Calibration /Verification Date	Next Calibration /Verification Date	Asset #
Spectrum Analyzer	ESR 26	Rohde & Schwarz	Mar. 6, 2020	Mar. 6, 2022	GEMC 341
Attenuator 10 dB	612-10-1	Meca Electronics, Inc	NCR	NCR	GEMC 224

Client	Kapsch TrafficCom Canada Inc	
Product	802155B-TAB	
Standard(s)	RSS 137 Issue 2:2009 FCC Part 90 Subpart M	

Emission Mask

Purpose

The purpose of this test is to ensure that the maximum power conducted to the radiating element at frequencies outside of the authorized spectrum does not exceed the limits specified. This ensures that the only the intended signal is delivered to the radiating element.

Limits

The Limit is as specified in FCC Part 90.210 (K) and RSS-137 Clause 6.5.3

Emission Mask K—(1) Wideband multilateration transmitters. For transmitters authorized under subpart M to provide forward or reverse links in a multilateration system in the subbands 904-909.75 MHz, 921.75-927.25 MHz and 919.75-921.75 MHz, and which transmit an emission occupying more than 50 kHz bandwidth: in any 100 kHz band, the center frequency of which is removed from the center of authorized sub-band(s) by more than 50 percent of the authorized bandwidth, the power of emissions shall be attenuated below the transmitter output power, as specified by the following equation, but in no case less than 31 dB:

$$A=16+0.4 (D-50)+10 \log B \text{ (attenuation greater than 66 dB is not required)}$$

Where:

- A = attenuation (in decibels) below the maximum permitted output power level
- D = displacement of the center frequency of the measurement bandwidth from the center frequency of the authorized sub-band, expressed as a percentage of the authorized bandwidth B
- B = authorized bandwidth in megahertz.

(2) Narrowband forward link transmitters. For LMS multilateration narrowband forward link transmitters operating in the 927.25-928 MHz frequency band the power of any emission shall be attenuated below the transmitter output power (P) in accordance with following schedule:

On any frequency outside the authorized sub-band and removed from the edge of the authorized sub-band by a displacement frequency (f_d in kHz): at least $116 \log ((f_d+10)/6.1)$ dB or $50 + 10 \log (P)$ dB or 70 dB, whichever is the lesser attenuation.

(3) Other transmitters. For all other transmitters authorized under subpart M that operate in the 902-928 MHz band, the peak power of any emission shall be attenuated below the power of the highest emission contained within the licensee's sub-band in accordance with the following schedule:

Client	Kapsch TrafficCom Canada Inc	
Product	802155B-TAB	
Standard(s)	RSS 137 Issue 2:2009 FCC Part 90 Subpart M	

- (i) On any frequency within the authorized bandwidth: Zero dB.
- (ii) On any frequency outside the licensee's sub-band edges: $55 + 10 \log(P)$ dB, where (P) is the highest emission (watts) of the transmitter inside the licensee's sub-band.

(4) In the 902-928 MHz band, the resolution bandwidth of the instrumentation used to measure the emission power shall be 100 kHz, except that, in regard to paragraph (2) of this section, a minimum spectrum analyzer resolution bandwidth of 300 Hz shall be used for measurement center frequencies with 1 MHz of the edge of the authorized subband. The video filter bandwidth shall not be less than the resolution bandwidth.

(5) Emission power shall be measured in peak values.

(6) The LMS sub-band edges for non-multilateration systems for which emissions must be attenuated are 902.00, 904.00, 909.5 and 921.75 MHz.

Note: The EUT is a non- multilateration LMS transmitter. Emission limit (3) applies to the EUT. A $55 + 10 \log(P)$ dB attenuation (or -25 dBm absolute emission level) was applied all frequency from the outside authorized band.

Test procedure is as per eCFR 47 Part 2 Clause 2.1051.

Results

The EUT passed; it meets attenuation requirement at the antenna port.

The worst case is presented as a graph for the spectrum. Band edge requirements were shown for the lower band edge at 909.5 MHz in the low band where applicable. Band edge requirements were also shown for the higher band edge at 921.75 MHz in the high band where applicable.

Note: All measurements were made with an attenuator as appropriate to the measurement. The insertion loss were adjusted with Reference Level Offset function in the spectrum analyzer.

Client	Kapsch TrafficCom Canada Inc	
Product	802155B-TAB	
Standard(s)	RSS 137 Issue 2:2009 FCC Part 90 Subpart M	

Graph(s)

The graphs shown below shows the peak power output of the device during the antenna conducted measurement during transmit operation of the EUT.

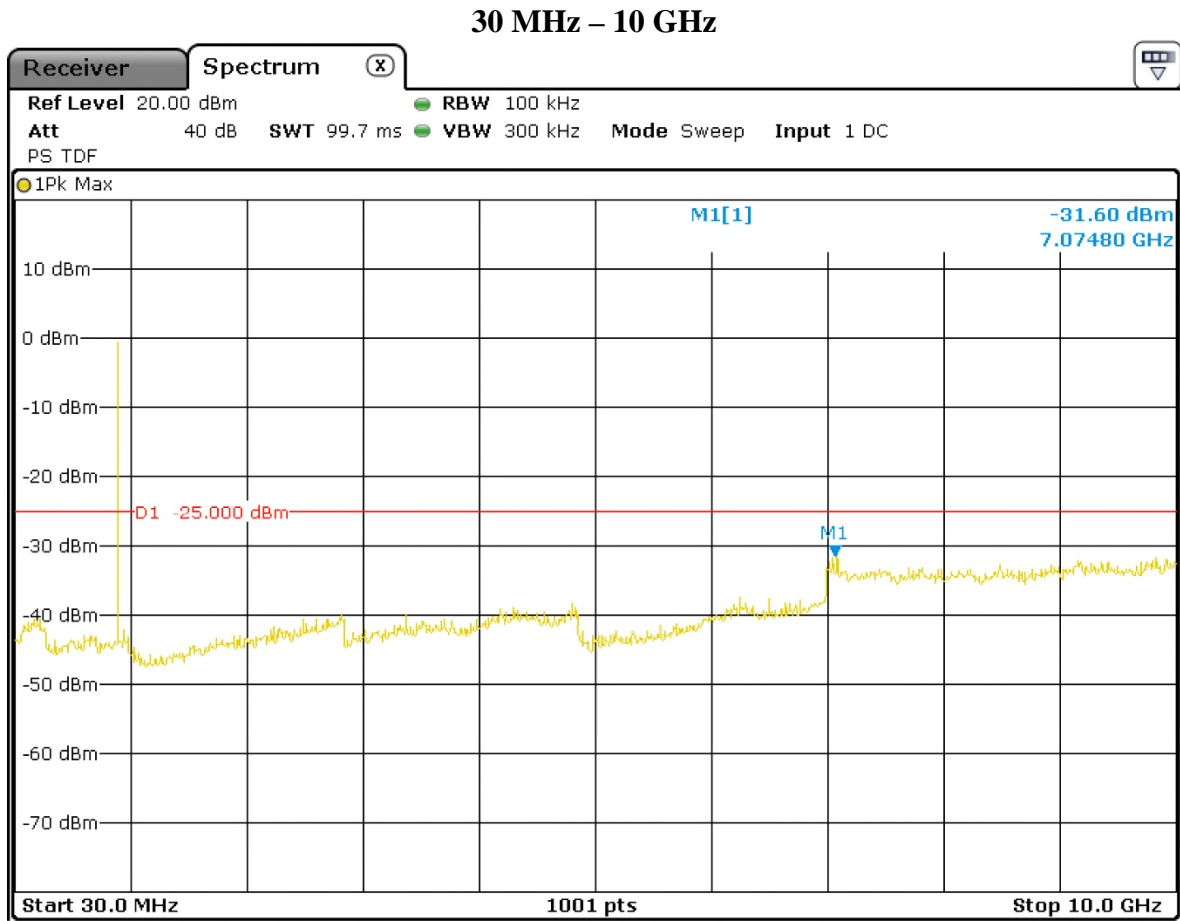

Date: 9.DEC.2021 15:39:10

Client	Kapsch TrafficCom Canada Inc	
Product	802155B-TAB	
Standard(s)	RSS 137 Issue 2:2009 FCC Part 90 Subpart M	

Band Edge

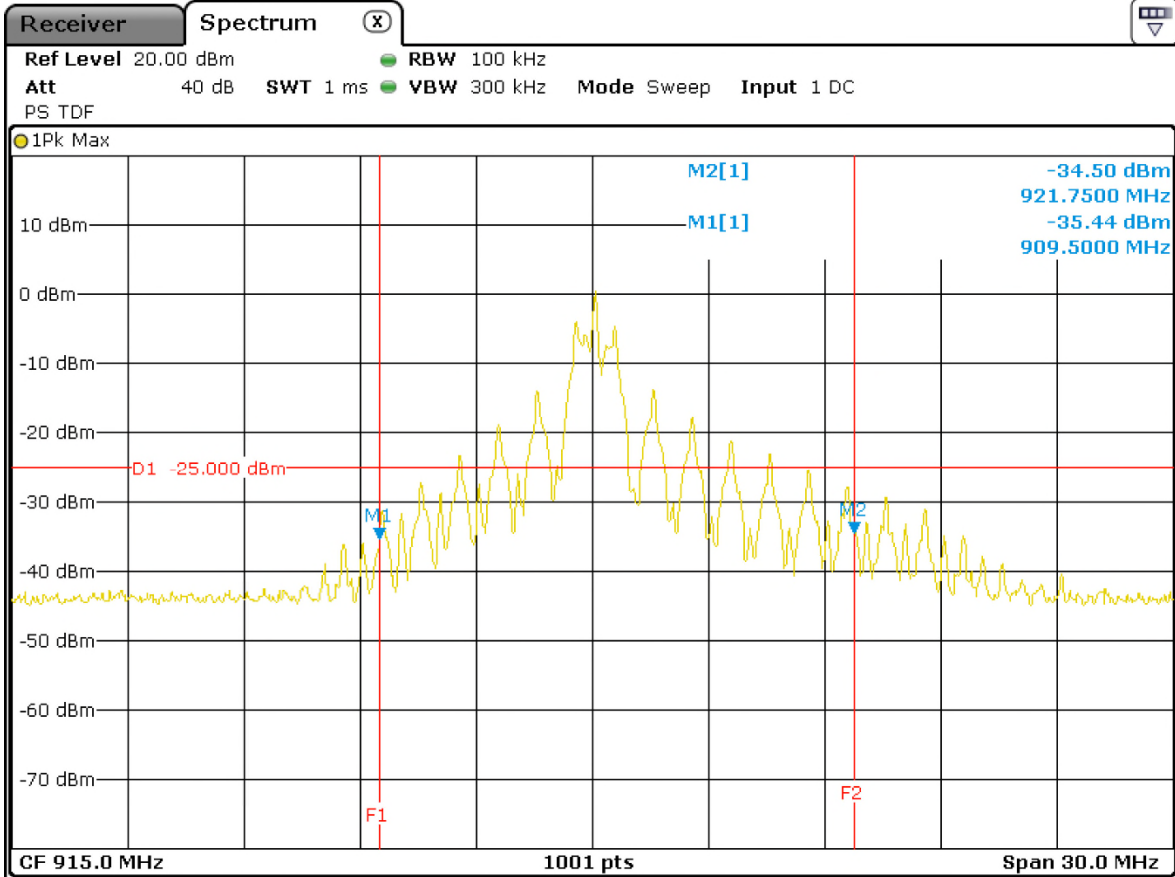

Date: 9.DEC.2021 15:37:26

See 'Appendix B – EUT & Test Setup Photographs' for photos showing the test set-up.

Client	Kapsch TrafficCom Canada Inc	
Product	802155B-TAB	
Standard(s)	RSS 137 Issue 2:2009 FCC Part 90 Subpart M	

Test Equipment List

Equipment	Model No.	Manufacturer	Last Calibration Date	Next Calibration Date	Asset #
Spectrum Analyzer	ESR 26	Rohde & Schwarz	Mar. 6, 2020	Mar. 6, 2022	GEMC 341
Attenuator 10 dB	612-10-1	Meca Electronics, Inc	NCR	NCR	GEMC 224

Client	Kapsch TrafficCom Canada Inc	
Product	802155B-TAB	
Standard(s)	RSS 137 Issue 2:2009 FCC Part 90 Subpart M	

Transmitter Spurious Radiated Emissions

Purpose

The purpose of this test is to ensure that the RF energy unintentionally emitted from the EUT does not exceed the limits listed below as defined in the applicable test standard, as measured from a receiving antenna. This helps protect broadcast radio services such as television, FM radio, pagers, cellular telephones, emergency services, and so on, from unwanted interference.

Limit(s) and Method

The method is as defined in FCC 2.1053 and the limits are as defined in FCC Part 90.210(K).

(3) *Other transmitters.* For all other transmitters authorized under subpart M that operate in the 902-928 MHz band, the peak power of any emission shall be attenuated below the power of the highest emission contained within the licensee's sub-band in accordance with the following schedule:

(i) On any frequency within the authorized bandwidth: Zero dB.

(ii) On any frequency outside the licensee's sub-band edges: $55 + 10 \log(P)$ dB, where (P) is the highest emission (watts) of the transmitter inside the licensee's sub-band.

Spurious radiated emissions of the EUT was performed at 3 meters. The limit specified in FCC 90.210 (K) is $55 + 10 \log(P)$ dBc. For all intensive purpose, the limit is -25 dBm. The field strength limit for the EUT is give in the below:

$$E(\text{dB}\mu\text{V}/\text{m}) = \text{EIRP}(\text{dBm}) + 95.2$$

$$\text{Where EIRP} = \text{ERP} + 2.15$$

$$E(\text{dB}\mu\text{V}/\text{m}) = \text{ERP}(\text{dBm}) + 97.35$$

$$E(\text{dB}\mu\text{V}/\text{m}) = -25 \text{ dBm} + 97.35 = 72.35 \text{ dB}\mu\text{V}$$

This limit is applicable all emission at 3 meter measurement distance.

The Limit is with 100 kHz measurement bandwidth and using a Peak detector.

Client	Kapsch TrafficCom Canada Inc	
Product	802155B-TAB	
Standard(s)	RSS 137 Issue 2:2009 FCC Part 90 Subpart M	

Typical Radiated Emissions Setup

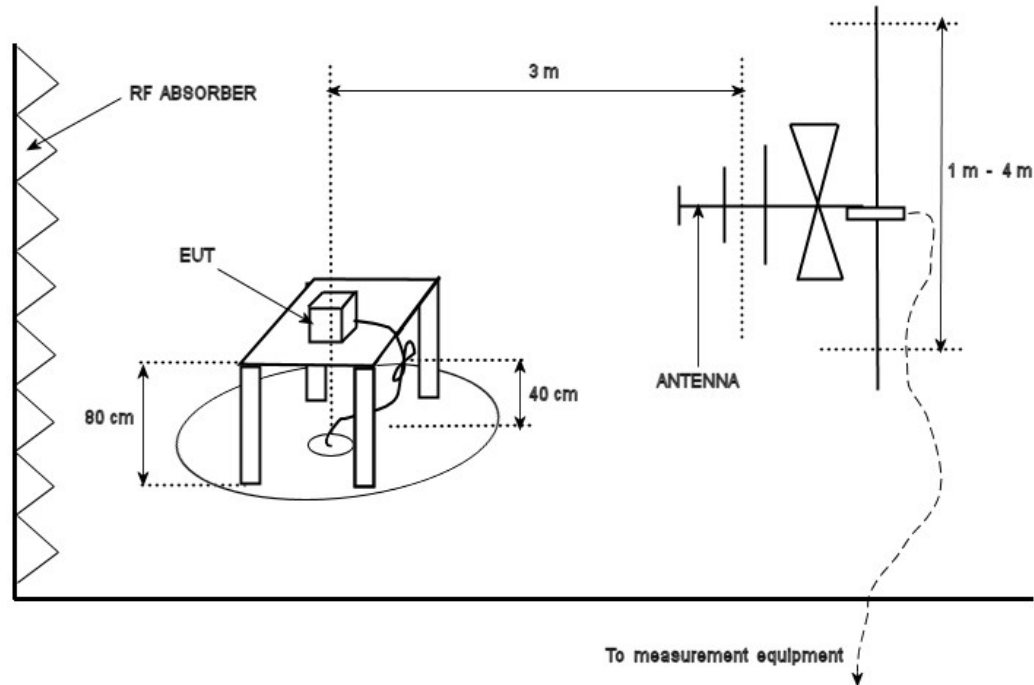

Measurement Uncertainty

The expanded measurement uncertainty is calculated in accordance with CISPR 16-4-2 and is +/-4.4 dB with a 'k=2' coverage factor and a 95% confidence level.

Preliminary Graphs

Note the graphs shown below are for graphical illustration only. For final measurements with the appropriate detector, please refer to the final measurement table where applicable. The graph shown below is a maximized peak measurement graph, measured with a resolution bandwidth greater than the final required detector and over a full 0-360 rotation. This peaking process is done as a worst case measurement. This process enables the detection of frequencies of concern for final measurement, and provides considerable time savings.

The device was scanned to the 10th harmonic (a minimum of a 10 GHz).

The measured radiation includes the emissions from the reader being used to control the EUT.

Client	Kapsch TrafficCom Canada Inc	
Product	802155B-TAB	
Standard(s)	RSS 137 Issue 2:2009 FCC Part 90 Subpart M	

Vertical – Peak Emission Graph 30 MHz – 1 GHz

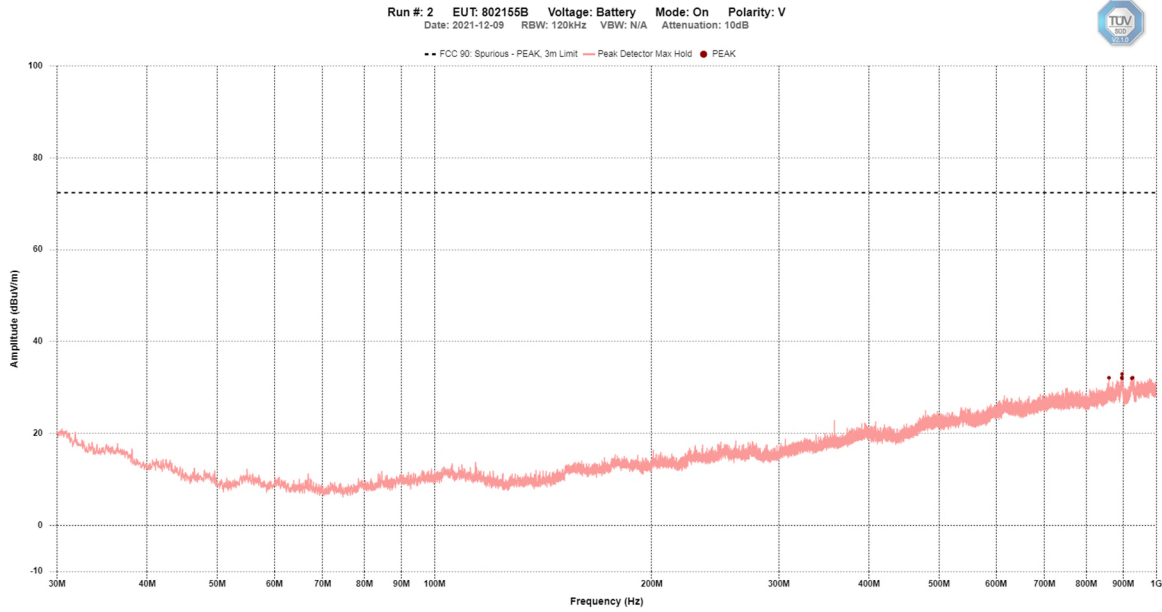

Vertical – Peak Emission Graph 1 GHz – 3.5 GHz

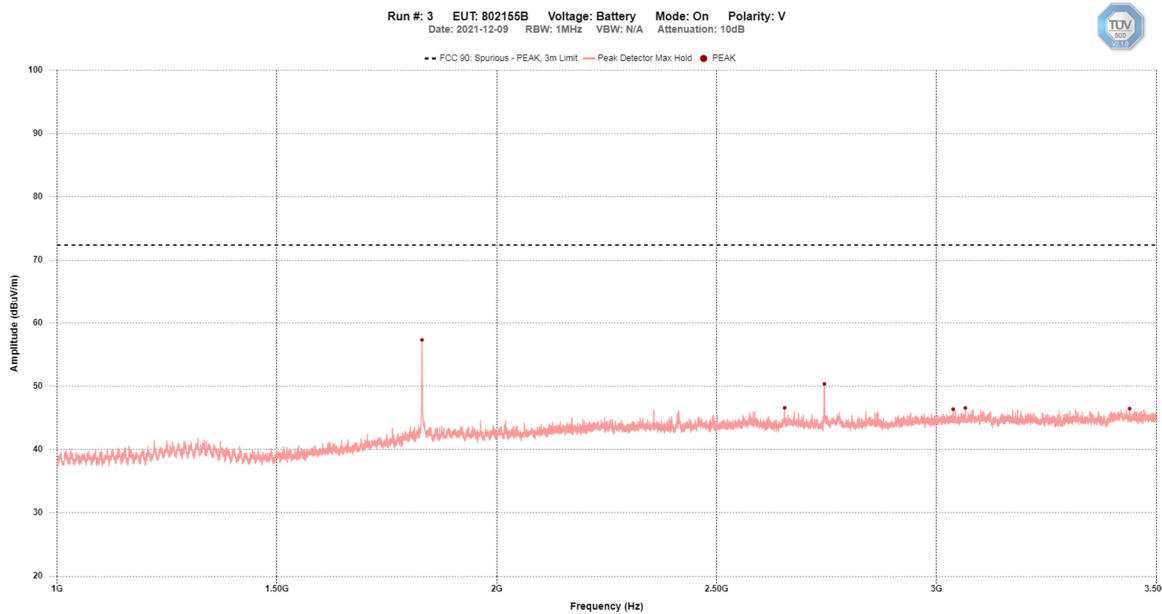

Client	Kapsch TrafficCom Canada Inc	
Product	802155B-TAB	
Standard(s)	RSS 137 Issue 2:2009 FCC Part 90 Subpart M	

Vertical – Peak Emission Graph 3.5 GHz – 10 GHz

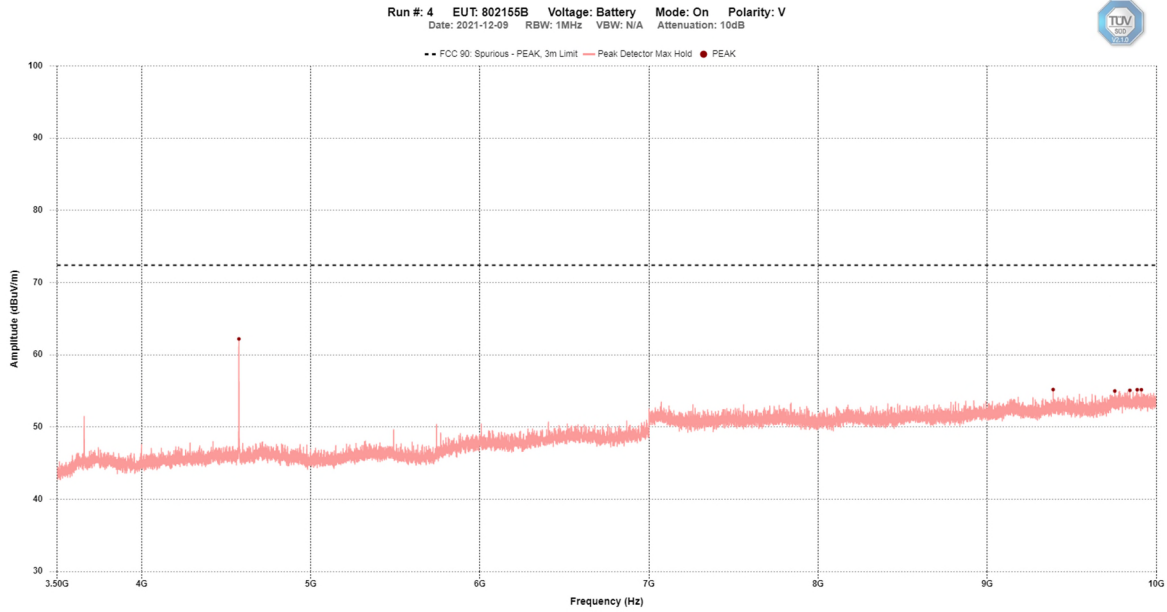

Horizontal – Peak Emission Graph 30 MHz – 1 GHz

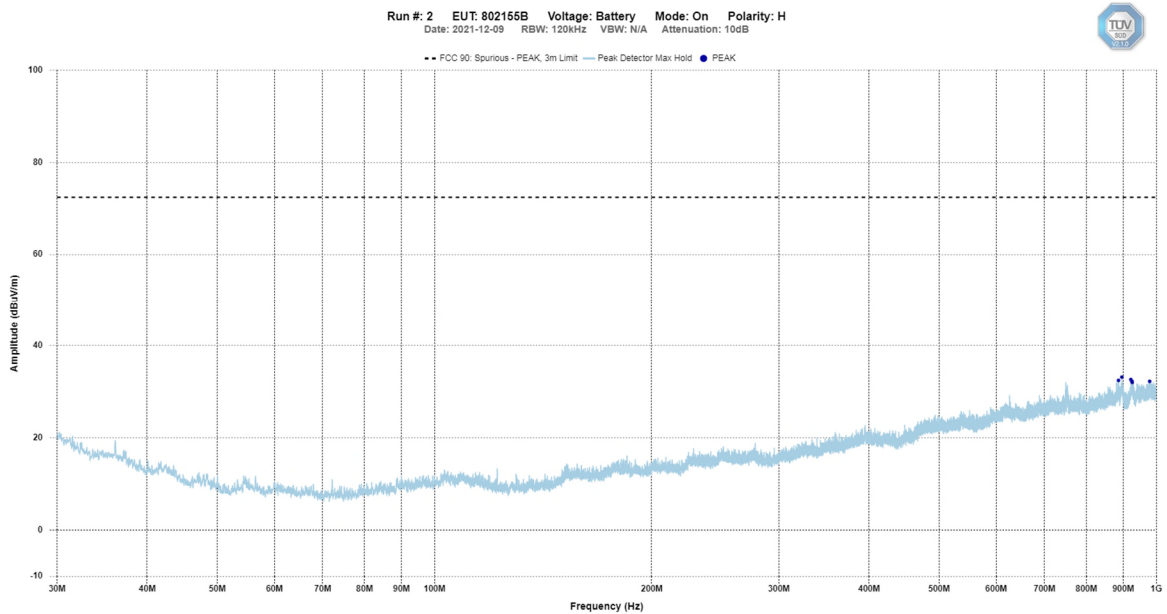

Client	Kapsch TrafficCom Canada Inc	
Product	802155B-TAB	
Standard(s)	RSS 137 Issue 2:2009 FCC Part 90 Subpart M	

Horizontal – Peak Emission Graph 1 GHz – 3.5 GHz

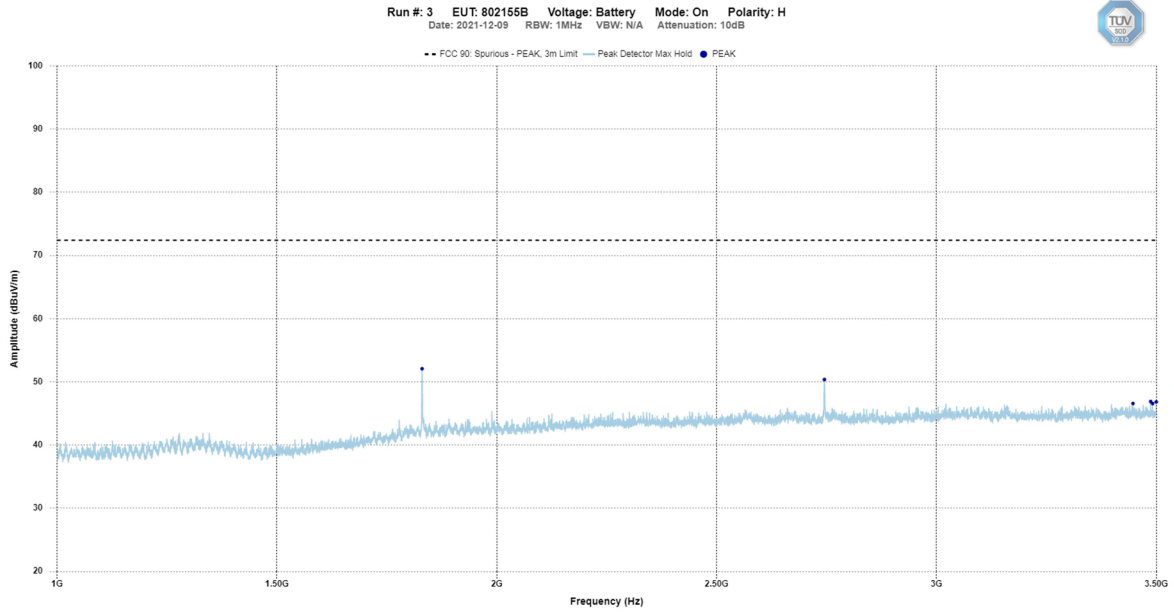

Horizontal – Peak Emission Graph 3.5 GHz – 10 GHz

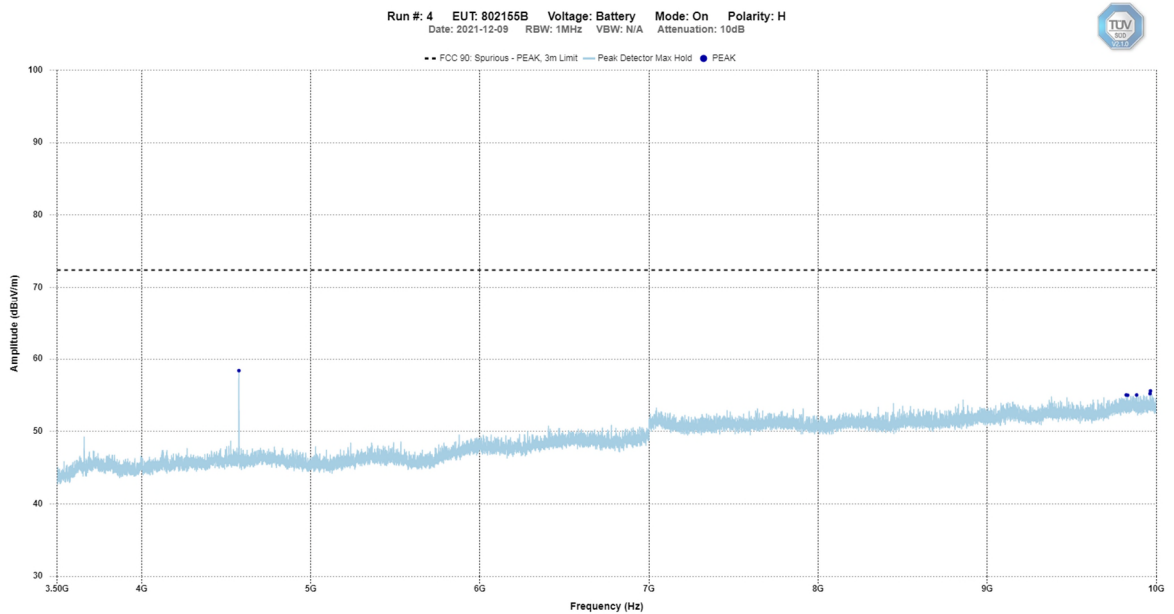

Client	Kapsch TrafficCom Canada Inc	
Product	802155B-TAB	
Standard(s)	RSS 137 Issue 2:2009 FCC Part 90 Subpart M	

Results

Pass.

The EUT meets the Transmitter Spurious Radiated Emissions requirements.

All scans were performed with a measurement bandwidth greater than or equal to the required bandwidth. No peak emissions were above the limit.

Test Equipment List

Equipment	Model No.	Manufacturer	Last Calibration / Verification Date	Next Calibration / Verification Date	Asset #
Spectrum Analyzer	ESR 26	Rohde & Schwarz	Mar. 6, 2020	Mar. 6, 2022	GEMC 341
BiLog Antenna	3142-C	ETS-Lindgren	Mar. 26, 2021	Mar. 26, 2023	GEMC 137
Horn Antenna 1 – 18 GHz	3117	ETS-Lindgren	Feb. 17, 2020	Feb. 17, 2022	GEMC 340
Band Reject Filter	BRC50722	Micro-Tronics	NCR	NCR	GEMC 186
0.98 GHz High pass filter	8IH40-980/T3750	K & L Microwave	NCR	NCR	GEMC 4256
4GHZ-12GHZ High Pass filter	11SH10-4000/T12000-0/0	K & L Microwave	NCR	NCR	GEMC 119
Attenuator 10 dB	612-10-1	Meca Electronics, Inc	NCR	NCR	GEMC 224
Attenuator 6 dB	612-6-1	Meca Electronics, Inc	NCR	NCR	GEMC 287
Pre-Amp 9 kHz – 1 GHz	CPA9230	Chase	May 22, 2020	May 22, 2022	GEMC 301
Pre-Amp 1 – 26.5 GHz	HP 8449B	HP	Aug. 4, 2020	Aug. 4, 2022	GEMC 312
RF Cable <1GHz	LMR-400	LexTec	NCR	NCR	GEMC 27
RF Cable <1GHz	HP305S	Semflex	NCR	NCR	GEMC 310
RF Cable >1GHz	EMC2	MegaPhase	NCR	NCR	GEMC 370
Emissions Software	V2.1.0	TUV SUD Canada, Inc.	NCR	NCR	GEMC 361

Note: GEMC 287 is part of GEMC 8's calibration.

Client	Kapsch TrafficCom Canada Inc	
Product	802155B-TAB	
Standard(s)	RSS 137 Issue 2:2009 FCC Part 90 Subpart M	

Temperature Frequency Stability

Purpose

The purpose of this test is to ensure that the RF energy unintentionally emitted from the EUT does not exceed the permitted bandwidth during extreme temperature variations. This helps protect radio broadcasts and receivers with spectrum nearby to the equipment under test from unwanted interference. This also helps ensure proper reception of the intended signal by ensuring the transmit frequency is correct in any temperature.

Limit(s) and Method

The methods are given in FCC Part 2.1055. The limits given in FCC Part 90.213.

However, the device meets the following condition:

Fixed non-multilateration transmitters with an authorized bandwidth that is more than 40 kHz from the band edge, intermittently operated hand-held readers, and mobile transponders are not subject to frequency tolerance restrictions.

The EUT is an intermittently operated hand-held reader and therefore is not subject to frequency tolerance restrictions. The test was performed for information purpose.

Frequency tolerances measurements are taken for information purpose. Frequency must be maintained from -30 C to +50 C. The EUT is monitored at each 10 degrees increment. At each temperature, the device is checked after a stabilization period required for the device to reach the temperature.

Measurements

The worst-case results are presented, with the frequency shown. The device was checked at each 10 degrees increment of temperature

Temperature	Measured Frequency	Frequency Drift (PPM)
-30	914.954650000	-115.72
-20	914.988210000	-79.04
-10	915.016780000	-47.82
0	915.043360000	-18.77
10	915.057740000	-3.06
20	915.060540000	0.00
30	915.057540000	-3.28
40	915.053150000	-8.08
50	915.049150000	-12.45

Client	Kapsch TrafficCom Canada Inc	
Product	802155B-TAB	
Standard(s)	RSS 137 Issue 2:2009 FCC Part 90 Subpart M	

Test Equipment List

Equipment	Model No.	Manufacturer	Last Calibration Date	Next Calibration Date	Asset #
Spectrum Analyzer	ESR 26	Rohde & Schwarz	Mar. 6, 2020	Mar. 6, 2022	GEMC 341
Attenuator 10 dB	612-10-1	Meca Electronics, Inc	NCR	NCR	GEMC 224
Environmental Chamber	SH-241	Espec	NCR	NCR	CANE00196
Data Acquisition	Tm500	Extech	May 17, 2021	May 17, 2022	CANE00170

Client	Kapsch TrafficCom Canada Inc	
Product	802155B-TAB	
Standard(s)	RSS 137 Issue 2:2009 FCC Part 90 Subpart M	

Appendix A – EUT Summary

Client	Kapsch TrafficCom Canada Inc	
Product	802155B-TAB	
Standard(s)	RSS 137 Issue 2:2009 FCC Part 90 Subpart M	

For further details for filing purposes, refer to filing package.

General EUT Description

Client Details	
Organization / Address	Kapsch TrafficCom Canada Inc 6020 Ambler Drive, Mississauga, Ontario, Canada, L4W 1P1
Contact	Alastair Malarky
Phone	905-624-3020
Email	alastair.malarky@kapsch.net
EUT (Equipment Under Test) Details	
EUT Name (for report title)	CVO-Selftest
EUT Model / SN (if known)	802155B-TAB
EUT revision	New product
Software version	N/A
Equipment category	902-928 MHz, LMS Non-multilateration, mobile transponder
EUT is powered using	Battery 3.6V Internal to EUT
Transmits RF energy? (describe)	Yes 902-928 MHz, LMS Non-multilateration Listen before Talk - Triggered by part 90 licensed reader Transmits fixed frequency 915 +/- 0.6 MHz Transmits burst OOK Manchester, 500 kbps Internal antenna
Testing is required for the following standards	FCC 90 LMS Non-multi-lateration, RSS-137
Basic EUT functionality description	Device responds to specific RF free-space signal (receive) signal and radiates (transmits) short burst of 915 MHz manchester encoded RF free-space signal..
High level block diagram of EUT (attachment)	See 802155B - Exhibit 04 - Block Diagram

Client	Kapsch TrafficCom Canada Inc	
Product	802155B-TAB	
Standard(s)	RSS 137 Issue 2:2009 FCC Part 90 Subpart M	

Step by step instructions for setup and operation	see "802155B Test Article Modifications and Instructions" attached
Customer to setup EUT on site?	Yes The EUT requires no setup. See "802155B Test Article Modifications and Instructions" attached
Frequency of all clocks present in EUT	See 802155B - Exhibit 12 - Operating Description
Peripherals required to exercise EUT Ex. Signal generator	None. See "802155B Test Article Modifications and Instructions" attached
Dimensions of product	L 120mm W 66mm H 23mm

Note the EUT is considered to have been received the date of the commencement of the first test, unless otherwise stated. For a close-up picture of the EUT, see ‘Appendix B – EUT and Test Setup Photos’.