

# Global EMC Inc. Labs EMC & RF Test Report

As per

**FCC Part 90 Subpart M:2015**

&

**RSS-137 Issue 2:2009**

**Location and Monitoring Service (LMS)**

**Operation in the 902 – 928 MHz Band**

on the

## FME Transponder

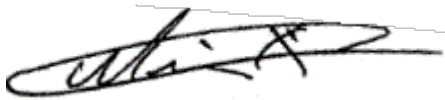

Min Xie  
Project Engineer  
Global EMC Labs Inc  
11 Gordon Collins Dr,  
Gormley, ON, L0H 1G0 Canada  
Ph: (905) 883-8189

Testing produced for

**kapsch** >>>

See Appendix A for full customer & EUT details.



Client	<b>Kapsch TrafficCom Canada Inc</b>	
Product	<b>FME Transponder</b>	
Standard(s)	RSS-137 Issue 2:2009 / FCC Part 90 Subpart M:2015	

## Table of Contents

Table of Contents .....	2
Report Scope .....	3
Summary .....	4
Test Results Summary .....	5
Justifications, Descriptions, or Deviations.....	6
Applicable Standards, Specifications and Methods.....	7
Sample calculation(s).....	8
Document Revision Status.....	8
Definitions and Acronyms .....	9
Testing Facility .....	10
Calibrations and Accreditations.....	10
Testing Environmental Conditions and Dates .....	11
Detailed Test Results Section .....	12
Output Power and Antenna Heights .....	13
Occupied Bandwidth.....	16
Emission Mask.....	19
Transmitter Spurious Radiated Emissions .....	29
Temperature Frequency Stability.....	38
Appendix A – EUT Summary.....	40
Appendix B – EUT and Test Setup Photographs.....	43

Client	<b>Kapsch TrafficCom Canada Inc</b>	
Product	<b>FME Transponder</b>	
Standard(s)	RSS-137 Issue 2:2009 / FCC Part 90 Subpart M:2015	

## Report Scope

This report addresses the EMC verification testing and test results of Kapsch TrafficCom Canada Inc's **FME Transponder**, Model 801800B-TAB herein referred to as EUT (Equipment Under Test) performed at Global EMC Labs. The EUT was tested for compliance against the following standards:

FCC Part 90 Subpart M:2015  
 RSS-137 Issue 2:2009

Test procedures, results, justifications, and engineering considerations, if any, follow later in this report.

The results contained in this report relate only to the item(s) tested.

This report does not imply product endorsement by A2LA or any other accreditation agency, any government, or Global EMC Inc.

Opinions/interpretations expressed in this report, if any, are outside the scope of Global EMC Inc accreditation. Any opinions expressed do not necessarily reflect the opinions of Global EMC Inc, unless otherwise stated.

Client	<b>Kapsch TrafficCom Canada Inc</b>	
Product	<b>FME Transponder</b>	
Standard(s)	RSS-137 Issue 2:2009 / FCC Part 90 Subpart M:2015	

## Summary

The results contained in this report relate only to the item(s) tested.

EUT FCC Certification #, FCC ID:	JQU801800B
EUT Industry Canada Certification #, IC:	2665A-801800B
EUT Passed all tests performed.	Yes (see test results summary)
Tests conducted by	Min Xie

Client	<b>Kapsch TrafficCom Canada Inc</b>	
Product	<b>FME Transponder</b>	
Standard(s)	RSS-137 Issue 2:2009 / FCC Part 90 Subpart M:2015	

## Test Results Summary

Standard/Method	Description	Limit	Result
FCC 90.205 RSS-137 Clause 6.4	Output Power	30 W	Pass
FCC 90.207 RSS-137 Clause 6.2	Types of Modulation	--	Pass See Justifications
FCC 90.209 RSS-137 Clause 6.1.2	Occupied Bandwidth	902 - 904 MHz: 2 MHz 909.75 - 921.75 MHz 12 MHz	Pass
FCC 90.210 (K) RSS-137 Clause 6.5.3	Spurious antenna port conducted emissions	$55 + 10 \log_{10} P_{max}$ dB.	Pass See Justifications
FCC 90.210 RSS-137 Clause 6.5.3	Spurious radiated emissions	$55 + 10 \log_{10} P_{max}$ dB.	Pass
FCC 90.213 RSS-137 Clause 6.3	Frequency stability	2.5 ppm	Pass
FCC 90.214	Transient Behavior	--	N/A See Justifications
<b>Overall Result</b>			<b>PASS</b>

All tests other than spurious radiated emissions were performed by Min Xie.

If the product as tested or otherwise complies with the specification, the EUT is deemed to comply with the requirement and is deemed a 'PASS' grade. If not 'FAIL' grade will be issued. Note that 'PASS' / 'FAIL' grade is independent of any measurement uncertainties.

Client	<b>Kapsch TrafficCom Canada Inc</b>	
Product	<b>FME Transponder</b>	
Standard(s)	RSS-137 Issue 2:2009 / FCC Part 90 Subpart M:2015	

### ***Justifications, Descriptions, or Deviations***

The following justifications for tests not performed or deviations from the above listed specifications apply:

The EUT uses Shaped ON-OFF Keying to transmit information. According to FCC 90.207, the EUT is classified as K1D type of emission.

For FCC 90.214, the EUT operates in the 902-928 MHz band, and this requirement is not applicable.

For the requirements of FCC 90.210 (K) and FCC 2.1053 Measurements required: Field strength of spurious radiation. Spurious radiated emissions of the EUT was performed at 3 meters. The limit specified in FCC 90.210 (K) is: On any frequency outside the licensee's sub-band edges, the peak power of any emission shall be attenuated by  $55 + 10 \log(P)$  where P is the highest emission (Watts) of the transmitter. For all intensive purposes, the limit is -25 dBm ERP. The 3 meter field strength limit for the EUT is given below:

$$E(\text{dB}\mu\text{V}/\text{m}) = \text{ERIP}(\text{dBm}) + 95.2$$

$$\text{Where EIRP} = \text{ERP} + 2.15$$

$$E(\text{dB}\mu\text{V}/\text{m}) = \text{ERP}(\text{dBm}) + 97.35$$

$$E(\text{dB}\mu\text{V}/\text{m}) = -25 \text{ dBm} + 97.35 = 72.35 \text{ dBuV}$$

This limit is applicable to all emission at 3 meter measurement distance.

Client	<b>Kapsch TrafficCom Canada Inc</b>	
Product	<b>FME Transponder</b>	
Standard(s)	RSS-137 Issue 2:2009 / FCC Part 90 Subpart M:2015	

## ***Applicable Standards, Specifications and Methods***

ANSI C63.4:2009      Methods of Measurement of Radio-Noise Emissions from Low-Voltage Electrical and Electronic Equipment in the Range of 9 kHz to 40 GHz

ANSI/TIA-603-C-2004  
Land Mobile FM or PM Communications Equipment Measurement and Performance Standards

CFR 47 FCC Part 2 Subpart J –  
Code of Federal Regulations – Equipment Authorization Procedure

CFR 47 FCC Part 90    Code of Federal Regulations – Private Land Mobile Radio Services

FCC KDB 412172      D01 Determining ERP and EIRP v01

ISO 17025:2005      General Requirements for the competence of testing and calibration laboratories

RSS-GEN:2014      Issue 4: General Requirements and Information for the Certification of Radio Apparatus

RSS 137:2009      Issue 2: Spectrum Management and Telecommunications. Radio Standards Specification, Location and Monitoring Service in the Band 902-928 MHz.

Client	<b>Kapsch TrafficCom Canada Inc</b>	
Product	<b>FME Transponder</b>	
Standard(s)	RSS-137 Issue 2:2009 / FCC Part 90 Subpart M:2015	

### ***Sample calculation(s)***

Margin = limit – (received signal + antenna factor + cable loss – pre-amp gain)

Margin = 50.5dBuV/m – (50dBuV + 10dB + 2.5dB – 20dB)

Margin = 8.5 dB

Reference Offset = Attenuator + Cable Loss

Reference Offset = 10 dB + 0.4 dB

Reference Offset = 10.4 dB

### ***Document Revision Status***

Revision 1 - October 15, 2015

Initial release



Client	<b>Kapsch TrafficCom Canada Inc</b>	
Product	<b>FME Transponder</b>	
Standard(s)	RSS-137 Issue 2:2009 / FCC Part 90 Subpart M:2015	

## Definitions and Acronyms

The following definitions and acronyms are applicable in this report.  
See also ANSI C63.14.

**AE** – Auxillary Equipment.

**BW** – Bandwidth. Unless otherwise stated, this refers to the 6 dB bandwidth.

**EMC** – Electro-Magnetic Compatibility

**EMI** – Electro-Magnetic Immunity

**EUT** – Equipment Under Test

**ITE** – Information Technology Equipment with a primary function(s) of entry, storage, display, retrieval, transmission, processing, switching, or control, of data.

**LISN** – Line impedance stabilization network

**NCR** – No Calibration Required

**RF** – Radio Frequency

Client	<b>Kapsch TrafficCom Canada Inc</b>	
Product	<b>FME Transponder</b>	
Standard(s)	RSS-137 Issue 2:2009 / FCC Part 90 Subpart M:2015	

## Testing Facility

Testing for EMC on the EUT was carried out at Global EMC labs in 11 Gordon Collins, Gormley, Ontario, Canada. The testing lab consists of a 3m semi-anechoic chamber calibrated to be able to allow measurements on an EUT with a maximum width or length of up to 2m and height up to 3m. The chamber is equipped with a turn table that is capable of testing devices up to 3300lb in weight. This facility is capable of testing products that are rated for 120 Vac and 240Vac single phase, or 208 Vac 3 phase input. DC capability is also available. The chamber is equipped with an antenna mast that controls polarization and height from the control room adjoining the shielded chamber. Radiated emissions measurements are performed using a Bilog, and Horn antenna where applicable. Conducted emissions, unless otherwise stated, are performed using a LISN.

### **Calibrations and Accreditations**

The 3m semi-anechoic chamber is registered with Federal Communications Commission (FCC, 377448), Industry Canada (IC, 6844A-3) and VCCI (R-4023, G-506, T-1246, and C-4498). This semi-anechoic chamber complies with the requirements of EN55016-2-3:2006, section 7.5 and the site attenuation requirements of EN55016-1-4. This chamber was additionally calibrated for Normalized Site Attenuation (NSA) using test procedures outlined in ANSI C63.4 “Methods of Measurement of Radio-Noise Emissions from Low-Voltage Electrical and Electronic Equipment in the Range of 9 kHz to 40 GHz”. The chamber is lined with ferrite tiles and absorption cones to minimize any undesired reflections. The NSA data is kept on file at Global EMC. For radiated susceptibility testing, a 16 point field calibration has been performed on the chamber. The field uniformity data is kept on file at Global EMC. Global EMC Inc is accredited to ISO 17025 by A2LA with Testing Certificate #2555.01. The laboratories current scope of accreditation listing can be found as listed on the A2LA website. All measuring equipment is calibrated on an annual or bi-annual basis as listed for each respective test.

Client	<b>Kapsch TrafficCom Canada Inc</b>	
Product	<b>FME Transponder</b>	
Standard(s)	RSS-137 Issue 2:2009 / FCC Part 90 Subpart M:2015	

### ***Testing Environmental Conditions and Dates***

Following were the environmental conditions in the facility during time of testing –

<b>Date</b>	<b>Test</b>	<b>Init.</b>	<b>Temperature (°C)</b>	<b>Humidity (%)</b>	<b>Pressure (kPa)</b>
2015/07/10	Output Power	MX	20-24°C	35 – 41%	96 -102kPa
2015/07/10	Occupied Bandwidth	MX	20-24°C	35 – 41%	96 -102kPa
2015/07/10	Spurious Antenna conducted	MX	20-24°C	35 – 41%	96 -102kPa
2015/07/10	Frequency stability	MX	20-24°C	35 – 41%	96 -102kPa
2015/07/09	Radiated spurious	MX	20-24°C	35 – 41%	96 -102kPa

Client	<b>Kapsch TrafficCom Canada Inc</b>	
Product	<b>FME Transponder</b>	
Standard(s)	RSS-137 Issue 2:2009 / FCC Part 90 Subpart M:2015	

**Detailed Test Results Section**

Client	<b>Kapsch TrafficCom Canada Inc</b>	
Product	<b>FME Transponder</b>	
Standard(s)	RSS-137 Issue 2:2009 / FCC Part 90 Subpart M:2015	

## ***Output Power and Antenna Heights***

### **Purpose**

The purpose of this test is to ensure that the maximum power conducted to the radiating element does not exceed the limits specified.

### **Limits**

The limits are defined in FCC Part 90.205 (l) and RSS 137 Clause 6.4 as per the following paragraph:

902-928 MHz. LMS systems operating pursuant to subpart M of this part in the 902-927.25 MHz band will be authorized a maximum of 30 watts ERP. LMS equipment operating in the 927.25-928 MHz band will be authorized a maximum of 300 watts ERP. ERP must be measured as peak envelope power. Antenna heights will be as specified in §90.353(h).

### **Results**

The EUT passed.

The EUT supports one protocols and operates only on a single channel. The EUT has a permanently connected antenna. Thus antenna height is not applicable.

Frequency (MHz)	Power (dBm)	Antenna Gain (dBd)	ERP (dBm)	ERP (mW)
915.0	-0.15	3.25	3.10	2.04

Client	Kapsch TrafficCom Canada Inc	
Product	FME Transponder	
Standard(s)	RSS-137 Issue 2:2009 / FCC Part 90 Subpart M:2015	

### Graph(s)

The graphs below show examples of the Peak Power during the operation of the device. Measurements were performed using a spectrum analyzer with a Peak detector of 10 MHz RBW. This measurement is a peak measurement. Max hold is performed for a duration of not less than 1 minute.

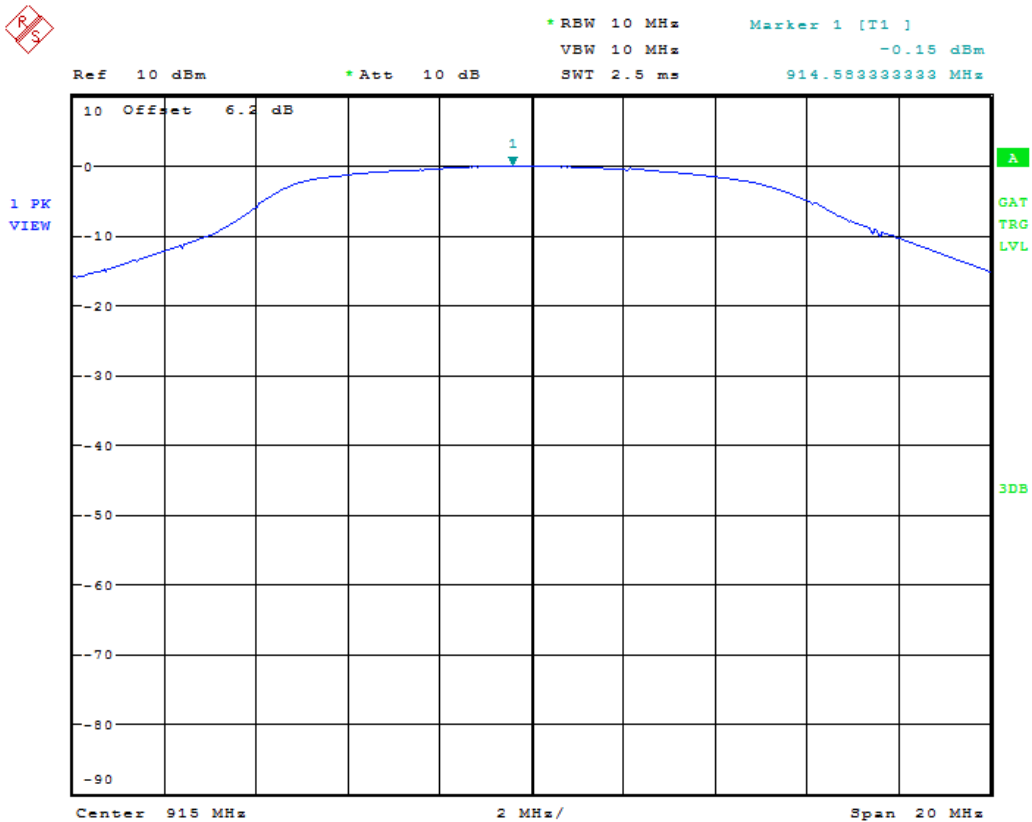

Date: 10.JUL.2015 12:47:32

Note: See 'Appendix B – EUT & Test Setup Photographs' for photos showing the test set-up.

Client	<b>Kapsch TrafficCom Canada Inc</b>	
Product	<b>FME Transponder</b>	
Standard(s)	RSS-137 Issue 2:2009 / FCC Part 90 Subpart M:2015	

### Test Equipment List

Equipment	Model No.	Manufacturer	Last calibration date	Next calibration due date	Asset #
Spectrum Analyzer	FSU	Rohde & Schwarz	1/19/2015	1/19/2017	GEMC 198

Client	<b>Kapsch TrafficCom Canada Inc</b>	
Product	<b>FME Transponder</b>	
Standard(s)	RSS-137 Issue 2:2009 / FCC Part 90 Subpart M:2015	

## Occupied Bandwidth

### Purpose

The purpose of this test is to ensure that the bandwidth occupied exceeds a stated minimum. This helps ensure the utilization of the frequency allocation is sufficiently wide. This also helps prevent corruption of data by ensuring adequate data separation to distinguish the reception of the intended information.

### Limits

The Limit is as specified in FCC Part 90.209 and RSS-137 Clause 6.1.2.

The maximum authorized bandwidth shall be 12 MHz for non-multilateration LMS operations in the band 909.75-921.75 MHz and 2 MHz in the band 902.00-904.00 MHz. The maximum authorized bandwidth for multilateration LMS operations shall be 5.75 MHz in the 904.00-909.75 MHz band; 2 MHz in the 919.5-921.75 MHz band; 5.75 MHz in the 921.75-927.25 MHz band and its associated 927.25-927.50 MHz narrowband forward link; and 8.00 MHz if the 919.75-921.75 MHz and 921.75-927.25 MHz bands and their associated 927.25-927.50 MHz and 927.50-927.75 MHz narrowband forward links are aggregated.

### Results

The EUT passed.

Frequency (MHz)	99% Bandwidth (MHz)
915.0	7.10



Client	Kapsch TrafficCom Canada Inc	
Product	FME Transponder	
Standard(s)	RSS-137 Issue 2:2009 / FCC Part 90 Subpart M:2015	

### Graph(s)

The graphs showed below shows the OBW during the operation of the device. This is measured by a max hold on the spectrum analyzer and the highest resolution bandwidth that is sufficiently low to exhibit the 99% bandwidth of a channel during operation of the EUT. This measurement is a peak measurement. Max hold is performed for a duration of not less than 1 minute.

#### 99 % Bandwidth

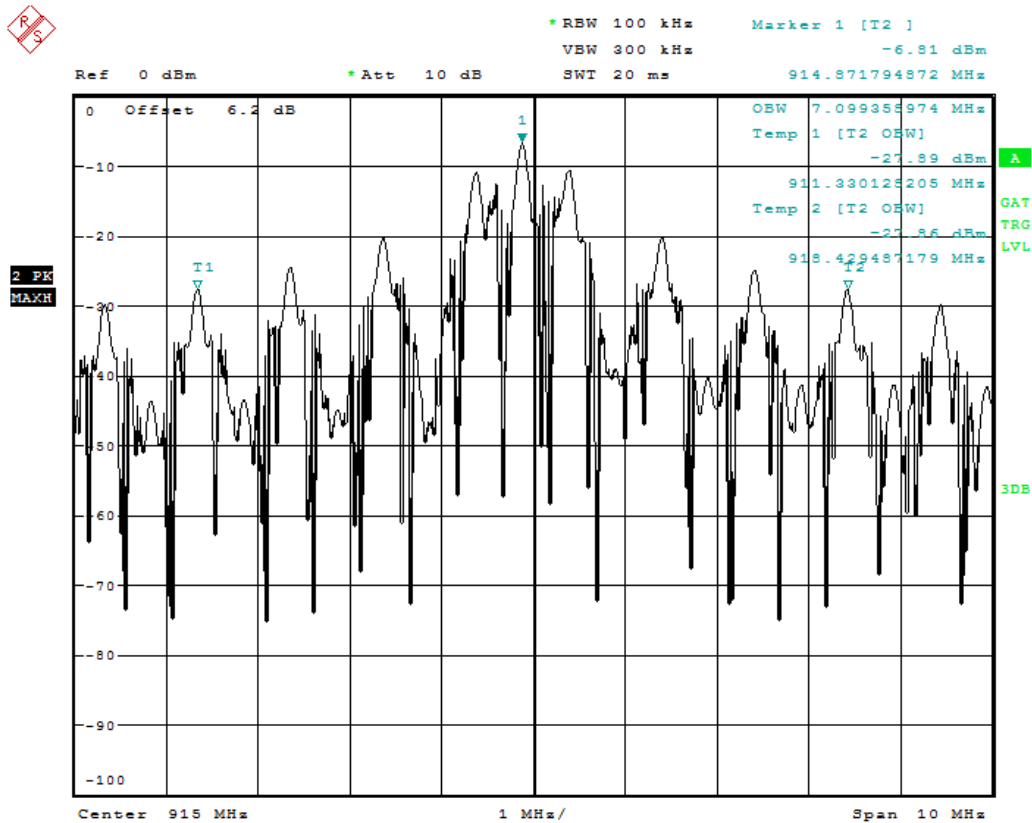

Date: 10.JUL.2015 13:07:23

Note: See 'Appendix B – EUT & Test Setup Photographs' for photos showing the test set-up.

Client	<b>Kapsch TrafficCom Canada Inc</b>	
Product	<b>FME Transponder</b>	
Standard(s)	RSS-137 Issue 2:2009 / FCC Part 90 Subpart M:2015	

## Test Equipment List

Equipment	Model No.	Manufacturer	Last calibration date	Next calibration due date	Asset #
Spectrum Analyzer	FSU	Rohde & Schwarz	1/19/2015	1/19/2017	GEMC 198

This report module is based on GEMC template "FCC – Power Line Conducted Emissions Class B\_Rev1"

Client	<b>Kapsch TrafficCom Canada Inc</b>	
Product	<b>FME Transponder</b>	
Standard(s)	RSS-137 Issue 2:2009 / FCC Part 90 Subpart M:2015	

## ***Emission Mask***

### **Purpose**

The purpose of this test is to ensure that the maximum power conducted to the radiating element at frequencies outside of the authorized spectrum does not exceed the limits specified. This ensures that the only the intended signal is delivered to the radiating element.

### **Limits**

The Limit is as specified in FCC Part 90.210 (K) and RSS-137 Clause 6.5.3

Emission Mask K—(1) Wideband multilateration transmitters. For transmitters authorized under subpart M to provide forward or reverse links in a multilateration system in the subbands 904-909.75 MHz, 921.75-927.25 MHz and 919.75-921.75 MHz, and which transmit an emission occupying more than 50 kHz bandwidth: in any 100 kHz band, the center frequency of which is removed from the center of authorized sub-band(s) by more than 50 percent of the authorized bandwidth, the power of emissions shall be attenuated below the transmitter output power, as specified by the following equation, but in no case less than 31 dB:

$$A=16+0.4 (D-50)+10 \log B \text{ (attenuation greater than 66 dB is not required)}$$

Where:

- A = attenuation (in decibels) below the maximum permitted output power level
- D = displacement of the center frequency of the measurement bandwidth from the center frequency of the authorized sub-band, expressed as a percentage of the authorized bandwidth B
- B = authorized bandwidth in megahertz.

(2) Narrowband forward link transmitters. For LMS multilateration narrowband forward link transmitters operating in the 927.25-928 MHz frequency band the power of any emission shall be attenuated below the transmitter output power (P) in accordance with following schedule:

On any frequency outside the authorized sub-band and removed from the edge of the authorized sub-band by a displacement frequency ( $f_d$  in kHz): at least  $116 \log ((f_d+10)/6.1)$  dB or  $50 + 10 \log (P)$  dB or 70 dB, whichever is the lesser attenuation.

(3) Other transmitters. For all other transmitters authorized under subpart M that operate in the 902-928 MHz band, the peak power of any emission shall be attenuated below the

Client	<b>Kapsch TrafficCom Canada Inc</b>	
Product	<b>FME Transponder</b>	
Standard(s)	RSS-137 Issue 2:2009 / FCC Part 90 Subpart M:2015	

power of the highest emission contained within the licensee's sub-band in accordance with the following schedule:

- (i) On any frequency within the authorized bandwidth: Zero dB.
- (ii) On any frequency outside the licensee's sub-band edges:  $55 + 10 \log(P)$  dB, where (P) is the highest emission (watts) of the transmitter inside the licensee's sub-band.

(4) In the 902-928 MHz band, the resolution bandwidth of the instrumentation used to measure the emission power shall be 100 kHz, except that, in regard to paragraph (2) of this section, a minimum spectrum analyzer resolution bandwidth of 300 Hz shall be used for measurement center frequencies with 1 MHz of the edge of the authorized subband. The video filter bandwidth shall not be less than the resolution bandwidth.

(5) Emission power shall be measured in peak values.

(6) The LMS sub-band edges for non-multilateration systems for which emissions must be attenuated are 902.00, 904.00, 909.5 and 921.75 MHz.

Note: The EUT is a non- multilateration LMS transmitter. Emission limit (3) applies to the EUT. A  $55 + 10 \log(P)$  dB attenuation (or -25 dBm absolute emission level) was applied all frequency from the outside authorized band.

Test procedure is as per eCFR 47 Part 2 Clause 2.1051.

## Results

The EUT passed; it meets attenuation requirement at the antenna port.

The worst case is presented as a graph for the spectrum. Band edge requirements were shown for the lower band edge at 909.5 MHz in the low band where applicable. Band edge requirements were also shown for the higher band edge at 921.75 MHz in the high band where applicable.

Client	<b>Kapsch TrafficCom Canada Inc</b>	
Product	<b>FME Transponder</b>	
Standard(s)	RSS-137 Issue 2:2009 / FCC Part 90 Subpart M:2015	

### Graph(s)

The graphs shown below shows the peak power output of the device during the antenna conducted measurement during transmit operation of the EUT.

### 30 MHz – 1 GHz

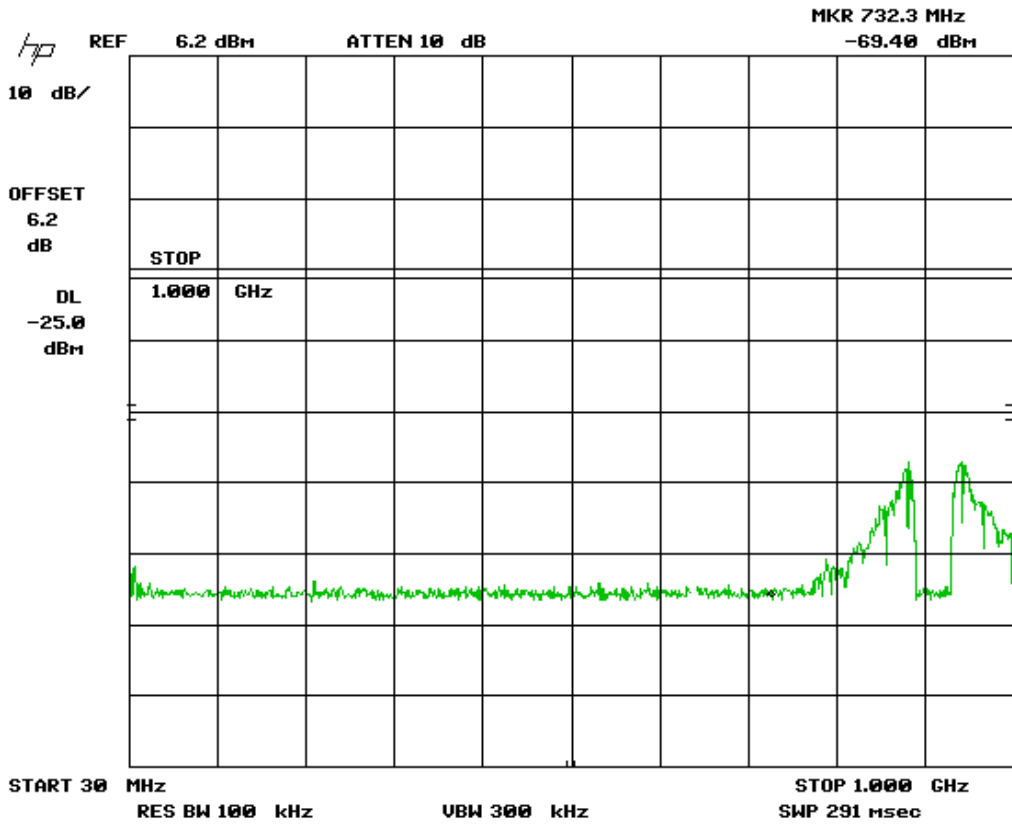

Client	Kapsch TrafficCom Canada Inc	
Product	FME Transponder	
Standard(s)	RSS-137 Issue 2:2009 / FCC Part 90 Subpart M:2015	

1 GHz – 2 GHz

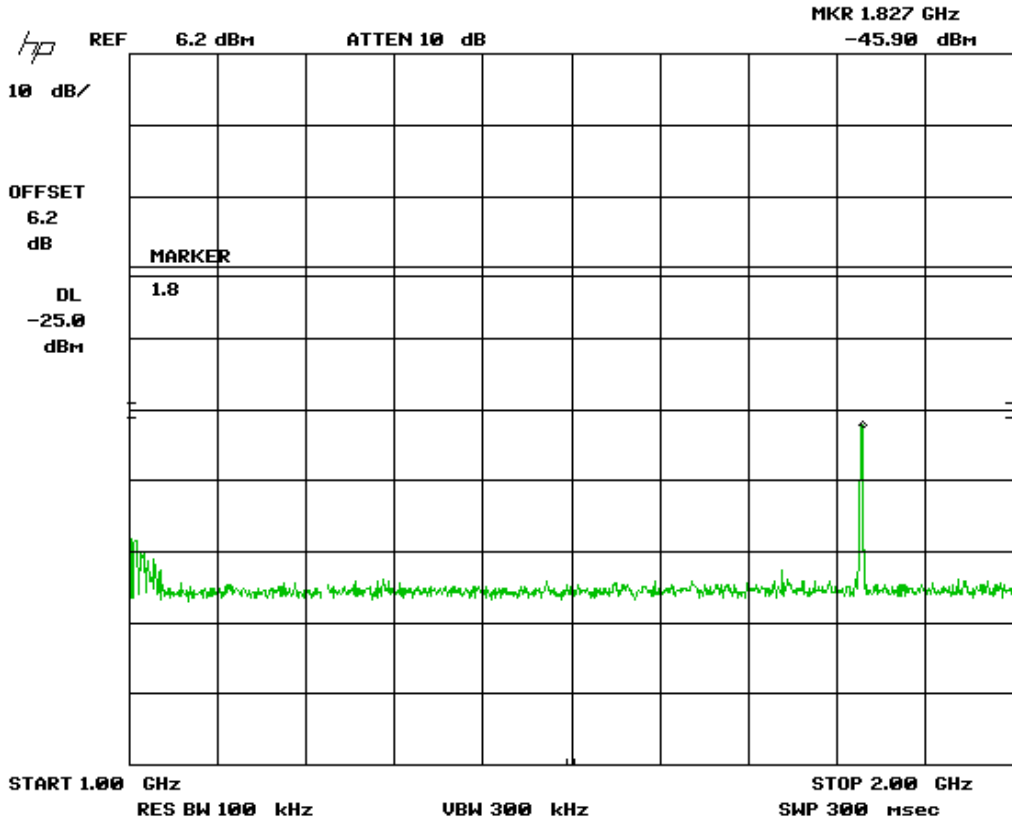

Client	Kapsch TrafficCom Canada Inc	
Product	FME Transponder	
Standard(s)	RSS-137 Issue 2:2009 / FCC Part 90 Subpart M:2015	

2 GHz – 4 GHz

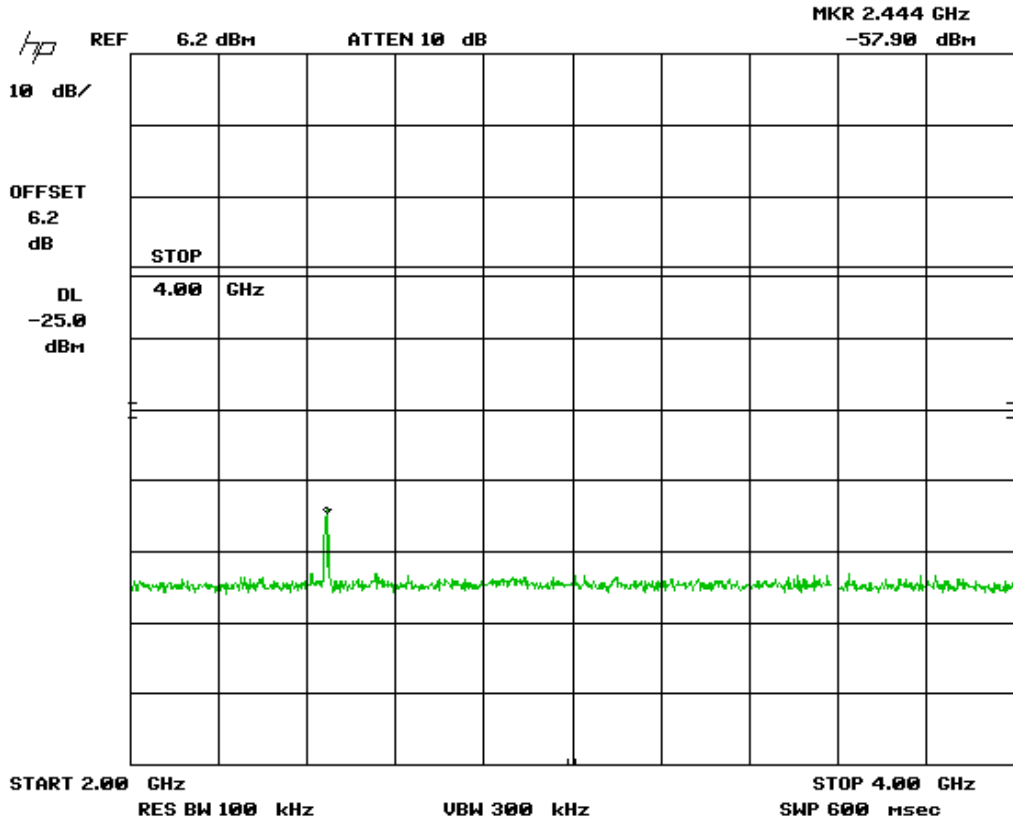

Client	Kapsch TrafficCom Canada Inc	
Product	FME Transponder	
Standard(s)	RSS-137 Issue 2:2009 / FCC Part 90 Subpart M:2015	

4 GHz – 6 GHz

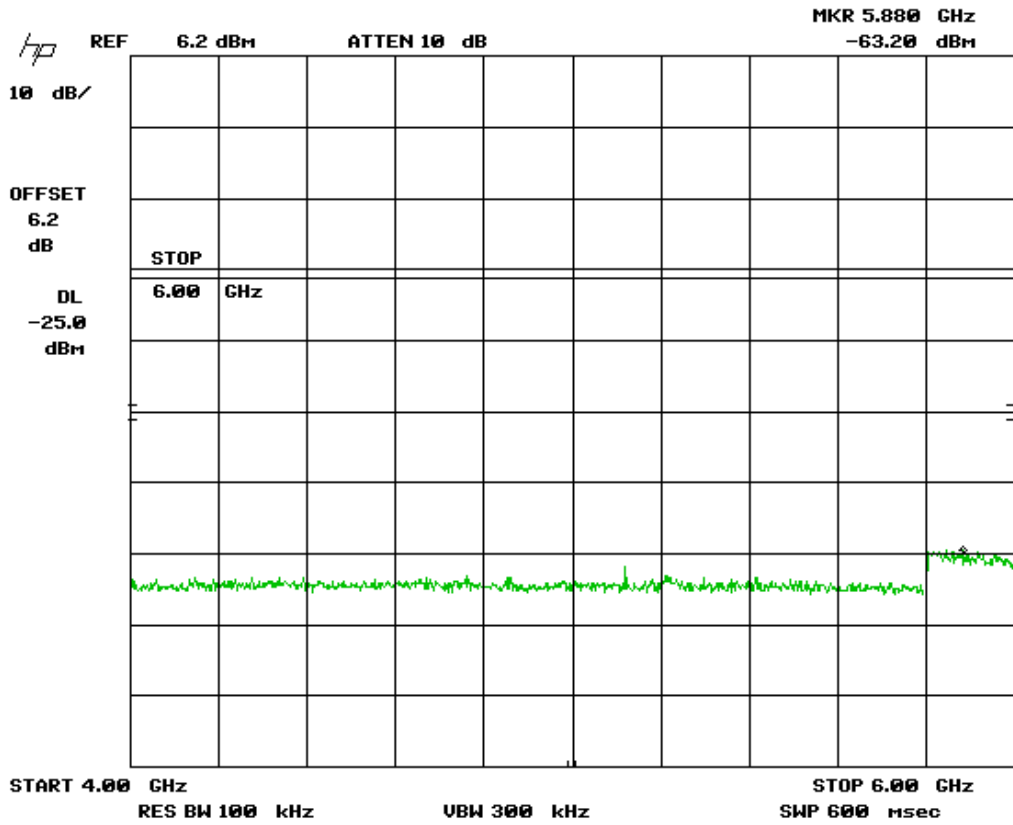



Client	Kapsch TrafficCom Canada Inc	
Product	FME Transponder	
Standard(s)	RSS-137 Issue 2:2009 / FCC Part 90 Subpart M:2015	

6 GHz – 10 GHz

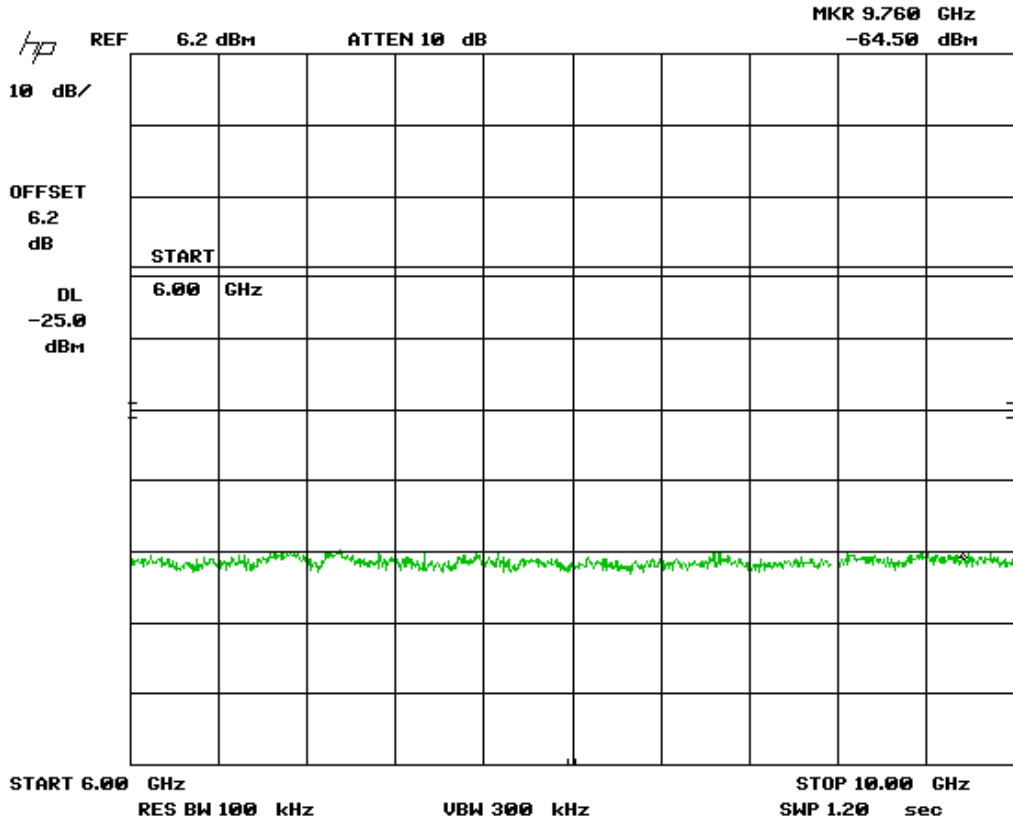

Client	Kapsch TrafficCom Canada Inc	
Product	FME Transponder	
Standard(s)	RSS-137 Issue 2:2009 / FCC Part 90 Subpart M:2015	

### 909.5 MHz Band Edge

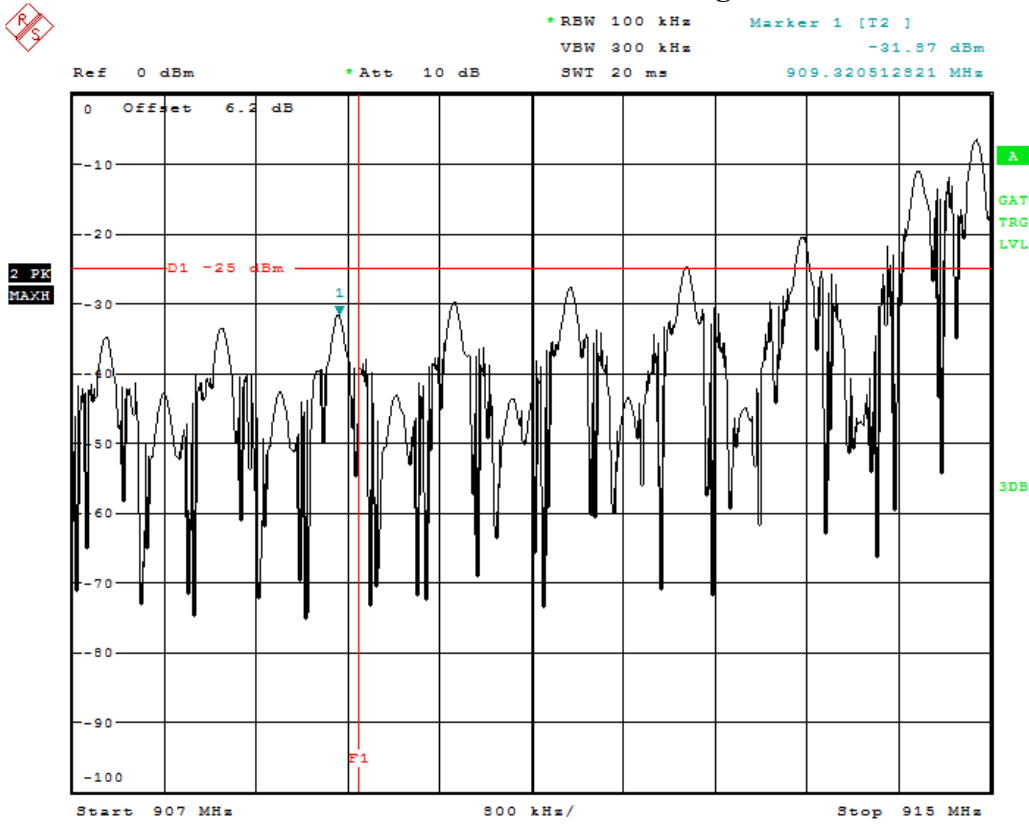

Date: 10.JUL.2015 13:33:32

Client	Kapsch TrafficCom Canada Inc	
Product	FME Transponder	
Standard(s)	RSS-137 Issue 2:2009 / FCC Part 90 Subpart M:2015	

### 921.75 MHz Band Edge

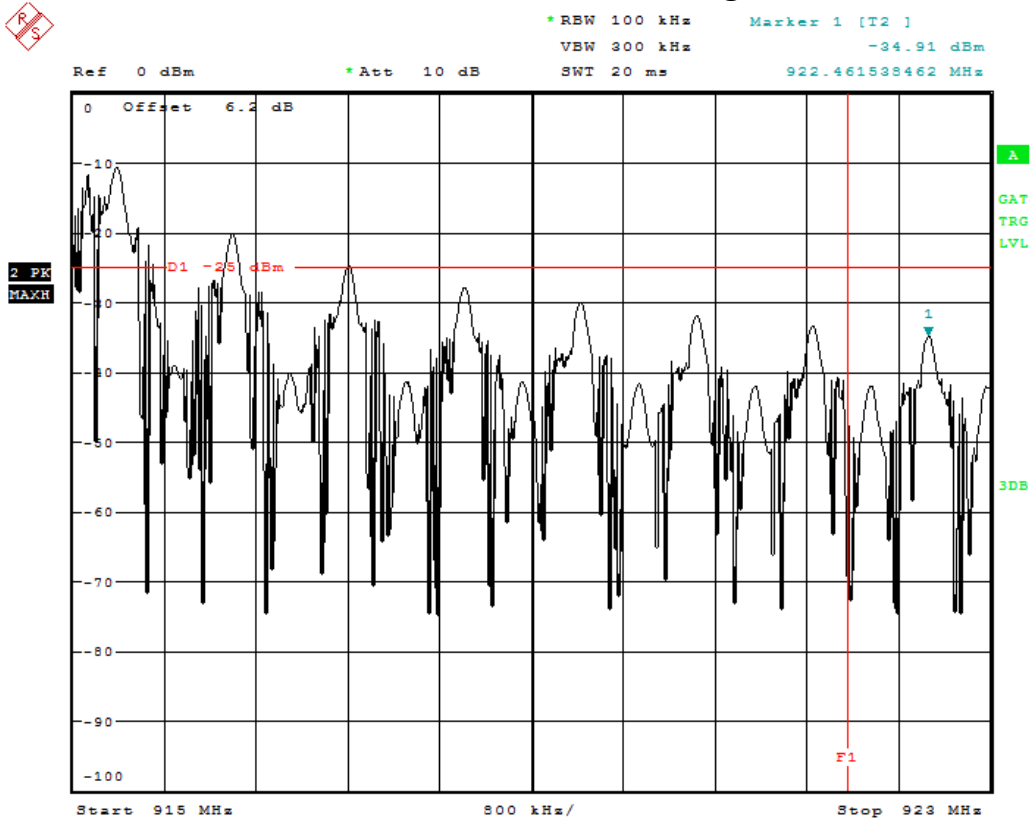

Date: 10.JUL.2015 13:35:30

See 'Appendix B – EUT & Test Setup Photographs' for photos showing the test set-up.

Client	<b>Kapsch TrafficCom Canada Inc</b>	
Product	<b>FME Transponder</b>	
Standard(s)	RSS-137 Issue 2:2009 / FCC Part 90 Subpart M:2015	

## Final Measurements

Note: All measurements were made with an power splitter / combiner. The insertion loss were adjusted with Reference Level Offset function in the spectrum analyzer.

Frequency (MHz)	Level (dBm)	Limit (dBm)	Margin (dB)
909.5	-31.9	-25	6.9
921.5	-34.9	-25	9.9
1827	-45.9	-25	20.9
2444	-57.9	-25	32.9

## Test Equipment List

Equipment	Model No.	Manufacturer	Last calibration date	Next calibration due date	Asset #
Spectrum Analyzer	FSU	Rohde & Schwarz	1/19/2015	1/19/2017	GEMC 198
1.2 GHz High pass filter	5IH30-1078	K & L Microwave	NCR	NCR	GEMC118
Band Reject Filter	BRC50722	Micro-Tronics	NCR	NCR	GEMC 186
Spectrum Analyzer	8566B	HP	2013-10-02	2015-10-02	GEMC190
Quasi Peak Adapter	85650A	HP	2013-10-01	2015-10-01	GEMC191
RF Cable 1m	LMR-400-1M-50OHM-MN-MN	LexTec	NCR	NCR	GEMC 29

This report module is based on GEMC template "FCC – Power Line Conducted Emissions Class B\_Rev1"

Client	<b>Kapsch TrafficCom Canada Inc</b>	
Product	<b>FME Transponder</b>	
Standard(s)	RSS-137 Issue 2:2009 / FCC Part 90 Subpart M:2015	

## ***Transmitter Spurious Radiated Emissions***

### **Purpose**

The purpose of this test is to ensure that the RF energy unintentionally emitted from the EUT does not exceed the limits listed below as defined in the applicable test standard, as measured from a receiving antenna. This helps protect broadcast radio services such as television, FM radio, pagers, cellular telephones, emergency services, and so on, from unwanted interference.

### **Limit(s) and Method**

The method is as defined in FCC 2.1053 and the limits are as defined in FCC Part 90.210(K).

(3) *Other transmitters.* For all other transmitters authorized under subpart M that operate in the 902-928 MHz band, the peak power of any emission shall be attenuated below the power of the highest emission contained within the licensee's sub-band in accordance with the following schedule:

(i) On any frequency within the authorized bandwidth: Zero dB.

(ii) On any frequency outside the licensee's sub-band edges:  $55 + 10 \log(P)$  dB, where (P) is the highest emission (watts) of the transmitter inside the licensee's sub-band.

Spurious radiated emissions of the EUT was performed at 3 meters. The limit specified in FCC 90.210 (K) is  $55 + 10 \log(P)$  dBc. For all intensive purpose, the limit is -25 dBm. The field strength limit for the EUT is give in the below:

$$E(\text{dB}\mu\text{V}/\text{m}) = \text{ERIP}(\text{dBm}) + 95.2$$

$$\text{Where EIRP} = \text{ERP} + 2.15$$

$$E(\text{dB}\mu\text{V}/\text{m}) = \text{ERP} (\text{dBm}) + 97.35$$

$$E(\text{dB}\mu\text{V}/\text{m}) = -25 \text{ dBm} + 97.35 = 72.35 \text{ dBuV}$$

This limit is applicable all emission at 3 meter measurement distance.

The Limit is with 100 kHz measurement bandwidth and using a Peak detector.

Client	<b>Kapsch TrafficCom Canada Inc</b>	
Product	<b>FME Transponder</b>	
Standard(s)	RSS-137 Issue 2:2009 / FCC Part 90 Subpart M:2015	

**Typical Radiated Emissions Setup**

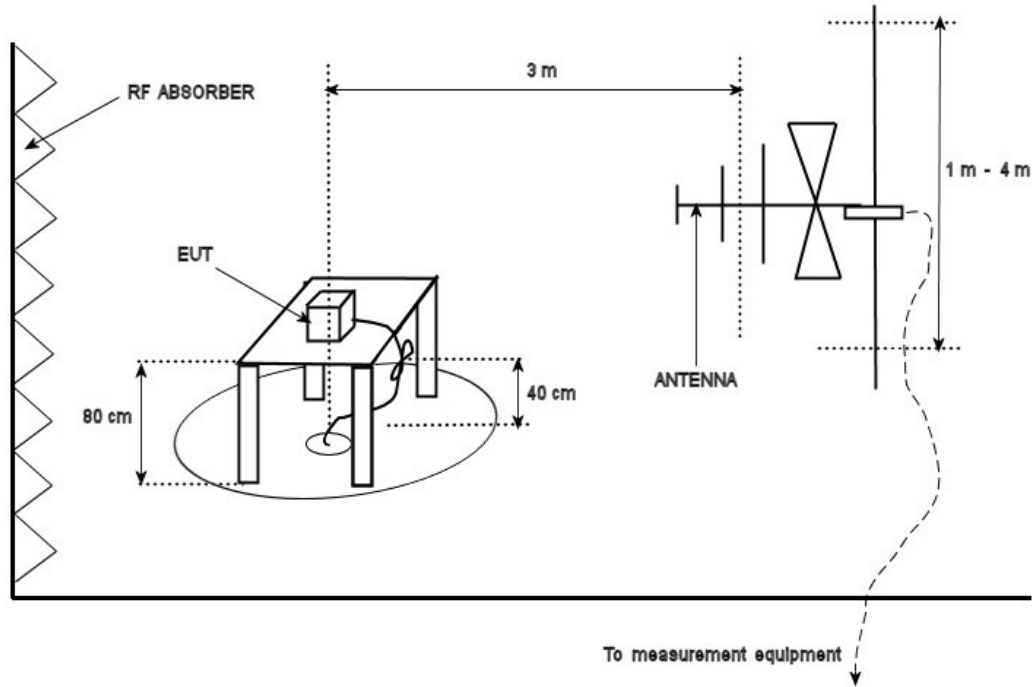

**Measurement Uncertainty**

The expanded measurement uncertainty is calculated in accordance with CISPR 16-4-2 and is +/-4.4 dB with a 'k=2' coverage factor and a 95% confidence level.

**Preliminary Graphs**

Note the graphs shown below are for graphical illustration only. For final measurements with the appropriate detector, please refer to the final measurement table where applicable. The graph shown below is a maximized peak measurement graph, measured with a resolution bandwidth greater than the final required detector and over a full 0-360 rotation. This peaking process is done as a worst case measurement. This process enables the detection of frequencies of concern for final measurement, and provides considerable time savings.

The device was scanned to the 10<sup>th</sup> harmonic (a minimum of a 10 GHz).

The measured radiation includes the emissions from the reader being used to control the EUT.

Client	<b>Kapsch TrafficCom Canada Inc</b>	
Product	<b>FME Transponder</b>	
Standard(s)	RSS-137 Issue 2:2009 / FCC Part 90 Subpart M:2015	

**Vertical – Peak Emission Graph  
30 MHz – 1 GHz**

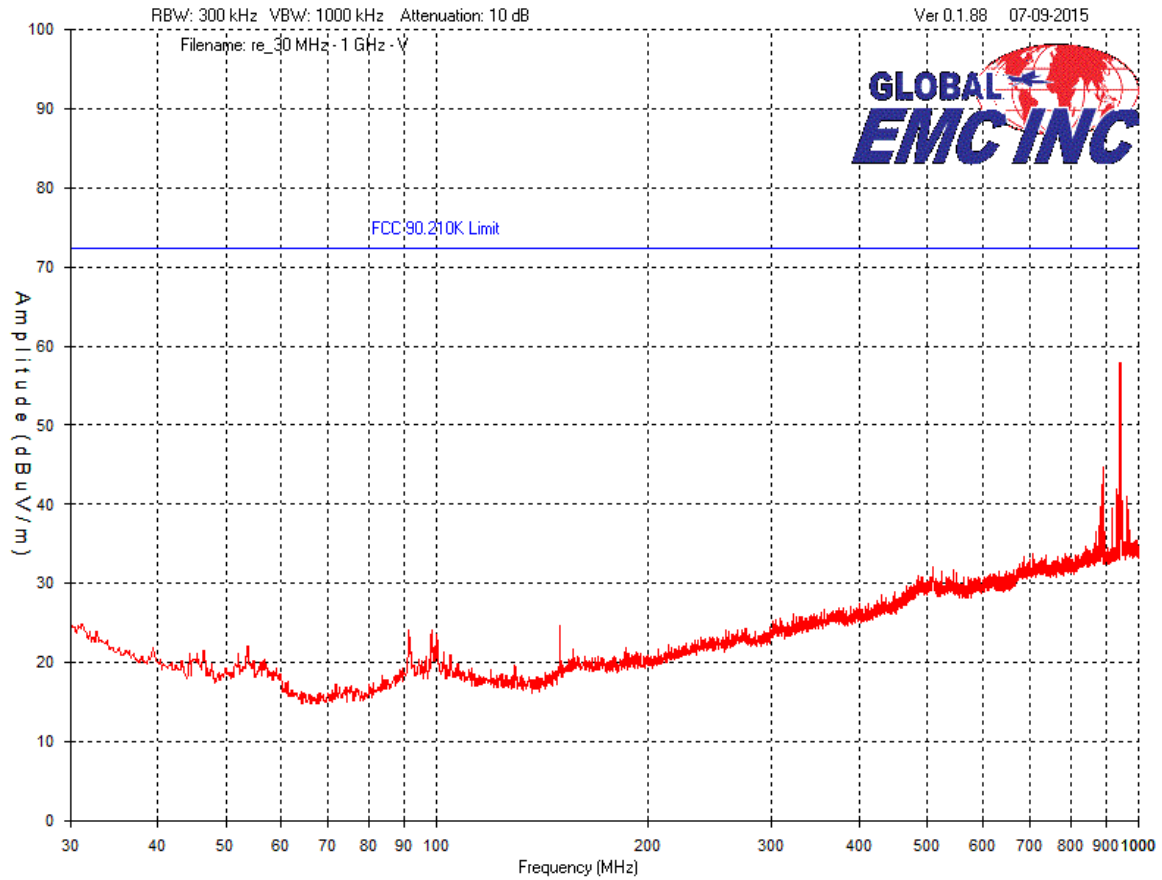

Client	<b>Kapsch TrafficCom Canada Inc</b>	
Product	<b>FME Transponder</b>	
Standard(s)	RSS-137 Issue 2:2009 / FCC Part 90 Subpart M:2015	

**Vertical – Peak Emission Graph  
1 GHz – 2 GHz**

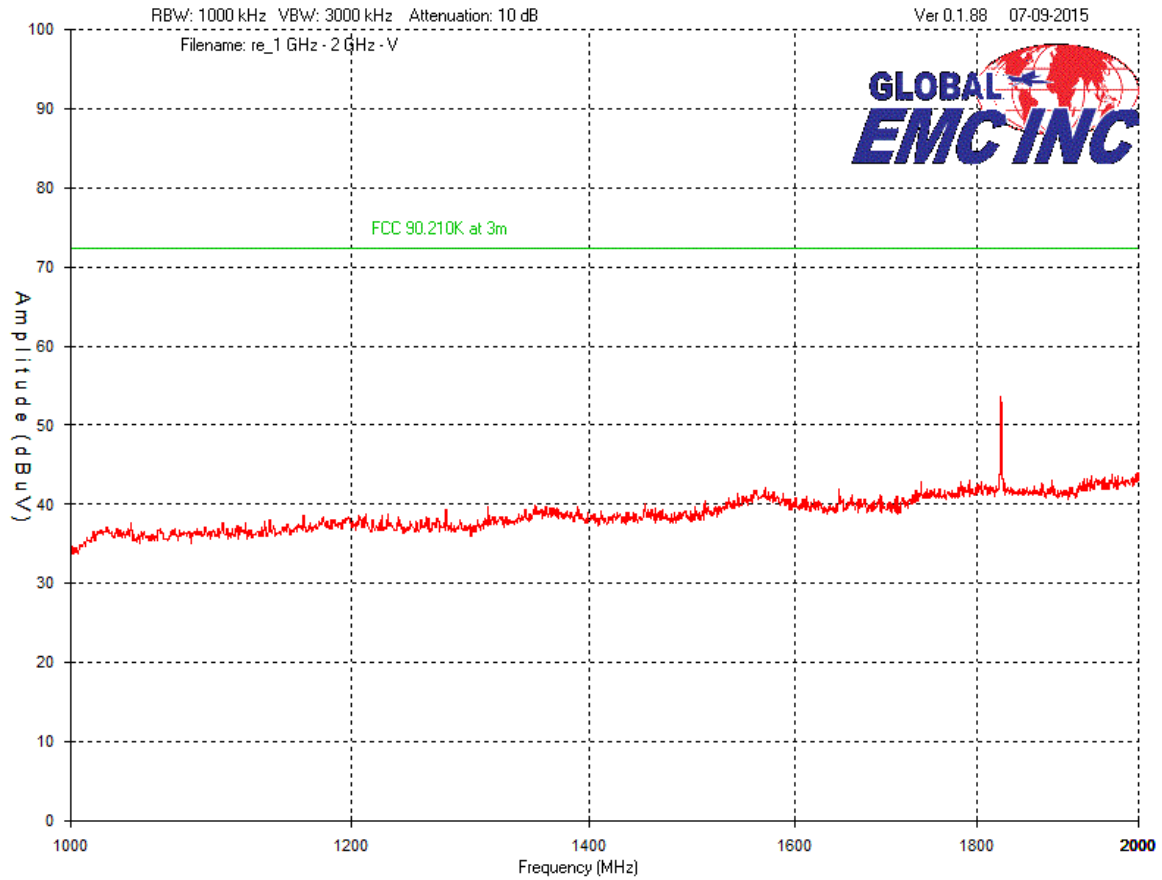



Client	<b>Kapsch TrafficCom Canada Inc</b>	
Product	<b>FME Transponder</b>	
Standard(s)	RSS-137 Issue 2:2009 / FCC Part 90 Subpart M:2015	

**Vertical – Peak Emission Graph  
2 GHz – 10 GHz**

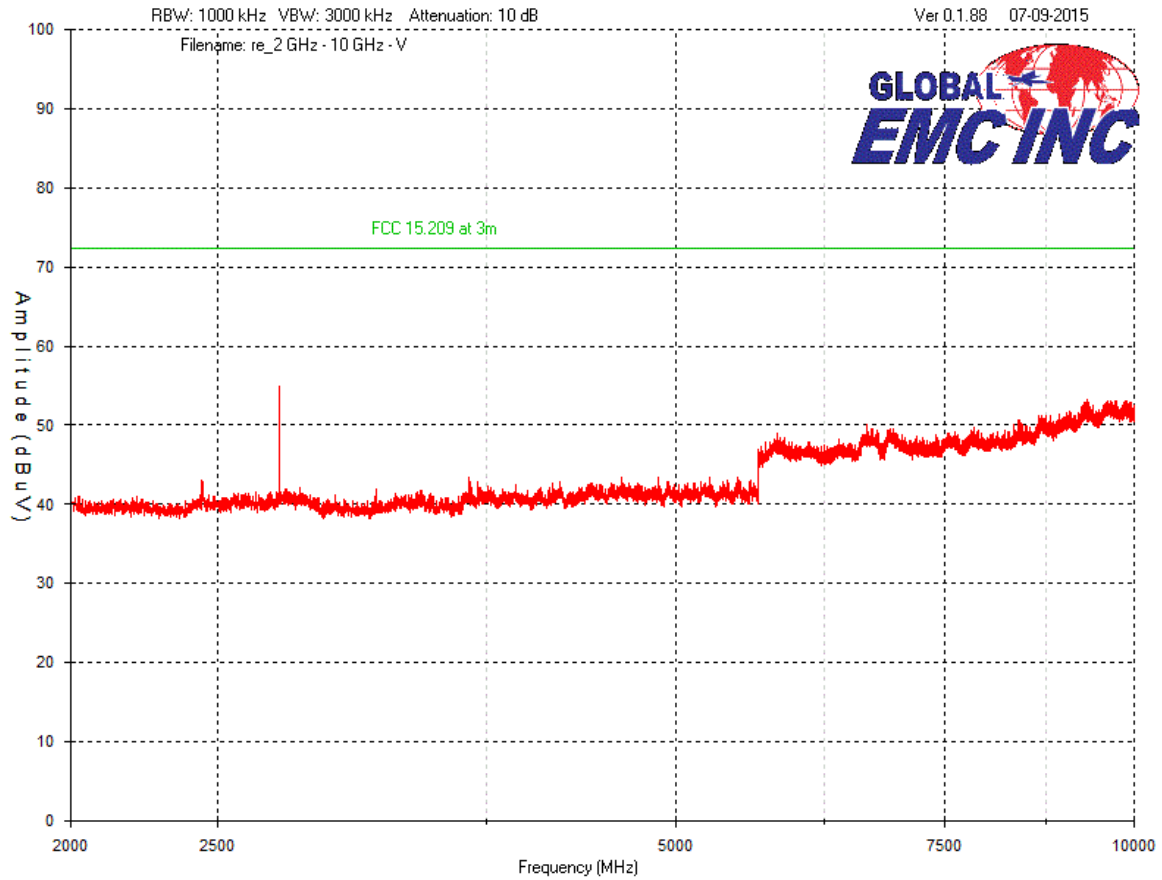

Client	<b>Kapsch TrafficCom Canada Inc</b>	
Product	<b>FME Transponder</b>	
Standard(s)	RSS-137 Issue 2:2009 / FCC Part 90 Subpart M:2015	

**Horizontal – Peak Emission Graph  
30 MHz – 1 GHz**

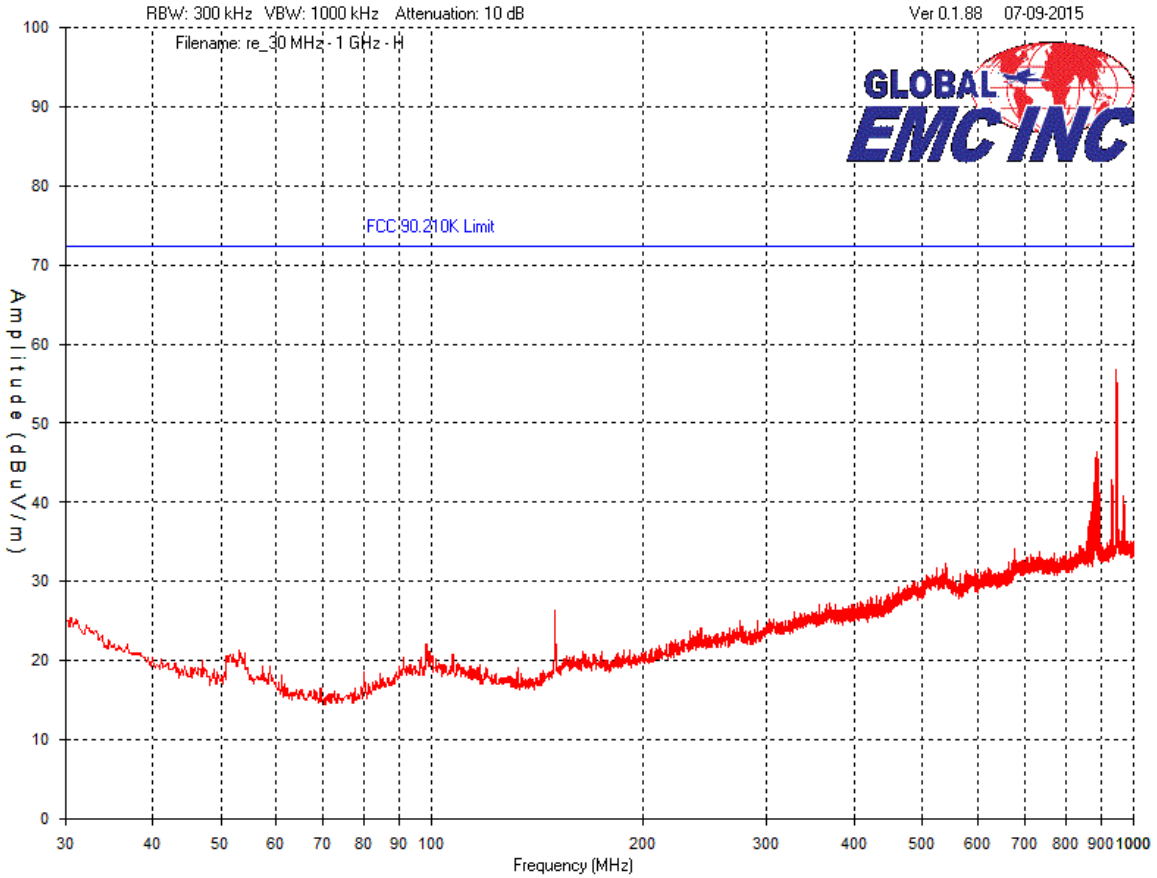

Client	<b>Kapsch TrafficCom Canada Inc</b>	
Product	<b>FME Transponder</b>	
Standard(s)	RSS-137 Issue 2:2009 / FCC Part 90 Subpart M:2015	

### Horizontal – Peak Emission Graph 1 GHz – 2 GHz

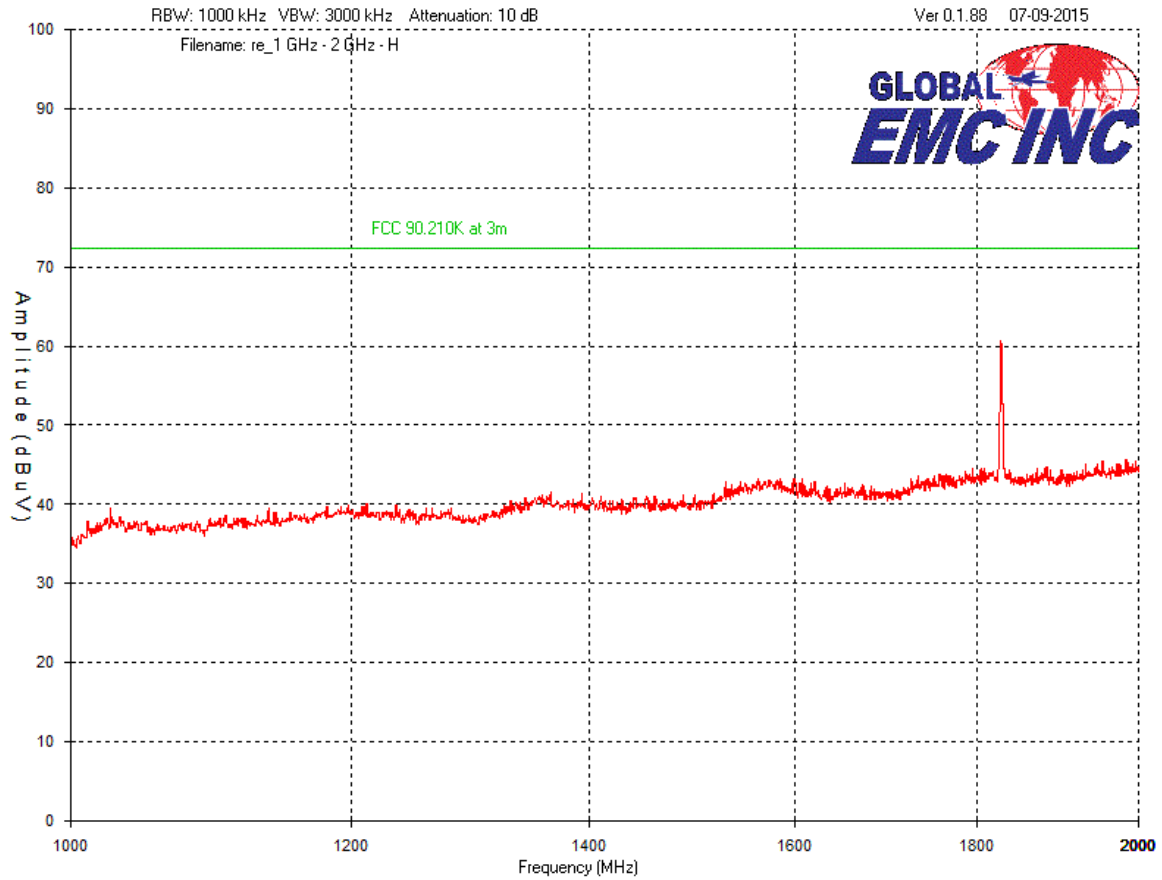

Client	<b>Kapsch TrafficCom Canada Inc</b>	
Product	<b>FME Transponder</b>	
Standard(s)	RSS-137 Issue 2:2009 / FCC Part 90 Subpart M:2015	

**Horizontal – Peak Emission Graph  
2 GHz – 10 GHz**

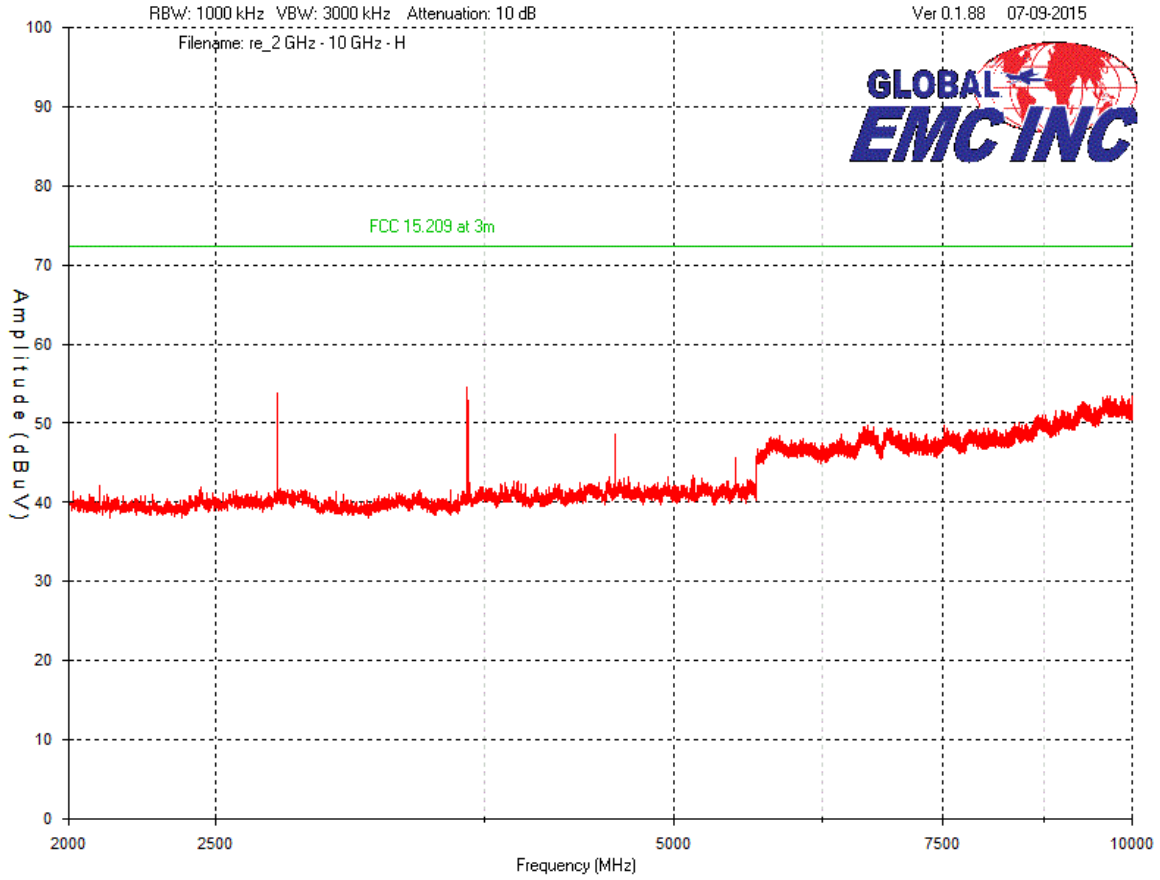

Client	<b>Kapsch TrafficCom Canada Inc</b>	
Product	<b>FME Transponder</b>	
Standard(s)	RSS-137 Issue 2:2009 / FCC Part 90 Subpart M:2015	

## Results

Pass.

The EUT meets the Transmitter Spurious Radiated Emissions requirements.

All scan were perform with a measurement bandwidth greater than the required bandwidth. No peak emissions were above the limit.

## Test Equipment List

Equipment	Model No.	Manufacturer	Last calibration date	Next calibration due date	Asset #
Spectrum Analyzer	8566B	HP	Oct 2, 2013	Oct 2, 2015	GEMC190
Quasi Peak Adapter	85650A	HP	Oct 2, 2013	Oct 2, 2015	GEMC191
BiLog Antenna	3142-C	ETS	Feb 10, 2015	Feb 10, 2017	GEMC 137
Band Reject Filter	BRC50722	Micro-Tronics	NCR	NCR	GEMC186
Chase Preamp 9kHz - 2 GHz	CPA9231A	Chase	Sept 9, 2014	Sept 9, 2016	GEMC 6403
Q-Par 1.5-18 GHz Horn	6878/24	Q-par	Sept 10, 2014	Sept 10, 2016	GEMC 6365
1-26G pre-amp	HP 8449B	HP	Sept 9, 2014	Sept 9, 2016	GEMC 6351
RF Cable 7m	LMR-400-7M-50OHM-MN-MN	LexTec	NCR	NCR	GEMC 28
RF Cable 1m	LMR-400-1M-50OHM-MN-MN	LexTec	NCR	NCR	GEMC 29
RF Cable 0.5M	LMR-400-0.5M-50OHM-MN-MN	LexTec	NCR	NCR	GEMC 31

This report module is based on GEMC template "FCC - 15.209 - Radiated Emissions\_Rev1.doc"

Client	<b>Kapsch TrafficCom Canada Inc</b>	
Product	<b>FME Transponder</b>	
Standard(s)	RSS-137 Issue 2:2009 / FCC Part 90 Subpart M:2015	

## **Temperature Frequency Stability**

### **Purpose**

The purpose of this test is to ensure that the RF energy unintentionally emitted from the EUT does not exceed the permitted bandwidth during extreme temperature variations. This helps protect radio broadcasts and receivers with spectrum nearby to the equipment under test from unwanted interference. This also helps ensure proper reception of the intended signal by ensuring the transmit frequency is correct in any temperature.

### **Limit(s) and Method**

The methods are given in FCC Part 2.1055. There limits given in FCC Part 90.213.

However, the device meets the following condition:

Fixed non-multilateration transmitters with an authorized bandwidth that is more than 40 kHz from the band edge, intermittently operated hand-held readers, and mobile transponders are not subject to frequency tolerance restrictions.

Frequency tolerances measurements are taken for information purpose. Frequency must be maintained from -30 C to +50 C. The EUT is monitored at each 10 degree increment. At each temperature, the device is checked after a stabilization period required for the device to reach the temperature.

### **Measurement Graphs**

The worst case results are presented, with the frequency shown. The device was checked at each 10 degree increment of temperature

### **Table**

Test Condition	Measured Frequency (MHz)	Frequency Drift (ppm)
+22°C, Nominal	914.8717948	--
-30°C, Nominal	914.8705357	-1.37
+50°C, Nominal	914.8738758	2.27

Client	<b>Kapsch TrafficCom Canada Inc</b>	
Product	<b>FME Transponder</b>	
Standard(s)	RSS-137 Issue 2:2009 / FCC Part 90 Subpart M:2015	

## Test Equipment List

Equipment	Model No.	Manufacturer	Last calibration date	Next calibration due date	Asset #
Spectrum Analyzer	FSU	Rohde & Schwarz	1/19/2015	1/19/2017	GEMC 198
Environmental Chamber	SM-32-7800	Thermotron	NCR	NCR	GEMC 153

This report module is based on GEMC template "FCC - 15.225 - RFID Freq Stab\_Rev1.doc"

Client	<b>Kapsch TrafficCom Canada Inc</b>	
Product	<b>FME Transponder</b>	
Standard(s)	RSS-137 Issue 2:2009 / FCC Part 90 Subpart M:2015	

## Appendix A – EUT Summary

For further details for filing purposes, refer to filing package.

### General EUT Description

Client Details	
Organization / Address	Kapsch TrafficCom Canada Inc. 6020 Ambler Drive, Mississauga, Ont. Canada L4W 2P1
Contact	Richard Turnock, CTO
Phone	905-624-3020 x 7900
Email	richard.turnock@kapsch.net
Manufacturer Details (if not same as above)	
Organization / Address	
Contact	Alastair Malarky, Chief Engineer
Phone	905-624-3020 x 7900
Email	alastair.malarky@kapsch.net
EUT (Equipment Under Test) Details	
EUT Name (for report title)	FME Transponder
EUT Model / SN (if known)	801800B-TAB
EUT revision	B
Software version	N/A
Equipment category	LMS Part 90, Subpart M transceiver
EUT is powered using	Self powered; internal 3.6V battery
Number of power supplies in EUT	None
unit Transmits RF energy? (describe)	Yes. Unit is a Part 90 (LMS) transceiver. It intentionally radiates RF at nominally 915 MHz when triggered by coded RF radiation.
Basic EUT functionality description	The EUT responds to a trigger reader signal and emits a radiated transmission in response. The unit has an integral antenna.
High level block diagram of EUT (attachment)	In confidential attachment
Customer to setup EUT on site?	Yes



Client	<b>Kapsch TrafficCom Canada Inc</b>	
Product	<b>FME Transponder</b>	
Standard(s)	RSS-137 Issue 2:2009 / FCC Part 90 Subpart M:2015	

Frequency of all clocks present in EUT	6 MHz digital clock when triggered
I/O cable description Specify length and type	N/A for product  Test version modified to provide SMA connection for conducted RF measurements
Available connectors on EUT	N/A for product  SMA on conducted test unit only
Peripherals required to exercise EUT Ex. Signal generator	RF signal generator, Kapsch test mount
Dimensions of product	L = 215.9 mm (8.5" inches) W = 46.49 mm (1.838" inches) H = 26.95 mm (1.061" inches)

Note the EUT is considered to have been received the date of the commencement of the first test, unless otherwise stated. For a close-up picture of the EUT, see 'Appendix B – EUT & Test Setup Photographs'.

Client	<b>Kapsch TrafficCom Canada Inc</b>	
Product	<b>FME Transponder</b>	
Standard(s)	RSS-137 Issue 2:2009 / FCC Part 90 Subpart M:2015	

## Technical Specifications

Operation Band:	902 – 928 MHz
Modulation:	Shaped On-Off Keying
Emission Designator	K1D
Operation Frequency:	915 MHz

## EUT Configurations and Operation Setup

Please see Appendix B for a picture of the unit running in normal conditions.

The EUT is an internally battery powered devices and are continuously in receive mode. It required an external RF trigger to stimulate a response. Each RF trigger will produce one burst of transmission from the EUT.

The trigger pulse was generated by a signal generator gated be a function generator.

Note: Test version was modified to provide SMA connection for conducted RF measurements.

Client	<b>Kapsch TrafficCom Canada Inc</b>	
Product	<b>FME Transponder</b>	
Standard(s)	RSS-137 Issue 2:2009 / FCC Part 90 Subpart M:2015	

## Appendix B – EUT and Test Setup Photographs

Client	<b>Kapsch TrafficCom Canada Inc</b>	
Product	<b>FME Transponder</b>	
Standard(s)	RSS-137 Issue 2:2009 / FCC Part 90 Subpart M:2015	

Note: These photos are for information purposes only. Also refer to PDF files that are separate from this test report.



**Illustration 1: FME Transponder front view**

Client	<b>Kapsch TrafficCom Canada Inc</b>	
Product	<b>FME Transponder</b>	
Standard(s)	RSS-137 Issue 2:2009 / FCC Part 90 Subpart M:2015	

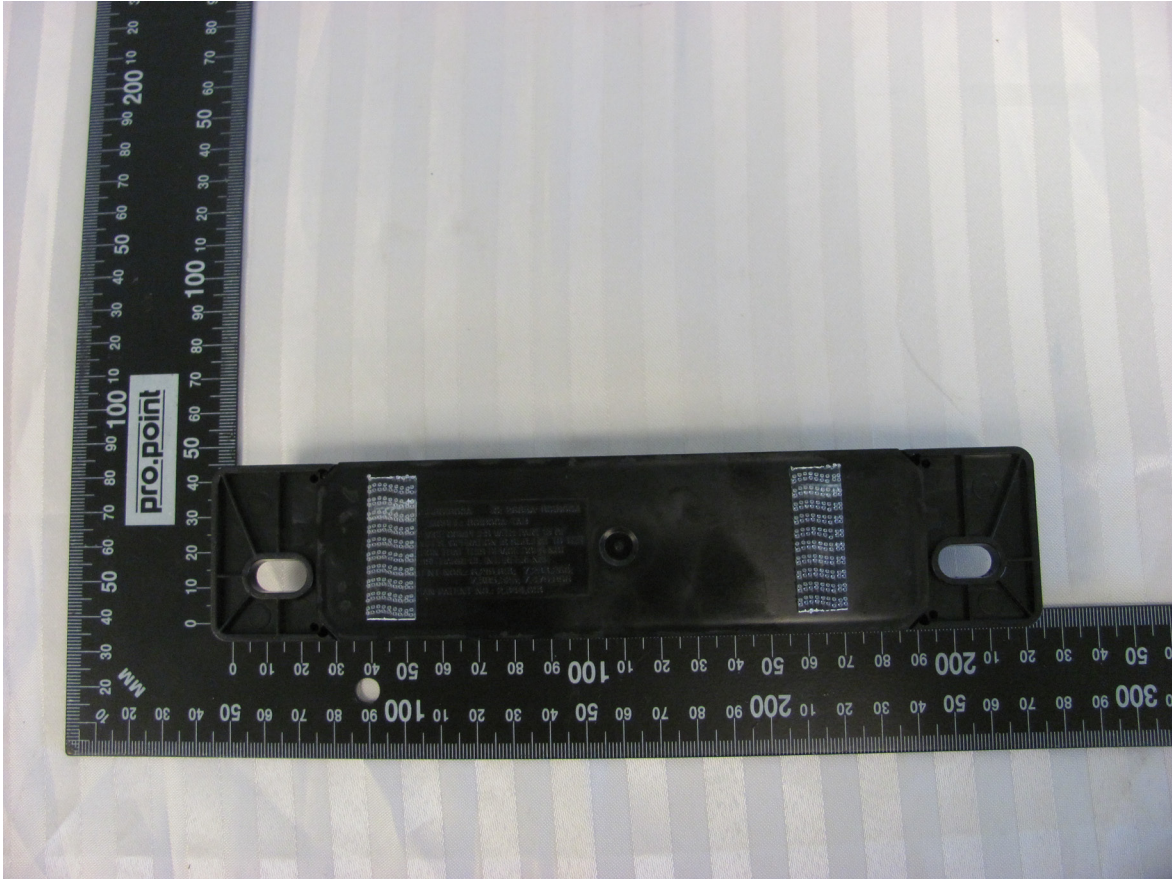

**Illustration 2: FME transponder rear view**



Client	<b>Kapsch TrafficCom Canada Inc</b>	
Product	<b>FME Transponder</b>	
Standard(s)	RSS-137 Issue 2:2009 / FCC Part 90 Subpart M:2015	



**Illustration 3: Radiated emission setup – photo 1**

Client	<b>Kapsch TrafficCom Canada Inc</b>	
Product	<b>FME Transponder</b>	
Standard(s)	RSS-137 Issue 2:2009 / FCC Part 90 Subpart M:2015	

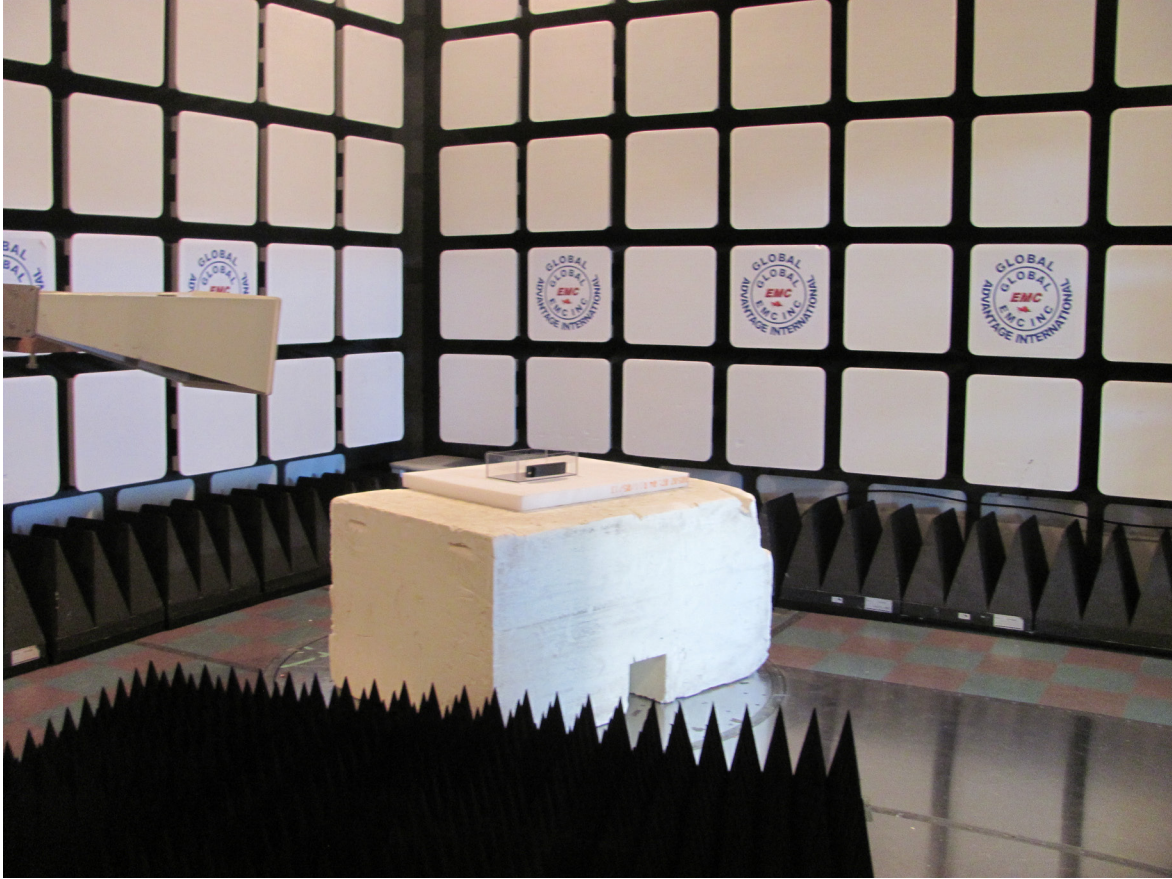

**Illustration 4: Radiated emission setup - photo 2**



Client	<b>Kapsch TrafficCom Canada Inc</b>	
Product	<b>FME Transponder</b>	
Standard(s)	RSS-137 Issue 2:2009 / FCC Part 90 Subpart M:2015	

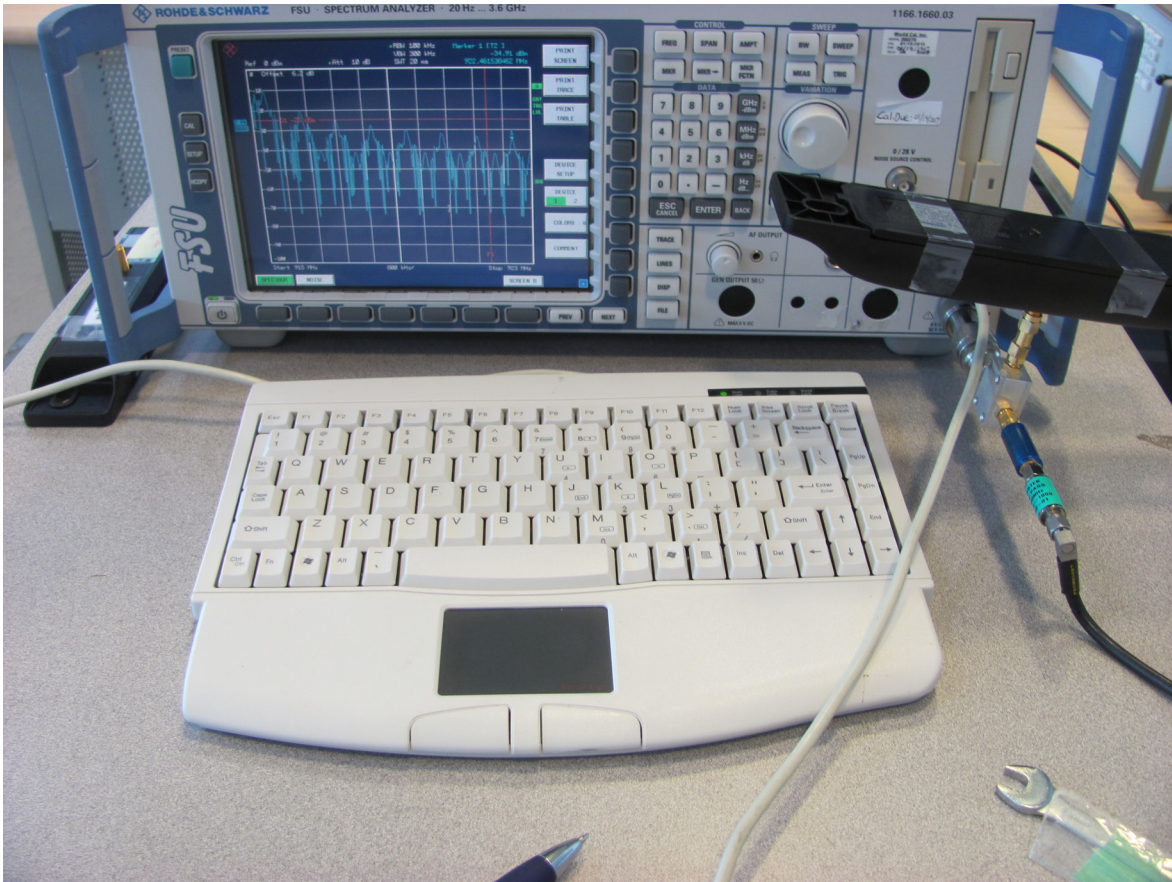

**Illustration 5: Antenna conducted emission setup**