

# Prime Input Module

LDP-01787

**BRAND OWNER**  
**HID GLOBAL CORPORATION**  
611 Center Ridge Drive, Austin, TX 78753 USA  
www.hidglobal.com

인증 받은 자의 상호 :  
**CARD MARKING SYSTEM**  
卡片个性化系统 카드 마킹 시스템 卡片个性化系统  
Система Маркировки Карточек

INPUT (输入/輸入/일렉/Вход) :  
100-240V~, 最大电流 最大限量  
50-60Hz 2.5A MAX 최대한계 Макс.

**FCC CLASS A**  
This device complies with Part 15 of the FCC Rules.  
Operation is subject to the following two conditions:  
(1) this device may not cause harmful interference,  
and (2) this device must accept any interference  
received, including interference that may cause  
undesired operation.

FCC ID: JQ6-X002600  
IC: 2236B-X002600  
SRD MODEL: X002600

**CE**  
**UL US LISTED**  
I.T.E.  
E145118



**MARKETING NAME: ELEMENT**  
**PRIME INPUT MODULE**  
**MODULE: 001**  
**MODEL: X002600**  
모델명 번호 모델 型號

**Hi-pot tested**

Patented, www.hidglobal.com/patents

LDP-01787 Rev C

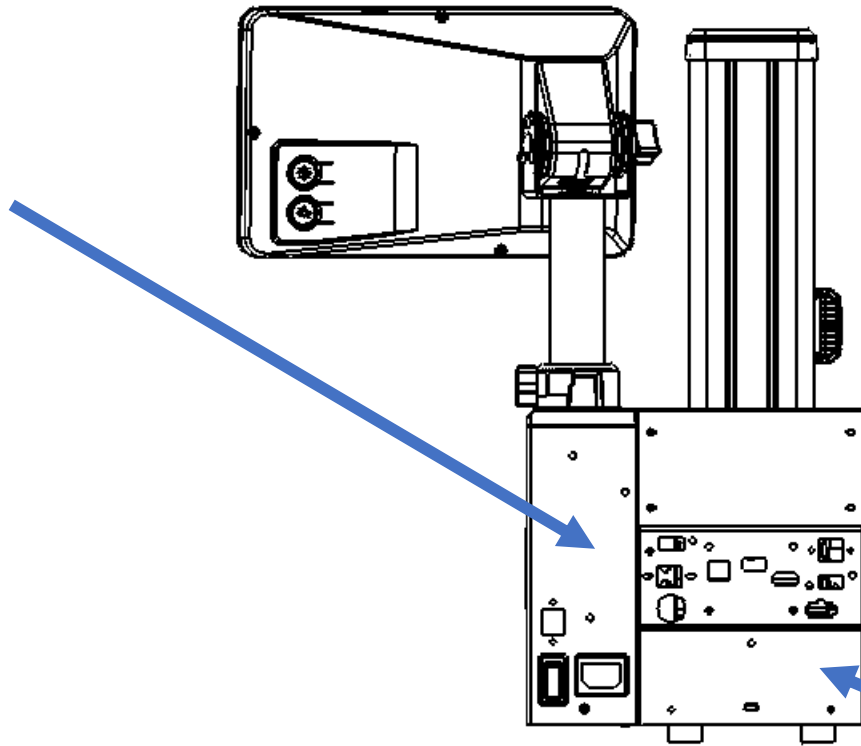

FCC ID: JQ6-X002600  
IC: 2236B-X002600  
SDR MODEL: X002600  
E4662  
LDP-01878 Rev A

or

Contains: FCC ID: JQ6-OK5127CKMINI  
Contains IC: 2236B-OK5127CKMINI  
SRD MODEL: OK5127CKMINI  
E4662  
LDP-01634 Rev A

LDP-01878

or

LDP-01634

# Input Module

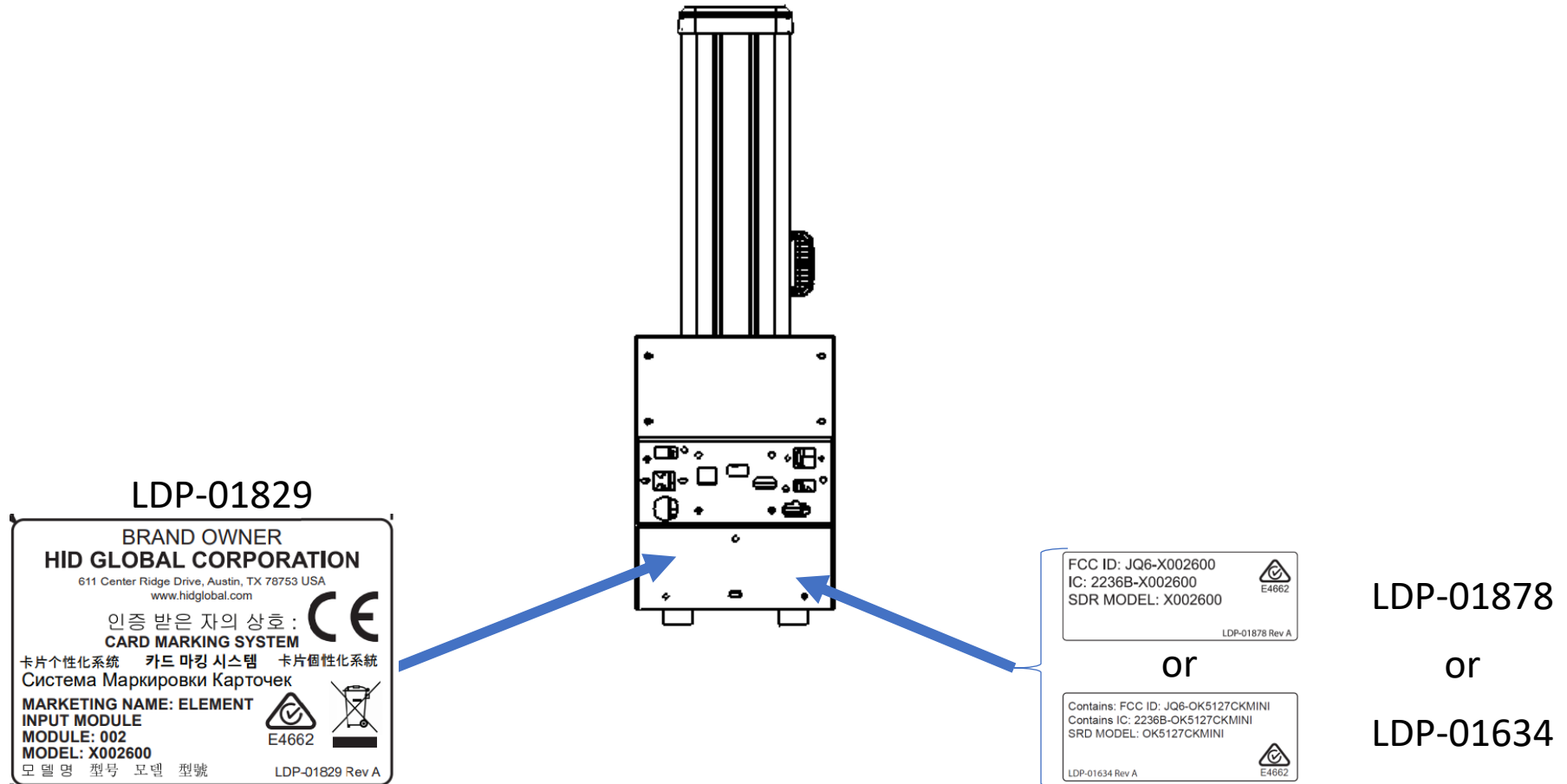

# Encoder Module

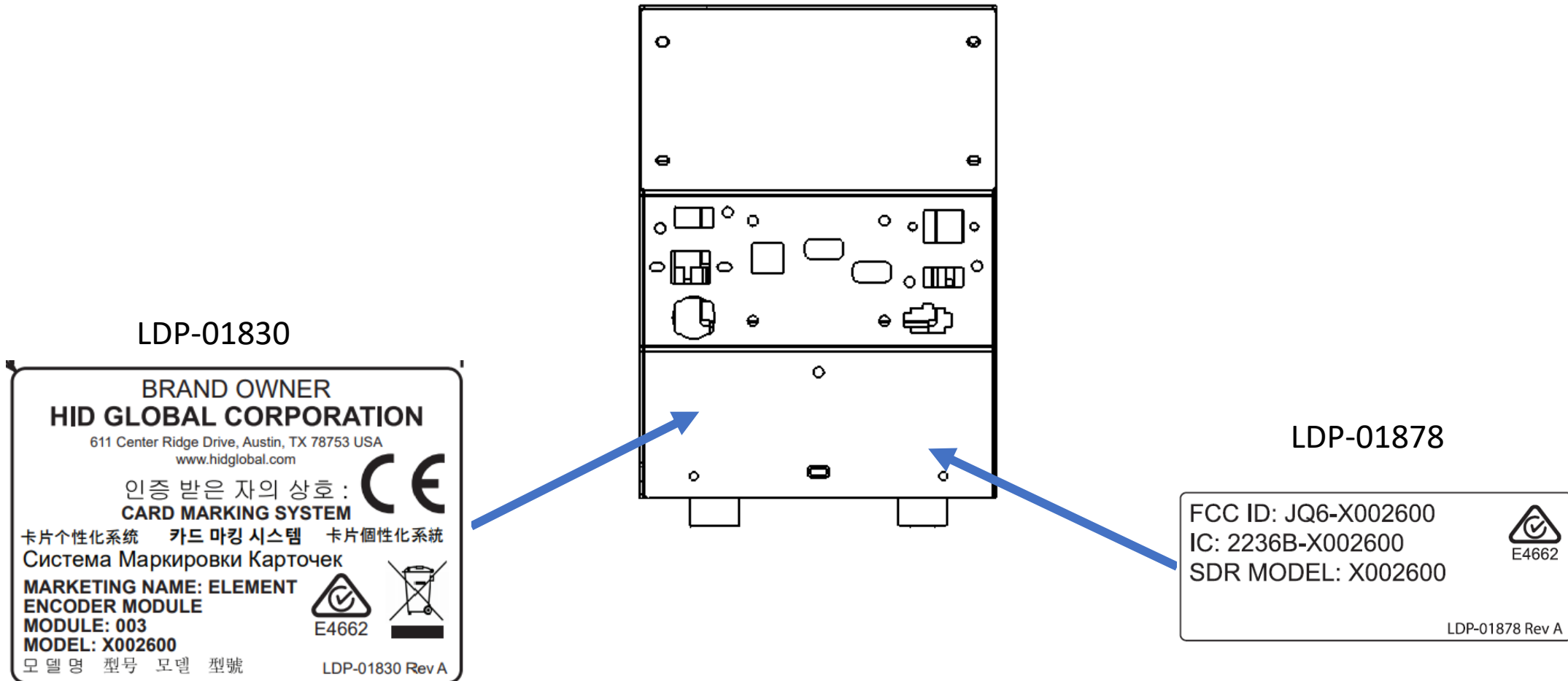

LDP-01830

**BRAND OWNER**  
**HID GLOBAL CORPORATION**  
611 Center Ridge Drive, Austin, TX 78753 USA  
www.hidglobal.com

인증 받은 자의 상호:   
**CARD MARKING SYSTEM**

卡片个性化系统 카드 마킹 시스템 卡片个性化系统  
Система Маркировки Карточек

**MARKETING NAME: ELEMENT**  
**ENCODER MODULE**  
**MODULE: 003**  
**MODEL: X002600**

   
E4662

모델명    型号    모델    型號                      LDP-01830 Rev A

LDP-01878

FCC ID: JQ6-X002600  
IC: 2236B-X002600  
SDR MODEL: X002600

  
E4662

LDP-01878 Rev A

# Laser Marking Module

LDP-01831 or LDP-01832

BRAND OWNER  
**HID GLOBAL CORPORATION**  
611 Center Ridge Drive, Austin, TX 78753 USA  
www.hidglobal.com

인증을 받은 자의 상호 : **CE**  
**CARD MARKING SYSTEM**  
卡片个性化系统 카드 마킹 시스템 卡片个性化系统  
Система Маркировки Карточек

MARKETING NAME: ELEMENT  
3W LASER MARKING MODULE  
MODULE: 004  
MODEL: X002600

모델명 型号 모델 型號

CLASS 1 LASER PRODUCT  
Complies with 21 CFR 1040.10 and 1040.11  
except for conformance with IEC 60825-1  
Ed. 3, as described in Laser Notice No. 56,  
dated May 8, 2015.

LDP-01831 Rev A

OR

BRAND OWNER  
**HID GLOBAL CORPORATION**  
611 Center Ridge Drive, Austin, TX 78753 USA  
www.hidglobal.com

인증을 받은 자의 상호 : **CE**  
**CARD MARKING SYSTEM**  
卡片个性化系统 카드 마킹 시스템 卡片个性化系统  
Система Маркировки Карточек

MARKETING NAME: ELEMENT  
8W LASER MARKING MODULE  
MODULE: 005  
MODEL: X002600

모델명 型号 모델 型號

CLASS 1 LASER PRODUCT  
Complies with 21 CFR 1040.10 and 1040.11  
except for conformance with IEC 60825-1  
Ed. 3, as described in Laser Notice No. 56,  
dated May 8, 2015.

LDP-01832 Rev A

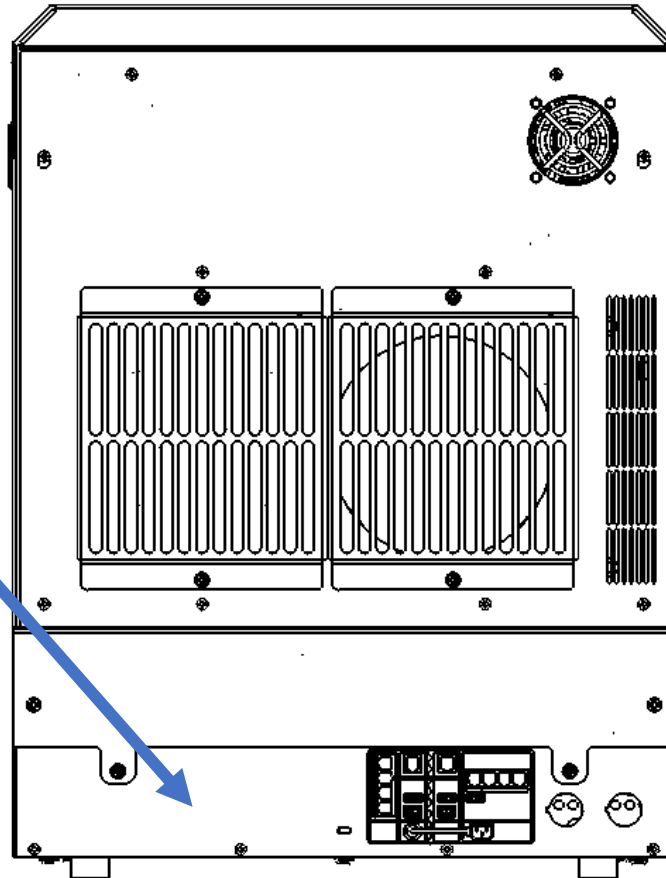

# UV Ink Marking Module

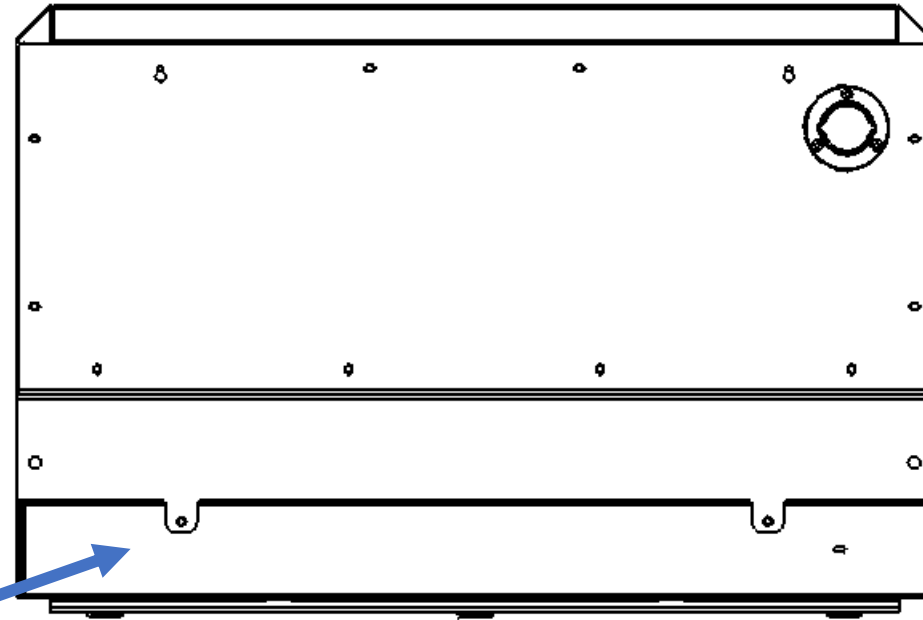

LDP-01837

BRAND OWNER  
**HID GLOBAL CORPORATION**  
611 Center Ridge Drive, Austin, TX 78753 USA  
www.hidglobal.com

인증 받은 자의 상호 : **CE**  
**CARD MARKING SYSTEM**

卡片个性化系统 카드 마킹 시스템 卡片个性化系统  
Система Маркировки Карточек

MARKETING NAME: ELEMENT  
UV INK MARKING MODULE  
MODULE: 006  
MODEL: X002600

모 델 명 型号 모델 型号

E4662

LDP-01837 Rev A

# Output Module

LDP-01875

**BRAND OWNER**  
**HID GLOBAL CORPORATION**  
611 Center Ridge Drive, Austin, TX 78753 USA  
www.hidglobal.com

인증 받은 자의 상호 : **CE**  
**CARD MARKING SYSTEM**

卡片个性化系统    카드 마킹 시스템    卡片个性化系统  
Система Маркировки Карточек

**MARKETING NAME: ELEMENT**  
**OUTPUT MODULE**  
**MODULE: 007**  
**MODEL: X002600**

모 델 명    型号    모 델    型号    **E4662**

**LDP-01875 Rev A**

