

# HID GLOBAL CORPORATION

## 3500 READER MODULE, OPERATING ON 13.56 MHZ

Model: 3500

March 17 2011

Report No.: SL11021502-HID-005\_veriCLASS (FCC,IC)

(This report supersedes None)

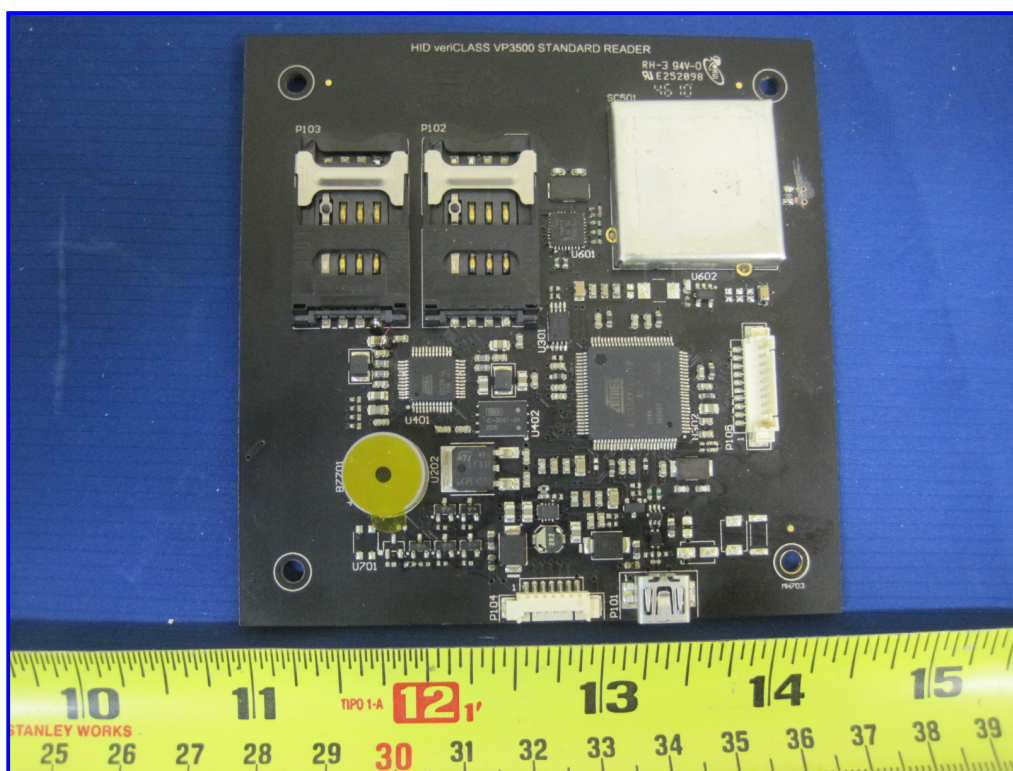

Modifications made to the product : None

This Test Report is Issued Under the Authority of:

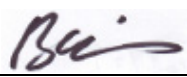
	
Dan Corona Compliance Engineer	Leslie Bai Director of Certification

This test report may be reproduced in full only.  
Test result presented in this test report is applicable to the representative sample only.

# EMC Test Report

To: FCC Part 15.207, 15.209, 15.225, RSS-GEN, RSS-210

SIEMIC, INC.  
Accessing global markets



This page has been left blank intentionally.

# CONTENTS

<b>1</b>	<b>EXECUTIVE SUMMARY &amp; EUT INFORMATION.....</b>	<b>5</b>
<b>2</b>	<b>TECHNICAL DETAILS.....</b>	<b>6</b>
<b>3</b>	<b>MODIFICATION .....</b>	<b>7</b>
<b>4</b>	<b>TEST SUMMARY .....</b>	<b>8</b>
<b>5</b>	<b>MEASUREMENTS, EXAMINATION AND DERIVED RESULTS .....</b>	<b>9</b>
	<b>ANNEX A. TEST INSTRUMENT &amp; METHOD .....</b>	<b>23</b>
	<b>ANNEX B. TEST SETUP PHOTOGRAPHS.....</b>	<b>27</b>
	<b>ANNEX B. I. EUT INTERNAL PHOTOGRAPHS.....</b>	<b>28</b>
	<b>ANNEX B. II. EUT EXTERNAL PHOTOGRAPHS .....</b>	<b>29</b>
	<b>ANNEX C. SUPPORTING EQUIPMENT DESCRIPTION .....</b>	<b>30</b>
	<b>ANNEX D. EUT OPERATING CONDITIONS.....</b>	<b>33</b>
	<b>ANNEX E. USER MANUAL, BLOCK &amp; CIRCUIT DIAGRAM.....</b>	<b>34</b>
	<b>ANNEX F. SIEMIC ACCREDITATION CERTIFICATES .....</b>	<b>36</b>

This page has been left blank intentionally.

# 1 Executive Summary & EUT information

The purpose of this test programmed was to demonstrate compliance of the HID Global Corp., Model: 3500 against the current Stipulated Standards for FCC 15.225 and RSS-210 Issue 8 assessment.

The equipment under test radio operating frequency is 13.56 MHz.

The test has demonstrated that this unit complies with stipulated standards.

## EUT Information

<b>EUT Description</b>	:	The veriCLASS P-Series platform model 3500 is a 13.56 MHz fully certified and easy-to-integrate reader product line that provides simultaneously support for multiple card technologies as well as open and closed loop payment schemes within one system. veriCLASS is tailored to meet the needs of Payment and Ticketing manufacturers, such as automated fare collection systems, handheld terminals, ATMs, vending, kiosk or retail applications. The platform offers ultimate integration flexibility for secure contact less cashless payment and AFC solutions.
<b>Model No</b>	:	3500
<b>Serial No</b>	:	
<b>Input Power</b>	:	5 VDC (Powered by Host using USB as the host interface, use VUSB to supply the board to ensure correct enumeration).
<b>Classification Per Stipulated Test Standard</b>	:	RFID Reader Module



## 2 TECHNICAL DETAILS

<b>Purpose</b>	Compliance testing of 3500 Reader Module, Operating on 13.56 MHz with stipulated standard
<b>Applicant / Client</b>	HID Global Corporation
<b>Manufacturer</b>	HID Global Corporation 15730 Barranca Parkway Irvine, CA 92618 USA
<b>Laboratory performing the tests</b>	SIEMIC Laboratories
<b>Test report reference number</b>	SL11021502-HID-005_veriCLASS (FCC,IC)
<b>Date EUT received</b>	March 3 2011
<b>Standard applied</b>	47 CFR §15.207, 15.209, 15.225: 2010 & Canadian Standards RSS-GEN Issue 3, RSS-210 Issue 8
<b>Dates of test (from – to)</b>	March 8 2011
<b>No of Units:</b>	2
<b>Equipment Category:</b>	DXX
<b>Model :</b>	3500
<b>RF Operating Frequency (ies)</b>	13.56 MHz (RFID)
<b>Number of Channels :</b>	(13.56MHz) 1
<b>FCC ID :</b>	JQ6-VERICLASS
<b>IC ID :</b>	2236B-VERICLASS

### 3 MODIFICATION

NONE

## 4 TEST SUMMARY

**The product was tested in accordance with the following specifications. All testing has been performed according to below product classification:**

**RFID Reader**

**Test Results Summary**

Test Standard		Description	Pass / Fail
47 CFR Part 15.225: 2010	RSS 210 Issue 8		
15.203		Antenna Requirement	Pass
15.207(a)	RSS Gen(7.2.2)	Conducted Emissions Voltage	Pass
15.225(a)	RSS210(A2.6)	Limit in the band of 13.553 – 13.567 MHz	Pass
15.225(b)	RSS210(A2.6)	Limit in the band of 13.410 – 13.553 MHz and 13.567 – 13.710 MHz	Pass
15.225(c)	RSS210(A2.6)	Limit in the band of 13.110 – 13.410 MHz and 13.710 – 14.010 MHz	Pass
15.225(d), 15.209	RSS210(A2.6)	Limit outside the band of 13.110 – 14.010 MHz	Pass
15.225(e)	RSS210(A2.6)	Frequency Stability	Pass
	RSS-210(5.9.1)	Occupied Bandwidth	Pass
	RSS-310 (3.7)	Very Low Power Devices Operating Below 490 kHz	N/A

ANSI C63.4: 2003/ RSS-Gen Issue 3

PS: All measurement uncertainties are not taken into consideration for all presented test result.



## **5 MEASUREMENTS, EXAMINATION AND DERIVED RESULTS**

### **5.1 Antenna Requirement**

**Requirement(s):** 47 CFR §15.203

An intentional radiator shall be designed to ensure that no antenna other than that furnished by the responsible party shall be used with the device.

Antenna requirement must meet at least one of the following:

- a) Antenna must be permanently attached to the device.
  - b) Antenna must use a unique type of connector to attach to the device.
  - c) Device must be professionally installed. Installer shall be responsible for ensuring that the correct antenna is employed with the device.
- 
- 1) The RFID antenna is integral to the main board permanently to the device which meets the requirement (See Internal Photographs submitted as another Exhibit).

## 5.2 Conducted Emissions Voltage

Requirement(s): 47 CFR §15.207

Requirement:

Frequency of emission (MHz)	Conducted limit (dBµV)	
	Quasi-peak	Average
0.15–0.5	66 to 56*	56 to 46*
0.5–5	56	46
5–30	60	50

\*Decreases with the logarithm of the frequency.

**Procedures:**

1. All possible modes of operation were investigated. Only the 6 worst case emissions measured, using the correct CISPR and Average detectors, are reported. All other emissions were relatively insignificant.
2. A "-ve" margin indicates a PASS as it refers to the margin present below the limit line at the particular frequency.
3. Conducted Emissions Measurement Uncertainty  
All test measurements carried out are traceable to national standards. The uncertainty of the measurement at a confidence level of approximately 95% (in the case where distributions are normal), with a coverage factor of 2, in the range 150kHz – 30MHz (Average & Quasi-peak) is ±3.5dB.
4. Environmental Conditions

Temperature	22°C
Relative Humidity	48%
Atmospheric Pressure	1019mbar

Test Date : March 8 2011  
Tested By : Dan Corona

**Results:** Pass

**Test Result – EUT powered by Host using USB as the host interface**

Quasi-Peak Limit
Average Limit

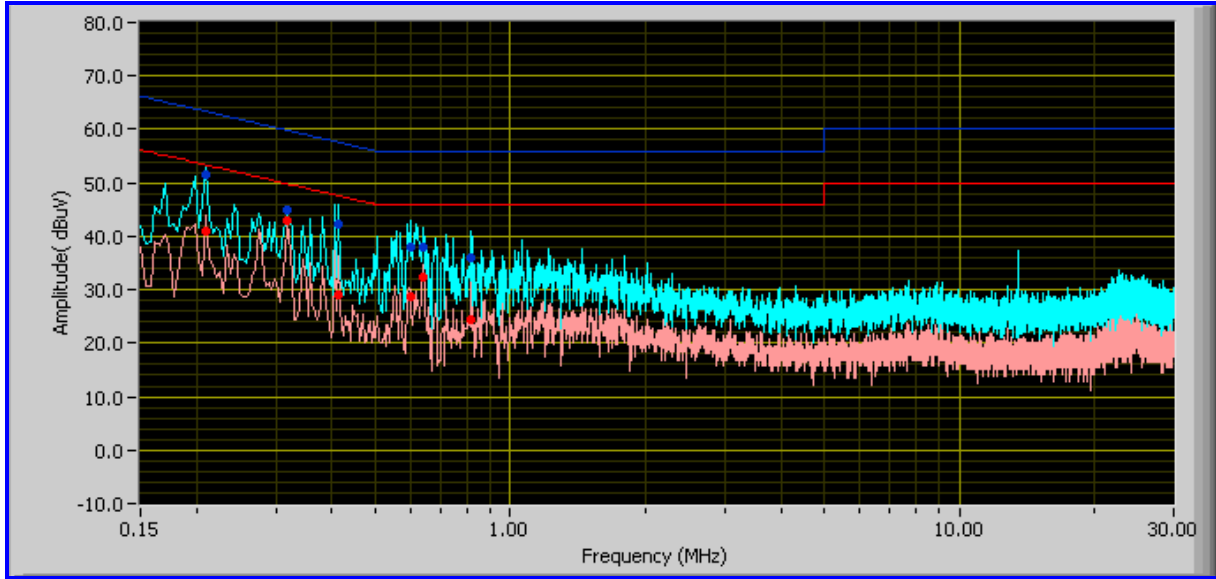

120V, 60Hz, Neutral Line

Frequency (MHz)	QP Value (dBuV)	Class B Limit (dB)	Pass / Fail	Margin (dB)	Avg Value (dBuV)	Class B Limit (dB)	Pass / Fail	Margin (dB)	Line
0.21	51.66	63.34	Pass	-11.68	40.98	53.34	Pass	-12.36	Neutral
0.41	42.15	57.59	Pass	-15.44	28.95	47.59	Pass	-18.64	Neutral
0.60	37.87	56.00	Pass	-18.13	28.70	46.00	Pass	-17.30	Neutral
0.64	38.08	56.00	Pass	-17.92	32.42	46.00	Pass	-13.58	Neutral
0.82	35.85	56.00	Pass	-20.15	24.37	46.00	Pass	-21.63	Neutral
0.32	45.02	59.83	Pass	-14.81	43.11	49.83	Pass	-6.72	Neutral

Quasi-Peak Limit

Average Limit

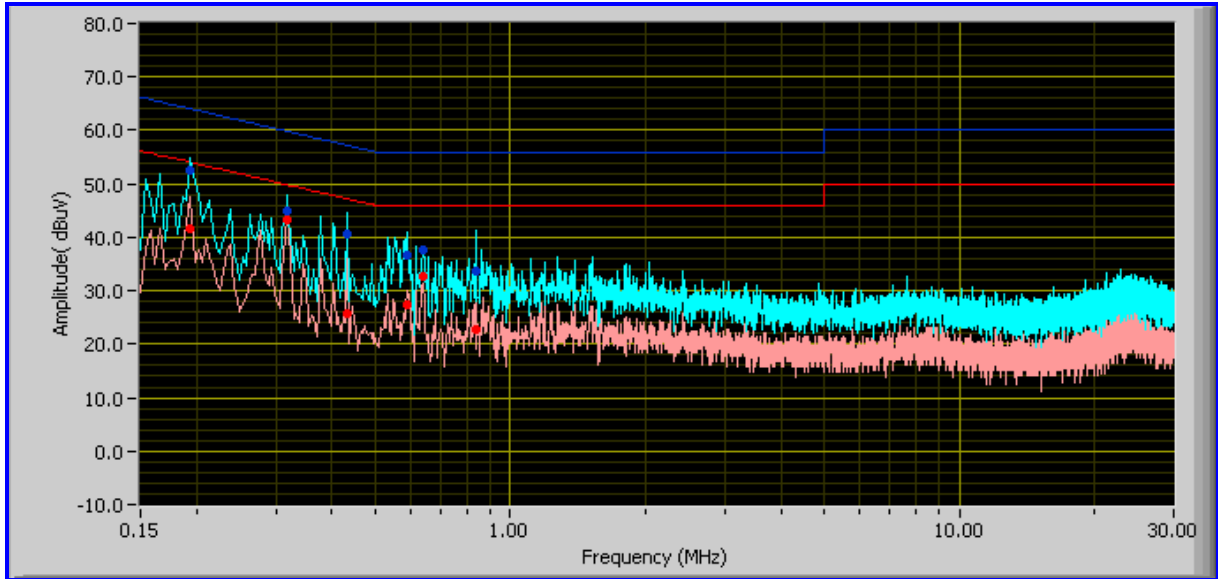

120V, 60Hz, Phase Line

Frequency (MHz)	QP Value (dBµV)	Class B Limit (dB)	Pass / Fail	Margin (dB)	Avg Value (dBµV)	Class B Limit (dB)	Pass / Fail	Margin (dB)	Line
0.19	52.38	64.01	Pass	-11.63	41.64	54.01	Pass	-12.37	Phase
0.32	45.02	59.83	Pass	-14.81	43.15	49.83	Pass	-6.68	Phase
0.43	40.50	57.19	Pass	-16.70	25.77	47.19	Pass	-21.42	Phase
0.84	33.72	56.00	Pass	-22.28	22.83	46.00	Pass	-23.17	Phase
0.59	36.74	56.00	Pass	-19.26	27.53	46.00	Pass	-18.47	Phase
0.64	37.52	56.00	Pass	-18.48	32.68	46.00	Pass	-13.32	Phase

### **5.3 Radiated Emission < 30MHz (9kHz - 30MHz, H-Field)**

**Requirement(s):** 47 CFR §15.225 & RSS-210 (A2.6) & RSS-310 (3.7)

**Procedures:** For < 30MHz, Radiated emissions were measured according to ANSI C63.4. The EUT was set to transmit at the highest output power. The EUT was set 10 meter away from the measuring antenna. The loop antenna was positioned 1 meter above the ground from the centre of the loop. The measuring bandwidth was set to 10 kHz. (Note: During testing the receive antenna was rotated about its axis to maximize the emission from the EUT.)

The limit converted from microvolt/meter to decibel microvolt/meter.

**Sample Calculation:** Corrected Amplitude = Raw Amplitude (dBµV/m) + ACF (dB) + Cable Loss (dB) – Distance Correction Factor

1. All possible modes of operation were investigated. Only the 6 worst case emissions measured, using the correct CISPR detectors, are reported. All other emissions were relatively insignificant.
2. A "-ve" margin indicates a PASS as it refers to the margin present below the limit line at the particular frequency.
3. Radiated Emissions Measurement Uncertainty  
All test measurements carried out are traceable to national standards. The uncertainty of the measurement at a confidence level of approximately 95% (in the case where distributions are normal), with a coverage factor of 2, is +/- 6dB.

4.	Environmental Conditions	Temperature	22°C
		Relative Humidity	48%
		Atmospheric Pressure	1019mbar
	Test Date : March 8 2011		
	Tested By : Dan Corona		

**Results:** Pass

**100 kHz ~ 1 MHz**

General Emission Limit @ 3 Meter

Loop Antenna at 0 degree

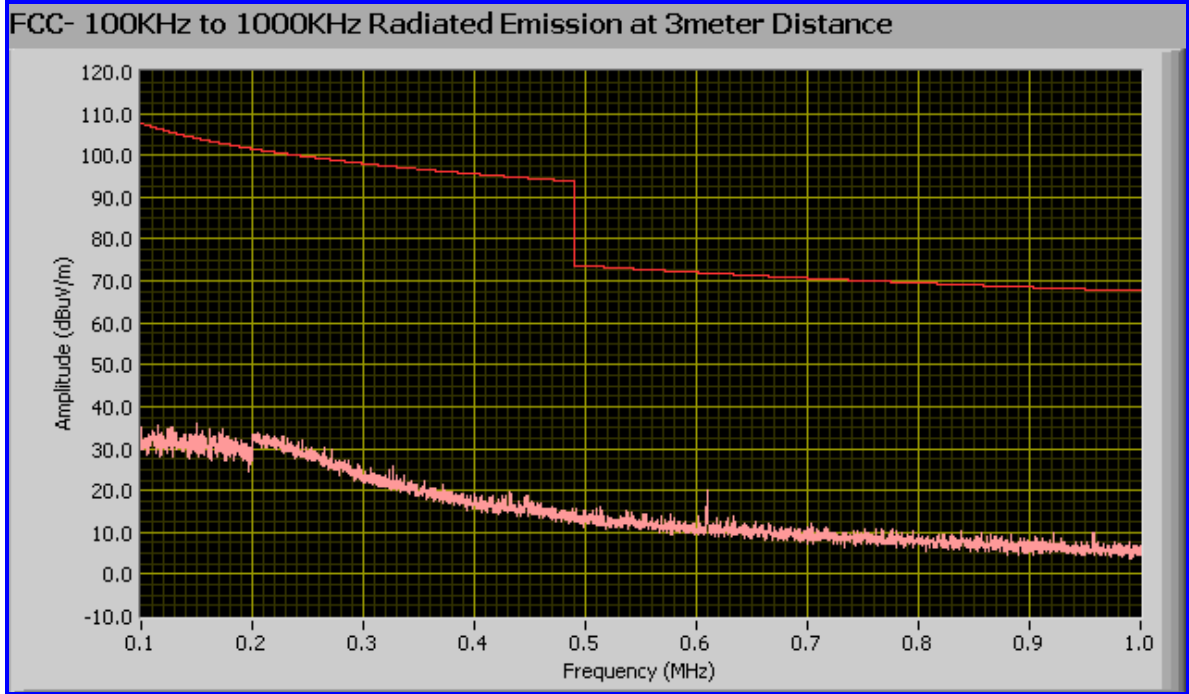

Loop Antenna at 90 degree

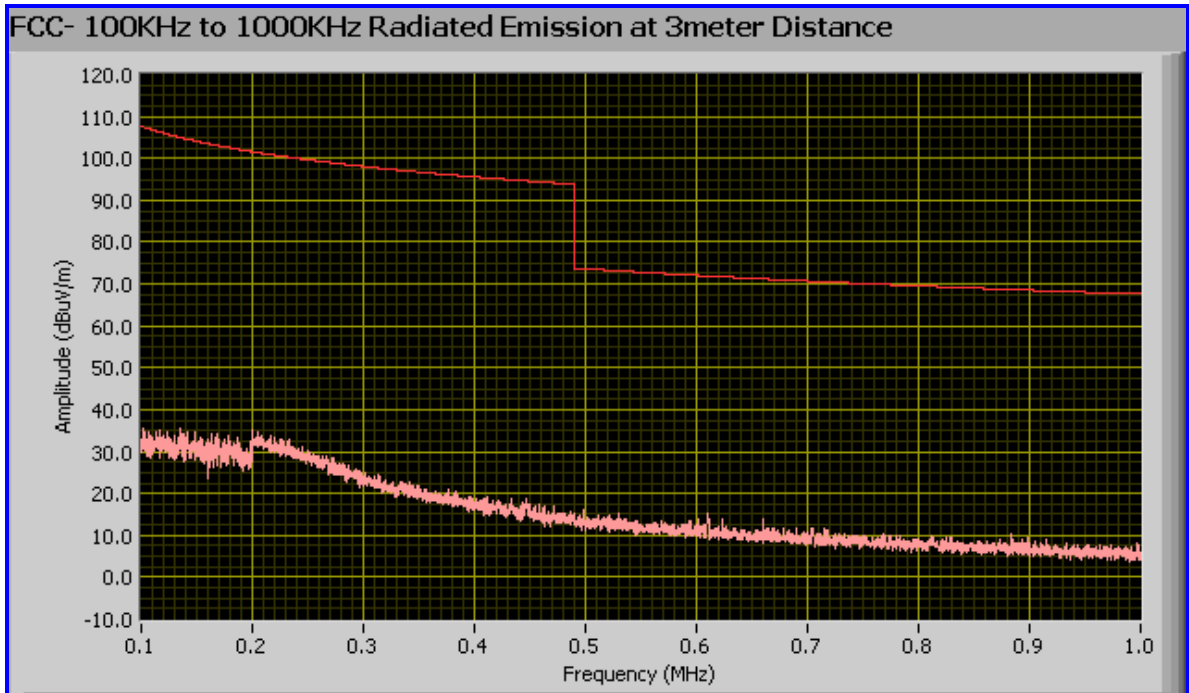

**1MHz ~ 30MHz**

**General Emission Limit @ 3 meter**

Loop Antenna at 0 degree

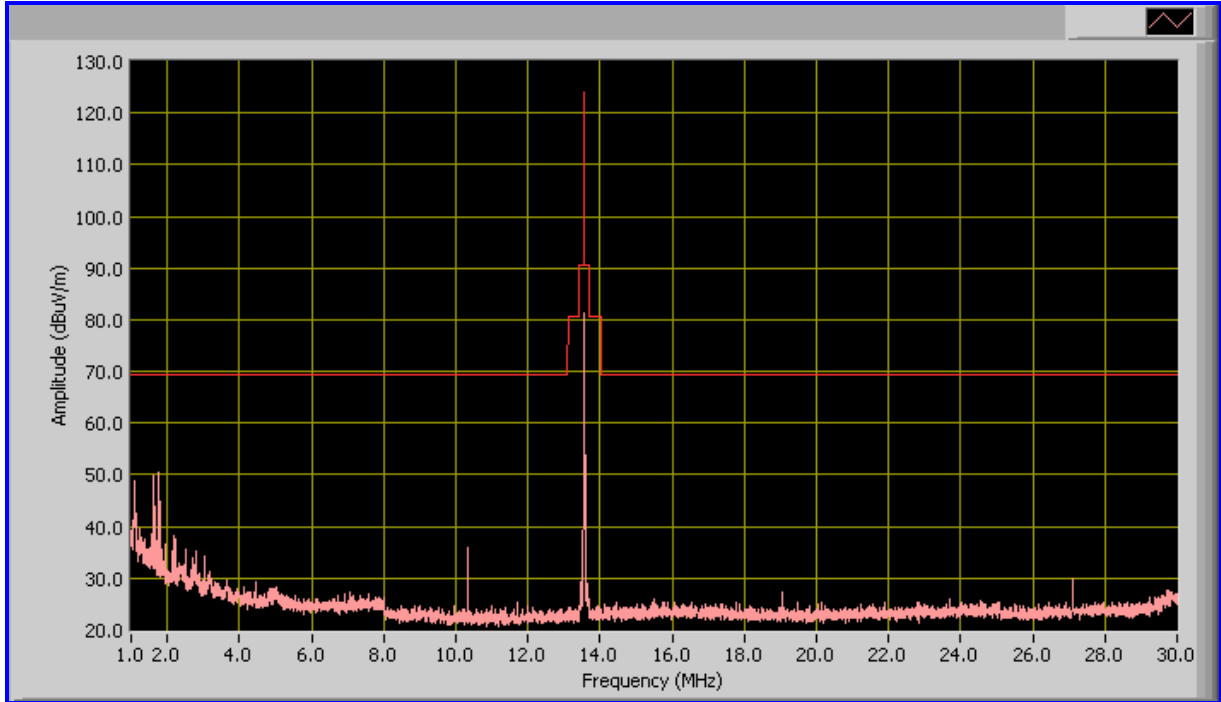

Loop Antenna at 90 degree

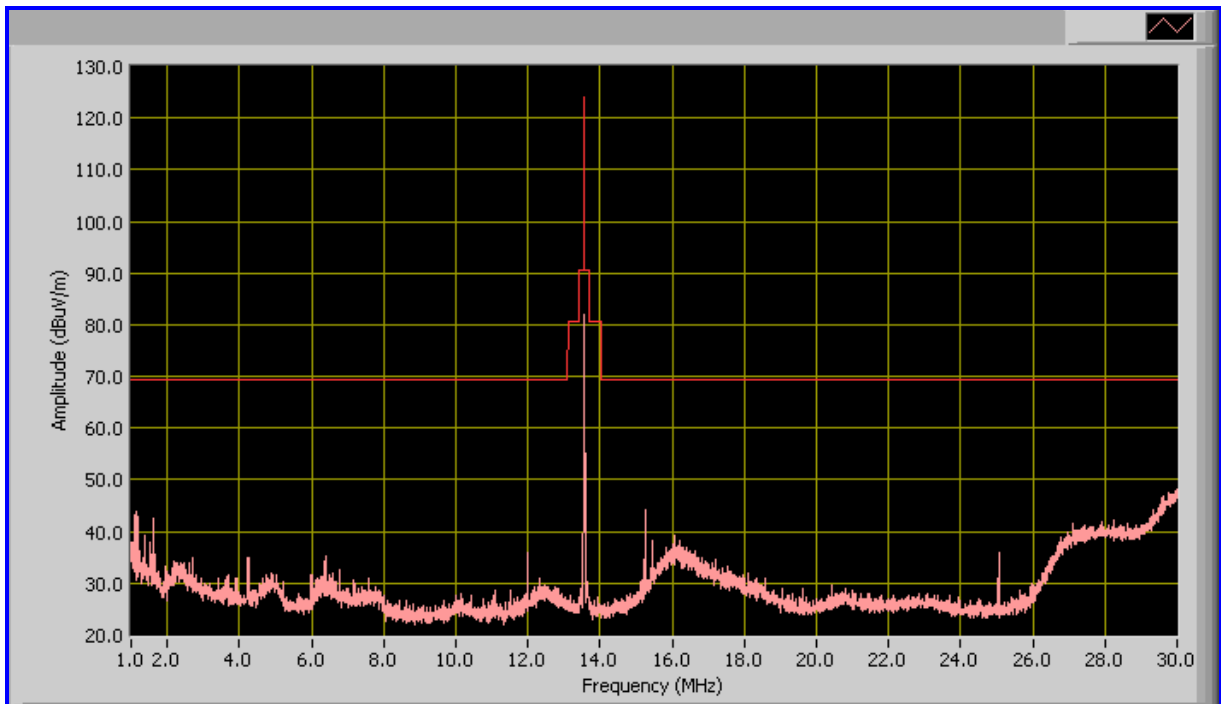

## **5.4 Radiated Emissions > 30 MHz (30MHz – 1 GHz, E-Field)**

**Requirement(s):** 47 CFR §15.209; 47 CFR §15.225(d) & RSS-210 (A2.6)

**Procedures:** For > 30MHz, Radiated emissions were measured according to ANSI C63.4. The EUT was set to transmit at the highest output power. The EUT was set 10 meter away from the measuring antenna. The Log periodic antenna was positioned 1 meter above the ground from the centre of the antenna. The measuring bandwidth was set to 120 kHz. (Note: During testing the receive antenna was raise from 1~4 meters to maximize the emission from the EUT.)

The limit converted from microvolt/meter to decibel microvolt/meter.

Sample Calculation: Corrected Amplitude = Raw Amplitude (dBµV/m) + ACF (dB) + Cable Loss(dB) – Distance Correction Factor

1. All possible modes of operation were investigated. Only the 6 worst case emissions measured, using the correct CISPR detectors, are reported. All other emissions were relatively insignificant.
2. A “-ve” margin indicates a PASS as it refers to the margin present below the limit line at the particular frequency.
3. Radiated Emissions Measurement Uncertainty  
All test measurements carried out are traceable to national standards. The uncertainty of the measurement at a confidence level of approximately 95% (in the case where distributions are normal), with a coverage factor of 2, is +/- 6dB.
4. Environmental Conditions

Temperature	22°C
Relative Humidity	48%
Atmospheric Pressure	1019mbar

Test Date : March 8 2011  
Tested By : Dan Corona

**Results:** Pass

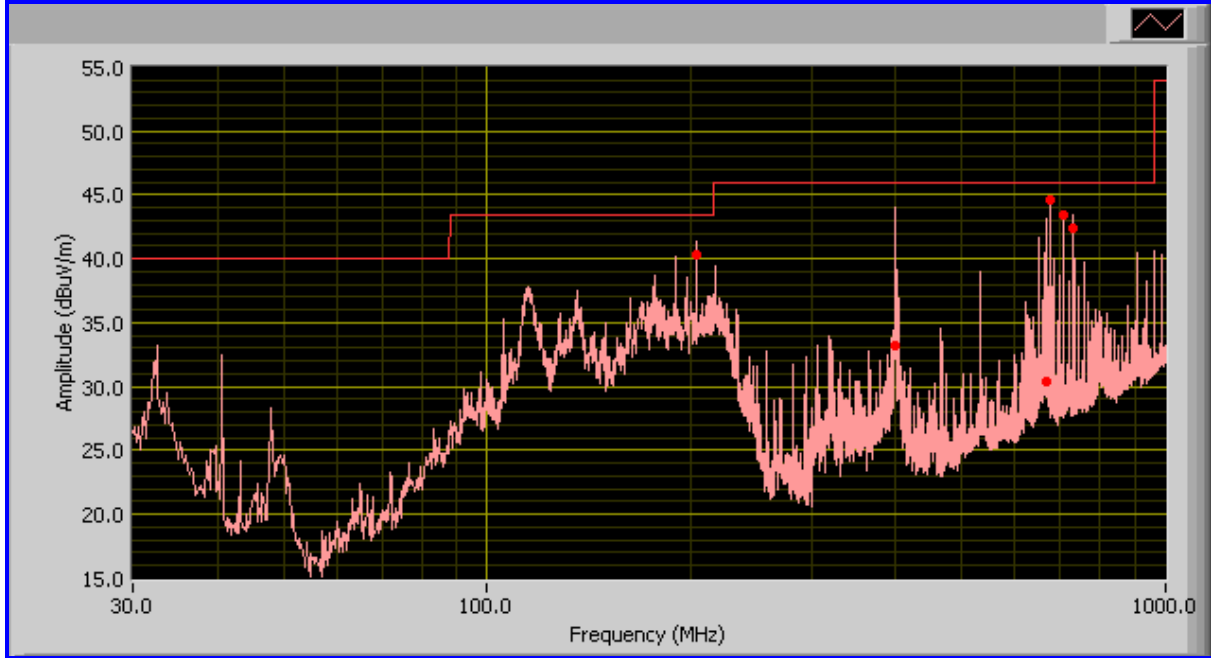

**General Emission Limit @ 3 meter**
**30MHz ~ 1000MHz**

**Radiated Emission Test Table 30MHz ~ 1000MHz**

Frequency (MHz)	Amplitude @ 3m	Azimuth (degree)	Antenna Polarity	Antenna Height (cm)	Limit @ 3 meter	Margin (dB)
678.03	44.98	139.00	H	112.00	46.00	-1.02
400.38	33.16	12.00	V	170.00	46.00	-12.84
203.39	40.35	254.00	H	118.00	43.50	-3.15
732.28	42.36	188.00	H	101.00	46.00	-3.64
665.52	30.45	217.00	H	122.00	46.00	-15.55
705.15	43.48	139.00	H	111.00	46.00	-2.52

## 5.5 Frequency Stability

**Requirement(s):** 47 CFR §15.225(e) & RSS-210 (A2.6)

**Procedures:** Frequency Stability was measured according to 47 CFR §2.1055. Measurement was taken with spectrum analyzer. The spectrum analyzer bandwidth and span was set to read in hertz. A voltmeter was used to monitor when varying the voltage.

Limit:  $\pm 0.01\%$  of 13.56 MHz = 1356 Hz

Environmental Conditions	Temperature	22°C
	Relative Humidity	48%
	Atmospheric Pressure	1019mbar

Test Date : March 8 2011  
 Tested By : Dan Corona

**Results:** Pass

**Frequency Stability versus Temperature:** The Frequency tolerance of the carrier signal shall maintained within  $\pm 0.01\%$  of the operating frequency over a temperature variation of -20°C to +50°C at normal supply voltage.

Reference Frequency: 13.5627061 MHz at -20°C and +50°C

Temperature (°C)	Measured Frequency (MHz)	Frequency Drift (Hz)	Frequency Deviation (Limit: 0.01%)	Pass/Fail
50	13.562666	40.1	<0.01	Pass
40	13.562685	21.1	<0.01	Pass
30	13.562685	21.1	<0.01	Pass
20	Reference (13.5627061 MHz)			
10	13.562690	16.1	<0.01	Pass
0	13.562666	40.1	<0.01	Pass
-10	13.562683	23.1	<0.01	Pass
-20	13.562682	24.1	<0.01	Pass

**Frequency Stability versus Input Voltage:** The Frequency tolerance of the carrier signal shall maintained within  $\pm 0.01\%$ , the frequency of the transmitter was measured at 85% and at 115% of the rated power supply voltage at 20°C environmental temperature.

Carrier Frequency: 13.5627061 MHz at 20°C at 5VDC

Measured Voltage $\pm 15\%$ of nominal (DC)	Measured Frequency (MHz)	Frequency Drift (Hz)	Frequency Deviation (Limit: 0.01%)	Pass/Fail
4.25	13.562681	25.1	<0.01	Pass
5.75	13.562692	14.1	<0.01	Pass

## **5.6 Fundamental Field Strength Test Result**

1. All possible modes of operation were investigated. Only the 6 worst case emissions measured, using the correct CISPR detectors, are reported. All other emissions were relatively insignificant.
2. A “-ve” margin indicates a PASS as it refers to the margin present below the limit line at the particular frequency.
3. Radiated Emissions Measurement Uncertainty  
All test measurements carried out are traceable to national standards. The uncertainty of the measurement at a confidence level of approximately 95% (in the case where distributions are normal), with a coverage factor of 2, is +/- 6dB.

4. Environmental Conditions	Temperature	22°C
	Relative Humidity	48%
	Atmospheric Pressure	1019mbar

Test Date : March 8 2011

Tested By : Dan Corona

### **Test Requirement:**

- (a) The field strength of any emissions within the band 13.553–13.567 MHz shall not exceed 15,848 microvolts/meter at 30 meters.
- (b) Within the bands 13.410–13.553 MHz and 13.567–13.710 MHz, the field strength of any emissions shall not exceed 334 microvolts/meter at 30 meters.
- (c) Within the bands 13.110–13.410 MHz and 13.710–14.010 MHz the field strength of any emissions shall not exceed 106 microvolts/meter at 30 meters.

Loop Antenna at 0 degree

General Emission Limit @ 3 meter

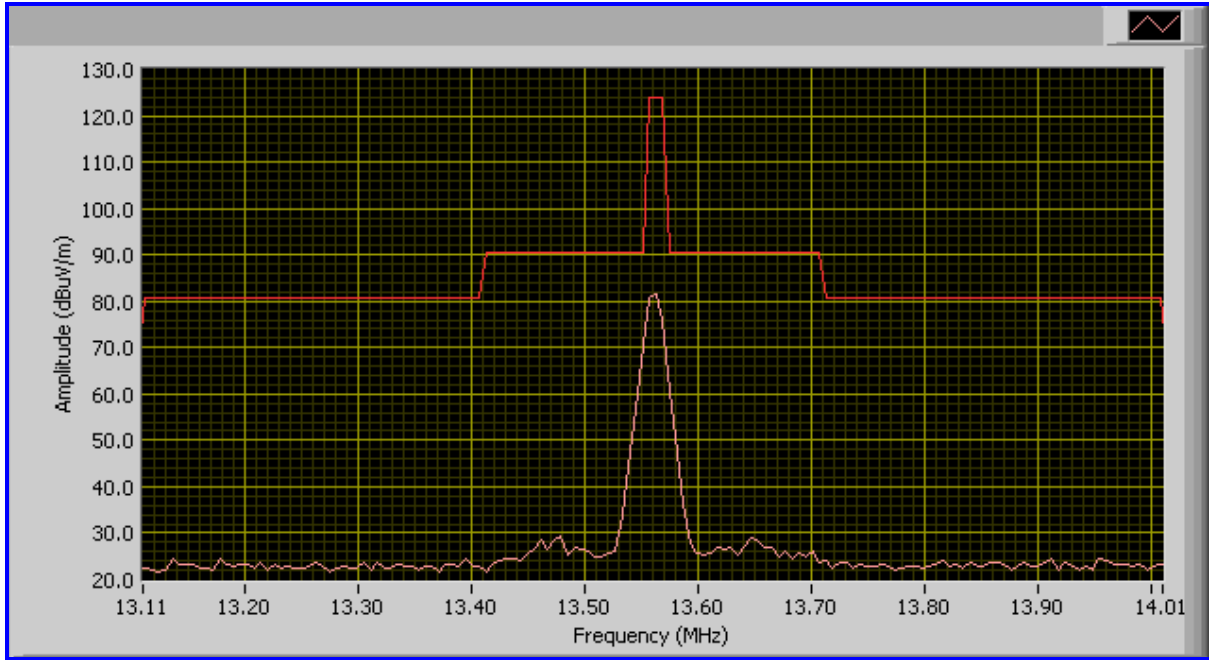

Frequency (MHz)	Corrected Amplitude Reading (dBuV/m)
13.563	81.36

Loop Antenna at 90 degree

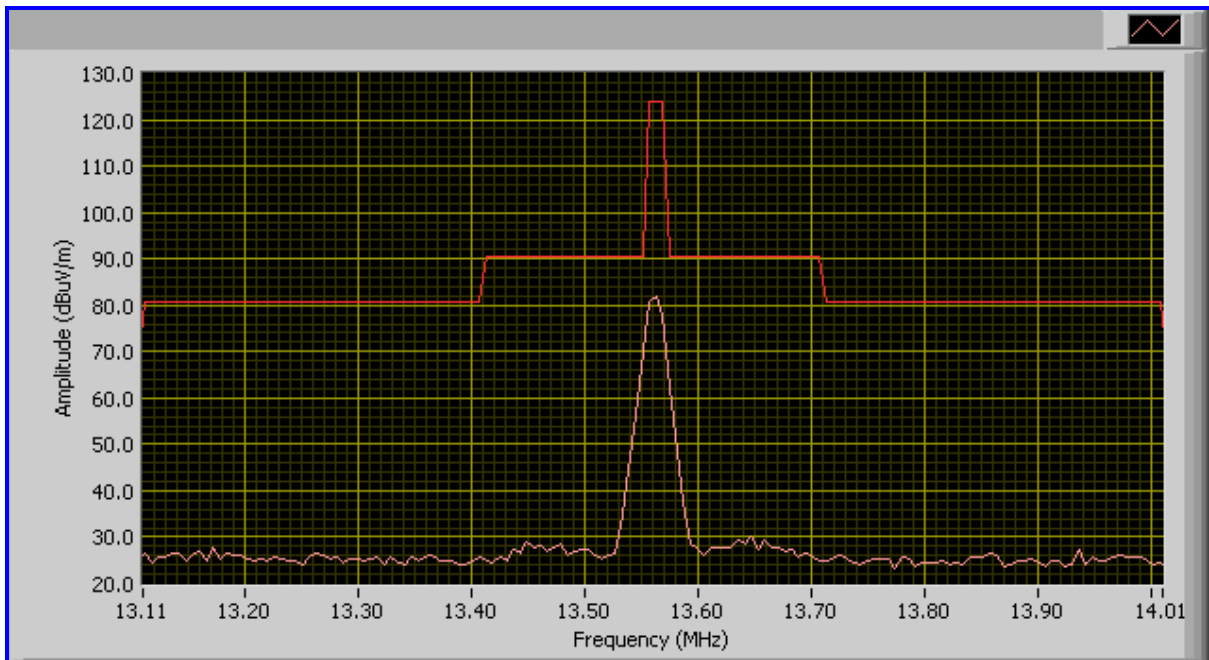

Frequency (MHz)	Corrected Amplitude Reading (dBuV/m)
13.563	82.07

## **5.7 Occupied Bandwidth**

**Requirement(s):** RSS-210 (5.9.1)

**Procedures:** Occupied Bandwidth was measured according to RSS-210 (5.9.1). Measurement was taken with spectrum analyzer. The spectrum analyzer bandwidth and span was set to read in hertz.

Environmental Conditions	Temperature	22°C
	Relative Humidity	48%
	Atmospheric Pressure	1019mbar

Test Date : March 8 2011  
Tested By : Dan Corona

**Results:** Pass

Plots: 13.56 MHz

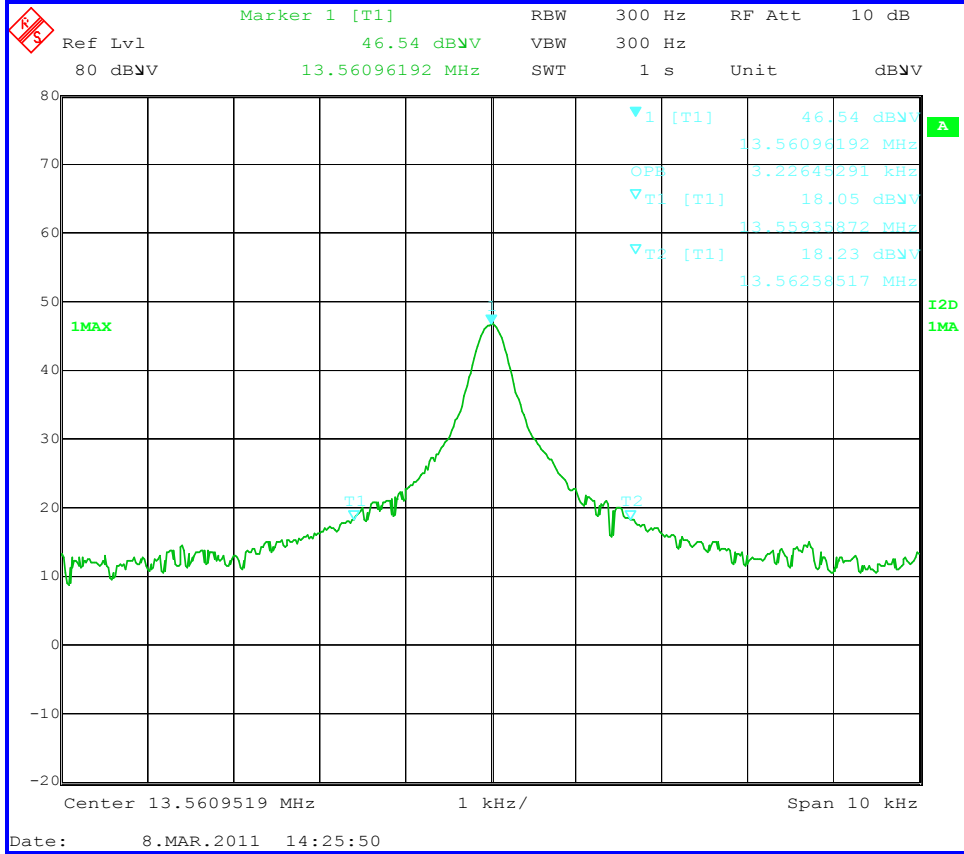

**Annex A. TEST INSTRUMENT & METHOD**

**Annex A.i. TEST INSTRUMENTATION & GENERAL PROCEDURES**

Instrument	Model	Calibration Due
<b>AC Conducted Emissions</b>		
R&S EMI Test Receiver	ESIB40	05/19/2011
R&S LISN	ESH3-Z5	05/18/2011
CHASE LISN	MN2050B	05/18/2011
Sekonic Hygro Hermograph	ST-50	06/04/2012
<b>Radiated Emissions</b>		
Spectrum Analyzer	8564E	05/17/2011
EMI Receiver	ESIB 40	05/19/2011
R&S LISN	ESH3-Z5	05/18/2011
CHASE LISN	MN2050B	05/18/2011
Horn Antenna (1 ~18GHz)	3115	06/02/2011
Biconlog Antenna (30MHz~2GHz)	JB1	06/01/2011
Passive Loop Antenna (10kHz-30MHz)	6512	08/31/2012
3 Meters SAC	3m	10/13/2011
Sekonic Hygro Hermograph	ST-50	06/04/2012
Pre-Amplifier(1 ~ 26GHz)	8449B	05/17/2011
Horn Antenna (18~40GHz)	AH-840	07/23/2013
Microwave Pre-Amp (18~40GHz)	PA-840	11/30/2011

## Annex A.ii. CONDUCTED EMISSIONS TEST DESCRIPTION

### Test Set-up

1. The EUT and supporting equipment were set up in accordance with the requirements of the standard on top of a 1.5m x 1m x 0.8m high, non-metallic table, as shown in [Annex B](#).
2. The power supply for the EUT was fed through a 50Ω/50μH EUT LISN, connected to filtered mains.
3. The RF OUT of the EUT LISN was connected to the EMI test receiver via a low-loss coaxial cable.
4. All other supporting equipments were powered separately from another main supply.

### Test Method

1. The EUT switched on and allowed to warm up to its normal operating condition.
2. A scan was made on the NEUTRAL line (for AC mains) or Earth line (for DC power) over the required frequency range using an EMI test receiver.
3. High peaks, relative to the limit line, were then selected.
4. The EMI test receiver was then tuned to the selected frequencies and the necessary measurements made with a receiver bandwidth setting of 10 KHz. For FCC tests, only Quasi-peak measurements made; while for CISPR/EN tests, both Quasi-peak and Average measurements made.
5. Steps 2 to 4 then repeated for the LIVE line (for AC mains) or DC line (for DC power).

### Description of Conducted Emission Program

This EMC Measurement software run LabView automation software and offers a common user interface for electromagnetic interference (EMI) measurements. This software is a modern and powerful tool for controlling and monitoring EMI test receivers and EMC test systems. It guarantees reliable collection, evaluation, and documentation of measurement results. Basically, this program will run a pre-scan measurement before it proceeds with the final measurement. The pre-scan routine will run the common scan range from 15 kHz to 30 MHz; the program will first start a peak and average scan on selectable measurement time and step size. After the program complete the pre-scan, this program will perform the Quasi Peak and Average measurement, based on the pre-scan peak data reduction result.

### Sample Calculation Example

At 20 MHz	limit = 250 μV = 47.96 dBμV
Transducer factor of LISN, pulse limiter & cable loss at 20 MHz = 11.20 dB	
Q-P reading obtained directly from EMI Receiver = 40.00 dBμV	
	(Calibrated for system losses)
Therefore, Q-P margin = 47.96 – 40.00 = 7.96	i.e. <b>7.96 dB below limit</b>



## Annex A. iii RADIATED EMISSIONS TEST DESCRIPTION

### EUT Characterisation

EUT characterisation, over the frequency range from 100kHz – 1GHz to 10<sup>th</sup> Harmonic , was done in order to minimise radiated emissions testing time while still maintaining high confidence in the test results.

The EUT was placed in the chamber, at a height of about 0.8m on a turntable. Its radiated emissions frequency profile was observed, using a spectrum analyzer /receiver with the appropriate broadband antenna placed 3m away from the EUT. Radiated emissions from the EUT were maximised by rotating the turntable manually, changing the antenna polarisation and manipulating the EUT cables while observing the frequency profile on the spectrum analyzer / receiver. Frequency points at which maximum emissions occurred; clock frequencies and operating frequencies were then noted for the formal radiated emissions test at the Open Area Test Site (OATS) at 10m distance.

### Test Set-up

1. The EUT and supporting equipment were set up in accordance with the requirements of the standard on top of a 1.5m X 1.0m X 0.8m high, non-metallic table.
2. The filtered power supply for the EUT and supporting equipment were tapped from the appropriate power sockets located on the turntable.
3. The relevant broadband antenna was set at the required test distance away from the EUT and supporting equipment boundary.

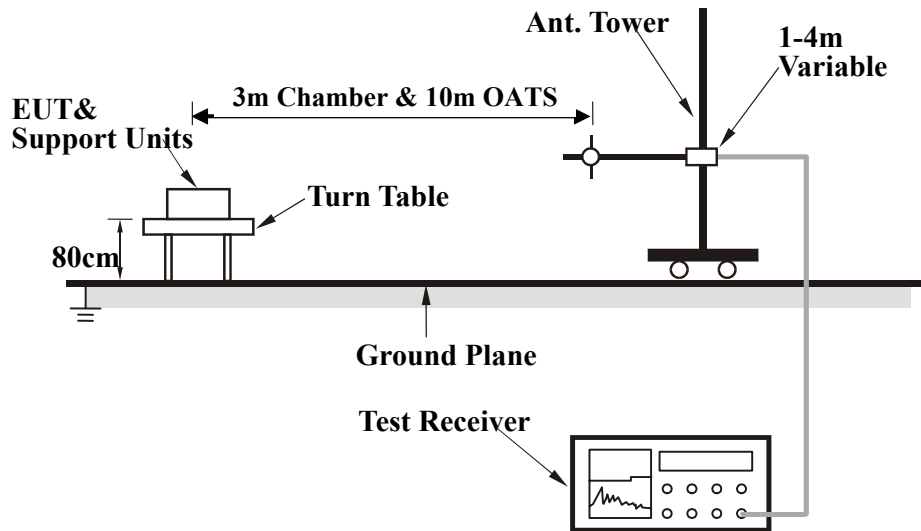

## **Test Method**

The following procedure was performed to determine the maximum emission axis of EUT:

1. With the receiving antenna is H polarization, rotate the EUT in turns with three orthogonal axes to determine the axis of maximum emission.
2. With the receiving antenna is V polarization, rotate the EUT in turns with three orthogonal axes to determine the axis of maximum emission.
3. Compare the results derived from above two steps. So, the axis of maximum emission from EUT was determined and the configuration was used to perform the final measurement.

### **Final Radiated Emission Measurement**

1. Setup the configuration according to figure 1. Turn on EUT and make sure that it is in normal function.
2. For emission frequencies measured below 1 GHz, a pre-scan is performed in a shielded chamber to determine the accurate frequencies of higher emissions will be checked on a open test site. As the same purpose, for emission frequencies measured above 1 GHz, a pre-scan also be performed with a 1 meter measuring distance before final test.
3. For emission frequencies measured below 1 GHz, set the spectrum analyzer on a 100 kHz and 1 MHz resolution bandwidth respectively for each frequency measured in step 2.
4. The search antenna is to be raised and lowered over a range from 1 to 4 meters in horizontally polarized orientation. Position the highness when the highest value is indicated on spectrum analyzer, then change the orientation of EUT on test table over a range from 0° to 360° with a speed as slow as possible, and keep the azimuth that highest emission is indicated on the spectrum analyzer. Vary the antenna position again and record the highest value as a final reading.
5. Repeat step 4 until all frequencies need to be measured were complete.
6. Repeat step 5 with search antenna in vertical polarized orientations.

During the radiated emission test, the Spectrum Analyzer was set with the following configurations:

Frequency Band (MHz)	Function	Resolution bandwidth	Video Bandwidth
30 to 1000	Peak	100 kHz	100 kHz
Above 1000	Peak	1 MHz	1 MHz
	Average	1 MHz	10 Hz

## **Description of Radiated Emission Program**

This EMC Measurement software run LabView automation software and offers a common user interface for electromagnetic interference (EMI) measurements. This software is a modern and powerful tool for controlling and monitoring EMI test receivers and EMC test systems. It guarantees reliable collection, evaluation, and documentation of measurement results. Basically, this program will run a pre-scan measurement before it proceeds with the final measurement. The pre-scan routine will run the scan on four different antenna heights, 2 antenna polarity, and 360 degrees table rotation. For example, the program was set to run 30 MHz to 1 GHz scan; the program will first start from a meter antenna height and divide the 30 MHz to 1 GHz into 10 separate parts of maximum hold sweeps. Each parts of maximum hold sweep, the program will collect the data from 0 degree to 360 degrees table rotation. After the program complete the 1m scan, the antenna continues to rise to 2m and continue the scan. The step will repeated for all specified antenna height and polarity. This program will perform the Quasi Peak measurement after the signal maximization process and pre-scan routine. The final measurement will be base on the pre-scan data reduction result.

## **Sample Calculation Example**

The field strength is calculated by adding the Antenna Factor and Cable Factor, and subtracting the Amplifier Gain (if any) from the measured reading. For the limit is employed average value, therefore the peak value can be transferred to average value by subtracting the duty factor. The basic equation with a sample calculation is as follows:

$$\text{Peak} = \text{Reading} + \text{Corrected Factor}$$

Where:

Corr. Factor = Antenna Factor + Cable Factor - Amplifier Gain (if any)

And the average value is

$$\text{Average} = \text{Peak Value} + \text{Duty Factor or}$$

$$\text{Set RBW} = 1\text{MHz, VBW} = 10\text{Hz.}$$

Note:

If the measured frequencies are fall in the restricted frequency band, the limit employed must be quasi peak value when frequencies are below or equal to 1 GHz. And the measuring instrument is set to quasi peak detector function.

## **Annex B. TEST SETUP PHOTOGRAPHS**

**Please See Attachment**

## **Annex B. i. EUT INTERNAL PHOTOGRAPHS**

**Please see attachment**

## **Annex B. ii. EUT EXTERNAL PHOTOGRAPHS**

**Please see attachment**

**Annex C. SUPPORTING EQUIPMENT DESCRIPTION**

The following is a description of supporting equipment and details of cables used with the EUT.

Equipment Description (Including Brand Name)	Model & Serial Number	Cable Description (List Length, Type & Purpose)
Laptop/DELL	Latitude D600	USB Cable , 2m

**NOTE:** No special supporting equipment used or needed during testing to achieve compliance.

### Block Configuration Diagram for Radiated Emission

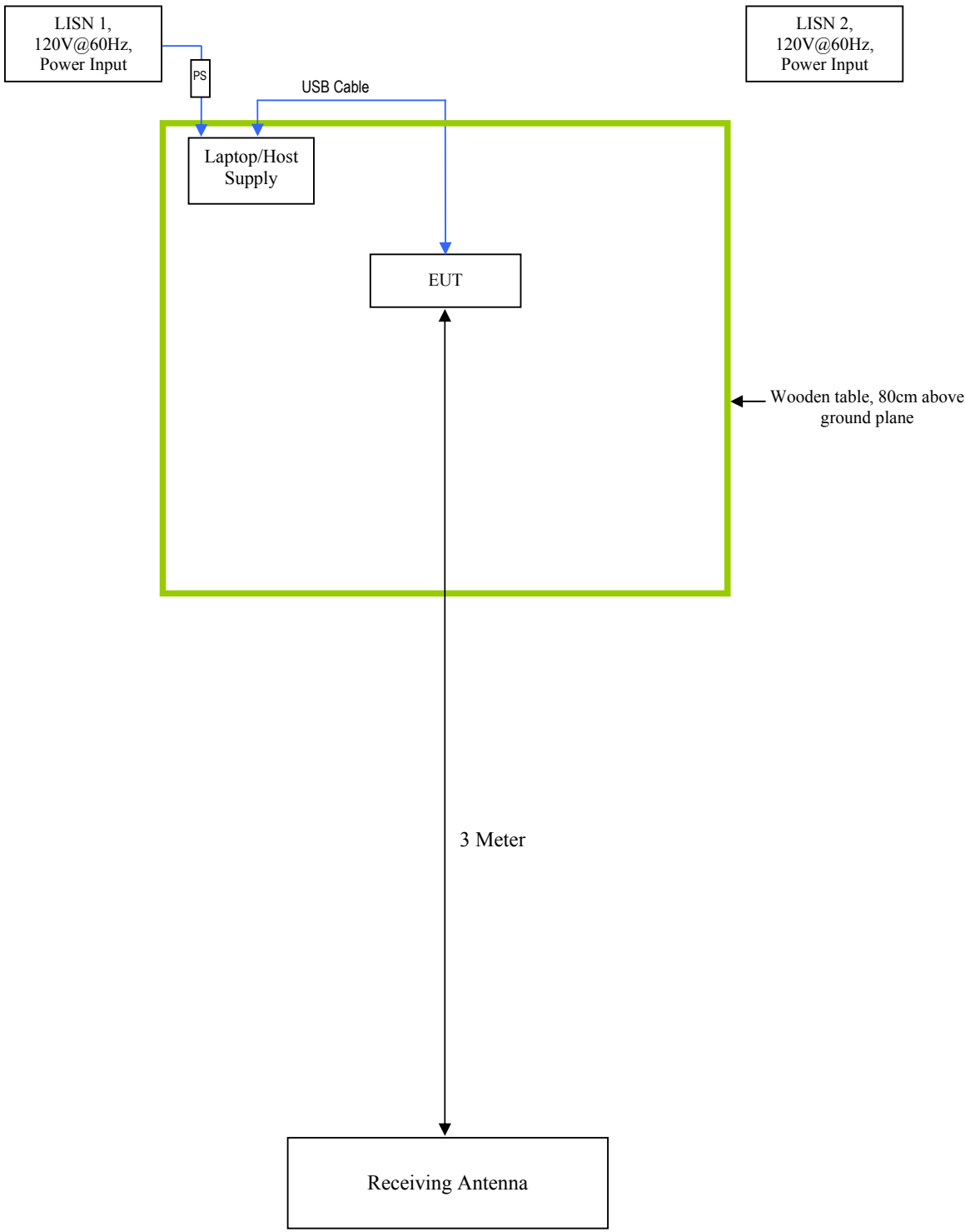

### Block Configuration Diagram Conducted Emission

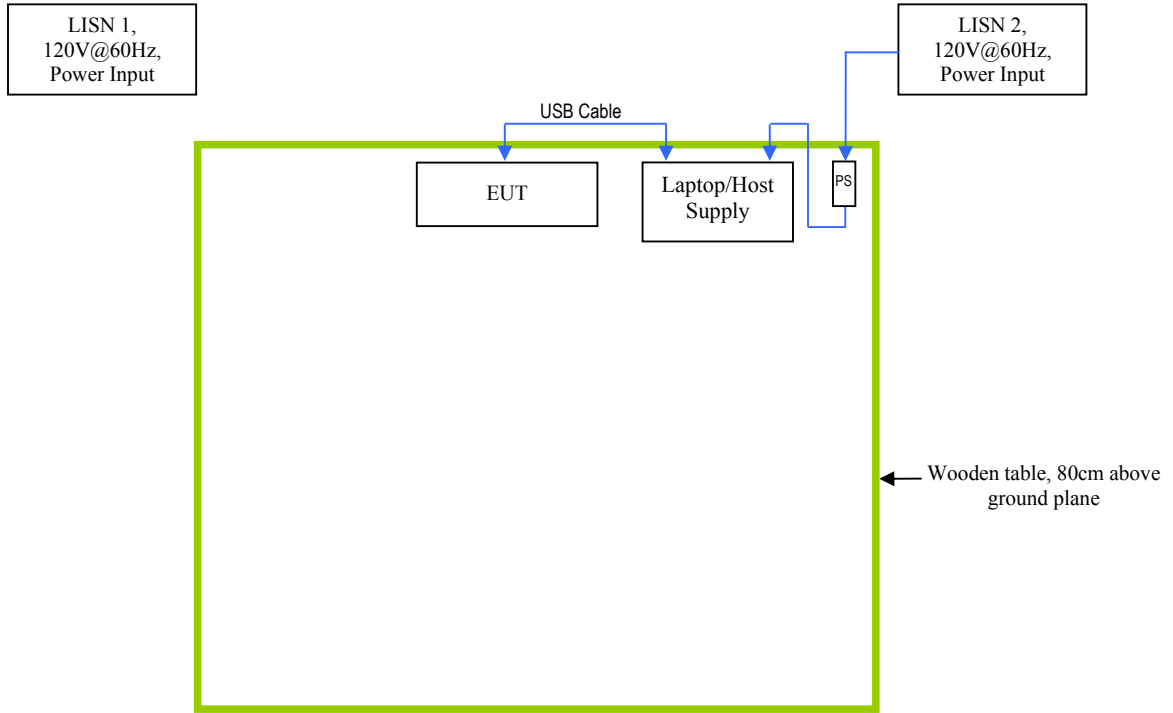

**NOTE:** EUT was powered by Host using USB as the host interface



**Annex D. EUT OPERATING CONDITIONS**

The following is the description of how the EUT is exercised during testing.

Test	Description Of Operation
<b>Emissions Testing</b>	The EUT was controlled by itself.
<b>Others Testing</b>	The EUT was controlled by itself.

## **Annex E. USER MANUAL, BLOCK & CIRCUIT DIAGRAM**

**Please see attachment**

## Laboratory Introduction

SIEMIC, headquartered in the heart of Silicon Valley, with superior facilities in US and Asia, is one of the leading independent testing and certification facilities providing customers with one-stop shop services for Compliance Testing and Global Certifications.



In addition to [testing](#) and [certification](#), SIEMIC provides initial design reviews and [compliance management](#) through out a project. Our extensive experience with [China](#), [Asia Pacific](#), [North America](#), [European](#), and [international](#) compliance requirements, assures the fastest, most cost effective way to attain regulatory compliance for the [global markets](#).

### Accreditations for Conformity Assessment

Country/Region	Accreditation Body	Scope
USA	FCC, A2LA	EMC , RF/Wireless , Telecom , SAR
Canada	IC, A2LA, NIST	EMC, RF/Wireless , Telecom , SAR
Taiwan	BSMI , NCC , NIST	EMC, RF, Telecom , Safety
Hong Kong	OFTA , NIST	RF/Wireless ,Telecom
Australia	NATA, NIST	EMC, RF, Telecom , Safety
Korea	KCC/RRA, NIST	EMI, EMS, RF , Telecom, Safety , SAR
Japan	VCCI, JATE, TELEC, RFT	EMI, RF/Wireless, Telecom
Mexico	NOM, COFETEL, Caniety	Safety, EMC , RF/Wireless, Telecom
Europe	A2LA, NIST	EMC, RF, Telecom , Safety, SAR

### Accreditations for Product Certifications

Country	Accreditation Body	Scope
USA	FCC TCB, NIST	EMC , RF , Telecom
Canada	IC FCB , NIST	EMC , RF , Telecom
Singapore	iDA, NIST	EMC , RF , Telecom
EU	NB	EMC & R&TTE Directive

**Annex F. SIEMIC ACCREDITATION CERTIFICATES**

**SIEMIC ACREDITATION DETAILS: A2LA Certificate Number: 2742.01**

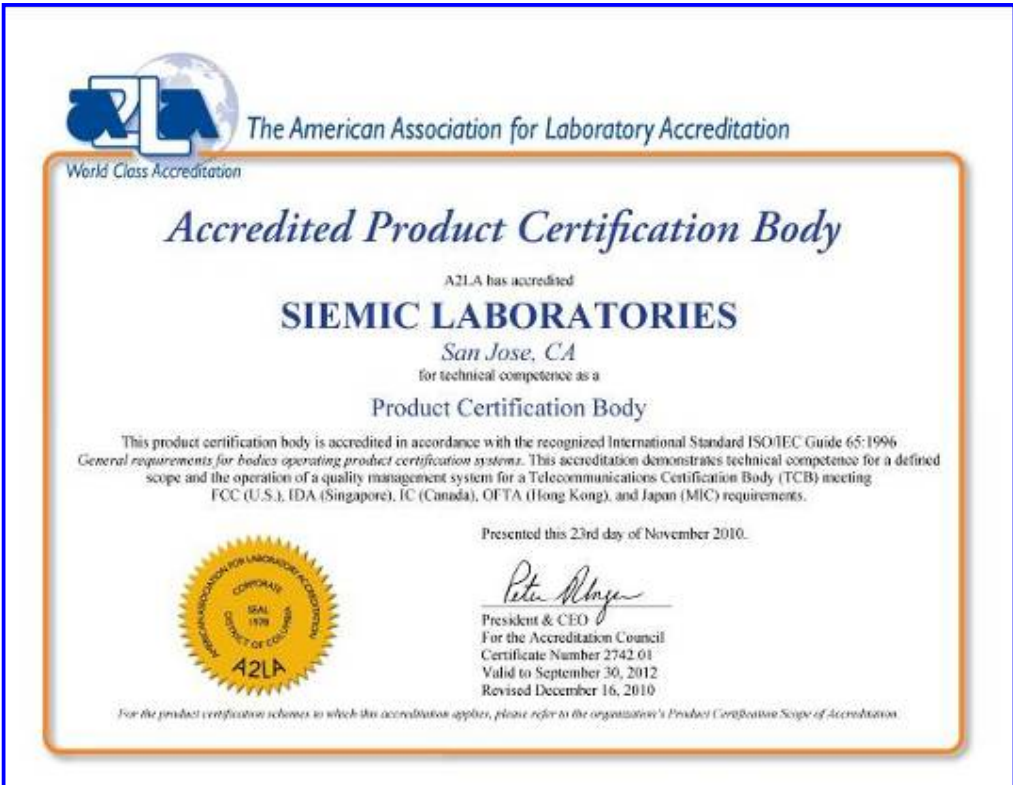



**The American Association for Laboratory Accreditation**

SCOPE OF ACCREDITATION TO ISO/IEC GUIDE 65:1996

SIEMIC INC.  
 2206 Ringwood Ave.  
 San Jose, CA 95131  
 Mr. Snell Leong (Authorized Representative) Phone: 408 526 1188  
[www.siemic.com](http://www.siemic.com)

PRODUCT CERTIFICATION CONFORMITY ASSESSMENT BODY (CAB)

Valid to: September 30, 2012

Certificate Number: 2742.02

In recognition of the successful completion of the A2LA Certification Body Accreditation Program evaluation, including the US Federal Communications Commission (FCC), Industry Canada (IC), Singapore (IDA) and Hong Kong (OFTA) requirements for the indicated types of product certifications, accreditation is granted to this organization to perform the following product certification schemes:

Economy Scope

**Federal Communication Commission - (FCC)**

Unlicensed Radio Frequency Devices	A1, A2, A3, A4
Licensed Radio Frequency Devices	B1, B2, B3, B4
Telephone Terminal Equipment	C

*\*Please refer to FCC TCB Program Roles and Responsibilities, released July 22, 2010 detailing scopes, roles and responsibilities. <http://fjallfoss.fcc.gov/oetcf/kdb/forms/FTSsearchResultPage.cfm?id=44683&switch=P>*

**Industry Canada - (IC)**

Radio	Scope 1-Licence-Exempt Radio Frequency Devices; Scope 2-Licensed Personal Mobile Radio Services; Scope 3-Licensed General Mobile & Fixed Radio Services; Scope 4-Licensed Maritime & Aviation Radio Services; Scope 5-Licensed Fixed Microwave Radio Services;
-------	--

*\*Please refer to Industry Canada (IC) website at: <http://www.ic.gc.ca/eic/site/smt-gst.nsf/eng/sf09888.html>*

**IDA – Singapore**

Line Terminal Equipment	All Technical Specifications for Line Terminal Equipment – Table 1 of IDA MRA Recognition Scheme: 2009, Annex 2
Radio-Communication Equipment	All Technical Specifications for Radio-Communication Equipment – Table 2 of IDA MRA Recognition Scheme: 2009, Annex 2

*\*Please refer to Info-Communication Development Authority (IDA) Singapore website at: [http://www.ida.gov.sg/doc/Policies%20and%20Regulation/Policies\\_and\\_Regulation\\_Level2/20060609145118/MRAREcScheme.pdf](http://www.ida.gov.sg/doc/Policies%20and%20Regulation/Policies_and_Regulation_Level2/20060609145118/MRAREcScheme.pdf)*

(A2LA Cert. No. 2742.02) Revised 12/16/2010

*Peter Mlynek* Page 1 of 2



**OFTA – Hong Kong**

Radio Equipment HKTA 1001, 1002, 1003, 1004, 1005, 1006, 1007, 1008,  
1009, 1010, 1015, 1016, 1019, 1020, 1022, 1026, 1027,  
1029, 1030, 1031, 1032, 1033, 1034, 1035, 1036, 1037,  
1038, 1039, 1041, 1042, 1043, 1044, 1045, 1046, 1047,  
1048, 1049, 1050, 1051, 1052, 1053, 1054, 1055

*\*Please refer to the Office of the Telecommunications Authority's website at:  
<http://www.ofta.gov.hk/en/standards/HKTASpec/hkta-10xx.html>*

Fixed Network Equipment HKTA 2001, 2005, 2011, 2012, 2013, 2014, 2015, 2016,  
2017, 2018, 2019, 2020, 2021, 2022, 2023, 2024, 2025,  
2026, 2027, 2028, 2029, 2030, 2031, 2032, 2033, 2034,  
2035, 2036, 2037, 2040, 2041, 2102, 2103,  
2104, 2108, 2201, 2202, 2203, 2204

*\*Please refer to the Office of the Telecommunications Authority's website at:  
<http://www.ofta.gov.hk/en/standards/HKTASpec/hkta-2xxx.html>*

**MIC – Japan**

Terminal Equipment Scope A1 - Terminal Equipment for the Purpose of Calls

Radio Equipment Scope B1 - Unlicensed Station (all classes of equipment)



**SIEMIC, Inc.**  
Accessing global markets

Title: RF Test Report of HID Global Corporation  
Model : 3500  
To: FCC 15.225 2010, RSS-210 Issue 8

Serial# SL11021502-HID-005\_veriCLASS (FCC,IC)  
Issue Date March 17 2011  
Page 39 of 53  
www.siemic.com

**SIEMIC ACREDITATION DETAILS: FCC Test Site Registration No. 783147**

**FEDERAL COMMUNICATIONS COMMISSION**

Laboratory Division  
7435 Oakland Mills Road  
Columbia, MD 21046

September 12, 2008

Registration Number: 783147

SIEMIC Laboratories  
2206 Ringwood Avenue,  
San Jose, CA 95131

Attention: Leslie Bai

Re: Measurement facility located at San Jose  
Anechoic chamber (3 meters)  
Date of Listing: February 10, 2004

Dear Sir or Madam:

Your request for registration of the subject measurement facility has been reviewed and found to be in compliance with the requirements of Section 2.948 of the FCC rules. The information has, therefore, been placed on file and the name of your organization added to the list of facilities whose measurement data will be accepted in conjunction with applications for Certification under Parts 15 or 18 of the Commission's Rules. Please note that the file must be updated for any changes made to the facility and the registration must be renewed at least every three years. Please also note that this registration does not recognize the measurement facility to perform testing for products authorized under the Declaration of Conformity (DoC) process. In order to test products subject to DoC authorization process, a measurement facility must be accredited and recognized by the FCC.

Measurement facilities that have indicated that they are available to the public to perform measurement services on a fee basis may be found on the FCC website [www.fcc.gov](http://www.fcc.gov) under E-Filing, OET Equipment Authorization Electronic Filing, Test Firms.

Sincerely,

Katie Hawkins  
Electronics Engineer

**SIEMIC ACREDITATION DETAILS: Industry of Canada CAB ID : US0160**



**UNITED STATES DEPARTMENT OF COMMERCE**  
**National Institute of Standards and Technology**  
Gaithersburg, Maryland 20899-

March 4, 2009

Mr. Leslie Bai  
SIEMIC, Inc.  
2206 Ringwood Avenue  
San Jose, CA 95131

Dear Mr. Bai:

NIST is pleased to inform you that your laboratory has been recognized by Industry Canada (IC), under the Asia Pacific Economic Cooperation for Telecommunications Equipment Mutual Recognition Arrangement (APEC Tel MRA). Your laboratory is now designated to act as a Conformity Assessment Body (CAB) under Appendix B, **Phase I** Procedures, of the APEC Tel MRA. The pertinent information about your laboratory's designation is as follows:

CAB Name: SIEMIC, Inc.  
Physical Location: 2206 Ringwood Avenue, San Jose, CA 95131 USA  
Identification No.: US0160  
Recognized Scope: CS-03 Part I, II, V, VI, VII and VIII

You may submit test data to IC to verify that the equipment to be imported into Canada satisfies the applicable requirements. The designation of your organization will remain in force as long as its accreditation for the designated scope remains valid and comply with the designation requirements.

Recognized CABs are listed on the NIST website at <http://ts.nist.gov/mra>. Please contact Ms. Ramona Saar at (301) 975-5521 or [ramona.saar@nist.gov](mailto:ramona.saar@nist.gov) if you have any questions.

Sincerely,

David F. Alderman  
Group Leader, Standards Coordination and Conformity Group  
Standards Services Division

Enclosure

cc: CAB Program Manager



**SIEMIC ACREDITATION DETAILS: Industry of Canada Test Site Registration No. 4842-1**



May 27, 2010

OUR FILE: 46405-4842  
Submission No: 140856

**Siemic Inc.**  
2206 Ringwood Ave  
San Jose, CA, 95131  
USA

**Attention:** Snell Leong

Dear Sir/Madame:

The Bureau has received your application for the renewal of a 3m alternative test site. Be advised that the information received was satisfactory to Industry Canada. The following number(s) is now associated to the site(s) for which registration / renewal was sought ( **4842A-1** ). Please reference the appropriate site number in the body of test reports containing measurements performed on the site. In addition, please keep for your records the following information;

- Your primary code is: **4842**
- The company number associated to the site(s) located at the above address is: **4842A**

Furthermore, to obtain or renew a unique site number, the applicant shall demonstrate that the site has been accredited to ANSI C63.4-2003 or later. A scope of accreditation indicating the accreditation by a recognized accreditation body to ANSI C63.4-2003 or later shall be accepted. Please indicate in a letter the previous assigned site number if applicable and the type of site (example: 3 metre OATS or 3 metre chamber). If the test facility is not accredited to ANSI C63.4-2003 or later, the test facility shall submit test data demonstrating full compliance with the ANSI standard. The Bureau will evaluate the filing to determine if recognition shall be granted.

The frequency for re-validation of the test site and the information that is required to be filed or retained by the testing party shall comply with the requirements established by the accrediting organization. However, in all cases, test site re-validation shall occur on an interval not to exceed two years. There is no fee or form associated with an OATS filing. OATS submissions are encouraged to be submitted electronically to the Bureau using the following URL;  
[http://strategis.ic.gc.ca/epic/internet/inceb-bhst.nsf/en/h\\_tt00052e.html](http://strategis.ic.gc.ca/epic/internet/inceb-bhst.nsf/en/h_tt00052e.html)

If you have any questions, you may contact the Bureau by e-mail at [certification\\_bureau@ic.gc.ca](mailto:certification_bureau@ic.gc.ca) Please reference our file and submission number above for all correspondence.

Yours sincerely,

Dalwinder Gill  
For: Wireless Laboratory Manager  
Certification and Engineering Bureau  
3701 Carling Ave., Building 94  
P.O. Box 11490, Station "H"  
Ottawa, Ontario K2H 8S2  
Email: [dalwinder.gill@ic.gc.ca](mailto:dalwinder.gill@ic.gc.ca)  
Tel. No. (613) 998-8363  
Fax. No. (613) 990-4752

**SIEMIC ACREDITATION DETAILS: FCC DOC CAB Recognition : US1109**

**FEDERAL COMMUNICATIONS COMMISSION**

**Laboratory Division  
7435 Oakland Mills Road  
Columbia, MD 21046**

August 28, 2008

Siemic Laboratories  
2206 Ringwood Ave.,  
San Jose, CA 95131

Attention: Leslie Bai

Re: Accreditation of Siemic Laboratories  
Designation Number: US1109  
Test Firm Registration #: 540430

Dear Sir or Madam:

We have been notified by American Association for Laboratory Accreditation that Siemic Laboratories has been accredited as a Conformity Assessment Body (CAB).

At this time Siemic Laboratories is hereby designated to perform compliance testing on equipment subject to Declaration Of Conformity (DOC) and Certification under Parts 15 and 18 of the Commission's Rules.

This designation will expire upon expiration of the accreditation or notification of withdrawal of designation.

Sincerely,

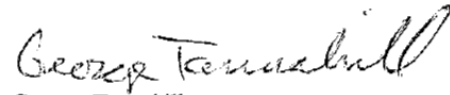

George Tannahill  
Electronics Engineer

**SIEMIC ACREDITATION DETAILS: Australia CAB ID : US0160**



**UNITED STATES DEPARTMENT OF COMMERCE**  
**National Institute of Standards and Technology**  
Gaithersburg, Maryland 20899-

November 20, 2008

Mr. Leslie Bai  
SIEMIC, Inc.  
2206 Ringwood Avenue  
San Jose, CA 95131

Dear Mr. Bai:

NIST is pleased to inform you that your laboratory has been recognized by the Australian Communications and Media Authority (ACMA) under the Asia Pacific Economic Cooperation for Telecommunications Equipment Mutual Recognition Arrangement (APEC Tel MRA). Your laboratory is now designated to act as a Conformity Assessment Body (CAB) under Appendix B, **Phase I** Procedures, of the APEC Tel MRA. The pertinent information about your laboratory's designation is as follows:

CAB Name: Siemic, Inc.  
Physical Location: 2206 Ringwood Avenue, San Jose, CA 95131  
Identification No.: US0160  
Recognized Scope: **EMC:** AS/NZS 4251.1 (until 5/31/2009), AS/NZS 4251.2 (until 5/31/2009), AS/NZS CISPR 11, AS/NZS CISPR 14.1, AS/NZS CISPR 22, AS/NZS 61000.6.3, AS/NZS 61000.6.4  
**Radiocommunications:** AS/NZS 4281, AS/NZS 4268, AS/NZS 4280.1, AS/NZS 4280.2, AS/NZS 4295, AS/NZS 4582, AS/NZS 4583, AS/NZS 4769.1, AS/NZS 4769.2, AS/NZS 4770, AS/NZS 4771  
**Telecommunications:** AS/ACIF S002:05, AS/ACIF S003:06, AS/ACIF S004:06, AS/ACIF S006:01, AS/ACIF S016:01, AS/ACIF S031:01, AS/ACIF S038:01, AS/ACIF S040:01, AS/ACIF S041:05, AS/ACIF S043.2:06, AS/NZS 60950.1

You may submit test data to ACMA to verify that the equipment to be imported into Australia satisfies the applicable requirements. The designation of your organization will remain in force as long as its accreditation for the designated scope remains valid and comply with the designation requirements. Recognized CABs are listed on the NIST website at <http://ts.nist.gov/mra>. Please contact Ms. Ramona Saar, at (301) 975-5521 or [ramona.saar@nist.gov](mailto:ramona.saar@nist.gov) if you have questions.

Sincerely,

David F. Alderman  
Group Leader, Standards Coordination and Conformity Group  
Standards Services Division

Enclosure

cc: Snell Leong, Siemic, Inc.; Ramona Saar, NIST



**SIEMIC ACREDITATION DETAILS: Korea CAB ID: US0160**



방송통신위원회 전파연구소  
Radio Research Agency

**KOREA COMMUNICATIONS COMMISSION**  
**REPUBLIC OF KOREA**  
1, Wonhyoro-3ga, Yongsan-gu, Seoul, 140-848, Korea

**Radio Research Agency**

Tel: +82 2 710 6610  
Fax: +82 2 710 6619  
Homepage : www.rra.go.kr

---

KCC/RRA

14<sup>th</sup> Jan, 2011

Radio Research Agency  
Korea Communications Commission  
#1, Wonhyoro-3ga, Yongsan-gu  
Seoul Korea 140-848  
(Tel) 82-2-710-6610, (Fax) 82-2-710-6619  
Jan 14<sup>th</sup>, 2011

Mr. David F. Alderman  
 Group Leader, Standards Coordination and Conformity Group  
 National Institute of Standards and Technology  
 100 Bureau Drive, Stop 2100  
 Gaithersburg, Maryland 20899-2100, USA

Dear Mr. David F. Alderman:

This is to confirm the recognition by Radio Research Agency of

**SIEMIC, Inc. (US0160)**

as an accredited Conformity Assessment Body (CAB) under the terms of Phase I of the APEC TEL MRA. The scope for which this laboratory has been recognized is given below.

Coverage	Standards	Date of Recognition
Current Scope	EMI : KCC Notice 2008-39, RRL Notice 2008-3 and KN22 EMS : KCC Notice 2008-38, RRL Notice 2008-4, KN24, KN 61000 -4-2, -4-3, -4-4, -4-5, -4-6, -4-8, -4-11 Radio : RRL Notice 2008-26, RRL Notice 2008-2, RRL Notice 2008-10, RRL Notice 2007-49, RRL Notice 2007-20, RRL Notice 2007-11, RRL Notice 2007-80, RRL Notice 2004-68 Telecom : President Notice 20664, RRL Notice 2007-30, 2008-7(1,3,4,5,6)	Jan 14 <sup>th</sup> , 2011
Updated Scope	SAR : RRA Notice 2008-16, RRA Notice 2008-18, KCC Notice 2009-27	

This recognition is contingent upon the maintenance of this CAB's accreditation status and is limited to the standards listed above.

If you have any inquiries about this recognition, please contact to Certification Division of Radio Research Agency with above address and telephone numbers.

Best Regards,

Ahn, Kun-Young  
Director Certification Division



Enclosure

cc: Ramona Saar – NIST,  
JungMin Park - RRA



**SIEMIC ACREDITATION DETAILS: Taiwan BSMI Accreditation No. SL2-IN-E-1130R**



**UNITED STATES DEPARTMENT OF COMMERCE**  
National Institute of Standards and Technology  
Gaithersburg, Maryland 20899

May 3, 2006

Mr. Leslie Bai  
SIEMIC Laboratories  
2206 Ringwood Avenue  
San Jose, CA 95131

Dear Mr. Bai:

I am pleased to inform you that your laboratory has been recognized by the Chinese Taipei's Bureau of Standards, Metrology, and Inspection (BSMI) under the Asia Pacific Economic Cooperation (APEC) Mutual Recognition Arrangement (MRA). Your laboratory is now designated to act as a Conformity Assessment Body (CAB) under Appendix B, **Phase I** Procedures, of the APEC Tel MRA. You may submit test data to BSMI to verify that the equipment to be imported into Chinese Taipei satisfies the applicable requirements. The designation of your organization will remain in force as long as its accreditation for the designated scope remains valid and comply with the designation requirements. The pertinent designation information is as follows:

- BSMI number: **SL2-IN-E-1130R** (Must be applied to the test reports)
- U.S Identification No: **US0160**
- Scope of Designation: **CNS 13438**
- Authorized signatory: **Mr. Leslie Bai**

The names of all recognized CABs will be posted on the NIST website at <http://ts.nist.gov/mra>. If you have any questions, please contact Mr. Dhillon at 301-975-5521. We appreciate your continued interest in our international conformity assessment activities.

Sincerely,

David F. Alderman  
Group Leader, Standards Coordination and Conformity Group

cc: Jogindar Dhillon



**SIEMIC ACREDITATION DETAILS: Taiwan NCC CAB ID: US0160**

  
**UNITED STATES DEPARTMENT OF COMMERCE**  
**National Institute of Standards and Technology**  
Gaithersburg, Maryland 20899

March 16, 2009

Mr. Leslie Bai  
SIEMIC, Inc.  
2206 Ringwood Avenue  
San Jose, CA 95131

Dear Mr. Bai:

NIST is pleased to inform you that your laboratory has been recognized by the National Communications Commission (NCC) for the requested scope expansion under the Asia Pacific Economic Cooperation for Telecommunications Equipment Mutual Recognition Arrangement (APEC Tel MRA). Your laboratory is designated to act as a Conformity Assessment Body (CAB) under Appendix B, **Phase I** Procedures, of the APEC Tel MRA. The pertinent information about your laboratory's designation is as follows:

CAB Name: SIEMIC, Inc.  
Physical Location: 2206 Ringwood Avenue, San Jose, CA 95131  
Identification No.: US0160  
Current Scope: LP0002, PSTN01, ADSL01, ID0002, IS6100 and CNS 14336  
Additional Scope: PLMN07

You may submit test data to NCC to verify that the equipment to be imported into China satisfies the applicable requirements. The designation of your organization will remain in force as long as its accreditation for the designated scope remains valid and comply with the designation requirements.

Recognized CABs are listed on the NIST website at <http://ts.nist.gov/mra>. If you have any questions please contact Ramona Saar at (301) 975-5521 or [ramona.saar@nist.gov](mailto:ramona.saar@nist.gov).

Sincerely,



David F. Alderman  
Group Leader, Standards Coordination and Conformity Group  
Standards Services Division

Enclosure

cc: Ramona Saar

**NIST**



**SIEMIC, Inc.**

Accessing global markets

Title: RF Test Report of HID Global Corporation  
Model : 3500  
To: FCC 15.225 2010, RSS-210 Issue 8

Serial# SL11021502-HID-005\_veriCLASS (FCC,IC)  
Issue Date March 17 2011  
Page 47 of 53  
www.siemic.com

**SIEMIC ACREDITATION DETAILS: Mexico NOM Recognition**



CAMARA NACIONAL  
DE LA INDUSTRIA  
ELECTRONICA, DE  
TELECOMUNICACIONES  
E INFORMATICA

## Laboratorio Valentín V. Rivero

México D.F. a 16 de octubre de 2006.

**LESLIE BAI  
DIRECTOR OF CERTIFICATION  
SIEMIC LABORATORIES, INC.  
ACCESSING GLOBAL MARKETS  
P R E S E N T E**

En contestación a su escrito de fecha 5 de septiembre del año en curso, le comento que estamos muy interesados en su intención de firmar un Acuerdo de Reconocimiento Mutuo, para lo cual adjunto a este escrito encontrara el Acuerdo en idioma inglés y español prellenado de los cuales le pido sea revisado y en su caso corregido, para que si este de acuerdo poder firmarlo para mandarlo con las autoridades Mexicanas para su visto bueno y así poder ejercer dicho acuerdo.

Aprovecho este escrito para mencionarle que nuestro intermediario gestor será la empresa Isabel de México, S. A. de C. V., empresa que ha colaborado durante mucho tiempo con nosotros en lo relacionado a la evaluación de la conformidad y que cuenta con amplia experiencia en la gestión de la certificación de cumplimiento con Normas Oficiales Mexicanas de producto en México.

Me despido de usted enviándole un cordial saludo y esperando sus comentarios al Acuerdo que nos ocupa.

Atentamente:

  
**Ing. Faustino Gómez González  
Gerente Técnico del Laboratorio de  
CANIETI.**

Culacán 71  
Hidrógeno Condosa  
06100 México, D.F.  
Tel. 5264-0808 con 12 líneas  
Fax 5264 0496  
www.canieti.org

**SIEMIC ACREDITATION DETAILS: Hong Kong OFTA CAB ID : US0160**



**UNITED STATES DEPARTMENT OF COMMERCE**  
**National Institute of Standards and Technology**  
Gaithersburg, Maryland 20899

December 8, 2008

Mr. Leslie Bai  
SIEMIC, Inc.  
2206 Ringwood Avenue  
San Jose, CA 95131

Dear Mr. Bai:

NIST is pleased to inform you that your laboratory has been recognized by the Office of the Telecommunications Authority (OFTA) under the Asia Pacific Economic Cooperation for Telecommunications Equipment Mutual Recognition Arrangement (APEC Tel MRA). Your laboratory is now designated to act as a Conformity Assessment Body (CAB) under Appendix B, **Phase I** Procedures, of the APEC Tel MRA. The pertinent information about your laboratory's designation is as follows:

CAB Name: SIEMIC, Inc.  
Physical Location: 2206 Ringwood Avenue, San Jose, California 95131 USA  
Identification No.: US0160  
Recognized Scope: **Radio:** HKTA 1002, 1007, 1008, 1010, 1015, 1016, 1020, 1022, 1026, 1027, 1029, 1030, 1031, 1032, 1033, 1034, 1035, 1036, 1037, 1039, 1041, 1042, 1043, 1044, 1046, 1047, 1048, 1049, 1051  
**Telecom:** HKTA 2011, 2012, 2013, 2014, 2017, 2018, 2022, 2024, 2026, 2027, 2028, 2029, 2030, 2031, 2032, 2033

You may submit test data to OFTA to verify that the equipment to be imported into Hong Kong satisfies the applicable requirements. The designation of your organization will remain in force as long as its accreditation for the designated scope remains valid and comply with the designation requirements.

Recognized CABs are listed on the NIST website at <http://ts.nist.gov/mra>. If you have any questions please contact Ramona Saar at (301) 975-5521 or [ramona.saar@nist.gov](mailto:ramona.saar@nist.gov).

Sincerely,

David F. Alderman  
Group Leader, Standards Coordination and Conformity Group  
Standards Services Division

Enclosure

cc: Ramona Saar



**SIEMIC ACREDITATION DETAILS: Australia ACMA CAB ID: US0160**



**UNITED STATES DEPARTMENT OF COMMERCE**  
**National Institute of Standards and Technology**  
Gaithersburg, Maryland 20899

November 20, 2008

Mr. Leslie Bai  
SIEMIC, Inc.  
2206 Ringwood Avenue  
San Jose, CA 95131

Dear Mr. Bai:

NIST is pleased to inform you that your laboratory has been recognized by the Australian Communications and Media Authority (ACMA) under the Asia Pacific Economic Cooperation for Telecommunications Equipment Mutual Recognition Arrangement (APEC Tel MRA). Your laboratory is now designated to act as a Conformity Assessment Body (CAB) under Appendix B, **Phase I** Procedures, of the APEC Tel MRA. The pertinent information about your laboratory's designation is as follows:

CAB Name: Siemic, Inc.  
Physical Location: 2206 Ringwood Avenue, San Jose, CA 95131  
Identification No.: US0160  
Recognized Scope: EMC: AS/NZS 4251.1 (until 5/31/2009), AS/NZS 4251.2 (until 5/31/2009), AS/NZS CISPR 11, AS/NZS CISPR 14.1, AS/NZS CISPR 22, AS/NZS 61000.6.3, AS/NZS 61000.6.4  
Radiocommunications: AS/NZS 4281, AS/NZS 4268, AS/NZS 4280.1, AS/NZS 4280.2, AS/NZS 4295, AS/NZS 4582, AS/NZS 4583, AS/NZS 4769.1, AS/NZS 4769.2, AS/NZS 4770, AS/NZS 4771  
Telecommunications: AS/ACIF S002:05, AS/ACIF S003:06, AS/ACIF S004:06, AS/ACIF S006:01, AS/ACIF S016:01, AS/ACIF S031:01, AS/ACIF S038:01, AS/ACIF S040:01, AS/ACIF S041:05, AS/ACIF S043.2:06, AS/NZS 60950.1

You may submit test data to ACMA to verify that the equipment to be imported into Australia satisfies the applicable requirements. The designation of your organization will remain in force as long as its accreditation for the designated scope remains valid and comply with the designation requirements. Recognized CABs are listed on the NIST website at <http://ts.nist.gov/mra>. Please contact Ms. Ramona Saar, at (301) 975-5521 or [ramona.saar@nist.gov](mailto:ramona.saar@nist.gov) if you have questions.

Sincerely,

David F. Alderman  
Group Leader, Standards Coordination and Conformity Group  
Standards Services Division

Enclosure

cc: Snell Leong, Siemic, Inc.; Ramona Saar, NIST

**SIEMIC ACREDITATION DETAILS: Australia NATA Recognition**



Leslie Bai  
SIEMIC, Inc.  
2206 Ringwood Avenue  
San Jose, CA 95131

November 4, 2008

Under Australian government legislation, the Australian Communications and Media Authority (ACMA) has determined the National Association of Testing Authorities, Australia (NATA) as an accreditation body as per Section 409(1) of the Telecommunications Act 1997 (Cth). Pursuant to Section 409(2) of the Telecommunications Act 1997 (Cth), I am pleased to advise that your laboratory has been determined as a Recognised Testing Authority (RTA).

This determination has been made on the basis of your accreditation by A2LA accreditation no. 2742.01 and the Mutual Recognition Agreement between NATA and A2LA. It is effective from 11 July 2008. RTA status applies only to the following standards and is contingent upon their continued inclusion in your laboratory's scope of accreditation.

**AS/ACIF S002, AS/ACIF S003, AS/ACIF S004,  
AS/ACIF S006, AS/ACIF S016, AS/ACIF S031,  
AS/ACIF S038, AS/ACIF S041 and  
AS/ACIF S043.2**

As an RTA, your laboratory has the following obligations:

1. the laboratory shall continue to meet all of the accreditation criteria of A2LA;
2. the authorised representative of the laboratory shall notify NATA of changes to the staff or operations of the laboratory which would affect the performance of the tests for which the laboratory has been determined;
3. compliance of equipment shall be reported on test reports bearing the A2LA logo/endorsement.

Current information on the Australian Communications and Media Authority and regulatory requirements for telecommunications products within Australia can be obtained from the ACMA's web-site at "<http://www.acma.gov.au>". Further information about NATA may be gained by visiting "<http://www.nata.asn.au>".

Please note that AS/ACIF S040 and New Zealand standards do not form part of the RTA scheme.

Your RTA listing will appear on the NATA website shortly.

Kind Regards

Chris Norton,  
Senior Scientific Officer  
Measurement Science and Technology  
National Association of Testing Authorities (NATA)  
71-73 Flemington Road  
North Melbourne Vic 3051  
Australia  
Ph: +61 3 9329 1633 Fx: +61 3 9326 5148  
E-Mail: [Christopher.Norton@nata.asn.au](mailto:Christopher.Norton@nata.asn.au)  
Internet: [www.nata.asn.au](http://www.nata.asn.au)

**SIEMIC ACREDITATION DETAILS: VCCI Radiated Test Site Registration No. R-3083**



**SIEMIC ACREDITATION DETAILS: VCCI Conducted (Main Port) Test Site Registration No. C-3421**

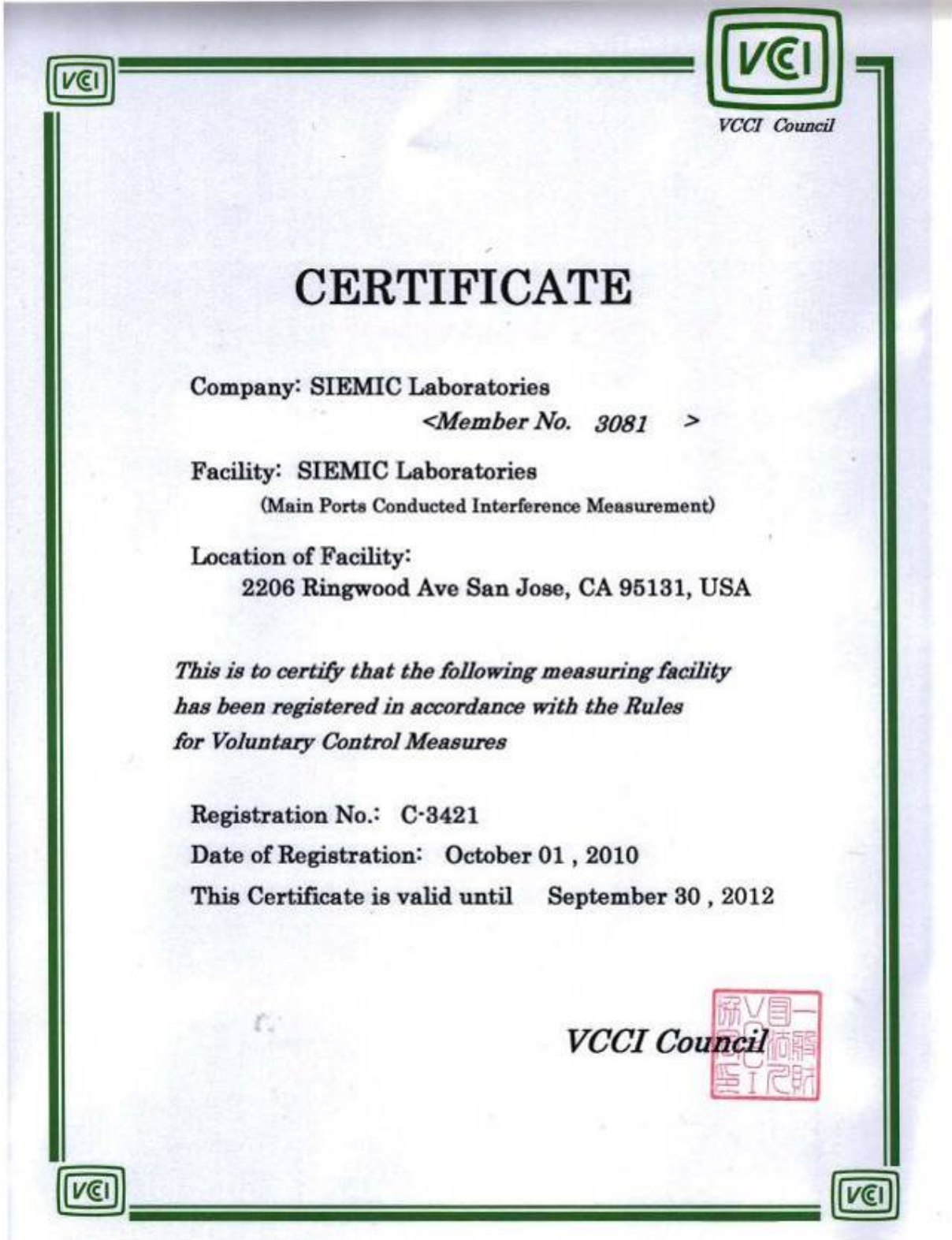

**SIEMIC ACREDITATION DETAILS: VCCI Conducted (Telecom Port) Test Site Registration No. T-1597**

