

January 8, 2020

HID Global Corporation
6533 Flying Cloud Drive
Eden Prairie, MN 55344

Dear Robert Cresswell,

Enclosed is the EMC Wireless test report for compliance testing of the HID Global Corporation, Model: 40K as tested to the requirements of Title 47 of the CFR, Ch. 1 (10-1-06 ed.), Part 15 Subpart C for Intentional Radiators.

Thank you for using the services of Eurofins MET Labs, Inc. If you have any questions regarding these results or if MET can be of further service to you, please feel free to contact me.

Sincerely yours,
EUROFINS MET LABS, INC.



Michelle Tawmging
Documentation Department

Reference: (\HID Global Corporation\EMCA104938-FCC247 SRD 40K Rev. 4)

Certificates and reports shall not be reproduced except in full, without the written permission of Eurofins MET Labs, Inc. While use of the A2LA logo in this report reflects MET accreditation under these programs, the report must not be used by the client to claim product certification, approval, or endorsement by A2LA or any agency of the Federal Government. This letter of transmittal is not a part of the attached report.

Electromagnetic Compatibility Criteria Test Report

for the

HID Global Corporation
HID Signo Reader
Model: 40K

Tested under
the FCC Certification Rules
contained in
15.247 Subpart C for Intentional Radiators

MET Report: EMCA104938-FCC247 SRD 40K Rev. 4

January 8, 2020

Prepared For:

HID Global Corporation
6533 Flying Cloud Drive
Eden Prairie, MN 55344

Prepared By:
Eurofins MET Labs, Inc.
13501 McCallen Pass,
Austin, TX 78753

Electromagnetic Compatibility Criteria Test Report

for the

HID Global Corporation
HID Signo Reader
Model: 40K

Tested under
the FCC Certification Rules
contained in
15.247 Subpart C for Intentional Radiators



Adan Arab, Project Engineer
Electromagnetic Compatibility Lab



Michelle Tawmging
Documentation Department

Engineering Statement: The measurements shown in this report were made in accordance with the procedures indicated, and the emissions from this equipment were found to be within the limits applicable. I assume full responsibility for the accuracy and completeness of these measurements, and for the qualifications of all persons taking them. It is further stated that upon the basis of the measurements made, the equipment tested is capable of operation in accordance with the requirements of the FCC Rules Part 15.247 under normal use and maintenance.

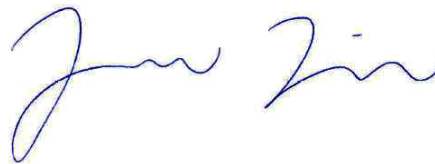

Jonathan Tavira,
Manager, Electromagnetic Compatibility Lab

Report Status Sheet

Revision	Report Date	Reason for Revision
∅	October 22, 2019	Initial Issue
1	October 24, 2019	Implemented Customer-Requested Revisions
2	October 29, 2019	Implemented Customer-Requested Revisions
3	November 13, 2019	Implemented Customer-Requested Revisions
4	January 8, 2020	Implemented TCB-Requested Revisions

Table of Contents

I.	Executive Summary	1
	A. Purpose of Test	2
	B. Executive Summary	2
II.	Equipment Configuration	3
	A. Overview.....	4
	B. References.....	5
	C. Test Site	5
	D. Measurement Uncertainty	5
	E. Description of Test Sample.....	6
	F. Equipment Configuration.....	6
	G. Support Equipment	7
	H. Ports and Cabling Information.....	7
	I. Mode of Operation.....	7
	J. Method of Monitoring EUT Operation.....	7
	K. Modifications	8
	a) Modifications to EUT.....	8
	b) Modifications to Test Standard.....	8
	L. Disposition of EUT	8
III.	Electromagnetic Compatibility Criteria for Intentional Radiators.....	9
	§ 15.203 Antenna Requirement.....	10
	§ 15.207(a) Conducted Emissions Limits.....	11
	§ 15.247(a)(a) 6 dB and 99% Bandwidth	16
	§ 15.247(b) Peak Power Output	25
	§ 15.247(d) Radiated Spurious Emissions Requirements and Band Edge	34
	§ 15.247(c) Spurious Emissions in Non-restricted Bands	81
	§ 15.247(e) Peak Power Spectral Density	100
	§ 15.247(i) RF Human Exposure.....	109
IV.	Test Equipment	111
V.	Certification & User’s Manual Information.....	113
	A. Certification Information	114
	B. Label and User’s Manual Information	118

List of Figures

Figure 1: Executive Summary of EMC Part 15.247 Compliance Testing	2
Figure 2: EUT Summary Table	4
Figure 3: References	5
Figure 4: Uncertainty Calculations Summary	5
Figure 5: Block Diagram of Test Configuration	6
Figure 6: Equipment List	6
Figure 7: Support Equipment	7
Figure 8: Ports and Cabling Information	7
Figure 9: Conducted Limits for Intentional Radiators from FCC Part 15 § 15.207(a)	11
Figure 10: Conducted Emissions Limits, Pigtail, Phase Line, Test Results	12
Figure 11: Conducted Emissions Limits, Pigtail, Phase Line, Prescan	12
Figure 12: Conducted Emissions Limits, Terminal, Neutral Line, Test Results	13
Figure 13: Conducted Emissions Limits, Terminal, Neutral Line, Prescan	13
Figure 14: Conducted Emissions Limits, Terminal, Phase Line, Test Results	14
Figure 15: Conducted Emissions Limits, Terminal, Phase Line, Prescan	14
Figure 16: Conducted Emissions Limits, Terminal, Neutral Line, Test Results	15
Figure 17: Conducted Emissions Limits, Terminal, Neutral Line, Prescan	15
Figure 18: Block Diagram, Occupied Bandwidth Test Setup	16
Figure 19: 6 dB Bandwidth, Pigtail, Test Results	17
Figure 20: 6 dB Bandwidth, Pigtail, 2402 MHz, 1 Mbps, 759.963 kHz	18
Figure 21: 6 dB Bandwidth, Pigtail, 2402 MHz, 2 Mbps, 1.309 MHz	18
Figure 22: 6 dB Bandwidth, Pigtail, 2442 MHz, 1 Mbps, 788.955 kHz	19
Figure 23: 6 dB Bandwidth, Pigtail, 2442 MHz, 2 Mbps, 1.326 MHz	19
Figure 24: 6 dB Bandwidth, Pigtail, 2480 MHz, 1 Mbps, 743.060 kHz	20
Figure 25: 6 dB Bandwidth, Pigtail, 2480 MHz, 2 Mbps, 1.326 MHz	20
Figure 26: 6 dB Bandwidth, 40K Terminal, Test Results	21
Figure 27: 6 dB Bandwidth, Terminal, 2402 MHz, 1 Mbps, 740.764 kHz	22
Figure 28: 6 dB Bandwidth, Terminal, 2402 MHz, 2 Mbps, 1.324 MHz	22
Figure 29: 6 dB Bandwidth, Terminal, 2442 MHz, 1 Mbps, 773.330 kHz	23
Figure 30: 6 dB Bandwidth, Terminal, 2442 MHz, 2 Mbps, 1.385 MHz	23
Figure 31: 6 dB Bandwidth, Terminal, 2480 MHz, 1 Mbps, 759.417 kHz	24
Figure 32: 6 dB Bandwidth, Terminal, 2480 MHz, 2 Mbps, 1.201 MHz	24
Figure 33: Output Power Requirements from §15.247(b)	25
Figure 34: Block Diagram, Peak Conducted Output Power Test Setup	25
Figure 35: Peak Power Output, Pigtail, Test Results	26
Figure 36: Peak Power Output, Pigtail, 2402 MHz, 1 Mbps, 0.05 dBm	27
Figure 37: Peak Power Output, Pigtail, 2402 MHz, 2 Mbps, 0.94 dBm	27
Figure 38: Peak Power Output, Pigtail, 2442 MHz, 1 Mbps, -0.17 dBm	28
Figure 39: Peak Power Output, Pigtail, 2442 MHz, 2 Mbps, 0.71 dBm	28
Figure 40: Peak Power Output, Pigtail, 2480 MHz, 1 Mbps, -0.47 dBm	29
Figure 41: Peak Power Output, Pigtail, 2480 MHz, 2 Mbps, 0.41 dBm	29
Figure 42: Peak Power Output, Terminal, Test Results	30
Figure 43: Peak Power Output, Terminal, 2402 MHz, 1 Mbps, 0.30 dBm	30
Figure 44: Peak Power Output, Terminal, 2402 MHz, 2 Mbps, 1.23 dBm	31
Figure 45: Peak Power Output, Terminal, 2442 MHz, 1 Mbps, 0.09 dBm	31
Figure 46: Peak Power Output, Terminal, 2442 MHz, 2 Mbps, 0.99 dBm	32
Figure 47: Peak Power Output, Terminal, 2480 MHz, 1 Mbps, -0.15 dBm	32
Figure 48: Peak Power Output, Terminal, 2480 MHz, 2 Mbps, 0.75 dBm	33
Figure 49: Restricted Bands of Operation	34

Figure 50: Radiated Emissions Limits Calculated from FCC Part 15, § 15.209 (a)..... 35

Figure 51: Radiated Emissions Test Setup 35

Figure 52: Radiated Spurious Emissions, Pigtail, 2402 MHz, 30 MHz - 1000 MHz, Horizontal 37

Figure 53: Radiated Spurious Emissions, Pigtail, 2402 MHz, 30 MHz - 1000 MHz, Vertical 38

Figure 54: Radiated Spurious Emissions, Pigtail, 2402 MHz, 30 MHz - 1000 MHz 38

Figure 55: Radiated Spurious Emissions, Pigtail, 2402 MHz, 1 GHz - 18 GHz, Average, Horizontal..... 39

Figure 56: Radiated Spurious Emissions, Pigtail, 2402 MHz, 1 GHz - 18 GHz, Average, Vertical 40

Figure 57: Radiated Spurious Emissions, Pigtail, 2402 MHz, 1 GHz - 18 GHz, Test Results 40

Figure 58: Radiated Spurious Emissions, Pigtail, 2402 MHz, 1 GHz - 18 GHz, Peak, Horizontal 41

Figure 59: Radiated Spurious Emissions, Pigtail, 2402 MHz, 1 GHz - 18 GHz, Peak, Vertical..... 41

Figure 60: Radiated Spurious Emissions, Pigtail, 2402 MHz, 18 GHz - 25 GHz, Average, Horizontal..... 42

Figure 61: Radiated Spurious Emissions, Pigtail, 2402 MHz, 18 GHz - 25 GHz, Average, Vertical 42

Figure 62: Radiated Spurious Emissions, Pigtail, 2402 MHz, 18 GHz - 25 GHz, Peak, Horizontal 43

Figure 63: Radiated Spurious Emissions, Pigtail, 2402 MHz, 18 GHz - 25 GHz, Peak, Vertical 43

Figure 64: Radiated Spurious Emissions, Pigtail, 2442 MHz, 30 MHz - 1000 MHz, Horizontal 44

Figure 65: Radiated Spurious Emissions, Pigtail, 2442 MHz, 30 MHz - 1000 MHz, Vertical 45

Figure 66: Radiated Spurious Emissions, Pigtail, 2442 MHz, 30 MHz - 1000 MHz 45

Figure 67: Radiated Spurious Emissions, Pigtail, 2442 MHz, 1 GHz - 18 GHz, Average, Horizontal..... 46

Figure 69: Radiated Spurious Emissions, Pigtail, 2442 MHz, 1 GHz - 18 GHz, Test Results 47

Figure 70: Radiated Spurious Emissions, Pigtail, 2442 MHz, 1 GHz - 18 GHz, Peak, Horizontal 48

Figure 72: Radiated Spurious Emissions, Pigtail, 2480 MHz, 30 MHz - 1000 MHz, Horizontal 49

Figure 74: Radiated Spurious Emissions, Pigtail, 2480 MHz, 30 MHz - 1000 MHz 50

Figure 75: Radiated Spurious Emissions, Pigtail, 2480 MHz, 1 GHz - 18 GHz, Average, Horizontal..... 51

Figure 76: Radiated Spurious Emissions, Pigtail, 2480 MHz, 1 GHz - 18 GHz, Average, Vertical 52

Figure 77: Radiated Spurious Emissions, Pigtail, 2480 MHz, 1 GHz - 18 GHz, Test Results 52

Figure 78: Radiated Spurious Emissions, Pigtail, 2480 MHz, 1 GHz - 18 GHz, Peak, Horizontal 53

Figure 79: Radiated Spurious Emissions, Pigtail, 2480 MHz, 1 GHz - 18 GHz, Peak, Vertical..... 53

Figure 80: Radiated Spurious Emissions, Terminal, 2402 MHz, 30 MHz - 1000 MHz, Horizontal..... 54

Figure 81: Radiated Spurious Emissions, Terminal, 2402 MHz, 30 MHz - 1000 MHz, Vertical 55

Figure 82: Radiated Spurious Emissions, Terminal, 2402 MHz, 30 MHz - 1000 MHz 55

Figure 83: Radiated Spurious Emissions, Terminal, 2402 MHz, 1 GHz - 18 GHz, Average, Horizontal..... 56

Figure 84: Radiated Spurious Emissions, Terminal, 2402 MHz, 1 GHz - 18 GHz, Average, Vertical..... 57

Figure 85: Radiated Spurious Emissions, Terminal, 2402 MHz, 1 GHz - 18 GHz, Test Results 57

Figure 86: Radiated Spurious Emissions, Terminal, 2402 MHz, 1 GHz - 18 GHz, Peak, Horizontal 58

Figure 87: Radiated Spurious Emissions, Terminal, 2402 MHz, 1 GHz - 18 GHz, Peak, Vertical 58

Figure 88: Radiated Spurious Emissions, Terminal, 2402 MHz, 18 GHz - 25 GHz, Average, Horizontal..... 59

Figure 89: Radiated Spurious Emissions, Terminal, 2402 MHz, 18 GHz - 25 GHz, Average, Vertical..... 59

Figure 90: Radiated Spurious Emissions, Terminal, 2402 MHz, 18 GHz - 25 GHz, Peak, Horizontal 60

Figure 91: Radiated Spurious Emissions, Terminal, 2402 MHz, 18 GHz - 25 GHz, Peak, Vertical 60

Figure 92: Radiated Spurious Emissions, Terminal, 2442 MHz, 30 MHz - 1000 MHz, Horizontal..... 61

Figure 93: Radiated Spurious Emissions, Terminal, 2442 MHz, 30 MHz - 1000 MHz, Vertical 62

Figure 94: Radiated Spurious Emissions, Terminal, 2442 MHz, 30 MHz - 1000 MHz 62

Figure 95: Radiated Spurious Emissions, Terminal, 2442 MHz, 1 GHz - 18 GHz, Average, Horizontal..... 63

Figure 96: Radiated Spurious Emissions, Terminal, 2442 MHz, 1 GHz - 18 GHz, Average, Vertical..... 64

Figure 97: Radiated Spurious Emissions, Terminal, 2442 MHz, 1 GHz - 18 GHz, Test Results 64

Figure 98: Radiated Spurious Emissions, Terminal, 2442 MHz, 1 GHz - 18 GHz, Peak, Horizontal 65

Figure 99: Radiated Spurious Emissions, Terminal, 2442 MHz, 1 GHz - 18 GHz, Peak, Vertical 65

Figure 100: Radiated Spurious Emissions, Terminal, 2480 MHz, 30 MHz - 1000 MHz, Horizontal..... 66

Figure 101: Radiated Spurious Emissions, Terminal, 2480 MHz, 30 MHz - 1000 MHz, Vertical 67

Figure 102: Radiated Spurious Emissions, Terminal, 2480 MHz, 30 MHz - 1000 MHz 67

Figure 103: Radiated Spurious Emissions, Terminal, 2480 MHz, 1 GHz - 18 GHz, Average, Horizontal..... 68

Figure 104: Radiated Spurious Emissions, Terminal, 2480 MHz, 1 GHz - 18 GHz, Average, Vertical..... 69

Figure 105: Radiated Spurious Emissions, Terminal, 2480 MHz, 1 GHz - 18 GHz, Test Results..... 69

Figure 106: Radiated Spurious Emissions, Terminal, 2480 MHz, 1 GHz - 18 GHz, Peak, Horizontal 70

Figure 107: Radiated Spurious Emissions, Terminal, 2480 MHz, 1 GHz - 18 GHz, Peak, Vertical 70

Figure 108: Radiated Band Edge, Pigtail, 2402 MHz, Average, Horizontal 71

Figure 109: Radiated Band Edge, Pigtail, 2402 MHz, Average, Vertical 72

Figure 110: Radiated Band Edge, Pigtail, 2402 MHz, Peak, Horizontal..... 72

Figure 111: Radiated Band Edge, Pigtail, 2402 MHz, Peak, Vertical..... 73

Figure 112: Radiated Band Edge, Pigtail, 2480 MHz, Average, Horizontal 73

Figure 113: Radiated Band Edge, Pigtail, 2480 MHz, Average, Vertical 74

Figure 114: Radiated Band Edge, Pigtail, 2480 MHz, Peak, Horizontal..... 74

Figure 115: Radiated Band Edge, Pigtail, 2480 MHz, Peak, Vertical..... 75

Figure 116: Radiated Band Edge, Terminal, 2402 MHz, Average, Horizontal..... 76

Figure 117: Radiated Band Edge, Terminal, 2402 MHz, Average, Vertical 77

Figure 118: Radiated Band Edge, Terminal, 2402 MHz, Peak, Horizontal 77

Figure 119: Radiated Band Edge, Terminal, 2402 MHz, Peak, Vertical..... 78

Figure 120: Radiated Band Edge, Terminal, 2480 MHz, Average, Horizontal..... 78

Figure 121: Radiated Band Edge, Terminal, 2480 MHz, Average, Vertical 79

Figure 122: Radiated Band Edge, Terminal, 2480 MHz, Peak, Horizontal 79

Figure 123: Radiated Band Edge, Terminal, 2480 MHz, Peak, Vertical..... 80

Figure 124: Block Diagram, Conducted Spurious Emissions Test Setup 81

Figure 125: Conducted Spurious Emissions, Pigtail, 2402 MHz, 1 Mbps, 30 MHz - 1000 MHz..... 82

Figure 126: Conducted Spurious Emissions, Pigtail, 2402 MHz, 1 Mbps, 1 GHz - 25 GHz 83

Figure 127: Conducted Spurious Emissions, Pigtail, 2402 MHz, 2 Mbps, 30 MHz - 1000 MHz..... 83

Figure 128: Conducted Spurious Emissions, Pigtail, 2402 MHz, 2 Mbps, 1 GHz - 25 GHz 84

Figure 129: Conducted Spurious Emissions, Pigtail, 2442 MHz, 1 Mbps, 30 MHz - 1000 MHz..... 84

Figure 130: Conducted Spurious Emissions, Pigtail, 2442 MHz, 1 Mbps, 1 GHz - 25 GHz 85

Figure 131: Conducted Spurious Emissions, Pigtail, 2442 MHz, 2 Mbps, 30 MHz - 1000 MHz..... 85

Figure 132: Conducted Spurious Emissions, Pigtail, 2442 MHz, 2 Mbps, 1 GHz - 25 GHz 86

Figure 133: Conducted Spurious Emissions, Pigtail, 2480 MHz, 1 Mbps, 30 MHz - 1000 MHz..... 86

Figure 134: Conducted Spurious Emissions, Pigtail, 2480 MHz, 1 Mbps, 1 GHz - 25 GHz 87

Figure 135: Conducted Spurious Emissions, Pigtail, 2480 MHz, 2 Mbps, 30 MHz - 1000 MHz..... 87

Figure 136: Conducted Spurious Emissions, Pigtail, 2480 MHz, 2 Mbps, 1 GHz - 25 GHz 88

Figure 137: Conducted Band Edge, Pigtail, 2402 MHz, 1 Mbps 88

Figure 138: Conducted Band Edge, Pigtail, 2402 MHz, 2 Mbps 89

Figure 139: Conducted Band Edge, Pigtail, 2480 MHz, 1 Mbps 89

Figure 140: Conducted Band Edge, Pigtail, 2480 MHz, 2 Mbps 90

Figure 141: Conducted Spurious Emissions, Terminal, 2402 MHz, 1 Mbps, 30 MHz - 1000 MHz..... 91

Figure 142: Conducted Spurious Emissions, Terminal, 2402 MHz, 2 Mbps, 1 GHz - 25 GHz..... 92

Figure 143: Conducted Spurious Emissions, Terminal, 2402 MHz, 2 Mbps, 30 MHz - 1000 MHz..... 92

Figure 144: Conducted Spurious Emissions, Terminal, 2402 MHz, 2 Mbps, 1 GHz - 25 GHz 93

Figure 145: Conducted Spurious Emissions, Terminal, 2442 MHz, 1 Mbps, 30 MHz - 1000 MHz..... 93

Figure 146: Conducted Spurious Emissions, Terminal, 2442 MHz, 1 Mbps, 1 GHz - 25 GHz 94

Figure 147: Conducted Spurious Emissions, Terminal, 2442 MHz, 2 Mbps, 30 MHz - 1000 MHz..... 94

Figure 148: Conducted Spurious Emissions, Terminal, 2442 MHz, 2 Mbps, 1 GHz - 25 GHz 95

Figure 149: Conducted Spurious Emissions, Terminal, 2480 MHz, 1 Mbps, 30 MHz - 1000 MHz..... 95

Figure 150: Conducted Spurious Emissions, Terminal, 2480 MHz, 1 Mbps, 1 GHz - 25 GHz 96

Figure 151: Conducted Spurious Emissions, Terminal, 2480 MHz, 2 Mbps, 30 MHz - 1000 MHz..... 96

Figure 152: Conducted Spurious Emissions, Terminal, 2480 MHz, 2 Mbps, 1 GHz - 25 GHz 97

Figure 153: Conducted Band Edge, Terminal, 2402 MHz, 1 Mbps 97

Figure 154: Conducted Band Edge, Terminal, 2402 MHz, 2 Mbps 98

Figure 155: Conducted Band Edge, Terminal, 2480 MHz, 1 Mbps	98
Figure 156: Conducted Band Edge, Terminal, 2480 MHz, 2 Mbps	99
Figure 157: Block Diagram, Power Spectral Density Test Setup.....	100
Figure 158: Peak Power Spectral Density, Pigtail, Test Results	101
Figure 159: Peak Power Spectral Density, Pigtail, 2402 MHz, 1 Mbps, -1.755 dBm.....	102
Figure 160: Peak Power Spectral Density, Pigtail, 2402 MHz, 2 Mbps, -2.236 dBm.....	102
Figure 161: Peak Power Spectral Density, Pigtail, 2442 MHz, 1 Mbps, -1.699 dBm.....	103
Figure 162: Peak Power Spectral Density, Pigtail, 2442 MHz, 2 Mbps, -2.321 dBm.....	103
Figure 163: Peak Power Spectral Density, Pigtail, 2480 MHz, 1 Mbps, -2.115 dBm.....	104
Figure 164: Peak Power Spectral Density, Pigtail, 2480 MHz, 2 Mbps, -3.528 dBm.....	104
Figure 165: Peak Power Spectral Density, Terminal, Test Results	105
Figure 166: Peak Power Spectral Density, Terminal, 2402 MHz, 1 Mbps, -1.624 dBm.....	106
Figure 167: Peak Power Spectral Density, Terminal, 2402 MHz, 2 Mbps, -2.543 dBm.....	106
Figure 168: Peak Power Spectral Density, Terminal, 2442 MHz, 1 Mbps, -2.288 dBm.....	107
Figure 169: Peak Power Spectral Density, Terminal, 2442 MHz, 2 Mbps, -2.843 dBm.....	107
Figure 170: Peak Power Spectral Density, Terminal, 2480 MHz, 1 Mbps, -2.222 dBm.....	108
Figure 171: Peak Power Spectral Density, Terminal, 2480 MHz, 2 Mbps, -2.609 dBm.....	108
Figure 172: RF Human Exposure, Pigtail, Test Results	109
Figure 173: RF Human Exposure, Terminal, Test Results.....	110
Figure 174: Test Equipment List.....	112

List of Terms and Abbreviations

AC	Alternating Current
ACF	Antenna Correction Factor
Cal	Calibration
<i>d</i>	Measurement Distance
dB	Decibels
dBμA	Decibels above one microamp
dBμV	Decibels above one microvolt
dBμA/m	Decibels above one microamp per meter
dBμV/m	Decibels above one microvolt per meter
DC	Direct Current
E	Electric Field
DSL	Digital Subscriber Line
ESD	Electrostatic Discharge
EUT	Equipment Under Test
<i>f</i>	Frequency
FCC	Federal Communications Commission
GRP	Ground Reference Plane
H	Magnetic Field
HCP	Horizontal Coupling Plane
Hz	Hertz
IEC	International Electrotechnical Commission
kHz	kilohertz
kPa	kilopascal
kV	kilovolt
LISN	Line Impedance Stabilization Network
MHz	Megahertz
μH	microhenry
μ	microfarad
μs	microseconds
NEBS	Network Equipment-Building System
PRF	Pulse Repetition Frequency
RF	Radio Frequency
RMS	Root-Mean-Square
TWT	Traveling Wave Tube
V/m	Volts per meter
VCP	Vertical Coupling Plane

I. Executive Summary

A. Purpose of Test

An EMC evaluation was performed to determine compliance of the HID Global Corporation Model: 40K, with the requirements of Part 15, §15.247. All references are to the most current version of Title 47 of the Code of Federal Regulations in effect. In accordance with §2.1033, the following data is presented in support of the Certification of the Model: 40K. HID Global Corporation should retain a copy of this document which should be kept on file for at least two years after the manufacturing of the Model: 40K, has been **permanently** discontinued.

B. Executive Summary

The following tests were conducted on a sample of the equipment for the purpose of demonstrating compliance with Part 15, §15.247, in accordance with HID Global Corporation, quote number HID000518. All tests were conducted using measurement procedure ANSI C63.10-2013.

FCC Reference 47 CFR Part 15.247:2005	Description	Compliance Model: 40K Pigtail	Compliance Model: 40K Terminal
Title 47 of the CFR, Part 15 §15.203	Antenna Requirement	Compliant	Compliant
Title 47 of the CFR, Part 15 §15.207(a)	Conducted Emission Limits	Compliant	Compliant
Title 47 of the CFR, Part 15 §15.247(a)(2)	6dB Occupied Bandwidth	Compliant	Compliant
Title 47 of the CFR, Part 15 §15.247(b)	Peak Power Output	Compliant	Compliant
Title 47 of the CFR, Part 15 §15.247(c)	Spurious Emissions in Non-restricted Bands	Compliant	Compliant
Title 47 of the CFR, Part 15 §15.247(d); §15.209; §15.205	Radiated Spurious Emissions Requirements	Compliant	Compliant
Title 47 of the CFR, Part 15; §15.247(e)	Peak Power Spectral Density	Compliant	Compliant
Title 47 of the CFR, Part 15 §15.247(i)	RF Human Exposure, SAR Exclusion	Compliant	Compliant

Figure 1: Executive Summary of EMC Part 15.247 Compliance Testing

II. Equipment Configuration

A. Overview

Eurofins MET Labs, Inc. was contracted by HID Global Corporation to perform testing on the Model: 40K, under HID Global Corporation’s quote number HID000518.

This document describes the test setups, test methods, required test equipment, and the test limit criteria used to perform compliance testing of the HID Global Corporation, Model: 40K.

The results obtained relate only to the item(s) tested.

Models Tested:	40K Pigtail and Terminal	
Models Covered:	40K	
EUT Specifications:	Primary Power: 12 VDC	
	FCC ID: JQ6-SIGNO40K	
	Type of Modulations:	GFSK
	Equipment Code:	DTS
	Peak RF Output Power:	1.23 dBm
	EUT Frequency Ranges:	2400-2483.5 MHz
	Transmit Speeds:	1 Mbps, 2 Mbps
	Antenna Type:	PCB Patch
	Antenna Gain:	-1.7 dBi
	Firmware Version:	R9.1.0.19
Analysis:	The results obtained relate only to the item(s) tested.	
Environmental Test Conditions:	Temperature: 15-35° C	
	Relative Humidity: 30-60%	
	Barometric Pressure: 860-1060 mbar	
Evaluated by:	Jonathan Tavira and Adan Arab	
Report Date:	January 8, 2020	

Figure 2: EUT Summary Table

B. References

CFR 47, Part 15, Subpart C	Federal Communication Commission, Code of Federal Regulations, Title 47, Part 15: General Rules and Regulations, Allocation, Assignment, and Use of Radio Frequencies
ANSI C63.4:2014	Methods and Measurements of Radio-Noise Emissions from Low-Voltage Electrical And Electronic Equipment in the Range of 9 kHz to 40 GHz
ISO/IEC 17025:2017	General Requirements for the Competence of Testing and Calibration Laboratories
ANSI C63.10-2013	American National Standard for Testing Unlicensed Wireless Devices
KDB 558074 D01 V05r02	Guidance For Performing Compliance Measurements On Digital Transmission Systems (DTS) Operating Under Section 15.247

Figure 3: References

C. Test Site

All testing was performed at Eurofins MET Labs, Inc., 13501 McCallen Pass, Austin, TX 78753. All equipment used in making physical determinations is accurate and bears recent traceability to the National Institute of Standards and Technology.

Radiated Emissions measurements were performed in a 3 meter semi-anechoic chamber (equivalent to an Open Area Test Site). In accordance with §2.948(a)(3), a complete site description is contained at MET Laboratories.

D. Measurement Uncertainty

Test Method	Typical Expanded Uncertainty	K	Confidence Level
RF Frequencies	±4.52 Hz	2	95%
RF Power Conducted Emissions	±2.32 dB	2	95%
RF Power Conducted Spurious Emissions	±2.25 dB	2	95%
RF Power Radiated Emissions	±3.01 dB	2	95%

Figure 4: Uncertainty Calculations Summary

E. Description of Test Sample

The Model: 40K, Equipment Under Test (EUT), is typically installed near doorway as part of physical access system, to control access to that door. A user will approach the door and present a BLE or RFID credentials to the reader with intention of entering the door. The reader will read the credential and send its data to a connected access control panel, which determine whether or not grant the user access to the door. Optionally, a personal identification number (PIN) may also be required, in which case the user will enter the PIN on the reader’s keypad.

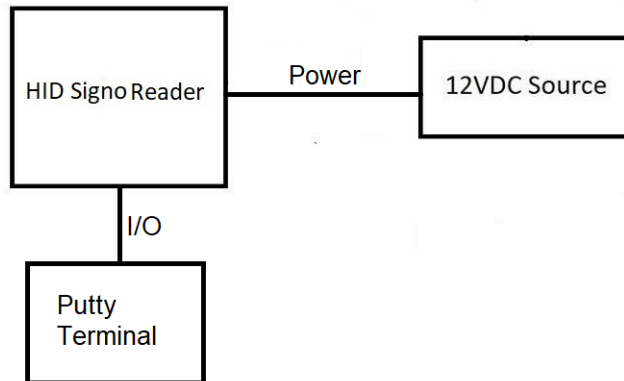

Figure 5: Block Diagram of Test Configuration

F. Equipment Configuration

The EUT was set up as outlined in **Figure 5**. All cards, racks, etc., incorporated as part of the EUT is included in the following list.

Ref. ID	Slot #	Name / Description	Model Number	Part Number	Serial Number	Rev. #
	N/A	HID Signo Reader	40K	N/A	N/A	N/A

Figure 6: Equipment List

G. Support Equipment

Support equipment necessary for the operation and testing of the EUT is included in the following list.

Ref. ID	Slot #	Name / Description	Model Number	Part number	Serial Number	Rev. #
N/A	N/A	12VDC Source	DURACELL Battery	N/A	N/A	N/A
N/A	N/A	Tablet	Galaxy Tab 4	N/A	N/A	N/A

Figure 7: Support Equipment

H. Ports and Cabling Information

Ref. ID	Port name on EUT	Cable Description or reason for no cable	Qty	Length as tested (m)	Max Length(m)	Shielded? (Y/N)	Termination Box ID & Port Name
1	+VDC	Power	1	0.3	0.3	Y	
2	GND	Power	1	0.3	0.3	Y	
3	Data1	Data	1	0.3	0.3	Y	
4	Data0	Data	1	0.3	0.3	Y	
5	GLED	Data	1	0.3	0.3	Y	
6	RLY1	Data	1	0.3	0.3	Y	
7	RLY2	Data	1	0.3	0.3	Y	
8	RLED	Data	1	0.3	0.3	Y	
9	HOLD	Data	1	0.3	0.3	Y	
10	Beep	Data	1	0.3	0.3	Y	

Figure 8: Ports and Cabling Information

I. Mode of Operation

A 12V DC provided to the EUT, once booting process done and LED's on readers turn solid RED the unit is ready to be tested. An HF/LF credential were presented to the reader for a continuously operation. The unit will beep every few seconds and LED's flashing constantly means that the unit is reading and data is going back and forth between the credential and the reader. In order to operate the BT radio, a tablet was paired to the unit via BT link and signal information presented via the HID app to insure connection is constant.

J. Method of Monitoring EUT Operation

BT: a tablet was paired via BT link with the HID app. BT signal data shown on tablet screen through the HID app to ensure link is alive and reader-tablet link is live.

K. Modifications**a) Modifications to EUT**

No modifications were made to the EUT.

b) Modifications to Test Standard

No modifications were made to the test standard.

L. Disposition of EUT

The test sample including all support equipment submitted to the Electro-Magnetic Compatibility Lab for testing was returned to HID Global Corporation upon completion of testing.

III. Electromagnetic Compatibility Criteria for Intentional Radiators

Electromagnetic Compatibility Criteria for Intentional Radiators

§ 15.203 Antenna Requirement

Test Requirement: § 15.203: An intentional radiator shall be designed to ensure that no antenna other than that furnished by the responsible party shall be used with the device. The use of a permanently attached antenna or of an antenna that uses a unique coupling to the intentional radiator shall be considered sufficient to comply with the provisions of this section. The manufacturer may design the unit so that a broken antenna can be replaced by the user, but the use of a standard antenna jack or electrical connector is prohibited.

The structure and application of the EUT were analyzed to determine compliance with Section 15.203 of the Rules. Section 15.203 states that the subject device must meet at least one of the following criteria:

- a.) Antenna must be permanently attached to the unit.
- b.) Antenna must use a unique type of connector to attach to the EUT.
- c.) Unit must be professionally installed. Installer shall be responsible for verifying that the correct antenna is employed with the unit.

Model: 40K Pigtail

Test Results: The EUT was tested is **compliant** with § 15.203 Antenna Requirement. The 40K-Pigtail Smart Card Reader uses a PCB etched antenna that is permanently attached. The 40K-Pigtail Smart Card Reader meets all requirements of 15.203.

Test Engineer: Jonathan Tavira

Test Date: September 18, 2019

Model: 40K Terminal

Test Results: The EUT was tested is **compliant** with § 15.203 Antenna Requirement. The 40K-Terminal Smart Card Reader uses a PCB etched antenna that is permanently attached. The 40K-Terminal Smart Card Reader meets all requirements of 15.203.

Test Engineer: Jonathan Tavira

Test Date: September 16, 2019

Electromagnetic Compatibility Criteria for Intentional Radiators

§ 15.207(a) Conducted Emissions Limits

Test Requirement(s): § 15.207 (a): For an intentional radiator that is designed to be connected to the public utility (AC) power line, the radio frequency voltage that is conducted back onto the AC power line on any frequency or frequencies, within the band 150 kHz to 30MHz, shall not exceed the limits in the following table, as measured using a 50 μH/50 Ω line impedance stabilization network (LISN). Compliance with the provisions of this paragraph shall be based on the measurement of the radio frequency voltage between each power line and ground at the power terminal. The lower limit applies at the boundary between the frequency ranges.

Frequency range (MHz)	§ 15.207(a), Conducted Limit (dBμV)	
	Quasi-Peak	Average
* 0.15- 0.5	66 - 56	56 - 46
0.5 - 5	56	46
5 - 30	60	50

Figure 9: Conducted Limits for Intentional Radiators from FCC Part 15 § 15.207(a)

Test Procedure:

The EUT was placed on a 0.8 m-high wooden table inside a screen room. The EUT was situated such that the back of the EUT was 0.4 m from one wall of the vertical ground plane, and the remaining sides of the EUT were no closer than 0.8 m from any other conductive surface. The EUT was powered from a 50 Ω/50 μH Line Impedance Stabilization Network (LISN). The EMC receiver scanned the frequency range from 150 kHz to 30 MHz. Conducted Emissions measurements were made in accordance with *ANSI C63.4-2014 "Methods and Measurements of Radio-Noise Emissions from Low-Voltage Electrical and Electronic Equipment in the Range of 9kHz to 40 GHz"*. The measurements were performed over the frequency range of 0.15 MHz to 30 MHz using a 50 Ω/50 μH LISN as the input transducer to an EMC/field intensity meter. For the purpose of this testing, the transmitter was turned on. Scans were performed with the transmitter on.

Sample Calculation:

$$R_r - S = M$$

where:

- R_r = Receiver Reading in dBμV
- S = Specification Limit in dBμV
- M = Margin to Specification in +/- dB

Sample formula for calculating the Corrected Data for the Conducted Emissions Measurements:

Line	Freq (MHz)	Uncorrected QP** Amplitude (dBμV)	LISN IL (dB)	CBL (dB)	Corrected QP** Amplitude (dBμV)	QP** Limit (dBμV)	Delta (dB)	Results
XYZ	0.18	42.65	10	0.58	53.23	79	-25.77	Pass

*Corrected QP** Amplitude (dBμV) = Uncorrected Amplitude (dBμV) + LISN IL (dB) + CBL (dB) = 42.65 + 10 + 0.58 = 53.23*

*** Same Calculation applies to Corrected Avg. amplitude as well*

Model: 40K Pigtail

Test Results: The EUT was tested is **compliant** with § 15.207(a) Conducted Emissions Limits. Measured emissions were below applicable limits.

Test Engineer: Adan Arab

Test Date: August 7, 2019

Test Data, Model: 40K Pigtail

Meas. Location	Meas. mΩ	Limit	Pass/Fail
Bonding measurement from LISN ground to ground plane	0.889	< 2.5 mΩ	Pass

Line	Freq (MHz)	QP Amplitude	QP Limit	Delta	Pass	Average Amplitude	Average Limit	Delta	Pass
Line1_120VAC 60Hz	0.466	49.90	56.602	-6.70	Pass	41.10	46.600	-5.50	Pass
Line1_120VAC 60Hz	0.498	46.80	56.034	-9.23	Pass	34.50	46.030	-11.53	Pass
Line1_120VAC 60Hz	0.874	37.70	56.000	-18.30	Pass	26.30	46.000	-19.70	Pass
Line1_120VAC 60Hz	1.278	41.10	56.000	-14.90	Pass	31.40	46.000	-14.60	Pass
Line1_120VAC 60Hz	0.610	40.70	56.000	-15.30	Pass	32.50	46.000	-13.50	Pass
Line1_120VAC 60Hz	2.154	37.70	56.000	-18.30	Pass	27.00	46.000	-19.00	Pass

Figure 10: Conducted Emissions Limits, Pigtail, Phase Line, Test Results

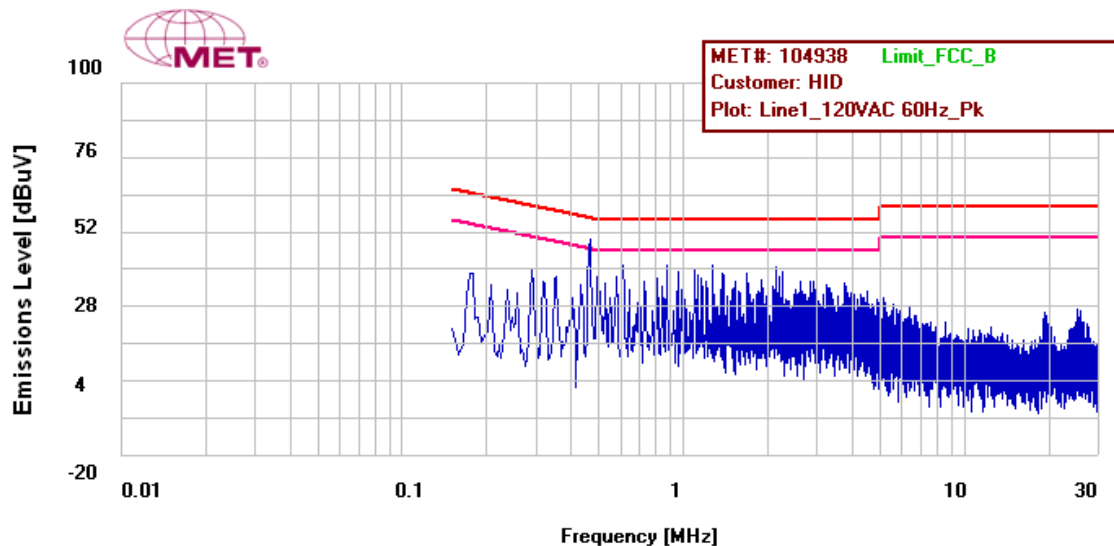

Figure 11: Conducted Emissions Limits, Pigtail, Phase Line, Prescan

Line	Freq (MHz)	QP Amplitude	QP Limit	Delta	Pass	Average Amplitude	Average Limit	Delta	Pass
Neutral_120VAC 60Hz	0.482	32.80	56.31	-23.51	Pass	16.90	46.313	-29.41	Pass
Neutral_120VAC 60Hz	0.522	42.60	56.00	-13.40	Pass	30.80	46.000	-15.20	Pass
Neutral_120VAC 60Hz	0.814	34.30	56.00	-21.70	Pass	23.00	46.000	-23.00	Pass
Neutral_120VAC 60Hz	0.174	40.60	64.77	-24.17	Pass	28.40	54.771	-26.37	Pass
Neutral_120VAC 60Hz	1.338	36.80	56.00	-19.20	Pass	25.20	46.000	-20.80	Pass
Neutral_120VAC 60Hz	0.754	34.40	56.00	-21.60	Pass	23.50	46.000	-22.50	Pass

Figure 12: Conducted Emissions Limits, Terminal, Neutral Line, Test Results

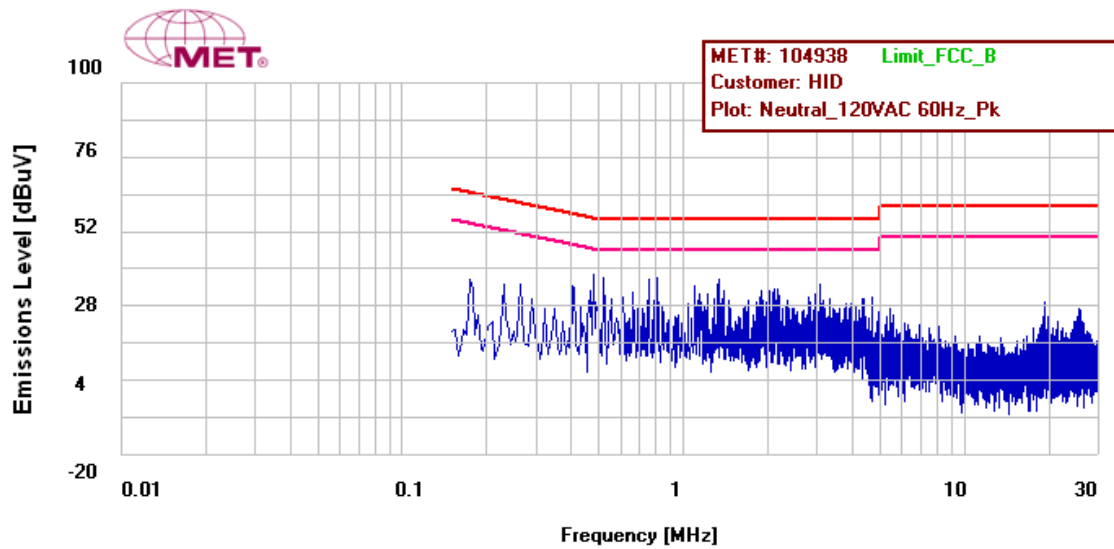

Figure 13: Conducted Emissions Limits, Terminal, Neutral Line, Prescan

Model: 40K Terminal

Test Results: The EUT was tested is **compliant** with § 15.207(a) Conducted Emissions Limits. Measured emissions were below applicable limits.

Test Engineer: Adan Arab

Test Date: August 5, 2019

Test Data, Model: 40K Terminal

Meas. Location	Meas. mΩ	Limit	Pass/Fail
Bonding measurement from LISN ground to ground plane	0.876	< 2.5 mΩ	Pass

Line	Freq (MHz)	QP Amplitude	QP Limit	Delta	Pass	Average Amplitude	Average Limit	Delta	Pass
Line1_120VAC 60Hz	0.438	46.00	57.124	-11.12	Pass	33.40	47.124	-13.72	Pass
Line1_120VAC 60Hz	0.526	42.40	56.000	-13.60	Pass	33.60	46.000	-12.40	Pass
Line1_120VAC 60Hz	0.466	50.30	56.602	-6.30	Pass	40.60	46.602	-6.00	Pass
Line1_120VAC 60Hz	0.406	41.80	57.752	-15.95	Pass	40.90	47.752	-6.85	Pass
Line1_120VAC 60Hz	0.234	41.90	62.317	-20.42	Pass	33.30	52.317	-19.02	Pass
Line1_120VAC 60Hz	0.350	40.90	58.982	-18.08	Pass	32.20	48.982	-16.78	Pass

Figure 14: Conducted Emissions Limits, Terminal, Phase Line, Test Results

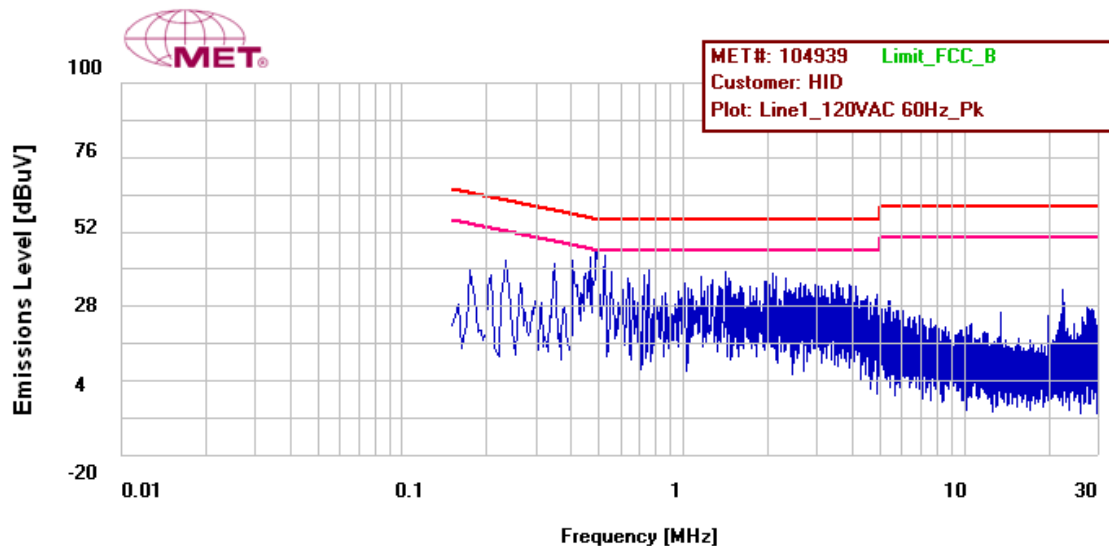

Figure 15: Conducted Emissions Limits, Terminal, Phase Line, Prescan

Line	Freq (MHz)	QP Amplitude	QP Limit	Delta	Pass	Average Amplitude	Average Limit	Delta	Pass
Neutral_120VAC 60Hz	0.466	46.80	56.602	-9.80	Pass	35.80	46.602	-10.80	Pass
Neutral_120VAC 60Hz	0.498	40.90	56.034	-15.13	Pass	28.80	46.034	-17.23	Pass
Neutral_120VAC 60Hz	0.482	36.90	56.313	-19.41	Pass	22.50	46.313	-23.81	Pass
Neutral_120VAC 60Hz	0.666	35.00	56.000	-21.00	Pass	25.10	46.000	-20.90	Pass
Neutral_120VAC 60Hz	0.184	43.10	64.308	-21.21	Pass	30.10	54.308	-24.20	Pass
Neutral_120VAC 60Hz	2.090	31.90	56.000	-24.10	Pass	20.70	46.000	-25.30	Pass

Figure 16: Conducted Emissions Limits, Terminal, Neutral Line, Test Results

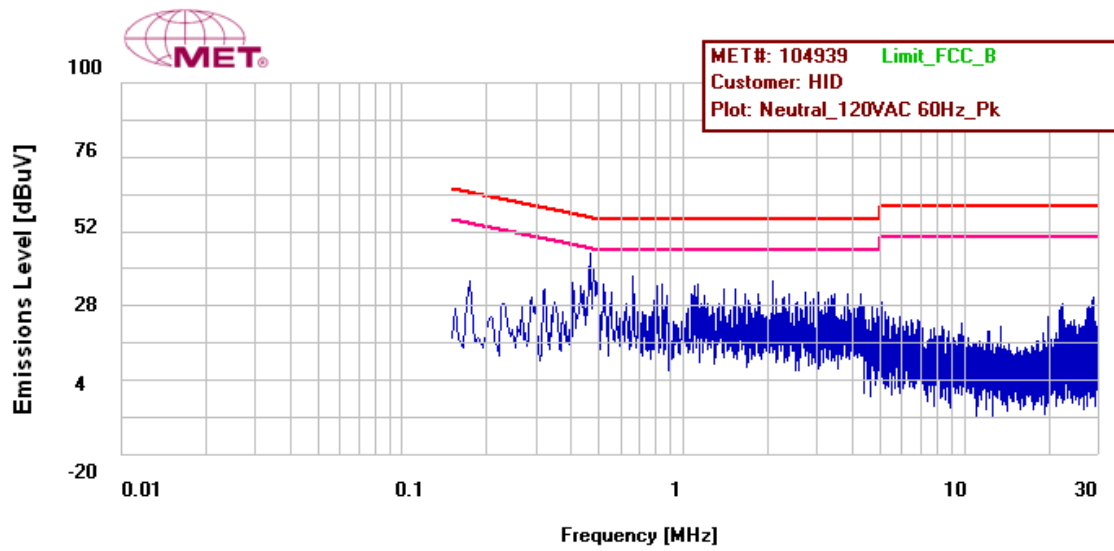

Figure 17: Conducted Emissions Limits, Terminal, Neutral Line, Prescan

Electromagnetic Compatibility Criteria for Intentional Radiators

§ 15.247(a)(2) 6 dB Bandwidth

Test Requirements: § 15.247(a)(2): Operation under the provisions of this section is limited to frequency hopping and digitally modulated intentional radiators that comply with the following provisions:

For systems using digital modulation techniques, the EUT may operate in the 902-928 MHz, 2400-2483.5 MHz and 5725-5850 MHz bands. The minimum 6dB bandwidth shall be at least 500 kHz.

Test Procedure: The transmitter was on and transmitting at the highest output power. The bandwidth of the fundamental frequency was measured with the spectrum analyzer using a RBW = 100kHz, VBW = 3*RBW. The 6 dB Bandwidth was measured and recorded. The measurements were performed on the low, mid and high channels.

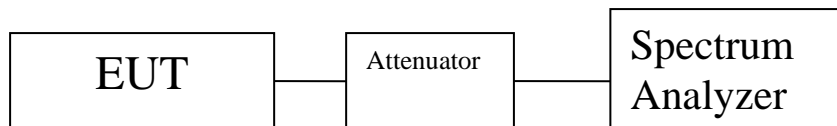

Figure 18: Block Diagram, Occupied Bandwidth Test Setup

Model: 40K Pigtail

Test Results: The EUT was tested is **compliant** with § 15.247(a)(2) 6 dB Bandwidth. No anomalies were noted.

The 6 dB Bandwidth was determined from the plots on the following pages.

Test Engineer: Jonathan Tavira

Test Date: September 18, 2019

Test Data, Model: 40K Pigtail

Mode	Channel (MHz)	6 dB Bandwidth (MHz)	Limit (MHz)
1 Mbps	2402	0.759963	≥0.500
1 Mbps	2442	0.788955	≥0.500
1 Mbps	2480	0.743060	≥0.500
2 Mbps	2402	1.309000	≥0.500
2 Mbps	2442	1.326000	≥0.500
2 Mbps	2480	1.326000	≥0.500

Figure 19: 6 dB Bandwidth, Pigtail, Test Results

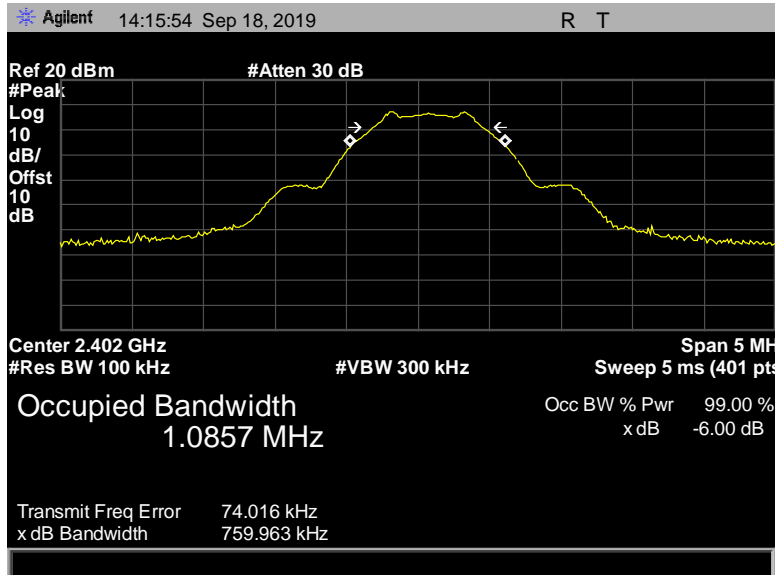

Figure 20: 6 dB Bandwidth, Pigtail, 2402 MHz, 1 Mbps, 759.963 kHz

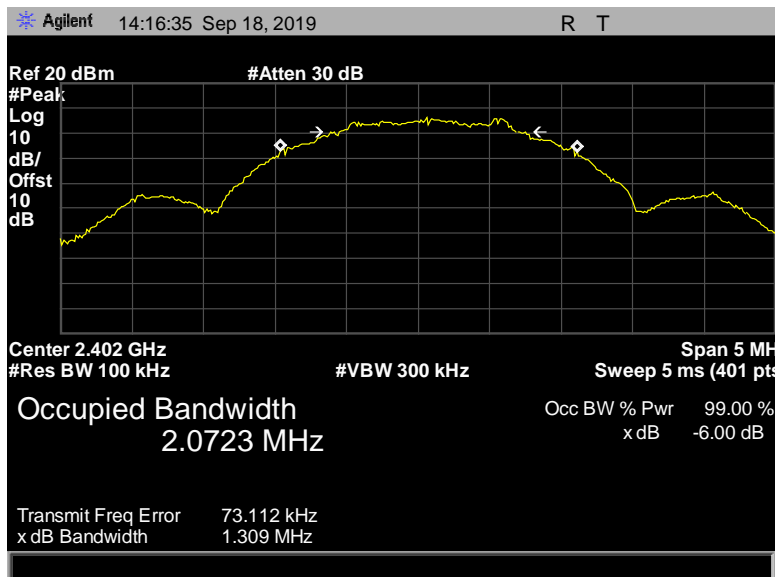

Figure 21: 6 dB Bandwidth, Pigtail, 2402 MHz, 2 Mbps, 1.309 MHz

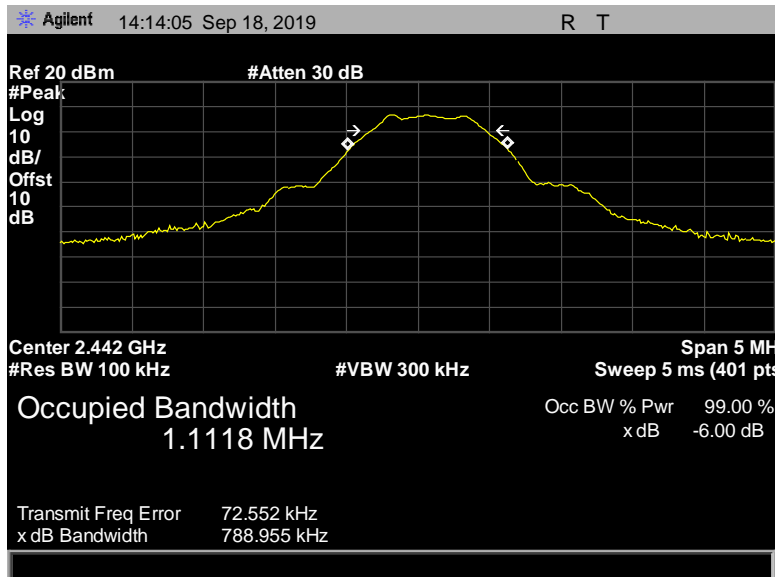

Figure 22: 6 dB Bandwidth, Pigtail, 2442 MHz, 1 Mbps, 788.955 kHz

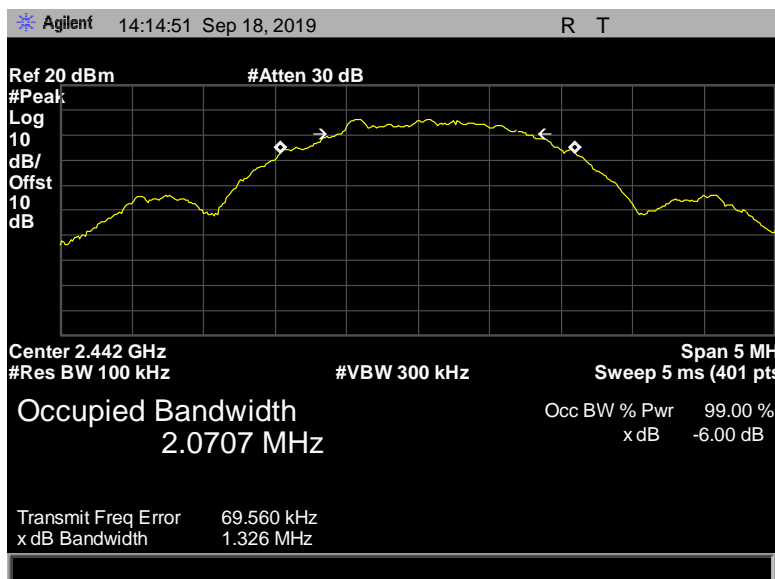

Figure 23: 6 dB Bandwidth, Pigtail, 2442 MHz, 2 Mbps, 1.326 MHz

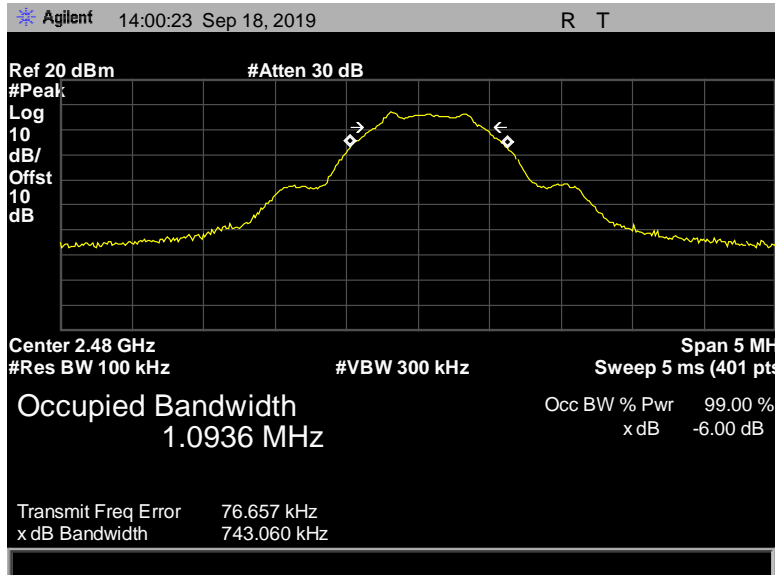

Figure 24: 6 dB Bandwidth, Pigtail, 2480 MHz, 1 Mbps, 743.060 kHz

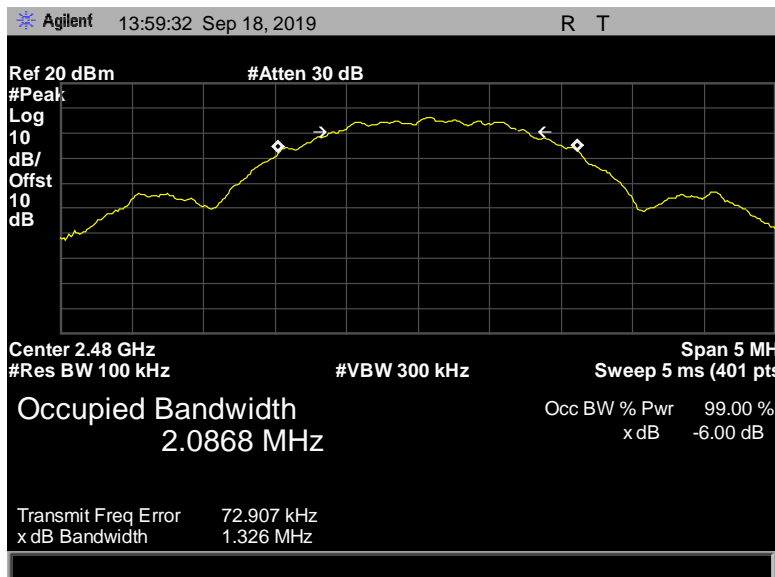

Figure 25: 6 dB Bandwidth, Pigtail, 2480 MHz, 2 Mbps, 1.326 MHz

Model: 40K Terminal

Test Results: The EUT was tested is **compliant** with § 15.247(a)(2) 6 dB Bandwidth. No anomalies were noted.

The 6 dB Bandwidth was determined from the plots on the following pages.

Test Engineer: Jonathan Tavira

Test Date: September 6, 2019

Test Data, Model: 40K Terminal

Mode	Channel (MHz)	6 dB Bandwidth (MHz)	Limit (MHz)
1 Mbps	2402	0.740764	≥0.500
1 Mbps	2442	0.773330	≥0.500
1 Mbps	2480	0.759417	≥0.500
2 Mbps	2402	1.324000	≥0.500
2 Mbps	2442	1.385000	≥0.500
2 Mbps	2480	1.201000	≥0.500

Figure 26: 6 dB Bandwidth, 40K Terminal, Test Results

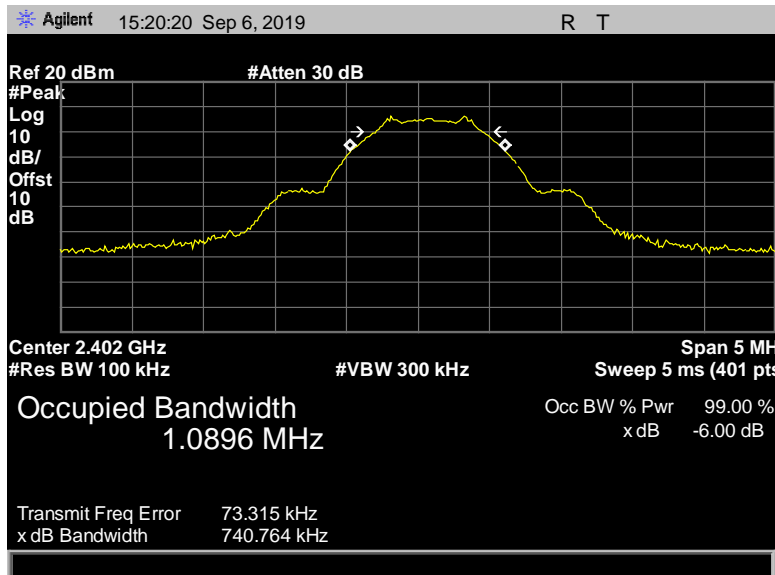

Figure 27: 6 dB Bandwidth, Terminal, 2402 MHz, 1 Mbps, 740.764 kHz

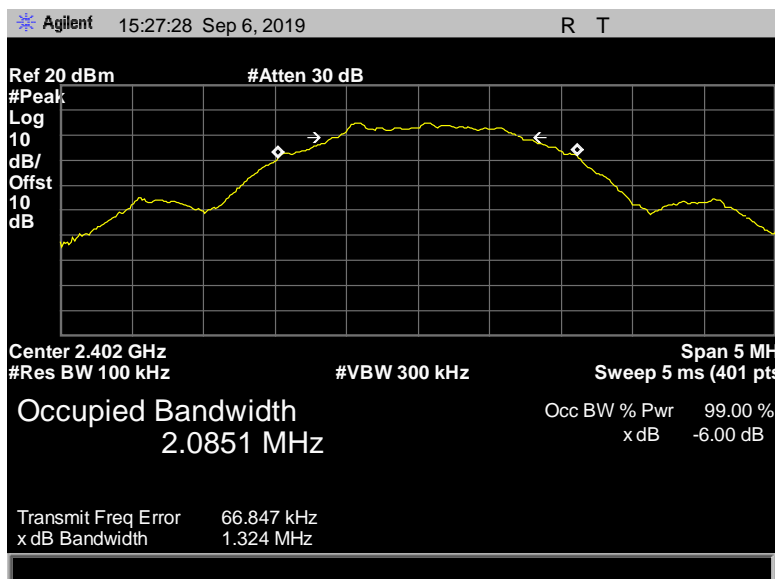

Figure 28: 6 dB Bandwidth, Terminal, 2402 MHz, 2 Mbps, 1.324 MHz

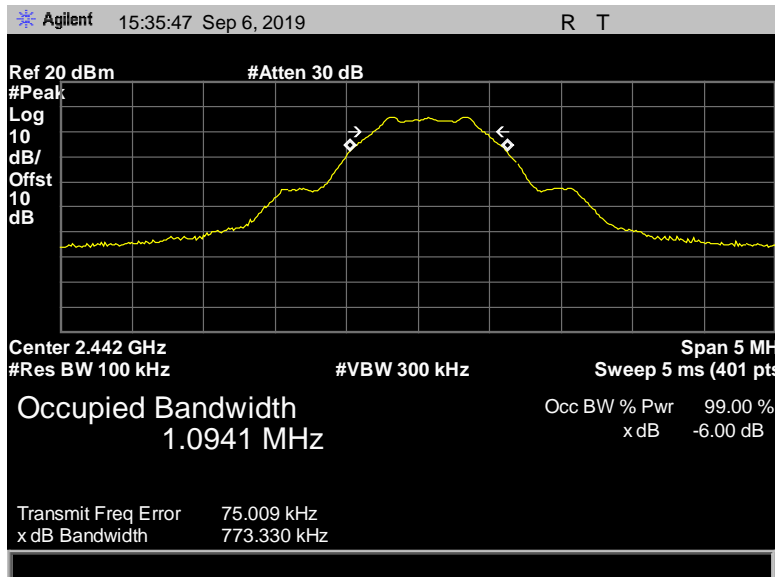

Figure 29: 6 dB Bandwidth, Terminal, 2442 MHz, 1 Mbps, 773.330 kHz

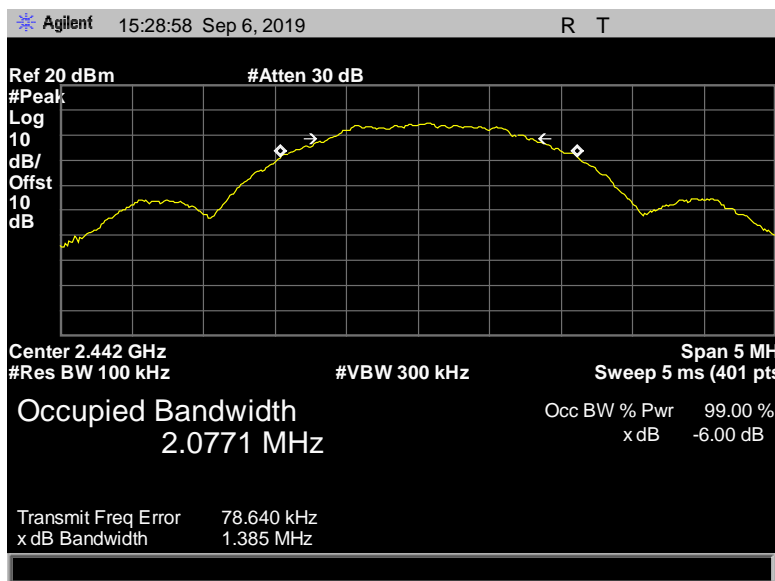

Figure 30: 6 dB Bandwidth, Terminal, 2442 MHz, 2 Mbps, 1.385 MHz

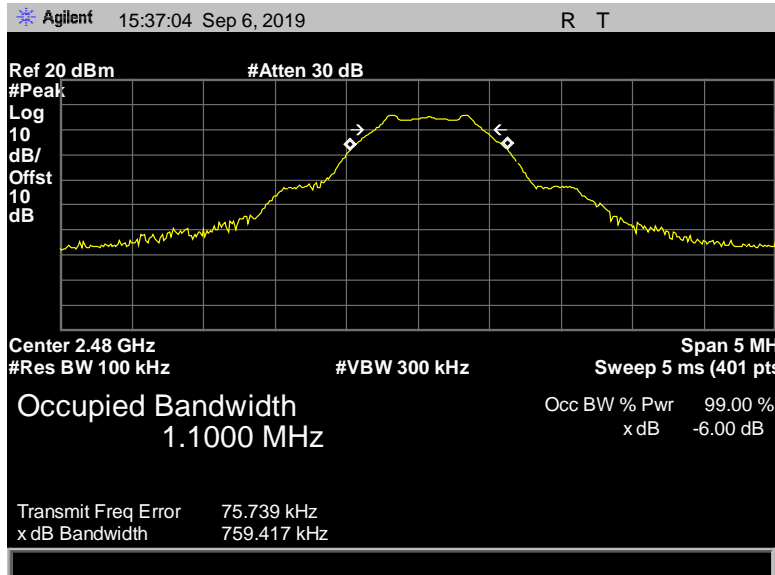

Figure 31: 6 dB Bandwidth, Terminal, 2480 MHz, 1 Mbps, 759.417 kHz

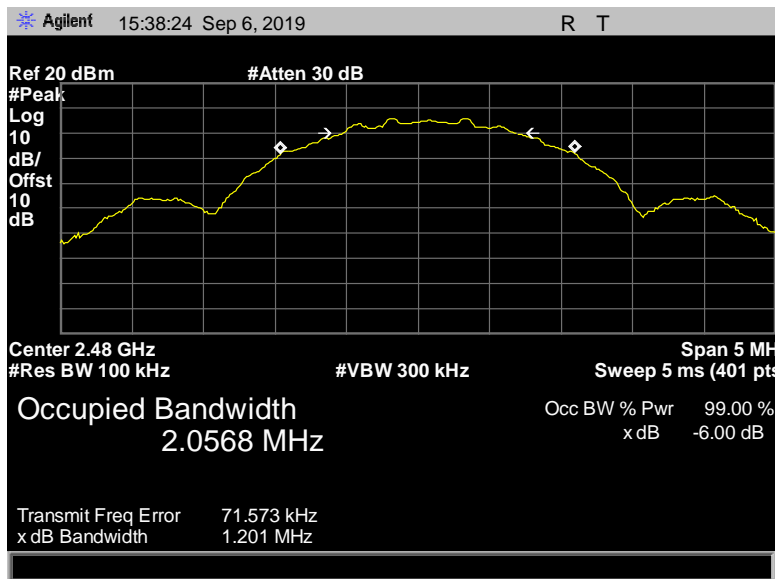

Figure 32: 6 dB Bandwidth, Terminal, 2480 MHz, 2 Mbps, 1.201 MHz

Electromagnetic Compatibility Criteria for Intentional Radiators

§ 15.247(b) Peak Power Output

Test Requirements: §15.247(b): The maximum peak output power of the intentional radiator shall not exceed the following:

Digital Transmission Systems (MHz)	Output Limit (Watts)
2400–2483.5	1.000

Figure 33: Output Power Requirements from §15.247(b)

§15.247(c): if transmitting antennas of directional gain greater than 6 dBi are used the peak output power from the intentional radiator shall be reduced below the stated values in the 9, as appropriate, by the amount in dB that the directional gain of the antenna exceeds 6 dBi.

Test Procedure: The EUT was configured to measure the low, mid and high channels of each band at the maximum power level. Measurements were performed in a conducted setup as shown in figure below.

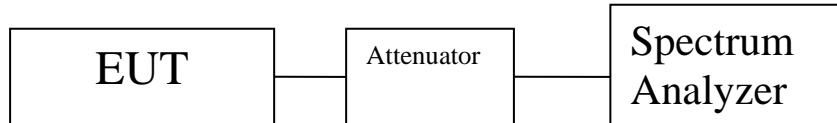

Figure 34: Block Diagram, Peak Conducted Output Power Test Setup

Model: 40K Pigtail

Test Results: The EUT was tested is **compliant** with § 15.247(b) Peak Power Output. No anomalies were noted.

Test Engineer: Jonathan Tavira

Test Date: September 18, 2019

Test Data, Model: 40K Pigtail

Mode	Channel (MHz)	Peak Output Power (dBm)
1 Mbps	2402	0.05
1 Mbps	2442	-0.17
1 Mbps	2480	-0.47
2 Mbps	2402	0.94
2 Mbps	2442	0.71
2 Mbps	2480	0.41

Figure 35: Peak Power Output, Pigtail, Test Results

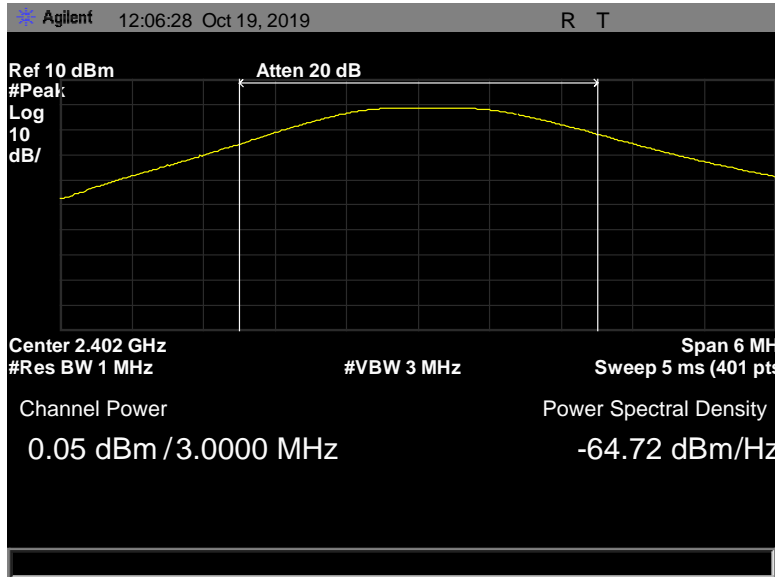

Figure 36: Peak Power Output, Pigtail, 2402 MHz, 1 Mbps, 0.05 dBm

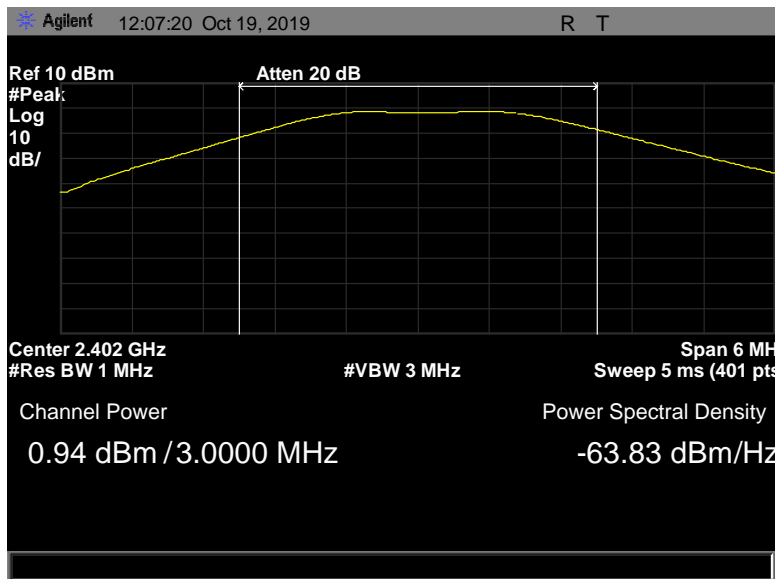

Figure 37: Peak Power Output, Pigtail, 2402 MHz, 2 Mbps, 0.94 dBm

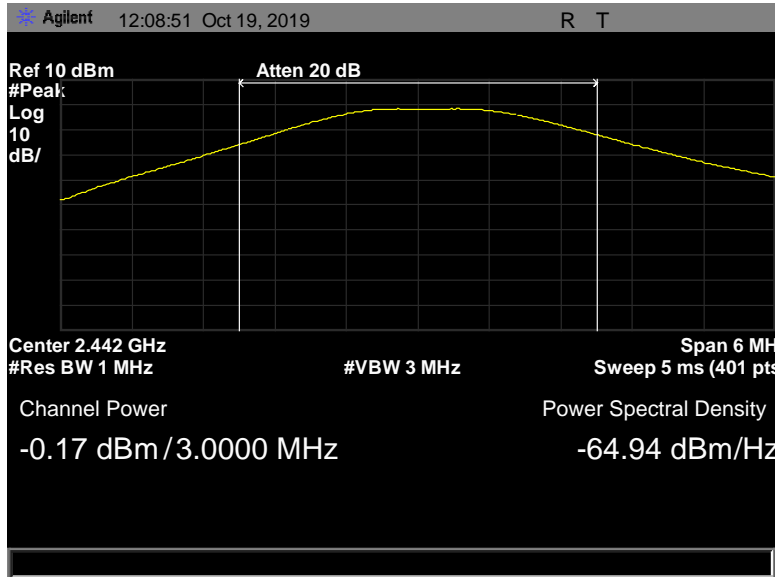

Figure 38: Peak Power Output, Pigtail, 2442 MHz, 1 Mbps, -0.17 dBm

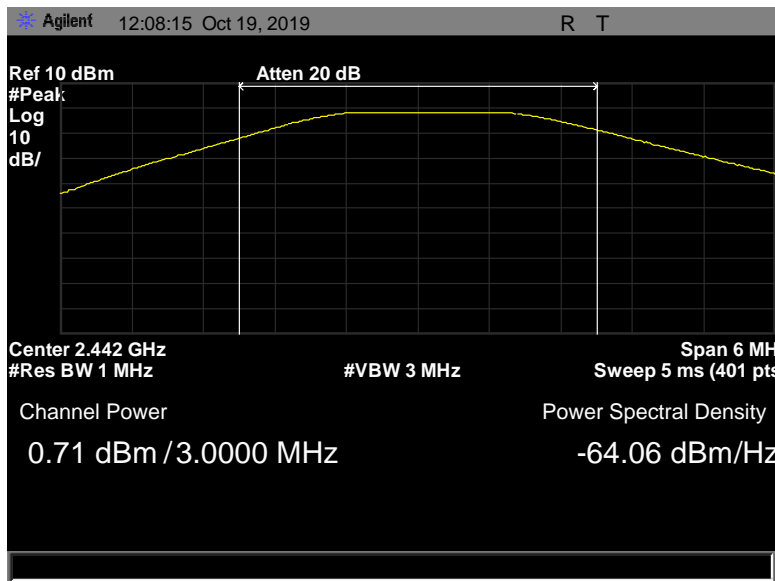

Figure 39: Peak Power Output, Pigtail, 2442 MHz, 2 Mbps, 0.71 dBm

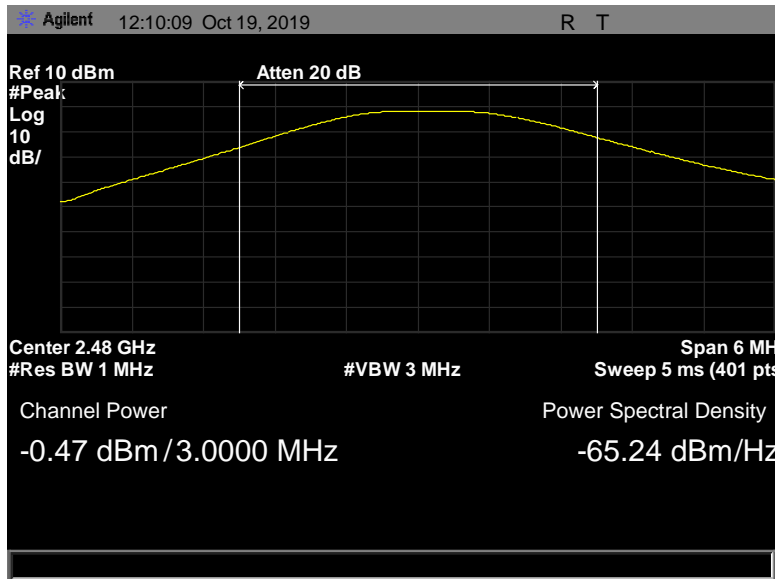

Figure 40: Peak Power Output, Pigtail, 2480 MHz, 1 Mbps, -0.47 dBm

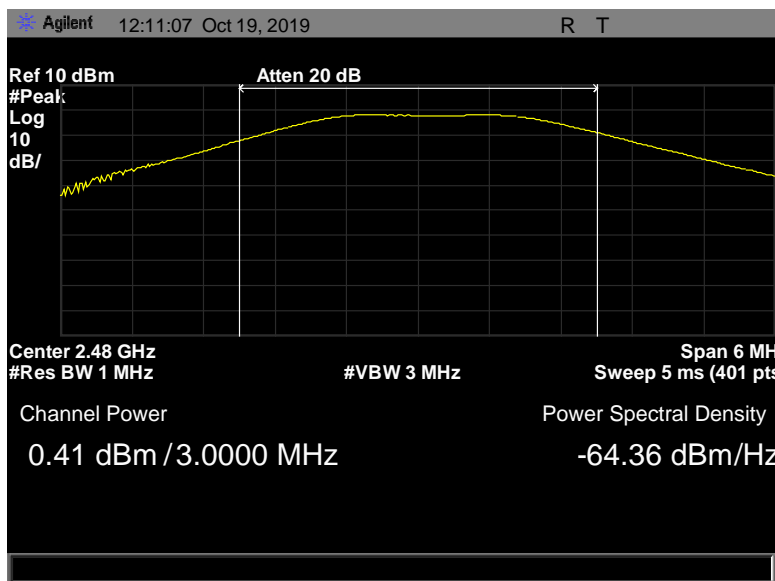

Figure 41: Peak Power Output, Pigtail, 2480 MHz, 2 Mbps, 0.41 dBm

Model: 40K Terminal

Test Results: The EUT was tested is **compliant** with § 15.247(b) Peak Power Output. No anomalies were noted.

Test Engineer: Jonathan Tavira

Test Date: September 6, 2019

Test Data, Model: 40K Terminal

Mode	Channel (MHz)	Peak Output Power (dBm)
1 Mbps	2402	0.30
1 Mbps	2442	0.09
1 Mbps	2480	-0.15
2 Mbps	2402	1.23
2 Mbps	2442	0.99
2 Mbps	2480	0.75

Figure 42: Peak Power Output, Terminal, Test Results

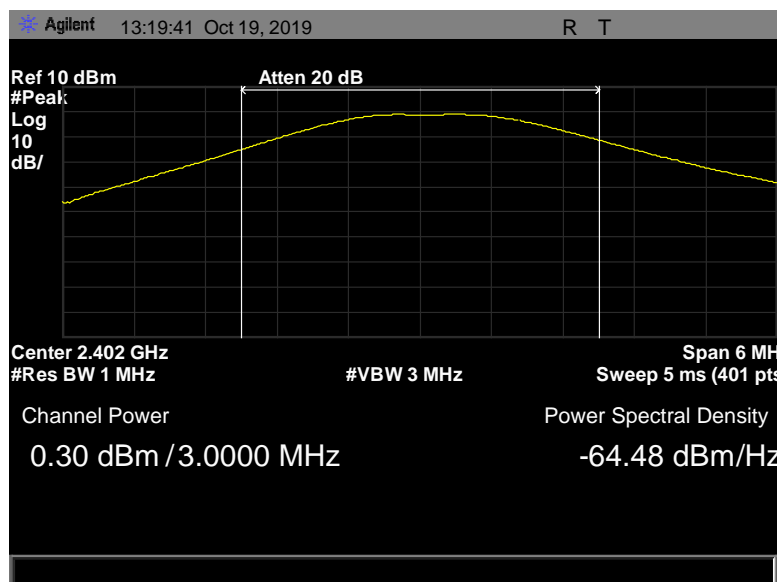

Figure 43: Peak Power Output, Terminal, 2402 MHz, 1 Mbps, 0.30 dBm

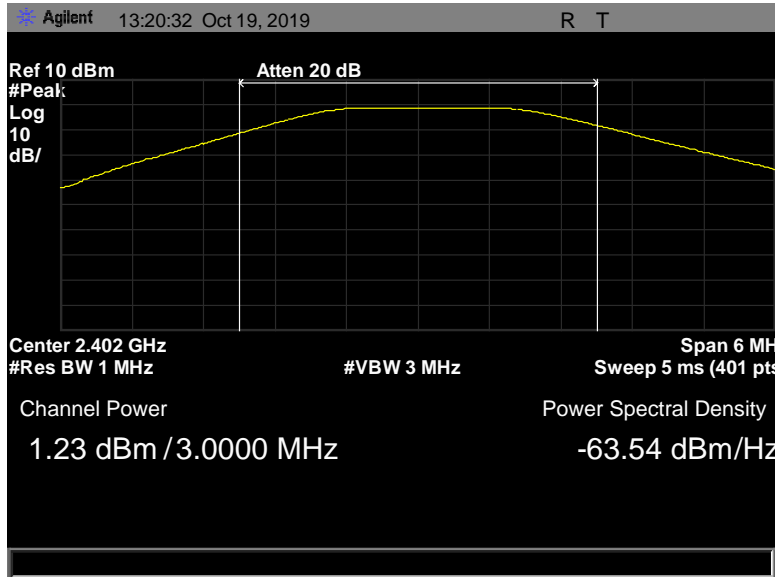

Figure 44: Peak Power Output, Terminal, 2402 MHz, 2 Mbps, 1.23 dBm

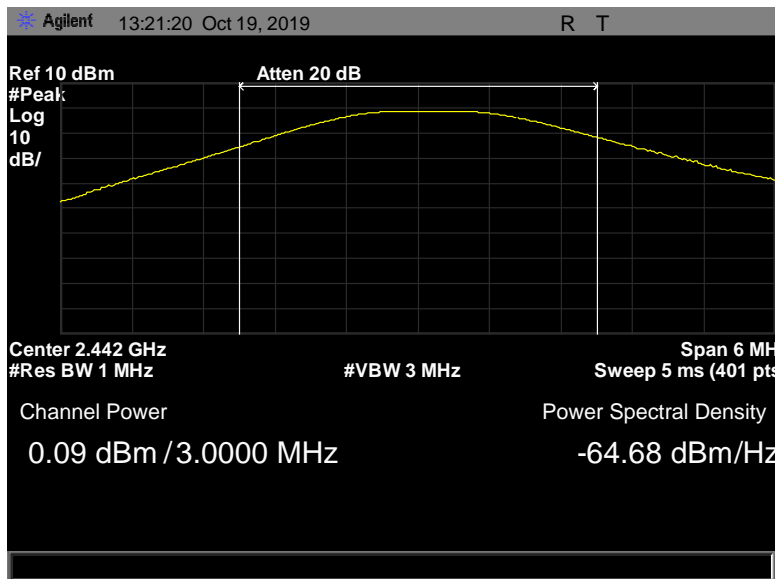

Figure 45: Peak Power Output, Terminal, 2442 MHz, 1 Mbps, 0.09 dBm

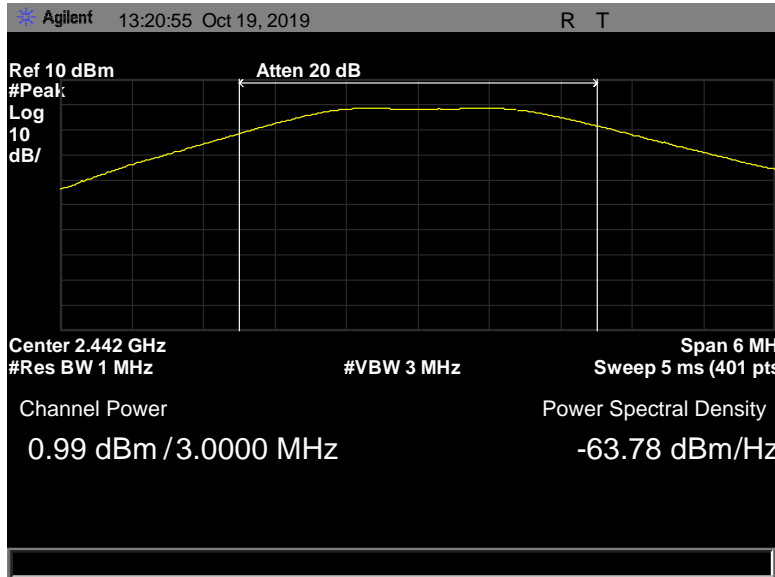

Figure 46: Peak Power Output, Terminal, 2442 MHz, 2 Mbps, 0.99 dBm

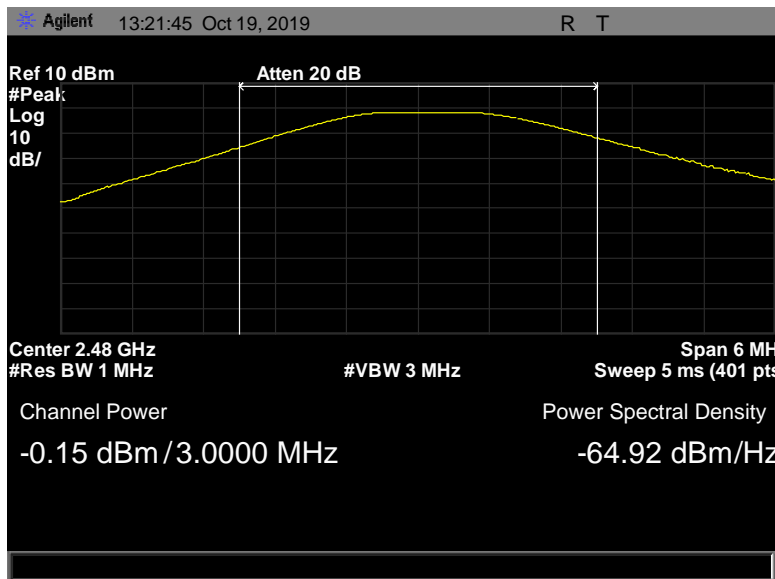

Figure 47: Peak Power Output, Terminal, 2480 MHz, 1 Mbps, -0.15 dBm

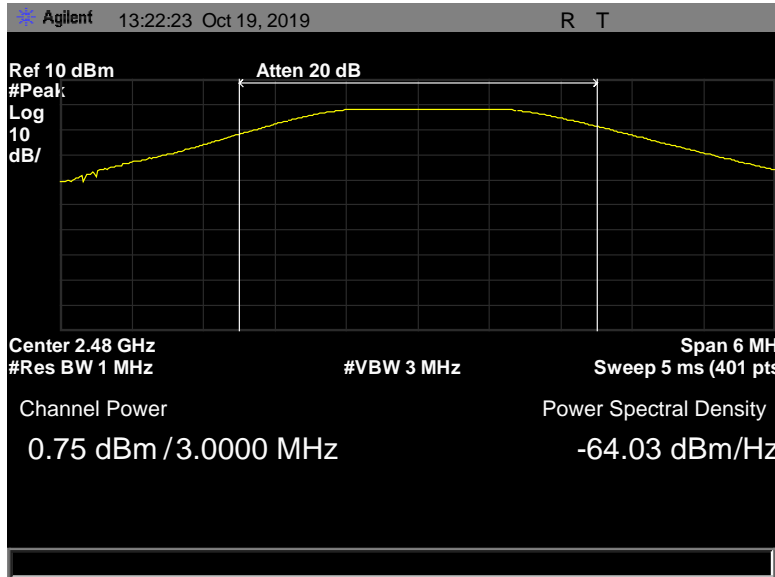

Figure 48: Peak Power Output, Terminal, 2480 MHz, 2 Mbps, 0.75 dBm

Electromagnetic Compatibility Criteria for Intentional Radiators

§ 15.209 Radiated Spurious Emissions Requirements and Band Edge

Test Requirements: §15.247(d); §15.205: Emissions outside the frequency band.

§15.205(a): Except as shown in paragraph (d) of this section, only spurious emissions are permitted in any of the frequency bands listed below:

MHz	MHz	MHz	GHz
0.090–0.110-----	16.42–16.423	399.9–410	4.5–5.15
¹ 0.495–0.505-----	16.69475–16.69525	608–614	5.35–5.46
2.1735–2.1905-----	16.80425–16.80475	960–1240	7.25–7.75
4.125–4.128-----	25.5–25.67	1300–1427	8.025–8.5
4.17725–4.17775-----	37.5–38.25	1435–1626.5	9.0–9.2
4.20725–4.20775-----	73–74.6	1645.5–1646.5	9.3–9.5
6.215–6.218-----	74.8–75.2	1660–1710	10.6–12.7
6.26775–6.26825-----	108–121.94	1718.8–1722.2	13.25–13.4
6.31175–6.31225-----	123–138	2200–2300	.47–14.5
8.291–8.294-----	149.9–150.05	2310–2390	15.35–16.2
8.362–8.366-----	156.52475–156.52525	2483.5–2500	17.7–21.4
8.37625–8.38675-----	156.7–156.9	2655–2900	22.01–23.12
8.41425–8.41475-----	162.0125–167.17	3260–3267	23.6–24.0
12.29–12.293-----	167.72–173.2	3332–3339	31.2–31.8
12.51975–12.52025-----	240–285	3345.8–3358 36.	43–36.5
12.57675–12.57725-----	322–335.4	3600–4400	(²)

Figure 49: Restricted Bands of Operation

¹ Until February 1, 1999, this restricted band shall be 0.490 – 0.510 MHz.

² Above 38.6

Test Requirement(s): § 15.209 (a): Except as provided elsewhere in this subpart, the emissions from an intentional radiator shall not exceed the field strength levels specified in Figure 50:

Frequency (MHz)	§ 15.209(a), Radiated Emission Limits (dBµV) @ 3m
30 - 88	40.00
88 - 216	43.50
216 - 960	46.00
Above 960	54.00

Figure 50: Radiated Emissions Limits Calculated from FCC Part 15, § 15.209 (a)

Test Procedures: The transmitter was turned on. Measurements were performed of the low, mid and high Channels. The EUT was rotated orthogonally through all three axes. Plots shown are corrected for both antenna correction factor and distance and compared to a 3 m limit line. Only noise floor was measured above 18 GHz.

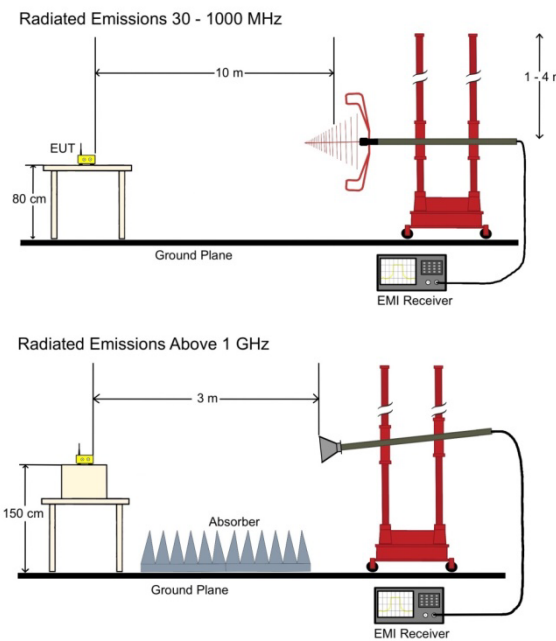

Figure 51: Radiated Emissions Test Setup

Sample Calculation for Distance Correction factor (DCF) measurement:

$$F_d = 20 \cdot \text{LOG}_{10} (D_m/D_s)$$

where:

- F_d = Distance Factor in dB
- D_m = Measurement Distance in meters
- D_s = Specification Distance in meters

Sample formula for calculating the Corrected Data for the Radiated Emissions Measurements:

Frequency (MHz)	Antenna Polarity	EUT Azimuth (Degrees)	Antenna Height (cm)	Uncorrected Amplitude (dBμV/m)	ACF (dB/m) (+)	Pre Amp Gain + CBL (dB)(-)	DCF (dB) (+)	Corrected Amplitude (dBμV/m)	Limit (dBμV/m)	Margin (dB)
249.99	V	359.9	240.7	55.46	11.4	28.335	10.46	38.525	47	-8.475

$$\begin{aligned} \text{Corrected Amplitude (dB}\mu\text{V/m)} &= \text{Uncorrected Amplitude (dB}\mu\text{V/m)} + \text{ACF (dB/m)} - (\text{Preamp Gain (dB)} + \text{CBL (dB)} + \text{DCF (dB)})^{**} \\ &= 55.46 + 11.4 - 28.355 + 10.46 = \mathbf{38.525} \end{aligned}$$

** DCF Column represents the appropriate correction factor used when the measurement distance differs from the specification distance.

Model: 40K Pigtail

Test Results: The EUT was tested is **compliant** with § 15.209 Radiated Spurious Emissions Requirements and Band Edge. Based Peak output power and Peak power spectral density measurement, it was determined that the 2 Mbps mod produced the worst-case operating conditions of the EUT. No anomalies were noted.

Test Engineer: Jonathan Tavira

Test Date: September 26, 2019

Test Data, Model: 40K Pigtail

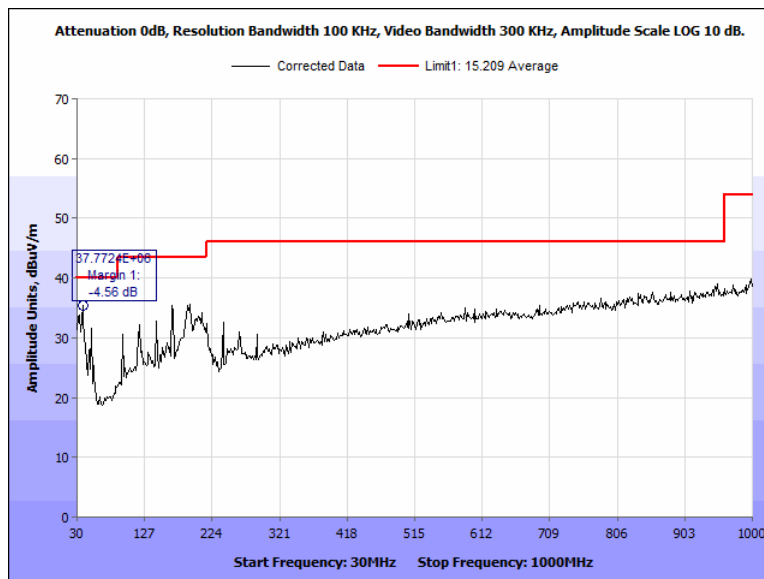

Figure 52: Radiated Spurious Emissions, Pigtail, 2402 MHz, 30 MHz - 1000 MHz, Horizontal

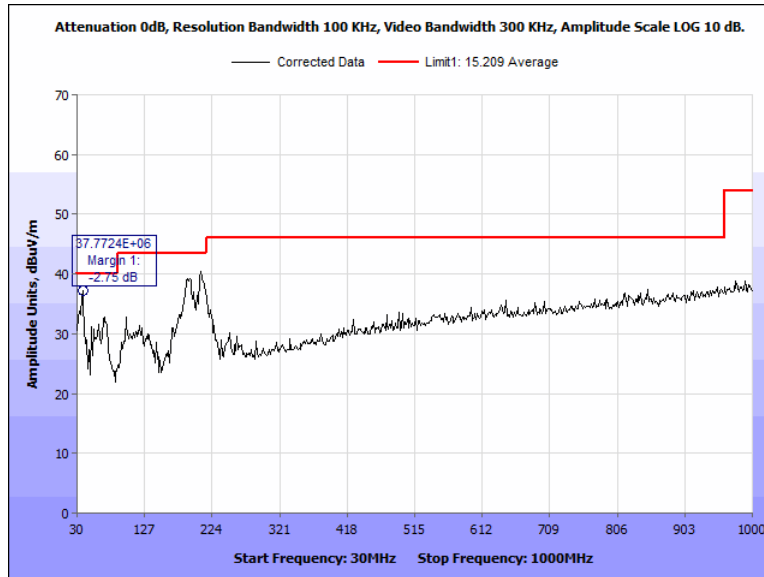

Figure 53: Radiated Spurious Emissions, Pigtail, 2402 MHz, 30 MHz - 1000 MHz, Vertical

Frequency (MHz)	EUT Azimuth (Degrees)	Antenna Polarity (H/V)	Antenna HEIGHT (m)	Uncorrected EMI Meter Reading (dBµV)	Antenna Correction Factor (dB/m) (+)	Distance Correction Factor (dB) (-)	Cable Loss/Pre-amp (dB) (+)	Corrected Amplitude (dBµV/m)	Limit (dBµV/m)	Margin (dB)
37.7724	180.60	H	1.52	31.12	18.44	10.46	-24.58	35.44	40	-4.56
33.1090	181.20	H	1.52	26.78	21.25	10.46	-24.70	33.78	40	-6.22
31.5545	180.60	H	1.53	25.78	21.92	10.46	-24.72	33.44	40	-6.56
37.7724	180.50	V	1.67	32.93	18.44	10.46	-24.58	37.25	40	-2.75
207.2115	180.50	V	1.52	39.00	13.78	10.46	-22.86	40.37	43.5	-3.13
208.7660	180.60	V	1.49	38.21	13.62	10.46	-22.83	39.46	43.5	-4.04

Figure 54: Radiated Spurious Emissions, Pigtail, 2402 MHz, 30 MHz – 1000 MHz

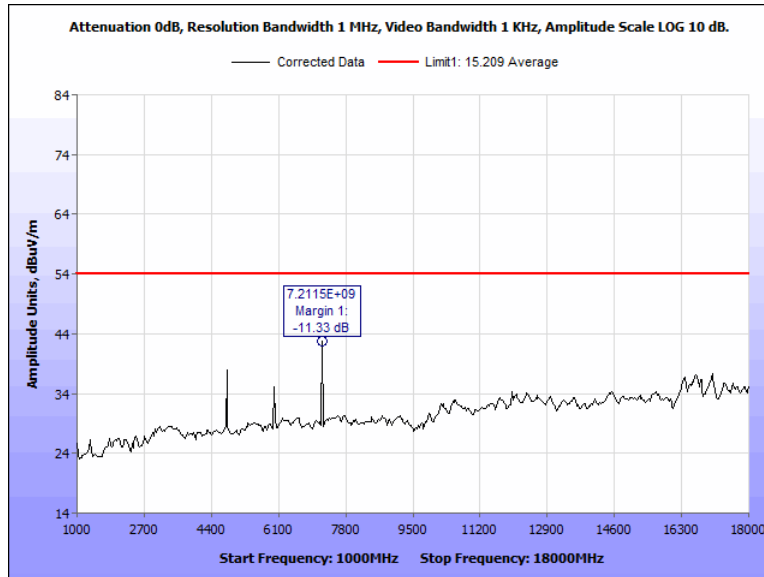

Figure 55: Radiated Spurious Emissions, Pigtail, 2402 MHz, 1 GHz - 18 GHz, Average, Horizontal

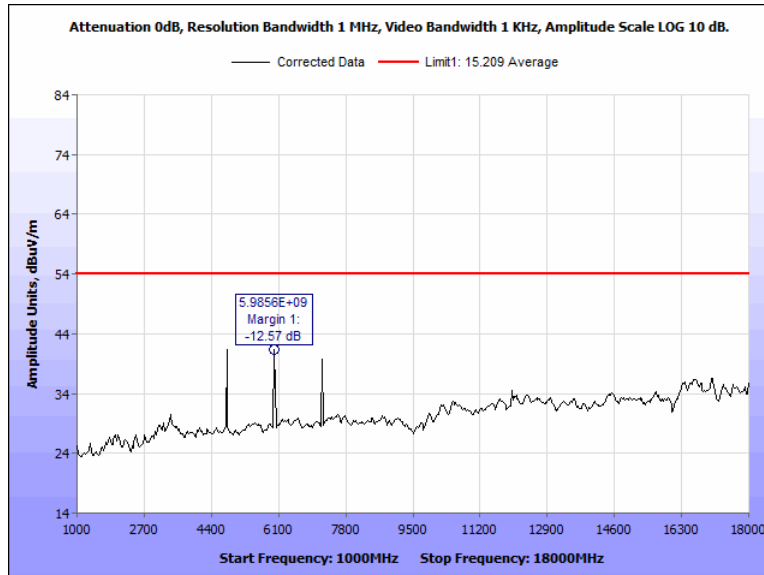

Figure 56: Radiated Spurious Emissions, Pigtail, 2402 MHz, 1 GHz - 18 GHz, Average, Vertical

Frequency (GHz)	EUT Azimuth (Degrees)	Antenna Polarity (H/V)	Antenna HEIGHT (m)	Uncorrected EMI Meter Reading (dBµV)	Antenna Correction Factor (dB/m) (+)	Distance Correction Factor (dB) (-)	Cable Loss/Pre-amp (dB) (+)	Corrected Amplitude (dBµV/m)	Limit (dBµV/m)	Margin (dB)
7.2115	210.00	H	2.20	47.29	35.38	0.00	-40.00	42.67	54	-11.33
4.7869	187.20	H	1.80	42.61	33.81	0.00	-38.46	37.97	54	-16.03
17.0737	180.60	H	1.89	37.85	40.91	0.00	-41.55	37.31	54	-16.69
4.7869	188.30	V	1.88	46.06	33.81	0.00	-39.74	41.41	54	-12.59
5.9856	180.76	V	1.82	46.24	34.89	0.00	-39.69	41.43	54	-12.57
7.2115	180.60	V	1.86	44.36	35.38	0.00	-40.00	39.74	54	-14.26

Figure 57: Radiated Spurious Emissions, Pigtail, 2402 MHz, 1 GHz – 18 GHz, Test Results

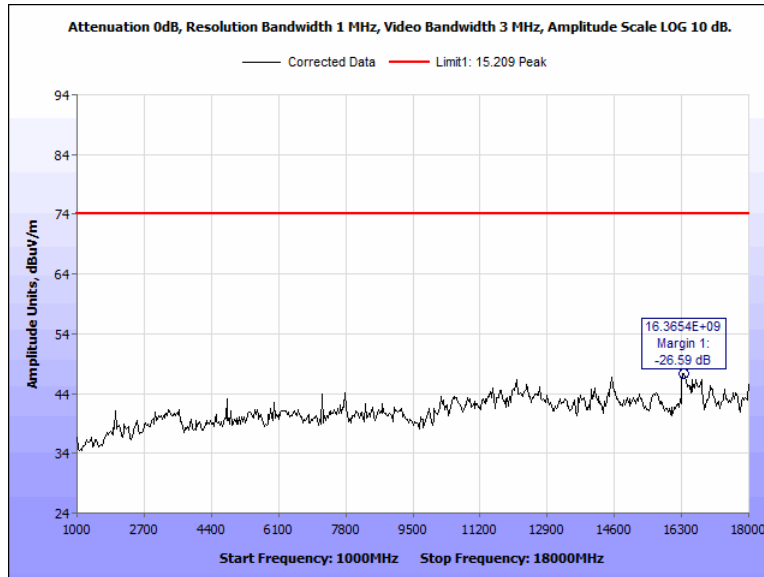

Figure 58: Radiated Spurious Emissions, Pigtail, 2402 MHz, 1 GHz - 18 GHz, Peak, Horizontal

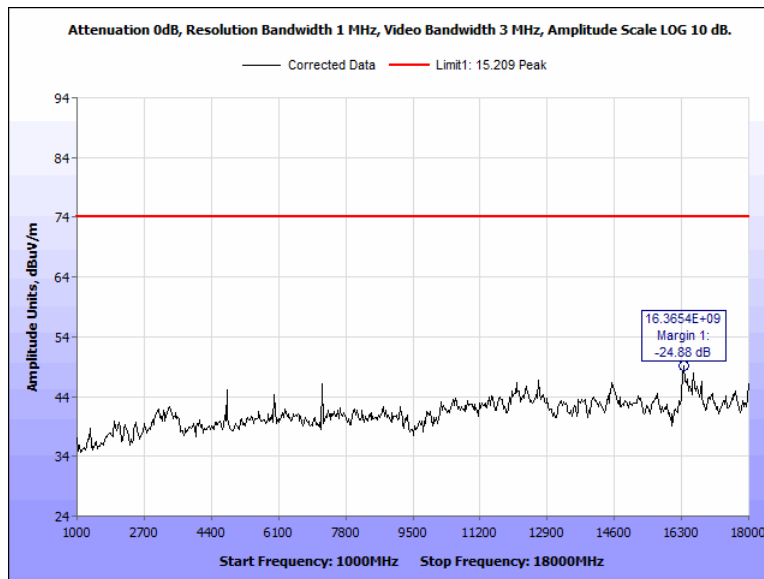

Figure 59: Radiated Spurious Emissions, Pigtail, 2402 MHz, 1 GHz - 18 GHz, Peak, Vertical

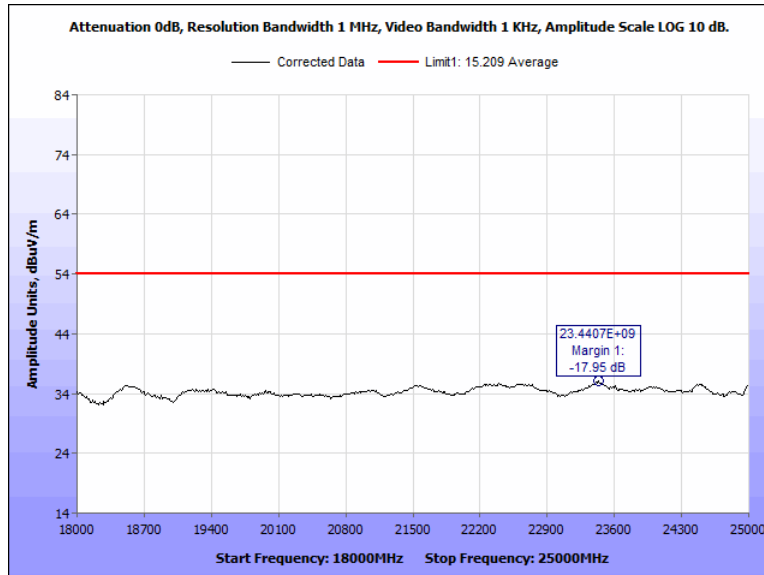

Figure 60: Radiated Spurious Emissions, Pigtail, 2402 MHz, 18 GHz - 25 GHz, Average, Horizontal

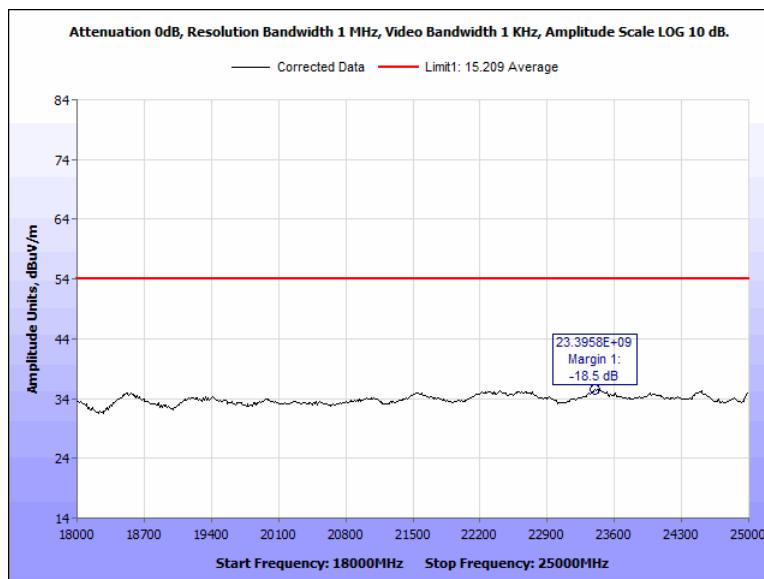

Figure 61: Radiated Spurious Emissions, Pigtail, 2402 MHz, 18 GHz - 25 GHz, Average, Vertical

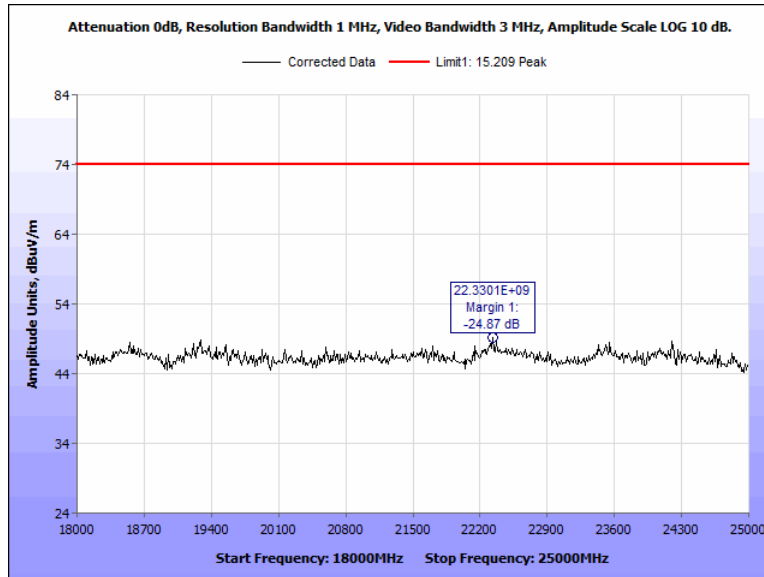

Figure 62: Radiated Spurious Emissions, Pigtail, 2402 MHz, 18 GHz - 25 GHz, Peak, Horizontal

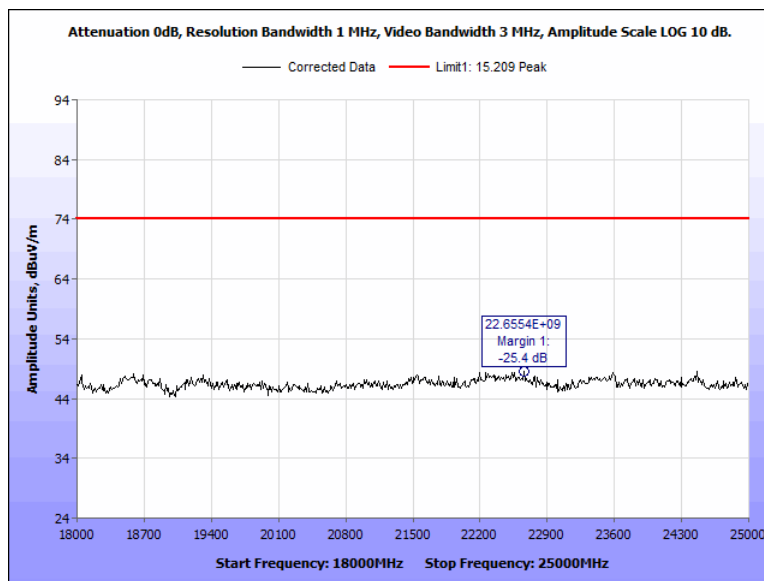

Figure 63: Radiated Spurious Emissions, Pigtail, 2402 MHz, 18 GHz - 25 GHz, Peak, Vertical

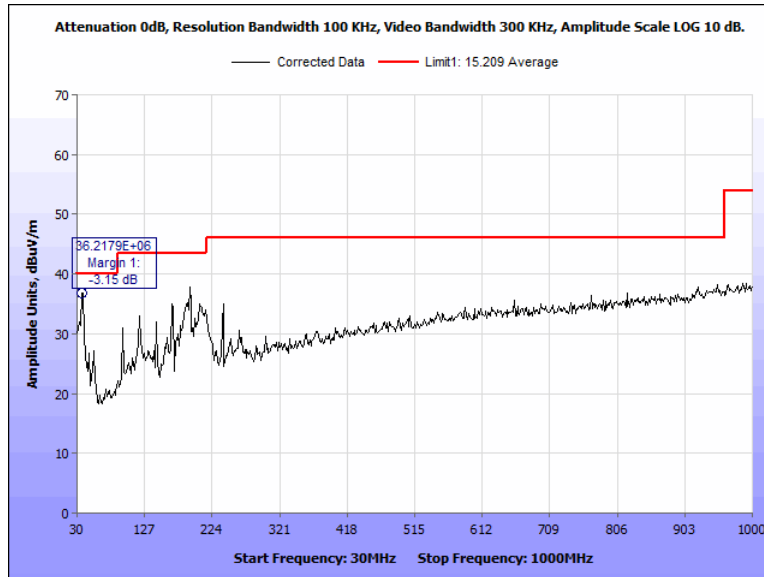

Figure 64: Radiated Spurious Emissions, Pigtail, 2442 MHz, 30 MHz - 1000 MHz, Horizontal

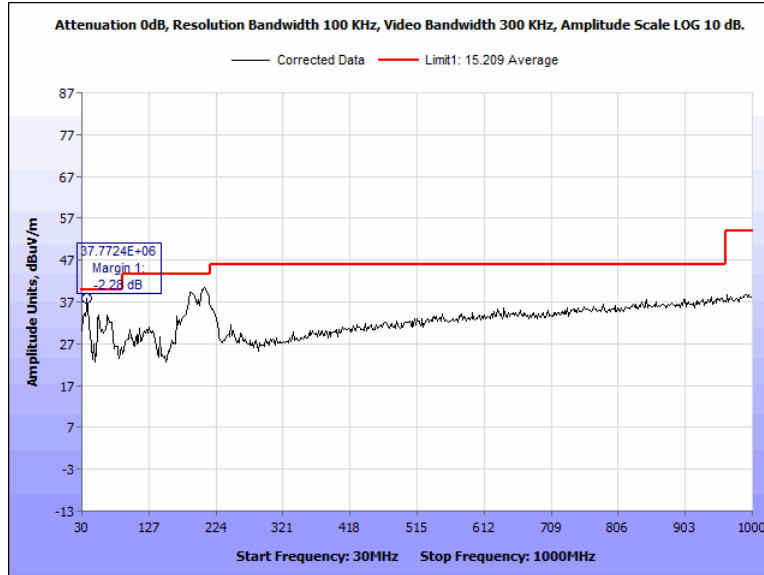

Figure 65: Radiated Spurious Emissions, Pigtail, 2442 MHz, 30 MHz - 1000 MHz, Vertical

Frequency (MHz)	EUT Azimuth (Degrees)	Antenna Polarity (H/V)	Antenna HEIGHT (m)	Uncorrected EMI Meter Reading (dBµV)	Antenna Correction Factor (dB/m) (+)	Distance Correction Factor (dB) (-)	Cable Loss/Pre-amp (dB) (+)	Corrected Amplitude (dBµV/m)	Limit (dBµV/m)	Margin (dB)
36.2179	180.60	H	1.52	31.1	19.29	10.46	-24.61	36.85	40	-3.15
39.3269	181.20	H	1.52	33.28	17.54	10.46	-24.52	36.75	40	-3.25
37.7724	180.60	H	1.53	30.61	18.44	10.46	-24.58	34.92	40	-5.08
37.7724	180.50	V	1.67	33.40	18.44	10.46	-24.58	37.72	40	-2.28
207.2115	180.50	V	1.52	39.00	13.78	10.46	-22.86	40.37	43.5	-3.13
208.7660	180.60	V	1.49	38.80	13.62	10.46	-22.83	40.06	43.5	-3.44

Figure 66: Radiated Spurious Emissions, Pigtail, 2442 MHz, 30 MHz – 1000 MHz

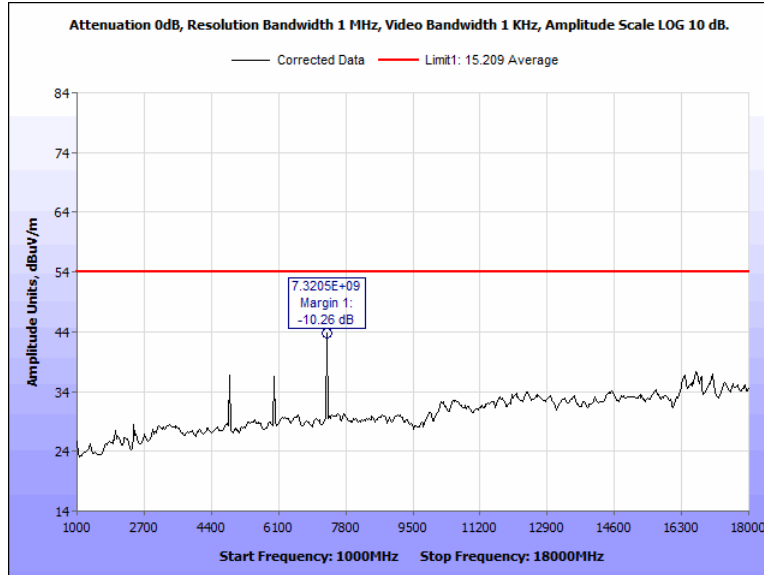

Figure 67: Radiated Spurious Emissions, Pigtail, 2442 MHz, 1 GHz - 18 GHz, Average, Horizontal

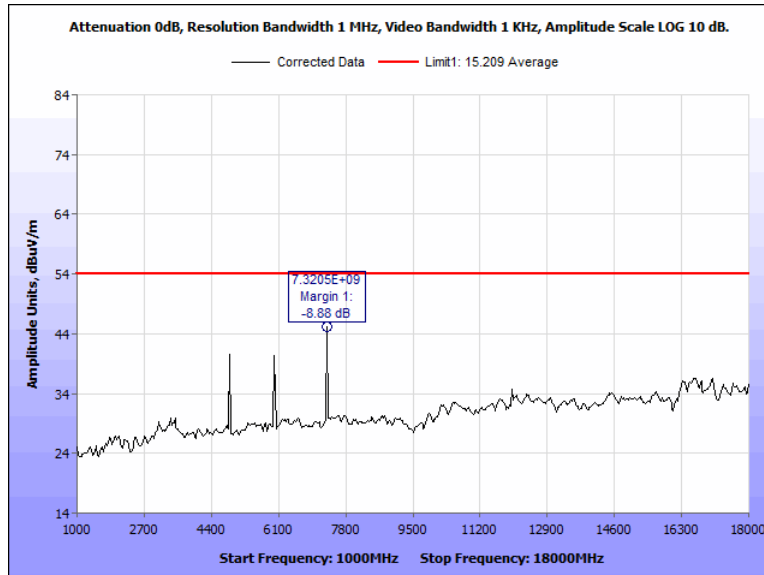

Figure 68: Radiated Spurious Emissions, Pigtail, 2442 MHz, 1 GHz - 18 GHz, Average, Vertical

Frequency (GHz)	EUT Azimuth (Degrees)	Antenna Polarity (H/V)	Antenna HEIGHT (m)	Uncorrected EMI Meter Reading (dBμV)	Antenna Correction Factor (dB/m) (+)	Distance Correction Factor (dB) (-)	Cable Loss/Pre-amp (dB) (+)	Corrected Amplitude (dBμV/m)	Limit (dBμV/m)	Margin (dB)
7.3205	250.00	H	2.30	48.28	35.38	0.00	-39.93	43.74	54	-10.26
16.6651	176.40	H	1.70	38.22	41.12	0.00	-42.10	37.25	54	-16.75
16.6923	180.60	H	1.79	38.21	41.18	0.00	-42.32	37.14	54	-16.86
7.3205	250.00	V	2.30	49.66	35.38	0.00	-39.93	45.12	54	-8.88
4.8686	180.76	V	1.82	45.48	33.75	0.00	-38.67	40.56	54	-13.44
5.9856	180.60	V	1.86	45.15	34.89	0.00	-39.69	40.34	54	-13.66

Figure 69: Radiated Spurious Emissions, Pigtail, 2442 MHz, 1 GHz – 18 GHz, Test Results

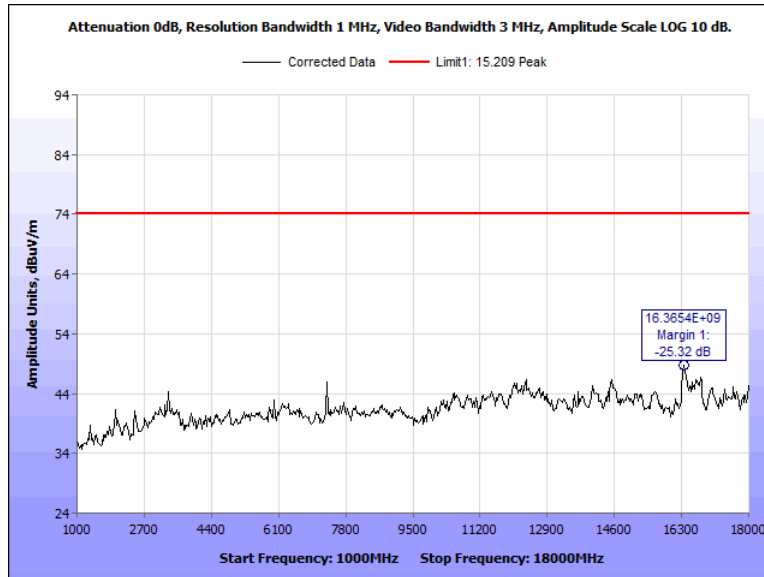

Figure 70: Radiated Spurious Emissions, Pigtail, 2442 MHz, 1 GHz - 18 GHz, Peak, Horizontal

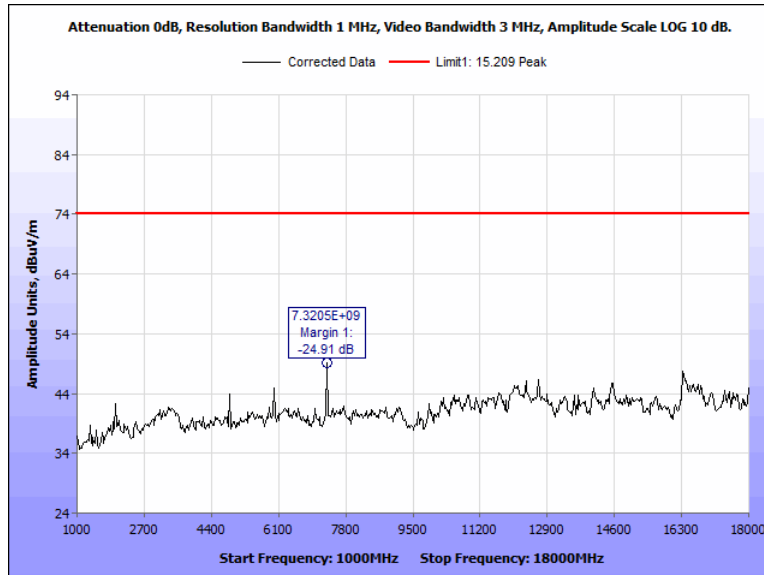

Figure 71: Radiated Spurious Emissions, Pigtail, 2442 MHz, 1 GHz - 18 GHz, Peak, Vertical

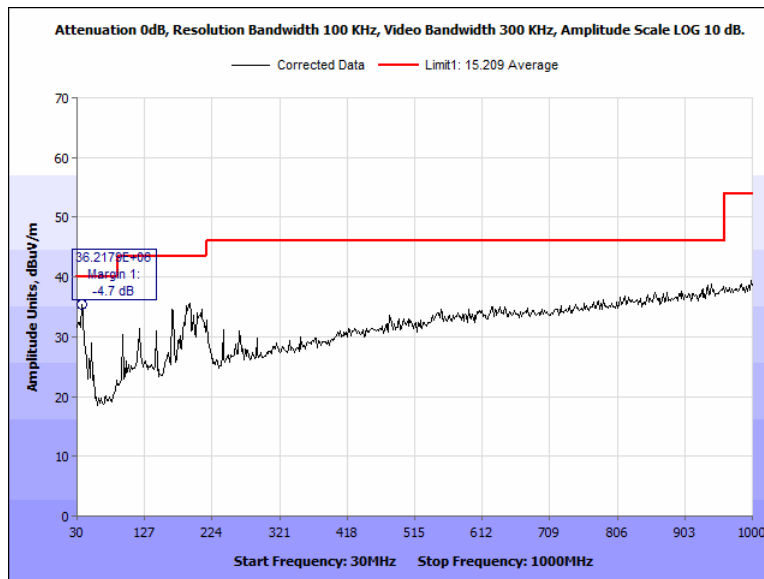

Figure 72: Radiated Spurious Emissions, Pigtail, 2480 MHz, 30 MHz - 1000 MHz, Horizontal

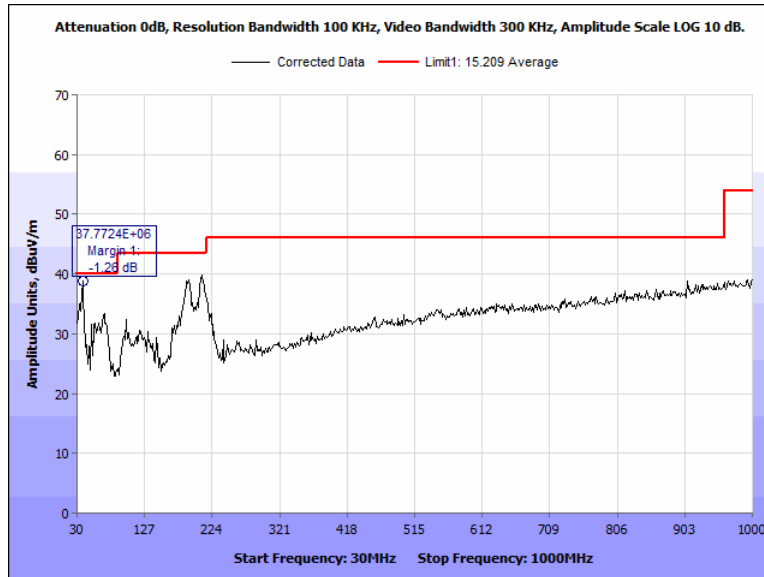

Figure 73: Radiated Spurious Emissions, Pigtail, 2480 MHz, 30 MHz - 1000 MHz, Vertical

Frequency (MHz)	EUT Azimuth (Degrees)	Antenna Polarity (H/V)	Antenna HEIGHT (m)	Uncorrected EMI Meter Reading (dBµV)	Antenna Correction Factor (dB/m) (+)	Distance Correction Factor (dB) (-)	Cable Loss/Pre-amp (dB) (+)	Corrected Amplitude (dBµV/m)	Limit (dBµV/m)	Margin (dB)
36.2179	180.60	H	1.52	30.16	19.29	10.46	-24.61	35.30	40	-4.70
37.7724	180.60	H	1.53	30.33	18.44	10.46	-24.58	34.65	40	-5.35
39.3269	181.20	H	1.52	29.91	17.54	10.46	-24.52	33.39	40	-6.61
37.7724	180.50	V	1.67	34.43	18.44	10.46	-24.58	38.74	40	-1.26
36.2179	178.50	V	1.47	31.46	19.29	10.46	-24.61	36.60	40	-3.40
208.7660	180.60	V	1.49	38.56	13.62	10.46	-22.83	39.81	43.5	-3.69

Figure 74: Radiated Spurious Emissions, Pigtail, 2480 MHz, 30 MHz – 1000 MHz

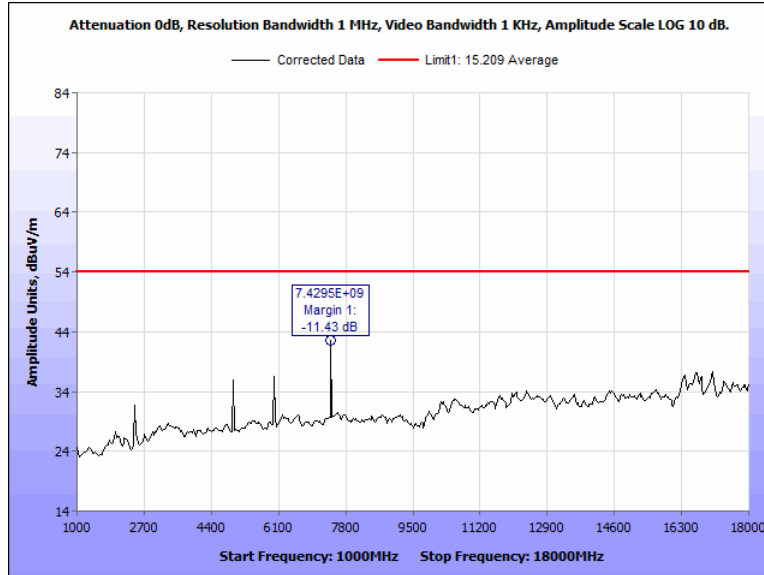

Figure 75: Radiated Spurious Emissions, Pigtail, 2480 MHz, 1 GHz - 18 GHz, Average, Horizontal

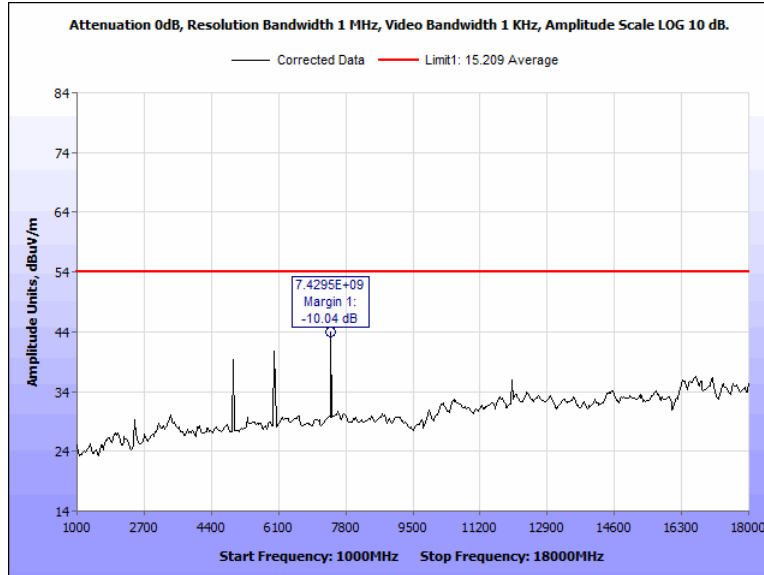

Figure 76: Radiated Spurious Emissions, Pigtail, 2480 MHz, 1 GHz - 18 GHz, Average, Vertical

Frequency (GHz)	EUT Azimuth (Degrees)	Antenna Polarity (H/V)	Antenna HEIGHT (m)	Uncorrected EMI Meter Reading (dBμV)	Antenna Correction Factor (dB/m) (+)	Distance Correction Factor (dB) (-)	Cable Loss/Pre-amp (dB) (+)	Corrected Amplitude (dBμV/m)	Limit (dBμV/m)	Margin (dB)
7.4295	250.00	H	2.30	46.74	35.38	0.00	-39.55	42.57	54	-11.43
17.0737	37.69	H	2.27	37.96	40.91	0.00	-41.55	37.32	54	-16.68
16.6651	176.40	H	1.70	38.06	41.12	0.00	-42.10	37.09	54	-16.91
7.4295	250.00	H	2.30	48.12	35.38	0.00	-39.55	43.96	54	-10.04
5.9856	180.60	V	1.86	45.59	34.89	0.00	-39.69	40.79	54	-13.21
4.9503	230.50	V	1.84	44.47	33.76	0.00	-38.80	39.43	54	-14.57

Figure 77: Radiated Spurious Emissions, Pigtail, 2480 MHz, 1 GHz – 18 GHz, Test Results

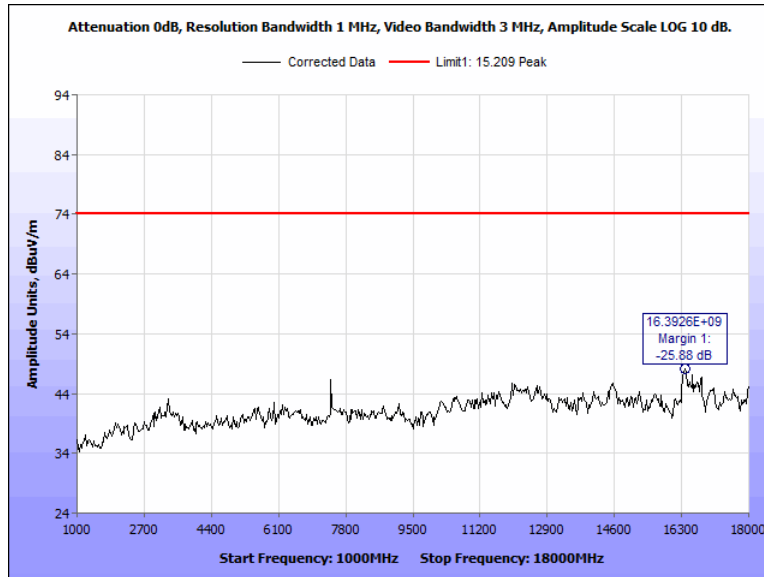

Figure 78: Radiated Spurious Emissions, Pigtail, 2480 MHz, 1 GHz - 18 GHz, Peak, Horizontal

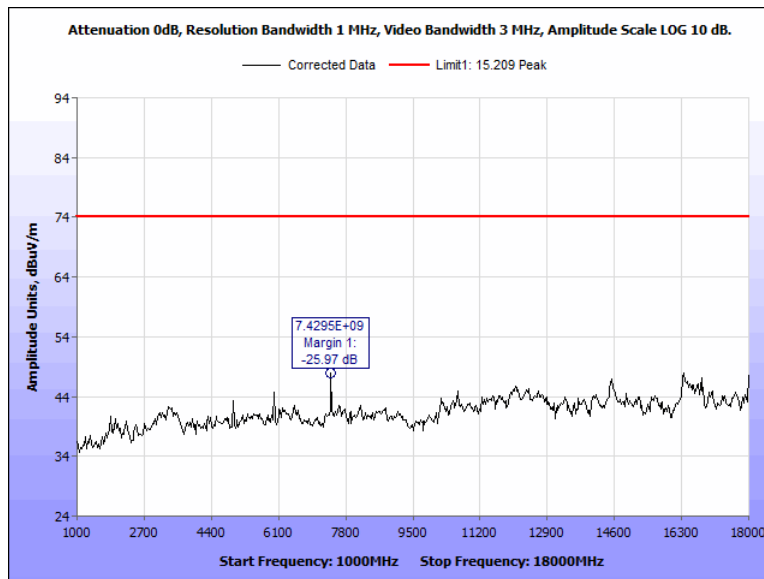

Figure 79: Radiated Spurious Emissions, Pigtail, 2480 MHz, 1 GHz - 18 GHz, Peak, Vertical

Model: 40K Terminal

Test Results: The EUT was tested is **compliant** with § 15.209 Radiated Spurious Emissions Requirements and Band Edge. No anomalies were noted.

Test Engineer: Jonathan Tavira

Test Date: September 26, 2019

Test Data, Model: 40K Terminal

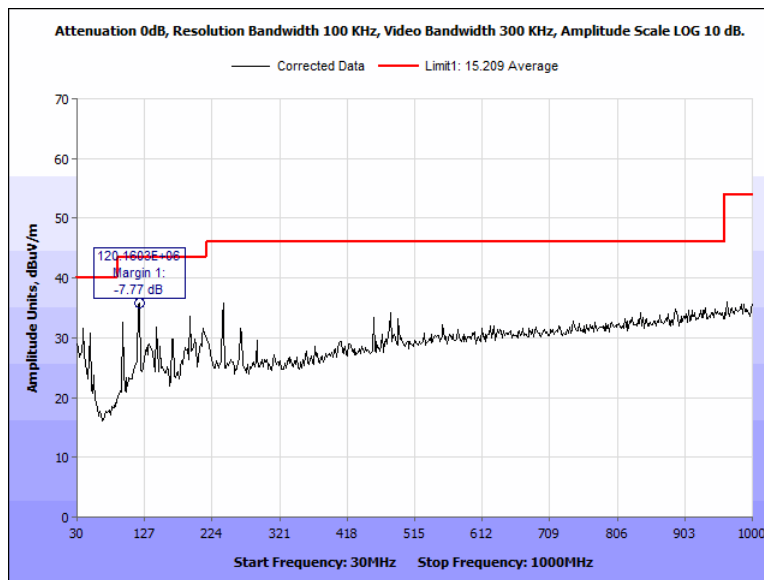

Figure 80: Radiated Spurious Emissions, Terminal, 2402 MHz, 30 MHz - 1000 MHz, Horizontal

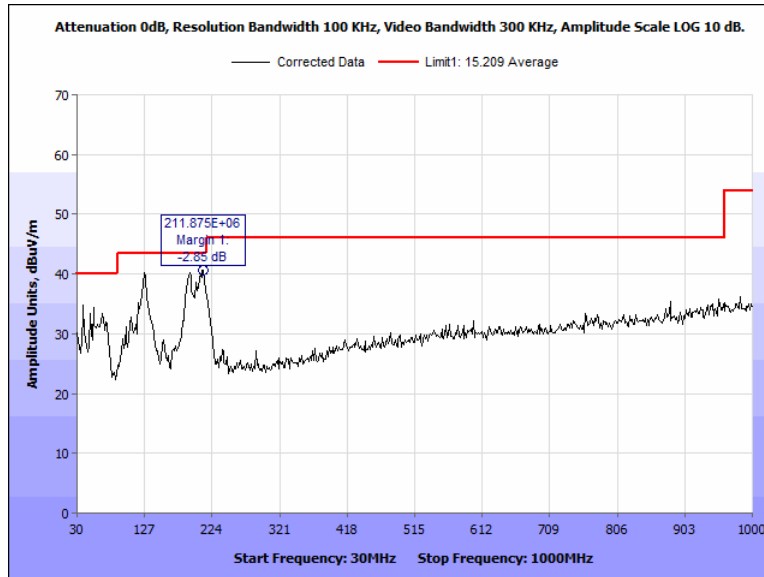

Figure 81: Radiated Spurious Emissions, Terminal, 2402 MHz, 30 MHz - 1000 MHz, Vertical

Frequency (MHz)	EUT Azimuth (Degrees)	Antenna Polarity (H/V)	Antenna HEIGHT (m)	Uncorrected EMI Meter Reading (dBµV)	Antenna Correction Factor (dB/m) (+)	Distance Correction Factor (dB) (-)	Cable Loss/Pre-amp (dB) (+)	Corrected Amplitude (dBµV/m)	Limit (dBµV/m)	Margin (dB)
120.1603	176.65	H	2.56	32.86	15.92	10.46	-23.51	35.73	43.5	-7.77
118.6058	177.50	H	2.67	32.41	16.04	10.46	-23.53	35.39	43.5	-8.11
39.3269	180.60	H	1.53	28.48	17.14	10.46	-24.52	31.55	40	-8.45
211.8750	180.50	V	1.67	38.79	14.21	10.46	-22.81	40.65	43.5	-2.85
210.3205	180.50	V	1.52	38.56	14.37	10.46	-22.80	40.59	43.5	-2.91
191.6667	179.60	V	1.72	38.83	14.00	10.46	-22.98	40.31	43.5	-3.19

Figure 82: Radiated Spurious Emissions, Terminal, 2402 MHz, 30 MHz – 1000 MHz

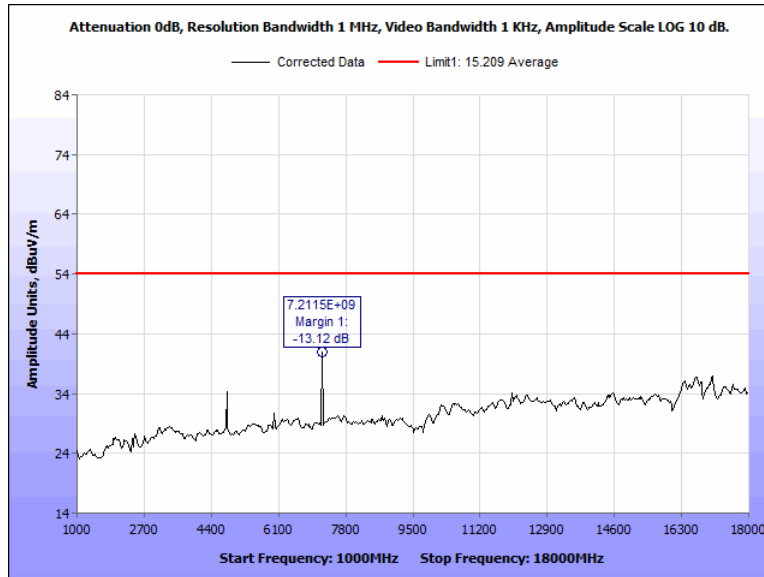

Figure 83: Radiated Spurious Emissions, Terminal, 2402 MHz, 1 GHz - 18 GHz, Average, Horizontal

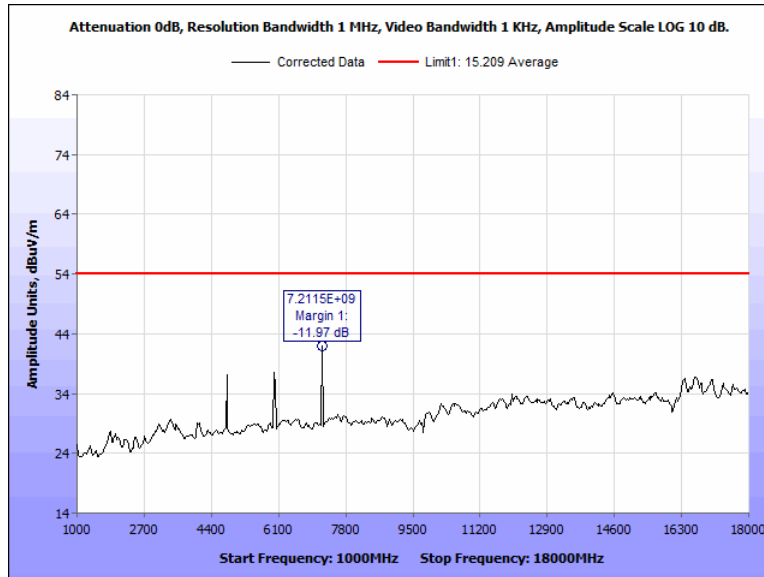

Figure 84: Radiated Spurious Emissions, Terminal, 2402 MHz, 1 GHz - 18 GHz, Average, Vertical

Frequency (GHz)	EUT Azimuth (Degrees)	Antenna Polarity (H/V)	Antenna HEIGHT (m)	Uncorrected EMI Meter Reading (dBμV)	Antenna Correction Factor (dB/m) (+)	Distance Correction Factor (dB) (-)	Cable Loss/Pre-amp (dB) (+)	Corrected Amplitude (dBμV/m)	Limit (dBμV/m)	Margin (dB)
7.2115	250.00	H	1.65	45.50	35.38	0.00	-40.00	40.88	54	-13.12
16.3381	37.69	H	2.27	36.26	40.50	0.00	-41.16	35.59	54	-18.41
16.3654	176.40	H	1.70	36.46	40.53	0.00	-41.10	35.89	54	-18.11
4.7869	250.00	H	1.80	41.80	33.81	0.00	-38.46	37.15	54	-16.85
5.9856	180.60	V	1.86	42.35	34.89	0.00	-39.69	37.54	54	-16.46
7.2115	230.50	V	1.84	46.64	35.38	0.00	-40.00	42.03	54	-11.97

Figure 85: Radiated Spurious Emissions, Terminal, 2402 MHz, 1 GHz – 18 GHz, Test Results

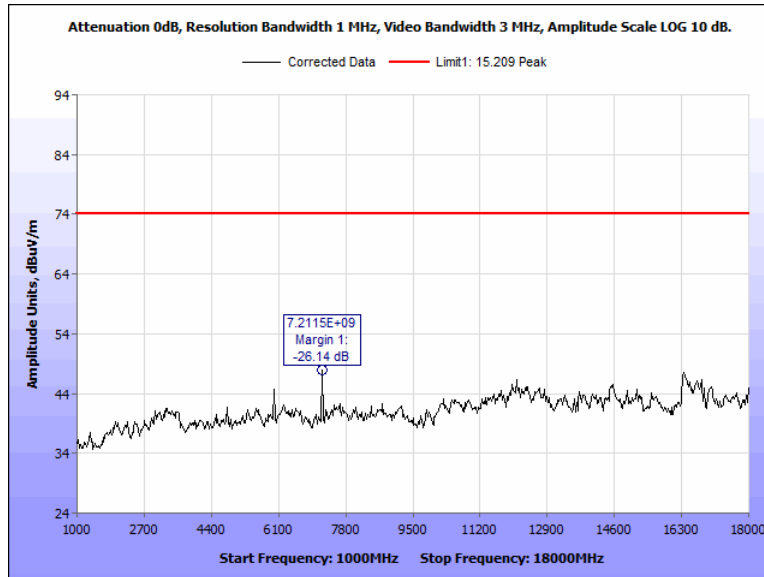

Figure 86: Radiated Spurious Emissions, Terminal, 2402 MHz, 1 GHz - 18 GHz, Peak, Horizontal

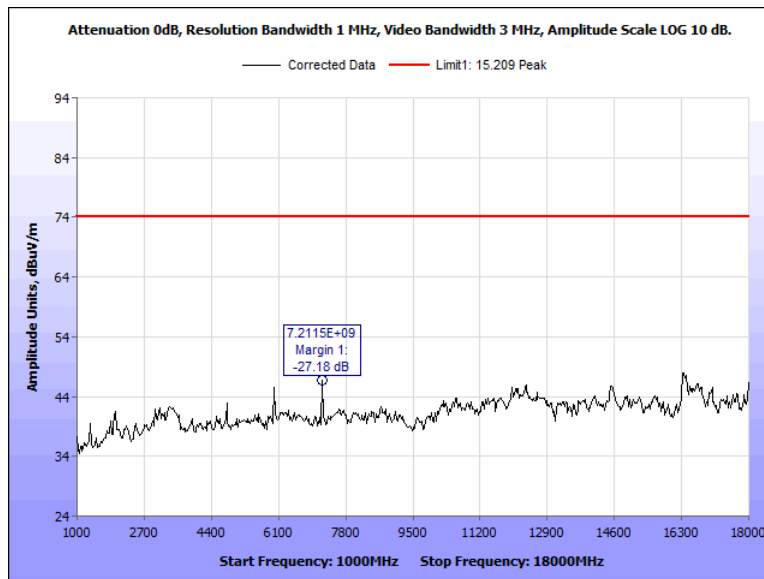

Figure 87: Radiated Spurious Emissions, Terminal, 2402 MHz, 1 GHz - 18 GHz, Peak, Vertical

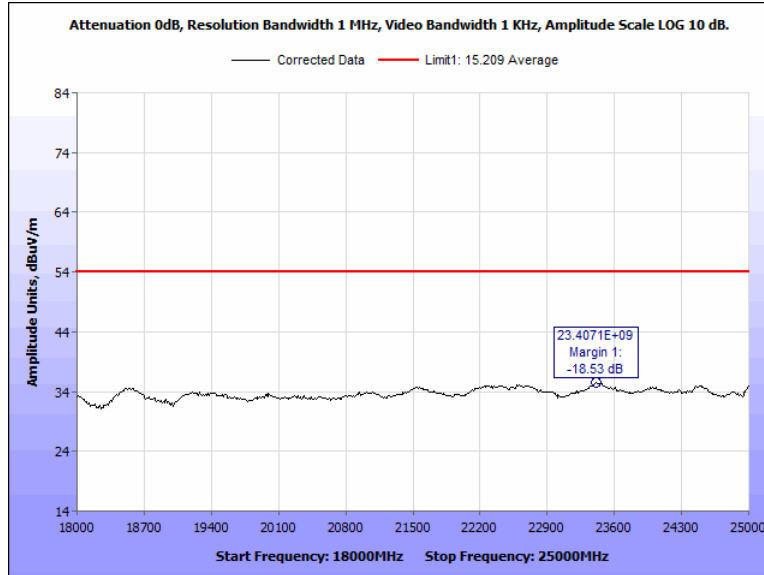

Figure 88: Radiated Spurious Emissions, Terminal, 2402 MHz, 18 GHz - 25 GHz, Average, Horizontal

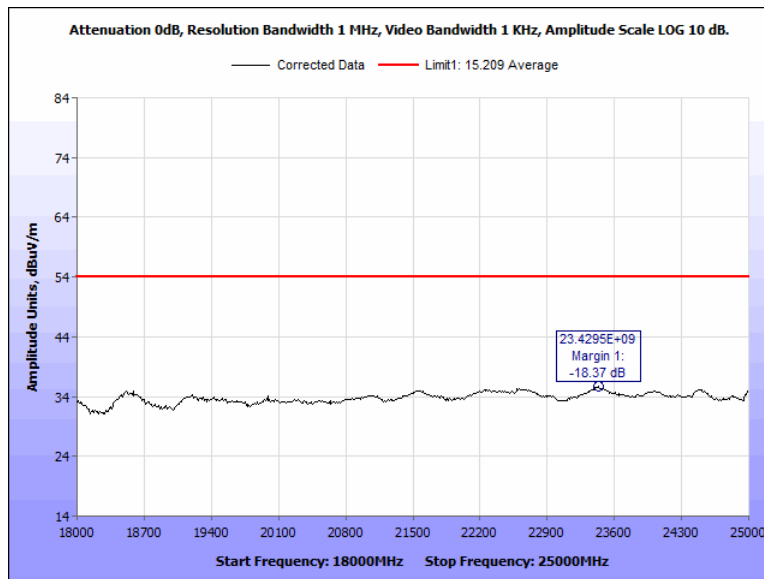

Figure 89: Radiated Spurious Emissions, Terminal, 2402 MHz, 18 GHz - 25 GHz, Average, Vertical

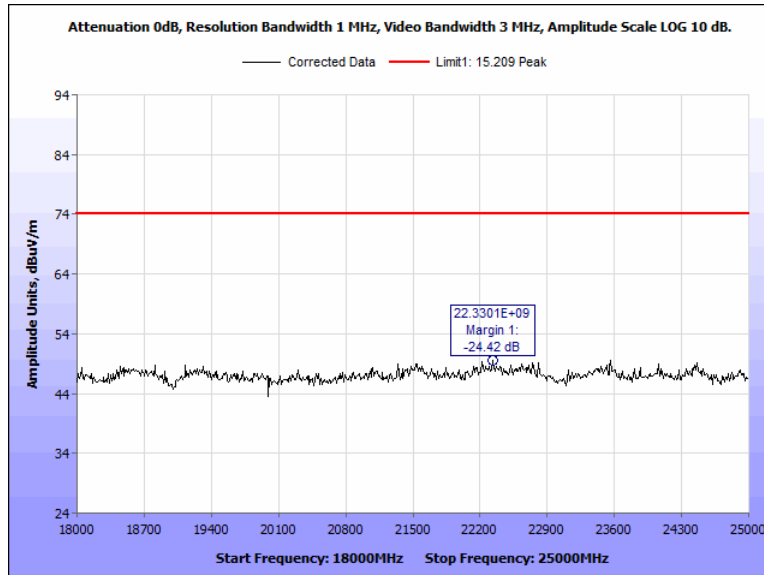

Figure 90: Radiated Spurious Emissions, Terminal, 2402 MHz, 18 GHz - 25 GHz, Peak, Horizontal

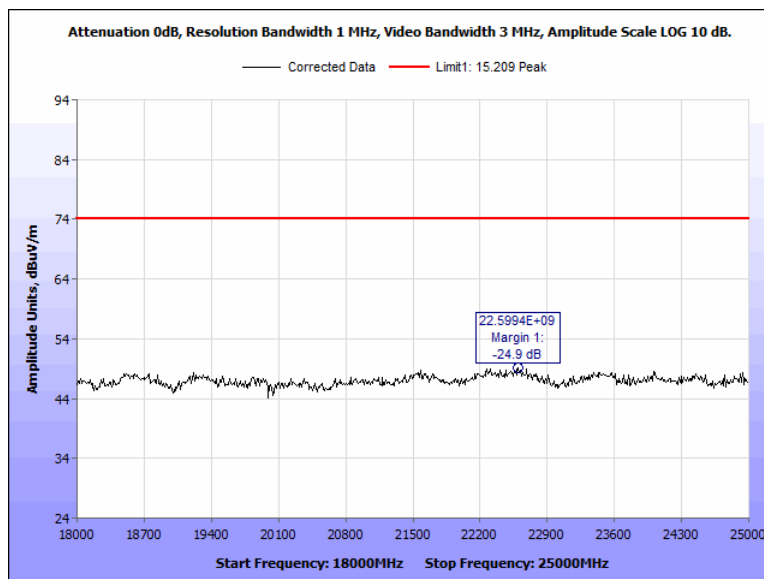

Figure 91: Radiated Spurious Emissions, Terminal, 2402 MHz, 18 GHz - 25 GHz, Peak, Vertical

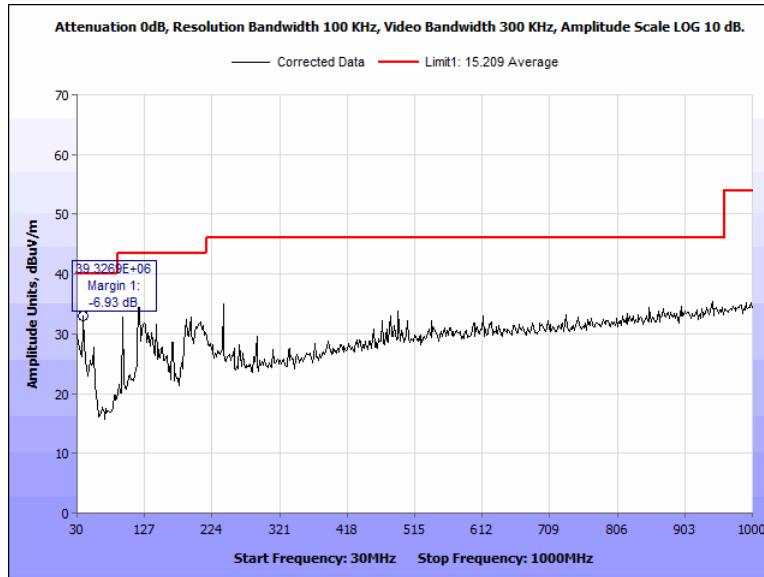

Figure 92: Radiated Spurious Emissions, Terminal, 2442 MHz, 30 MHz - 1000 MHz, Horizontal

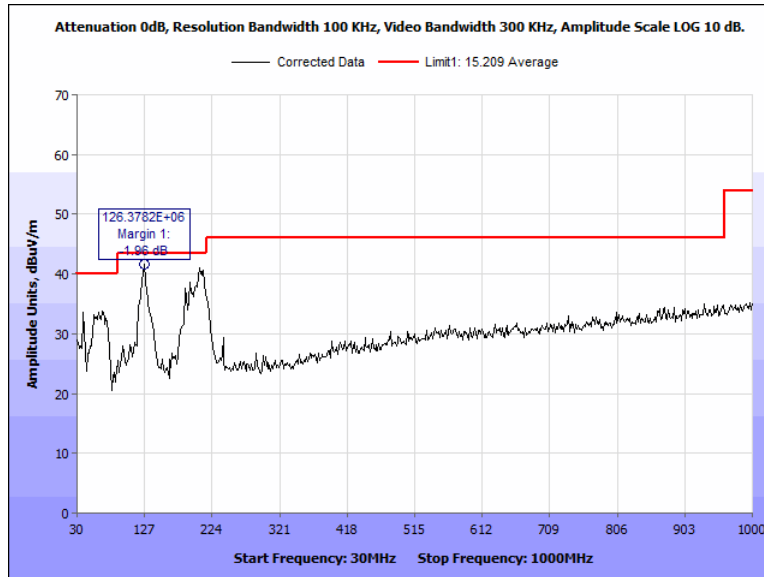

Figure 93: Radiated Spurious Emissions, Terminal, 2442 MHz, 30 MHz - 1000 MHz, Vertical

Frequency (MHz)	EUT Azimuth (Degrees)	Antenna Polarity (H/V)	Antenna HEIGHT (m)	Uncorrected EMI Meter Reading (dBµV)	Antenna Correction Factor (dB/m) (+)	Distance Correction Factor (dB) (-)	Cable Loss/Pre-amp (dB) (+)	Corrected Amplitude (dBµV/m)	Limit (dBµV/m)	Margin (dB)
39.3269	181.20	H	1.52	29.99	17.54	10.46	-24.52	33.07	40	-6.93
205.6571	156.10	H	1.64	38.98	14.57	10.46	-22.90	41.11	43.50	-2.39
37.7724	180.60	H	1.53	27.59	18.44	10.46	-24.58	30.91	40	-9.09
126.3782	173.60	V	1.45	38.64	15.94	10.46	-23.50	41.50	40	-1.96
207.2115	180.50	V	1.52	39.00	13.78	10.46	-22.86	40.37	43.5	-3.13
208.7660	180.60	V	1.49	38.80	13.62	10.46	-22.83	40.06	43.5	-3.44

Figure 94: Radiated Spurious Emissions, Terminal, 2442 MHz, 30 MHz – 1000 MHz

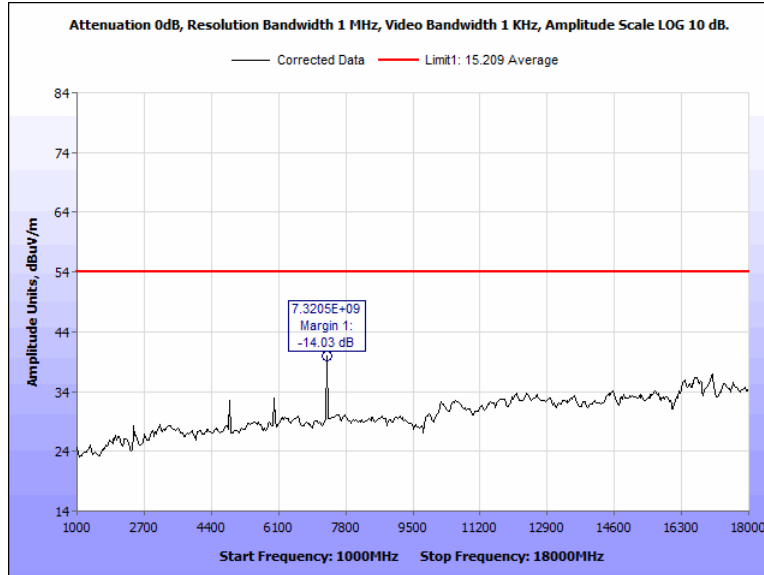

Figure 95: Radiated Spurious Emissions, Terminal, 2442 MHz, 1 GHz - 18 GHz, Average, Horizontal

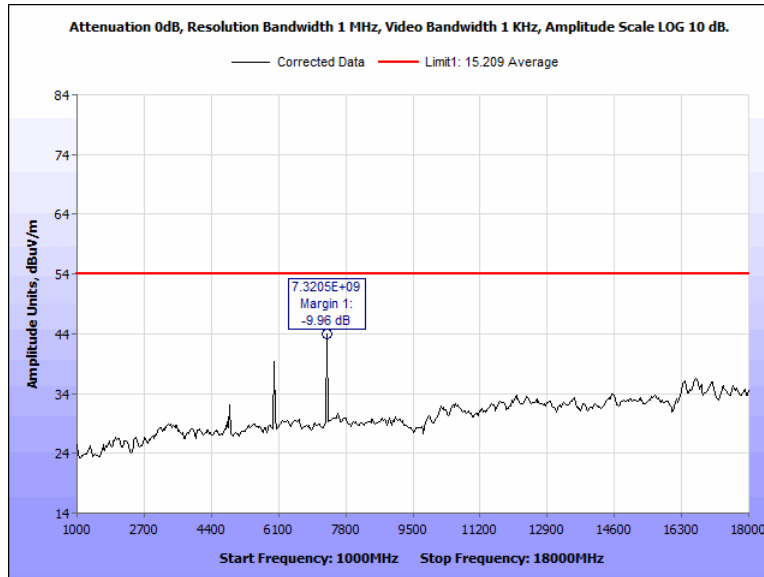

Figure 96: Radiated Spurious Emissions, Terminal, 2442 MHz, 1 GHz - 18 GHz, Average, Vertical

Frequency (GHz)	EUT Azimuth (Degrees)	Antenna Polarity (H/V)	Antenna HEIGHT (m)	Uncorrected EMI Meter Reading (dBµV)	Antenna Correction Factor (dB/m) (+)	Distance Correction Factor (dB) (-)	Cable Loss/Pre-amp (dB) (+)	Corrected Amplitude (dBµV/m)	Limit (dBµV/m)	Margin (dB)
7.4295	250.00	H	1.76	47.31	35.38	0.00	-39.55	43.15	54	-10.85
17.0737	176.40	H	1.70	37.50	40.91	0.00	-41.55	36.87	54	-17.13
17.0465	180.60	H	1.79	37.19	40.95	0.00	-41.60	36.55	54	-17.45
7.4295	250.00	V	2.30	51.45	35.38	0.00	-39.55	47.29	54	-6.71
5.9856	180.76	V	1.82	43.98	34.89	0.00	-39.69	39.18	54	-14.82
16.6651	180.60	V	1.86	37.66	41.12	0.00	-42.10	36.69	54	-17.31

Figure 97: Radiated Spurious Emissions, Terminal, 2442 MHz, 1 GHz – 18 GHz, Test Results

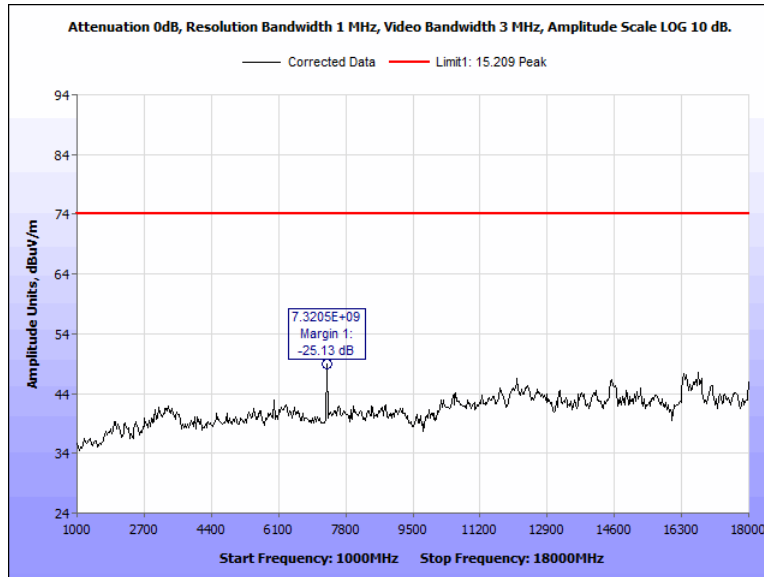

Figure 98: Radiated Spurious Emissions, Terminal, 2442 MHz, 1 GHz - 18 GHz, Peak, Horizontal

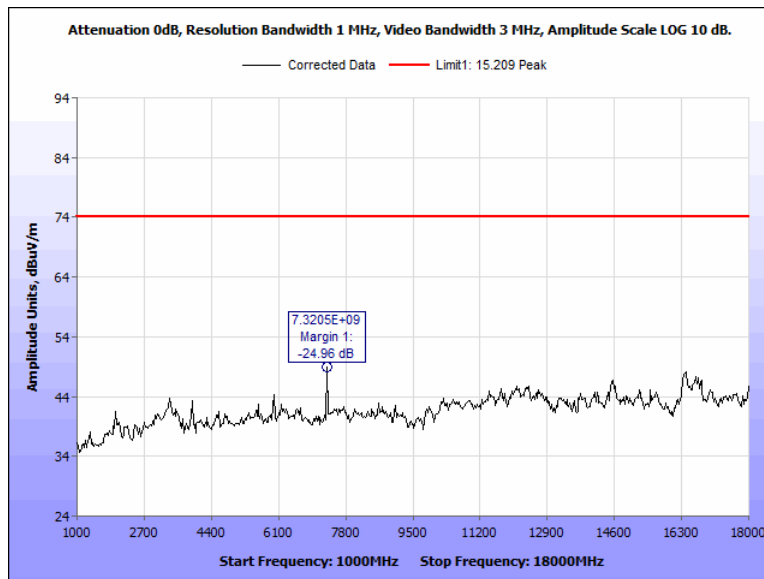

Figure 99: Radiated Spurious Emissions, Terminal, 2442 MHz, 1 GHz - 18 GHz, Peak, Vertical

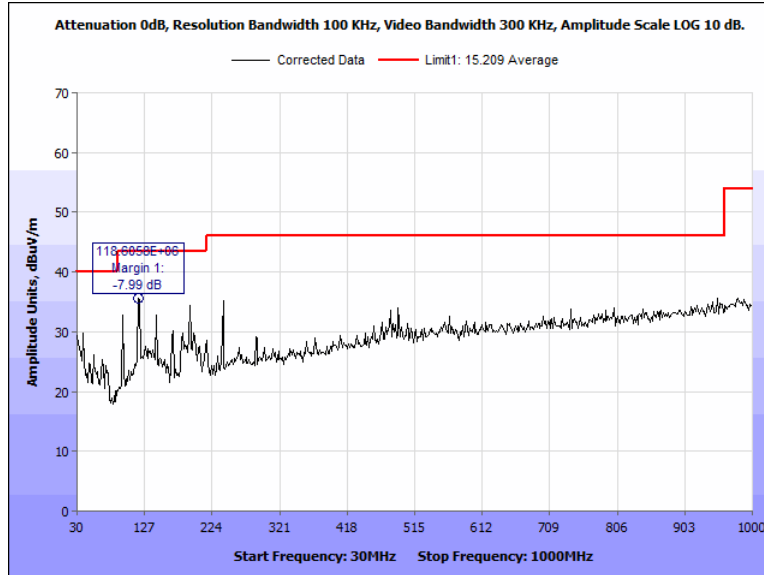

Figure 100: Radiated Spurious Emissions, Terminal, 2480 MHz, 30 MHz - 1000 MHz, Horizontal

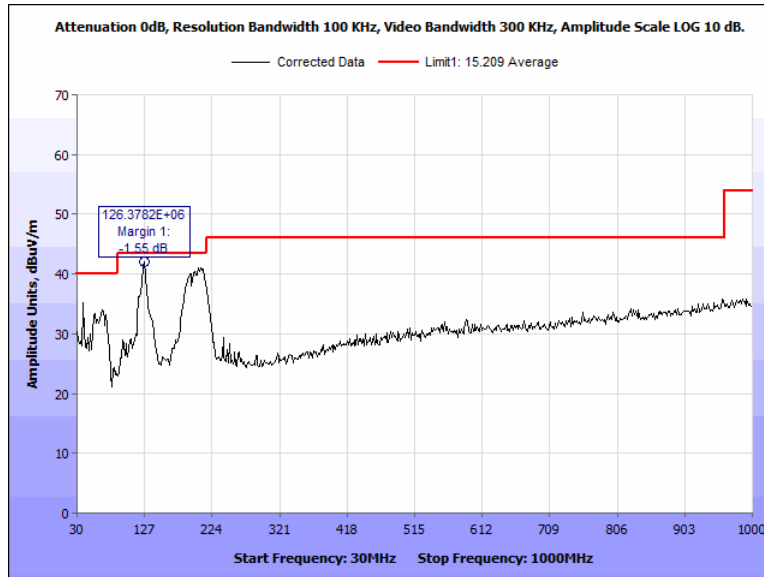

Figure 101: Radiated Spurious Emissions, Terminal, 2480 MHz, 30 MHz - 1000 MHz, Vertical

Frequency (MHz)	EUT Azimuth (Degrees)	Antenna Polarity (H/V)	Antenna HEIGHT (m)	Uncorrected EMI Meter Reading (dBµV)	Antenna Correction Factor (dB/m) (+)	Distance Correction Factor (dB) (-)	Cable Loss/Pre-amp (dB) (+)	Corrected Amplitude (dBµV/m)	Limit (dBµV/m)	Margin (dB)
118.6058	180.60	H	1.52	32.53	16.04	10.46	-23.53	35.51	43.5	-7.99
120.1603	180.60	H	1.61	32.62	15.92	10.46	-23.51	35.49	43.5	-8.01
191.6667	181.20	H	1.52	32.91	14.00	10.46	-22.98	34.39	43.5	-9.11
126.3782	173.56	V	1.77	39.05	15.94	10.46	-23.50	41.95	43.5	-1.55
124.8237	178.50	V	1.47	38.27	16.00	10.46	-23.50	41.23	43.5	-2.27
204.1026	180.60	V	1.49	39.19	14.41	10.46	-22.94	41.13	43.5	-2.37

Figure 102: Radiated Spurious Emissions, Terminal, 2480 MHz, 30 MHz – 1000 MHz

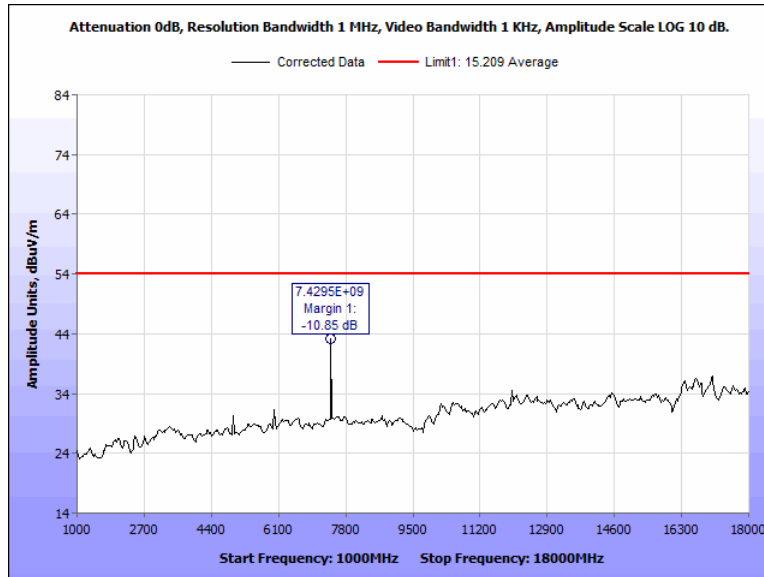

Figure 103: Radiated Spurious Emissions, Terminal, 2480 MHz, 1 GHz - 18 GHz, Average, Horizontal

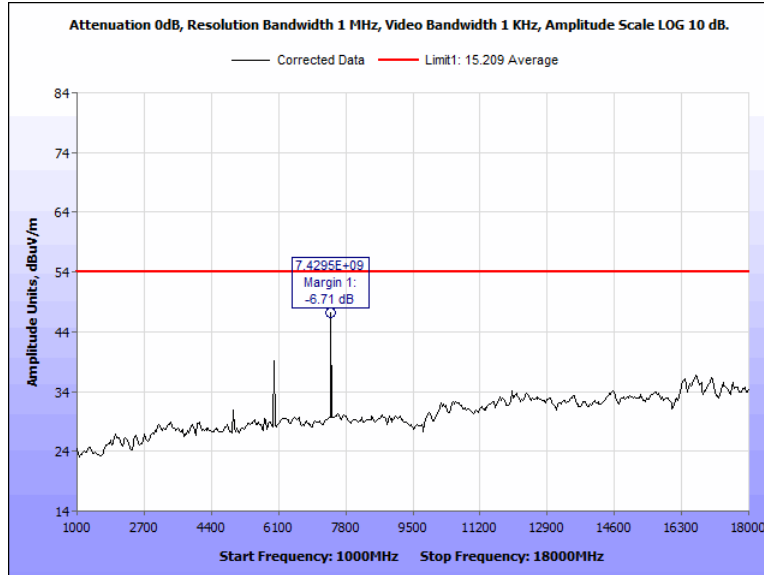

Figure 104: Radiated Spurious Emissions, Terminal, 2480 MHz, 1 GHz - 18 GHz, Average, Vertical

Frequency (GHz)	EUT Azimuth (Degrees)	Antenna Polarity (H/V)	Antenna HEIGHT (m)	Uncorrected EMI Meter Reading (dBµV)	Antenna Correction Factor (dB/m) (+)	Distance Correction Factor (dB) (-)	Cable Loss/Pre-amp (dB) (+)	Corrected Amplitude (dBµV/m)	Limit (dBµV/m)	Margin (dB)
7.4295	250.00	H	2.30	47.31	35.38	0.00	-39.55	43.15	54	-10.85
17.0737	37.69	H	1.65	37.50	40.91	0.00	-41.55	40.91	54	-17.13
17.0465	176.40	H	1.70	37.19	40.95	0.00	-41.60	36.55	54	-17.45
7.4295	250.00	V	2.30	51.45	35.38	0.00	-39.55	47.29	54	-6.71
5.9856	180.60	V	1.86	43.98	34.89	0.00	-39.69	39.18	54	-14.82
16.6651	230.50	V	2.14	37.66	41.12	0.00	-42.10	36.69	54	-17.31

Figure 105: Radiated Spurious Emissions, Terminal, 2480 MHz, 1 GHz – 18 GHz, Test Results

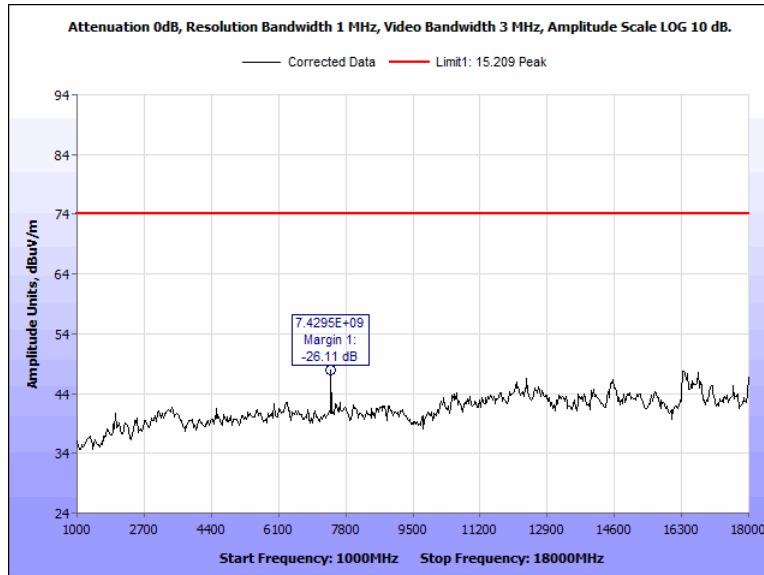

Figure 106: Radiated Spurious Emissions, Terminal, 2480 MHz, 1 GHz - 18 GHz, Peak, Horizontal

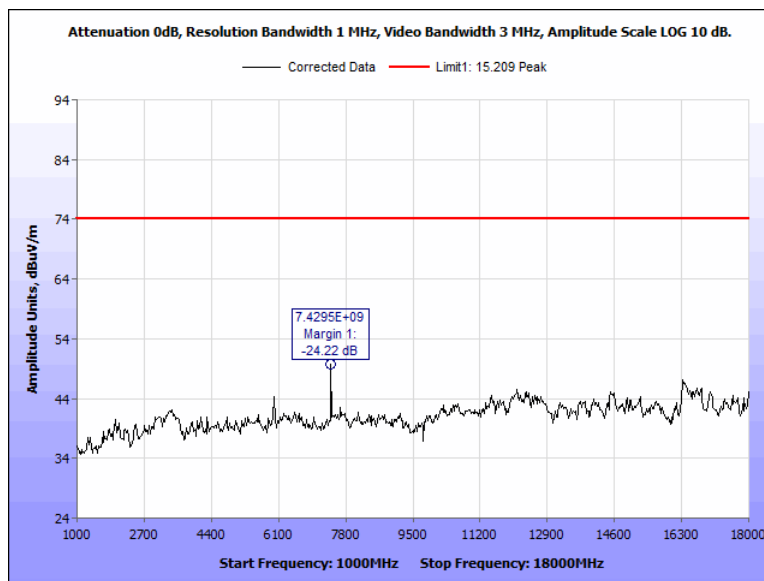

Figure 107: Radiated Spurious Emissions, Terminal, 2480 MHz, 1 GHz - 18 GHz, Peak, Vertical

Radiated Band Edge Measurements

Test Procedures: The transmitter was turned on. Measurements were performed of the low and high Channels. The EUT was rotated orthogonally through all three axes. Plots shown are corrected for both antenna correction factor and distance and compared to a 3 m limit line.

Model: 40K Pigtail

Test Results: The EUT was tested was compliant with § 15.205 Restricted Band requirements. No anomalies noted.

Test Engineer: Jonathan Tavira

Test Date: September 26, 2019

Test Data, Model: 40K Pigtail

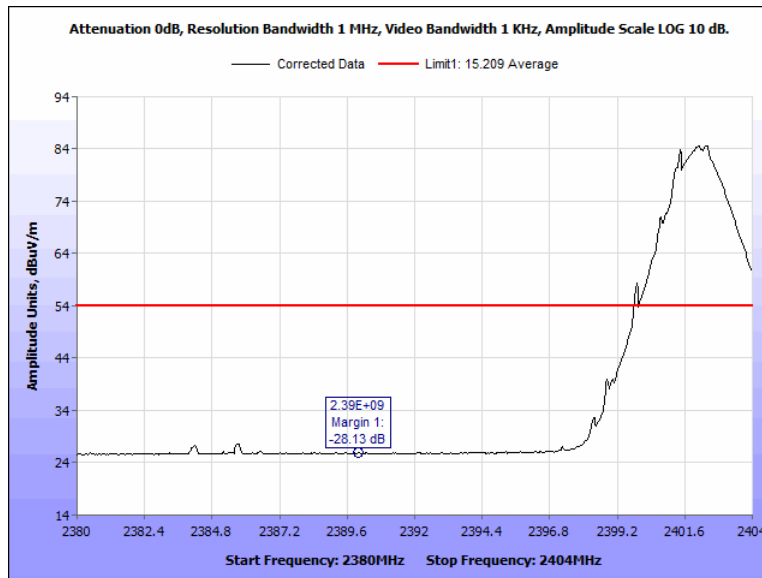

Figure 108: Radiated Band Edge, Pigtail, 2402 MHz, Average, Horizontal

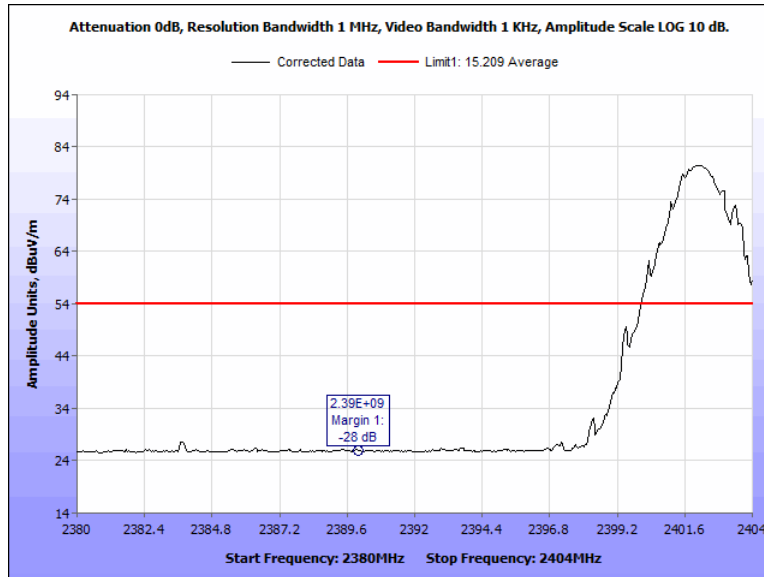

Figure 109: Radiated Band Edge, Pigtail, 2402 MHz, Average, Vertical

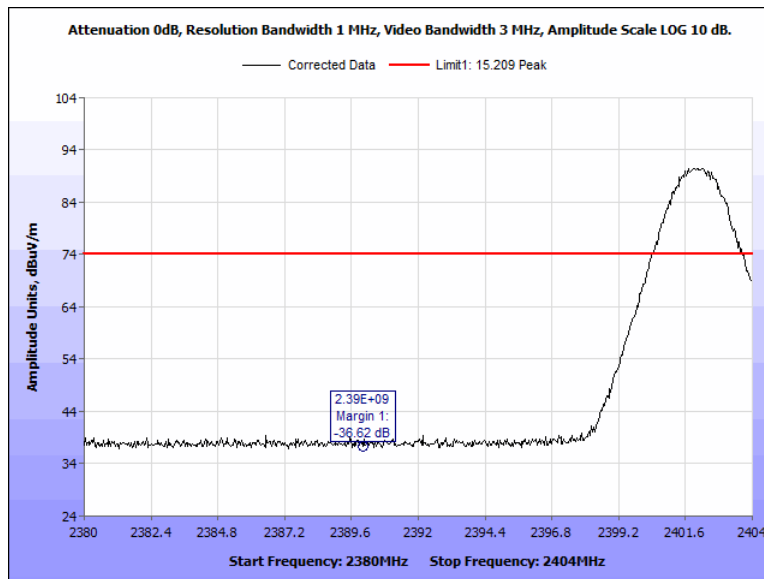

Figure 110: Radiated Band Edge, Pigtail, 2402 MHz, Peak, Horizontal

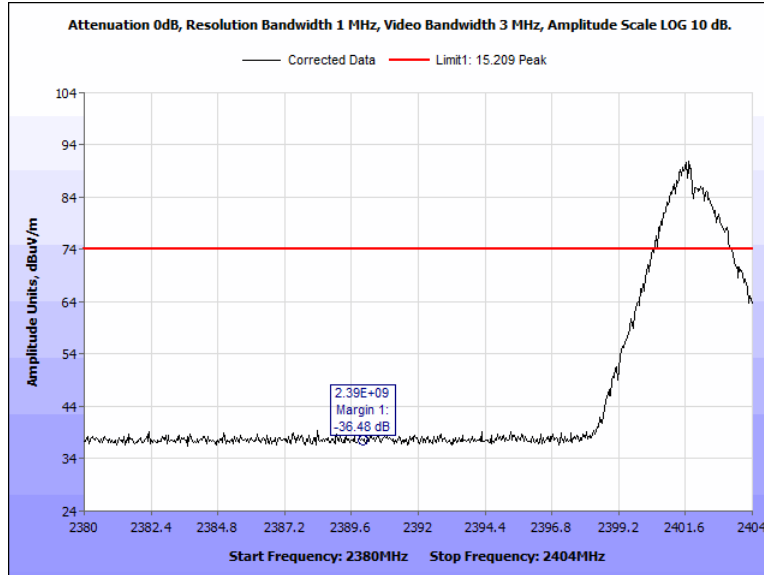

Figure 111: Radiated Band Edge, Pigtail, 2402 MHz, Peak, Vertical

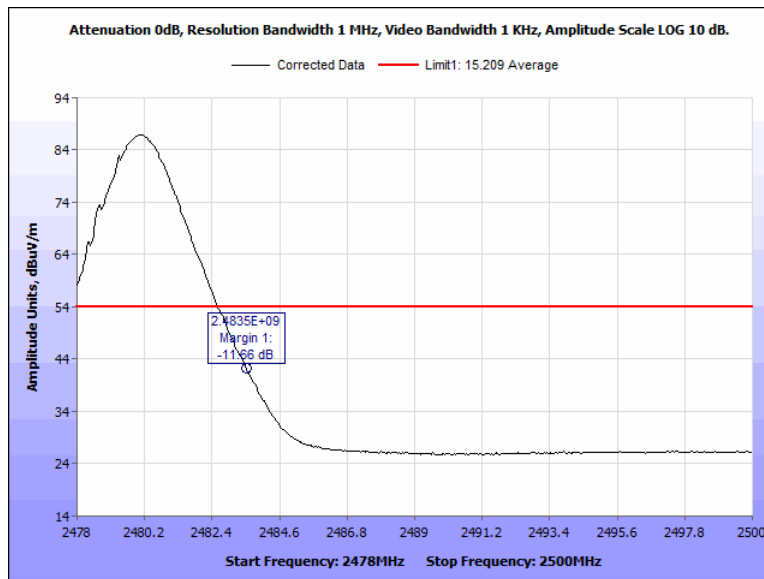

Figure 112: Radiated Band Edge, Pigtail, 2480 MHz, Average, Horizontal

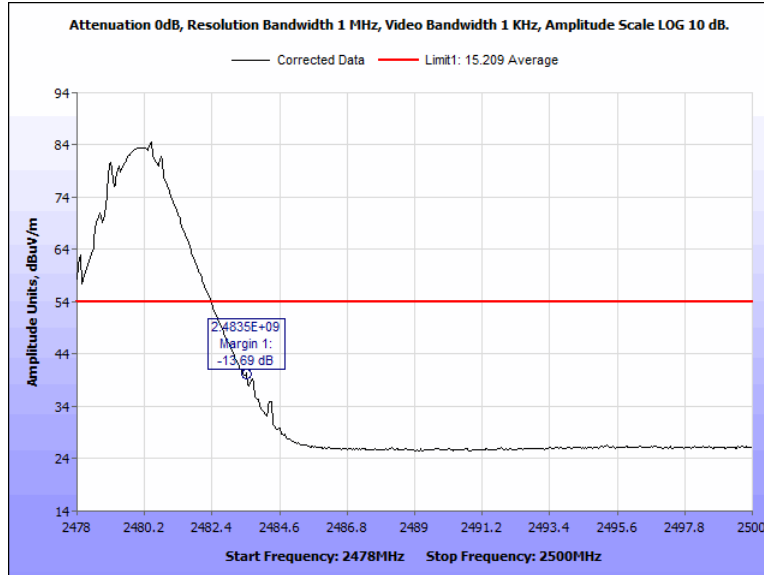

Figure 113: Radiated Band Edge, Pigtail, 2480 MHz, Average, Vertical

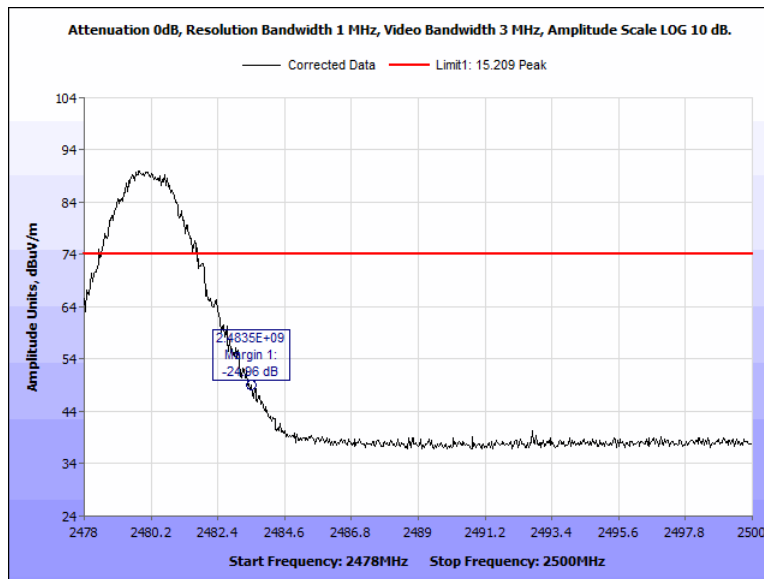

Figure 114: Radiated Band Edge, Pigtail, 2480 MHz, Peak, Horizontal

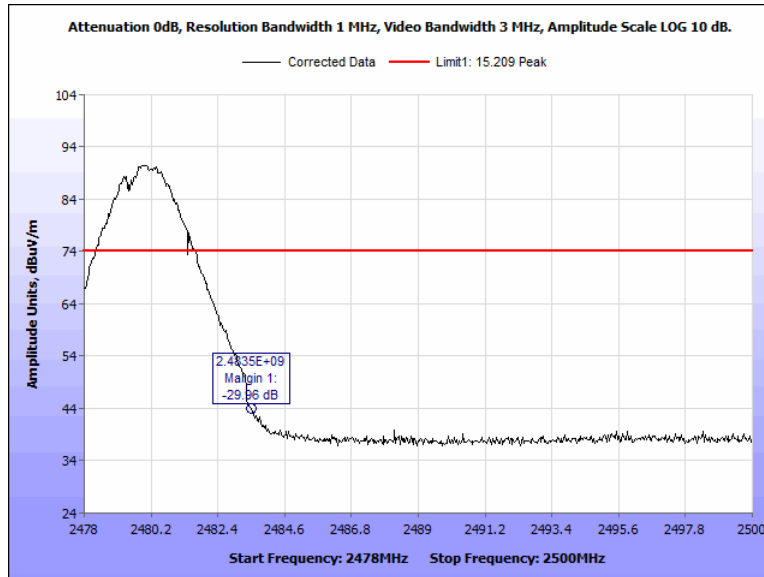

Figure 115: Radiated Band Edge, Pigtail, 2480 MHz, Peak, Vertical

Model: 40K Terminal

Test Results: The EUT was tested was **compliant** with § 15.205 Restricted Band requirements. No anomalies noted.

Test Engineer: Jonathan Tavira

Test Date: September 26, 2019

Test Data, Model: 40K Terminal

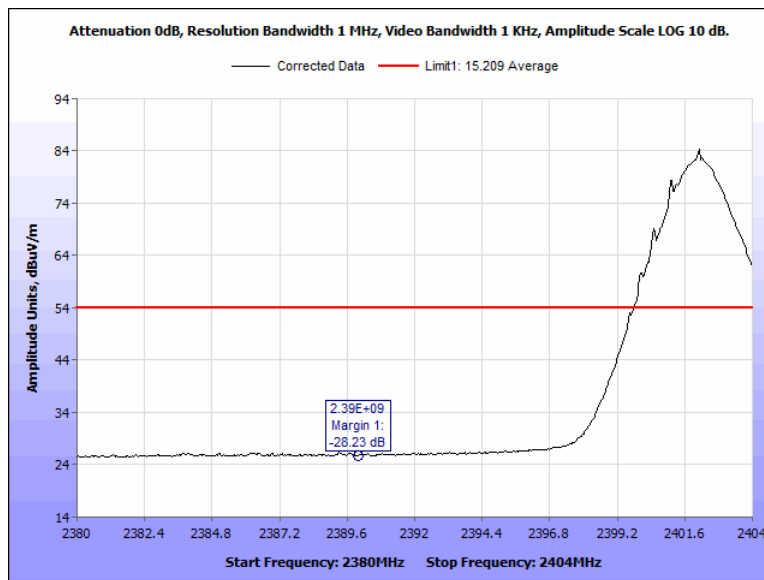

Figure 116: Radiated Band Edge, Terminal, 2402 MHz, Average, Horizontal

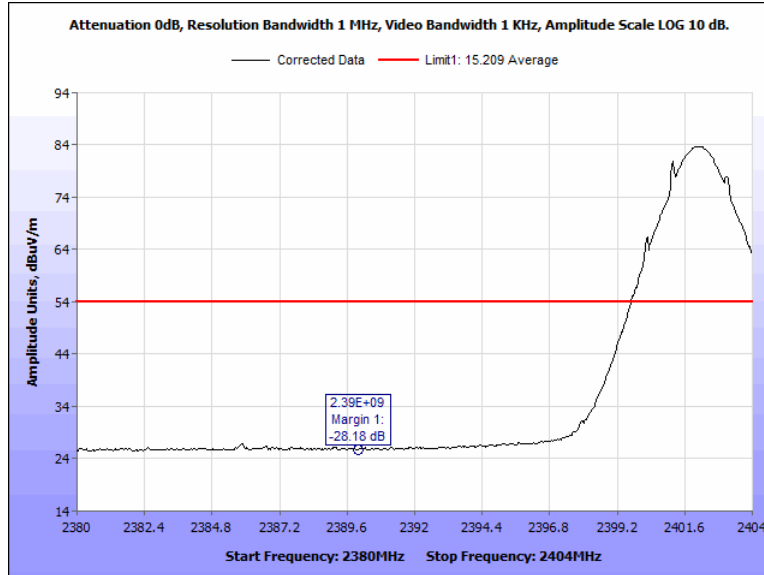

Figure 117: Radiated Band Edge, Terminal, 2402 MHz, Average, Vertical

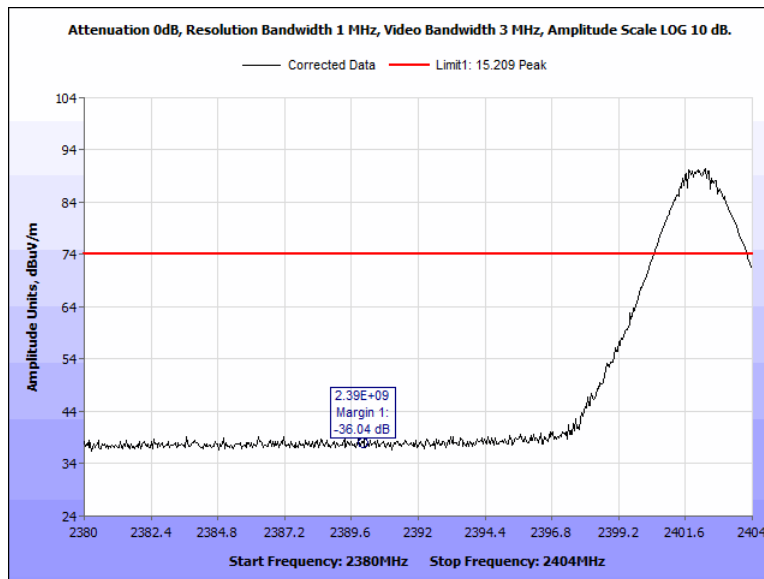

Figure 118: Radiated Band Edge, Terminal, 2402 MHz, Peak, Horizontal

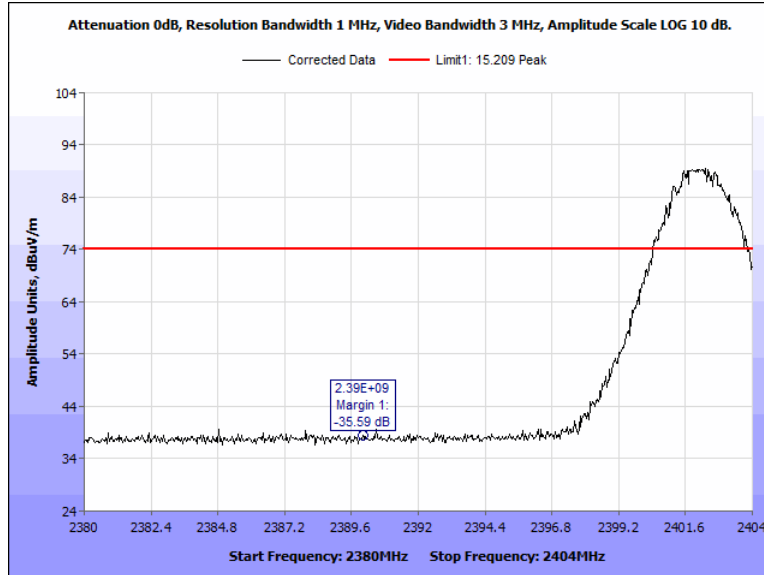

Figure 119: Radiated Band Edge, Terminal, 2402 MHz, Peak, Vertical

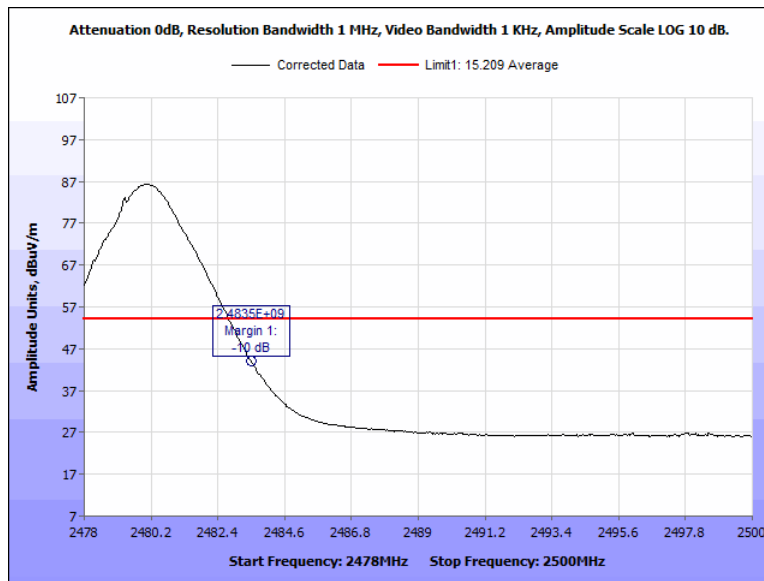

Figure 120: Radiated Band Edge, Terminal, 2480 MHz, Average, Horizontal

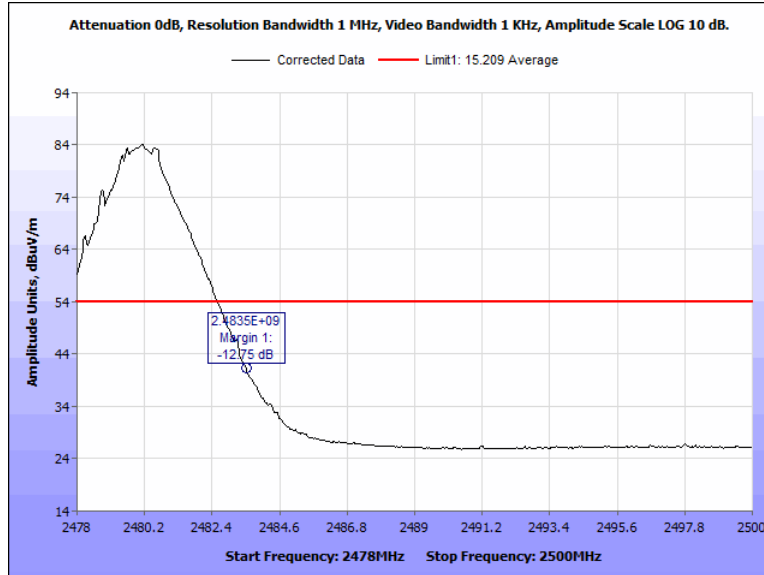

Figure 121: Radiated Band Edge, Terminal, 2480 MHz, Average, Vertical

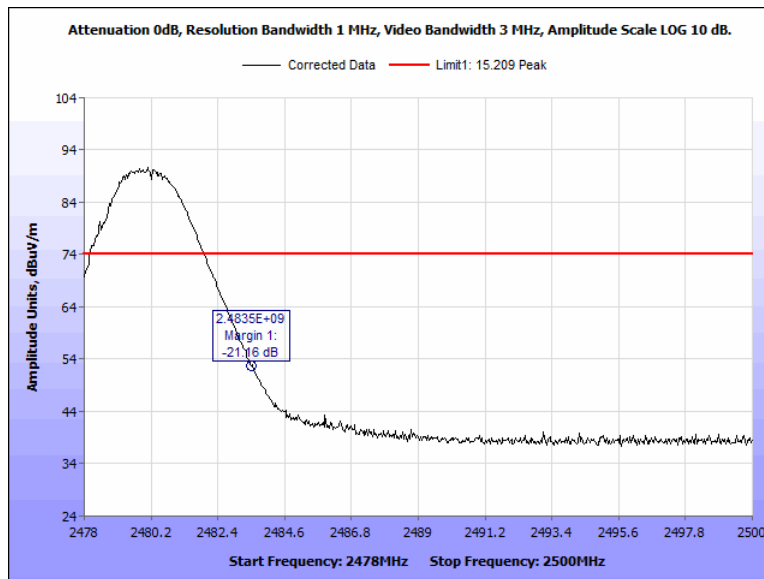

Figure 122: Radiated Band Edge, Terminal, 2480 MHz, Peak, Horizontal

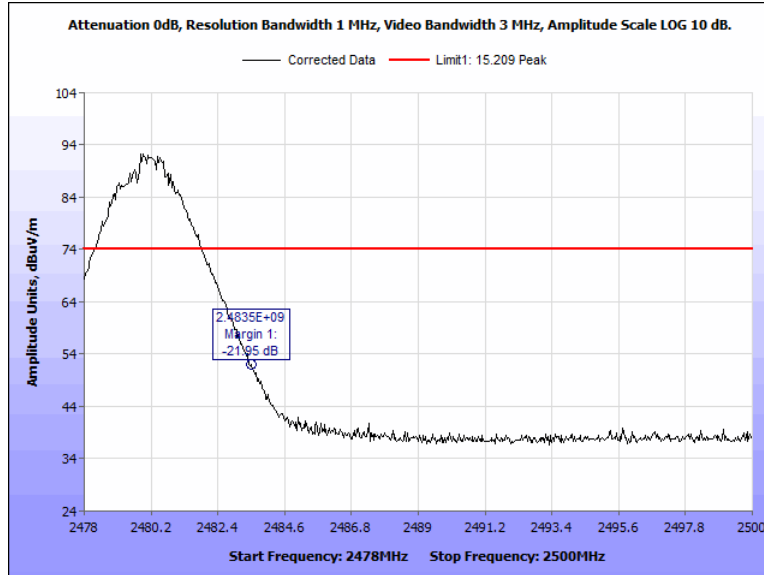

Figure 123: Radiated Band Edge, Terminal, 2480 MHz, Peak, Vertical

Electromagnetic Compatibility Criteria for Intentional Radiators

§ 15.247(d) Spurious Emissions in Non-restricted Bands

Test Requirement: 15.247(d) In any 100 kHz bandwidth outside the frequency band in which the spread spectrum or digitally modulated intentional radiator is operating, the radio frequency power that is produced by the intentional radiator shall be at least 20 dB below that in the 100 kHz bandwidth within the band that contains the highest level of the desired power, based on either an RF conducted or a radiated measurement, provided the transmitter demonstrates compliance with the peak conducted power limits. If the transmitter complies with the conducted power limits based on the use of RMS averaging over a time interval, as permitted under paragraph (b)(3) of this section, the attenuation required under this paragraph shall be 30 dB instead of 20 dB.

Test Procedure: For intentional radiators with a digital device portion which operates below 10 GHz, the spectrum was investigated as per §15.33(a)(1) and §15.33(a)(4); i.e., the lowest RF signal generated or used in the device up to the 10th harmonic of the highest fundamental frequency or to 40 GHz, whichever is lower.

Conducted measurements were performed. The plots were corrected for cable loss.

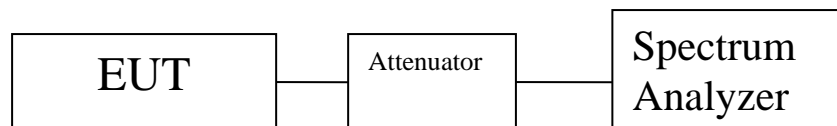

Figure 124: Block Diagram, Conducted Spurious Emissions Test Setup

Model: 40K Pigtail

Test Results: The EUT was tested is **compliant** with § 15.247(d) Spurious Emissions in Non-restricted Bands. No anomalies were noted.

Test Engineer: Jonathan Tavira

Test Date: September 18, 2019

Test Data, Model: 40K Pigtail

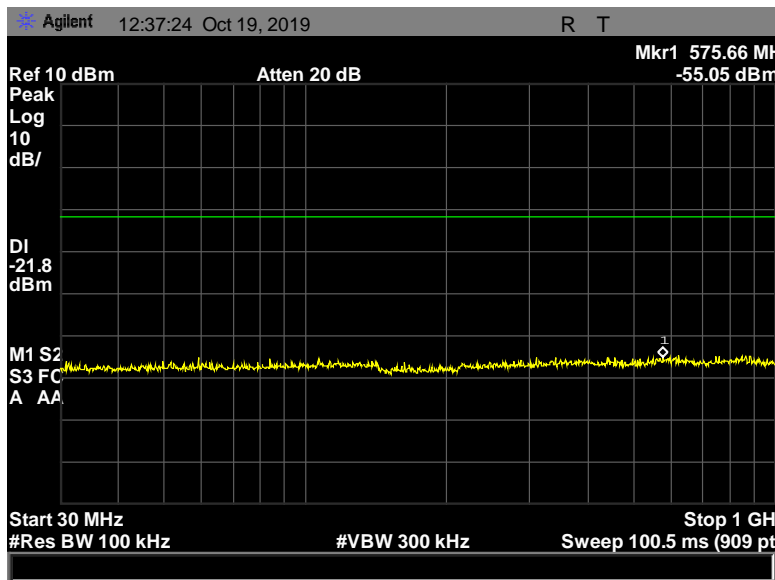

Figure 125: Conducted Spurious Emissions, Pigtail, 2402 MHz, 1 Mbps, 30 MHz - 1000 MHz

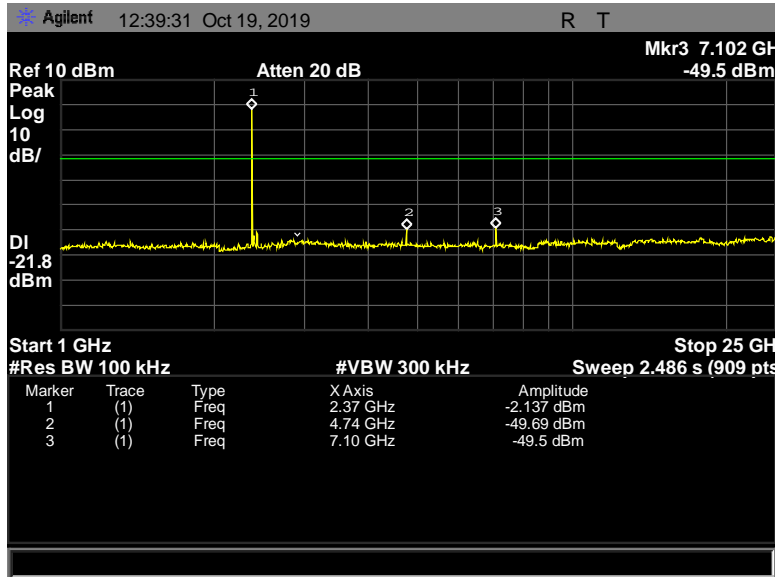

Figure 126: Conducted Spurious Emissions, Pigtail, 2402 MHz, 1 Mbps, 1 GHz - 25 GHz

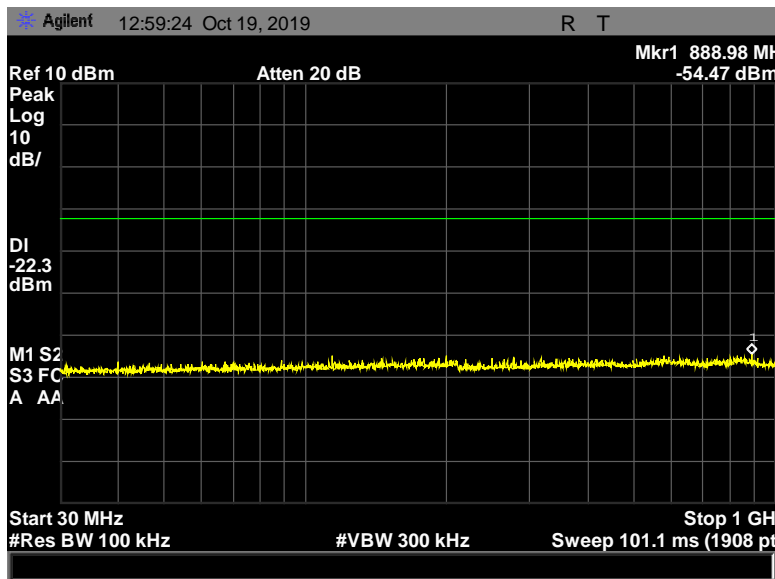

Figure 127: Conducted Spurious Emissions, Pigtail, 2402 MHz, 2 Mbps, 30 MHz - 1000 MHz

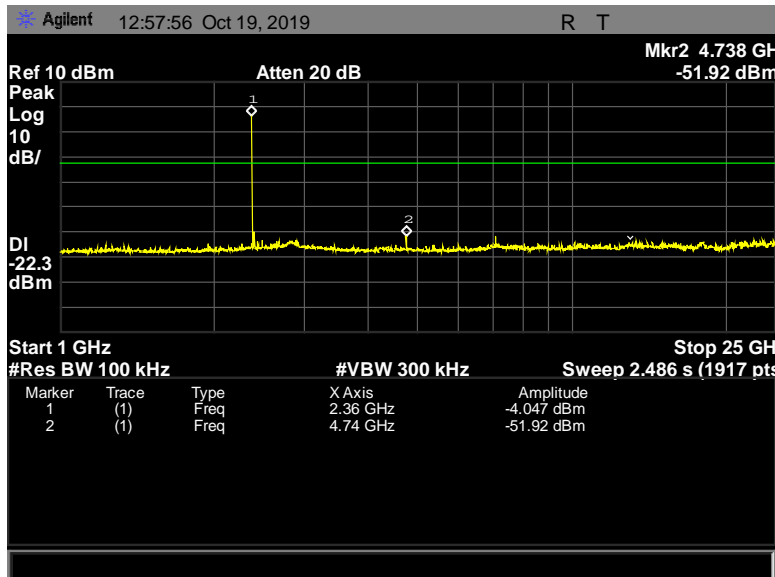

Figure 128: Conducted Spurious Emissions, Pigtail, 2402 MHz, 2 Mbps, 1 GHz - 25 GHz

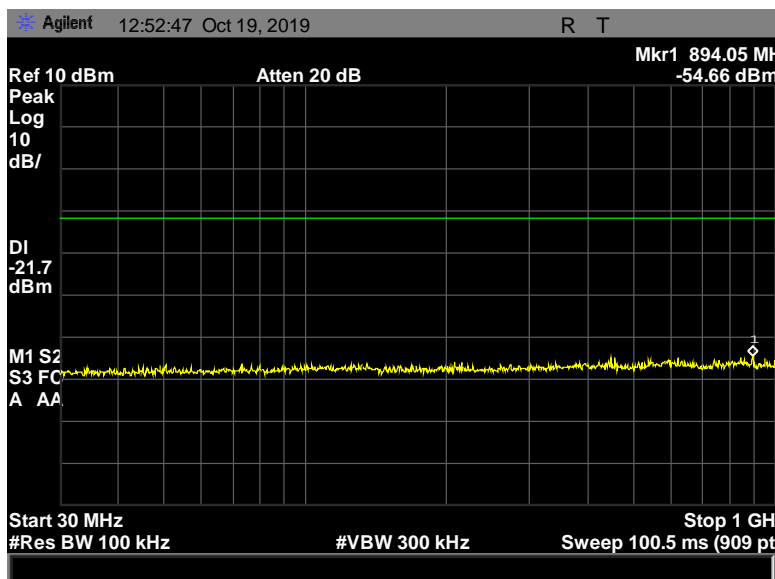

Figure 129: Conducted Spurious Emissions, Pigtail, 2442 MHz, 1 Mbps, 30 MHz - 1000 MHz

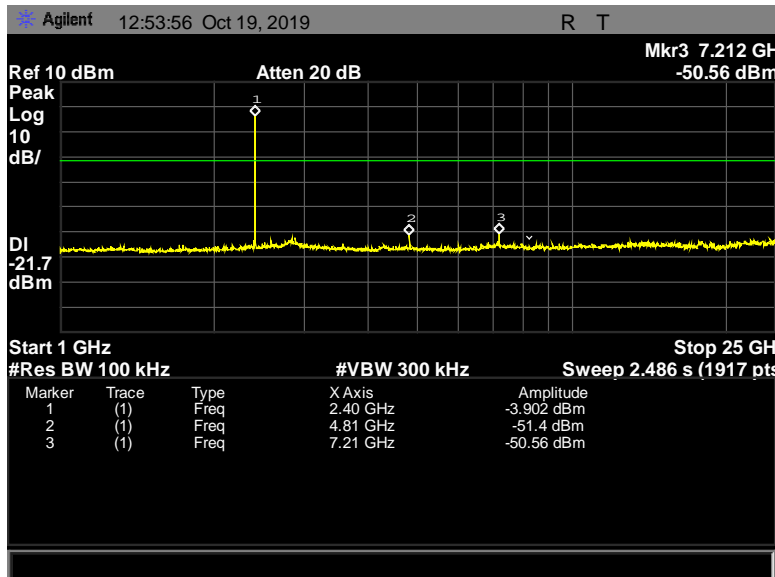

Figure 130: Conducted Spurious Emissions, Pigtail, 2442 MHz, 1 Mbps, 1 GHz - 25 GHz

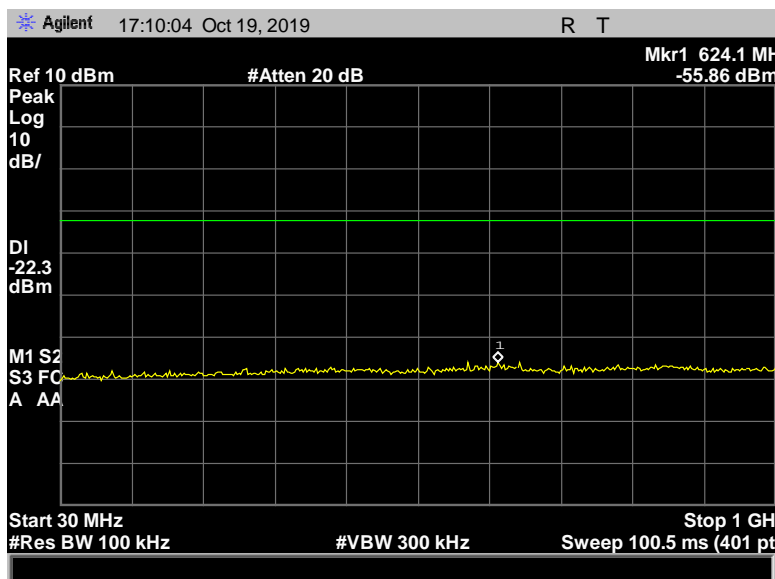

Figure 131: Conducted Spurious Emissions, Pigtail, 2442 MHz, 2 Mbps, 30 MHz - 1000 MHz

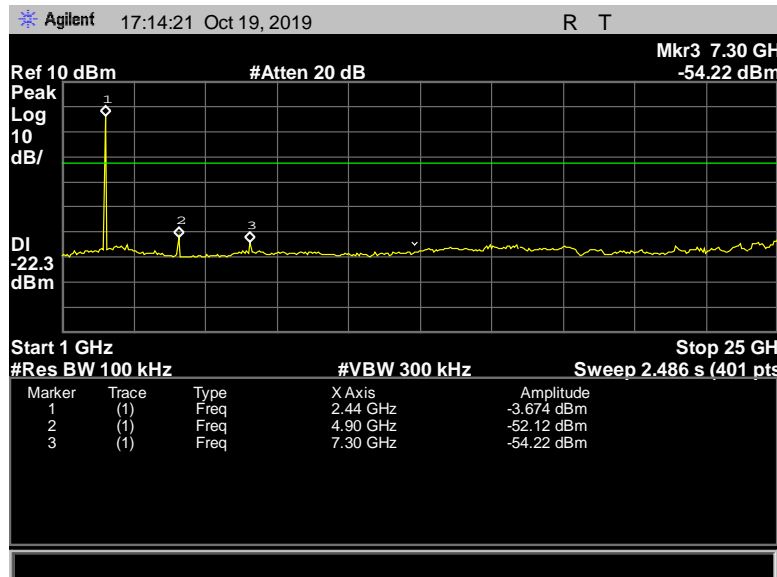

Figure 132: Conducted Spurious Emissions, Pigtail, 2442 MHz, 2 Mbps, 1 GHz - 25 GHz

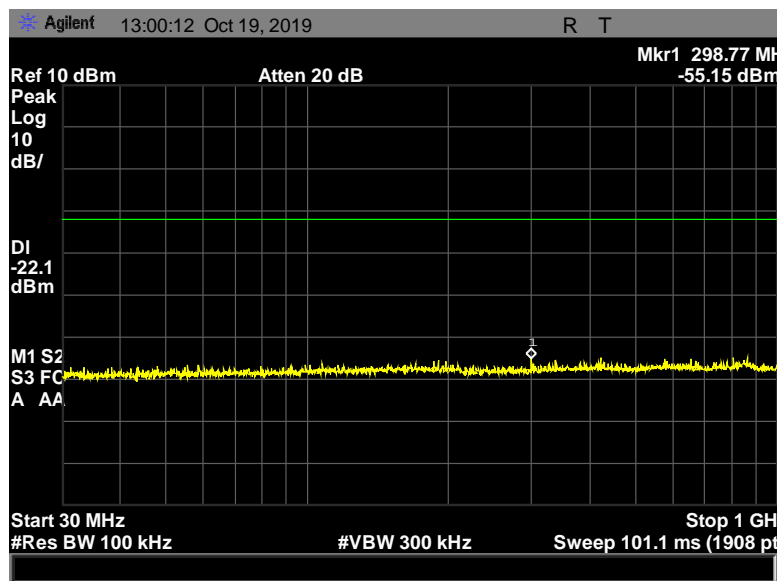

Figure 133: Conducted Spurious Emissions, Pigtail, 2480 MHz, 1 Mbps, 30 MHz - 1000 MHz

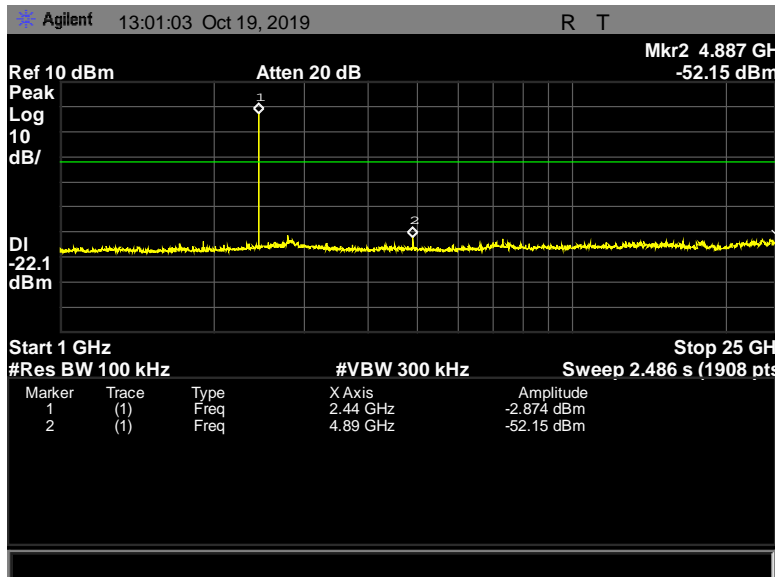

Figure 134: Conducted Spurious Emissions, Pigtail, 2480 MHz, 1 Mbps, 1 GHz - 25 GHz

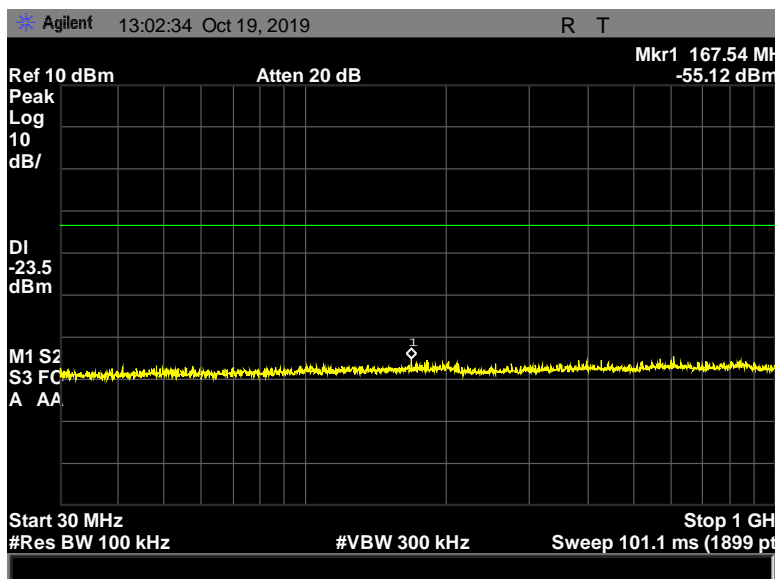

Figure 135: Conducted Spurious Emissions, Pigtail, 2480 MHz, 2 Mbps, 30 MHz - 1000 MHz

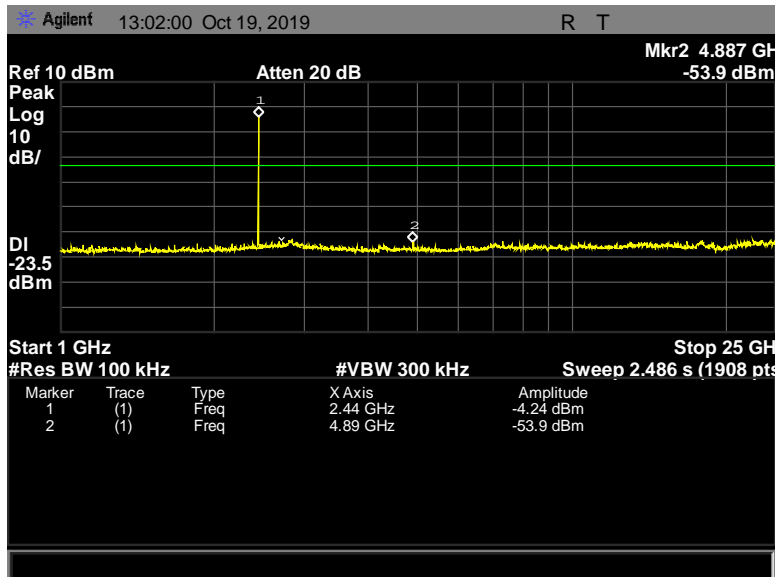

Figure 136: Conducted Spurious Emissions, Pigtail, 2480 MHz, 2 Mbps, 1 GHz - 25 GHz

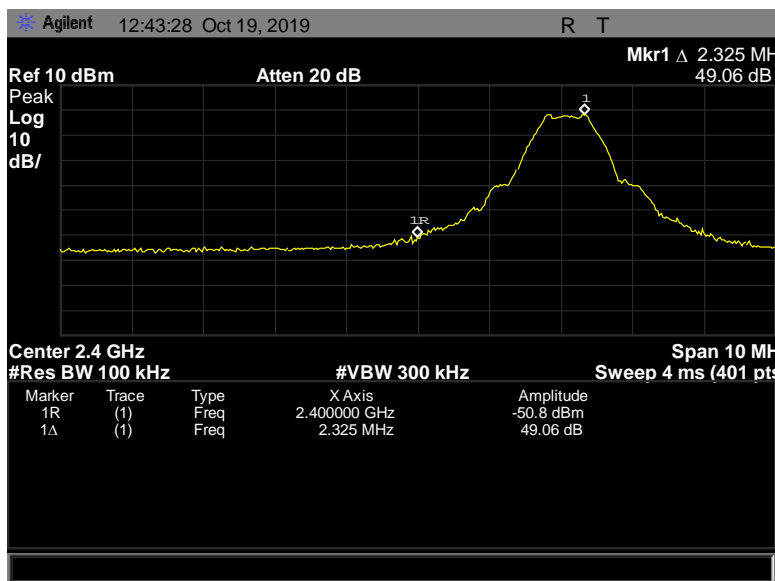

Figure 137: Conducted Band Edge, Pigtail, 2402 MHz, 1 Mbps

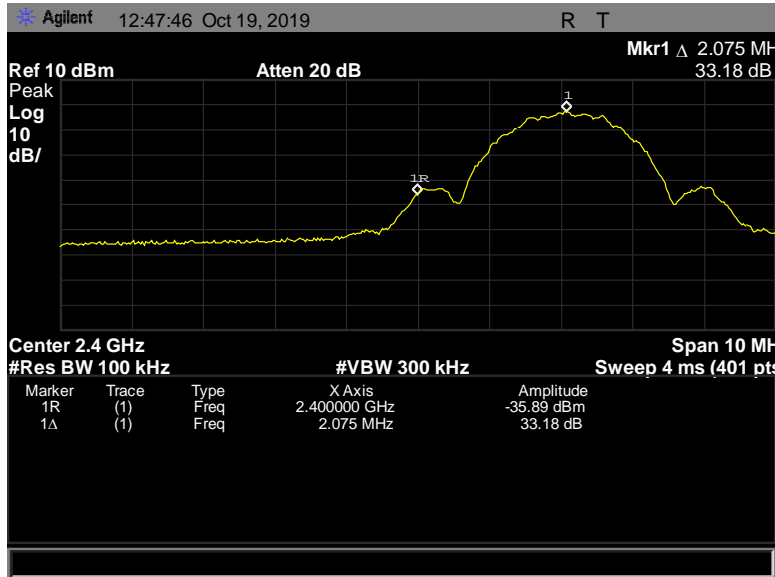

Figure 138: Conducted Band Edge, Pigtail, 2402 MHz, 2 Mbps

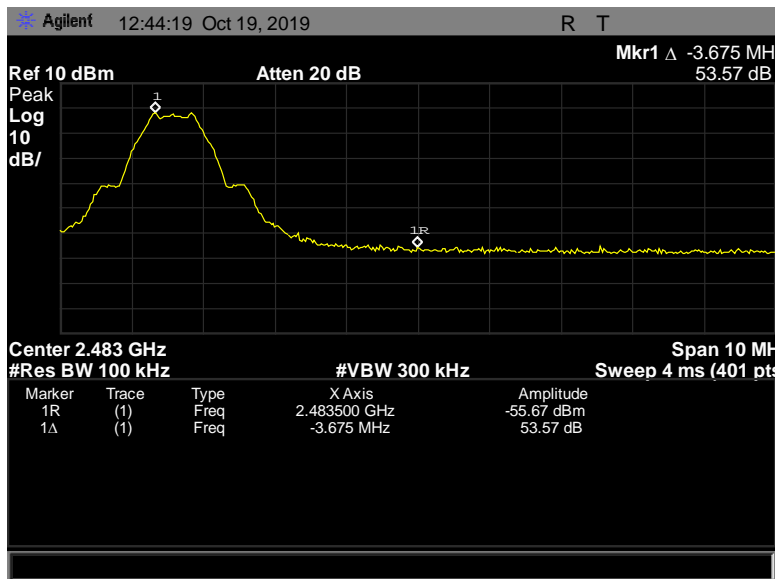

Figure 139: Conducted Band Edge, Pigtail, 2480 MHz, 1 Mbps

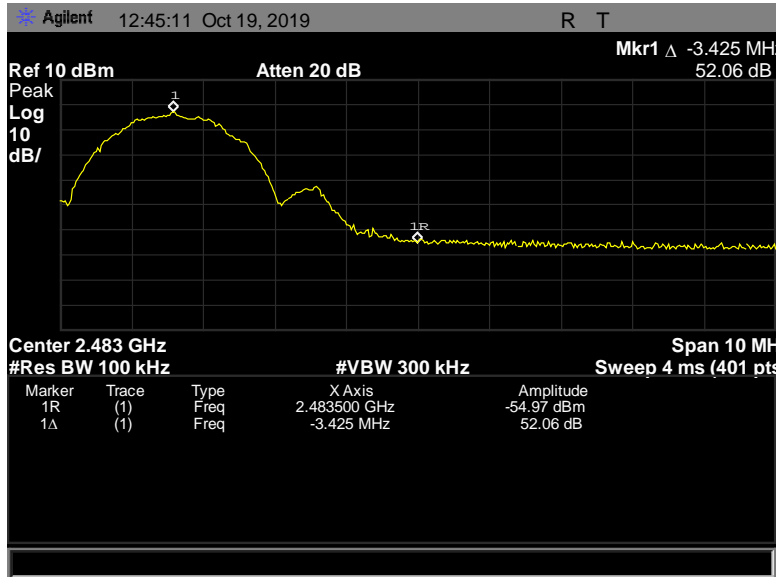

Figure 140: Conducted Band Edge, Pigtail, 2480 MHz, 2 Mbps

Model: 40K Terminal

Test Results: The EUT was tested is **compliant** with § 15.247(d) Spurious Emissions in Non-restricted Bands. No anomalies were noted.

Test Engineer: Jonathan Tavira

Test Date: September 11, 2019

Test Data, Model: 40K Terminal

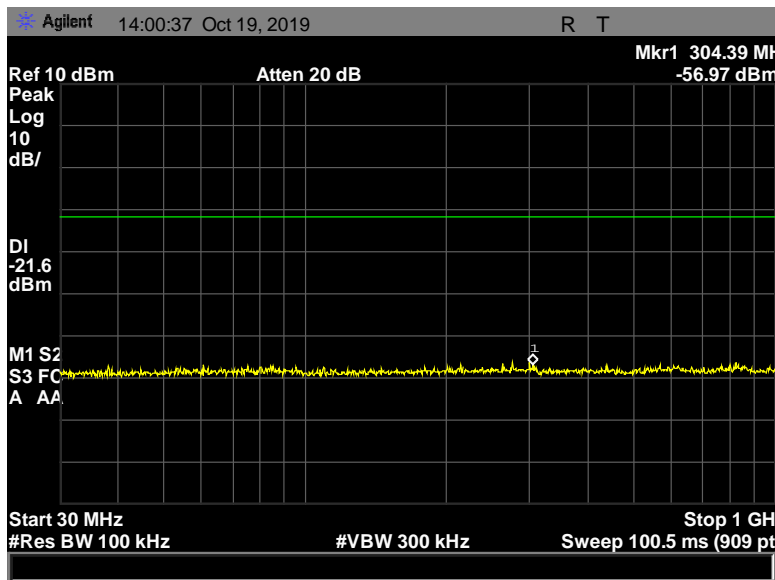

Figure 141: Conducted Spurious Emissions, Terminal, 2402 MHz, 1 Mbps, 30 MHz - 1000 MHz

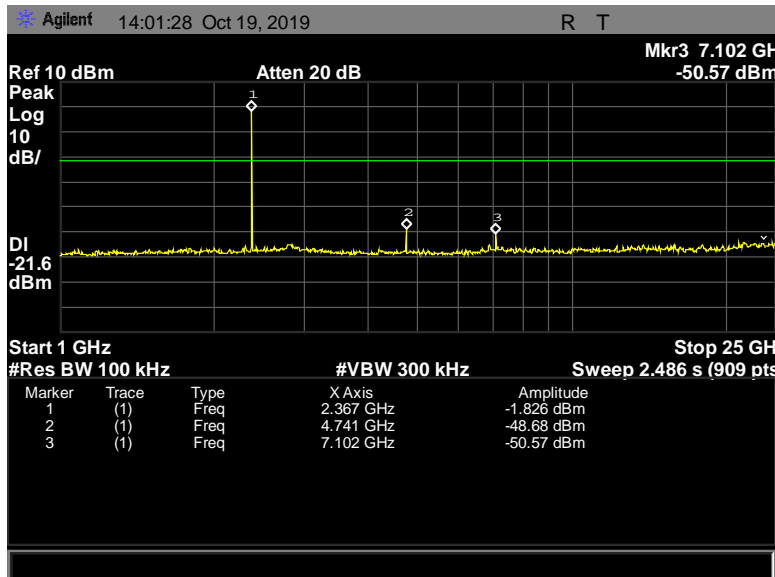

Figure 142: Conducted Spurious Emissions, Terminal, 2402 MHz, 2 Mbps, 1 GHz - 25 GHz

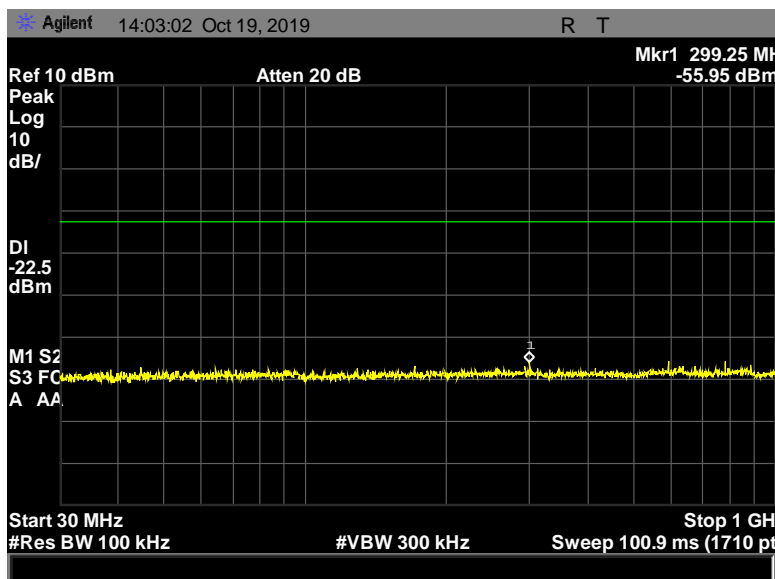

Figure 143: Conducted Spurious Emissions, Terminal, 2402 MHz, 2 Mbps, 30 MHz - 1000 MHz

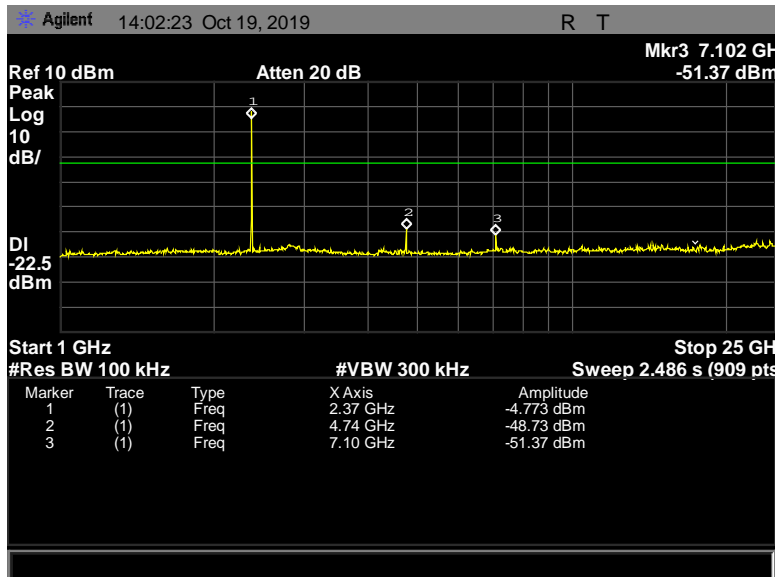

Figure 144: Conducted Spurious Emissions, Terminal, 2402 MHz, 2 Mbps, 1 GHz – 25 GHz

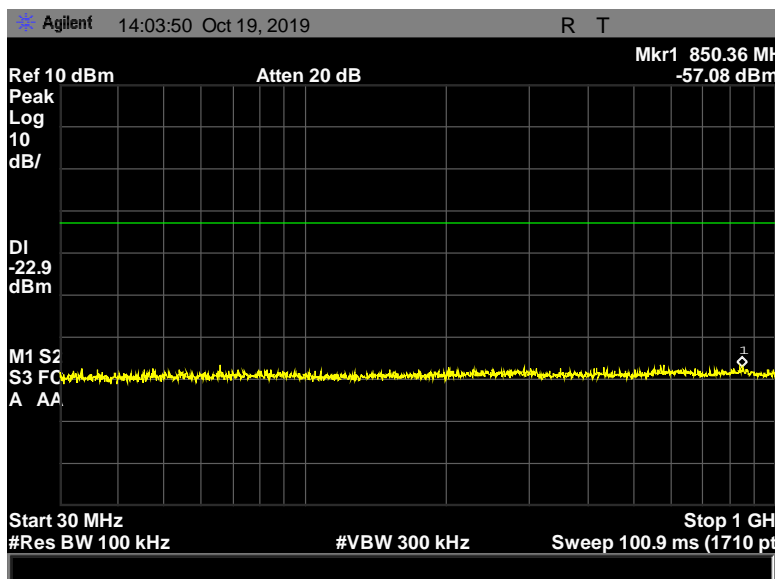

Figure 145: Conducted Spurious Emissions, Terminal, 2442 MHz, 1 Mbps, 30 MHz – 1000 MHz

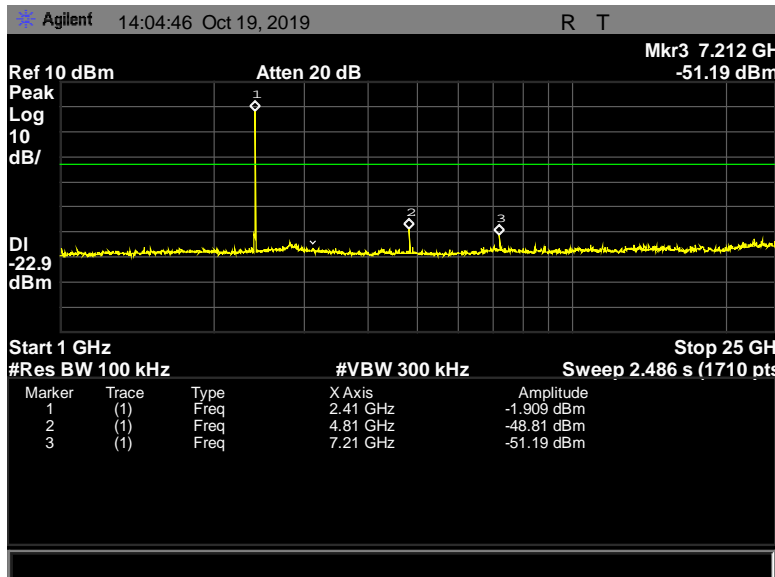

Figure 146: Conducted Spurious Emissions, Terminal, 2442 MHz, 1 Mbps, 1 GHz – 25 GHz

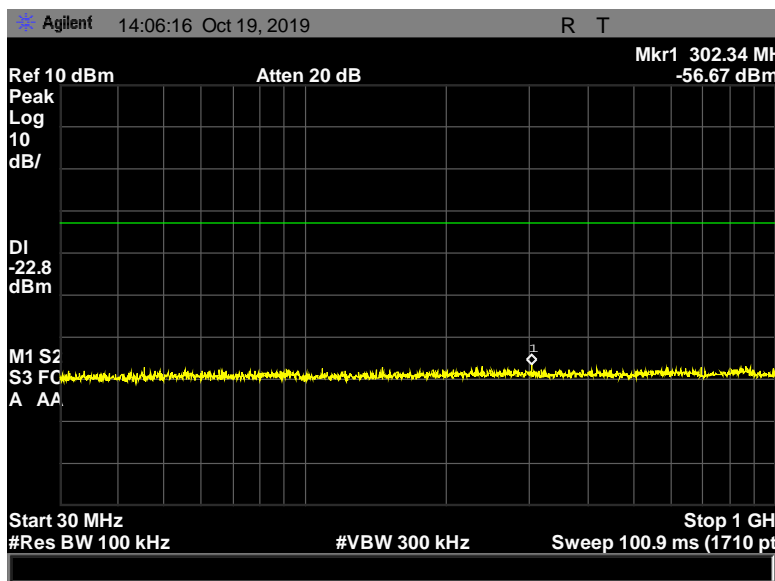

Figure 147: Conducted Spurious Emissions, Terminal, 2442 MHz, 2 Mbps, 30 MHz – 1000 MHz

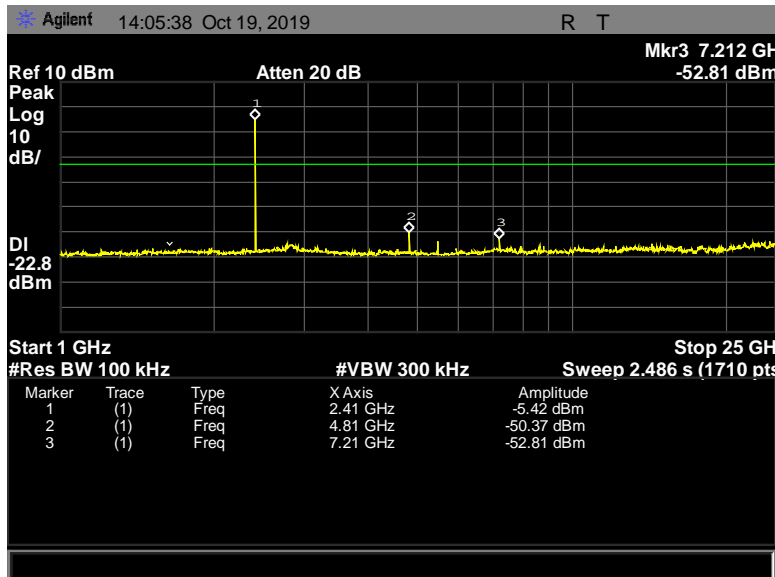

Figure 148: Conducted Spurious Emissions, Terminal, 2442 MHz, 2 Mbps, 1 GHz – 25 GHz

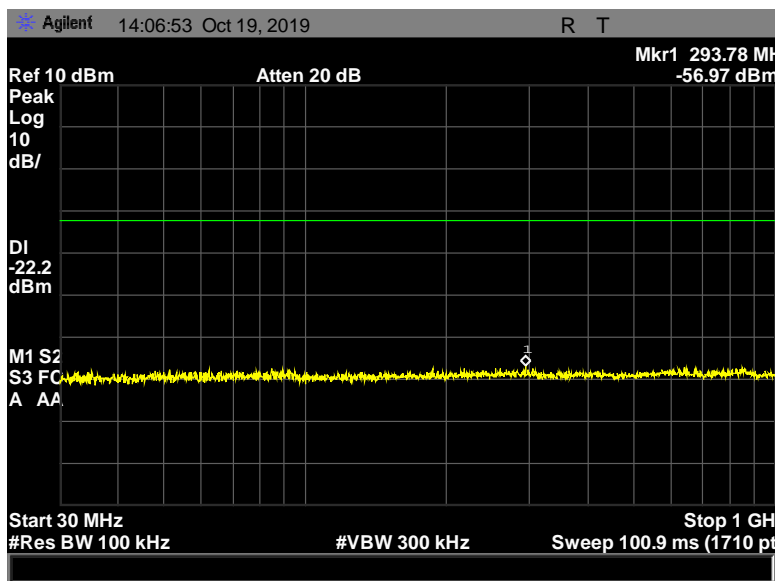

Figure 149: Conducted Spurious Emissions, Terminal, 2480 MHz, 1 Mbps, 30 MHz- 1000 MHz

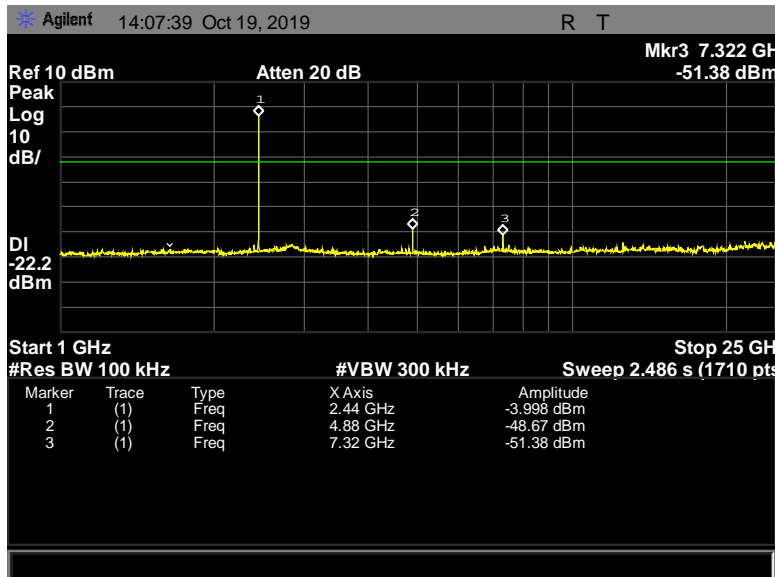

Figure 150: Conducted Spurious Emissions, Terminal, 2480 MHz, 1 Mbps, 1 GHz – 25 GHz

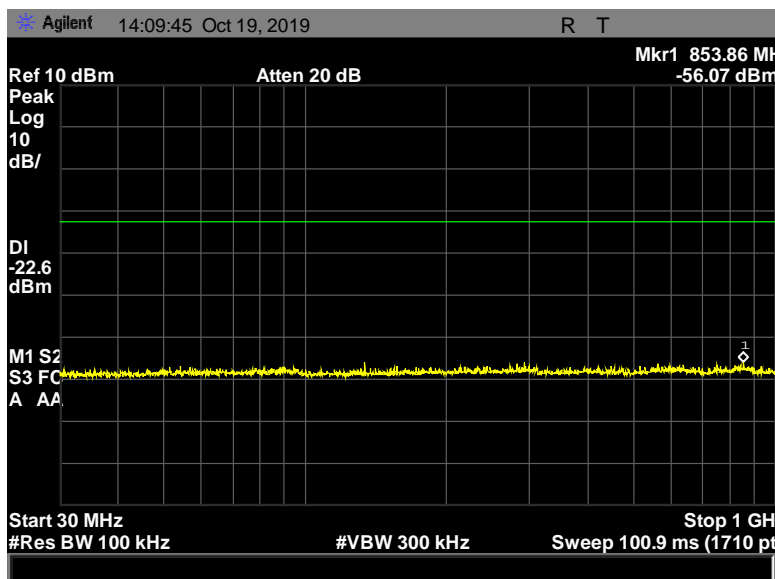

Figure 151: Conducted Spurious Emissions, Terminal, 2480 MHz, 2 Mbps, 30 MHz – 1000 MHz

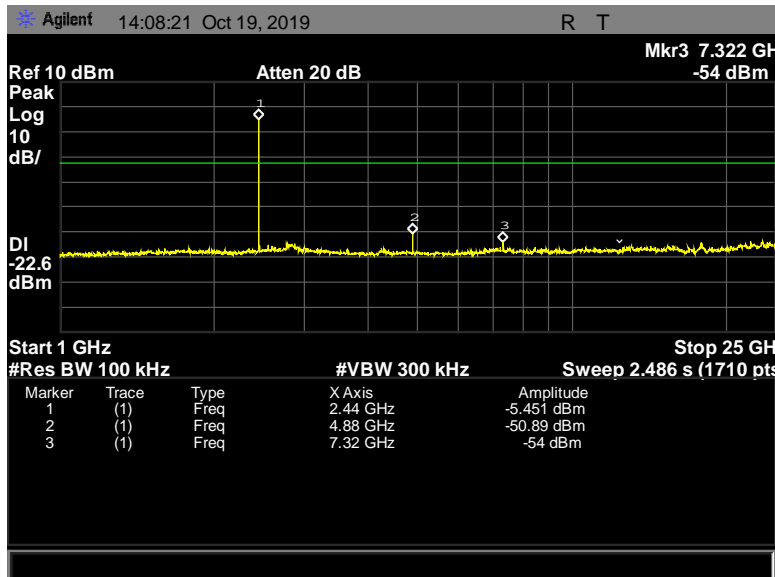

Figure 152: Conducted Spurious Emissions, Terminal, 2480 MHz, 2 Mbps, 1 GHz – 25 GHz

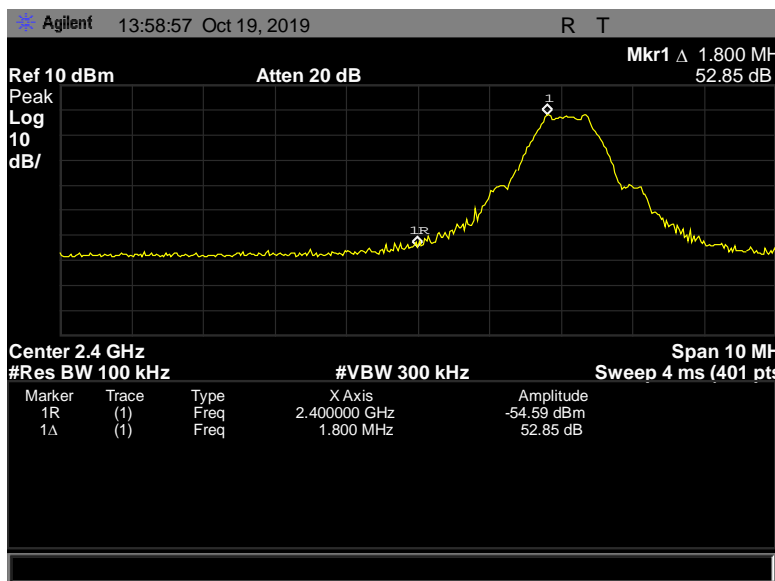

Figure 153: Conducted Band Edge, Terminal, 2402 MHz, 1 Mbps

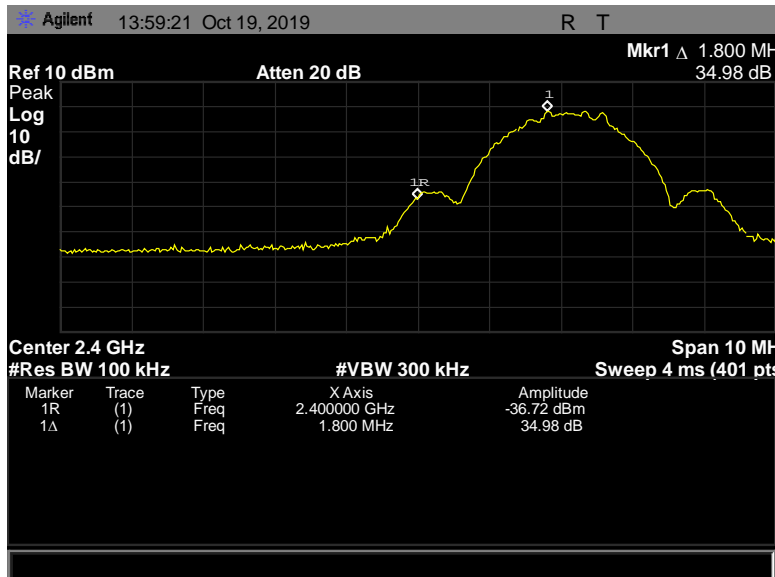

Figure 154: Conducted Band Edge, Terminal, 2402 MHz, 2 Mbps

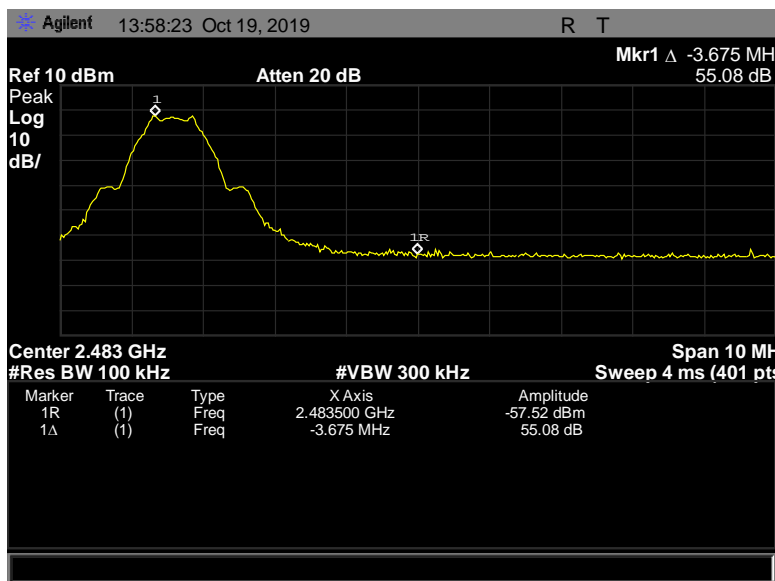

Figure 155: Conducted Band Edge, Terminal, 2480 MHz, 1 Mbps

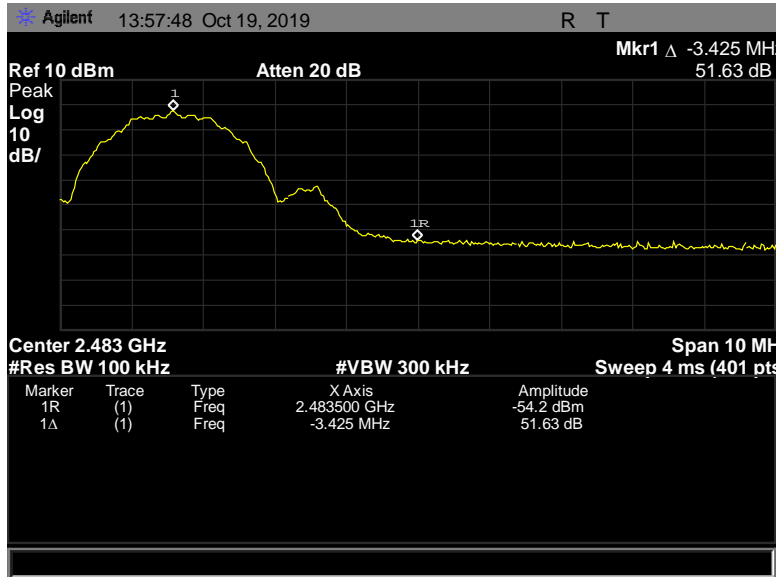

Figure 156: Conducted Band Edge, Terminal, 2480 MHz, 2 Mbps

Electromagnetic Compatibility Criteria for Intentional Radiators

§ 15.247(e) Peak Power Spectral Density

Test Requirements: §15.247(e): For digitally modulated systems, the peak power spectral density conducted from the intentional radiator to the antenna shall not be greater than 8dBm in any 3 kHz band during any time interval of continuous transmission.

Test Procedure: The power level was set to the maximum level throughout each of the 100 sweeps of power averaging. The RBW was set to 100 kHz and a VBW set to 300 kHz or greater. The spectrum analyzer was set to an auto sweep time and a peak detector was used. Measurements were carried out at the low, mid and high channels.

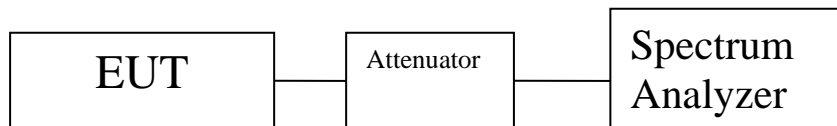

Figure 157: Block Diagram, Power Spectral Density Test Setup

Model: 40K Pigtail

Test Results: The EUT was tested is **compliant** with § 15.247(e) Peak Power Spectral Density. No anomalies were noted.

The peak power spectral density was determined from plots on the following page(s).

Test Engineer: Jonathan Tavira

Test Date: September 18, 2019

Test Data, Model: 40K Pigtail

Mode	Channel (MHz)	Power Density (dBm)
1 Mbps	2402	-1.755
1 Mbps	2442	-1.699
1 Mbps	2480	-2.115
2 Mbps	2402	-2.326
2 Mbps	2442	-2.321
2 Mbps	2480	-3.528

Figure 158: Peak Power Spectral Density, Pigtail, Test Results

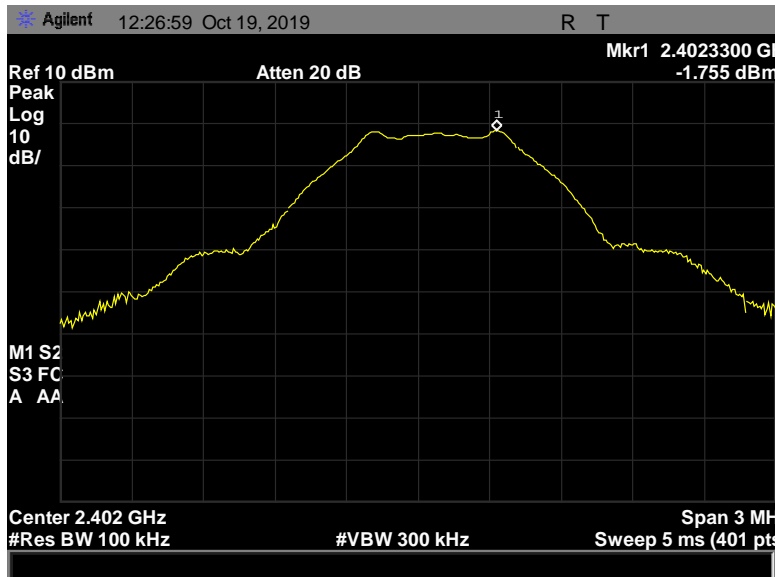

Figure 159: Peak Power Spectral Density, Pigtail, 2402 MHz, 1 Mbps, -1.755 dBm

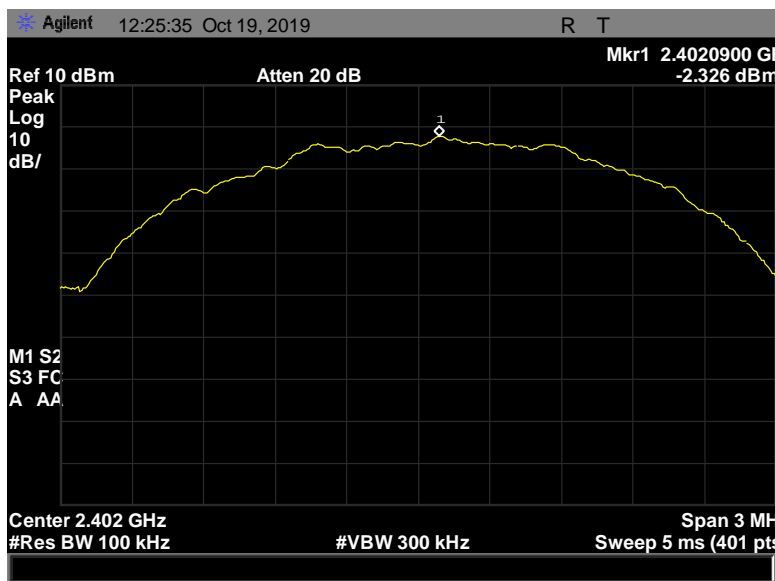

Figure 160: Peak Power Spectral Density, Pigtail, 2402 MHz, 2 Mbps, -2.236 dBm

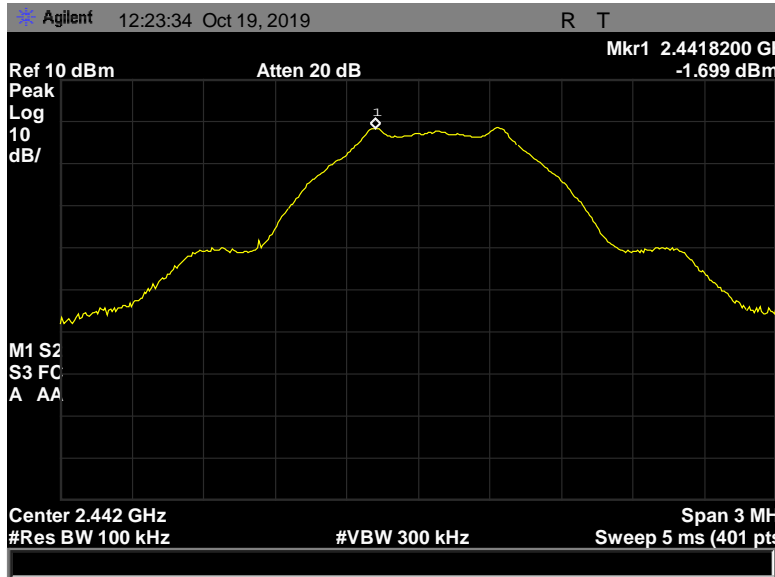

Figure 161: Peak Power Spectral Density, Pigtail, 2442 MHz, 1 Mbps, -1.699 dBm

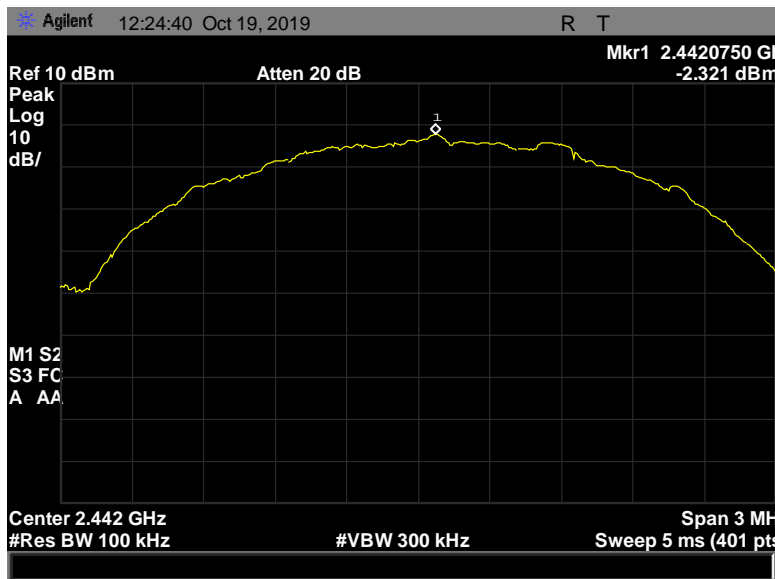

Figure 162: Peak Power Spectral Density, Pigtail, 2442 MHz, 2 Mbps, -2.321 dBm

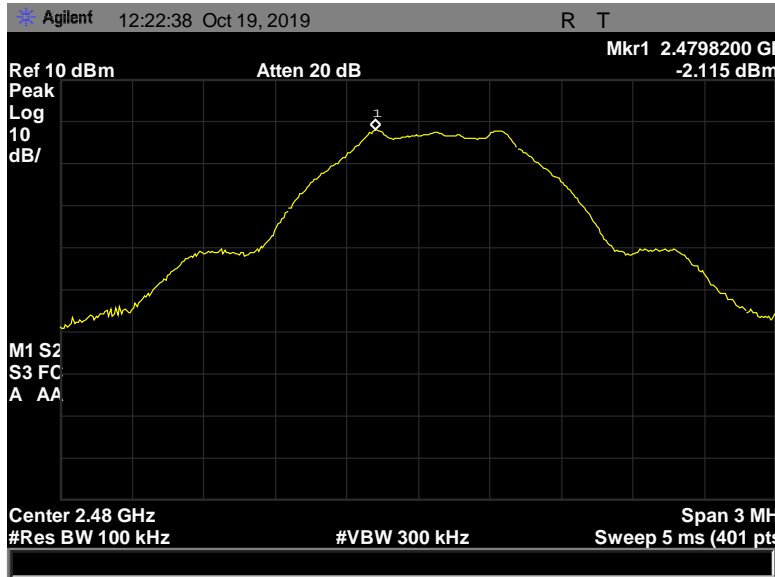

Figure 163: Peak Power Spectral Density, Pigtail, 2480 MHz, 1 Mbps, -2.115 dBm

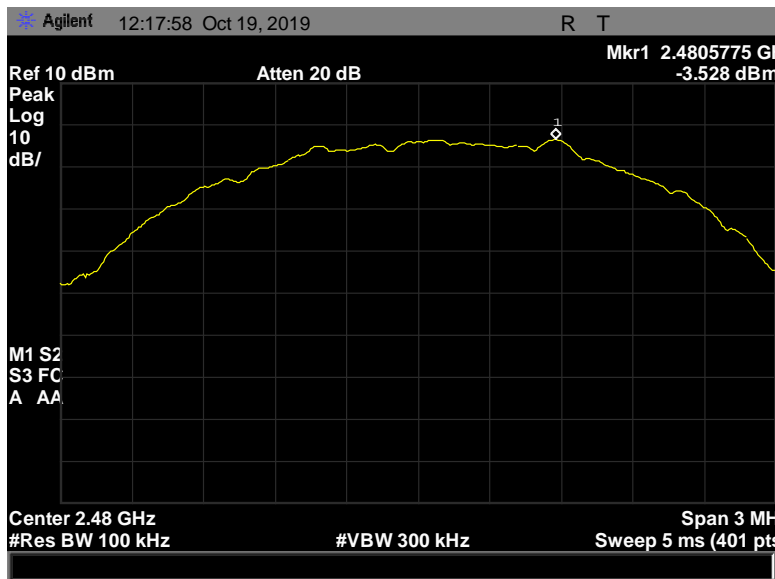

Figure 164: Peak Power Spectral Density, Pigtail, 2480 MHz, 2 Mbps, -3.528 dBm

Model: 40K Terminal

Test Results: The EUT was tested is **compliant** with § 15.247(e) Peak Power Spectral Density. No anomalies were noted.

The peak power spectral density was determined from plots on the following page(s).

Test Engineer: Jonathan Tavira

Test Date: September 11, 2019

Test Data, Model: 40K Terminal

Mode	Channel (MHz)	Power Density (dBm)
1 Mbps	2402	-1.624
1 Mbps	2442	-2.288
1 Mbps	2480	-2.222
2 Mbps	2402	-2.543
2 Mbps	2442	-2.843
2 Mbps	2480	-2.609

Figure 165: Peak Power Spectral Density, Terminal, Test Results

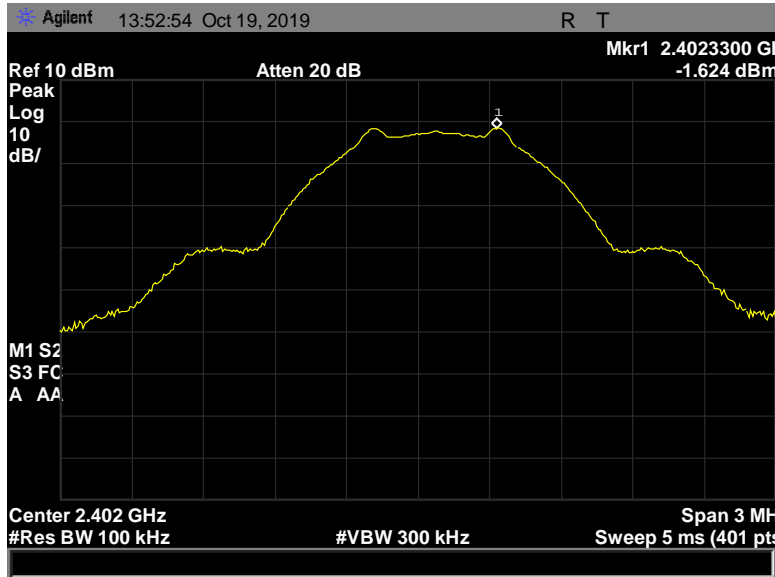

Figure 166: Peak Power Spectral Density, Terminal, 2402 MHz, 1 Mbps, -1.624 dBm

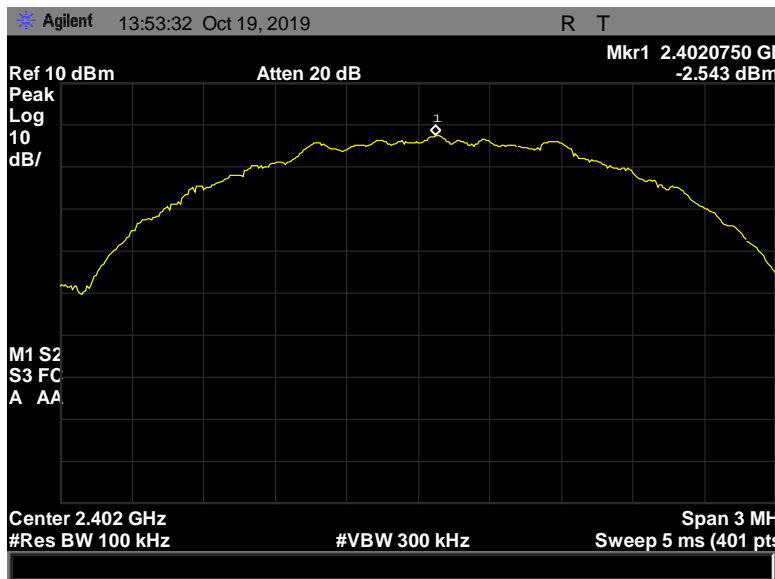

Figure 167: Peak Power Spectral Density, Terminal, 2402 MHz, 2 Mbps, -2.543 dBm

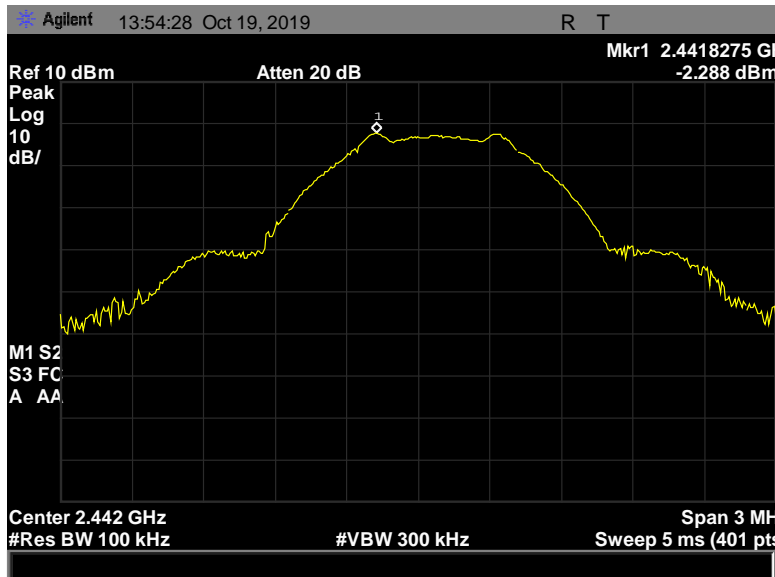

Figure 168: Peak Power Spectral Density, Terminal, 2442 MHz, 1 Mbps, -2.288 dBm

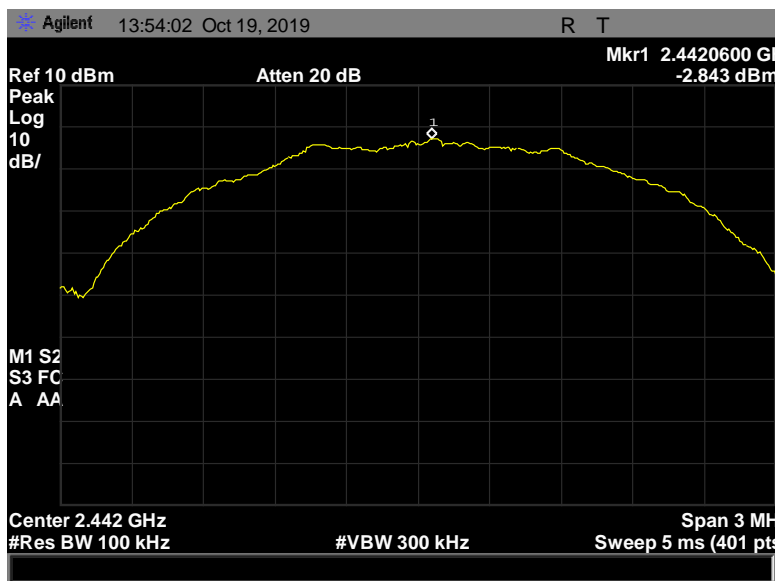

Figure 169: Peak Power Spectral Density, Terminal, 2442 MHz, 2 Mbps, -2.843 dBm

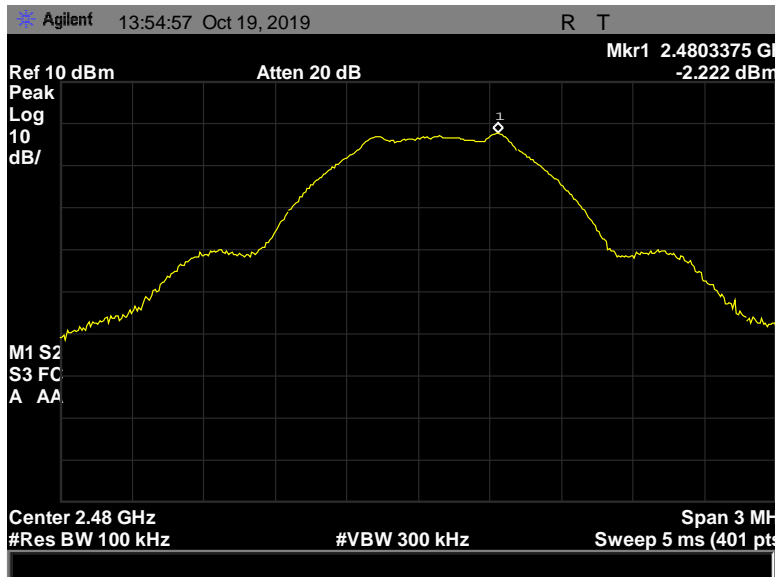

Figure 170: Peak Power Spectral Density, Terminal, 2480 MHz, 1 Mbps, -2.222 dBm

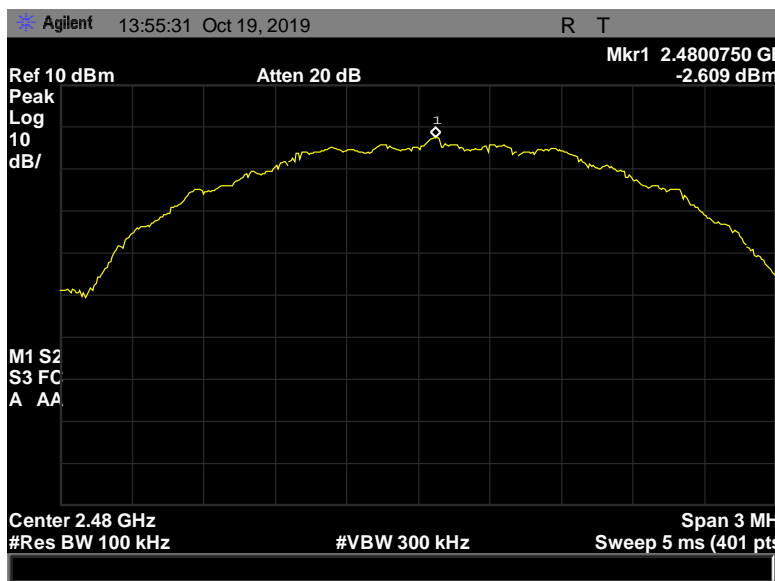

Figure 171: Peak Power Spectral Density, Terminal, 2480 MHz, 2 Mbps, -2.609 dBm

Electromagnetic Compatibility Criteria for Intentional Radiators

§ 15.247(i) RF Human Exposure

RF Exposure

Requirements:

§1.1307(b)(1) and §1.1307(b)(2): Systems operating under the provisions of this section shall be operated in a manner that ensures that the public is not exposed to radio frequency energy levels in excess of the Commission's guidelines.

RF Radiation

Exposure Limit:

§2.1093: As specified in this section, a portable device is defined as a transmitting device designed to be used so that the radiated structure(s) of the device is within 20 centimeters of the body of the user. Calculations below are in accordance with KDB 447498 D01 General RF Exposure Guidance v06, Section 4.3 General SAR test exclusion guidance. The SAR test exclusion thresholds are 3.0 for 1-g SAR and 7.5 for 10-g extremity SAR

Model: 40K Pigtail

Test Results:

The EUT was tested is **compliant** with § 15.247(i) RF Human Exposure. No anomalies were noted.

Test Engineer:

Jonathan Tavira

Test Date:

September 18, 2019

Test Data, Model: 40K Pigtail

Frequency (MHz)	Con. Pwr. (dBm)	Tuneup tolerance (dB)	Con. Pwr. Including Tuneup Tolerance (mW)	Calculated SAR Threshold	1.0-g SAR Limit	Margin	Separation Distance Declared (mm)	Result
2402	0.94	1.0	1.5631	0.4845	3.0	-2.5155	5	Pass

Figure 172: RF Human Exposure, Pigtail, Test Results

Per KDB 447498, Section 4.3.1 (a), applicable for 100 MHz to 6 GHz and test separation distances ≤ 50 mm:

$$\frac{\text{max. power of channel, including tuneup tolerance [mW]}}{\text{min. test separation distance [mm]}} * \sqrt{f \text{ [GHz]}} \leq 3.0 \text{ (1 - g SAR Limit)}$$

$$\frac{1.5631 \text{ mW}}{5 \text{ mm}} * \sqrt{2.402} = 0.4845 \leq 3.0 \text{ (1 - g SAR)}$$

Model: 40K Terminal

Test Results: The EUT was tested is **compliant** with § 15.247(i) RF Human Exposure. No anomalies were noted.

Test Engineer: Jonathan Tavira

Test Date: September 12, 2019

Test Data, Model: 40K Terminal

Frequency (MHz)	Con. Pwr. (dBm)	Tuneup tolerance (dB)	Con. Pwr. Including Tuneup Tolerance (mW)	Calculated SAR Threshold	1.0-g SAR Limit	Margin	Separation Distance Declared (mm)	Result
2402	1.23	1.0	1.6711	0.5180	3.0	-2.4820	5	Pass

Figure 173: RF Human Exposure, Terminal, Test Results

Per KDB 447498, Section 4.3.1 (a), applicable for 100 MHz to 6 GHz and test separation distances ≤ 50 mm:

$$\frac{\text{max. power of channel, including tuneup tolerance [mW]}}{\text{min. test separation distance [mm]}} * \sqrt{f [GHz]} \leq 3.0 (1 - g \text{ SAR Limit})$$

$$\frac{1.6711 \text{ mW}}{5 \text{ mm}} * \sqrt{2.402} = 0.5180 \leq 3.0 (1 - g \text{ SAR})$$

IV. Test Equipment

Test Equipment

Calibrated test equipment utilized during testing was maintained in a current state of calibration per the requirements of ISO/IEC 17025:2017.

MET ASSET #	EQUIPMENT	MANUFACTURER	MODEL	LAST CAL DATE	CAL DUE DATE
1A1065	EMI RECEIVER	ROHDE & SCHWARZ	ESCI	05/01/2019	05/01/2020
1A1177	ATTENUATOR	ROHDE & SCHWARZ	ESH3Z2	11/30/2018	11/30/2019
1A1123	LISN	TESEQ	NNB 51	07/18/2019	08/18/2019
1A1123	LISN	TESEQ	NNB 51	09/25/2019	09/25/2020
1A1076	VARIABLE AC TRANSFORMER	POWERSTAT	N/A	SEE NOTE	
1A1119	TEST AREA	CUSTOM MADE	N/A	SEE NOTE	
1A1184	SPECTRUM ANALYZER	AGILENT	E4407B	06/25/2019	06/25/2020
1A1083	EMI RECIVER	ROHDE & SCHWARZ	ESU40	10/10/2019	10/10/2020
1A1050	HYBRID ANTENNA	SCHAFFNER	CBL 6112D	08/29/2018	02/29/2020
1A1183	DOUBLE RIDGED WAVEGUIDE ANTENNA	ETS-LINDGREN	3117	10/10/2018	04/10/2020
1A1088	PRE-AMP	ROHDE & SCHWARZ	TS-PR1	SEE NOTE	
1A1080	MULTI-DEVICE CONTROLLER	ETS-EMCO	2090	SEE NOTE	
1A1180	PRE-AMP	MITEQ	AMF-7D-01001800-22-10P	SEE NOTE	
1A1106	10M SEMI-ANECHOIC CHAMBER	LINDGREN	N/a	SEE NOTE	

Figure 174: Test Equipment List

Note: Functionally tested equipment is verified using calibrated instrumentation at the time of testing.

V. Certification & User's Manual Information

Certification & User's Manual Information

A. Certification Information

The following is extracted from Title 47 of the Code of Federal Regulations, Part 2, Subpart I — Marketing of Radio frequency devices:

§ 2.801 Radio-frequency device defined.

As used in this part, a radio-frequency device is any device which in its operation is capable of Emitting radio-frequency energy by radiation, conduction, or other means. Radio- frequency devices include, but are not limited to:

- (a) The various types of radio communication transmitting devices described throughout this chapter.
- (b) *The incidental, unintentional and intentional radiators defined in Part 15 of this chapter.*
- (c) The industrial, scientific, and medical equipment described in Part 18 of this chapter.
- (d) Any part or component thereof which in use emits radio-frequency energy by radiation, conduction, or other means.

§ 2.803 Marketing of radio frequency devices prior to equipment authorization.

- (a) Except as provided elsewhere in this chapter, no person shall sell or lease, or offer for sale or lease (including advertising for sale or lease), or import, ship or distribute for the purpose of selling or leasing or offering for sale or lease, any radio frequency device unless:
 - (1) In the case of a device subject to certification, such device has been authorized by the Commission in accordance with the rules in this chapter and is properly identified and labeled as required by §2.925 and other relevant sections in this chapter; or
 - (2) In the case of a device that is not required to have a grant of equipment authorization issued by the Commission, but which must comply with the specified technical standards prior to use, such device also complies with all applicable administrative (including verification of the equipment or authorization under a Declaration of Conformity, where required), technical, labeling and identification requirements specified in this chapter.
- (d) Notwithstanding the provisions of paragraph (a) of this section, the offer for sale solely to business, commercial, industrial, scientific or medical users (but not an offer for sale to other parties or to end users located in a residential environment) of a radio frequency device that is in the conceptual, developmental, design or pre-production stage is permitted prior to equipment authorization or, for devices not subject to the equipment authorization requirements, prior to a determination of compliance with the applicable technical requirements *provided* that the prospective buyer is advised in writing at the time of the offer for sale that the equipment is subject to the FCC rules and that the equipment will comply with the appropriate rules before delivery to the buyer or to centers of distribution.

- (e)(1) Notwithstanding the provisions of paragraph (a) of this section, prior to equipment authorization or determination of compliance with the applicable technical requirements any radio frequency device may be operated, but not marketed, for the following purposes and under the following conditions:
- (i) *Compliance testing;*
 - (ii) Demonstrations at a trade show provided the notice contained in paragraph (c) of this section is displayed in a conspicuous location on, or immediately adjacent to, the device;
 - (iii) Demonstrations at an exhibition conducted at a business, commercial, industrial, scientific or medical location, but excluding locations in a residential environment, provided the notice contained in paragraphs (c) or (d) of this section, as appropriate, is displayed in a conspicuous location on, or immediately adjacent to, the device;
 - (iv) Evaluation of product performance and determination of customer acceptability, provided such operation takes place at the manufacturer's facilities during developmental, design or pre-production states; or
 - (v) Evaluation of product performance and determination of customer acceptability where customer acceptability of a radio frequency device cannot be determined at the manufacturer's facilities because of size or unique capability of the device, provided the device is operated at a business, commercial, industrial, scientific or medical user's site, but not at a residential site, during the development, design or pre-production stages.
- (e)(2) For the purpose of paragraphs (e)(1)(iv) and (e)(1)(v) of this section, the term *manufacturer's facilities* includes the facilities of the party responsible for compliance with the regulations and the manufacturer's premises, as well as the facilities of other entities working under the authorization of the responsible party in connection with the development and manufacture, but not the marketing, of the equipment.
- (f) For radio frequency devices subject to verification and sold solely to business, commercial, industrial, scientific and medical users (excluding products sold to other parties or for operation in a residential environment), parties responsible for verification of the devices shall have the option of ensuring compliance with the applicable technical specifications of this chapter at each end user's location after installation, provided that the purchase or lease agreement includes a proviso that such a determination of compliance be made and is the responsibility of the party responsible for verification of the equipment.

Certification & User's Manual Information

The following is extracted from Title 47 of the Code of Federal Regulations, Part 2, Subpart J — Equipment Authorization Procedures:

§ 2.901 Basis and Purpose

- (a) In order to carry out its responsibilities under the Communications Act and the various treaties and international regulations, and in order to promote efficient use of the radio spectrum, the Commission has developed technical standards for radio frequency equipment and parts or components thereof. The technical standards applicable to individual types of equipment are found in that part of the rules governing the service wherein the equipment is to be operated.¹ *In addition to the technical standards provided, the rules governing the service may require that such equipment be verified by the manufacturer or importer, be authorized under a Declaration of Conformity, or receive an equipment authorization from the Commission by one of the following procedures: certification or registration.*
- (b) The following sections describe the verification procedure, the procedure for a Declaration of Conformity, and the procedures to be followed in obtaining certification from the Commission and the conditions attendant to such a grant.

§ 2.907 Certification.

- (a) Certification is an equipment authorization issued by the Commission, based on representation and test data submitted by the applicant.
- (b) Certification attaches to all units subsequently marketed by the grantee which are identical (see Section 2.908) to the sample tested except for permissive changes or other variations authorized by the Commission pursuant to Section 2.1043.

¹ In this case, the equipment is subject to the rules of Part 15. More specifically, the equipment falls under Subpart B (of Part 15), which deals with unintentional radiators.

Certification & User's Manual Information

§ 2.948 Description of measurement facilities.

- (a) Each party making measurements of equipment that is subject to an equipment authorization under Part 15 or Part 18 of this chapter, regardless of whether the measurements are filed with the Commission or kept on file by the party responsible for compliance of equipment marketed within the U.S. or its possessions, shall compile a description of the measurement facilities employed.
- (1) If the measured equipment is subject to the verification procedure, the description of the measurement facilities shall be retained by the party responsible for verification of the equipment.
- (i) *If the equipment is verified through measurements performed by an independent laboratory, it is acceptable for the party responsible for verification of the equipment to rely upon the description of the measurement facilities retained by or placed on file with the Commission by that laboratory. In this situation, the party responsible for the verification of the equipment is not required to retain a duplicate copy of the description of the measurement facilities.*
- (ii) If the equipment is verified based on measurements performed at the installation site of the equipment, no specific site calibration data is required. It is acceptable to retain the description of the measurement facilities at the site at which the measurements were performed.
- (2) If the equipment is to be authorized by the Commission under the certification procedure, the description of the measurement facilities shall be filed with the Commission's Laboratory in Columbia, Maryland. The data describing the measurement facilities need only be filed once but must be updated as changes are made to the measurement facilities or as otherwise described in this section. At least every three years, the organization responsible for filing the data with the Commission shall certify that the data on file is current.

Certification & User's Manual Information

1. Label and User's Manual Information

The following is extracted from Title 47 of the Code of Federal Regulations, Part 15, Subpart A — General:

§ 15.19 Labeling requirements.

(a) *In addition to the requirements in Part 2 of this chapter, a device subject to certification or verification shall be labeled as follows:*

- (1) Receivers associated with the operation of a licensed radio service, e.g., FM broadcast under Part 73 of this chapter, land mobile operation under Part 90, etc., shall bear the following statement in a conspicuous location on the device:

This device complies with Part 15 of the FCC Rules. Operation is subject to the condition that this device does not cause harmful interference.

- (2) A stand-alone cable input selector switch, shall bear the following statement in a conspicuous location on the device:

This device is verified to comply with Part 15 of the FCC Rules for use with cable television service.

- (3) All other devices shall bear the following statement in a conspicuous location on the device:

This device complies with Part 15 of the FCC Rules. Operation is subject to the following two conditions: (1) This device may not cause harmful interference, and (2) this device must accept any interference received, including interference that may cause undesired operation.

- (4) Where a device is constructed in two or more sections connected by wires and marketed together, the statement specified under paragraph (a) of this section is required to be affixed only to the main control unit.

- (5) When the device is so small or for such use that it is not practicable to place the statement specified under paragraph (a) of this section on it, the information required by this paragraph shall be placed in a prominent location in the instruction manual or pamphlet supplied to the user or, alternatively, shall be placed on the container in which the device is marketed. However, the FCC identifier or the unique identifier, as appropriate, must be displayed on the device.

§ 15.21 Information to user.

The user's manual or instruction manual for an intentional or unintentional radiator shall caution the user that changes or modifications not expressly approved by the party responsible for compliance could void the user's authority to operate the equipment.

Verification & User's Manual Information

The following is extracted from Title 47 of the Code of Federal Regulations, Part 15, Subpart B — Unintentional Radiators:

§ 15.105 Information to the user.

- (a) For a Class A digital device or peripheral, the instructions furnished the user shall include the following or similar statement, placed in a prominent location in the text of the manual:

Note: This equipment has been tested and found to comply with the limits for a Class A digital device, pursuant to Part 15 of the FCC Rules. These limits are designed to provide reasonable protection against harmful interference when the equipment is operated in a commercial environment. This equipment generates, uses, and can radiate radio frequency energy and, if not installed and used in accordance with the instruction manual, may cause harmful interference to radio communications. Operation of this equipment in a residential area is likely to cause harmful interference in which case the user will be required to correct the interference at own expense.

- (b) For a Class B digital device or peripheral, the instructions furnished the user shall include the following or similar statement, placed in a prominent location in the text of the manual:

Note: This equipment has been tested and found to comply with the limits for a Class B digital device, pursuant to Part 15 of the FCC Rules. These limits are designed to provide reasonable protection against harmful interference when the equipment is operated in a residential environment. This equipment generates, uses, and can radiate radio frequency energy and, if not installed and used in accordance with the instruction manual, may cause harmful interference to radio communications. However, there is no guarantee that interference will not occur in a particular installation. If this equipment does cause harmful interference to radio or television reception, which can be determined by turning the equipment off and on, the user is encouraged to try to correct the interference by one or more of the following measures:

- Reorient or relocate the receiving antenna.
- Increase the separation between the equipment and receiver.
- Connect the equipment into an outlet on a circuit different from that to which the receiver is connected.
- Consult the dealer or an experienced radio/TV technician for help.

End of Report