

HID GLOBAL CORPORATION

RFID READER MODULE, OPERATING AT 13.56 MHZ

Model: RKCL40A

January 6th, 2012



Report No.: PCII_RKCL40A_SL1112901-HID-025_FCC_Rev-02

(This report supersedes PCII_RKCL40A(EMC)_SL1112901-HID-025)



Modifications made to the product : None

This Test Report is Issued Under the Authority of:

	
Yao Li Compliance Engineer	Leslie Bai Director of Certification

This test report may be reproduced in full only.
Test result presented in this test report is applicable to the representative sample only.

RF Test Report

To: FCC Part 15.207, 15.209, 15.225

SIEMIC, INC.
Accessing global markets



Laboratory Introduction

SIEMIC, headquartered in the heart of Silicon Valley, with superior facilities in US and Asia, is one of the leading independent testing and certification facilities providing customers with one-stop shop services for Compliance Testing and Global Certifications.



In addition to [testing](#) and [certification](#), SIEMIC provides initial design reviews and [compliance management](#) through out a project. Our extensive experience with [China](#), [Asia Pacific](#), [North America](#), [European](#), and [international](#) compliance requirements, assures the fastest, most cost effective way to attain regulatory compliance for the [global markets](#).

Accreditations for Conformity Assessment

Country/Region	Accreditation Body	Scope
USA	FCC, A2LA	EMC , RF/Wireless , Telecom , SAR
Canada	IC, A2LA, NIST	EMC, RF/Wireless , Telecom , SAR
Taiwan	BSMI , NCC , NIST	EMC, RF, Telecom , Safety
Hong Kong	OFTA , NIST	RF/Wireless ,Telecom
Australia	NATA, NIST	EMC, RF, Telecom , Safety
Korea	KCC/RRA, NIST	EMI, EMS, RF , Telecom, Safety , SAR
Japan	VCCI, JATE, TELEC, RFT	EMI, RF/Wireless, Telecom
Mexico	NOM, COFETEL, Caniety	Safety, EMC , RF/Wireless, Telecom
Europe	A2LA, NIST	EMC, RF, Telecom , Safety, SAR

Accreditations for Product Certifications

Country	Accreditation Body	Scope
USA	FCC TCB, NIST	EMC , RF , Telecom
Canada	IC FCB , NIST	EMC , RF , Telecom
Singapore	iDA, NIST	EMC , RF , Telecom
EU	NB	EMC & R&TTE Directive
Japan	MIC, (RCB 208)	RF , Telecom
HongKong	OFTA (US002)	RF , Telecom

This page has been left blank intentionally.



CONTENTS

1	EXECUTIVE SUMMARY & EUT INFORMATION	6
2	TECHNICAL DETAILS	7
3	MODIFICATION	8
4	TEST SUMMARY	9
5	MEASUREMENTS, EXAMINATION AND DERIVED RESULTS	10
	ANNEX A. TEST INSTRUMENT & METHOD.....	27
	ANNEX B. TEST SETUP PHOTOGRAPHS.....	31
	ANNEX B. I. EUT INTERNAL PHOTOGRAPHS	32
	ANNEX B. II. EUT EXTERNAL PHOTOGRAPHS	34
	ANNEX C. SUPPORTING EQUIPMENT DESCRIPTION	40
	ANNEX D. EUT OPERATING CONDITIONS	43
	ANNEX E. USER MANUAL, BLOCK & CIRCUIT DIAGRAM	44
	ANNEX E SIEMIC ACCREDITATION	45

This page has been left blank intentionally.



1 Executive Summary & EUT information

The purpose of this test programmed was to demonstrate compliance of the HID Global Corp., Model: RKCL40A against the current Stipulated Standards for FCC regulation requirements.

The equipment under test radio operating frequency is 13.56MHz.

The test has demonstrated that this unit complies with stipulated standards.

EUT Information

EUT Description : The RKCL40A is an RFID reader module working at 13.56MHz.

Model No : RKCL40A

Serial No : N/A

Input Power : 12 VDC

**Classification
Per Stipulated
Test Standard** : RFID Reader Module



2 TECHNICAL DETAILS

Purpose	Compliance testing of RFID Reader Module, Operating at 13.56 MHz with stipulated standard
Applicant / Client	HID Global Corporation
Manufacturer	HID Global Corporation 15730 Barranca Parkway Irvine, CA 92618 USA
Laboratory performing the tests	SIEMIC Laboratories 2206 Ringwood Ave. San Jose, CA 95131
Test report reference number	PCII_RKCL40A_SL11112901-HID-025_FCC_Rev-02
Date EUT received	Dec 12th, 2011
Standard applied	47 CFR §15.207, 15.209, 15.225
Dates of test (from – to)	Dec 12th – Dec 16th, 2011
No of Units:	4
Equipment Category:	DXX
Model :	RKCL40A
RF Operating Frequency (ies)	13.56 MHz (RFID)
Number of Channels :	13.56 MHz (1)
FCC ID :	JQ6-ICLASSR40D,



3 MODIFICATION

NONE

4 TEST SUMMARY

The product was tested in accordance with the following specifications. All testing has been performed according to below product classification:

RFID Reader

Test Results Summary

Test Standard	Description	Pass / Fail
47 CFR Part 15.225: 2010		
15.203	Antenna Requirement	Pass*
15.207(a)	Conducted Emissions Voltage	Pass
15.225(a)	Limit in the band of 13.553 – 13.567 MHz	Pass*
15.225(b)	Limit in the band of 13.410 – 13.553 MHz and 13.567 – 13.710 MHz	Pass*
15.225(c)	Limit in the band of 13.110 – 13.410 MHz and 13.710 – 14.010 MHz	Pass*
15.225(d), 15.209	Limit outside the band of 13.110 – 14.010 MHz	Pass
15.225(e)	Frequency Stability	Pass*
	Occupied Bandwidth	Pass*
	Very Low Power Devices Operating Below 490 kHz	Pass*

ANSI C63.4: 2009

*Note: results refer to original test report: SL10071904-HID-012_RP40D (FCC,IC)

PS: All measurement uncertainties are not taken into consideration for all presented test result.



5 MEASUREMENTS, EXAMINATION AND DERIVED RESULTS

5.1 Antenna Requirement

Requirement(s): 47 CFR §15.203

An intentional radiator shall be designed to ensure that no antenna other than that furnished by the responsible party shall be used with the device.

Antenna requirement must meet at least one of the following:

- a) Antenna must be permanently attached to the device.
 - b) Antenna must use a unique type of connector to attach to the device.
 - c) Device must be professionally installed. Installer shall be responsible for ensuring that the correct antenna is employed with the device.
-
- 1) The RFID antenna is integral to the main board permanently to the device which meets the requirement (See Internal Photographs submitted as another Exhibit).

5.2 Conducted Emissions Voltage

Requirement(s): 47 CFR §15.207

Requirement:

Frequency of emission (MHz)	Conducted limit (dB μ V)	
	Quasi-peak	Average
0.15–0.5	66 to 56*	56 to 46*
0.5–5	56	46
5–30	60	50

*Decreases with the logarithm of the frequency.

Procedures:

1. All possible modes of operation were investigated. Only the 6 worst case emissions measured, using the correct CISPR and Average detectors, are reported. All other emissions were relatively insignificant.
2. A "-ve" margin indicates a PASS as it refers to the margin present below the limit line at the particular frequency.
3. Conducted Emissions Measurement Uncertainty
All test measurements carried out are traceable to national standards. The uncertainty of the measurement at a confidence level of approximately 95% (in the case where distributions are normal), with a coverage factor of 2, in the range 9kHz – 30MHz (Average & Quasi-peak) is ± 3.5 dB.
4. Environmental Conditions

Temperature	20°C
Relative Humidity	52%
Atmospheric Pressure	1019mbar

Test Date : Dec 12th - Dec 16th 2011
Tested By : Yao Li

Results: Pass

Test Result

RKCL40A Pig-Tail Connectors

Quasi-Peak Limit

Average Limit

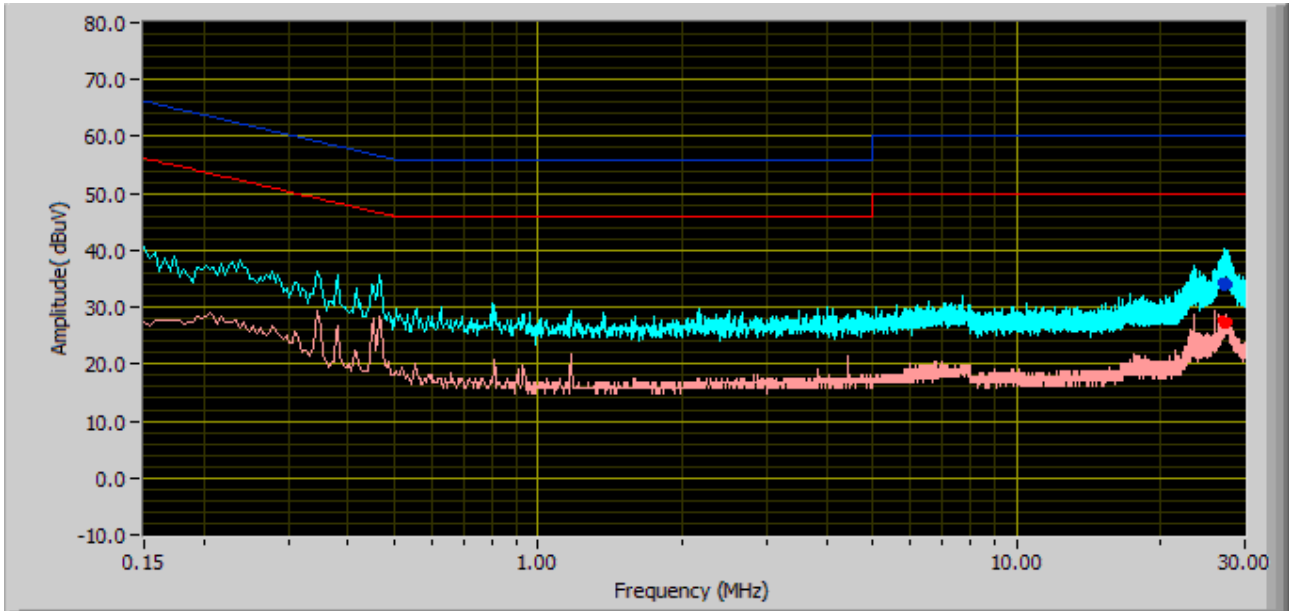

120V, 60Hz, Neutral Line

Frequency (MHz)	QP Value (dBμV)	Class B Limit (dB)	Pass / Fail	Margin (dB)	Avg Value (dBμV)	Class B Limit (dB)	Pass / Fail	Margin (dB)	Line
27.27	33.69	60.00	Pass	-26.31	26.98	50.00	Pass	-23.02	Neutral
27.49	34.21	60.00	Pass	-25.79	27.26	50.00	Pass	-22.74	Neutral
27.70	33.96	60.00	Pass	-26.04	27.26	50.00	Pass	-22.74	Neutral
27.34	33.96	60.00	Pass	-26.04	26.98	50.00	Pass	-23.02	Neutral
27.51	34.21	60.00	Pass	-25.79	27.26	50.00	Pass	-22.74	Neutral
27.02	34.22	60.00	Pass	-25.78	27.81	50.00	Pass	-22.19	Neutral



Quasi-Peak Limit

Average Limit

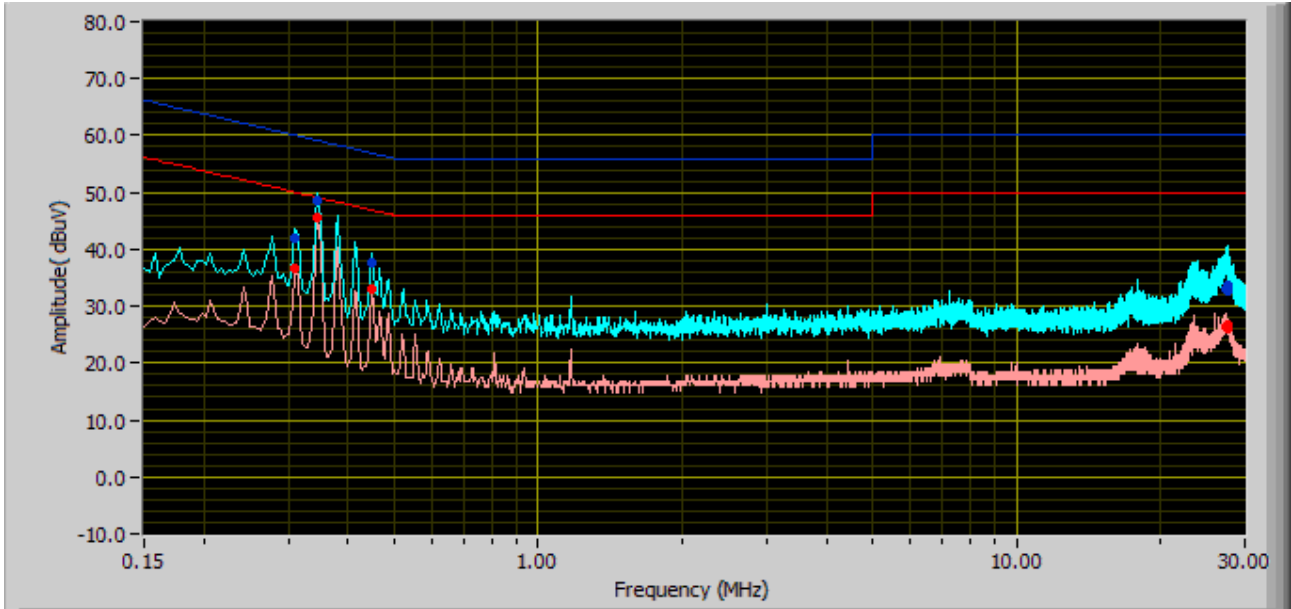

120V, 60Hz, Phase Line

Frequency (MHz)	QP Value (dBμV)	Class B Limit (dB)	Pass / Fail	Margin (dB)	Avg Value (dBμV)	Class B Limit (dB)	Pass / Fail	Margin (dB)	Line
0.35	48.67	59.11	Pass	-10.45	45.57	49.11	Pass	-3.54	Phase
0.31	42.08	60.04	Pass	-17.97	36.80	50.04	Pass	-13.25	Phase
0.45	37.52	56.89	Pass	-19.37	33.06	46.89	Pass	-13.83	Phase
27.54	33.59	60.00	Pass	-26.41	26.72	50.00	Pass	-23.28	Phase
27.29	33.04	60.00	Pass	-26.96	26.42	50.00	Pass	-23.58	Phase
27.71	32.58	60.00	Pass	-27.42	26.09	50.00	Pass	-23.91	Phase

RKCL40A Terminal Connectors

Quasi-Peak Limit

Average Limit

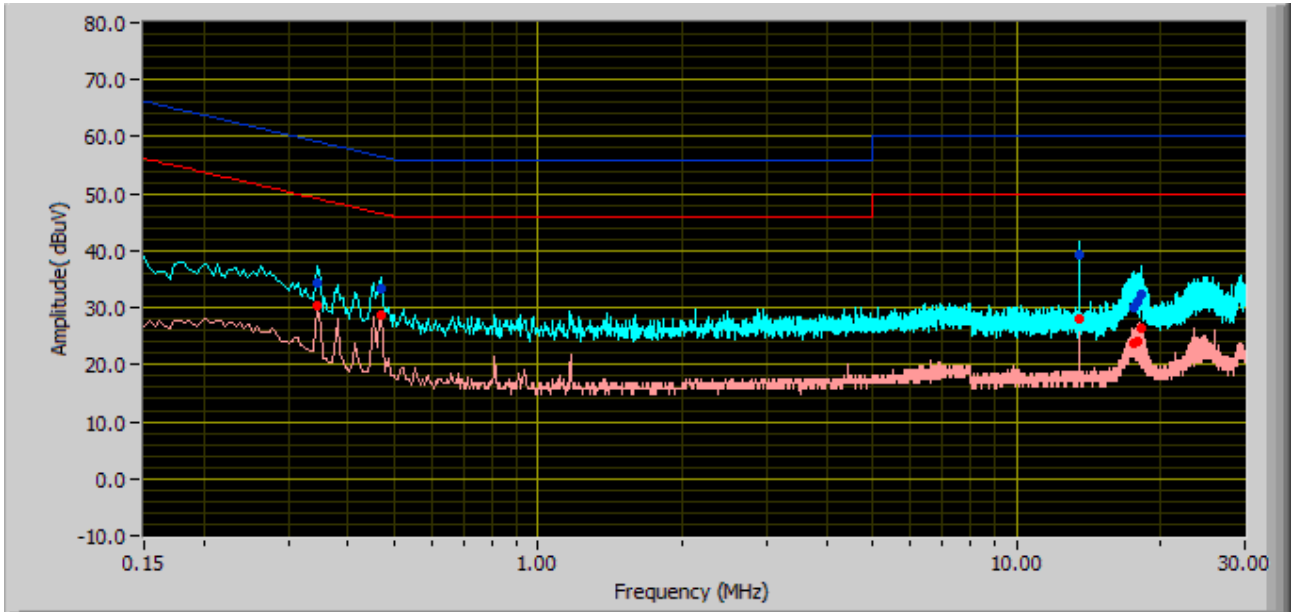

120V, 60Hz, Neutral Line

Frequency (MHz)	QP Value (dBµV)	Class B Limit (dB)	Pass / Fail	Margin (dB)	Avg Value (dBµV)	Class B Limit (dB)	Pass / Fail	Margin (dB)	Line
13.56	39.39	60.00	Pass	-20.61	27.99	50.00	Pass	-22.01	Neutral
0.47	33.28	56.52	Pass	-23.24	28.76	46.52	Pass	-17.76	Neutral
0.35	34.31	59.11	Pass	-24.81	30.27	49.11	Pass	-18.84	Neutral
18.15	32.42	60.00	Pass	-27.58	26.55	50.00	Pass	-23.45	Neutral
17.55	30.16	60.00	Pass	-29.84	23.73	50.00	Pass	-26.27	Neutral
17.90	30.92	60.00	Pass	-29.08	24.15	50.00	Pass	-25.85	Neutral

Quasi-Peak Limit

Average Limit

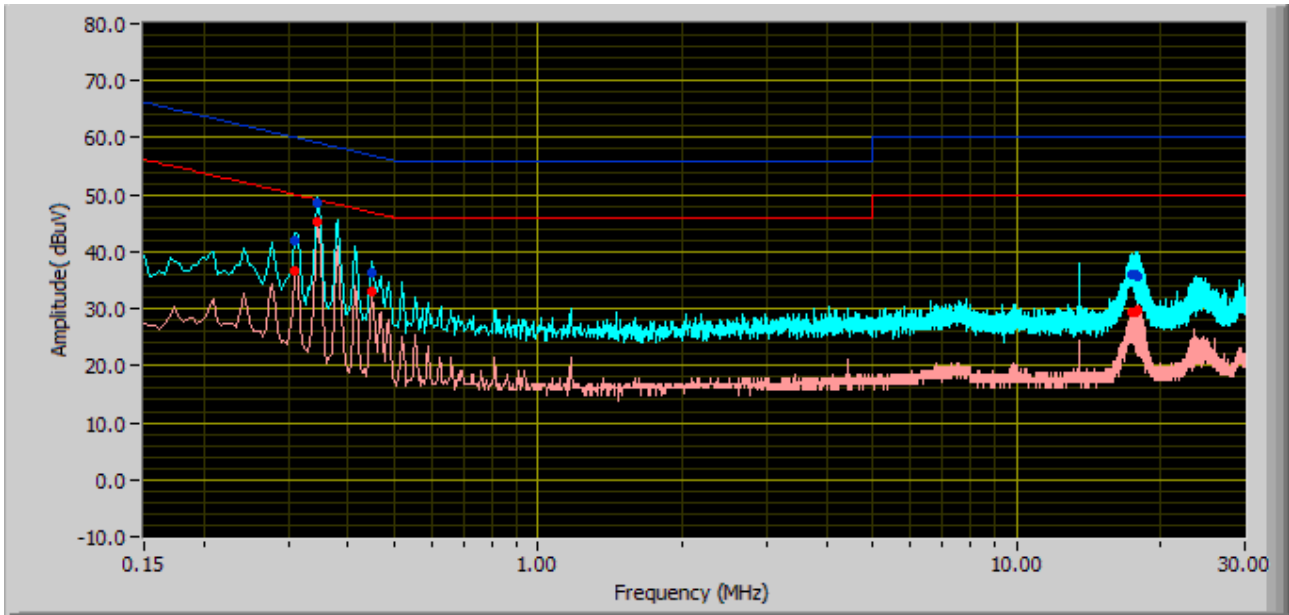

120V, 60Hz, Phase Line

Frequency (MHz)	QP Value (dBµV)	Class B Limit (dB)	Pass / Fail	Margin (dB)	Avg Value (dBµV)	Class B Limit (dB)	Pass / Fail	Margin (dB)	Line
0.35	48.45	59.11	Pass	-10.66	45.42	49.11	Pass	-3.70	Phase
0.31	41.98	60.04	Pass	-18.06	36.63	50.04	Pass	-13.42	Phase
0.45	36.36	56.89	Pass	-20.53	32.92	46.89	Pass	-13.96	Phase
17.80	35.87	60.00	Pass	-24.13	29.53	50.00	Pass	-20.47	Phase
17.91	35.56	60.00	Pass	-24.44	29.75	50.00	Pass	-20.25	Phase
17.46	35.85	60.00	Pass	-24.15	29.31	50.00	Pass	-20.69	Phase

Test Setup Photo



Conducted Emission Test Setup – Front View (Pig-Tail Connectors)

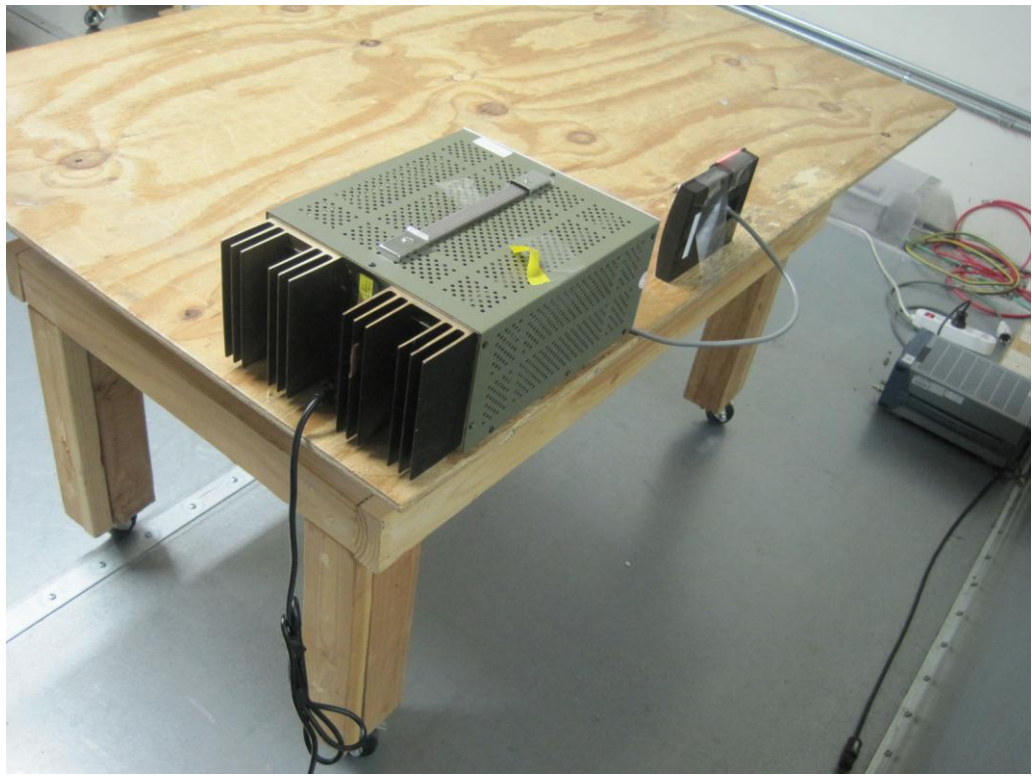

Conducted Emission Test Setup – Rear View (Pig-Tail Connectors)



Conducted Emission Test Setup – Front View (Terminal Connectors)

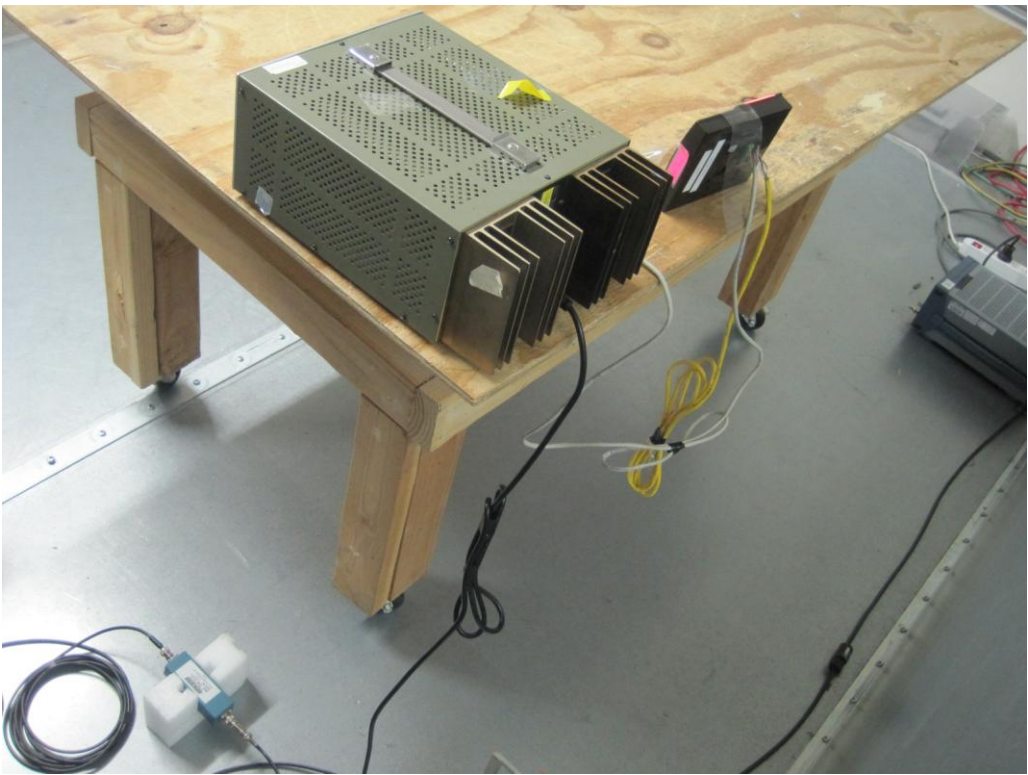

Conducted Emission Test Setup – Rear View (Terminal Connectors)

5.3 Radiated Emission < 30MHz (9kHz - 30MHz, H-Field)

Requirement(s): 47 CFR §15.225 & RSS-210 (A2.6) & RSS-310 (3.7)

Procedures: For < 30MHz, Radiated emissions were measured according to ANSI C63.4. The EUT was set to transmit at the highest output power. The EUT was set 10 meter away from the measuring antenna. The loop antenna was positioned 1 meter above the ground from the centre of the loop. The measuring bandwidth was set to 10 kHz. (Note: During testing the receive antenna was rotated about its axis to maximize the emission from the EUT.)

The limit is converted from microvolt/meter to decibel microvolt/meter.

Sample Calculation: Corrected Amplitude = Raw Amplitude (dBµV/m) + ACF (dB) + Cable Loss (dB) – Distance Correction Factor

1. All possible modes of operation were investigated. Only the 6 worst case emissions measured, using the correct CISPR detectors, are reported. All other emissions were relatively insignificant.
2. A "-ve" margin indicates a PASS as it refers to the margin present below the limit line at the particular frequency.
3. Radiated Emissions Measurement Uncertainty
All test measurements carried out are traceable to national standards. The uncertainty of the measurement at a confidence level of approximately 95% (in the case where distributions are normal), with a coverage factor of 2, is +/- 6dB.

4.	Environmental Conditions	Temperature Relative Humidity Atmospheric Pressure	20°C 65% 1019mbar
	Test Date : Dec 12th - Dec 16th 2011 Tested By : Yao Li		

Results: NA

5.4 Radiated Emissions > 30 MHz (30MHz – 1 GHz, E-Field)

Requirement(s): 47 CFR §15.209; 47 CFR §15.225(d) & RSS-210 (A2.6)

Procedures: For > 30MHz, Radiated emissions were measured according to ANSI C63.4. The EUT was set to transmit at the highest output power. The EUT was set 10 meter away from the measuring antenna. The Log periodic antenna was positioned 1 meter above the ground from the centre of the antenna. The measuring bandwidth was set to 120 kHz. (Note: During testing the receive antenna was raise from 1~4 meters to maximize the emission from the EUT.)

The limit is converted from microvolt/meter to decibel microvolt/meter.

Sample Calculation: Corrected Amplitude = Raw Amplitude (dBμV/m) + ACF (dB) + Cable Loss(dB) – Distance Correction Factor

1. All possible modes of operation were investigated. Only the 6 worst case emissions measured, using the correct CISPR detectors, are reported. All other emissions were relatively insignificant.
2. A “-ve” margin indicates a PASS as it refers to the margin present below the limit line at the particular frequency.
3. Radiated Emissions Measurement Uncertainty
All test measurements carried out are traceable to national standards. The uncertainty of the measurement at a confidence level of approximately 95% (in the case where distributions are normal), with a coverage factor of 2, is +/- 6dB.
4. Environmental Conditions

Temperature	21°C
Relative Humidity	62%
Atmospheric Pressure	1019mbar

Test Date : Dec 12th - Dec 16th 2011
 Tested By : Yao Li

Results: Pass

Test Result

RKCL40A Pig-Tail Connectors

General Emission Limit @ 3 meter

30MHz ~ 1000MHz

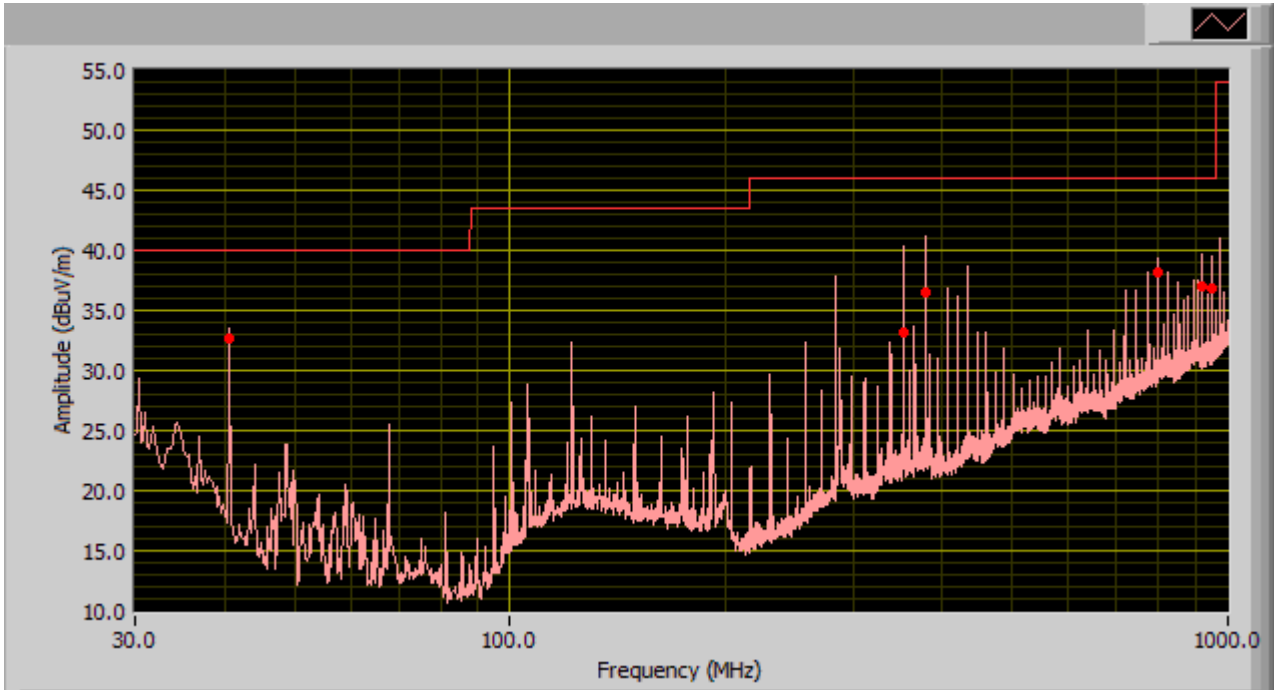

Radiated Emission Test Table 30MHz ~ 1000MHz

Frequency (MHz)	Amplitude @ 3m	Azimuth (degree)	Antenna Polarity	Antenna Height (cm)	Limit @ 3 meter	Margin (dB)
379.69	36.46	278.00	H	260.00	46.00	-9.54
352.51	33.19	333.00	H	158.00	46.00	-12.81
922.10	37.06	139.00	V	121.00	46.00	-8.94
40.70	32.63	91.00	V	161.00	40.00	-7.37
949.23	36.82	174.00	V	149.00	46.00	-9.18
800.05	38.23	268.00	H	105.00	46.00	-7.77

RKCL40A Terminal Connectors

General Emission Limit @ 3 meter

30MHz ~ 1000MHz

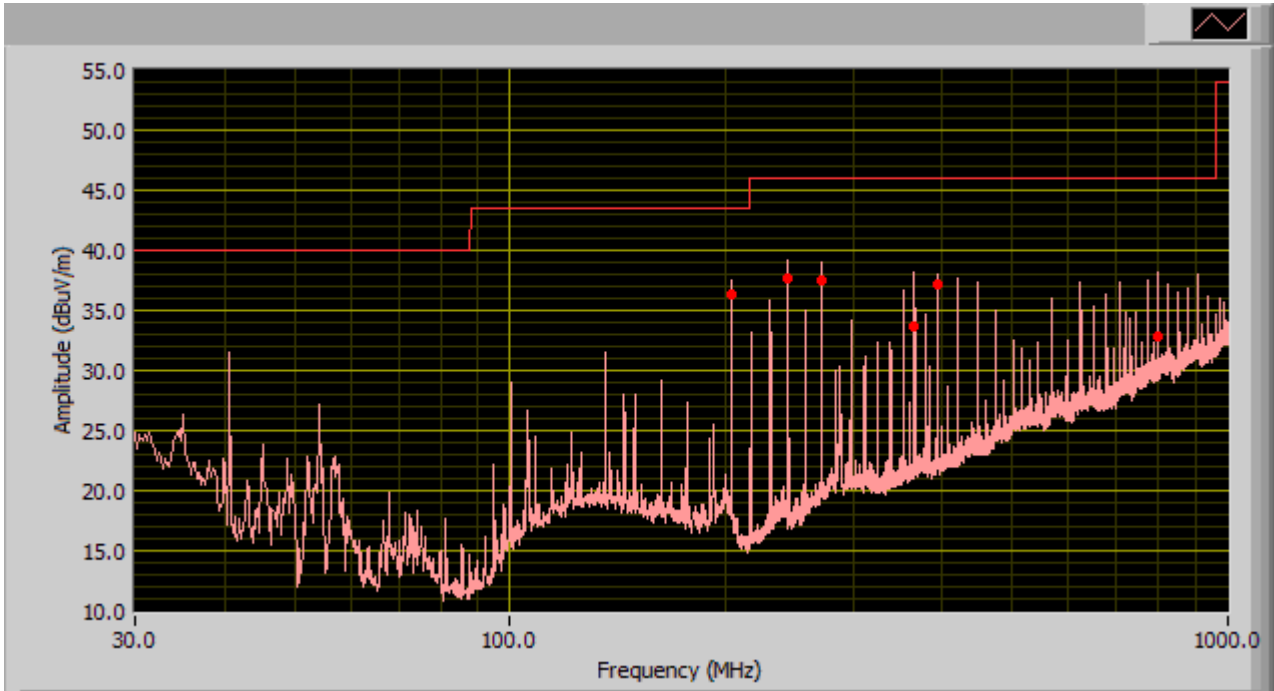

Radiated Emission Test Table 30MHz ~ 1000MHz

Frequency (MHz)	Amplitude @ 3m	Azimuth (degree)	Antenna Polarity	Antenna Height (cm)	Limit @ 3 meter	Margin (dB)
203.39	36.31	280.00	H	143.00	43.50	-7.19
244.09	37.62	254.00	H	128.00	46.00	-8.38
271.21	37.48	243.00	H	105.00	46.00	-8.52
366.14	33.69	243.00	V	285.00	46.00	-12.31
800.04	32.78	41.00	H	329.00	46.00	-13.22
393.26	37.11	174.00	V	100.00	46.00	-8.89

Test Setup Photo



Radiated Emission Test Setup – Front View (Pig-Tail Connectors)

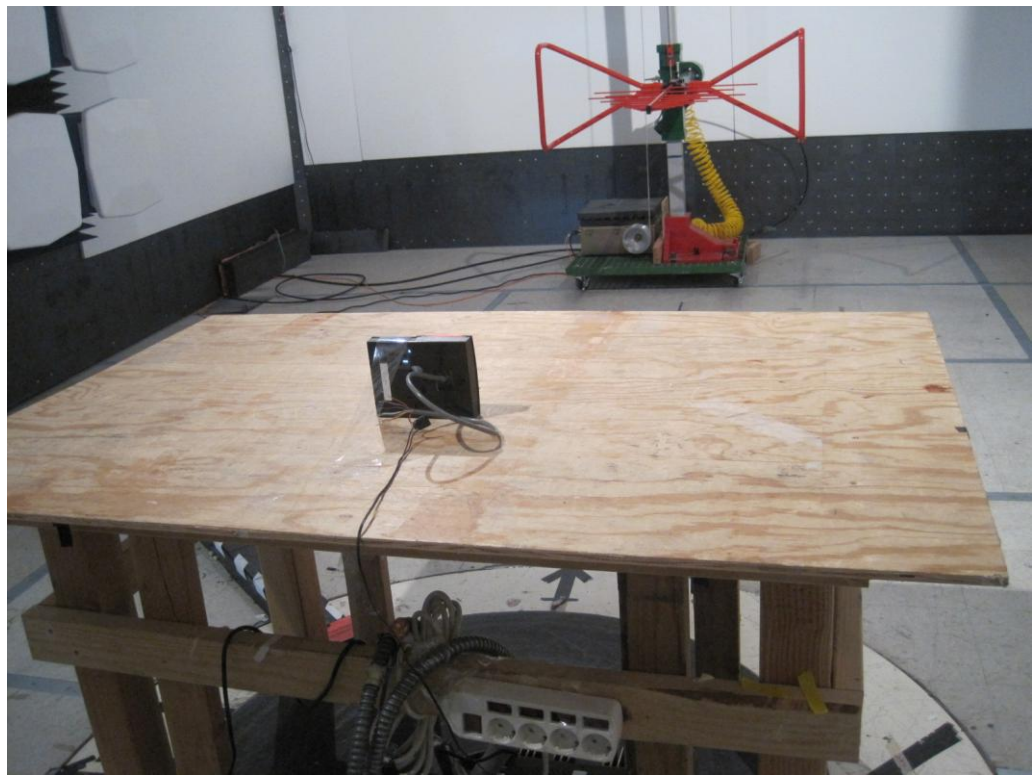

Radiated Emission Test Setup – Rear View (Pig-Tail Connectors)



Radiated Emission Test Setup – Front View (Terminal Connectors)



Radiated Emission Test Setup – Rear View (Terminal Connectors)

5.5 Frequency Stability

Requirement(s): 47 CFR §15.225(e) & RSS-210 (A2.6)

Procedures: Frequency Stability was measured according to 47 CFR §2.1055. Measurement was taken with spectrum analyzer. The spectrum analyzer bandwidth and span was set to read in hertz. A voltmeter was used to monitor when varying the voltage.

Limit: $\pm 0.01\%$ of 13.56 MHz = 1356 Hz

Environmental Conditions	Temperature	23°C
	Relative Humidity	51%
	Atmospheric Pressure	1019mbar

Test Date : Dec 12th - Dec 16th 2011

Tested By : Yao Li

Results: NA

5.7 Occupied Bandwidth

Requirement(s): RSS-210 (5.9.1)

Procedures: Occupied Bandwidth was measured according to RSS-210 (5.9.1). Measurement was taken with spectrum analyzer. The spectrum analyzer bandwidth and span was set to read in hertz.

Environmental Conditions	Temperature	23°C
	Relative Humidity	50%
	Atmospheric Pressure	1019mbar

Test Date : NA
Tested By : Yao Li

Results: NA

Annex A. TEST INSTRUMENT & METHOD

Annex A.i. TEST INSTRUMENTATION & GENERAL PROCEDURES

Instrument	Model	Calibration Due
AC Conducted Emissions		
R&S EMI Test Receiver	ESIB40	05/19/2012
R&S LISN	ESH3-Z5	05/18/2012
CHASE LISN	MN2050B	05/18/2012
Sekonic Hygro Hermograph	ST-50	06/04/2012
Radiated Emissions		
Spectrum Analyzer	8564E	05/17/2012
EMI Receiver	ESIB 40	05/19/2012
R&S LISN	ESH3-Z5	05/18/2012
CHASE LISN	MN2050B	05/18/2012
Horn Antenna (1 ~18GHz)	3115	06/02/2012
Biconlog Antenna (30MHz~2GHz)	JB1	06/01/2012
Passive Loop Antenna (10kHz-30MHz)	6512	08/31/2012
3 Meters SAC	3m	10/13/2012
Sekonic Hygro Hermograph	ST-50	06/04/2012
Pre-Amplifier(1 ~ 26GHz)	8449B	05/17/2012
Horn Antenna (18~40GHz)	AH-840	07/23/2013
Microwave Pre-Amp (18~40GHz)	PA-840	11/30/2012
Environmental Monitoring		
Sekonic Hygro Hermograph	ST-50	06/04/2012

Annex A.ii. CONDUCTED EMISSIONS TEST DESCRIPTION

Test Set-up

1. The EUT and supporting equipment were set up in accordance with the requirements of the standard on top of a 1.5m x 1m x 0.8m high, non-metallic table, as shown in Annex B.
2. The power supply for the EUT was fed through a 50Ω/50μH EUT LISN, connected to filtered mains.
3. The RF OUT of the EUT LISN was connected to the EMI test receiver via a low-loss coaxial cable.
4. All other supporting equipments were powered separately from another main supply.

Test Method

1. The EUT switched on and allowed to warm up to its normal operating condition.
2. A scan was made on the NEUTRAL line (for AC mains) or Earth line (for DC power) over the required frequency range using an EMI test receiver.
3. High peaks, relative to the limit line, were then selected.
4. The EMI test receiver was then tuned to the selected frequencies and the necessary measurements made with a receiver bandwidth setting of 10 KHz. For FCC tests, only Quasi-peak measurements made; while for CISPR/EN tests, both Quasi-peak and Average measurements made.
5. Steps 2 to 4 then repeated for the LIVE line (for AC mains) or DC line (for DC power).

Description of Conducted Emission Program

This EMC Measurement software run LabView automation software and offers a common user interface for electromagnetic interference (EMI) measurements. This software is a modern and powerful tool for controlling and monitoring EMI test receivers and EMC test systems. It guarantees reliable collection, evaluation, and documentation of measurement results. Basically, this program will run a pre-scan measurement before it proceeds with the final measurement. The pre-scan routine will run the common scan range from 15 kHz to 30 MHz; the program will first start a peak and average scan on selectable measurement time and step size. After the program complete the pre-scan, this program will perform the Quasi Peak and Average measurement, based on the pre-scan peak data reduction result.

Sample Calculation Example

At 20 MHz	limit = 250 μV = 47.96 dBμV
Transducer factor of LISN, pulse limiter & cable loss at 20 MHz = 11.20 dB	
Q-P reading obtained directly from EMI Receiver = 40.00 dBμV (Calibrated for system losses)	
Therefore, Q-P margin = 47.96 – 40.00 = 7.96	i.e. 7.96 dB below limit

Annex A. iii RADIATED EMISSIONS TEST DESCRIPTION

EUT Characterisation

EUT characterisation, over the frequency range from 100kHz – 1GHz to 10th Harmonic , was done in order to minimise radiated emissions testing time while still maintaining high confidence in the test results.

The EUT was placed in the chamber, at a height of about 0.8m on a turntable. Its radiated emissions frequency profile was observed, using a spectrum analyzer /receiver with the appropriate broadband antenna placed 3m away from the EUT. Radiated emissions from the EUT were maximised by rotating the turntable manually, changing the antenna polarisation and manipulating the EUT cables while observing the frequency profile on the spectrum analyzer / receiver. Frequency points at which maximum emissions occurred; clock frequencies and operating frequencies were then noted for the formal radiated emissions test at the Open Area Test Site (OATS) at 10m distance.

Test Set-up

1. The EUT and supporting equipment were set up in accordance with the requirements of the standard on top of a 1.5m X 1.0m X 0.8m high, non-metallic table.
2. The filtered power supply for the EUT and supporting equipment were tapped from the appropriate power sockets located on the turntable.
3. The relevant broadband antenna was set at the required test distance away from the EUT and supporting equipment boundary.

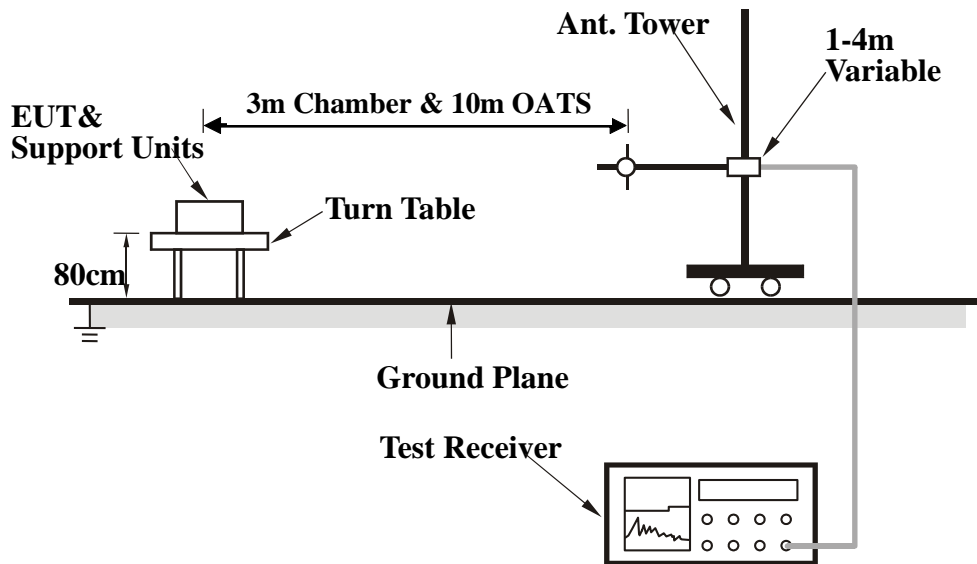

Test Method

The following procedure was performed to determine the maximum emission axis of EUT:

1. With the receiving antenna is H polarization, rotate the EUT in turns with three orthogonal axes to determine the axis of maximum emission.
2. With the receiving antenna is V polarization, rotate the EUT in turns with three orthogonal axes to determine the axis of maximum emission.
3. Compare the results derived from above two steps. So, the axis of maximum emission from EUT was determined and the configuration was used to perform the final measurement.

Final Radiated Emission Measurement

1. Setup the configuration according to figure 1. Turn on EUT and make sure that it is in normal function.
2. For emission frequencies measured below 1 GHz, a pre-scan is performed in a shielded chamber to determine the accurate frequencies of higher emissions will be checked on a open test site. As the same purpose, for emission frequencies measured above 1 GHz, a pre-scan also be performed with a 1 meter measuring distance before final test.
3. For emission frequencies measured below 1 GHz, set the spectrum analyzer on a 100 kHz and 1 MHz resolution bandwidth respectively for each frequency measured in step 2.
4. The search antenna is to be raised and lowered over a range from 1 to 4 meters in horizontally polarized orientation. Position the highness when the highest value is indicated on spectrum analyzer, then change the orientation of EUT on test table over a range from 0° to 360° with a speed as slow as possible, and keep the azimuth that highest emission is indicated on the spectrum analyzer. Vary the antenna position again and record the highest value as a final reading.
5. Repeat step 4 until all frequencies need to be measured were complete.
6. Repeat step 5 with search antenna in vertical polarized orientations.

During the radiated emission test, the Spectrum Analyzer was set with the following configurations:

Frequency Band (MHz)	Function	Resolution bandwidth	Video Bandwidth
30 to 1000	Peak	100 kHz	100 kHz
Above 1000	Peak	1 MHz	1 MHz
	Average	1 MHz	10 Hz

Description of Radiated Emission Program

This EMC Measurement software run LabView automation software and offers a common user interface for electromagnetic interference (EMI) measurements. This software is a modern and powerful tool for controlling and monitoring EMI test receivers and EMC test systems. It guarantees reliable collection, evaluation, and documentation of measurement results. Basically, this program will run a pre-scan measurement before it proceeds with the final measurement. The pre-scan routine will run the scan on four different antenna heights, 2 antenna polarity, and 360 degrees table rotation. For example, the program was set to run 30 MHz to 1 GHz scan; the program will first start from a meter antenna height and divide the 30 MHz to 1 GHz into 10 separate parts of maximum hold sweeps. Each parts of maximum hold sweep, the program will collect the data from 0 degree to 360 degrees table rotation. After the program complete the 1m scan, the antenna continues to rise to 2m and continue the scan. The step will repeated for all specified antenna height and polarity. This program will perform the Quasi Peak measurement after the signal maximization process and pre-scan routine. The final measurement will be base on the pre-scan data reduction result.

Sample Calculation Example

The field strength is calculated by adding the Antenna Factor and Cable Factor, and subtracting the Amplifier Gain (if any) from the measured reading. For the limit is employed average value, therefore the peak value can be transferred to average value by subtracting the duty factor. The basic equation with a sample calculation is as follows:

$$\text{Peak} = \text{Reading} + \text{Corrected Factor}$$

Where:

$$\text{Corr. Factor} = \text{Antenna Factor} + \text{Cable Factor} - \text{Amplifier Gain (if any)}$$

And the average value is

$$\begin{aligned} \text{Average} &= \text{Peak Value} + \text{Duty Factor or} \\ \text{Set RBW} &= 1\text{MHz, VBW} = 10\text{Hz.} \end{aligned}$$

Note:

If the measured frequencies are fall in the restricted frequency band, the limit employed must be quasi peak value when frequencies are below or equal to 1 GHz. And the measuring instrument is set to quasi peak detector function.

Annex B. TEST SETUP PHOTOGRAPHS

Please See Attachment

Annex B. i. EUT INTERNAL PHOTOGRAPHS

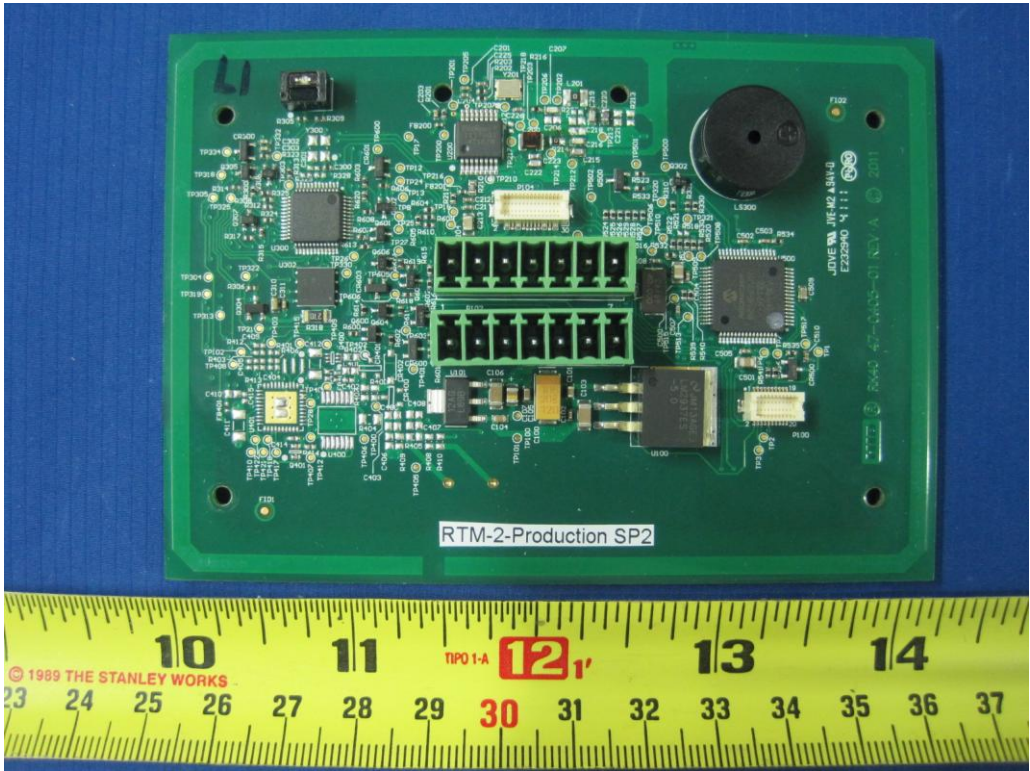

RKCL40A Terminal Front View

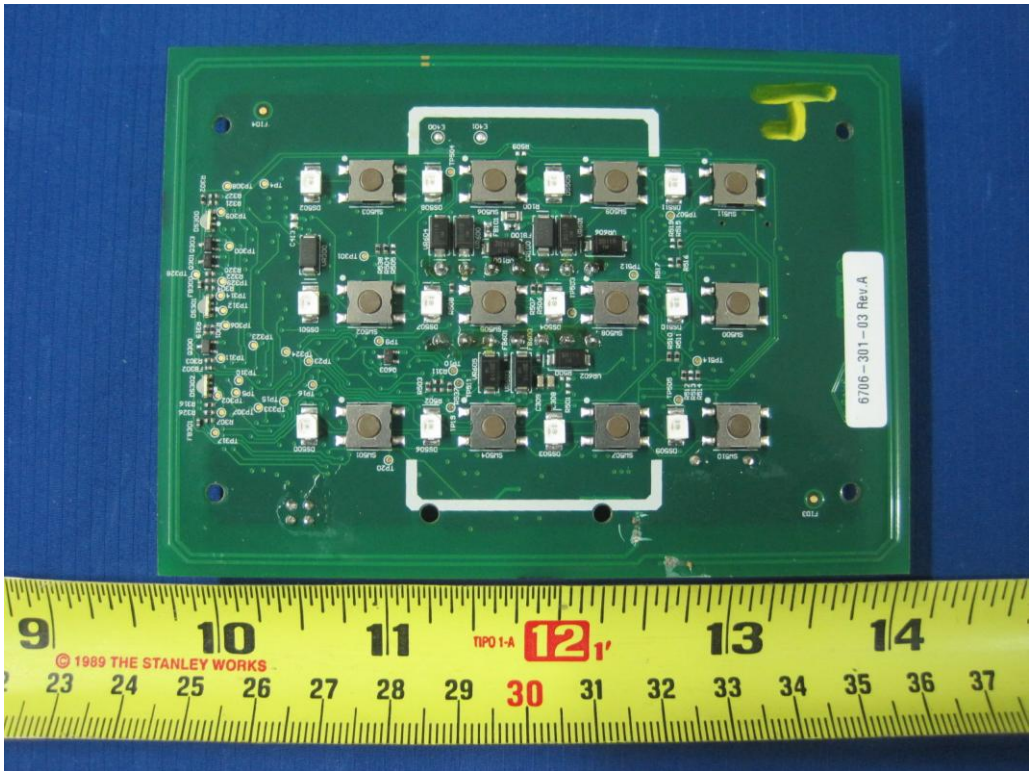

RKCL40A Terminal Back View

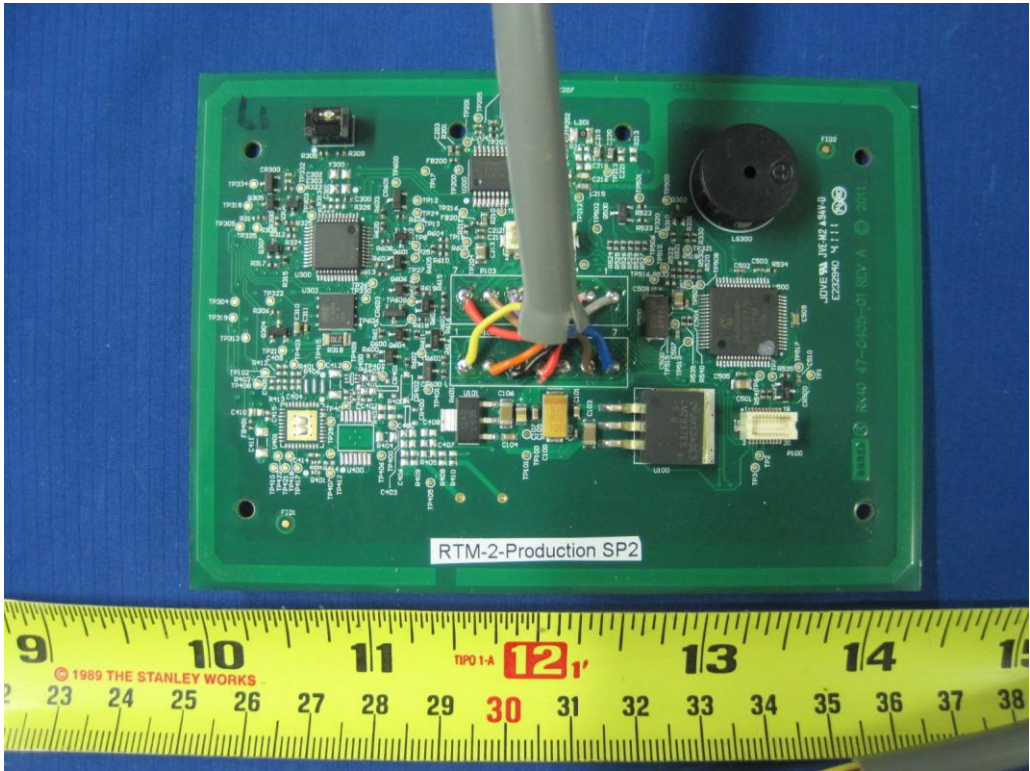

RKCL40A Pig Tail Front View

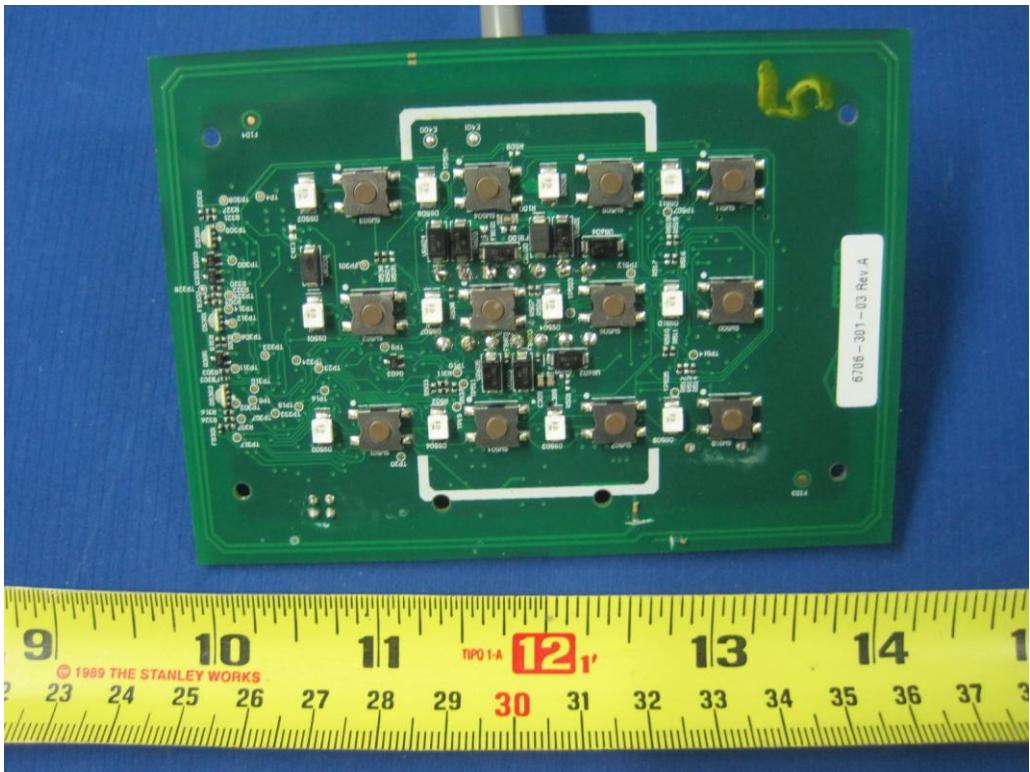

RKCL40A Pig Tail Back View

Annex B. ii. EUT EXTERNAL PHOTOGRAPHS



Terminal Front View

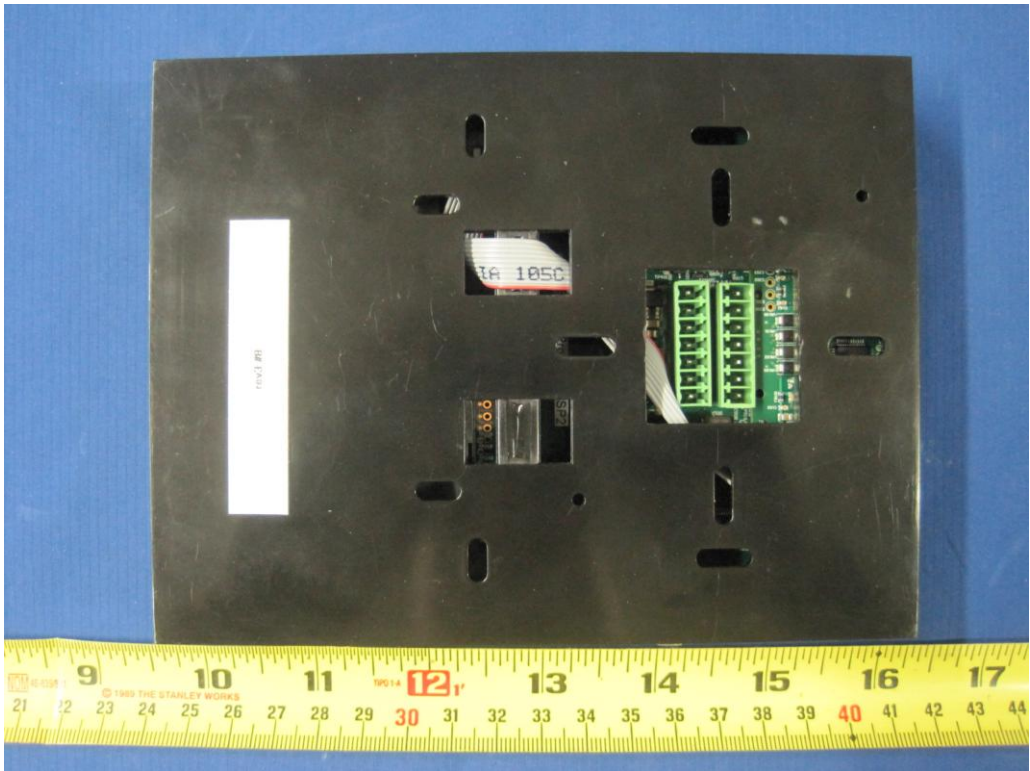

Terminal Back View



Terminal Top View



Terminal Bottom View



Terminal Left View



Terminal Right View



Pig Tail Front View

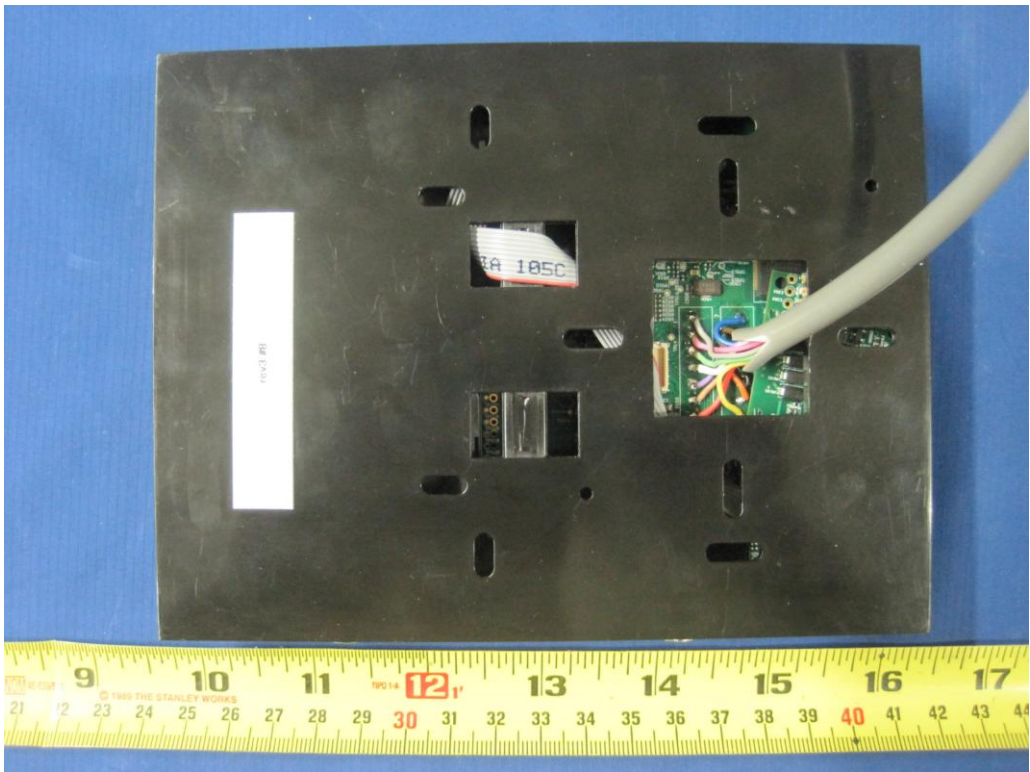

Pig Tail Back View



Pig Tail Top View



Pig Tail Bottom View

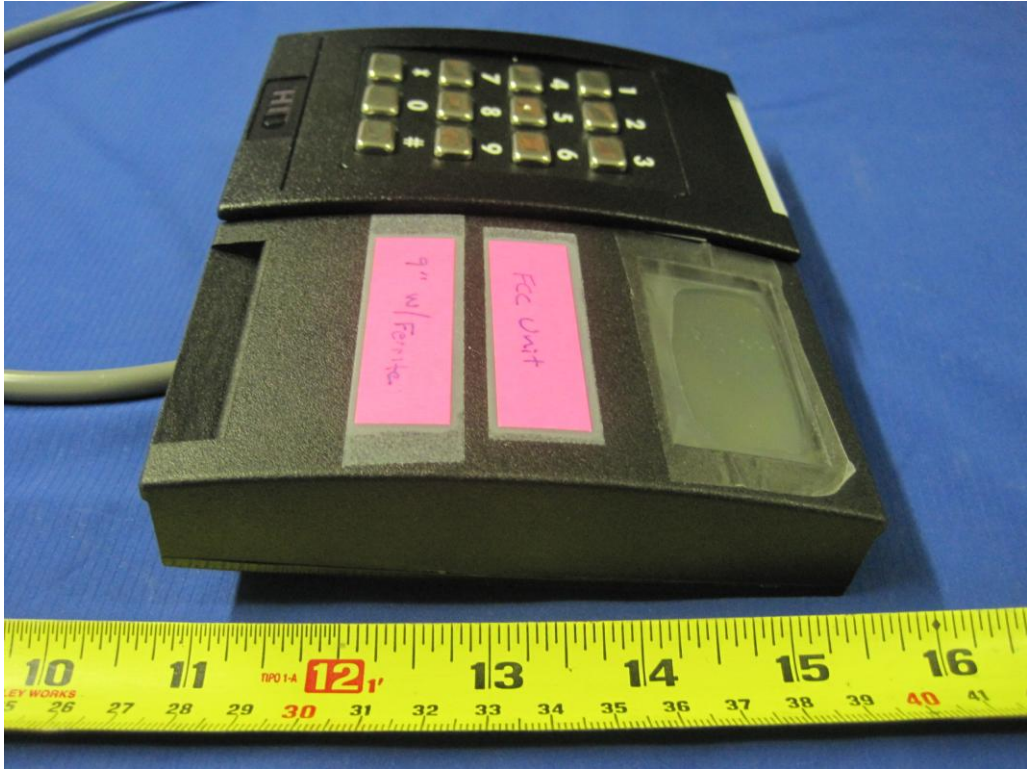

Pig Tail Left View



Pig Tail Right View

Annex C. SUPPORTING EQUIPMENT DESCRIPTION

The following is a description of supporting equipment and details of cables used with the EUT.

Equipment Description (Including Brand Name)	Model & Serial Number	Cable Description (List Length, Type & Purpose)
N/A	N/A	N/A

NOTE: No special supporting equipment used or needed during testing to achieve compliance.

Block Configuration Diagram for Radiated Emission

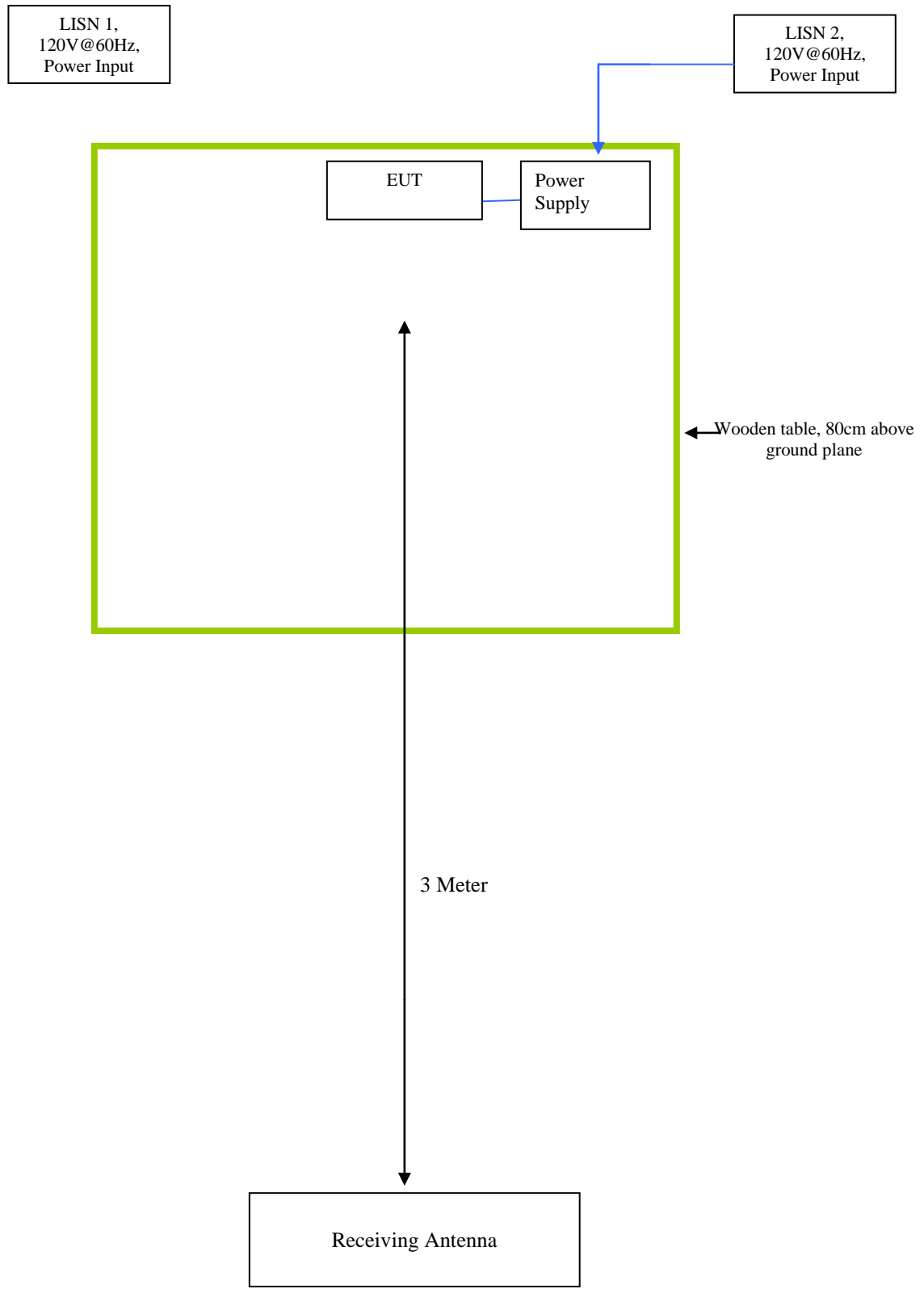

Block Configuration Diagram for AC Conducted Emission

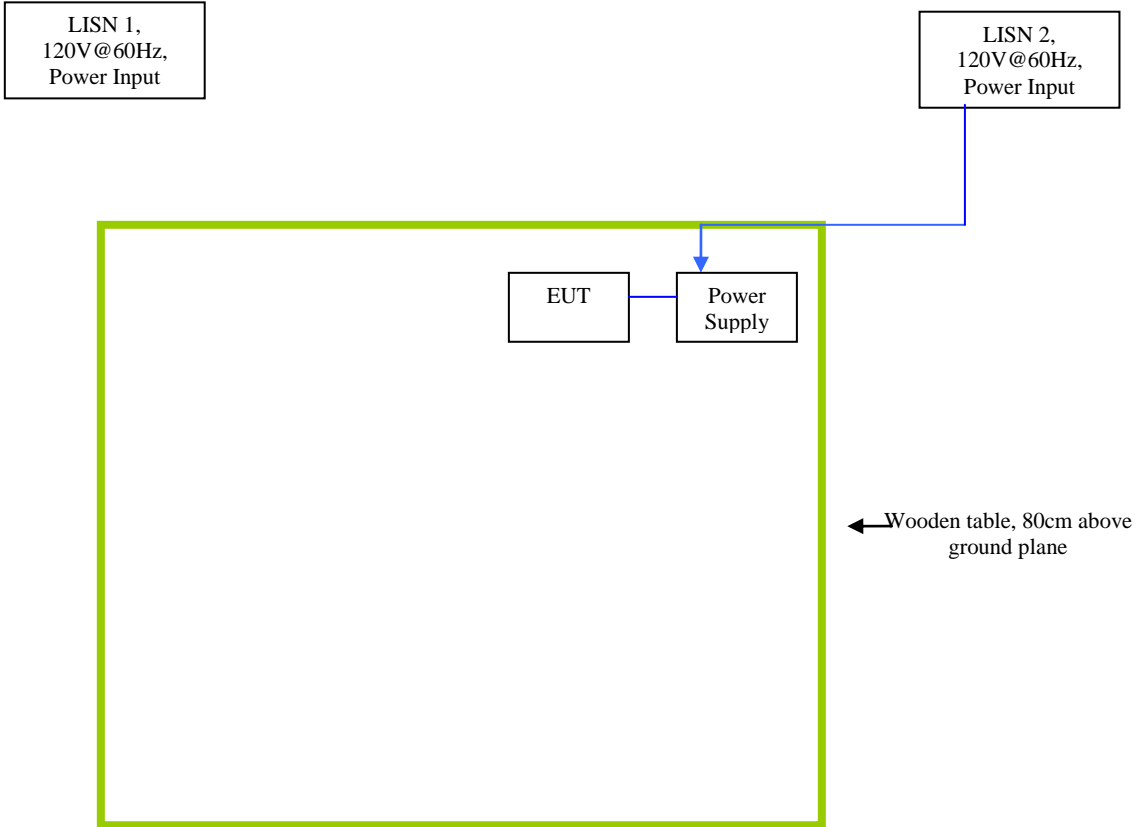

Annex D. EUT OPERATING CONDITIONS

The following is the description of how the EUT is exercised during testing.

Test	Description Of Operation
Emissions Testing	The EUT was set to continuously working during testing.

Annex E. USER MANUAL, BLOCK & CIRCUIT DIAGRAM

Please see attachment

Annex E SIEMIC ACCREDITATION

SIEMIC ACCREDITATION DETAILS: A2LA 17025 & ISO Guide 65 : 2742.01 , 2742.2

  **The American Association for Laboratory Accreditation**
World Class Accreditation

Accredited Laboratory

A2LA has accredited

SIEMIC LABORATORIES
San Jose, CA
for technical competence in the field of
Electrical Testing

This laboratory is accredited in accordance with the recognized International Standard ISO/IEC 17025:2005 *General Requirements for the Competence of Testing and Calibration Laboratories*. This accreditation demonstrates technical competence for a defined scope and the operation of a laboratory quality management system (refer to joint ISO-ILAC-LAF Communiqué dated 8 January 2009).

Presented this 23rd day of November 2010.



Peter Noyce
President & CEO
For the Accreditation Council
Certificate Number 2742.01
Valid to September 30, 2012

For the tests or types of tests to which this accreditation applies, please refer to the laboratory's Electrical Scope of Accreditation.



The American Association for Laboratory Accreditation

SCOPE OF ACCREDITATION TO ISO/IEC 17025:2005

SIEMIC LABORATORIES¹

2206 Ringwood Ave.
 San Jose, CA 95131

Mr. Leslie Bai Phone: 408 526 1188 Email: leslie.bai@siemic.com
 Mr. Snell Leong Phone: 408 526 1188 Email: snell.leong@siemic.com
 www.siemic.com

ELECTRICAL

Valid to: September 30, 2012

Certificate Number: 2742.01

In recognition of the successful completion of the A2LA evaluation process, accreditation is granted to this laboratory to perform the following EMC, Product Safety, Radio and Telecommunication tests:

<u>Test Description:</u>	<u>Test Method:</u>
EN & IEC – Emissions & Immunity	IEC/CISPR 11; IEC/CISPR 12; EN 55011; IEC/CISPR 22; EN 55022; IEC/CISPR 20; EN 55020; EN 61000-6-1; EN 61000-6-2; EN 61000-6-3; EN 61000-6-4; EN 61204-3; EN 61326, EN 61326-1; EN 61000-3-2; EN 61000-3-3; EN 50081-1, EN 50081-2; EN 50082-1; IEC 61000-4-2; EN 61000-4-2; IEC 61000-4-3 (limited up to 2.7 GHz and 3V/m); EN 61000-4-3; (limited up to 2.7 GHz and 3V/m); IEC 61000-4-4; EN 61000-4-4; IEC 61000-4-5; EN 61000-4-5; IEC 61000-4-6; EN 61000-4-6; IEC 61000-4-8; EN 61000-4-8; IEC 61000-4-11; EN 61000-4-11; IEC/CISPR 24; EN 55024; EN 50412-2-1; EN 50083-2; EN 50090-2-2; EN 50091-2; EN 50130-4; EN 50130-4 +A12; IEC 60601-1-2; EN 12184; EN 55015; EN 61547; CISPR 16-1-4
Korea – Emissions & Immunity	KCC Notice 2009-27, Nov. 5, 2009; RRA Announce 2009-9, Dec. 21, 2009; KN 22:2007-12; KCC Notice 2009-27, Nov. 5, 2009; RRA Notice 2009-10, Dec. 21, 2009; KN 24:2008-5; KN 61000-4-2:2008-5; KN 61000-4-3:2008-5; KN 61000-4-4:2008-5; KN 61000-4-5:2008-5; KN 61000-4-6:2008-5; KN 61000-4-8:2008-5; KN 61000-4-11:2008-5; RRL Notice 2008-3; RRL Notice 2008-4; RRL Notice 2005-131; RRL Notice 2007-99; RRL Notice 2007-101; RRL Notice 2008-4; RRA Notice No 2008-11(2008.12.16); RRA Notice No 2008-12(2008.12.16); KN 60601-1-2; KCC Notice 2009-27; KN 301 489-1(2008-05); KN 301 489-7(2008-05); KN 301 489-17(2008-05); KN 301 489-24(2008-05); KN 16-1-1(2008-05); KN 16-1-2(2008-05); KN 16-1-3(2008-05); KN 16-1-4(2008-05); KN 16-1-5(2008-05); KN 16-2-1(2008-05); KN 16-2-2(2008-05); KN 16-2-3(2008-05); KN 16-2-4(2008-05)

(A2LA Certificate No. 2742.01) Revised 01/12/2011

Page 1 of 8



US / FCC - Emissions	SAE J1113-11, SAE J1113-12; SAE J1113-41; SAE J1113-4; SAE J1113-13; FCC Method 47 CFR Part 18, FCC Report and Order ET Docket 98-153 (FCC 02-48); FCC Method 47 CFR Parts 15, including Subpart G, using FCC Order 04-425 ANSI C63.4(2009); ANSI C63.10(2009); ANSI C63.4:2003 ANSI C63.4(2003) with FCC Method 47 CFR Part 11; ANSI C63.4(2003) with FCC Method 47 CFR Part 15, Subpart E; ANSI C63.4(2003) with FCC Method 47 CFR Part 15, Subpart C; ANSI C63.4(2003) and DA 02-2138; ANSI C63.4(2003) with FCC Method 47 CFR Part 15, Subpart B
Canada – Emissions	ICES-001; ICES-002; ICES-003 Issue 4; ICES-003 Issue 4 (2004); ICES-006 Issue 1
Vietnam – Emission & Immunity	TCN 68-193:2003; TCN 68-196:2001; TCVN 7189:2002
Australia / New Zealand – Emissions and Immunity	AS/NZS 1044; AS/NZS 4251.1; AS/NZS 4251.2; AS/NZS CISPR 22; AS/NZS 3548; AS/NZS 2279.3; AS/NZS 61000-3-3; AS/NZS CISPR 11; AS/NZS CISPR 24; AS/NZS 61000.6.3; AS/NZS 61000.6.4; AS/NZS CISPR 14.1; AS/NZS 61000.3.2
Japan – Emissions	JEITA IT-3001; VCCI-V-3:2010.4 (up to 6 GHz)
China – Emissions	GB9254; GB17625.1
Taiwan – Emissions	CNS 13438 (up to 6 GHz); CNS 13783-1; CNS 13803; CNS 13439
Singapore – Emissions & Immunity	IDA TS EMC; CISPR 22; IEC 61000-4-2; IEC 61000-4-3; IEC 61000-4-4; IEC 61000-4-5; IEC 61000-4-6
FCC – Unlicensed Radio A1 to A4	A1: 47 CFR Parts 11 (Emergency Alert System (EAS)), 15 (Radio Frequency Devices) and 18 (Industrial, Scientific, and Medical Equipment); FCC OST/MP-5(1986); ANSI C63.4(2003); ANSI C63.4(2009); ANSI C63.10(2009) A2: 47 CFR Part 15 (Radio Frequency Devices); ANSI C63.4(2003); ANSI C63.4(2009); ANSI C63.10(2009) A3: 47 CFR Part 15 (Radio Frequency Devices); ANSI C63.17:2006; ANSI C63.10(2009); IEEE Std 1528:2003 + Ad1; Std IEEE 1528A:2005 A4: 47 CFR Part 15 (Radio Frequency Devices); ANSI C63.10(2009); IEEE Std 1528:2003 + Ad1; Std IEEE 1528A:2005
FCC – Licensed Radio B1 to B4	B1: 47 CFR Parts 2 (Frequency Allocations and Radio Treaty Matters; General Rules and Regulations), 22 (Public Mobile Services), 24 (Personal Communications Services), 25 (Satellite Communications), and 27 (Miscellaneous Wireless Communications Services); ANSI/TIA-603-C (2004), Land Mobile FM or PM Communications Equipment Measurement and Performance Standard; IEEE Std 1528:2003 + Ad1; Std IEEE 1528A:2005



<p>FCC – Licensed Radio (continued) B1 to B4</p>	<p>B2: 47 CFR Parts 2 (Frequency Allocations and Radio Treaty Matters; General Rules and Regulations), 22 (Public Mobile Services), 74 (Experimental Radio Auxiliary, Special Broadcast and Other Program Distributional Services), 90 (Private Land Mobile Radio Services), 95 (Personal Radio Services), and 97 (Amateur Radio Services); ANSI/TIA-603-C (2004), Land Mobile FM or PM Communications Equipment Measurement and Performance Standard</p> <p>B3: 47 CFR Parts 2 (Frequency Allocations and Radio Treaty Matters; General Rules and Regulations); 80 (Stations in the Maritime Services) , 87 (Aviation Services); ANSI/TIA-603-C (2004), Land Mobile FM or PM Communications Equipment Measurement and Performance Standard</p> <p>B4: 47 CFR Parts 2 (Frequency Allocations and Radio Treaty Matters; General Rules and Regulations); 27 (Broadband Radio Services (BRS) and Educational Broadband Services (EBS)), 74 (Experimental Radio Auxiliary, Special Broadcast and Other Program Distributional Services), and 101 (Fixed Microwave Services); ANSI/TIA-603-C (2004), Land Mobile FM or PM Communications Equipment Measurement and Performance Standard</p>
<p>Canada – Radio</p>	<p>RSS 102; RSS 111; RSS 112; RSS 117; RSS 118; RSS 119; RSS 123; RSS 125; RSS 127; RSS 128; RSS 129; RSS 131; RSS 132; RSS 133; RSS 134; RSS 135; RSS 136; RSS 137; RSS 138; RSS 139; RSS 141; RSS 142; RSS 170; RSS 181; RSS 182; RSS 188; RSS 191; RSS 192; RSS 193; RSS 194; RSS 195; RSS 196; RSS 197; RSS 198; RSS 199; RSS 210; RSS 220; RSS 213; RSS 215; RSS 243; RSS 287; RSS 310; RSS Gen</p>
<p>CE – Radio</p>	<p>EN 301 502; EN 301 511; EN 301 526; EN 301 681; EN 301 721; EN 301 751; EN 301 753; EN 301 783-2; EN 301 796; EN 301 797; EN 301 840-2; EN 301 843-1; EN 301 843-4; EN 301 843-5; EN 301 893; EN 301 908-01; EN 301 908-02; EN 301 908-03; EN 301 908-04; EN 301 908-05; EN 301 908-06; EN 301 908-07; EN 301 908-08; EN 301 908-09; EN 301 908-10; EN 301 908-11; EN 301 929-2; EN 301 997-2; EN 302 018-2; EN 302 054-2; EN 302 064-2; EN 302 066-2; EN 302 077-2; EN 302 186; EN 302 195-2; EN 302 217-3; EN 302 245-2; EN 302 288-2; EN 302 291-2; EN 302 296; EN 302 297; EN 302 326-2; EN 302 326-3; EN 302 340; EN 302 372-2; EN 302 426; EN 302 454-2; EN 302 502; EN 302 510-2;</p>
	<p>EN 302 217-4-2; EN 300 224-1; EN 300 279; EN 300 339; EN 300 385; EN 301 839-2; EN 301 843-6; EN 302 017-2; EN 302 208-2; EN 302 217-2-2; ETS 300 329; ETS 300 445; ETS 300 446; ETS 300 683; ETS 300 826; ETS EN 300 328; ETSI EN 300 086-2; EN 302217-1; EN 302217-2-1; EN 302217-4-1; EN 302288-1; EN 302908-12; EN 302326-1; EN 301929-1; EN 301997-1; EN 300224-2; EN 301839-1; EN 301843-1; EN 301843-2; EN 301843-3; EN 301843-4; EN 301843-5; EN 302017-1; EN 302208-1; EN 300086-1; EN 300113-1; EN 300224-1; EN 300341-1; EN 302291-1; EN 302500-1; EN 302500-2; ETSI EN 300 113-2; ETSI EN 300 197; ETSI EN 300 198; ETSI EN 300 219-1; ETSI EN 300 219-2; ETSI EN 300 220-1; ETSI EN 300 220-2; ETSI EN 300 220-3; ETSI EN 300 224-2; ETSI EN 300 296-1; ETSI EN 300 296-2; ETSI EN 300 328-1; ETSI EN 300 328-2; ETSI EN 300 330; ETSI EN 300 330-1; ETSI EN 300 330-2;</p>



CE – Radio (conitnued)	ETSI EN 300 341-2; ETSI EN 300 373-1; ETSI EN 300 373-2; ETSI EN 300 373-3; ETSI EN 300 390-1; ETSI EN 300 390-2; ETSI EN 300 422-1; ETSI EN 300 422-2; ETSI EN 300 431; ETSI EN 300 440-1; ETSI EN 300 440-2; ETSI EN 300 454-1; ETSI EN 300 454-2; ETSI EN 300 718-2; ETSI EN 301 021; ETSI EN 301 166-1; ETSI EN 301 166-2; ETSI EN 301 178-2; ETSI EN 301 213-1; ETSI EN 301 213-2; ETSI EN 301 213-3; ETSI EN 301 213-4; ETSI EN 301 213-5; ETSI EN 301 357-1; ETSI EN 301 357-2; ETSI EN 301 390; ETSI EN 301 459; ETSI EN 301 489-01(excluding section 9.6); ETSI EN 301 489-02; ETSI EN 301 489-03; ETSI EN 301 489-04; ETSI EN 301 489-05; ETSI EN 301 489-06; ETSI EN 301 489-07; ETSI EN 301 489-08; ETSI EN 301 489-09; ETSI EN 301 489-10; ETSI EN 301 489-11; ETSI EN 301 489-12; ETSI EN 301 489-13; ETSI EN 301 489-14; ETSI EN 301 489-15; ETSI EN 301 489-16; ETSI EN 301 489-17; ETSI EN 301 489-18; ETSI EN 301 489-19; ETSI EN 301 489-20; ETSI EN 301 489-22; ETSI EN 301 489-23; ETSI EN 301 489-24; ETSI EN 301 489-25; ETSI EN 301 489-26; ETSI EN 301 489-27; ETSI EN 301 489-28; ETSI EN 301 489-31; ETSI EN 301 489-32; IEC 60945
IDA – Radio	IDA TS 3G-BS; IDA TS 3G-MT; IDA TS AR; IDA TS CT-CTS; IDA TS GMPCS; IDA TS GSM-BS; IDA TS GSM-MT; IDA TS LMR; IDA TS RPG; IDA TS SRD; IDA TS UWB; IDA TS WBA
Vietnam – Radio	TCN 68-242:2006; TCN 68-243:2006; TCN 68-246:2006
Korea – Radio	KCC Notice 2009-13; KCC Notice 2008-26; RRL Notice 2008-2; RRL Notice 2005-105; RRL Notice 2008-17; RRL Notice 2005-127; RRL Notice 2005-24; RRL Notice 2005-25; RRL Notice 2005-179; RRL Notice 2008-10; RRL Notice 2007-49; RRL Notice 2007-20; RRL Notice 2007-11; RRL Notice 2007-80; RRL Notice 2004-68; KCC Notice 2009-36, Dec. 8, 2009; RRL Notice 2009-6, October 15, 2009; KCC Notice 2010-1; KCC Notice 2010-12; KCC Notice 2010-13
Taiwan – Radio	LP0002; PLMN07; PLMN01; PLMN08
Australia - New Zealand – Radio	AS 2772.2; AS/NZS 4281; AS/NZS 4268; AS/NZS 4280.1; AS/NZS 4583; AS/NZS 4280.2; AS/NZS 4281; AS/NZS 4295; AS/NZS 4582; AS/NZS 4769.1; AS/NZS 4769.2; AS/NZS 4770; AS/NZS 4771
Hong Kong – Radio	HKTA 1002; HKTA 1007; HKTA 1008; HKTA 1010; HKTA 1015; HKTA 1016; HKTA 1020; HKTA 1022; HKTA 1026; HKTA 1027; HKTA 1029; HKTA 1030; HKTA 1031; HKTA 1032; HKTA 1033; HKTA 1034; HKTA 1035; HKTA 1036; HKTA 1037; HKTA 1039; HKTA 1041; HKTA 1042; HKTA 1043; HKTA 1044; HKTA 1046; HKTA 1047; HKTA 1048; HKTA 1049; HKTA 1051; HKTA1052; HKTA1053; HKTA 1054; HKTA 1055



FCC Telephone Terminal Equipment Scope C1	ANSI/TIA-968-A-03; ANSI/TIA-968-A-1:03; ANSI/TIA-968-A-2:04; ANSI/TIA-968-A-3:05; ANSI/TIA-968-A-4:07; ANSI/TIA-968-A-5:07; TIA-968-B; FCC Rule Part 68; 47 CFR Part 68.316; 47 CFR Part 68.317; ANSI/TIA/EIA-464-C; TIA-810-B; T1.TRQ6 (2002); TCB-31-B (1998); TIA-470.110-C; TIA-810-B; TIA-920
Canada – Telecom	CS-03 Part V Issue 9:2009 Amendment 1; CS-03 Part VIII Issue 9:2009 Amendment 4; CS-03 Part I Issue 9:2006 Amendment 3; CS-03 Part II Issue 9:2004; CS-03 Part III Issue 9:2004; CS-03 Part V Issue 9:2004 ; CS-03 Part VI Issue 9:2004; CS-03 Part VII Issue 9:2006 Amendment 3; CS-03 Part VIII Issue 9:2007 Amendment 3; CS-03 Issue 9:04 + A2(06) + A3(06)
Europe – Telecom	TBR 2: 01-1997; TBR 004 Ed.1.95 + A1 (97); TBR 1: TBR 3; TBR 12:A1 01-1996; TBR 013 ed.1; TBR 024 ed.1; TBR 25; TBR 38 ed.1; ETSI ES 203 021-05 ; ETSI ES 203 021-2 ; ETSI ES 021-3; TBR 021; ETSI EG 201 121; ETSI EN 301 437; ETSI TS 101 270-1; ITU-T Recommendation Q.920; ITU-T Recommendation Q.920 – Amendment 1; ITU-T Recommendation Q.921; ITU-T Recommendation Q.921 – Amendment 1; ITU-T Recommendation Q.931; ITU-T Recommendation Q.931 – Amendment 1; Erratum 1 (02/2003) ITU-T Recommendation Q.931 (05/1998); ISDN User Network Interface Layer 3 Specification for Basic Call Control; ITU-T Recommendation P.300
Australia – Telecom Australia – Telecom	AS/CA S003.1:2010; AS/CA S003.2:2010; AS/CA S003.3:2010; AS/CA S004:2010; AS/ACIF S006:2008; AS/ACIF S041.1:2009 AS/ACIF S041.2:2009; AS/ACIF S041.3:2009; AS/ACIF S042.1:2008; AS/ACIF S043.2:2008; AS/ACIF S043.3:2008; AS/ACIF S002:05; AS/ACIF S003:06; AS/ACIF S004:06; AS/ACIF S006:01; AS/ACIF S016:01; AS/ACIF S031:01; AS/ACIF S038:01; AS/ACIF S040:01; AS/ACIF S041:05; AS/ACIF S043.2:06; AS ACIF S042.1
New Zealand – Telecom	PTC200:2006; PTC200 Issue No.2:97 + A1(980); PTC220; PTC273:2007; TNA 115; TNA 117
Singapore – Telecom	IDA TS ADSL, Issue 1, Rev. 1 (April 2006); IDA TS DLCN, Issue 1 (July 2005); IDA TS ISDN BA, Issue 1 (July 2005); IDA TS ISDN PRA, Issue 1 (July 2005); IDA TS ISDN 3 (Oct. 2000); IDA TS-PSTN, Issue 1 (March 2007); IDA TS ACLIP 07
Hong Kong – Telecom	HKTA 2011; HKTA 2012; HKTA 2013; HKTA 2014; HKTA 2015; HKTA 2017; HKTA 2018; HKTA 2019; HKTA 2022; HKTA 2023; HKTA 2024; HKTA 2026; HKTA 2027; HKTA 2028; HKTA 2029; HKTA 2030; HKTA 2031; HKTA 2032; HKTA 2033



Vietnam – Telecom	TCN 68-188:2000; TCN 68-193:2003; TCN 68-196:2001; TCN 68-143:2003; TCN 68-192:2003; TCN 68-189:2000; TCN 68-221:2004; TCN 68-222:2004; TCN 68-245:2004; TCN 68-223:2004
Korea – Telecom	RRA Notice 2009-38, Sep. 11, 2009; RRA Notice 2009-7 (including attachments 1, 3, 5 ,6); Presidential Decree 21098, RRL Notice 2007-30; RRL Notice 2008-10 (attachments 1, 3, 5, 6); RRL Notice 2009-25; RRL Notice 2008-59
China – Telecom	YD/T 514-1:98; YD/T 1277.1-2003; GB/T 17904.1-1999; GB/T 17904.2-1999; GB/T 17154.1-1997; GB/T 17154.2-1997; YD/T1091-2000; YD/T1006-1999; GB/T 17789-1999
Taiwan – Telecom	PSTN01:03; ADSL01:08; ID0002; IS6100: 93
Japan – Telecom	JATE Blue Book, Green Book; Ministerial Ordinance of the Ministry of Posts and Telecommunications No. 31 of April 1, 1985 (last amended on March 22 2004); Ordinance Concerning Technical Conditions Compliance Approval etc. of Terminal Equipment
South Africa – Telecom	DPT-TE-001; TE-002; TE-003; TE-004; TE-005; TE-006; TE-007; TE-008; TE-009; TE-010; TE-012 (telephone interface); TE-013 (telephone interface); TE-014; TE-015; TE-018; SWS-001; SWS-002; SWS-003; SWS-004; SWS-005; SWS-006; SWS-007; SWS-008; SWS-009; SWS-010
Israel – Telecom	Israel MoC Spe. 23/96
Mexico – Telecom	NOM-151-SCT1-1999; NOM-152-SCT1-1999
Argentina – Telecom	CNC-ST2-44-01
Brazil – Telecom	Resolution 392-2005
International Telecom Union	ITU-T-G.703:01; ITU-T-G.823:93; ITU-T G.824; ITU-T G.825; ITU-T-G.991.2; ITU-T-G.992.1; ITU-T-G.992.3; ITU-T-G.992.5; ITU-T-G.993.1
Product Safety	IEC 60950-1; EN 60950-1; UL 60950-1; IEC 60601-1-1; CAN/CSA 22.2 NO. 60950-1-03; SS-EN 60950-1; AS/NZ 60950-1, (voltage surge testing up to 6kV, excluding Annex A and H); CNS 14336, CNS 14408; GB4943; President Notice 20664; RRL Notice 2008-10 (attachment 4); RRA Notice 2009-7 (attachment 4); TCN 68-190:2003; SABS IEC 60950; IEC/EN 61558; IEC/EN 61558-2-7; EN 62115; IEC 60215; EN 60958; EN 60598; IEC 215 (1987) + A1 (1992) + A2 (1994)
Japan - Radio	ARIB STD-T81; ARIB STD-T66; RCR STD-1; RCR STD-29; ARIB STD-T94 Fascicle 1; ARIB STD-T90; ARIB STD-T89; RCR STD-33



SAR & HAC	IEEE P1528:2003 + Ad1; IEEE 1528A:2005; FCC OET Bulletin 65 Supplement C; FCC OET Bulletin 65; ANSI C95; ANSI C63.19; FCC 47 CFR 20.19; H46-2/99-273E; EN 50360; EN 50361; IEC62209-1; IEC 62209-2; EN 50371; EN 50383; EN 50357; EN 50364; RRL 2008-18; RRL 2008-16; KCC 2009-27; RRL 2004-67; CNS 14958-1; CNS 14959; NZS 2772.1; NZS 6609.2; Resolution N 533
Japan – Notification No. 88 of MIC 2004	
Table No 13	CB Radio
Table No 21	Cordless Telephone
Table Nos 22-1 thru 22-17	Low Power Radio Equipment
Table No 36	Low Power Security System
Table No 43	Low Power Data Communication in the 2.4 GHz Band
Table No 44	Low Power Data Communication in the 2.4 GHz Band
Table No 45	Low Power Data Communication in the 5.2, 5.3, 5.6 GHz Bands
Table No 46	Low Power Data Communication in the 25 and 27 GHz Bands
Table No 47	Base Station for 5 GHz Band Wireless Access System
Table No 47	Base Station for 5 GHz Band Wireless Access System (low spurious type)
Table No 47	Land Mobile Relay for 5 GHz Band Wireless Access System (limited for use in special zones)
Table No 47	Land Mobile Relay for 5 GHz Band Wireless Access System (limited for use in special zones, low spurious type)
Table No 47	Land Mobile Relay for 5 GHz Band Wireless Access System
Table No 47	Land Mobile Relay for 5 GHz Band Wireless Access System (low spurious type)
Table No 47	Land Mobile Relay for 5 GHz Band Wireless Access System (low power type)
Table No 50	Digital Cordless Telephone
Table No 50	PHS Base Station
Table No 50	PHS Land Mobile Station
Table No 50	PHS Relay Station
Table No 50	PHS Test Station
Table No 64	Mobile Station for Dedicated Short Range Communication Systems
Table No 64	Base Station for Dedicated Short Range Communication Systems
Table No 64	Test Station for Dedicated Short Range Communication Systems
Table No 70	UWB (Ultra Wide Band) Radio System



¹Note: This accreditation covers testing performed at the laboratory listed above and the OATS located at 44366 South Grimmer Blvd., Fremont CA 94538. At this site "Radiated Emissions" are tested at a measurement distance of 10m.

⁴Limitations for listed standards are indicated by italics and Scope excludes protocol sections of applicable standards.



SIEMIC, INC.
Accessing global markets

Title: RF Test Report of HID Global Corporation
Model : RKCL40A
To FCC 15.225 2010

Serial# PCII_RKCL40A_SL11112901-HID-025_FCC_Rev-02
Issue Date January 6th, 2012
Page 54 of 72
www.siemic.com



The American Association for Laboratory Accreditation

World Class Accreditation

Accredited Product Certification Body

A2LA has accredited

SIEMIC LABORATORIES

San Jose, CA

for technical competence as a

Product Certification Body

This product certification body is accredited in accordance with the recognized International Standard ISO/IEC Guide 65:1996 *General requirements for bodies operating product certification systems*. This accreditation demonstrates technical competence for a defined scope and the operation of a quality management system for a Telecommunications Certification Body (TCB) meeting FCC (U.S.), IDA (Singapore), IC (Canada), OFTA (Hong Kong), and Japan (MIC) requirements.

Presented this 23rd day of November 2010.



President & CEO
For the Accreditation Council
Certificate Number 2742.01
Valid to September 30, 2012
Revised December 16, 2010

For the product certification schemes to which this accreditation applies, please refer to the organization's Product Certification Scope of Accreditation.



The American Association for Laboratory Accreditation

SCOPE OF ACCREDITATION TO ISO/IEC GUIDE 65:1996

SIEMIC INC.
2206 Ringwood Ave.
San Jose, CA 95131
Mr. Snell Leong (Authorized Representative) Phone: 408 526 1188
www.siemic.com

PRODUCT CERTIFICATION CONFORMITY ASSESSMENT BODY (CAB)

Valid to: September 30, 2012

Certificate Number: 2742.02

In recognition of the successful completion of the A2LA Certification Body Accreditation Program evaluation, including the US Federal Communications Commission (FCC), Industry Canada (IC), Singapore (IDA) and Hong Kong (OFTA) requirements for the indicated types of product certifications, accreditation is granted to this organization to perform the following product certification schemes:

Economy Scope

Federal Communication Commission - (FCC)

Unlicensed Radio Frequency Devices	A1, A2, A3, A4
Licensed Radio Frequency Devices	B1, B2, B3, B4
Telephone Terminal Equipment	C

*Please refer to FCC TCB Program Roles and Responsibilities, released July 22, 2010 detailing scopes, roles and responsibilities. <http://fallfoss.fcc.gov/oetcf/kdb/forms/FTSSearchResultPage.cfm?id=44683&switch=P>

Industry Canada - (IC)

Radio	Scope 1-Licence-Exempt Radio Frequency Devices; Scope 2-Licensed Personal Mobile Radio Services; Scope 3-Licensed General Mobile & Fixed Radio Services; Scope 4-Licensed Maritime & Aviation Radio Services; Scope 5-Licensed Fixed Microwave Radio Services;
-------	--

*Please refer to Industry Canada (IC) website at: <http://www.ic.gc.ca/eic/site/smt-gst.nsf/eng/sf09888.html>

IDA – Singapore

Line Terminal Equipment	All Technical Specifications for Line Terminal Equipment – Table 1 of IDA MRA Recognition Scheme: 2009, Annex 2
Radio-Communication Equipment	All Technical Specifications for Radio-Communication Equipment – Table 2 of IDA MRA Recognition Scheme: 2009, Annex 2

*Please refer to Info-Communication Development Authority (IDA) Singapore website at: http://www.ida.gov.sg/doc/Policies%20and%20Regulation/Policies_and_Regulation_Level2/20060609145118/MRAREcScheme.pdf

(A2LA Cert. No. 2742.02) Revised 12/16/2010

 Page 1 of 2



OFTA – Hong Kong

Radio Equipment HKTA 1001, 1002, 1003, 1004, 1005, 1006, 1007, 1008,
1009, 1010, 1015, 1016, 1019, 1020, 1022, 1026, 1027,
1029, 1030, 1031, 1032, 1033, 1034, 1035, 1036, 1037,
1038, 1039, 1041, 1042, 1043, 1044, 1045, 1046, 1047,
1048, 1049, 1050, 1051, 1052, 1053, 1054, 1055

**Please refer to the Office of the Telecommunications Authority's website at:
<http://www.ofta.gov.hk/en/standards/HKTASpec/hkta-10xx.html>*

Fixed Network Equipment HKTA 2001, 2005, 2011, 2012, 2013, 2014, 2015, 2016,
2017, 2018, 2019, 2020, 2021, 2022, 2023, 2024, 2025,
2026, 2027, 2028, 2029, 2030, 2031, 2032, 2033, 2034,
2035, 2036, 2037, 2040, 2041, 2102, 2103,
2104, 2108, 2201, 2202, 2203, 2204

**Please refer to the Office of the Telecommunications Authority's website at:
<http://www.ofta.gov.hk/en/standards/HKTASpec/hkta-2xxx.html>*

MIC – Japan

Terminal Equipment Scope A1 - Terminal Equipment for the Purpose of Calls
Radio Equipment Scope B1 - Unlicensed Station (all classes of equipment)

SIEMIC ACCREDITATION DETAILS: FCC Test Site Registration No. 783147

FEDERAL COMMUNICATIONS COMMISSION
Laboratory Division
7435 Oakland Mills Road
Columbia, MD 21046

June 08, 2011

Registration Number: 783147

SIEMIC Laboratories
2206 Ringwood Avenue,
San Jose, CA 95131

Attention: Leslie Bai, Director of Certification

Re: Measurement facility located at San Jose
Anechoic chamber (3 meters)
Date of Renewal: June 08, 2011

Dear Sir or Madam:

Your request for renewal of the registration of the subject measurement facility has been received. The information submitted has been placed in your file and the registration has been renewed. The name of your organization will remain on the list of facilities whose measurement data will be accepted in conjunction with applications for Certification under Parts 15 or 18 of the Commission's Rules. Please note that the file must be updated for any changes made to the facility and the registration must be renewed at least every three years.

Measurement facilities that have indicated that they are available to the public to perform measurement services on a fee basis may be found on the FCC website www.fcc.gov under E-Filing, OET Equipment Authorization Electronic Filing, Test Firms.

Sincerely,

Phyllis Parrish
Industry Analyst

SIEMIC ACCREDITATION DETAILS: Industry of Canada CAB ID : US0160



UNITED STATES DEPARTMENT OF COMMERCE
National Institute of Standards and Technology
Gaithersburg, Maryland 20899

March 4, 2009

Mr. Leslie Bai
SIEMIC, Inc.
2206 Ringwood Avenue
San Jose, CA 95131

Dear Mr. Bai:

NIST is pleased to inform you that your laboratory has been recognized by Industry Canada (IC), under the Asia Pacific Economic Cooperation for Telecommunications Equipment Mutual Recognition Arrangement (APEC Tel MRA). Your laboratory is now designated to act as a Conformity Assessment Body (CAB) under Appendix B, **Phase I** Procedures, of the APEC Tel MRA. The pertinent information about your laboratory's designation is as follows:

CAB Name: SIEMIC, Inc.
Physical Location: 2206 Ringwood Avenue, San Jose, CA 95131 USA
Identification No.: US0160
Recognized Scope: CS-03 Part I, II, V, VI, VII and VIII

You may submit test data to IC to verify that the equipment to be imported into Canada satisfies the applicable requirements. The designation of your organization will remain in force as long as its accreditation for the designated scope remains valid and comply with the designation requirements.

Recognized CABs are listed on the NIST website at <http://ts.nist.gov/mra>. Please contact Ms. Ramona Saar at (301) 975-5521 or ramona.saar@nist.gov if you have any questions.

Sincerely,

David F. Alderman
Group Leader, Standards Coordination and Conformity Group
Standards Services Division

Enclosure

cc: CAB Program Manager

SIEMIC ACCREDITATION DETAILS: Industry of Canada Test Site Registration No. 4842-1

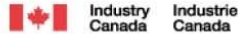

May 27, 2010

OUR FILE: 46405-4842
Submission No: 140856

Siemic Inc.

2206 Ringwood Ave
San Jose, CA, 95131
USA

Attention: Snell Leong

Dear Sir/Madame:

The Bureau has received your application for the renewal of a 3m alternative test site. Be advised that the information received was satisfactory to Industry Canada. The following number(s) is now associated to the site(s) for which registration / renewal was sought (**4842A-1**). Please reference the appropriate site number in the body of test reports containing measurements performed on the site. In addition, please keep for your records the following information;

- Your primary code is: **4842**

- The company number associated to the site(s) located at the above address is: **4842A**

Furthermore, to obtain or renew a unique site number, the applicant shall demonstrate that the site has been accredited to ANSI C63.4-2003 or later. A scope of accreditation indicating the accreditation by a recognized accreditation body to ANSI C63.4-2003 or later shall be accepted. Please indicate in a letter the previous assigned site number if applicable and the type of site (example: 3 metre OATS or 3 metre chamber). If the test facility is not accredited to ANSI C63.4-2003 or later, the test facility shall submit test data demonstrating full compliance with the ANSI standard. The Bureau will evaluate the filing to determine if recognition shall be granted.

The frequency for re-validation of the test site and the information that is required to be filed or retained by the testing party shall comply with the requirements established by the accrediting organization. However, in all cases, test site re-validation shall occur on an interval not to exceed two years. There is no fee or form associated with an OATS filing. OATS submissions are encouraged to be submitted electronically to the Bureau using the following URL;
http://strategis.ic.gc.ca/epic/internet/inceb-bhst.nsf/en/h_tt00052e.html.

If you have any questions, you may contact the Bureau by e-mail at certification.bureau@ic.gc.ca Please reference our file and submission number above for all correspondence.

Yours sincerely,

Dalwinder Gill
For: Wireless Laboratory Manager
Certification and Engineering Bureau
3701 Carling Ave., Building 94
P.O. Box 11490, Station "H"
Ottawa, Ontario K2H 8S2
Email: dalwinder.gill@ic.gc.ca
Tel. No. (613) 998-8363
Fax. No. (613) 990-4752



SIEMIC ACCREDITATION DETAILS: FCC DOC CAB Recognition : US1109

FEDERAL COMMUNICATIONS COMMISSION

**Laboratory Division
7435 Oakland Mills Road
Columbia, MD 21046**

August 28, 2008

Siemic Laboratories
2206 Ringwood Ave.,
San Jose, CA 95131

Attention: Leslie Bai

Re: Accreditation of Siemic Laboratories
Designation Number: US1109
Test Firm Registration #: 540430

Dear Sir or Madam:

We have been notified by American Association for Laboratory Accreditation that Siemic Laboratories has been accredited as a Conformity Assessment Body (CAB).

At this time Siemic Laboratories is hereby designated to perform compliance testing on equipment subject to Declaration Of Conformity (DOC) and Certification under Parts 15 and 18 of the Commission's Rules.

This designation will expire upon expiration of the accreditation or notification of withdrawal of designation.

Sincerely,

George Tannahill
Electronics Engineer

SIEMIC ACCREDITATION DETAILS: Australia CAB ID : US0160



UNITED STATES DEPARTMENT OF COMMERCE
National Institute of Standards and Technology
Gaithersburg, Maryland 20899

November 20, 2008

Mr. Leslie Bai
SIEMIC, Inc.
2206 Ringwood Avenue
San Jose, CA 95131

Dear Mr. Bai:

NIST is pleased to inform you that your laboratory has been recognized by the Australian Communications and Media Authority (ACMA) under the Asia Pacific Economic Cooperation for Telecommunications Equipment Mutual Recognition Arrangement (APEC Tel MRA). Your laboratory is now designated to act as a Conformity Assessment Body (CAB) under Appendix B, **Phase I** Procedures, of the APEC Tel MRA. The pertinent information about your laboratory's designation is as follows:

CAB Name: Siemic, Inc.
Physical Location: 2206 Ringwood Avenue, San Jose, CA 95131
Identification No.: US0160
Recognized Scope: EMC: AS/NZS 4251.1 (until 5/31/2009), AS/NZS 4251.2 (until 5/31/2009), AS/NZS CISPR 11, AS/NZS CISPR 14.1, AS/NZS CISPR 22, AS/NZS 61000.6.3, AS/NZS 61000.6.4
Radiocommunications: AS/NZS 4281, AS/NZS 4268, AS/NZS 4280.1, AS/NZS 4280.2, AS/NZS 4295, AS/NZS 4582, AS/NZS 4583, AS/NZS 4769.1, AS/NZS 4769.2, AS/NZS 4770, AS/NZS 4771
Telecommunications: AS/ACIF S002:05, AS/ACIF S003:06, AS/ACIF S004:06, AS/ACIF S006:01, AS/ACIF S016:01, AS/ACIF S031:01, AS/ACIF S038:01, AS/ACIF S040:01, AS/ACIF S041:05, AS/ACIF S043.2:06, AS/NZS 60950.1

You may submit test data to ACMA to verify that the equipment to be imported into Australia satisfies the applicable requirements. The designation of your organization will remain in force as long as its accreditation for the designated scope remains valid and comply with the designation requirements. Recognized CABs are listed on the NIST website at <http://ts.nist.gov/mra>. Please contact Ms. Ramona Saar, at (301) 975-5521 or ramona.saar@nist.gov if you have questions.

Sincerely,

David F. Alderman
Group Leader, Standards Coordination and Conformity Group
Standards Services Division

Enclosure

cc: Snell Leong, Siemic, Inc.; Ramona Saar, NIST

NIST



SIEMIC ACCREDITATION DETAILS: Korea CAB ID: US0160



KOREA COMMUNICATIONS COMMISSION
REPUBLIC OF KOREA
1, Wonhyoro-3ga, Yongsan-gu, Seoul, 140-848, Korea

Radio Research Agency

Tel: +82 2 710 6610
Fax: +82 2 710 6619
Homepage : www.rra.go.kr

KCC/RRA

14th Jan, 2011

Radio Research Agency
Korea Communications Commission
#1, Wonhyoro-3ga, Yongsan-gu
Seoul Korea 140-848
(Tel) 82-2-710-6610, (Fax) 82-2-710-6619
Jan 14th, 2011

Mr. David F. Alderman
Group Leader, Standards Coordination and Conformity Group
National Institute of Standards and Technology
100 Bureau Drive, Stop 2100
Gaithersburg, Maryland 20899-2100, USA

Dear Mr. David F. Alderman:

This is to confirm the recognition by Radio Research Agency of

SIEMIC, Inc. (US0160)

as an accredited Conformity Assessment Body (CAB) under the terms of Phase I of the APEC TEL MRA. The scope for which this laboratory has been recognized is given below.

Coverage	Standards	Date of Recognition
Current Scope	EMI : KCC Notice 2008-39, RRL Notice 2008-3 and KN22 EMS : KCC Notice 2008-38, RRL Notice 2008-4, KN24, KN 61000 -4-2, -4-3, -4-4, -4-5, -4-6, -4-8, -4-11 Radio : RRL Notice 2008-26, RRL Notice 2008-2, RRL Notice 2008-10, RRL Notice 2007-49, RRL Notice 2007-20, RRL Notice 2007-11, RRL Notice 2007-80, RRL Notice 2004-68 Telecom : President Notice 20664, RRL Notice 2007-30, 2008-7(1,3,4,5,6)	Jan 14 th , 2011
	Updated Scope	

This recognition is contingent upon the maintenance of this CAB's accreditation status and is limited to the standards listed above.

If you have any inquiries about this recognition, please contact to Certification Division of Radio Research Agency with above address and telephone numbers.

Best Regards,

Ahn, Kun-Young
Director Certification Division

Enclosure

cc: Ramona Saar – NIST,
JungMin Park - RRA



SIEMIC, Inc.
Accessing global markets

Title: RF Test Report of HID Global Corporation
Model : RKCL40A
To: FCC 15.225 2010

Serial# PCII_RKCL40A_SL11112901-HID-025_FCC_Rev-02
Issue Date January 6th, 2012
Page 63 of 72
www.siemic.com

SIEMIC ACCREDITATION DETAILS: Taiwan BSMI Accreditation No. SL2-IN-E-1130R



UNITED STATES DEPARTMENT OF COMMERCE
National Institute of Standards and Technology
Gaithersburg, Maryland 20899

May 3, 2006

Mr. Leslie Bai
SIEMIC Laboratories
2206 Ringwood Avenue
San Jose, CA 95131

Dear Mr. Bai:

I am pleased to inform you that your laboratory has been recognized by the Chinese Taipei's Bureau of Standards, Metrology, and Inspection (BSMI) under the Asia Pacific Economic Cooperation (APEC) Mutual Recognition Arrangement (MRA). Your laboratory is now designated to act as a Conformity Assessment Body (CAB) under Appendix B, **Phase I** Procedures, of the APEC Tel MRA. You may submit test data to BSMI to verify that the equipment to be imported into Chinese Taipei satisfies the applicable requirements. The designation of your organization will remain in force as long as its accreditation for the designated scope remains valid and comply with the designation requirements. The pertinent designation information is as follows:

- BSMI number: **SL2-IN-E-1130R** (Must be applied to the test reports)
- U.S Identification No: **US0160**
- Scope of Designation: **CNS 13438**
- Authorized signatory: **Mr. Leslie Bai**

The names of all recognized CABs will be posted on the NIST website at <http://ts.nist.gov/mra>. If you have any questions, please contact Mr. Dhillon at 301-975-5521. We appreciate your continued interest in our international conformity assessment activities.

Sincerely,

David F. Alderman
Group Leader, Standards Coordination and Conformity Group

cc: Jogindar Dhillon

NIST



SIEMIC, Inc.
Accessing global markets

Title: RF Test Report of HID Global Corporation
Model : RKCL40A
To FCC 15.225 2010

Serial# PCII_RKCL40A_SL11112901-HID-025_FCC_Rev-02
Issue Date January 6th, 2012
Page 64 of 72
www.siemic.com

SIEMIC ACCREDITATION DETAILS: Taiwan NCC CAB ID: US0160



UNITED STATES DEPARTMENT OF COMMERCE
National Institute of Standards and Technology
Gaithersburg, Maryland 20899

March 16, 2009

Mr. Leslie Bai
SIEMIC, Inc.
2206 Ringwood Avenue
San Jose, CA 95131

Dear Mr. Bai:

NIST is pleased to inform you that your laboratory has been recognized by the National Communications Commission (NCC) for the requested scope expansion under the Asia Pacific Economic Cooperation for Telecommunications Equipment Mutual Recognition Arrangement (APEC Tel MRA). Your laboratory is designated to act as a Conformity Assessment Body (CAB) under Appendix B, **Phase I** Procedures, of the APEC Tel MRA. The pertinent information about your laboratory's designation is as follows:

CAB Name: SIEMIC, Inc.
Physical Location: 2206 Ringwood Avenue, San Jose, CA 95131
Identification No.: US0160
Current Scope: LP0002, PSTN01, ADSL01, ID0002, IS6100 and CNS 14336
Additional Scope: PLMN07

You may submit test data to NCC to verify that the equipment to be imported into China satisfies the applicable requirements. The designation of your organization will remain in force as long as its accreditation for the designated scope remains valid and comply with the designation requirements.

Recognized CABs are listed on the NIST website at <http://ts.nist.gov/mra>. If you have any questions please contact Ramona Saar at (301) 975-5521 or ramona.saar@nist.gov.

Sincerely,

David F. Alderman
Group Leader, Standards Coordination and Conformity Group
Standards Services Division

Enclosure

cc: Ramona Saar

NIST

SIEMIC ACCREDITATION DETAILS: Vietnam CAB ID: US0160

BỘ THÔNG TIN VÀ TRUYỀN THÔNG CỘNG HÒA XÃ HỘI CHỦ NGHĨA VIỆT NAM
Độc lập - Tự do - Hạnh phúc

Số: 65 /QĐ-BTTTT

Hà Nội, ngày 19 tháng 01 năm 2011

QUYẾT ĐỊNH
Về việc Thừa nhận Phòng đo kiểm

BỘ TRƯỞNG BỘ THÔNG TIN VÀ TRUYỀN THÔNG

Căn cứ Nghị định số 187/2007/NĐ-CP ngày 25/12/2007 của Chính phủ quy định chức năng, nhiệm vụ, quyền hạn và cơ cấu tổ chức của Bộ Thông tin và Truyền thông;

Căn cứ Quyết định số 172/2003/QĐ-BBCVT ngày 29/10/2003 của Bộ trưởng Bộ Bưu chính, Viễn thông (nay là Bộ Thông tin và Truyền thông) quy định về việc thừa nhận các Phòng đo kiểm đã được các Bên tham gia Thỏa thuận thừa nhận lẫn nhau về đánh giá hợp chuẩn thiết bị viễn thông với Việt Nam chỉ định;

Theo đề nghị của Vụ trưởng Vụ Khoa học và Công nghệ,

QUYẾT ĐỊNH:

Điều 1. Thừa nhận phòng đo kiểm:

SIEMIC, INC. – US0160

Địa chỉ: 2206 Ringwood Avenue, San Jose, CA 95131 USA

(đã được Viện tiêu chuẩn và công nghệ quốc gia Hoa Kỳ (NIST) chỉ định và đề nghị thừa nhận) đáp ứng đầy đủ các yêu cầu về việc thừa nhận Phòng đo kiểm đã được Bên tham gia Thỏa thuận thừa nhận lẫn nhau về đánh giá hợp chuẩn thiết bị viễn thông với Việt Nam chỉ định theo Quyết định số 172/2003/QĐ-BBCVT với phạm vi thừa nhận kèm theo Quyết định này.

Điều 2. Phòng đo kiểm có tên tại Điều 1 có các quyền lợi và nghĩa vụ theo quy định tại Quyết định số 172/2003/QĐ-BBCVT.

Điều 3. Phòng đo kiểm có tên tại Điều 1 và các cơ quan, tổ chức có liên quan chịu trách nhiệm thi hành Quyết định này.

Điều 4. Quyết định này có hiệu lực đến ngày 30/09/2012. /.

Nơi nhận:

- Như Điều 3;
- Bộ trưởng (để b/c);
- Trung tâm Thông tin (để đăng website);
- Lưu: VT, KHCN.



Nguyễn Thành Hưng



SIEMIC ACCREDITATION DETAILS: Mexico NOM Recognition



CAMARA NACIONAL
DE LA INDUSTRIA
ELECTRONICA, DE
TELECOMUNICACIONES
E INFORMATICA

Laboratorio Valentín V. Rivero

México D.F. a 16 de octubre de 2006.

**LESLIE BAI
DIRECTOR OF CERTIFICATION
SIEMIC LABORATORIES, INC.
ACCESSING GLOBAL MARKETS
P R E S E N T E**

En contestación a su escrito de fecha 5 de septiembre del año en curso, le comento que estamos muy interesados en su intención de firmar un Acuerdo de Reconocimiento Mutuo, para lo cual adjunto a este escrito encontrara el Acuerdo en idioma inglés y español preferido de los cuales le pido sea revisado y en su caso corregido, para que si esta de acuerdo poder firmarlo para mandarlo con las autoridades Mexicanas para su visto bueno y así poder ejercer dicho acuerdo.

Aprovecho este escrito para mencionarle que nuestro intermediario gestor será la empresa Isabel de México, S. A. de C. V., empresa que ha colaborado durante mucho tiempo con nosotros en lo relacionado a la evaluación de la conformidad y que cuenta con amplia experiencia en la gestión de la certificación de cumplimiento con Normas Oficiales Mexicanas de producto en México.

Me despido de usted enviándole un cordial saludo y esperando sus comentarios al Acuerdo que nos ocupa.

Atentamente:

**Ing. Faustino Sánchez González
Gerente Técnico del Laboratorio de
CANIETI.**

SIEMIC ACCREDITATION DETAILS: Hong Kong OFTA CAB ID : US0160



UNITED STATES DEPARTMENT OF COMMERCE
National Institute of Standards and Technology
Gaithersburg, Maryland 20899-

December 8, 2008

Mr. Leslie Bai
SIEMIC, Inc.
2206 Ringwood Avenue
San Jose, CA 95131

Dear Mr. Bai:

NIST is pleased to inform you that your laboratory has been recognized by the Office of the Telecommunications Authority (OFTA) under the Asia Pacific Economic Cooperation for Telecommunications Equipment Mutual Recognition Arrangement (APEC Tel MRA). Your laboratory is now designated to act as a Conformity Assessment Body (CAB) under Appendix B, **Phase I** Procedures, of the APEC Tel MRA. The pertinent information about your laboratory's designation is as follows:

CAB Name: SIEMIC, Inc.
Physical Location: 2206 Ringwood Avenue, San Jose, California 95131 USA
Identification No.: US0160
Recognized Scope: **Radio:** HKTA 1002, 1007, 1008, 1010, 1015, 1016, 1020, 1022, 1026, 1027, 1029, 1030, 1031, 1032, 1033, 1034, 1035, 1036, 1037, 1039, 1041, 1042, 1043, 1044, 1046, 1047, 1048, 1049, 1051
Telecom: HKTA 2011, 2012, 2013, 2014, 2017, 2018, 2022, 2024, 2026, 2027, 2028, 2029, 2030, 2031, 2032, 2033

You may submit test data to OFTA to verify that the equipment to be imported into Hong Kong satisfies the applicable requirements. The designation of your organization will remain in force as long as its accreditation for the designated scope remains valid and comply with the designation requirements.

Recognized CABs are listed on the NIST website at <http://ts.nist.gov/mra>. If you have any questions please contact Ramona Saar at (301) 975-5521 or ramona.saar@nist.gov.

Sincerely,

David F. Alderman
Group Leader, Standards Coordination and Conformity Group
Standards Services Division

Enclosure

cc: Ramona Saar

SIEMIC ACCREDITATION DETAILS: Australia ACMA CAB ID: US0160



UNITED STATES DEPARTMENT OF COMMERCE
National Institute of Standards and Technology
Gaithersburg, Maryland 20899

November 20, 2008

Mr. Leslie Bai
SIEMIC, Inc.
2206 Ringwood Avenue
San Jose, CA 95131

Dear Mr. Bai:

NIST is pleased to inform you that your laboratory has been recognized by the Australian Communications and Media Authority (ACMA) under the Asia Pacific Economic Cooperation for Telecommunications Equipment Mutual Recognition Arrangement (APEC Tel MRA). Your laboratory is now designated to act as a Conformity Assessment Body (CAB) under Appendix B, **Phase I** Procedures, of the APEC Tel MRA. The pertinent information about your laboratory's designation is as follows:

CAB Name: Siemic, Inc.
Physical Location: 2206 Ringwood Avenue, San Jose, CA 95131
Identification No.: US0160
Recognized Scope: EMC: AS/NZS 4251.1 (until 5/31/2009), AS/NZS 4251.2 (until 5/31/2009), AS/NZS CISPR 11, AS/NZS CISPR 14.1, AS/NZS CISPR 22, AS/NZS 61000.6.3, AS/NZS 61000.6.4
Radiocommunications: AS/NZS 4281, AS/NZS 4268, AS/NZS 4280.1, AS/NZS 4280.2, AS/NZS 4295, AS/NZS 4582, AS/NZS 4583, AS/NZS 4769.1, AS/NZS 4769.2, AS/NZS 4770, AS/NZS 4771
Telecommunications: AS/ACIF S002:05, AS/ACIF S003:06, AS/ACIF S004:06, AS/ACIF S006:01, AS/ACIF S016:01, AS/ACIF S031:01, AS/ACIF S038:01, AS/ACIF S040:01, AS/ACIF S041:05, AS/ACIF S043.2:06, AS/NZS 60950.1

You may submit test data to ACMA to verify that the equipment to be imported into Australia satisfies the applicable requirements. The designation of your organization will remain in force as long as its accreditation for the designated scope remains valid and comply with the designation requirements. Recognized CABs are listed on the NIST website at <http://ts.nist.gov/mra>. Please contact Ms. Ramona Saar, at (301) 975-5521 or ramona.saar@nist.gov if you have questions.

Sincerely,

David F. Alderman
Group Leader, Standards Coordination and Conformity Group
Standards Services Division

Enclosure

cc: Snell Leong, Siemic, Inc.; Ramona Saar, NIST

NIST

SIEMIC ACCREDITATION DETAILS: Australia NATA Recognition



Leslie Bai
SIEMIC, Inc.
2206 Ringwood Avenue
San Jose, CA 95131

November 4, 2008

Under Australian government legislation, the Australian Communications and Media Authority (ACMA) has determined the National Association of Testing Authorities, Australia (NATA) as an accreditation body as per Section 409(1) of the Telecommunications Act 1997 (Cth). Pursuant to Section 409(2) of the Telecommunications Act 1997 (Cth), I am pleased to advise that your laboratory has been determined as a Recognised Testing Authority (RTA).

This determination has been made on the basis of your accreditation by A2LA accreditation no. 2742.01 and the Mutual Recognition Agreement between NATA and A2LA. It is effective from 11 July 2008. RTA status applies only to the following standards and is contingent upon their continued inclusion in your laboratory's scope of accreditation.

**AS/ACIF S002, AS/ACIF S003, AS/ACIF S004,
AS/ACIF S006, AS/ACIF S016, AS/ACIF S031,
AS/ACIF S038, AS/ACIF S041 and
AS/ACIF S043.2**

As an RTA, your laboratory has the following obligations:

1. the laboratory shall continue to meet all of the accreditation criteria of A2LA;
2. the authorised representative of the laboratory shall notify NATA of changes to the staff or operations of the laboratory which would affect the performance of the tests for which the laboratory has been determined;
3. compliance of equipment shall be reported on test reports bearing the A2LA logo/endorsement.

Current information on the Australian Communications and Media Authority and regulatory requirements for telecommunications products within Australia can be obtained from the ACMA's web-site at "<http://www.acma.gov.au>". Further information about NATA may be gained by visiting "<http://www.nata.asn.au>".

Please note that AS/ACIF S040 and New Zealand standards do not form part of the RTA scheme.

Your RTA listing will appear on the NATA website shortly.

Kind Regards

Chris Norton,
Senior Scientific Officer
Measurement Science and Technology
National Association of Testing Authorities (NATA)
71-73 Flemington Road
North Melbourne Vic 3051
Australia
Ph: +61 3 9329 1633 Fx: +61 3 9326 5148
E-Mail: Christopher.Norton@nata.asn.au
Internet: www.nata.asn.au



SIEMIC ACCREDITATION DETAILS: VCCI Radiated Test Site Registration No. R-3083



CERTIFICATE

Company: SIEMIC Laboratories
<Member No. 3081 >

Facility: SIEMIC Laboratories
(Radiation 3 meter site)

Location of Facility:
2206 Ringwood Ave , San Jose, CA 95131, USA

*This is to certify that the following measuring facility
has been registered in accordance with the Rules
for Voluntary Control Measures*

Registration No.: R-3083
Date of Registration: October 01 , 2010
This Certificate is valid until September 30 , 2012

VCCI Council





SIEMIC ACCREDITATION DETAILS: VCCI Conducted (Main Port) Test Site Registration No. C-3421



VCCI Council

CERTIFICATE

Company: SIEMIC Laboratories
<Member No. 3081 >

Facility: SIEMIC Laboratories
(Main Ports Conducted Interference Measurement)

Location of Facility:
2206 Ringwood Ave San Jose, CA 95131, USA

*This is to certify that the following measuring facility
has been registered in accordance with the Rules
for Voluntary Control Measures*

Registration No.: C-3421
Date of Registration: October 01 , 2010
This Certificate is valid until September 30 , 2012

VCCI Council





SIEMIC ACCREDITATION DETAILS: VCCI Conducted (Telecom Port) Test Site Registration No. T-1597

