

HID GLOBAL CORPORATION

NON-KEYPAD ICLASS REV E READER

Model: R30E



Aug 23rd, 2012

Report No.: SL12061801-HID-018_iClass RevE_RF_R30E(FCC)
(This report supersedes NONE)

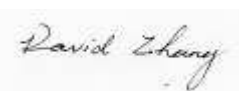

Modifications made to the product : None

This Test Report is Issued Under the Authority of:

	
David Zhang Compliance Engineer	Choon Sian Ooi Engineering Reviewer

This test report may be reproduced in full only.
Test result presented in this test report is applicable to the representative sample only.

FCC Test Report

To: FCC Part 15.207, 15.209, 15.225, RSS-GEN, RSS-210

SIEMIC, INC.
Assessing global markets



Laboratory Introduction

SIEMIC, headquartered in the heart of Silicon Valley, with superior facilities in US and Asia, is one of the leading independent testing and certification facilities providing customers with one-stop shop services for Compliance Testing and Global Certifications.



In addition to [testing](#) and [certification](#), SIEMIC provides initial design reviews and [compliance management](#) through out a project. Our extensive experience with [China](#), [Asia Pacific](#), [North America](#), [European](#), and [international](#) compliance requirements, assures the fastest, most cost effective way to attain regulatory compliance for the [global markets](#).

Accreditations for Conformity Assessment

Country/Region	Accreditation Body	Scope
USA	FCC, A2LA	EMC , RF/Wireless , Telecom
Canada	IC, A2LA, NIST	EMC, RF/Wireless , Telecom
Taiwan	BSMI , NCC , NIST	EMC, RF, Telecom , Safety
Hong Kong	OFTA , NIST	RF/Wireless , Telecom
Australia	NATA, NIST	EMC, RF, Telecom , Safety
Korea	KCC/RRA, NIST	EMI, EMS, RF , Telecom, Safety
Japan	VCCI, JATE, TELEC, RFT	EMI, RF/Wireless, Telecom
Mexico	NOM, COFETEL, Caniety	Safety, EMC , RF/Wireless, Telecom
Europe	A2LA, NIST	EMC, RF, Telecom , Safety

Accreditations for Product Certifications

Country	Accreditation Body	Scope
USA	FCC TCB, NIST	EMC , RF , Telecom
Canada	IC FCB , NIST	EMC , RF , Telecom
Singapore	iDA, NIST	EMC , RF , Telecom
EU	NB	EMC & R&TTE Directive
Japan	MIC (RCB 208)	RF , Telecom
HongKong	OFTA (US002)	RF , Telecom

This page has been left blank intentionally.

CONTENTS

1 EXECUTIVE SUMMARY & EUT INFORMATION6
2 TECHNICAL DETAILS7
3 MODIFICATION8
4 TEST SUMMARY9
5 MEASUREMENTS, EXAMINATION AND DERIVED RESULTS10
ANNEX A. TEST INSTRUMENT & METHOD.....28
ANNEX B. TEST SETUP PHOTOGRAPHS.....29
ANNEX B. I. EUT INTERNAL PHOTOGRAPHS30
ANNEX B. II. EUT EXTERNAL PHOTOGRAPHS31
ANNEX C. SUPPORTING EQUIPMENT DESCRIPTION32
ANNEX D. EUT OPERATING CONDITIONS35
ANNEX E SIEMIC ACCREDITATION36

This page has been left blank intentionally.

1 Executive Summary & EUT information

The purpose of this test programmed was to demonstrate compliance of the HID Global Corp., Model: R30E against the current Stipulated Standards for FCC 15.225 2011 and RSS-210 Issue 8: 2010.

The equipment under test radio operating frequency is 13.56 MHz.

The test has demonstrated that this unit complies with stipulated standards.

EUT Information

EUT Description : Smart Card Readers
Model No : R30E
Serial No : N/A
Input Power : 12VDC
Classification Per Stipulated Test Standard : RFID



2 TECHNICAL DETAILS

Purpose	Compliance testing of Non-Keypad iCLASS Rev E Reader with stipulated standard
Applicant / Client	HID Global Corporation
Manufacturer	HID Global Corporation 15730 Barranca Parkway Irvine, CA 92618 USA
Laboratory performing the tests	SIEMIC Laboratories 775 Montague Expressway, Milpitas, CA 95035
Date EUT received	Aug 2nd, 2012
Dates of test (from – to)	Aug 3rd - Aug 15th, 2012
Equipment Category:	DXX
Trade Name:	HID
Model :	R30E
RF Operating Frequency (ies)	13.56 MHz (RFID)
Number of Channels :	13.56MHz (1)
Modulation :	N/A
FCC ID :	JQ6-ICLASSR30E
IC ID :	2236B-ICLASSR30E

3 MODIFICATION

NONE

4 TEST SUMMARY

The product was tested in accordance with the following specifications. All testing has been performed according to below product classification:

**Smart Card Reader
Test Results Summary**

Test Standard		Description	Test Date	Pass / Fail
47 CFR Part 15.225: 2011	RSS 210 Issue 8: 2010			
15.203		Antenna Requirement	N/A	Pass
15.207(a)	RSS Gen(7.2.2)	Conducted Emissions Voltage	8/13/2012	Pass
15.225(a)	RSS210(A2.6)	Limit in the band of 13.553 – 13.567 MHz	8/03/2012	Pass
15.225(b)	RSS210(A2.6)	Limit in the band of 13.410 – 13.553 MHz and 13.567 – 13.710 MHz	8/03/2012	Pass
15.225(c)	RSS210(A2.6)	Limit in the band of 13.110 – 13.410 MHz and 13.710 – 14.010 MHz	8/03/2012	Pass
15.225(d), 15.209	RSS210(A2.6)	Limit outside the band of 13.110 – 14.010 MHz	8/03/2012	Pass
15.225(e)	RSS210(A2.6)	Frequency Stability	8/15/2012	Pass
	RSS-210(5.9.1)	Occupied Bandwidth	8/03/2012	Pass
ANSI C63.4: 2003/ RSS-Gen Issue 3: 2010				
PS: All measurement uncertainties are not taken into consideration for all presented test result.				

5 MEASUREMENTS, EXAMINATION AND DERIVED RESULTS

5.1 Antenna Requirement

Requirement(s): 47 CFR §15.203

An intentional radiator shall be designed to ensure that no antenna other than that furnished by the responsible party shall be used with the device.

Antenna requirement must meet at least one of the following:

- a) Antenna must be permanently attached to the device.
 - b) Antenna must use a unique type of connector to attach to the device.
 - c) Device must be professionally installed. Installer shall be responsible for ensuring that the correct antenna is employed with the device.
-
- 1) The RFID antenna is integral to the main board permanently to the device which meets the requirement (See Internal Photographs submitted as another Exhibit).

5.2 Conducted Emissions Voltage

Standard Requirement: 47 CFR §15.207

The frequency voltage that is conducted back onto the AC power line on any frequency or frequencies, within the band 150 kHz to 30 MHz, shall not exceed the limits in the following table, as measured using a 50 [μH]/50 ohms line impedance stabilization network (LISN). The lower limit applies at the boundary between the frequencies ranges.

AC Line Limit

Frequency ranges (MHz)	Limit (dBuV)	
	QP	Average
0.15 ~ 0.5	66 – 56	56 – 46
0.5 ~ 5	56	46
5 ~ 30	60	50

Note:

1.	All possible modes of operation were investigated. Only the 6 worst case emissions measured, using the correct CISPR and Average detectors, are reported. All other emissions were relatively insignificant.
2.	A "-ve" margin indicates a PASS as it refers to the margin present below the limit line at the particular frequency.
3.	<p><u>Conducted Emissions Measurement Uncertainty</u></p> <p>All test measurements carried out are traceable to national standards. The uncertainty of the measurement at a confidence level of approximately 95% (in the case where distributions are normal), with a coverage factor of 2, in the range 150kHz – 30MHz (Average & Quasi-peak) is ±3.5dB.</p>

Test Set-up

1. The EUT and supporting equipment were set up in accordance with the requirements of the standard on top of a 1.5m x 1m x 0.8m high, non-metallic table, as shown in Annex B.
2. The power supply for the EUT was fed through a 50Ω/50μH EUT LISN, connected to filtered mains.
3. The RF OUT of the EUT LISN was connected to the EMI test receiver via a low-loss coaxial cable.
4. All other supporting equipments were powered separately from another main supply.

Test Method

1. The EUT was switched on and allowed to warm up to its normal operating condition.
2. A scan was made on the NEUTRAL line (for AC mains) or Earth line (for DC power) over the required frequency range using an EMI test receiver.
3. High peaks, relative to the limit line, were then selected.
4. The EMI test receiver was then tuned to the selected frequencies and the necessary measurements made with a receiver bandwidth setting of 10 KHz. For FCC tests, only Quasi-peak measurements were made; while for CISPR/EN tests, both Quasi-peak and Average measurements were made.
5. Steps 2 to 4 were then repeated for the LIVE line (for AC mains) or DC line (for DC power).

Description of Conducted Emission Program

This EMC Measurement software run LabView automation software and offers a common user interface for electromagnetic interference (EMI) measurements. This software is a modern and powerful tool for controlling and monitoring EMI test receivers and EMC test systems. It guarantees reliable collection, evaluation, and documentation of measurement results. Basically, this program will run a pre-scan measurement before it proceeds with the final measurement. The pre-scan routine will run the common scan range from 15 kHz to 30 MHz; the program will first start a peak and average scan on selectable measurement time and step size. After the program complete the pre-scan, this program will perform the Quasi Peak and Average measurement, based on the pre-scan peak data reduction result.

Sample Calculation Example

At 20 MHz	limit = 250 μ V = 47.96 dB μ V
Transducer factor of LISN, pulse limiter & cable loss at 20 MHz = 11.20 dB	
Q-P reading obtained directly from EMI Receiver = 40.00 dB μ V	
	(Calibrated for system losses)
Therefore, Q-P margin = 47.96 – 40.00 = 7.96	i.e. 7.96 dB below limit

Test Result: Pass

Test Result

Test specification:	Conducted Emission (CE) per	FCC	
Environ Conditions:	Temp:	23°C	Result: Pass
	Humidity:	43.20%	
	Atmospheric:	1019mbar	
Voltage/Line & Phase	120VAC, 60Hz/ Neutral		
Test Date:	08/13/2012		
Tested by:	David Zhang		
EUT Operating Mode:	Normal operation		
EUT Configuration:	N/A		
Remarks:	NONE		

Quasi-Peak Limit

Average Limit

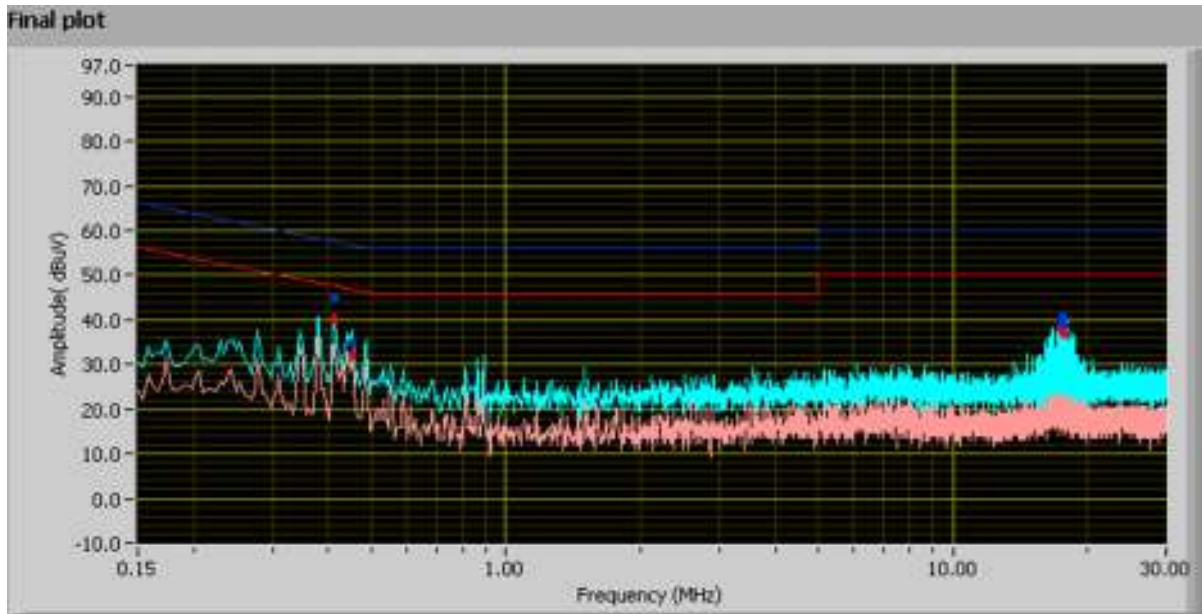

120V, 60Hz, Neutral

Frequency (MHz)	QP Value (dBuV)	Class A Limit (dBuV)	Margin (dB)	Avg Value (dBuV)	Class A Limit (dBuV)	Margin (dB)
0.41	45.18	57.59	-12.41	40.07	47.59	-7.52
0.45	34.81	56.81	-22.00	31.94	46.81	-14.87
17.40	39.59	60.00	-20.41	38.07	50.00	-11.93
17.55	40.85	60.00	-19.15	39.78	50.00	-10.22
17.63	40.75	60.00	-19.25	39.61	50.00	-10.39
17.78	38.86	60.00	-21.14	36.69	50.00	-13.31

Test specification:	Conducted Emission (CE) per	FCC		
Environ Conditions:	Temp:	23°C	Result:	Pass
	Humidity:	43.20%		
	Atmospheric:	1019mbar		
Voltage/Line & Phase	120VAC, 60Hz/ Line			
Test Date:	08/13/2012			
Tested by:	David Zhang			
EUT Operating Mode:	Normal operation			
EUT Configuration:	N/A			
Remarks:	NONE			

Quasi-Peak Limit

Average Limit

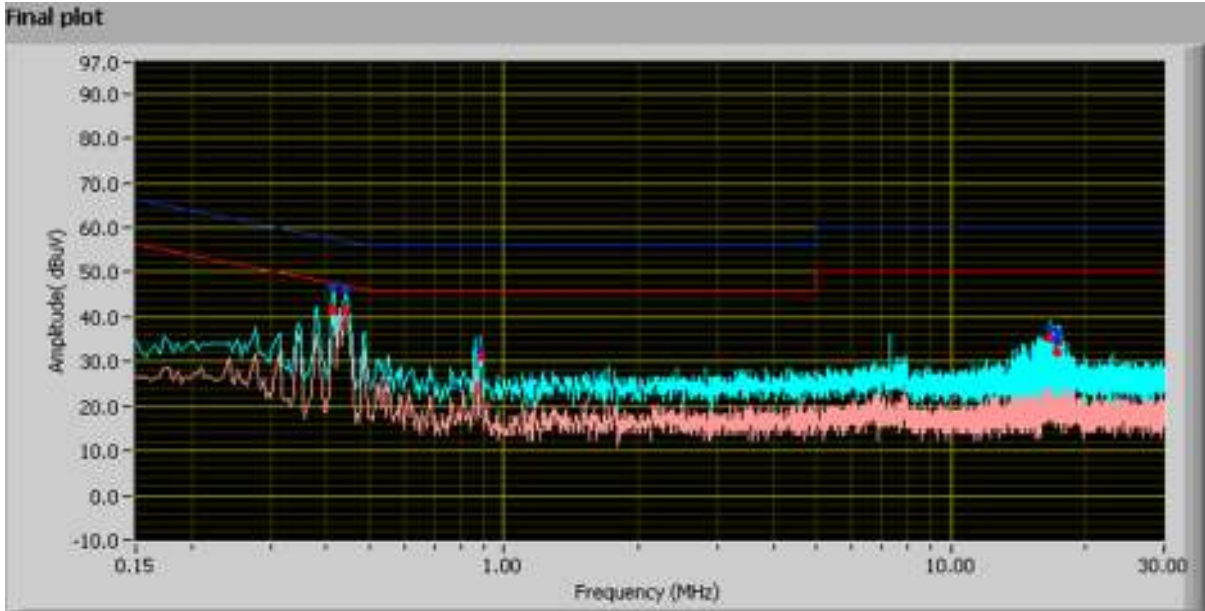

120V, 60Hz, Line

Frequency	QP Value	Class A Limit	Margin	Avg Value	Class A Limit	Margin
(MHz)	(dBuV)	(dBuV)	(dB)	(dBuV)	(dBuV)	(dB)
0.41	46.48	57.59	-11.11	41.37	47.59	-6.22
0.44	46.13	57.04	-10.91	41.64	47.04	-5.40
0.88	32.82	56.00	-23.18	31.32	46.00	-14.68
16.63	37.13	60.00	-22.87	35.17	50.00	-14.83
17.32	34.99	60.00	-25.01	31.91	50.00	-18.09
17.47	36.45	60.00	-23.55	34.29	50.00	-15.71

5.3 Radiated Emission (9kHz - 30MHz, H-Field)(outside operation band)

Requirement(s): 47 CFR §15.225 & RSS-210 (A2.6) & RSS-310 (3.7)

§ 15.225 Operation within the band 13.110–14.010 MHz.

(a) The field strength of any emissions within the band 13.553–13.567 MHz shall not exceed 15,848 microvolts/meter at 30 meters.

(b) Within the bands 13.410–13.553 MHz and 13.567–13.710 MHz, the field strength of any emissions shall not exceed 334 microvolts/meter at 30 meters.

(c) Within the bands 13.110–13.410 MHz and 13.710–14.010 MHz the field strength of any emissions shall not exceed 106 microvolts/meter at 30 meters.

(d) The field strength of any emissions appearing outside of the 13.110–14.010 MHz band shall not exceed the general radiated emission limits in §15.209.

Measurement uncertainty

All test measurements carried out are traceable to national standards. The uncertainty of the measurement at a confidence level of approximately 95% (in the case where distributions are normal), with a coverage factor of 2, is +/- 6dB.

Test Set-up

1. The EUT and supporting equipment were set up in accordance with the requirements of the standard on top of a 1.5m X 1.0m X 0.8m high, non-metallic table.
2. The filtered power supply for the EUT and supporting equipment were tapped from the appropriate power sockets located on the turntable.
3. The relevant loop antenna was set at the required test distance away from the EUT and supporting equipment boundary.

Test Method:

For < 30MHz, Radiated emissions were measured according to ANSI C63.4. The EUT was set to transmit at the highest output power. The EUT was set 10 meter away from the measuring antenna. The loop antenna was positioned 1 meter above the ground from the centre of the loop. The measuring bandwidth was set to 10 kHz. (Note: During testing the receive antenna was rotated about its axis to maximize the emission from the EUT.)

The limit is converted from microvolt/meter to decibel microvolt/meter.

Sample Calculation: Corrected Amplitude = Raw Amplitude (dBµV/m) + ACF (dB) + Cable Loss (dB) – Distance Correction Factor



100 kHz ~ 1 MHz

General Emission Limit @ 3 Meter

Loop Antenna at 0 degree

FCC- 100KHz to 1000KHz Radiated Emission at 3meter Distance

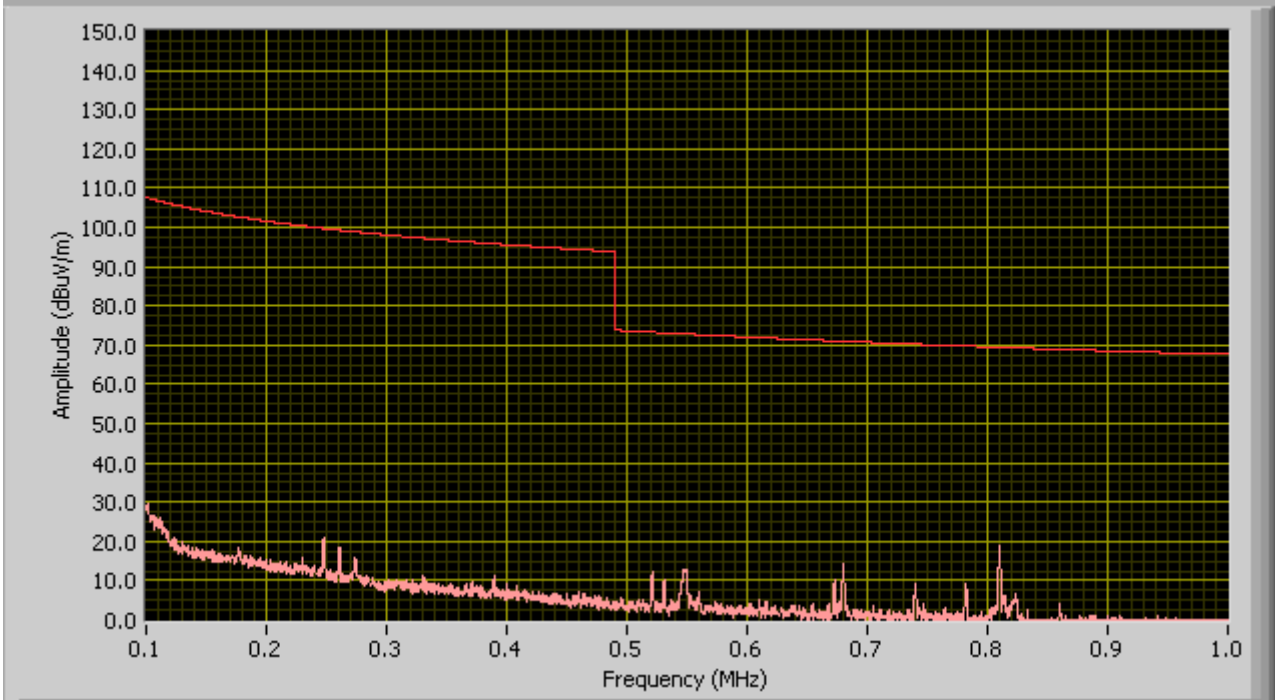

Loop Antenna at 90 degree

FCC- 100KHz to 1000KHz Radiated Emission at 3meter Distance

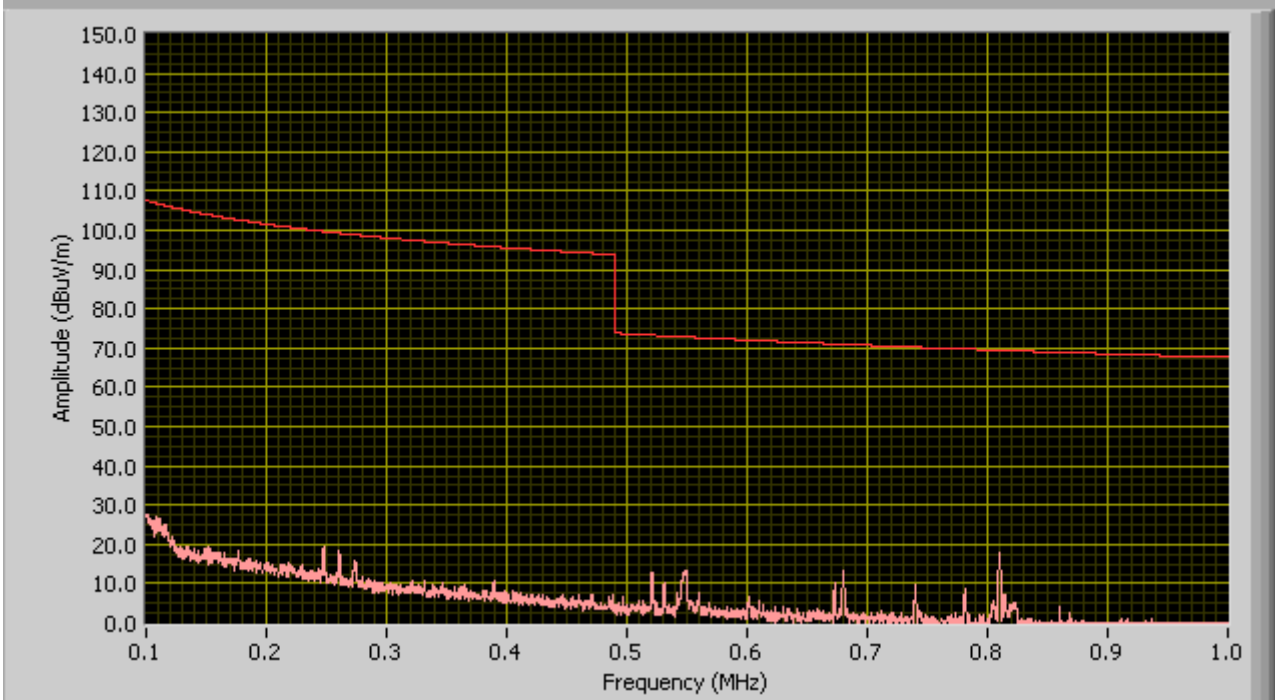

1MHz ~ 30MHz

General Emission Limit @ 3 meter

Loop Antenna at 0 degree

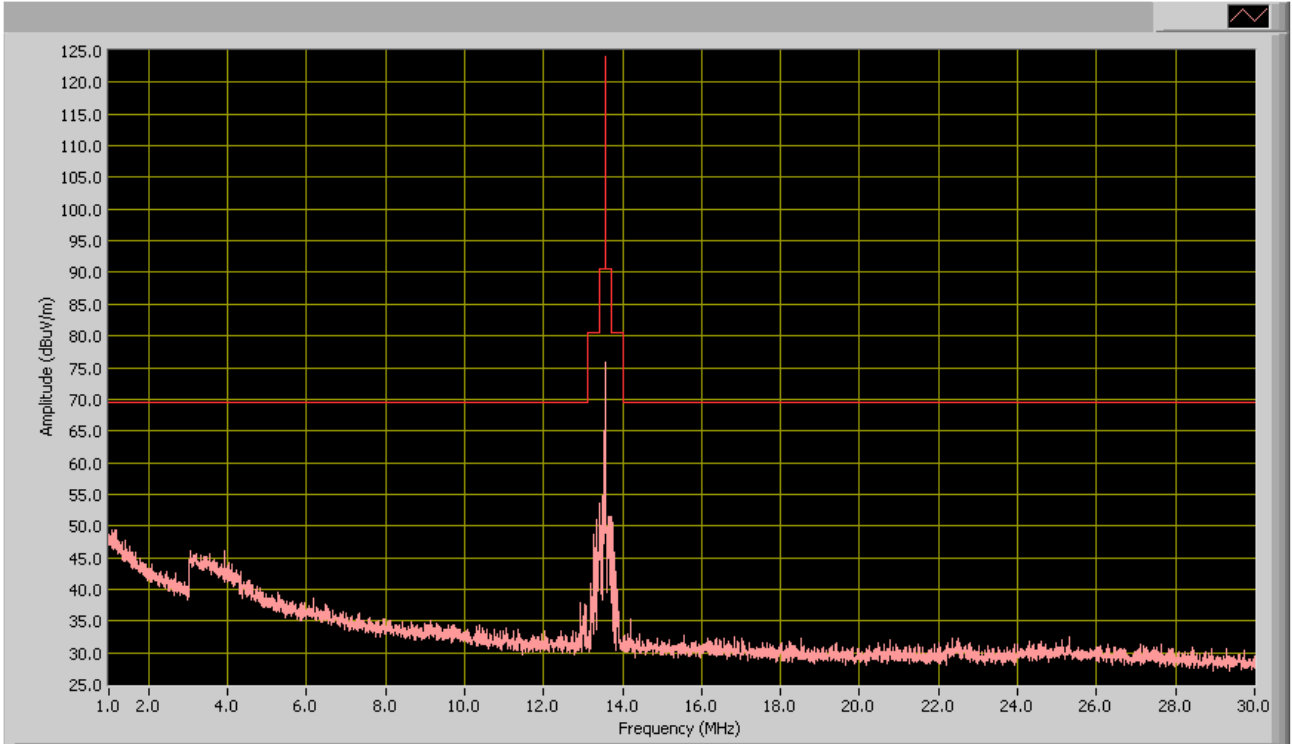

Loop Antenna at 90 degree

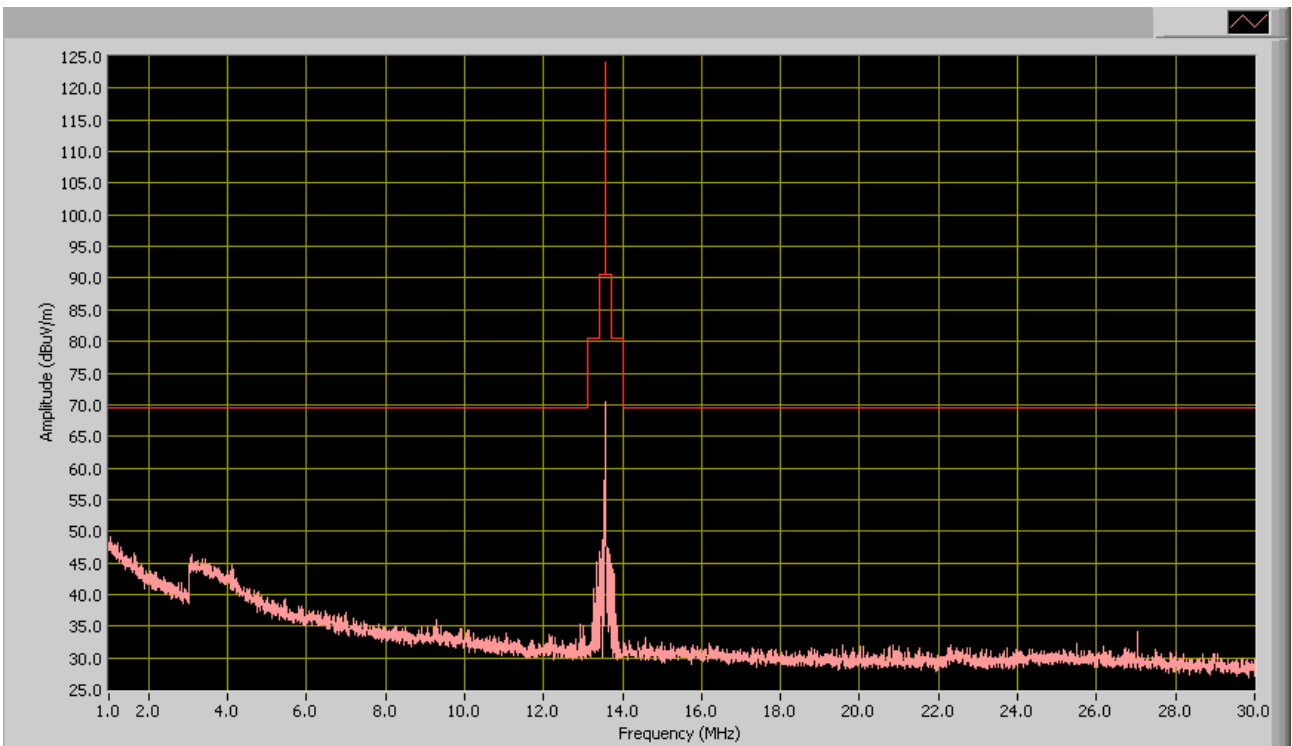

5.4 Radiated Emissions > 30 MHz (30MHz – 1 GHz, E-Field)

Standard Requirement(s): 47 CFR §15.209; 47 CFR §15.225(d) & RSS-210 (A2.6)

§ 15.225 Operation within the band 13.110–14.010 MHz.

(a) The field strength of any emissions within the band 13.553–13.567 MHz shall not exceed 15,848 microvolts/meter at 30 meters.

(b) Within the bands 13.410–13.553 MHz and 13.567–13.710 MHz, the field strength of any emissions shall not exceed 334 microvolts/meter at 30 meters.

(c) Within the bands 13.110–13.410 MHz and 13.710–14.010 MHz the field strength of any emissions shall not exceed 106 microvolts/meter at 30 meters.

(d) The field strength of any emissions appearing outside of the 13.110–14.010 MHz band shall not exceed the general radiated emission limits in §15.209.

Measurement uncertainty

All test measurements carried out are traceable to national standards. The uncertainty of the measurement at a confidence level of approximately 95% (in the case where distributions are normal), with a coverage factor of 2, in the range 30MHz – 1GHz (QP only @ 3m & 10m) is +6.0dB (for EUTs < 0.5m X 0.5m X 0.5m).

Test Set-up



1. The EUT and supporting equipment were set up in accordance with the requirements of the standard on top of a 1.5m X 1.0m X 0.8m high, non-metallic table.
2. The filtered power supply for the EUT and supporting equipment were tapped from the appropriate power sockets located on the turntable.
3. The relevant broadband antenna was set at the required test distance away from the EUT and supporting equipment boundary.

Test Method

1. The EUT was switched on and allowed to warm up to its normal operating condition.
2. The test was carried out at the selected frequency points obtained from the EUT characterisation. Maximization of the emissions, was carried out by rotating the EUT, changing the antenna polarization, and adjusting the antenna height in the following manner:
 - a. Vertical or horizontal polarisation (whichever gave the higher emission level over a full rotation of the EUT) was chosen.
 - b. The EUT was then rotated to the direction that gave the maximum emission.
 - c. Finally, the antenna height was adjusted to the height that gave the maximum emission.
3. A Quasi-peak measurement was then made for that frequency point.
4. Steps 2 and 3 were repeated for the next frequency point, until all selected frequency points were measured.
5. The frequency range covered was from 30MHz to 1GHz (for FCC tests, until the 5th harmonic for operating frequencies \geq 108MHz), using the Biconical antenna for frequencies from 30MHz to 230MHz, Log-periodical antenna for frequencies from 230MHz to 1GHz, and the Horn antenna above 1GHz.



Test specification:	Radiated Emission (RE)				
Environ Conditions:	Temp:	23°C	Result:	Pass	
	Humidity:	43.20%			
	Atmospheric:	1019mbar			
Mains Power:	12VDC				
Test Date:	8/3/2012				
Tested by:	David Zhang				
EUT Operating Mode:	13.56MHz				
EUT Configuration:	Transmitting				
Remarks:	NONE				

Peak Detector 
Quasi Peak Limit 

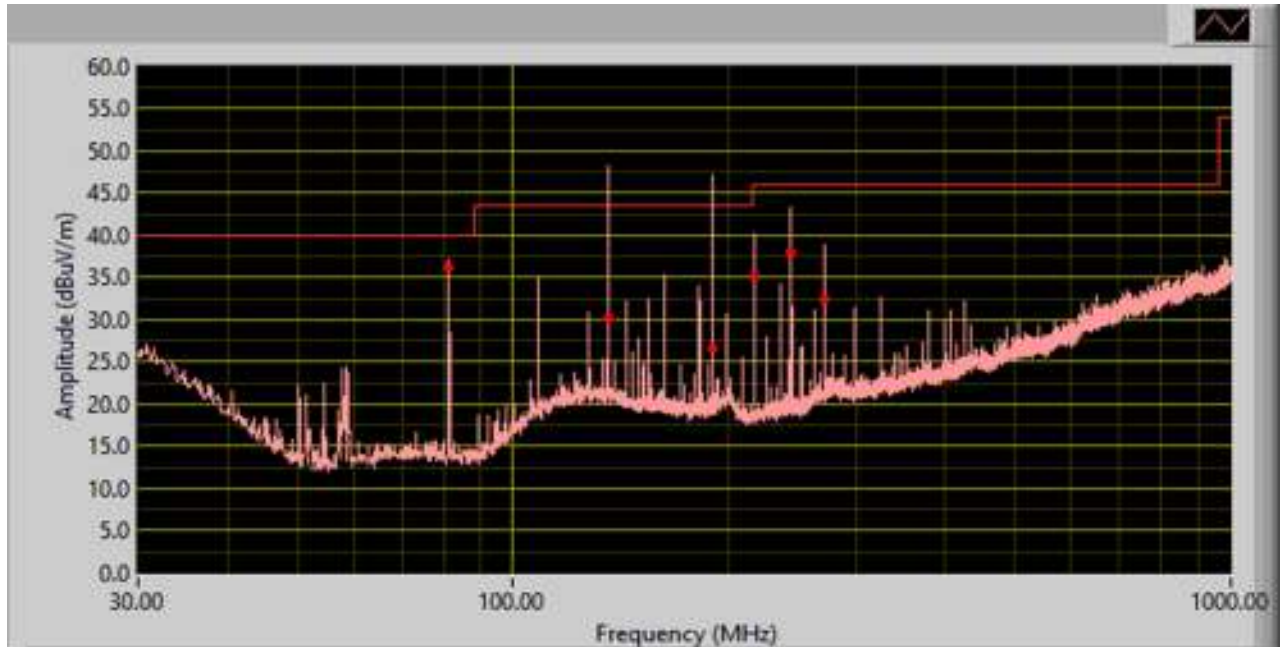

Below 1GHz Emission Test Data @ 3M

Frequency (MHz)	QP Value (dBuV/m)	Azimuth (degree)	Polarity (H/V)	Height (cm)	Class B Limit (dBuV/m)	Margin (dB)
135.61	30.13	153.00	H	201.00	43.52	-13.40
189.80	26.75	138.00	H	115.00	43.52	-16.77
244.04	38.00	27.00	H	107.00	46.00	-8.00
81.34	36.29	164.00	H	228.00	40.00	-3.71
216.92	35.04	29.00	H	119.00	46.00	-10.96
271.16	32.45	23.00	H	101.00	46.00	-13.55
941.87	30.32	129.00	H	152.00	46.00	-15.68

5.5 Frequency Stability

Standard Requirement(s): 47 CFR §15.225(e) & RSS-210 (A2.6)

Limit:

The frequency tolerance of the carrier signal shall be maintained within $\pm 0.01\%$ of the operating frequency over a temperature variation of -20 degrees to $+50$ degrees C at normal supply voltage, and for a variation in the primary supply voltage from 85% to 115% of the rated supply voltage at a temperature of 20 degrees C. For battery operated equipment, the equipment tests shall be performed using a new battery.

Test Set-up

1. The EUT was set up inside a semi-anechoic chamber in accordance with the standard.
2. The EUT was placed on top of a 0.8m high, non-metallic table in a typical configuration.

Test Method

Frequency Stability was measured according to 47 CFR §2.1055. Measurement was taken with spectrum analyzer. The spectrum analyzer bandwidth and span was set to read in hertz. A voltmeter was used to monitor when varying the voltage.

1. The EUT was switched on and allowed to warm up to its normal operating condition.
2. To measure conducted, a SMA cable was used to replace the EUT antenna. To measure radiated, an external antenna was used to detect EUT transmission signal.
3. Measurement of the frequency of EUT transmission signal and make record.
- 4.

Frequency Stability versus Temperature: The Frequency tolerance of the carrier signal shall be maintained within $\pm 0.01\%$ of the operating frequency over a temperature variation of -20°C to $+50^{\circ}\text{C}$ at normal supply voltage.

Test specification:	Frequency Stability			
Environ Conditions:	Temp:	23°C	Result:	Pass
	Humidity:	43.20%		
	Atmospheric:	1019mbar		
Mains Power:	12VDC			
Test Date:	8/15/2012			
Tested by:	David Zhang			
EUT Operating Mode:	13.56MHz			
EUT Configuration:	Transmitting			
Remarks:	NONE			

Test Result for 13.56 MHz radio

Frequency Stability versus Temperature: The Frequency tolerance of the carrier signal shall be maintained within $\pm 0.01\%$ of the operating frequency over a temperature variation of -20°C to +50°C at normal supply voltage.

Reference Frequency: 13.561058 MHz at -20°C and +50°C

Temperature	Measured Freq.	Freq. Drift	Freq. Deviation	Pass/Fail
(°C)	(MHz)	(Hz)	(Limit: 0.01%)	
50	13.561037	-21	<0.01	Pass
40	13.561042	-16	<0.01	Pass
30	13.560967	-91	<0.01	Pass
20	Reference	13.561058	MHz	
10	13.561033	-25	<0.01	Pass
0	13.561008	-50	<0.01	Pass
-10	13.561	-58	<0.01	Pass
-20	13.560917	-141	<0.01	Pass

Frequency Stability versus Input Voltage: The Frequency tolerance of the carrier signal shall be maintained within $\pm 0.01\%$, the frequency of the transmitter was measured at 85% and at 115% of the rated power supply voltage at 20°C environmental temperature.

Carrier Frequency: 13.561058 MHz at 20°C at 12VDC

Measured Voltage $\pm 15\%$ of nominal (DC)	Measured Freq. (MHz)	Freq. Drift (Hz)	Freq. Deviation (Limit: 0.01%)	Pass/Fail
10.2	13.561058	0	<0.01	Pass
13.8	13.561058	0	<0.01	Pass

5.6 Fundamental Field Strength Test Result

Standard Requirement:

§ 15.225 Operation within the band 13.110–14.010 MHz.

(a) The field strength of any emissions within the band 13.553–13.567 MHz shall not exceed 15,848 microvolts/meter at 30 meters.

(b) Within the bands 13.410–13.553 MHz and 13.567–13.710 MHz, the field strength of any emissions shall not exceed 334 microvolts/meter at 30 meters.

(c) Within the bands 13.110–13.410 MHz and 13.710–14.010 MHz the field strength of any emissions shall not exceed 106 microvolts/meter at 30 meters.

(d) The field strength of any emissions appearing outside of the 13.110–14.010 MHz band shall not exceed the general radiated emission limits in §15.209.

Measurement uncertainty

All test measurements carried out are traceable to national standards. The uncertainty of the measurement at a confidence level of approximately 95% (in the case where distributions are normal), with a coverage factor of 2, is +/-6dB.

Test Set-up

1. The EUT and supporting equipment were set up in accordance with the requirements of the standard on top of a 1.5m X 1.0m X 0.8m high, non-metallic table.
2. The filtered power supply for the EUT and supporting equipment were tapped from the appropriate power sockets located on the turntable.
3. The relevant loop antenna was set at the required test distance away from the EUT and supporting equipment boundary.

Test Method:

For < 30MHz, Radiated emissions were measured according to ANSI C63.4. The EUT was set to transmit at the highest output power. The EUT was set 10 meter away from the measuring antenna. The loop antenna was positioned 1 meter above the ground from the centre of the loop. The measuring bandwidth was set to 10 kHz. (Note: During testing the receive antenna was rotated about its axis to maximize the emission from the EUT.)

The limit is converted from microvolt/meter to decibel microvolt/meter.

Sample Calculation: Corrected Amplitude = Raw Amplitude (dBµV/m) + ACF (dB) + Cable Loss (dB) – Distance Correction Factor



Test Result

Test specification:	Channel Separation Per	47CFR15.247	Test Method	FCC		
Environ Conditions:	Temp:	23°C	Result:	Pass		
	Humidity:	43.20%				
	Atmospheric:	1019mbar				
Mains Power:	12VDC					
Test Date:	8/03/2012					
Tested by:	David Zhang					
EUT Operating Mode:	Transmitting					
EUT Configuration:	13.56MHz					
Remarks:	NONE					
Index	Radio	Frequency (MHz)	Antenna Deg	Measured (dBuV/m)	Limit (dBuV/m)	Margin (dB)
1	R30E	13.56	0deg	76.00	124.00	Pass
2	R30E	13.56	90deg	70.50		

Loop Antenna at 0 degree

General Emission Limit @ 3 meter

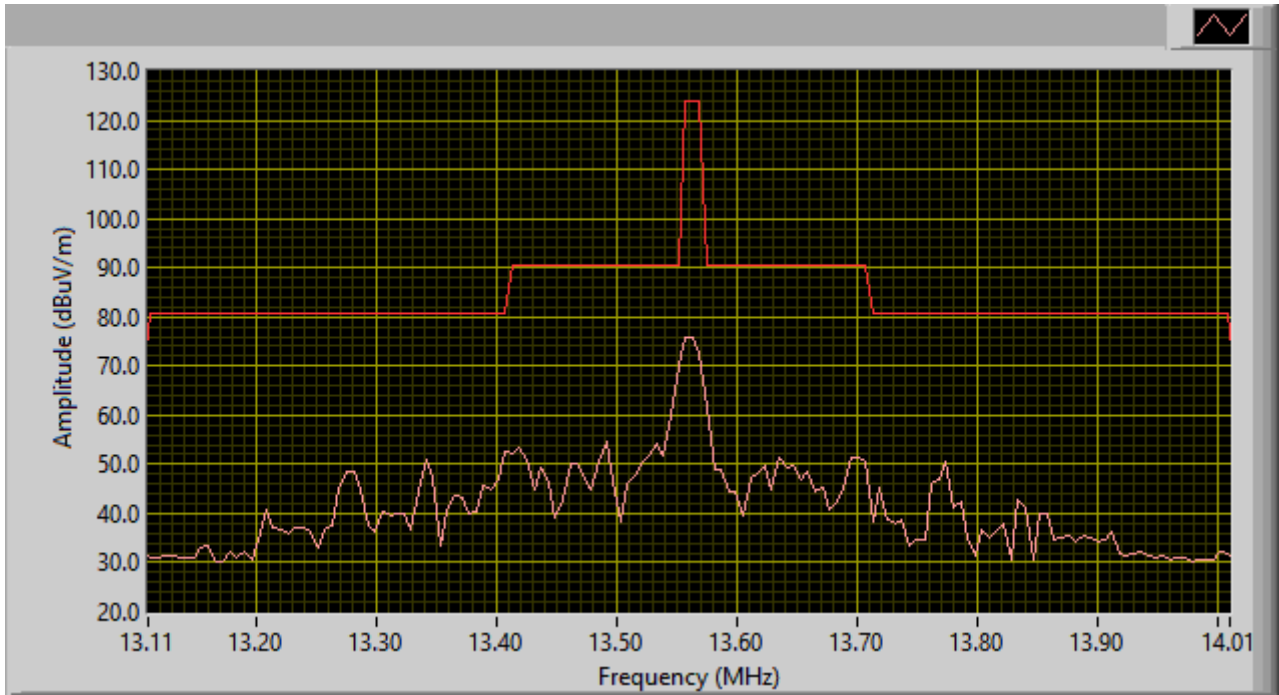

Frequency (MHz)	Corrected Amplitude Reading (dBuV/m)
13.56	76.00

Loop Antenna at 90 degree



Frequency (MHz)	Corrected Amplitude Reading (dBuV/m)
13.56	70.50

5.7 Occupied Bandwidth

Standard Requirement: RSS-210 (5.9.1)

Measurement uncertainty

All test measurements carried out are traceable to national standards. The uncertainty of the measurement at a confidence level of approximately 95% (in the case where distributions are normal), with a coverage factor of 2, in the range 30MHz – 40GHz is $\pm 1.5\text{dB}$

Test Set-up

1. The EUT was set up inside a semi-anechoic chamber in accordance with the standard.
2. The EUT was placed on top of a 0.8m high, non-metallic table in a typical configuration.

Test Method

1. The EUT was switched on and allowed to warm up to its normal operating condition.
2. To measure conducted, a SMA cable was used to replace the EUT antenna. To measure radiated, an external antenna was used to detect EUT transmission signal.
3. Measurement of the 99% Occupied Bandwidth of EUT transmission signal and make record.

Test Result: Pass

Test specification:	99% Occupied Bandwidth			Result:	N/A
Environ Conditions:	Temp:	23°C			
	Humidity:	43.2%			
	Atmospheric:	1019mbar			
Voltage/Line & Phase	N/A				
Test Date:	8/3/2012				
Tested by:	David				
Remarks:	R30E				

Test Result

Radio	Channel Frequency (MHz)	99% Occupied BW (KHz)	Limit (MHz)
13.56MHz Radio	13.56	4.112	N/A

Plots

Plots: 13.56 MHz

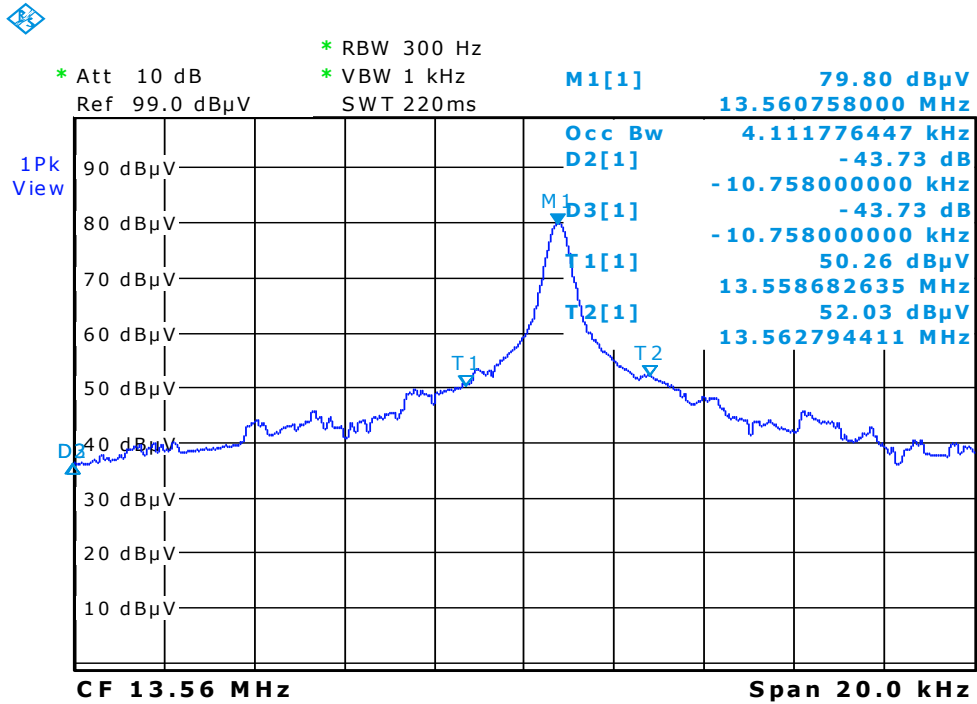

Date: 3.AUG.2012 01:26:54

Annex A. TEST INSTRUMENT & METHOD

Annex A.i. TEST INSTRUMENTATION & GENERAL PROCEDURES

Instrument	Model	Serial #	Cal Date	Cal Cycle	Cal Due	In use
Conducted Emissions						
R & S Receiver	ESIB 40	100179	04/20/2012	1 Year	04/20/2013	<input checked="" type="checkbox"/>
R&S LISN	ESH2-Z5	861741/013	05/18/2012	1 Year	05/18/2013	<input checked="" type="checkbox"/>
CHASE LISN	MN2050B	1018	07/24/2012	1 Year	07/24/2013	<input checked="" type="checkbox"/>
Sekonic Hygro Hermograph	ST-50	HE01-000092	05/25/2012	1 Year	05/25/2013	<input checked="" type="checkbox"/>
Radiated Emissions						
R & S Receiver	ESL6	100178	03/01/2012	1 Year	03/01/2013	<input checked="" type="checkbox"/>
R & S Receiver	ESIB 40	100179	04/20/2012	1 Year	04/20/2013	<input type="checkbox"/>
Spectrum Analyzer	E4407B	US88441016	5/31/2012	1 Year	05/31/2013	<input checked="" type="checkbox"/>
Passive Loop Antenna (10k-30MHz)	6512	49120	5/22/2012	1 Year	5/22/2013	<input checked="" type="checkbox"/>
Bi-Log antenna (30MHz~2GHz)	JB1	A030702	02/09/2012	1 Year	02/09/2013	<input checked="" type="checkbox"/>
Horn Antenna (1-26.5GHz)	3115	10SL0059	04/26/2012	1 Year	04/26/2013	<input type="checkbox"/>
Horn Antenna (18-40 GHz)	AH-840	101013	04/23/2012	1 Year	04/23/2013	<input type="checkbox"/>
Pre-Amplifier (1-26.5GHz)	8449B	3008A00715	05/30/2012	1 Year	05/30/2013	<input type="checkbox"/>
Microwave Preamplifier (18-40GHz)	PA-840	181251	05/30/2012	1 Year	05/30/2013	<input type="checkbox"/>
3 Meters SAC	3M	N/A	10/13/2011	1 Year	10/13/2012	<input type="checkbox"/>
10 Meters SAC	10M	N/A	06/05/2012	1 Year	06/05/2013	<input checked="" type="checkbox"/>
Sekonic Hygro Hermograph	ST-50	HE01-000092	05/25/2012	1 Year	05/25/2013	<input checked="" type="checkbox"/>
Radio Communication Tester	CMU200	111078	11/30/2011	1 Year	11/30/2012	<input type="checkbox"/>
Permitted Freq Range						
R & S Receiver	ESIB 40	100179	4/20/2012	1 Year	4/20/2013	<input type="checkbox"/>
Spectrum Analyzer	E4407B	US88441016	5/31/2012	1 Year	05/31/2013	<input type="checkbox"/>
Spectrum Analyzer	8564E	3738A00962	5/14/2012	1 Year	05/14/2013	<input checked="" type="checkbox"/>
TestEquity Environment Chamber	1007H	61201	07/05/2012	1 Year	07/05/2013	<input checked="" type="checkbox"/>
Signal Analyzer	FSIQ7	825555/013	5/10/2012	1 Year	5/10/2013	<input type="checkbox"/>

Annex B. TEST SETUP PHOTOGRAPHS

Please See Attachment

Annex B. i. EUT INTERNAL PHOTOGRAPHS

Please see attachment

Annex B. ii. EUT EXTERNAL PHOTOGRAPHS

Please see attachment

Annex C. SUPPORTING EQUIPMENT DESCRIPTION

The following is a description of supporting equipment and details of cables used with the EUT.

Equipment Description (Including Brand Name)	Model & Serial Number	Cable Description (List Length, Type & Purpose)
Laptop/IBM	R51	Ethernet Cable , 2m

NOTE: No special supporting equipment used or needed during testing to achieve compliance.

Block Configuration Diagram for Radiated Emission

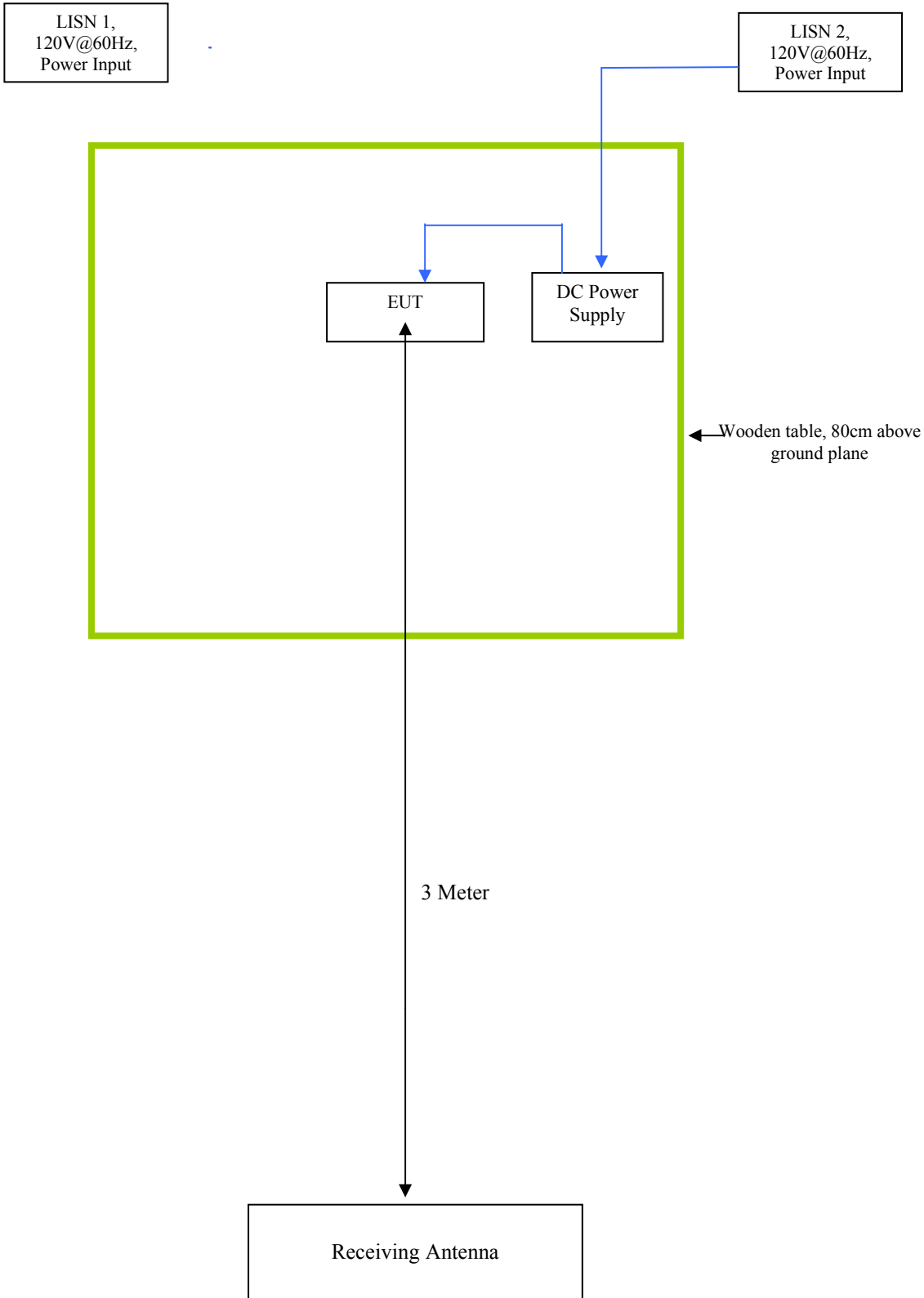

Block Configuration Diagram for AC Conducted Emission

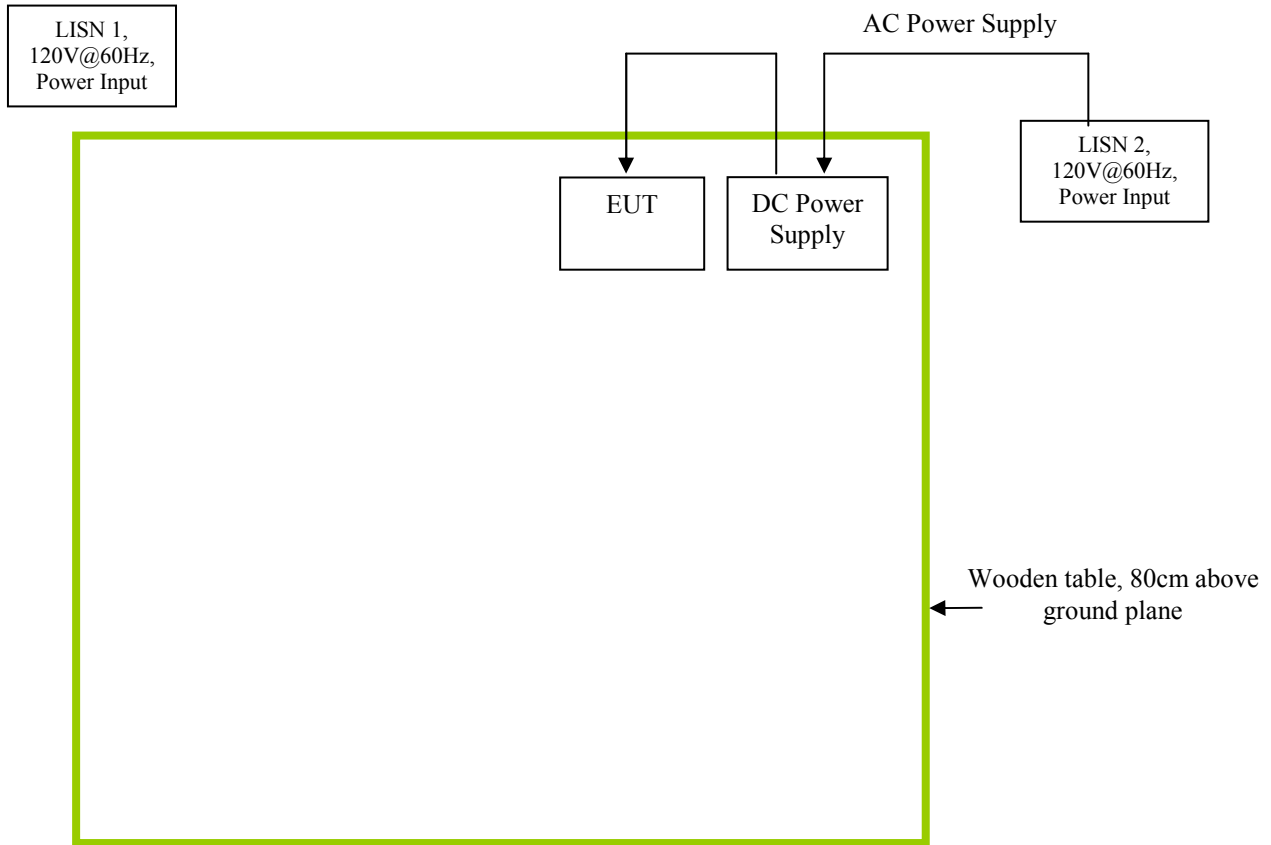

Annex D. EUT OPERATING CONDITIONS

The following is the description of how the EUT is exercised during testing.

Test	Description Of Operation
Emissions Testing	The EUT was transmitting once it's powered on.
Others Testing	The EUT was transmitting once it's powered on.

Annex E SIEMIC ACCREDITATION

SIEMIC ACCREDITATION DETAILS: A2LA 17025 & ISO Guide 65 : 2742.01 , 2742.2



The American Association for Laboratory Accreditation
World Class Accreditation

Accredited Laboratory

A2LA has accredited

SIEMIC, INC.
dba SIEMIC LABORATORIES
Milpitas, CA
for technical competence in the field of
Electrical Testing

This laboratory is accredited in accordance with the recognized International Standard ISO/IEC 17025:2005 *General Requirements for the Competence of Testing and Calibration Laboratories*. This accreditation demonstrates technical competence for a defined scope and the operation of a laboratory quality management system (refer to joint ISO-ILAC-IAF Communiqué dated 8 January 2009).

Presented this 23rd day of November 2010.



Peter Abney
President & CEO
For the Accreditation Council
Certificate Number 2742.01
Valid to September 30, 2012
Revised August 2, 2012

For the tests or types of tests to which this accreditation applies, please refer to the laboratory's Electrical Scope of Accreditation.



SCOPE OF ACCREDITATION TO ISO/IEC 17025:2005

SIEMIC, INC. ¹
dba SIEMIC LABORATORIES
775 Montague Expressway
Milpitas, CA 95035

Mr. Leslie Bai Phone: 408 526 1188 Email: leslie.bai@siemic.com
Mr. Snell Leong Phone: 408 526 1188 Email: snell.leong@siemic.com
www.siemic.com

ELECTRICAL

Valid to: September 30, 2012

Certificate Number: 2742.01

In recognition of the successful completion of the A2LA evaluation process, accreditation is granted to this laboratory to perform the following EMC, Product Safety, Radio and Telecommunication tests:

Test Description:	Test Method:
EN & IEC – Emissions & Immunity	IEC/CISPR 11; IEC/CISPR 12; EN 55011; IEC/CISPR 22; EN 55022; IEC/CISPR 20; EN 55020; EN 61000-6-1; EN 61000-6-2; EN 61000-6-3; EN 61000-6-4; EN 61204-3; EN 61326, EN 61326-1; EN 61000-3-2; EN 61000-3-3; EN 50081-1, EN 50081-2; EN 50082-1; IEC 61000-4-2; EN 61000-4-2; IEC 61000-4-3 (limited up to 2.7 GHz and 3V/m); EN 61000-4-3; (limited up to 2.7 GHz and 3V/m); IEC 61000-4-4; EN 61000-4-4; IEC 61000-4-5; EN 61000-4-5; IEC 61000-4-6; EN 61000-4-6; IEC 61000-4-8; EN 61000-4-8; IEC 61000-4-11; EN 61000-4-11; IEC/CISPR 24; EN 55024; EN 50412-2-1; EN 50083-2; EN 50090-2-2; EN 50091-2; EN 50130-4; EN 50130-4 +A12; IEC 60601-1-2; EN 12184; EN 55015; EN 61547; CISPR 16-1-4
Korea – Emissions & Immunity	RRA Public Notification 2011-18; RRA Announce 2010-5; Annex 2(KN 11); Annex 3(KN 13); Annex 4(KN 14-1); Annex 5(KN 22); Annex 6(KN 41); Annex 7(KN 50); Annex 9(KN 15); Annex 10(KN 19); Annex 11(KN 60); Annex 1-1(KN 16-1-1); Annex 1-2(KN 16-1-2); Annex 1-3(KN 16-1-3); Annex 1-4(KN 16-1-4); Annex 1-5(KN 16-1-5); Annex 1-6(KN 16-2-1); Annex 1-7(KN 16-2-2); Annex 1-8(KN 16-2-3); Annex 1-9(KN 16-2-4); RRA Public Notification 2011-17; RRA Announce 2010-6; Annex 1-1(KN 61000-4-2); Annex 1-2(KN 61000-4-3); Annex 1-3(KN 61000-4-4); Annex 1-4(KN 61000-4-5); Annex 1-5(KN 61000-4-6); Annex 1-6(KN 61000-4-8); Annex 1-7(KN 61000-4-11); Annex 2(KN 60601-1-2); Annex 3(KN 20); Annex 5(KN 24); Annex 6(KN 41); Annex 7(KN 51); Annex 8-1(KN 301-489-01); Annex 8-2(KN 301-489-07); Annex 8-3(KN 301-489-17); Annex 8-4(KN 301-489-24)

(A2LA Certificate No. 2742.01) revised 08/02/2012

Peter Almy

Page 1 of 8



US / FCC - Emissions	SAE J1113-11, SAE J1113-12; SAE J1113-41; SAE J1113-4; SAE J1113-13; FCC Method 47 CFR Part 18, FCC Report and Order ET Docket 98-153 (FCC 02-48); FCC Method 47 CFR Parts 15, including Subpart G, using FCC Order 04-425 ANSI C63.4(2009); ANSI C63.10(2009); ANSI C63.4:2003 ANSI C63.4(2003) with FCC Method 47 CFR Part 11; ANSI C63.4(2003) with FCC Method 47 CFR Part 15, Subpart E; ANSI C63.4(2003) with FCC Method 47 CFR Part 15, Subpart C; ANSI C63.4(2003) and DA 02-2138; ANSI C63.4(2003) with FCC Method 47 CFR Part 15, Subpart B
Canada – Emissions	ICES-001; ICES-002; ICES-003 Issue 4; ICES-003 Issue 4 (2004); ICES-006 Issue 1
Vietnam – Emission & Immunity	TCN 68-193:2003; TCN 68-196:2001; TCVN 7189:2002; TCVN 7189:2009 (CISPR 22:2006)
Australia / New Zealand – Emissions and Immunity	AS/NZS 1044; AS/NZS 4251.1; AS/NZS 4251.2; AS/NZS CISPR 22; AS/NZS 3548; AS/NZS 2279.3; AS/NZS 61000-3-3; AS/NZS CISPR 11; AS/NZS CISPR 24; AS/NZS 61000.6.3; AS/NZS 61000.6.4; AS/NZS CISPR 14.1; AS/NZS 61000.3.2
Japan – Emissions	JEITA IT-3001; VCCI-V-3:2010.4 (up to 6 GHz)
China – Emissions	GB9254; GB17625.1
Taiwan – Emissions	CNS 13438 (up to 6 GHz); CNS 13783-1; CNS 13803; CNS 13439
Singapore – Emissions & Immunity	IDA TS EMC; CISPR 22; IEC 61000-4-2; IEC 61000-4-3; IEC 61000-4-4; IEC 61000-4-5; IEC 61000-4-6
FCC – Unlicensed Radio A1 to A4	A1: 47 CFR Parts 11 (Emergency Alert System (EAS)), 15 (Radio Frequency Devices) and 18 (Industrial, Scientific, and Medical Equipment); FCC OST/MP-5(1986); ANSI C63.4(2003); ANSI C63.4(2009); ANSI C63.10(2009) A2: 47 CFR Part 15 (Radio Frequency Devices); ANSI C63.4(2003); ANSI C63.4(2009); ANSI C63.10(2009) A3: 47 CFR Part 15 (Radio Frequency Devices); ANSI C63.17:2006; ANSI C63.10(2009); IEEE Std 1528:2003 + Ad1; Std IEEE 1528A:2005 A4: 47 CFR Part 15 (Radio Frequency Devices); ANSI C63.10(2009); IEEE Std 1528:2003 + Ad1; Std IEEE 1528A:2005
FCC – Licensed Radio B1 to B4	B1: 47 CFR Parts 2 (Frequency Allocations and Radio Treaty Matters; General Rules and Regulations), 22 (Public Mobile Services), 24 (Personal Communications Services), 25 (Satellite Communications), and 27 (Miscellaneous Wireless Communications Services); ANSI/TIA-603-C (2004), Land Mobile FM or DM Communications



<p>FCC – Licensed Radio (continued) B1 to B4</p>	<p>Equipment Measurement and Performance Standard; IEEE Std 1528:2003 + Ad1; Std IEEE 1528A:2005 B2: 47 CFR Parts 2 (Frequency Allocations and Radio Treaty Matters; General Rules and Regulations), 22 (Public Mobile Services), 74 (Experimental Radio Auxiliary, Special Broadcast and Other Program Distributional Services), 90 (Private Land Mobile Radio Services), 95 (Personal Radio Services), and 97 (Amateur Radio Services); ANSI/TIA- 603-C (2004), Land Mobile FM or PM Communications Equipment Measurement and Performance Standard B3: 47 CFR Parts 2 (Frequency Allocations and Radio Treaty Matters; General Rules and Regulations); 80 (Stations in the Maritime Services) , 87 (Aviation Services); ANSI/TIA-603-C (2004), Land Mobile FM or PM Communications Equipment Measurement and Performance Standard B4: 47 CFR Parts 2 (Frequency Allocations and Radio Treaty Matters; General Rules and Regulations); 27 (Broadband Radio Services (BRS) and Educational Broadband Services (EBS)), 74 (Experimental Radio Auxiliary, Special Broadcast and Other Program Distributional Services), and 101 (Fixed Microwave Services); ANSI/TIA-603-C (2004), Land Mobile FM or PM Communications Equipment Measurement and Performance Standard</p>
<p>Canada – Radio</p>	<p>RSS 102; RSS 111; RSS 112; RSS 117; RSS 118; RSS 119; RSS 123; RSS 125; RSS 127; RSS 128; RSS 129; RSS 131; RSS 132; RSS 133; RSS 134; RSS 135; RSS 136; RSS 137; RSS 138; RSS 139; RSS 141; RSS 142; RSS 170; RSS 181; RSS 182; RSS 191; RSS 192; RSS 193; RSS 194; RSS 195; RSS 196; RSS 197; RSS 198; RSS 199; RSS 210; RSS 220; RSS 213; RSS 215; RSS 243; RSS 287; RSS 288;RSS 310; RSS Gen</p>
<p>CE – Radio</p>	<p>EN 301 502; EN 301 511; EN 301 526; EN 301 681; EN 301 721; EN 301 751; EN 301 753; EN 301 783-2; EN 301 796; EN 301 797; EN 301 840-2; EN 301 843-1; EN 301 843-4; EN 301 843-5; EN 301 893; EN 301 908-01; EN 301 908-02; EN 301 908-03; EN 301 908-04; EN 301 908-05; EN 301 908-06; EN 301 908-07; EN 301 908-08; EN 301 908-09; EN 301 908-10; EN 301 908-11; EN 301 929-2; EN 301 997-2; EN 302 018-2; EN 302 054-2; EN 302 064-2; EN 302 066-2; EN 302 077-2; EN 302 186; EN 302 195-2; EN 302 217-3; EN 302 245-2; EN 302 288-2; EN 302 291-2; EN 302 296; EN 302 297; EN 302 326-2; EN 302 326-3; EN 302 340; EN 302 372-2; EN 302 426; EN 302 454-2; EN 302 480; EN 302 502; EN 302 510-2;</p>
	<p>EN 302 217-4-2; EN 300 224-1; EN 300 279; EN 300 339; EN 300 385; EN 301 839-2; EN 301 843-6; EN 302 017-2; EN 302 208-2; EN 302 217-2-2; ETS 300 329; ETS 300 445; ETS 300 446; ETS 300 683; ETS 300 826; ETS EN 300 328; ETSI EN 300 086-2; EN 302217-1; EN 302217-2-1; EN 302217-4-1; EN 302288-1; EN 302908-12; EN 302326-1; EN 301929-1; EN 301997-1; EN 300224-2; EN 301839-1; EN 301843-1; EN 301843-2; EN 301843-3; EN 301843-4; EN 301843-5; EN 302017-1; EN 302208-1; EN 300086-1; EN 300113-1; EN 300224-1; EN 300341-1; EN 302291-1; EN 302500-1; EN 302500-2; ETSI EN 300 113-2; ETSI EN 300 197; ETSI EN 300 198;</p>



CE – Radio (continued)	ETSI EN 300 219-1; ETSI EN 300 219-2; ETSI EN 300 220-1; ETSI EN 300 220-2; ETSI EN 300 220-3; ETSI EN 300 224-2; ETSI EN 300 296-1; ETSI EN 300 296-2; ETSI EN 300 328-1; ETSI EN 300 328-2; ETSI EN 300 330; ETSI EN 300 330-1; ETSI EN 300 330-2; ETSI EN 300 341-2; ETSI EN 300 373-1; ETSI EN 300 373-2; ETSI EN 300 373-3; ETSI EN 300 390-1; ETSI EN 300 390-2; ETSI EN 300 422-1; ETSI EN 300 422-2; ETSI EN 300 431; ETSI EN 300 440-1; ETSI EN 300 440-2; ETSI EN 300 454-1; ETSI EN 300 454-2; ETSI EN 300 718-2; ETSI EN 301 021; ETSI EN 301 166-1; ETSI EN 301 166-2; ETSI EN 301 178-2; ETSI EN 301 213-1; ETSI EN 301 213-2; ETSI EN 301 213-3; ETSI EN 301 213-4; ETSI EN 301 213-5; ETSI EN 301 357-1; ETSI EN 301 357-2; ETSI EN 301 390; ETSI EN 301 459; ETSI EN 301 489-01(excluding section 9.6); ETSI EN 301 489-02; ETSI EN 301 489-03; ETSI EN 301 489-04; ETSI EN 301 489-05; ETSI EN 301 489-06; ETSI EN 301 489-07; ETSI EN 301 489-08; ETSI EN 301 489-09; ETSI EN 301 489-10; ETSI EN 301 489-11; ETSI EN 301 489-12; ETSI EN 301 489-13; ETSI EN 301 489-14; ETSI EN 301 489-15; ETSI EN 301 489-16; ETSI EN 301 489-17; ETSI EN 301 489-18; ETSI EN 301 489-19; ETSI EN 301 489-20; ETSI EN 301 489-22; ETSI EN 301 489-23; ETSI EN 301 489-24; ETSI EN 301 489-25; ETSI EN 301 489-26; ETSI EN 301 489-27; ETSI EN 301 489-28; ETSI EN 301 489-31; ETSI EN 301 489-32; IEC 60945
IDA – Radio	IDA TS AR; IDA TS CT-CTS; IDA TS GMPCS; IDA TS LMR; IDA TS RPG; IDA TS SRD; IDA TS UWB; IDA TS WBA; IDA TS CMT; IDA TA CBS
Vietnam – Radio	QCVN 54:2011/BTTTT; TCN 68-242:2006; QCVN 11:2010/BTTTT; TCN 68-243:2006; QCVN 17:2010/BTTTT; TCN 68-246:2006
Korea – Radio	Annex 8-1(KN 301-489-01); Annex 8-2(KN 301-489-07); Annex 8-3(KN 301-489-17); Annex 8-4(KN 301-489-24); KCC Public Notification 2011-31; RRA Announce 2011-10; RRA Public Notification 2010-46
Taiwan – Radio	LP0002; PLMN07; PLMN01; PLMN08
Australia - New Zealand – Radio	AS 2772.2; AS/NZS 4281; AS/NZS 4268; AS/NZS 4280.1; AS/NZS 4583; AS/NZS 4280.2; AS/NZS 4281; AS/NZS 4295; AS/NZS 4582; AS/NZS 4769.1; AS/NZS 4769.2; AS/NZS 4770; AS/NZS 4771
Hong Kong – Radio	HKCA 1002; HKCA 1007; HKCA 1008; HKCA 1010; HKCA 1015; HKCA 1016; HKCA 1020; HKCA 1022; HKCA 1026; HKCA 1027; HKCA 1033; HKCA 1034; HKCA 1035; HKCA 1036; HKCA 1037; HKCA 1039; HKCA 1041; HKCA 1042; HKCA 1043; HKCA 1044; HKCA 1046; HKCA 1047; HKCA 1048; HKCA 1049; HKCA1052; HKCA1053; HKCA 1054



FCC Telephone Terminal Equipment Scope C1 FCC Telephone Terminal Equipment Scope C1 (continued)	ANSI/TIA-968-A:03; ANSI/TIA-968-A-1:03; ANSI/TIA-968-A-2:04; ANSI/TIA-968-A-3:05; ANSI/TIA-968-A-4:07; ANSI/TIA-968-A-5:07; TIA-968-B; FCC Rule Part 68; 47 CFR Part 68.316; 47 CFR Part 68.317; ANSI/TIA/EIA-464-C; TIA-810-B; T1.TRQ6 (2002); TCB-31-B (1998); TIA-470.110-C; TIA-810-B; TIA-920
Canada – Telecom	CS-03 Part V Issue 9:2009 Amendment 1; CS-03 Part VIII Issue 9:2009 Amendment 4; CS-03 Part I Issue 9:2006 Amendment 3; CS-03 Part II Issue 9:2004; CS-03 Part III Issue 9:2004; CS-03 Part V Issue 9:2004 ; CS-03 Part VI Issue 9:2004; CS-03 Part VII Issue 9:2006 Amendment 3; CS-03 Part VIII Issue 9:2007 Amendment 3; CS-03 Issue 9:04 + A2(06) + A3(06)
Europe – Telecom	TBR 2; 01-1997; TBR 004 Ed.1.95 + A1 (97); TBR 1; TBR 3; TBR 12:A1 01-1996; TBR 013 ed.1; TBR 024 ed.1; TBR 25; TBR 38 ed.1; ETSI ES 203 021-05 ; ETSI ES 203 021-2 ; ETSI ES 021-3; TBR 021; ETSI EG 201 121; ETSI EN 301 437; ETSI TS 101 270-1; ITU-T Recommendation Q.920; ITU-T Recommendation Q.920 – Amendment 1; ITU-T Recommendation Q.921; ITU-T Recommendation Q.921 – Amendment 1; ITU-T Recommendation Q.931; ITU-T Recommendation Q.931 – Amendment 1; Erratum 1 (02/2003) ITU-T Recommendation Q.931 (05/1998); ISDN User Network Interface Layer 3 Specification for Basic Call Control; ITU-T Recommendation P.300
Australia –Telecom	AS/CA S003.1:2010; AS/CA S003.2:2010; AS/CA S003.3:2010; AS/CA S004:2010; AS/ACIF S006:2008; AS/ACIF S041.1:2009 AS/ACIF S041.2:2009; AS/ACIF S041.3:2009; AS/ACIF S042.1:2008; AS/ACIF S043.2:2008; AS/ACIF S043.3:2008; AS/ACIF S002:05; AS/ACIF S003:06; AS/ACIF S004:06; AS/ACIF S006:01; AS/ACIF S016:01; AS/ACIF S031:01; AS/ACIF S038:01; AS/ACIF S040:01; AS/ACIF S041:05; AS/ACIF S043.2:06; AS ACIF S042.1
New Zealand – Telecom	PTC200:2006; PTC200 Issue No.2:97 + A1(980); PTC220; PTC273:2007; TNA 115; TNA 117
Singapore – Telecom	IDA TS ADSL; IDA TS DLCN; IDA TS ISDN BA; IDA TS ISDN PRA; IDA TS ISDN 3; IDA TS-PSTN; IDA TS ACLIP
Hong Kong – Telecom	HKCA 2011; HKCA 2012; HKCA 2013; HKCA 2014; HKCA 2015; HKCA 2017; HKCA 2018; HKCA 2019; HKCA 2022; HKCA 2023; HKCA 2024; HKCA 2026; HKCA 2027; HKCA 2028; HKCA 2029; HKCA 2030; HKCA 2031; HKCA 2032; HKCA 2033



Vietnam – Telecom	QCVN 10:2010/BTTTT; TCN 68-143:2003; QCVN 19:2010/BTTTT; TCN 68-188:2000; TCN 68-189:2000; QCVN 18:2010/BTTTT; TCN 68-192:2003; TCN 68-193:2003; TCN 7317:2003 (CISPR 24: 1997); TCN 68-196:2001; QCVN 12:2010/BTTTT; TCN 68-221:2004; QCVN 13:2010/BTTTT; TCN 68-222:2004; QCVN 55:2011/BTTTT; TCN 68-223:2004; QCVN 15:2010/BTTTT; TCN 68-245:2004
Korea – Telecom	Presidential Decree 21098; RRA Public Notification 2010-36; RRA Public Notification 2009-38; RRA Announce 2011-2; Annex 1(RRA Announce 2011-2); Annex 3(RRA Announce 2011-2); Annex 5(RRA Announce 2011-2); Annex 6(RRA Announce 2011-2)
China – Telecom	YD/T 514-1:98; YD/T 1277.1-2003; GB/T 17904.1-1999; GB/T 17904.2-1999; GB/T 17154.1-1997; GB/T 17154.2-1997; YD/T1091-2000; YD/T1006-1999; GB/T 17789-1999
Taiwan – Telecom	PSTN01:03; ADSL01:08; ID0002; IS6100: 93
Japan – Telecom	JATE Blue Book, Green Book; Ministerial Ordinance of the Ministry of Posts and Telecommunications No. 31 of April 1, 1985 (last amended on March 22 2004); Ordinance Concerning Technical Conditions Compliance Approval etc. of Terminal Equipment
South Africa – Telecom	DPT-TE-001; TE-002; TE-003; TE-004; TE-005; TE-006; TE-007; TE-008; TE-009; TE-010; TE-012 (telephone interface); TE-013 (telephone interface); TE-014; TE-015; TE-018; SWS-001; SWS-002; SWS-003; SWS-004; SWS-005; SWS-006; SWS-007; SWS-008; SWS-009; SWS-010
Israel – Telecom	Israel MoC Spe. 23/96
Mexico – Telecom	NOM-151-SCT1-1999; NOM-152-SCT1-1999
Argentina – Telecom	CNC-ST2-44-01
Brazil – Telecom	Resolution 392-2005
International Telecom Union	ITU-T-G.703:01; ITU-T-G.823:93; ITU-T G.824; ITU-T G.825; ITU-T-G.991.2; ITU-T-G.992.1; ITU-T-G.992.3; ITU-T-G.992.5; ITU-T-G.993.1
Product Safety	IEC 60950-1; EN 60950-1; UL 60950-1; IEC 60601-1-1; CAN/CSA 22.2 NO. 60950-1-03; SS-EN 60950-1; AS/NZ 60950-1, (voltage surge testing up to 6kV, excluding Annex A and H); CNS 14336, CNS 14408; GB4943; President Notice 20664; RRA Public Notification 2011-14; RRA Announce 2011-3; Annex 1(RRA Announce 2011-3); QCVN 22:2010/BTTTT; TCN 68-190:2003; SABS IEC 60950; IEC/EN 61558; IEC/EN 61558-2-7; EN 62115; IEC 60215; EN 60958; EN 60598; IEC 215 (1987) + A1 (1992) + A2 (1994)



Japan - Radio	ARIB STD-T81; ARIB STD-T66; RCR STD-1; RCR STD-29; ARIB STD-T94 Fascicle 1; ARIB STD-T90; ARIB STD-T89; RCR STD-33
SAR & HAC	IEEE P1528:2003 + Ad1; IEEE 1528A:2005; FCC OET Bulletin 65 Supplement C; FCC OET Bulletin 65; ANSI C95; ANSI C63.19; FCC 47 CFR 20.19; H46-2/99-273E; EN 50360; EN 50361; IEC62209-1; IEC 62209-2; EN 50371; EN 50383; EN 50357; EN 50364; KCC Public Notification 2009-27; RRA Public Notification 2010-45; KCC Public Notification 2011-10; CNS 14958-1; CNS 14959; NZS 2772.1; NZS 6609.2; Resolution N 533
Japan – Notification No. 88 of MIC 2004	
Table No 13	CB Radio
Table No 21	Cordless Telephone
Table Nos 22-1 thru 22-17	Low Power Radio Equipment
Table No 36	Low Power Security System
Table No 43	Low Power Data Communication in the 2.4 GHz Band
Table No 44	Low Power Data Communication in the 2.4 GHz Band
Table No 45	Low Power Data Communication in the 5.2, 5.3, 5.6 GHz Bands
Table No 46	Low Power Data Communication in the 25 and 27 GHz Bands
Table No 47	Base Station for 5 GHz Band Wireless Access System
Table No 47	Base Station for 5 GHz Band Wireless Access System (low spurious type)
Table No 47	Land Mobile Relay for 5 GHz Band Wireless Access System (limited for use in special zones)
Table No 47	Land Mobile Relay for 5 GHz Band Wireless Access System (limited for use in special zones, low spurious type)
Table No 47	Land Mobile Relay for 5 GHz Band Wireless Access System
Table No 47	Land Mobile Relay for 5 GHz Band Wireless Access System (low spurious type)
Table No 47	Land Mobile Relay for 5 GHz Band Wireless Access System (low power type)
Table No 50	Digital Cordless Telephone
Table No 50	PHS Base Station
Table No 50	PHS Land Mobile Station
Table No 50	PHS Relay Station
Table No 50	PHS Test Station
Table No 64	Mobile Station for Dedicated Short Range Communication Systems



Japan – Notification No. 88 of MIC 2004 (cont.)	
Table No 64	Base Station for Dedicated Short Range Communication Systems
Table No 64	Test Station for Dedicated Short Range Communication Systems
Table No 70	UWB (Ultra Wide Band) Radio System

*Limitations for listed standards are indicated by italics and Scope excludes protocol sections of applicable standards.



SIEMIC, INC.

Accessing global markets

Title: RF Test Report of Non-Keypad iCLASS Rev E Reader
Model : R30E
To FCC 15.225 2011

Serial# SL12061801-HID-018_iClass RevE_RF_R30E(FCC)
Issue Date Aug 23rd, 2012
Page 45 of 63
www.siemic.com



The American Association for Laboratory Accreditation

"World Class Accreditation"

Accredited Product Certification Body

A2LA has accredited

SIEMIC, INC.

Milpitas, CA

for technical competence as a

Product Certification Body

This product certification body is accredited in accordance with the recognized International Standard ISO/IEC Guide 65:1996 *General requirements for bodies operating product certification systems*. This accreditation demonstrates technical competence for a defined scope and the operation of a quality management system.

Presented this 23rd day of November 2010.



President & CEO
For the Accreditation Council
Certificate Number 2742.02
Valid to September 30, 2012
Revised August 2, 2012

For the product certification schemes to which this accreditation applies, please refer to the organization's Product Certification Scope of Accreditation



American Association for Laboratory Accreditation

SCOPE OF ACCREDITATION TO ISO/IEC GUIDE 65:1996

SIEMIC, INC.
775 Montague Expressway
Milpitas, CA 95035
Mr. Snell Leong (Authorized Representative) Phone: 408 526 1188
www.siemic.com

PRODUCT CERTIFICATION CONFORMITY ASSESSMENT BODY (CAB)

Valid to: September 30, 2012

Certificate Number: 2742.02

In recognition of the successful completion of the A2LA Certification Body Accreditation Program evaluation, including the US Federal Communications Commission (FCC), Industry Canada (IC), Singapore (IDA), Hong Kong (OFCA) and Japan (MIC) requirements for the indicated types of product certifications, accreditation is granted to this organization to perform the following product certification schemes:

Economy Scope

Federal Communication Commission - (FCC)

Unlicensed Radio Frequency Devices	A1, A2, A3, A4
Licensed Radio Frequency Devices	B1, B2, B3, B4
Telephone Terminal Equipment	C

**Please refer to FCC TCB Program Roles and Responsibilities, released July 22, 2010 detailing scopes, roles and responsibilities. <http://fialfoss.fcc.gov/oetcf/kdb/forms/FTSSearchResultPage.cfm?id=44683&switch=P>*

Industry Canada - (IC)

Radio	Scope 1-Licence-Exempt Radio Frequency Devices; Scope 2-Licensed Personal Mobile Radio Services; Scope 3-Licensed General Mobile & Fixed Radio Services; Scope 4-Licensed Maritime & Aviation Radio Services; Scope 5-Licensed Fixed Microwave Radio Services;
-------	--

**Please refer to Industry Canada (IC) website at: <http://www.ic.gc.ca/eic/site/smt-gst.nsf/eng/sf09888.html>*

IDA – Singapore

Line Terminal Equipment	All Technical Specifications for Line Terminal Equipment – Table 1 of IDA MRA Recognition Scheme: 2011, Annex 2
Radio-Communication Equipment	All Technical Specifications for Radio-Communication Equipment – Table 2 of IDA MRA Recognition Scheme: 2011, Annex 2

**Please refer to Info-Communication Development Authority (IDA) Singapore website at: http://www.ida.gov.sg/doc/Policies%20and%20Regulation/Policies_and_Regulation_Level2/20060609145118/MRARecScheme.pdf*

(A2LA Cert. No. 2742.02) Revised 07/17/2012

Page 1 of 2



OFCA – Hong Kong

Radio Equipment HKCA 1001, 1002, 1003, 1004, 1005, 1006, 1007, 1008, 1009, 1010, 1015, 1016, 1019, 1020, 1022, 1026, 1027, 1033, 1034, 1035, 1036, 1037, 1038, 1039, 1041, 1042, 1043, 1044, 1045, 1046, 1047, 1048, 1049, 1050, 1052, 1053, 1054

**Please refer to the Office of the Communications Authority's website at:
[Radio Equipment Specifications \(HKCA 10XX\)](#)*

Fixed Network Equipment HKCA 2001, 2005, 2011, 2012, 2013, 2014, 2015, 2016, 2017, 2018, 2019, 2020, 2021, 2022, 2023, 2024, 2026, 2027, 2028, 2029, 2030, 2031, 2032, 2033, 2034, 2035, 2036, 2037, 2040, 2041, 2102, 2103, 2104, 2108, 2201, 2202, 2203, 2204

**Please refer to the Office of the Communications Authority's website at:
[Fixed Network Equipment Specifications \(HKCA 2XXX\)](#)*

MIC – Japan

Telecommunications Business Law (Terminal Equipment) Scope A1 - Terminal Equipment for the Purpose of Calls

Radio Law (Radio Equipment) Scope B1 - Specified Radio Equipment specified in, Article 38-2-2, paragraph 1, item 1 of the Radio Law



SIEMIC ACCREDITATION DETAILS: FCC Test Site Registration No. 881796

FEDERAL COMMUNICATIONS COMMISSION

**Laboratory Division
7435 Oakland Mills Road
Columbia, MD 21046**

August 03, 2012

Registration Number: 881796

SIEMIC Labs
775 Montague Expressway,
Milpitas, CA 95035

Attention: Leslie BAI

Re: Measurement facility located at 775 Montague Expressway, Milpitas, CA 95035
Anechoic chamber (10 meters)
Date of Listing: August 03, 2012

Dear Sir or Madam:

Your request for registration of the subject measurement facility has been reviewed and found to be in compliance with the requirements of Section 2.948 of the FCC rules. The information has, therefore, been placed on file and the name of your organization added to the list of facilities whose measurement data will be accepted in conjunction with applications for Certification under Parts 15 or 18 of the Commission's Rules. Please note that the file must be updated for any changes made to the facility and the registration must be renewed at least every three years.

Measurement facilities that have indicated that they are available to the public to perform measurement services on a fee basis may be found on the FCC website www.fcc.gov under E-Filing, OET Equipment Authorization Electronic Filing, Test Firms.

Sincerely,

Katie Hawkins
Electronics Engineer



SIEMIC, INC.
Accessing global markets

Title: RF Test Report of Non-Keypad iCLASS Rev E Reader
Model : R30E
To FCC 15.225 2011

Serial# SL12061801-HID-018_iClass RevE_RF_R30E(FCC)
Issue Date Aug 23rd, 2012
Page 49 of 63
www.siemic.com

SIEMIC ACCREDITATION DETAILS: Industry of Canada CAB ID : US0160



UNITED STATES DEPARTMENT OF COMMERCE
National Institute of Standards and Technology
Gaithersburg, Maryland 20899

March 4, 2009

Mr. Leslie Bai
SIEMIC, Inc.
2206 Ringwood Avenue
San Jose, CA 95131

Dear Mr. Bai:

NIST is pleased to inform you that your laboratory has been recognized by Industry Canada (IC), under the Asia Pacific Economic Cooperation for Telecommunications Equipment Mutual Recognition Arrangement (APEC Tel MRA). Your laboratory is now designated to act as a Conformity Assessment Body (CAB) under Appendix B, **Phase I** Procedures, of the APEC Tel MRA. The pertinent information about your laboratory's designation is as follows:

CAB Name: SIEMIC, Inc.
Physical Location: 2206 Ringwood Avenue, San Jose, CA 95131 USA
Identification No.: US0160
Recognized Scope: CS-03 Part I, II, V, VI, VII and VIII

You may submit test data to IC to verify that the equipment to be imported into Canada satisfies the applicable requirements. The designation of your organization will remain in force as long as its accreditation for the designated scope remains valid and comply with the designation requirements.

Recognized CABs are listed on the NIST website at <http://ts.nist.gov/mra>. Please contact Ms. Ramona Saar at (301) 975-5521 or ramona.saar@nist.gov if you have any questions.

Sincerely,

David F. Alderman
Group Leader, Standards Coordination and Conformity Group
Standards Services Division

Enclosure

cc: CAB Program Manager

NIST



SIEMIC, INC.
Accessing global markets

Title: RF Test Report of Non-Keypad iCLASS Rev E Reader
Model : R30E
To FCC 15.225 2011

Serial# SL12061801-HID-018_iClass RevE_RF_R30E(FCC)
Issue Date Aug 23rd, 2012
Page 50 of 63
www.sieminc.com

SIEMIC ACCREDITATION DETAILS: Industry of Canada Test Site Registration No. 4842-1

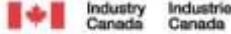

July 03, 2012

OUR FILE: 46405-4842
Submission No: 157820

Siemic Inc.
775 Montague Expressway
Milpitas, CA, 95035
United States

Attention:

Dear Sir/Madame: Snell Leong

The Bureau has received your application for the renewal of 3/10m alternative test site. Be advised that the information received was satisfactory to Industry Canada. The following number(s) is now associated to the site(s) for which registration / renewal was sought (**Site# 4842D-2**). Please reference the appropriate site number in the body of test reports containing measurements performed on the site. In addition, please keep for your records the following information:

- The company address code associated to the site(s) located at the above address is: **4842D**

Furthermore, to obtain or renew a unique site number, the applicant shall demonstrate that the site has been accredited to ANSI C63.4-2003 or later. A scope of accreditation indicating the accreditation by a recognized accreditation body to ANSI C63.4-2003 or later shall be accepted. Please indicate in a letter the previous assigned site number if applicable and the type of site (example: 3 metre OATS or 3 metre chamber). If the test facility is not accredited to ANSI C63.4-2003 or later, the test facility shall submit test data demonstrating full compliance with the ANSI standard. The Bureau will evaluate the filing to determine if recognition shall be granted.

The frequency for re-validation of the test site and the information that is required to be filed or retained by the testing party shall comply with the requirements established by the accrediting organization. However, in all cases, test site re-validation shall occur on an interval not to **exceed three years**. There is no fee or form associated with an OATS filing. OATS submissions are encouraged to be submitted electronically to the Bureau using the following URL;

http://strategies.ic.gc.ca/epic/internet/inceb-bhst.nsf/en/h_tt00052e.html.

If you have any questions, you may contact the Bureau by e-mail at certification.bureau@ic.gc.ca Please reference our file and submission number above for all correspondence.

Yours sincerely,

Dalwinder Gill
For: Wireless Laboratory Manager
Certification and Engineering Bureau
3701 Carling Ave., Building 04
P.O. Box 11490, Station "H"
Ottawa, Ontario K2H 6S2
Email: dalwinder.gill@ic.gc.ca
Tel. No. (613) 998-8363
Fax. No. (613) 990-4752



SIEMIC ACCREDITATION DETAILS: FCC DOC CAB Recognition : US1109

FEDERAL COMMUNICATIONS COMMISSION

**Laboratory Division
7435 Oakland Mills Road
Columbia, MD 21046**

August 28, 2008

Siemic Laboratories
2206 Ringwood Ave.,
San Jose, CA 95131

Attention: Leslie Bai

Re: Accreditation of Siemic Laboratories
Designation Number: US1109
Test Firm Registration #: 540430

Dear Sir or Madam:

We have been notified by American Association for Laboratory Accreditation that Siemic Laboratories has been accredited as a Conformity Assessment Body (CAB).

At this time Siemic Laboratories is hereby designated to perform compliance testing on equipment subject to Declaration Of Conformity (DOC) and Certification under Parts 15 and 18 of the Commission's Rules.

This designation will expire upon expiration of the accreditation or notification of withdrawal of designation.

Sincerely,

George Tannahill
Electronics Engineer

SIEMIC ACCREDITATION DETAILS: Australia CAB ID : US0160



UNITED STATES DEPARTMENT OF COMMERCE
National Institute of Standards and Technology
Gaithersburg, Maryland 20899

November 20, 2008

Mr. Leslie Bai
SIEMIC, Inc.
2206 Ringwood Avenue
San Jose, CA 95131

Dear Mr. Bai:

NIST is pleased to inform you that your laboratory has been recognized by the Australian Communications and Media Authority (ACMA) under the Asia Pacific Economic Cooperation for Telecommunications Equipment Mutual Recognition Arrangement (APEC Tel MRA). Your laboratory is now designated to act as a Conformity Assessment Body (CAB) under Appendix B, **Phase I** Procedures, of the APEC Tel MRA. The pertinent information about your laboratory's designation is as follows:

CAB Name: Siemic, Inc.
Physical Location: 2206 Ringwood Avenue, San Jose, CA 95131
Identification No.: US0160
Recognized Scope: EMC: AS/NZS 4251.1 (until 5/31/2009), AS/NZS 4251.2 (until 5/31/2009), AS/NZS CISPR 11, AS/NZS CISPR 14.1, AS/NZS CISPR 22, AS/NZS 61000.6.3, AS/NZS 61000.6.4
Radiocommunications: AS/NZS 4281, AS/NZS 4268, AS/NZS 4280.1, AS/NZS 4280.2, AS/NZS 4295, AS/NZS 4582, AS/NZS 4583, AS/NZS 4769.1, AS/NZS 4769.2, AS/NZS 4770, AS/NZS 4771
Telecommunications: AS/ACIF S002:05, AS/ACIF S003:06, AS/ACIF S004:06, AS/ACIF S006:01, AS/ACIF S016:01, AS/ACIF S031:01, AS/ACIF S038:01, AS/ACIF S040:01, AS/ACIF S041:05, AS/ACIF S043.2:06, AS/NZS 60950.1

You may submit test data to ACMA to verify that the equipment to be imported into Australia satisfies the applicable requirements. The designation of your organization will remain in force as long as its accreditation for the designated scope remains valid and comply with the designation requirements. Recognized CABs are listed on the NIST website at <http://ts.nist.gov/mra>. Please contact Ms. Ramona Saar, at (301) 975-5521 or ramona.saar@nist.gov if you have questions.

Sincerely,

David F. Alderman
Group Leader, Standards Coordination and Conformity Group
Standards Services Division

Enclosure

cc: Snell Leong, Siemic, Inc.; Ramona Saar, NIST





SIEMIC, Inc.
Accessing global markets

Title: RF Test Report of Non-Keypad iCLASS Rev E Reader
Model : R30E
To: FCC 15.225 2011

Serial# SL12061801-HID-018_iClass RevE_RF_R30E(FCC)
Issue Date Aug 23rd, 2012
Page 53 of 63
www.sieminc.com

SIEMIC ACCREDITATION DETAILS: Korea CAB ID: US0160



UNITED STATES DEPARTMENT OF COMMERCE
National Institute of Standards and Technology
Gaithersburg, Maryland 20899

December 6, 2011

Mr. Leslie Bai
SIEMIC, Inc.
2206 Ringwood Avenue
San Jose, CA 95131

Dear Mr. Bai:

NIST is pleased to inform you that your laboratory's recognition by the Radio Research Agency (RRA) Korea Communications Commission (KCC) under the Asia Pacific Economic Cooperation for Telecommunications Equipment Mutual Recognition Arrangement (APEC Tel MRA) has been updated. The pertinent information about your laboratory's designation is as follows:

CAB Name: SIEMIC, Inc.
Physical Location: 2206 Ringwood Avenue, San Jose, CA 95131
Identification No.: US0160
Current Scope: **EMI:** KCC Notice 2008-39; RRA Public Notification 2011-5; KN22
EMS: KCC Notice 2008-38; RRA Public Notification 2011-6, KN24
Updated Scope: **EMI:** RRA Public Notification 2011-18; RRA Announce 2010-5; KN 11; KN 13; KN 14-1; KN 22; KN 41; KN50; KN15; KN19; KN60; KN16-1-1; KN16-1-2; KN16-1-3; KN16-1-4; KN16-1-5; KN16-2-1; KN16-2-2; KN 16-2-3; KN 16-2-4;
EMS: RRA Public Notification 2011-17; RRA Announce 2010-6; KN24; KN 61000-4-2, -4-3, -4-4, -4-5, -4-6, -4-8, -4-11; KN60101-1-2, KN20; KN41, KN51;
RF: KCC Public Notification 2011-31; KCC Public Notification 2011-10; RRA Public Notification 2010-46; KN301-489-1; KN301-489-07; KN301-489-17; KN 301-489-24
SAR: KCC Public Notification 2009-27; RRA Public Notification 2010-45; KCC Public Notification 2011-10
TELECOM: RRA Public Notification 2010-36; RRA Public Notification 2009-38

You may submit test data to RRA/KCC to verify that the equipment to be imported into Korea satisfies the applicable requirements. The designation of your organization will remain in force as long as the accreditation for the designated scope remains valid and complies with the designation requirements.

Recognized CABs are listed on the NIST website at <http://ts.nist.gov/mra>. If you have any questions please, contact me at (301) 975-5521 or via email at ramona.saar@nist.gov.

Sincerely,

Ramona Saar
Standards Services Group

Enclosure

NIST



SIEMIC ACCREDITATION DETAILS: Taiwan BSMI Accreditation No. SL2-IN-E-1130R



UNITED STATES DEPARTMENT OF COMMERCE
National Institute of Standards and Technology
Gaithersburg, Maryland 20899

May 3, 2006

Mr. Leslie Bai
SIEMIC Laboratories
2206 Ringwood Avenue
San Jose, CA 95131

Dear Mr. Bai:

I am pleased to inform you that your laboratory has been recognized by the Chinese Taipei's Bureau of Standards, Metrology, and Inspection (BSMI) under the Asia Pacific Economic Cooperation (APEC) Mutual Recognition Arrangement (MRA). Your laboratory is now designated to act as a Conformity Assessment Body (CAB) under Appendix B, **Phase I** Procedures, of the APEC Tel MRA. You may submit test data to BSMI to verify that the equipment to be imported into Chinese Taipei satisfies the applicable requirements. The designation of your organization will remain in force as long as its accreditation for the designated scope remains valid and comply with the designation requirements. The pertinent designation information is as follows:

- BSMI number: **SL2-IN-E-1130R** (Must be applied to the test reports)
- U.S. Identification No: **US0160**
- Scope of Designation: **CNS 13438**
- Authorized signatory: **Mr. Leslie Bai**

The names of all recognized CABs will be posted on the NIST website at <http://ts.nist.gov/mra>. If you have any questions, please contact Mr. Dhillon at 301-975-5521. We appreciate your continued interest in our international conformity assessment activities.

Sincerely,

David F. Alderman
Group Leader, Standards Coordination and Conformity Group

cc: Joginder Dhillon

NIST

SIEMIC ACCREDITATION DETAILS: Taiwan NCC CAB ID: US0160



UNITED STATES DEPARTMENT OF COMMERCE
National Institute of Standards and Technology
Gaithersburg, Maryland 20899

April 25, 2011

Mr. Leslie Bai
SIEMIC, Inc.
2206 Ringwood Avenue
San Jose, CA 95131

Dear Mr. Bai:

NIST is pleased to inform you that your laboratory has been recognized by the National Communications Commission (NCC) under the Asia Pacific Economic Cooperation for Telecommunications Equipment Mutual Recognition Arrangement (APEC Tel MRA). Your laboratory is now designated to act as a Conformity Assessment Body (CAB) under Appendix B, **Phase I** Procedures, of the APEC Tel MRA. The pertinent information about the laboratory's designation is as follows:

CAB Name: SIEMIC, Inc.
Physical Location: 2206 Ringwood Avenue, San Jose, CA 95131
Identification No.: US0160
Previous Scope: LP0002, PSTN01, ADSL01, ID0002, IS6100, CNS 14336, PLMN07
Current Scope: LP0002, PSTN01, ADSL01, ID0002, IS6100, CNS 14336, PLMN07, PLMN01 and PLMN08

You may submit test data to NCC to verify that the equipment to be imported into Chinese Taipei satisfies the applicable requirements. The designation of your organization will remain in force as long as its accreditation for the designated scope remains valid and comply with the designation requirements.

Recognized CABs are listed on the NIST website at <http://ts.nist.gov/mra>. If you have any questions please contact Ramona Saar at (301) 975-5521 or ramona.saar@nist.gov.

Sincerely,

David F. Alderman
Standards Services Group

Enclosure

cc: Ramona Saar

NIST



SIEMIC, Inc.
Accessing global markets

Title: RF Test Report of Non-Keypad iCLASS Rev E Reader
Model : R30E
To FCC 15.225 2011

Serial# SL12061801-HID-018_iClass RevE_RF_R30E(FCC)
Issue Date Aug 23rd, 2012
Page 56 of 63
www.sieminc.com

SIEMIC ACCREDITATION DETAILS: Vietnam CAB ID: US0160



UNITED STATES DEPARTMENT OF COMMERCE
National Institute of Standards and Technology
Gaithersburg, Maryland 20899

July 11, 2012

Mr. Leslie Bai
SIEMIC, Inc.
2206 Ringwood Avenue
San Jose, CA 95131

Dear Mr. Bai:

NIST is pleased to inform you that your laboratory continues to be recognized by Vietnam's Ministry of Information and Communication (MIC) under the Asia Pacific Economic Cooperation for Telecommunications Equipment Mutual Recognition Arrangement (APEC Tel MRA). MIC has updated your scope of recognition. The pertinent information about the continued recognition is as follows:

CAB Name: SIEMIC, Inc.
Physical Location: 2206 Ringwood Avenue, San Jose, CA 95131
Identification No.: US0160
Current Scope: TCN68-188, TCN68-190, TCN68-193, TCN68-196, TCN68-143, TCN68-192, TCN68-189, TCN68-221, TCN68-222, TCN68-223, TCN68-245, TCN68-242, TCN68-243, TCN68-246, TCVN 7189
Updated Scope: QCVN 19:2010/BTTTT, QCVN 22:2010/BTTTT, TCVN 7189:2009, TCVN 7317:2003, QCVN 10:2010/BTTTT, QCVN 12:2010/BTTTT, QCVN 3:2010/BTTTT, QCVN 15:2010/BTTTT, QCVN 11:2010/BTTTT, QCVN 54:2011/BTTTT, QCVN 55:2011/BTTTT, QCVN 18:2010/BTTTT, QCVN 17:2010/BTTTT

You may submit test data to MIC to verify that the equipment to be imported into Vietnam satisfies the applicable requirements. *Please note that your recognition from Vietnam will expire on **September 30, 2012**. To continue the recognition beyond this date, it will be necessary to submit to NIST the updated ISO/IEC 17025 Scope and Certification of Accreditation as soon as it is reissued during your next accreditation renewal period. NIST will then submit the updated information to MIC so that the recognition can be extended.*

Recognized CABs are listed on the NIST website at <http://gsi.nist.gov/global/index.cfm/L1-4/L2-16/L3-90/A-380>. If you have any questions please contact Ramona Saar via email at ramona.saar@nist.gov or phone at (301) 975-5521.

Sincerely,

David F. Alderman
Standards Services Group

Enclosure

cc: Ramona Saar

NIST



SIEMIC ACCREDITATION DETAILS: Mexico NOM Recognition



CAMARA NACIONAL
DE LA INDUSTRIA
ELECTRONICA, DE
TELECOMUNICACIONES
E INFORMÁTICA

Laboratorio Valentín V. Rivero

México D.F. a 16 de octubre de 2006.

**LESLIE BAI
DIRECTOR OF CERTIFICATION
SIEMIC LABORATORIES, INC.
ACCESSING GLOBAL MARKETS
P R E S E N T E**

En contestación a su escrito de fecha 5 de septiembre del año en curso, le comento que estamos muy interesados en su intención de firmar un Acuerdo de Reconocimiento Mutuo, para lo cual adjunto a este escrito encontrara el Acuerdo en idioma ingles y español preferido de los cuales le pido sea revisado y en su caso corregido, para que si este de acuerdo poder firmarlo para mandarlo con las autoridades Mexicanas para su visto bueno y así poder ejercer dicho acuerdo.

Aprovecho este escrito para mencionarle que nuestro intermediario gestor será la empresa Isatel de México S. A. de C. V., empresa que ha colaborado durante mucho tiempo con nosotros en lo relacionado a la evaluación de la conformidad y que cuenta con amplia experiencia en la gestión de la certificación de cumplimiento con Normas Oficiales Mexicanas de producto en México.

Me despido de usted enviándole un cordial saludo y esperando sus comentarios al Acuerdo que nos ocupa

Atentamente:

**Ing. Faustino Gomez González
Gerente Técnico del Laboratorio de
CANIETI**



SIEMIC, INC.
Accessing global markets

Title: RF Test Report of Non-Keypad iCLASS Rev E Reader
Model : R30E
To FCC 15.225 2011

Serial# SL12061801-HID-018_iClass RevE_RF_R30E(FCC)
Issue Date Aug 23rd, 2012
Page 58 of 63
www.sieminc.com

SIEMIC ACCREDITATION DETAILS: Hong Kong OFTA CAB ID : US0160



UNITED STATES DEPARTMENT OF COMMERCE
National Institute of Standards and Technology
Gaithersburg, Maryland 20899-

December 8, 2008

Mr. Leslie Bai
SIEMIC, Inc.
2206 Ringwood Avenue
San Jose, CA 95131

Dear Mr. Bai:

NIST is pleased to inform you that your laboratory has been recognized by the Office of the Telecommunications Authority (OFTA) under the Asia Pacific Economic Cooperation for Telecommunications Equipment Mutual Recognition Arrangement (APEC Tel MRA). Your laboratory is now designated to act as a Conformity Assessment Body (CAB) under Appendix B, **Phase I** Procedures, of the APEC Tel MRA. The pertinent information about your laboratory's designation is as follows:

CAB Name: SIEMIC, Inc.
Physical Location: 2206 Ringwood Avenue, San Jose, California 95131 USA
Identification No.: US0160
Recognized Scope: **Radio:** HKTA 1002, 1007, 1008, 1010, 1015, 1016, 1020, 1022, 1026, 1027, 1029, 1030, 1031, 1032, 1033, 1034, 1035, 1036, 1037, 1039, 1041, 1042, 1043, 1044, 1046, 1047, 1048, 1049, 1051
Telecom: HKTA 2011, 2012, 2013, 2014, 2017, 2018, 2022, 2024, 2026, 2027, 2028, 2029, 2030, 2031, 2032, 2033

You may submit test data to OFTA to verify that the equipment to be imported into Hong Kong satisfies the applicable requirements. The designation of your organization will remain in force as long as its accreditation for the designated scope remains valid and comply with the designation requirements.

Recognized CABs are listed on the NIST website at <http://ts.nist.gov/mra>. If you have any questions please contact Ramona Saar at (301) 975-5521 or ramona.saar@nist.gov.

Sincerely,

David F. Alderman
Group Leader, Standards Coordination and Conformity Group
Standards Services Division

Enclosure

cc: Ramona Saar

SIEMIC ACCREDITATION DETAILS: Australia ACMA CAB ID: US0160



UNITED STATES DEPARTMENT OF COMMERCE
National Institute of Standards and Technology
Gaithersburg, Maryland 20899-

November 20, 2008

Mr. Leslie Bai
SIEMIC, Inc.
2206 Ringwood Avenue
San Jose, CA 95131

Dear Mr. Bai:

NIST is pleased to inform you that your laboratory has been recognized by the Australian Communications and Media Authority (ACMA) under the Asia Pacific Economic Cooperation for Telecommunications Equipment Mutual Recognition Arrangement (APEC Tel MRA). Your laboratory is now designated to act as a Conformity Assessment Body (CAB) under Appendix B, **Phase I** Procedures, of the APEC Tel MRA. The pertinent information about your laboratory's designation is as follows:

CAB Name: Siemic, Inc.
Physical Location: 2206 Ringwood Avenue, San Jose, CA 95131
Identification No.: US0160
Recognized Scope: EMC: AS/NZS 4251.1 (until 5/31/2009), AS/NZS 4251.2 (until 5/31/2009), AS/NZS CISPR 11, AS/NZS CISPR 14.1, AS/NZS CISPR 22, AS/NZS 61000.6.3, AS/NZS 61000.6.4
Radiocommunications: AS/NZS 4281, AS/NZS 4268, AS/NZS 4280.1, AS/NZS 4280.2, AS/NZS 4295, AS/NZS 4582, AS/NZS 4583, AS/NZS 4769.1, AS/NZS 4769.2, AS/NZS 4770, AS/NZS 4771
Telecommunications: AS/ACIF S002:05, AS/ACIF S003:06, AS/ACIF S004:06, AS/ACIF S006:01, AS/ACIF S016:01, AS/ACIF S031:01, AS/ACIF S038:01, AS/ACIF S040:01, AS/ACIF S041:05, AS/ACIF S043.2:06, AS/NZS 60950.1

You may submit test data to ACMA to verify that the equipment to be imported into Australia satisfies the applicable requirements. The designation of your organization will remain in force as long as its accreditation for the designated scope remains valid and comply with the designation requirements. Recognized CABs are listed on the NIST website at <http://ts.nist.gov/mra>. Please contact Ms. Ramona Saar, at (301) 975-5521 or ramona.saar@nist.gov if you have questions.

Sincerely,

David F. Alderman
Group Leader, Standards Coordination and Conformity Group
Standards Services Division

Enclosure

cc: Snell Leong, Siemic, Inc.; Ramona Saar, NIST

NIST

SIEMIC ACCREDITATION DETAILS: Australia NATA Recognition



Leslie Bai
SIEMIC, Inc.
2206 Ringwood Avenue
San Jose, CA 95131

November 4, 2008

Under Australian government legislation, the Australian Communications and Media Authority (ACMA) has determined the National Association of Testing Authorities, Australia (NATA) as an accreditation body as per Section 409(1) of the Telecommunications Act 1997 (Cth). Pursuant to Section 409(2) of the Telecommunications Act 1997 (Cth), I am pleased to advise that your laboratory has been determined as a Recognised Testing Authority (RTA).

This determination has been made on the basis of your accreditation by A2LA accreditation no. 2742.01 and the Mutual Recognition Agreement between NATA and A2LA. It is effective from 11 July 2008. RTA status applies only to the following standards and is contingent upon their continued inclusion in your laboratory's scope of accreditation.

**AS/ACIF S002, AS/ACIF S003, AS/ACIF S004,
AS/ACIF S006, AS/ACIF S016, AS/ACIF S031,
AS/ACIF S038, AS/ACIF S041 and
AS/ACIF S043.2**

As an RTA, your laboratory has the following obligations:

1. the laboratory shall continue to meet all of the accreditation criteria of A2LA;
2. the authorised representative of the laboratory shall notify NATA of changes to the staff or operations of the laboratory which would affect the performance of the tests for which the laboratory has been determined;
3. compliance of equipment shall be reported on test reports bearing the A2LA logo/endorsement.

Current information on the Australian Communications and Media Authority and regulatory requirements for telecommunications products within Australia can be obtained from the ACMA's web-site at "<http://www.acma.gov.au>". Further information about NATA may be gained by visiting "<http://www.nata.asn.au>".

Please note that AS/ACIF S040 and New Zealand standards do not form part of the RTA scheme.

Your RTA listing will appear on the NATA website shortly.

Kind Regards

Chris Norton,
Senior Scientific Officer
Measurement Science and Technology
National Association of Testing Authorities (NATA)
71-73 Flemington Road
North Melbourne Vic 3051
Australia
Ph: +61 3 9329 1633 Fx: +61 3 9326 5148
E-Mail: Christopher.Norton@nata.asn.au
Internet: www.nata.asn.au



SIEMIC ACCREDITATION DETAILS: VCCI Radiated Test Site Registration No. R-3083

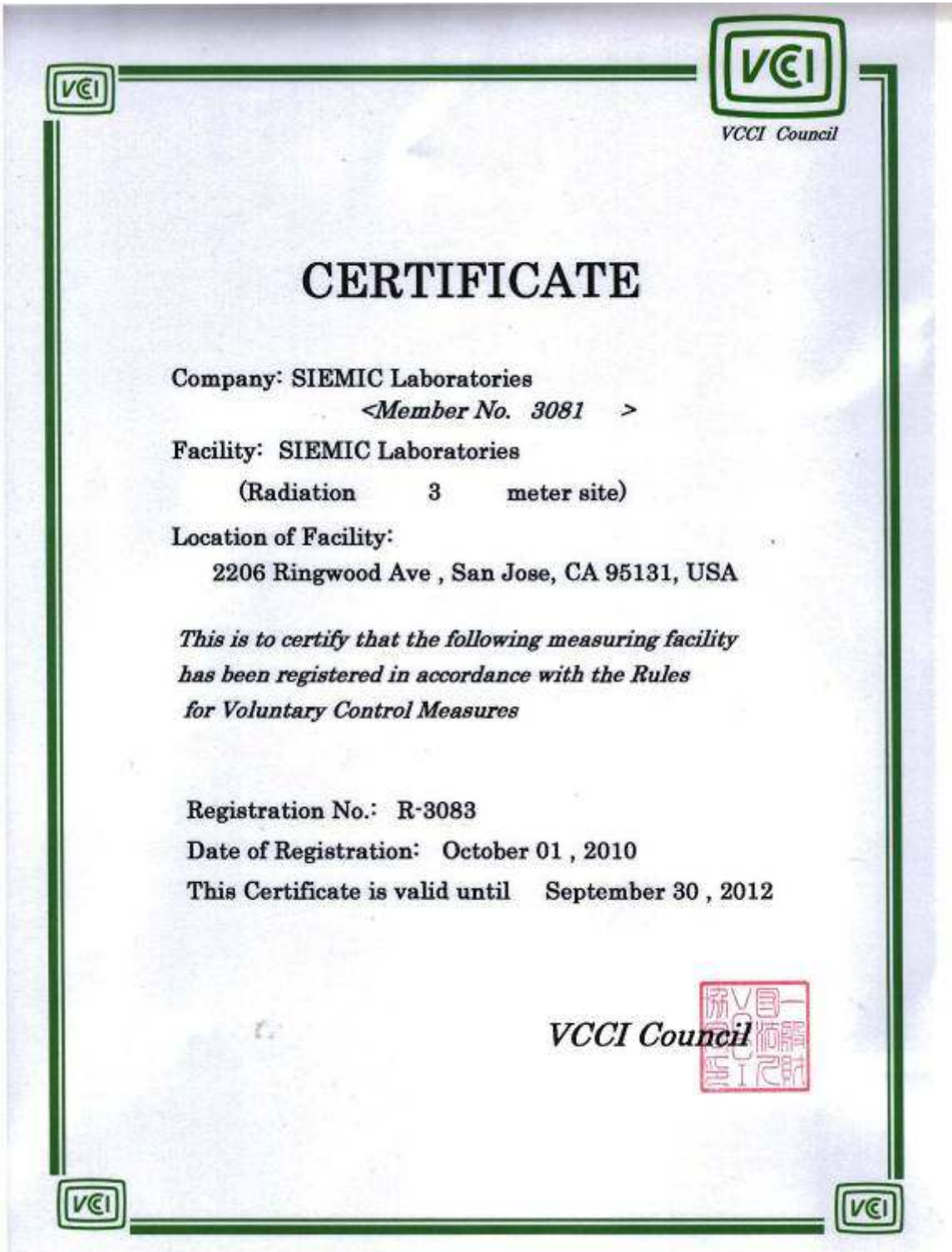

CERTIFICATE

Company: SIEMIC Laboratories
<Member No. 3081 >

Facility: SIEMIC Laboratories
(Radiation 3 meter site)

Location of Facility:
2206 Ringwood Ave , San Jose, CA 95131, USA

*This is to certify that the following measuring facility
has been registered in accordance with the Rules
for Voluntary Control Measures*

Registration No.: R-3083
Date of Registration: October 01 , 2010
This Certificate is valid until September 30 , 2012

VCCI Council





SIEMIC, INC.

Accessing global markets

Title: RF Test Report of Non-Keypad iCLASS Rev E Reader
Model : R30E
To FCC 15.225 2011

Serial# SL12061801-HID-018_iClass RevE_RF_R30E(FCC)
Issue Date Aug 23rd, 2012
Page 62 of 63
www.siemec.com

SIEMIC ACCREDITATION DETAILS: VCCI Conducted (Main Port) Test Site Registration No. C-3421



VCCI Council

CERTIFICATE

Company: SIEMIC Laboratories

<Member No. 3081 >

Facility: SIEMIC Laboratories

(Main Ports Conducted Interference Measurement)

Location of Facility:

2206 Ringwood Ave San Jose, CA 95131, USA

*This is to certify that the following measuring facility
has been registered in accordance with the Rules
for Voluntary Control Measures*

Registration No.: C-3421

Date of Registration: October 01, 2010

This Certificate is valid until September 30, 2012

VCCI Council





SIEMIC, INC.

Accessing global markets

Title: RF Test Report of Non-Keypad iCLASS Rev E Reader
Model : R30E
To FCC 15.225 2011

Serial# SL12061801-HID-018_iClass RevE_RF_R30E(FCC)
Issue Date Aug 23rd, 2012
Page 63 of 63
www.siemic.com

SIEMIC ACCREDITATION DETAILS: VCCI Conducted (Telecom Port) Test Site Registration No. T-1597



VCCI Council

CERTIFICATE

Company: SIEMIC Laboratories

<Member No. 3081 >

Facility: SIEMIC Laboratories

(Telecommunication Ports Conducted Disturbance Measurement)

Location of Facility:

2206 Ringwood Ave San Jose, CA 95131, USA

*This is to certify that the following measuring facility
has been registered in accordance with the Rules
for Voluntary Control Measures*

Registration No.: T-1597

Date of Registration: October 01 , 2010

This Certificate is valid until September 30 , 2012

VCCI Council

