

HID GLOBAL CORPORATION

RFID READER, OPERATING ON 13.56 MHZ

Model: R10D

November 15 2010



Report No.: SL10071904-HID-012_R10D (FCC,IC)

(This report supersedes None)



Modifications made to the product : None

This Test Report is Issued Under the Authority of:

	
Dan Corona Compliance Engineer	Leslie Bai Director of Certification

This test report may be reproduced in full only.
Test result presented in this test report is applicable to the representative sample only.

EMC Test Report

To: FCC Part 15.207, 15.209, 15.225, RSS-GEN, RSS-210

SIEMIC, INC.
Accessing global markets



This page has been left blank intentionally.

CONTENTS

1	EXECUTIVE SUMMARY & EUT INFORMATION	3
2	TECHNICAL DETAILS.....	3
3	MODIFICATION.....	3
4	TEST SUMMARY.....	3
5	MEASUREMENTS, EXAMINATION AND DERIVED RESULTS	3
	ANNEX A. TEST INSTRUMENT & METHOD	3
	ANNEX B. TEST SETUP PHOTOGRAPHS.....	3
	ANNEX B. I. EUT INTERNAL PHOTOGRAPHS	3
	ANNEX B. II. EUT EXTERNAL PHOTOGRAPHS	3
	ANNEX C. SUPPORTING EQUIPMENT DESCRIPTION.....	3
	ANNEX D. EUT OPERATING CONDITIONS	3
	ANNEX E. USER MANUAL, BLOCK & CIRCUIT DIAGRAM.....	3
	ANNEX F. SIEMIC ACCREDITATION CERTIFICATES	3

This page has been left blank intentionally.

1 Executive Summary & EUT information

The purpose of this test programmed was to demonstrate compliance of the HID Global Corp., Model: R10D against the current Stipulated Standards.

The equipment under test radio operating frequency is 13.56 MHz.

The test has demonstrated that this unit complies with stipulated standards.

EUT Information

EUT Description	:	The R10D is an inductive RFID card reader intended to be used in access control systems, parking systems and other applications using RFID readers. It is capable of reading 13.56 MHz inductive tags.
Model No	:	R10D
Serial No	:	N/A
Input Power	:	12 VDC
Classification Per Stipulated Test Standard	:	RFID Reader

2 TECHNICAL DETAILS

Purpose	Compliance testing of RFID Reader, Operating on 13.56 MHz with stipulated standard
Applicant / Client	HID Global Corporation
Manufacturer	HID Global Corporation 15730 Barranca Parkway Irvine, CA 92618 USA
Laboratory performing the tests	SIEMIC Laboratories
Test report reference number	SL10071904-HID-012_R10D (FCC,IC)
Date EUT received	November 8 2010
Standard applied	47 CFR §15.207, 15.209, 15.225: 2010 & Canadian Standards RSS-GEN Issue 2: 2007, RSS-210 Issue 7: 2007
Dates of test (from – to)	November 08 - 12 2010
No of Units:	2
Equipment Category:	DXX
Model :	R10D
RF Operating Frequency (ies)	13.56 MHz (RFID)
Number of Channels :	1
FCC ID :	JQ6-ICLASSR10D
IC ID :	2236B- ICLASSR10D

3 MODIFICATION

NONE

4 TEST SUMMARY

The product was tested in accordance with the following specifications. All testing has been performed according to below product classification:

RFID Reader

Test Results Summary

Test Standard		Description	Pass / Fail
47 CFR Part 15.225: 2010	RSS 210 Issue 7: 2007		
15.203		Antenna Requirement	Pass
15.207(a)	RSS Gen(7.2.2)	Conducted Emissions Voltage	Pass
15.225(a)	RSS210(A2.6)	Limit in the band of 13.553 – 13.567 MHz	Pass
15.225(b)	RSS210(A2.6)	Limit in the band of 13.410 – 13.553 MHz and 13.567 – 13.710 MHz	Pass
15.225(c)	RSS210(A2.6)	Limit in the band of 13.110 – 13.410 MHz and 13.710 – 14.010 MHz	Pass
15.225(d), 15.209	RSS210(A2.6)	Limit outside the band of 13.110 – 14.010 MHz	Pass
15.225(e)	RSS210(A2.6)	Frequency Stability	Pass
	RSS-210(5.9.1)	Occupied Bandwidth	Pass
	RSS-310 (3.7)	Very Low Power Devices Operating Below 490 kHz	N/A

ANSI C63.4: 2003/ RSS-Gen Issue 2: 2007

PS: All measurement uncertainties are not taken into consideration for all presented test result.

5 MEASUREMENTS, EXAMINATION AND DERIVED RESULTS

5.1 Antenna Requirement

Requirement(s): 47 CFR §15.203

An intentional radiator shall be designed to ensure that no antenna other than that furnished by the responsible party shall be used with the device.

Antenna requirement must meet at least one of the following:

- a) Antenna must be permanently attached to the device.
 - b) Antenna must use a unique type of connector to attach to the device.
 - c) Device must be professionally installed. Installer shall be responsible for ensuring that the correct antenna is employed with the device.
-
- 1) The RFID antenna is integral to the main board permanently to the device which meets the requirement (See Internal Photographs submitted as another Exhibit).

5.2 Conducted Emissions Voltage

Requirement(s): 47 CFR §15.207

Requirement:

Frequency of emission (MHz)	Conducted limit (dBµV)	
	Quasi-peak	Average
0.15–0.5	66 to 56*	56 to 46*
0.5–5	56	46
5–30	60	50

*Decreases with the logarithm of the frequency.

Procedures:

1. All possible modes of operation were investigated. Only the 6 worst case emissions measured, using the correct CISPR and Average detectors, are reported. All other emissions were relatively insignificant.
 2. A "-ve" margin indicates a PASS as it refers to the margin present below the limit line at the particular frequency.
 3. Conducted Emissions Measurement Uncertainty
All test measurements carried out are traceable to national standards. The uncertainty of the measurement at a confidence level of approximately 95% (in the case where distributions are normal), with a coverage factor of 2, in the range 9kHz – 30MHz (Average & Quasi-peak) is ±3.5dB.
 4. Environmental Conditions

Temperature	23°C
Relative Humidity	50%
Atmospheric Pressure	1019mbar
- Test Date : November 8-12 2010
Tested By : Dan Corona

Results: Pass

Test Result - PoE AC adapter

Quasi-Peak Limit

Average Limit

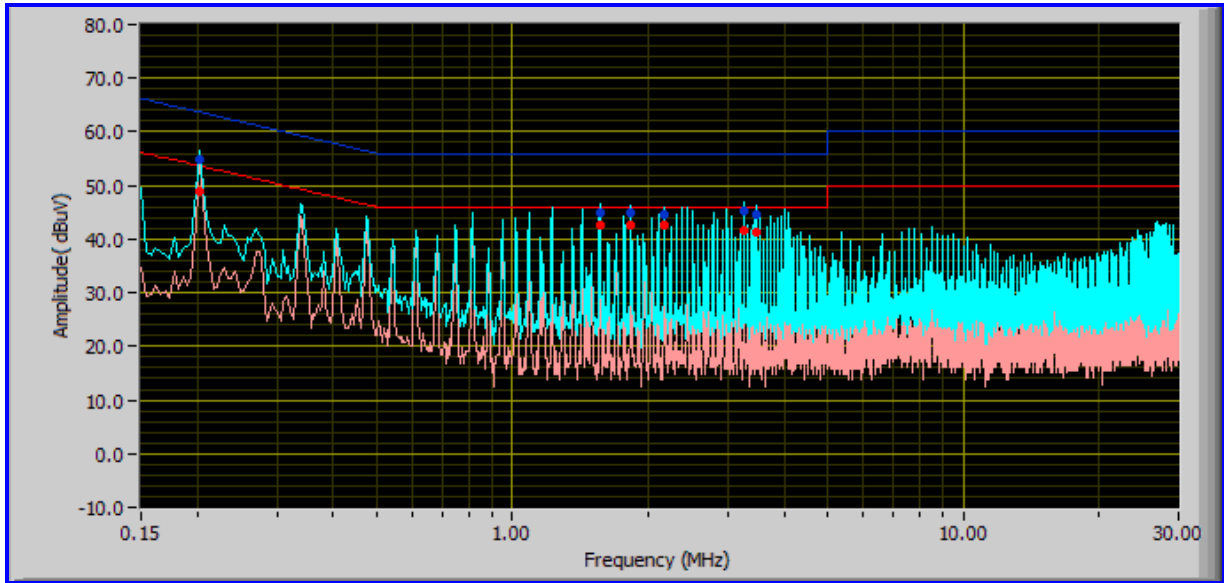

110V, 60Hz, Neutral Line

Frequency (MHz)	QP Value (dB μ V)	Class B Limit (dB)	Pass / Fail	Margin (dB)	Avg Value (dB μ V)	Class B Limit (dB)	Pass / Fail	Margin (dB)	Line
0.20	54.90	63.67	Pass	-8.77	48.86	53.67	Pass	-4.81	Neutral
3.26	45.38	56.00	Pass	-10.62	41.49	46.00	Pass	-4.51	Neutral
1.56	44.94	56.00	Pass	-11.06	42.76	46.00	Pass	-3.24	Neutral
1.83	45.02	56.00	Pass	-10.98	42.54	46.00	Pass	-3.46	Neutral
3.46	44.76	56.00	Pass	-11.24	41.27	46.00	Pass	-4.73	Neutral
2.17	44.71	56.00	Pass	-11.29	42.54	46.00	Pass	-3.46	Neutral

Quasi-Peak Limit

Average Limit

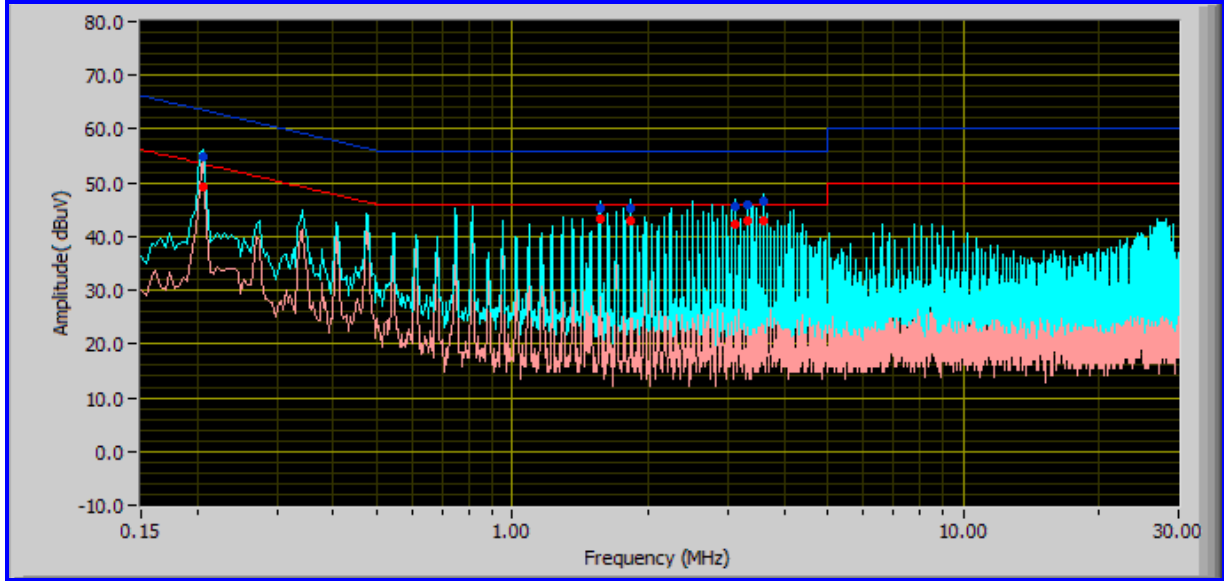

110V, 60Hz, Phase Line

Frequency (MHz)	QP Value (dBμV)	Class B Limit (dB)	Pass / Fail	Margin (dB)	Avg Value (dBμV)	Class B Limit (dB)	Pass / Fail	Margin (dB)	Line
0.21	54.72	63.50	Pass	-8.78	49.13	53.50	Pass	-4.37	Phase
3.60	46.64	56.00	Pass	-9.36	42.79	46.00	Pass	-3.21	Phase
3.12	45.64	56.00	Pass	-10.36	42.13	46.00	Pass	-3.87	Phase
1.83	45.42	56.00	Pass	-10.58	43.05	46.00	Pass	-2.95	Phase
3.33	45.93	56.00	Pass	-10.07	42.88	46.00	Pass	-3.12	Phase
1.56	45.35	56.00	Pass	-10.65	43.13	46.00	Pass	-2.87	Phase

Test Result - DC Power Supply

Quasi-Peak Limit

Average Limit

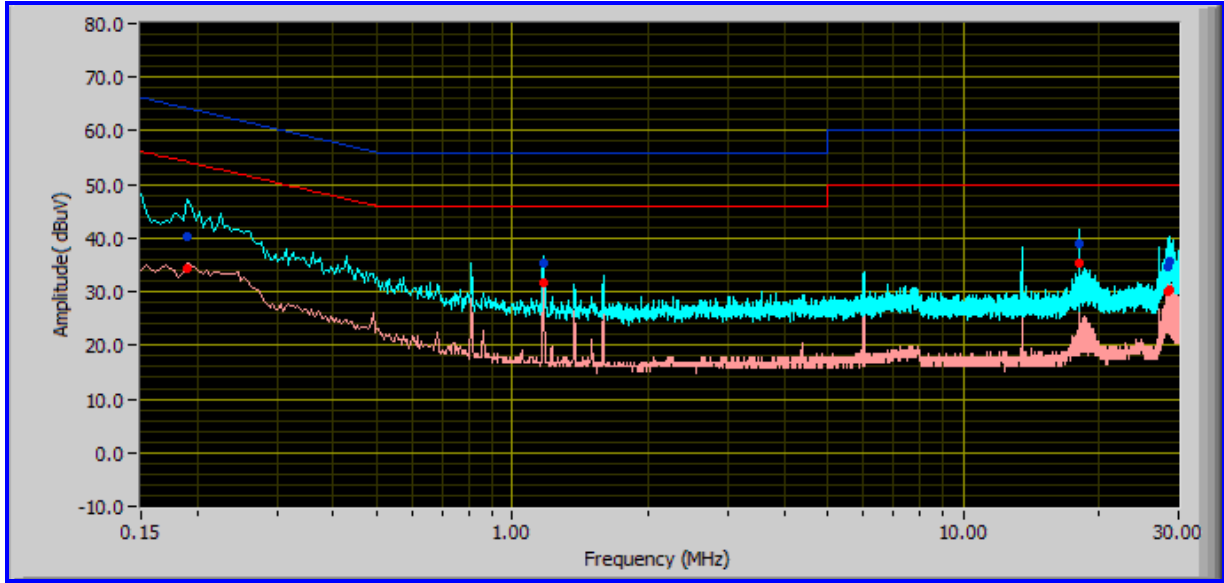

110 Vac, Positive Line

Frequency (MHz)	QP Value (dBµV)	Class B Limit (dB)	Pass / Fail	Margin (dB)	Avg Value (dBµV)	Class B Limit (dB)	Pass / Fail	Margin (dB)	Line
0.19	40.42	64.19	Pass	-23.77	34.24	54.19	Pass	-19.95	Positive
18.04	38.94	60.00	Pass	-21.06	35.46	50.00	Pass	-14.54	Positive
1.17	35.38	56.00	Pass	-20.62	31.70	46.00	Pass	-14.30	Positive
28.61	35.51	60.00	Pass	-24.49	30.31	50.00	Pass	-19.69	Positive
28.68	35.61	60.00	Pass	-24.39	30.31	50.00	Pass	-19.69	Positive
28.47	34.71	60.00	Pass	-25.29	29.91	50.00	Pass	-20.09	Positive

Quasi-Peak Limit

Average Limit

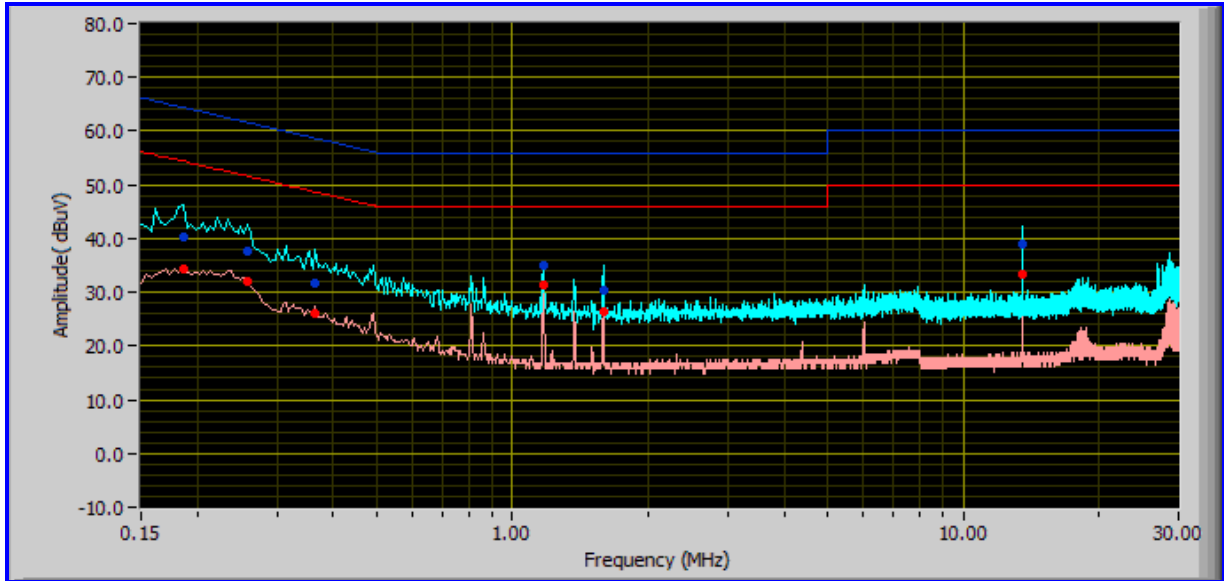

110 Vac, Negative Line

Frequency (MHz)	QP Value (dBμV)	Class B Limit (dB)	Pass / Fail	Margin (dB)	Avg Value (dBμV)	Class B Limit (dB)	Pass / Fail	Margin (dB)	Line
13.56	38.98	60.00	Pass	-21.02	33.37	50.00	Pass	-16.63	Negative
0.19	40.36	64.37	Pass	-24.01	34.39	54.37	Pass	-19.98	Negative
0.26	37.65	61.60	Pass	-23.94	32.00	51.60	Pass	-19.60	Negative
0.37	31.59	58.64	Pass	-27.05	26.02	48.64	Pass	-22.62	Negative
1.59	30.35	56.00	Pass	-25.65	26.55	46.00	Pass	-19.45	Negative
1.17	35.08	56.00	Pass	-20.92	31.35	46.00	Pass	-14.65	Negative

5.3 Radiated Emission < 30MHz (9kHz - 30MHz, H-Field)

Requirement(s): 47 CFR §15.225 & RSS-210 (A2.6) & RSS-310 (3.7)

Procedures: For < 30MHz, Radiated emissions were measured according to ANSI C63.4. The EUT was set to transmit at the highest output power. The EUT was set 10 meter away from the measuring antenna. The loop antenna was positioned 1 meter above the ground from the centre of the loop. The measuring bandwidth was set to 10 kHz. (Note: During testing the receive antenna was rotated about its axis to maximize the emission from the EUT.)

The limit is converted from microvolt/meter to decibel microvolt/meter.

Sample Calculation: Corrected Amplitude = Raw Amplitude (dBμV/m) + ACF (dB) + Cable Loss (dB) – Distance Correction Factor

1. All possible modes of operation were investigated. Only the 6 worst case emissions measured, using the correct CISPR detectors, are reported. All other emissions were relatively insignificant.
2. A "-ve" margin indicates a PASS as it refers to the margin present below the limit line at the particular frequency.
3. Radiated Emissions Measurement Uncertainty
All test measurements carried out are traceable to national standards. The uncertainty of the measurement at a confidence level of approximately 95% (in the case where distributions are normal), with a coverage factor of 2, is +/- 6dB.

- | | | | |
|----|--------------------------|----------------------|----------|
| 4. | Environmental Conditions | Temperature | 23°C |
| | | Relative Humidity | 50% |
| | | Atmospheric Pressure | 1019mbar |

Test Date : November 8-12 2010

Tested By : Dan Corona

Results: Pass

100 kHz ~ 1 MHz

Loop Antenna at 0 degree

General Emission Limit @ 3 Meter

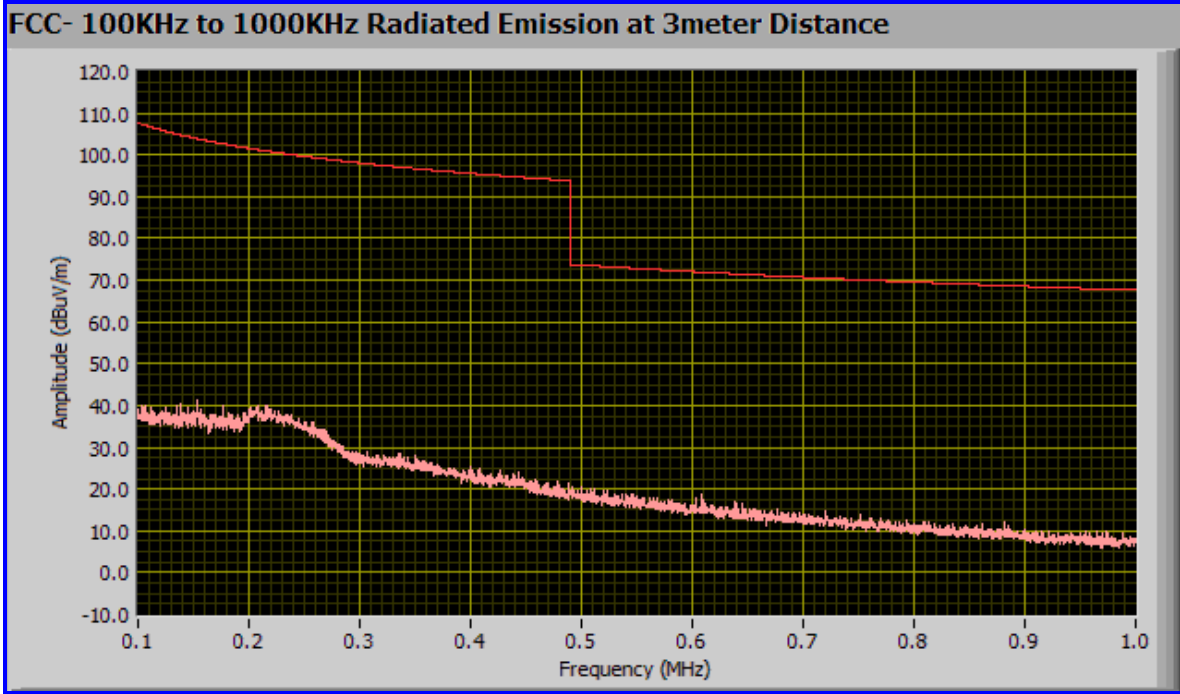

Loop Antenna at 90 degree

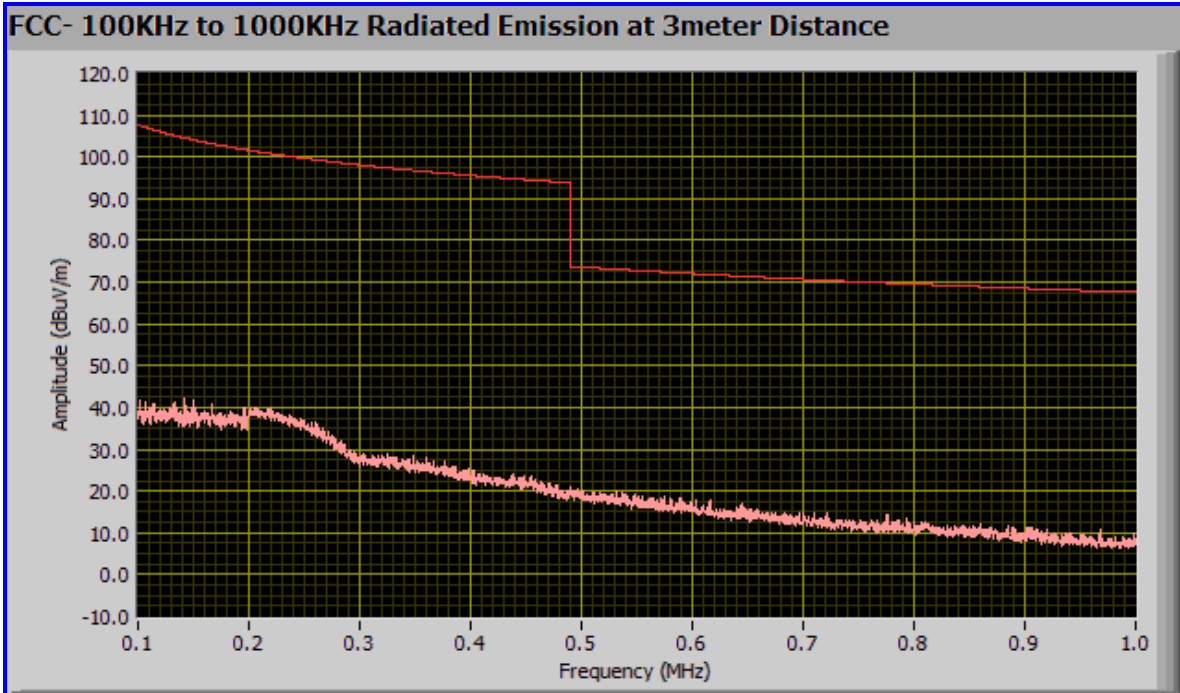

1MHz ~ 30MHz

General Emission Limit @ 3 meter

Loop Antenna at 0 degree

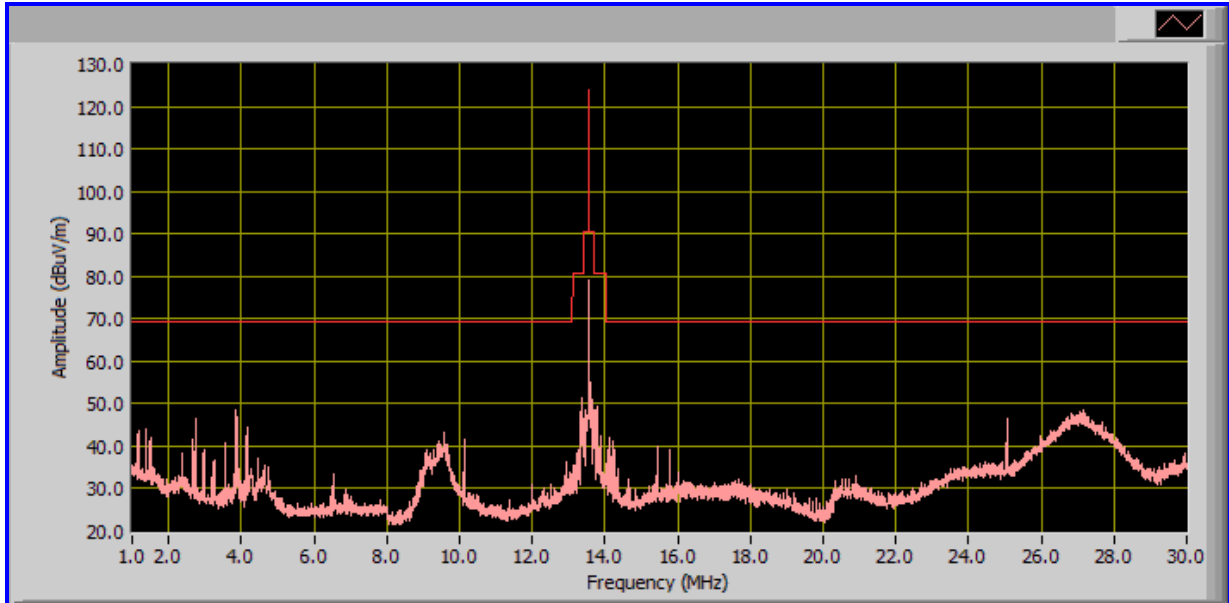

Loop Antenna at 90 degree

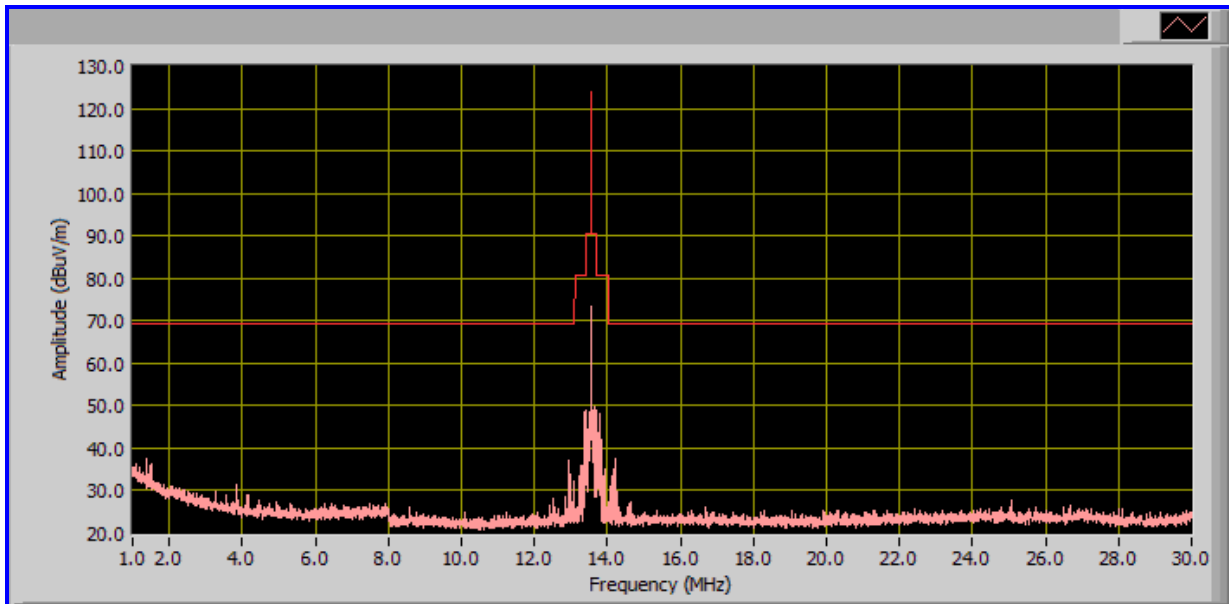

5.4 Radiated Emissions > 30 MHz (30MHz – 1 GHz, E-Field)

Requirement(s): 47 CFR §15.209; 47 CFR §15.225(d) & RSS-210 (A2.6)

Procedures: For > 30MHz, Radiated emissions were measured according to ANSI C63.4. The EUT was set to transmit at the highest output power. The EUT was set 10 meter away from the measuring antenna. The Log periodic antenna was positioned 1 meter above the ground from the centre of the antenna. The measuring bandwidth was set to 120 kHz. (Note: During testing the receive antenna was raise from 1~4 meters to maximize the emission from the EUT.)

The limit is converted from microvolt/meter to decibel microvolt/meter.

Sample Calculation: Corrected Amplitude = Raw Amplitude (dBμV/m) + ACF (dB) + Cable Loss(dB) – Distance Correction Factor

1. All possible modes of operation were investigated. Only the 6 worst case emissions measured, using the correct CISPR detectors, are reported. All other emissions were relatively insignificant.
2. A "-ve" margin indicates a PASS as it refers to the margin present below the limit line at the particular frequency.
3. Radiated Emissions Measurement Uncertainty
All test measurements carried out are traceable to national standards. The uncertainty of the measurement at a confidence level of approximately 95% (in the case where distributions are normal), with a coverage factor of 2, is +/- 6dB.
4. Environmental Conditions

Temperature	23°C
Relative Humidity	50%
Atmospheric Pressure	1019mbar

Test Date : November 8-12 2010

Tested By : Dan Corona

Results: Pass

General Emission Limit @ 3 meter

30MHz ~ 1000MHz

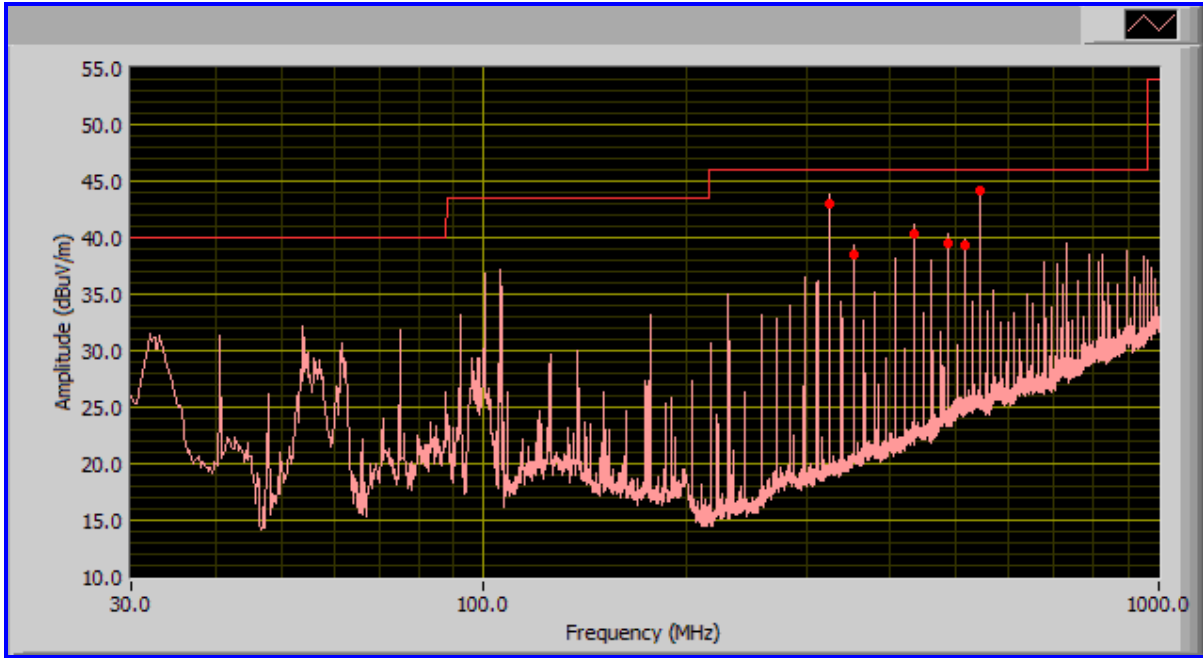

Radiated Emission Test Table 30MHz ~ 1000MHz

Frequency (MHz)	Amplitude @ 3m	Azimuth (degree)	Antenna Polarity	Antenna Height (cm)	Limit @ 3 meter	Margin (dB)
352.43	38.54	136.00	H	100.00	46.00	-7.46
325.41	43.02	141.00	H	105.00	46.00	-2.98
542.40	44.19	209.00	H	154.00	46.00	-1.81
433.92	40.39	164.00	V	100.00	46.00	-5.61
488.15	39.43	178.00	V	184.00	46.00	-6.57
515.28	39.26	180.00	V	176.00	46.00	-6.74

5.5 Frequency Stability

Requirement(s): 47 CFR §15.225(e) & RSS-210 (A2.6)

Procedures: Frequency Stability was measured according to 47 CFR §2.1055. Measurement was taken with spectrum analyzer. The spectrum analyzer bandwidth and span was set to read in hertz. A voltmeter was used to monitor when varying the voltage.

Limit: $\pm 0.01\%$ of 13.56 MHz = 1356 Hz

Environmental Conditions	Temperature	23°C
	Relative Humidity	50%
	Atmospheric Pressure	1019mbar

Test Date : November 8-12 2010
Tested By : Dan Corona

Results: Pass

Frequency Stability versus Temperature: The Frequency tolerance of the carrier signal shall be maintained within $\pm 0.01\%$ of the operating frequency over a temperature variation of -20°C to +50°C at normal supply voltage.

Reference Frequency: 13.560410 MHz at -20°C and +50°C

Temperature (°C)	Measured Freq. (MHz)	Freq. Drift (Hz)	Freq. Deviation (Limit: 0.01%)	Pass/Fail
50	13.560370	40	<0.01	Pass
40	13.560390	20	<0.01	Pass
30	13.560390	20	<0.01	Pass
20	Reference (13.560410 MHz)			
10	13.560410	0	<0.01	Pass
0	13.560390	20	<0.01	Pass
-10	13.560350	60	<0.01	Pass
-20	13.560290	120	<0.01	Pass

Frequency Stability versus Input Voltage: The Frequency tolerance of the carrier signal shall be maintained within $\pm 0.01\%$, the frequency of the transmitter was measured at 85% and at 115% of the rated power supply voltage at 20°C environmental temperature.

Carrier Frequency: 13.560410 MHz at 20°C at 12VDC

Measured Voltage $\pm 15\%$ of nominal (DC)	Measured Freq. (MHz)	Freq. Drift (Hz)	Freq. Deviation (Limit: 0.01%)	Pass/Fail
10.2	13.560400	10	<0.01	Pass
13.8	13.560382	28	<0.01	Pass

5.6 Fundamental Field Strength Test Result

1. All possible modes of operation were investigated. Only the 6 worst case emissions measured, using the correct CISPR detectors, are reported. All other emissions were relatively insignificant.
2. A "-ve" margin indicates a PASS as it refers to the margin present below the limit line at the particular frequency.
3. Radiated Emissions Measurement Uncertainty

All test measurements carried out are traceable to national standards. The uncertainty of the measurement at a confidence level of approximately 95% (in the case where distributions are normal), with a coverage factor of 2, is +/- 6dB.

4. Environmental Conditions

Temperature	23°C
Relative Humidity	50%
Atmospheric Pressure	1019mbar

Test Date : November 8-12 2010

Tested By : Dan Corona

Test Requirement:

13.56 MHz ---The field strength of any emissions within allowed operating band shall not exceed 10mV/m at 30 meters.

Loop Antenna at 0 degree

General Emission Limit @ 3 meter

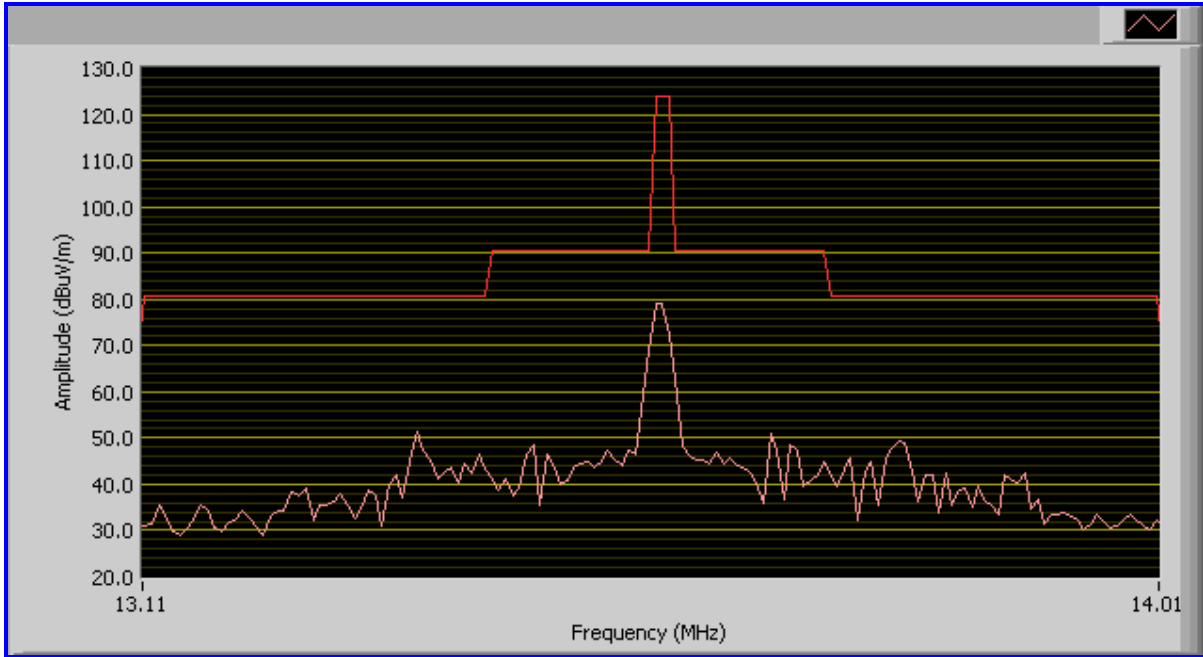

Loop Antenna at 90 degree

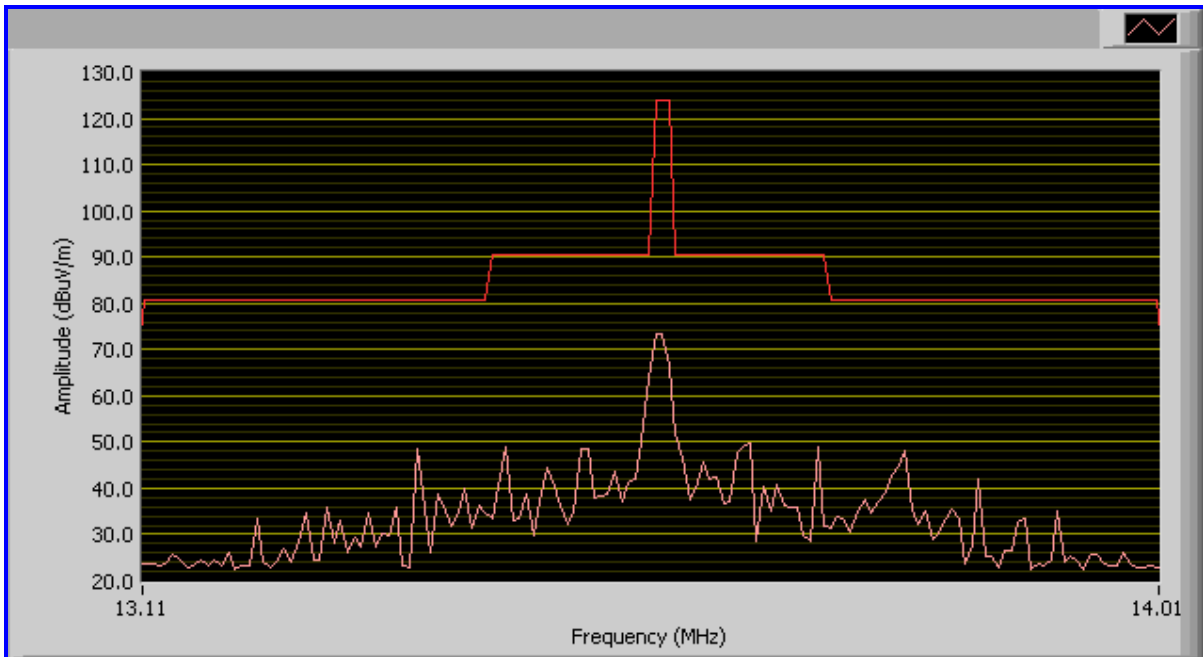

5.7 Occupied Bandwidth

Requirement(s): RSS-210 (5.9.1)

Procedures: Occupied Bandwidth was measured according to RSS-210 (5.9.1). Measurement was taken with spectrum analyzer. The spectrum analyzer bandwidth and span was set to read in hertz.

Environmental Conditions	Temperature	23°C
	Relative Humidity	50%
	Atmospheric Pressure	1019mbar

Test Date : November 8-12 2010

Tested By : Dan Corona

Results: Pass

Plots: 13.56 MHz

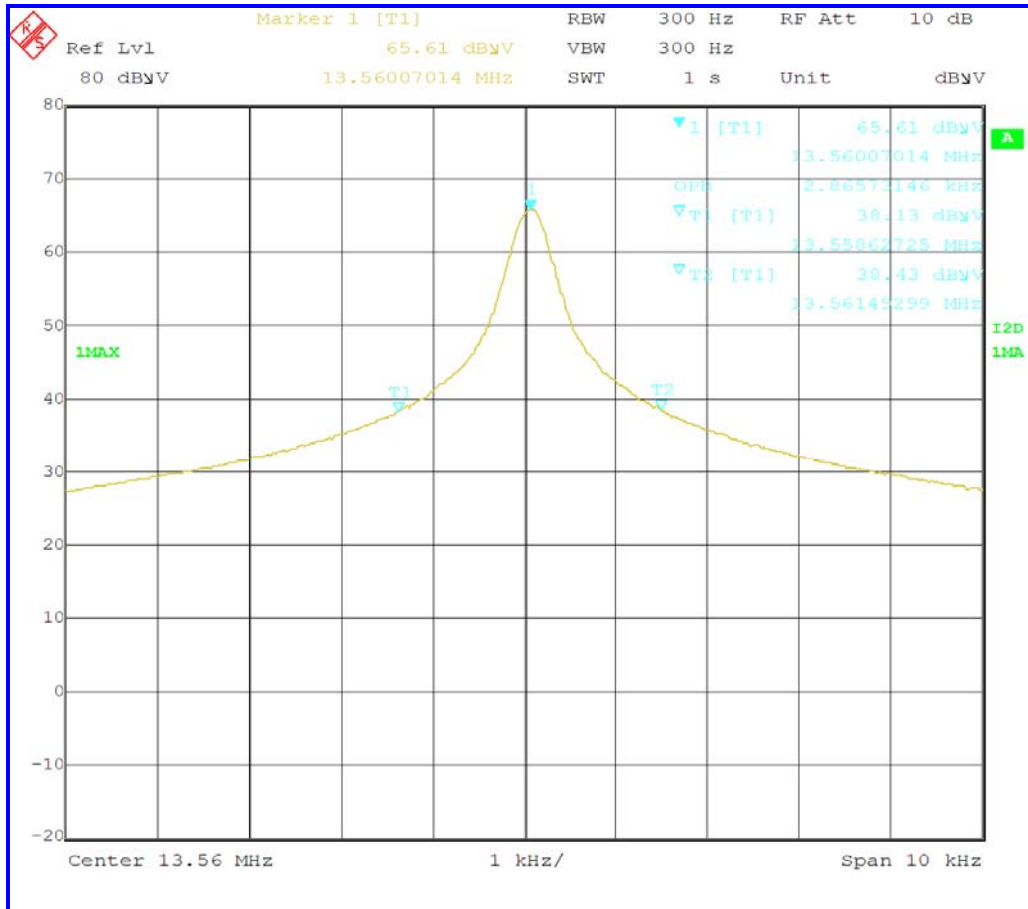

Annex A. TEST INSTRUMENT & METHOD

Annex A.i. TEST INSTRUMENTATION & GENERAL PROCEDURES

Instrument	Model	Calibration Due
AC Conducted Emissions		
R&S EMI Test Receiver	ESIB40	04/25/2011
R&S LISN	ESH2-Z5	04/24/2011
CHASE LISN	MN2050B	04/24/2011
Sekonic Hygro Hermograph	ST-50	06/04/2012
Radiated Emissions		
Spectrum Analyzer	8564E	04/26/2011
EMI Receiver	ESIB 40	04/25/2011
R&S LISN	ESH2-Z5	04/24/2011
CHASE LISN	MN2050B	04/24/2011
Horn Antenna (1 ~18GHz)	3115	06/02/2011
Biconlog Antenna (30MHz~2GHz)	JB1	06/01/2011
Passive Loop Antenna (10kHz-30MHz)	6512	08/31/2012
3 Meters SAC	3m	12/04/2010
Sekonic Hygro Hermograph	ST-50	06/04/2012
Pre-Amplifier(1 ~ 26GHz)	8449	04/24/2011
Horn Antenna (18-40GHz)	AH-840	03/19/2011
Microwave Pre-Amp (18-40GHz)	PA-840	03/19/2011*

Annex A.ii. CONDUCTED EMISSIONS TEST DESCRIPTION

Test Set-up

1. The EUT and supporting equipment were set up in accordance with the requirements of the standard on top of a 1.5m x 1m x 0.8m high, non-metallic table, as shown in Annex B.
2. The power supply for the EUT was fed through a 50Ω/50μH EUT LISN, connected to filtered mains.
3. The RF OUT of the EUT LISN was connected to the EMI test receiver via a low-loss coaxial cable.
4. All other supporting equipments were powered separately from another main supply.

Test Method

1. The EUT was switched on and allowed to warm up to its normal operating condition.
2. A scan was made on the NEUTRAL line (for AC mains) or Earth line (for DC power) over the required frequency range using an EMI test receiver.
3. High peaks, relative to the limit line, were then selected.
4. The EMI test receiver was then tuned to the selected frequencies and the necessary measurements made with a receiver bandwidth setting of 10 KHz. For FCC tests, only Quasi-peak measurements were made; while for CISPR/EN tests, both Quasi-peak and Average measurements were made.
5. Steps 2 to 4 were then repeated for the LIVE line (for AC mains) or DC line (for DC power).

Description of Conducted Emission Program

This EMC Measurement software run LabView automation software and offers a common user interface for electromagnetic interference (EMI) measurements. This software is a modern and powerful tool for controlling and monitoring EMI test receivers and EMC test systems. It guarantees reliable collection, evaluation, and documentation of measurement results. Basically, this program will run a pre-scan measurement before it proceeds with the final measurement. The pre-scan routine will run the common scan range from 15 kHz to 30 MHz; the program will first start a peak and average scan on selectable measurement time and step size. After the program complete the pre-scan, this program will perform the Quasi Peak and Average measurement, based on the pre-scan peak data reduction result.

Sample Calculation Example

At 20 MHz	limit = 250 μV = 47.96 dBμV
Transducer factor of LISN, pulse limiter & cable loss at 20 MHz = 11.20 dB	
Q-P reading obtained directly from EMI Receiver = 40.00 dBμV (Calibrated for system losses)	
Therefore, Q-P margin = 47.96 – 40.00 = 7.96	i.e. 7.96 dB below limit

Annex A. iii RADIATED EMISSIONS TEST DESCRIPTION

EUT Characterisation

EUT characterisation, over the frequency range from 100kHz – 1GHz to 10th Harmonic , was done in order to minimise radiated emissions testing time while still maintaining high confidence in the test results.

The EUT was placed in the chamber, at a height of about 0.8m on a turntable. Its radiated emissions frequency profile was observed, using a spectrum analyzer /receiver with the appropriate broadband antenna placed 3m away from the EUT. Radiated emissions from the EUT were maximised by rotating the turntable manually, changing the antenna polarisation and manipulating the EUT cables while observing the frequency profile on the spectrum analyzer / receiver. Frequency points at which maximum emissions occurred: clock frequencies and operating frequencies were then noted for the formal radiated emissions test at the Open Area Test Site (OATS) at 10m distance.

Test Set-up

1. The EUT and supporting equipment were set up in accordance with the requirements of the standard on top of a 1.5m X 1.0m X 0.8m high, non-metallic table.
2. The filtered power supply for the EUT and supporting equipment were tapped from the appropriate power sockets located on the turntable.
3. The relevant broadband antenna was set at the required test distance away from the EUT and supporting equipment boundary.

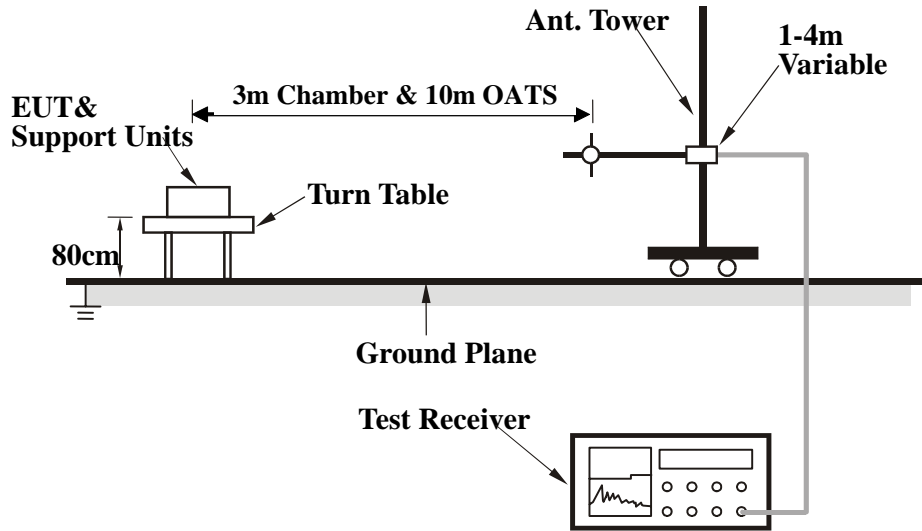

Test Method

The following procedure was performed to determine the maximum emission axis of EUT:

1. With the receiving antenna is H polarization, rotate the EUT in turns with three orthogonal axes to determine the axis of maximum emission.
2. With the receiving antenna is V polarization, rotate the EUT in turns with three orthogonal axes to determine the axis of maximum emission.
3. Compare the results derived from above two steps. So, the axis of maximum emission from EUT was determined and the configuration was used to perform the final measurement.

Final Radiated Emission Measurement

1. Setup the configuration according to figure 1. Turn on EUT and make sure that it is in normal function.
2. For emission frequencies measured below 1 GHz, a pre-scan is performed in a shielded chamber to determine the accurate frequencies of higher emissions will be checked on a open test site. As the same purpose, for emission frequencies measured above 1 GHz, a pre-scan also be performed with a 1 meter measuring distance before final test.
3. For emission frequencies measured below 1 GHz, set the spectrum analyzer on a 100 kHz and 1 MHz resolution bandwidth respectively for each frequency measured in step 2.
4. The search antenna is to be raised and lowered over a range from 1 to 4 meters in horizontally polarized orientation. Position the highness when the highest value is indicated on spectrum analyzer, then change the orientation of EUT on test table over a range from 0° to 360° with a speed as slow as possible, and keep the azimuth that highest emission is indicated on the spectrum analyzer. Vary the antenna position again and record the highest value as a final reading.
5. Repeat step 4 until all frequencies need to be measured were complete.
6. Repeat step 5 with search antenna in vertical polarized orientations.

During the radiated emission test, the Spectrum Analyzer was set with the following configurations:

Frequency Band (MHz)	Function	Resolution bandwidth	Video Bandwidth
30 to 1000	Peak	100 kHz	100 kHz
Above 1000	Peak	1 MHz	1 MHz
	Average	1 MHz	10 Hz

Description of Radiated Emission Program

This EMC Measurement software run LabView automation software and offers a common user interface for electromagnetic interference (EMI) measurements. This software is a modern and powerful tool for controlling and monitoring EMI test receivers and EMC test systems. It guarantees reliable collection, evaluation, and documentation of measurement results. Basically, this program will run a pre-scan measurement before it proceeds with the final measurement. The pre-scan routine will run the scan on four different antenna heights, 2 antenna polarity, and 360 degrees table rotation. For example, the program was set to run 30 MHz to 1 GHz scan; the program will first start from a meter antenna height and divide the 30 MHz to 1 GHz into 10 separate parts of maximum hold sweeps. Each parts of maximum hold sweep, the program will collect the data from 0 degree to 360 degrees table rotation. After the program complete the 1m scan, the antenna continues to rise to 2m and continue the scan. The step will repeated for all specified antenna height and polarity. This program will perform the Quasi Peak measurement after the signal maximization process and pre-scan routine. The final measurement will be base on the pre-scan data reduction result.

Sample Calculation Example

The field strength is calculated by adding the Antenna Factor and Cable Factor, and subtracting the Amplifier Gain (if any) from the measured reading. For the limit is employed average value, therefore the peak value can be transferred to average value by subtracting the duty factor. The basic equation with a sample calculation is as follows:

$$\text{Peak} = \text{Reading} + \text{Corrected Factor}$$

Where:

Corr. Factor = Antenna Factor + Cable Factor - Amplifier Gain (if any)

And the average value is

$$\text{Average} = \text{Peak Value} + \text{Duty Factor or} \\ \text{Set RBW} = 1\text{MHz, VBW} = 10\text{Hz.}$$

Note:

If the measured frequencies are fall in the restricted frequency band, the limit employed must be quasi peak value when frequencies are below or equal to 1 GHz. And the measuring instrument is set to quasi peak detector function.

Annex B. TEST SETUP PHOTOGRAPHS

Please See Attachment

Annex B. i. EUT INTERNAL PHOTOGRAPHS

Please see attachment

Annex B. ii. EUT EXTERNAL PHOTOGRAPHS

Please see attachment

Annex C. SUPPORTING EQUIPMENT DESCRIPTION

The following is a description of supporting equipment and details of cables used with the EUT.

Equipment Description (Including Brand Name)	Model & Serial Number	Cable Description (List Length, Type & Purpose)
POE Injector /Planet	POE-151/AF00107300297(000)	Ethernet Cable , 2m
Laptop/IBM	R32	-
RFID Controller/HIC	E400	Ethernet Cable, 2m

NOTE: No special supporting equipment are used or needed during testing to achieve compliance.

Block Configuration Diagram for Radiated Emission

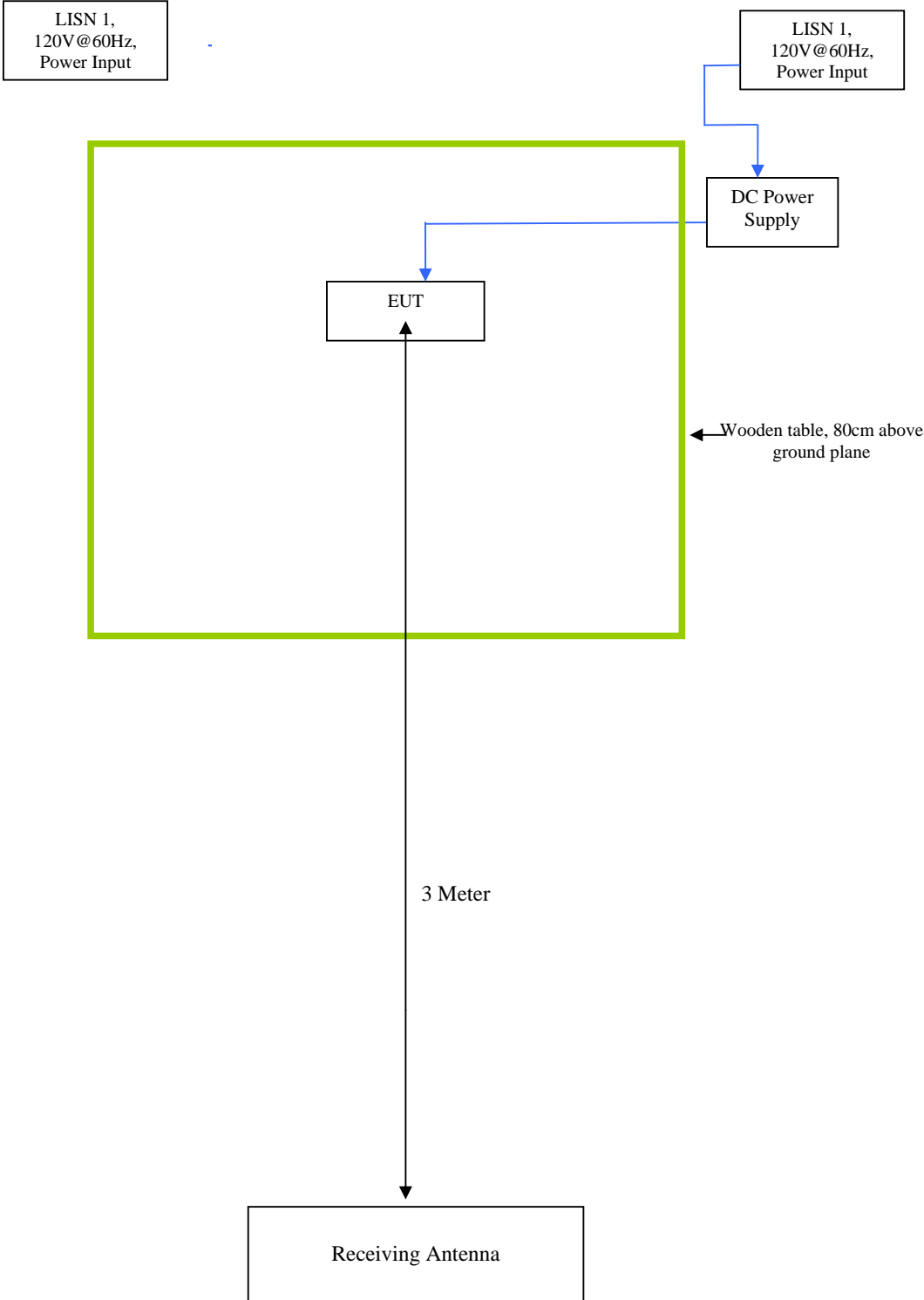

Block Configuration Diagram for DC Conducted Emission

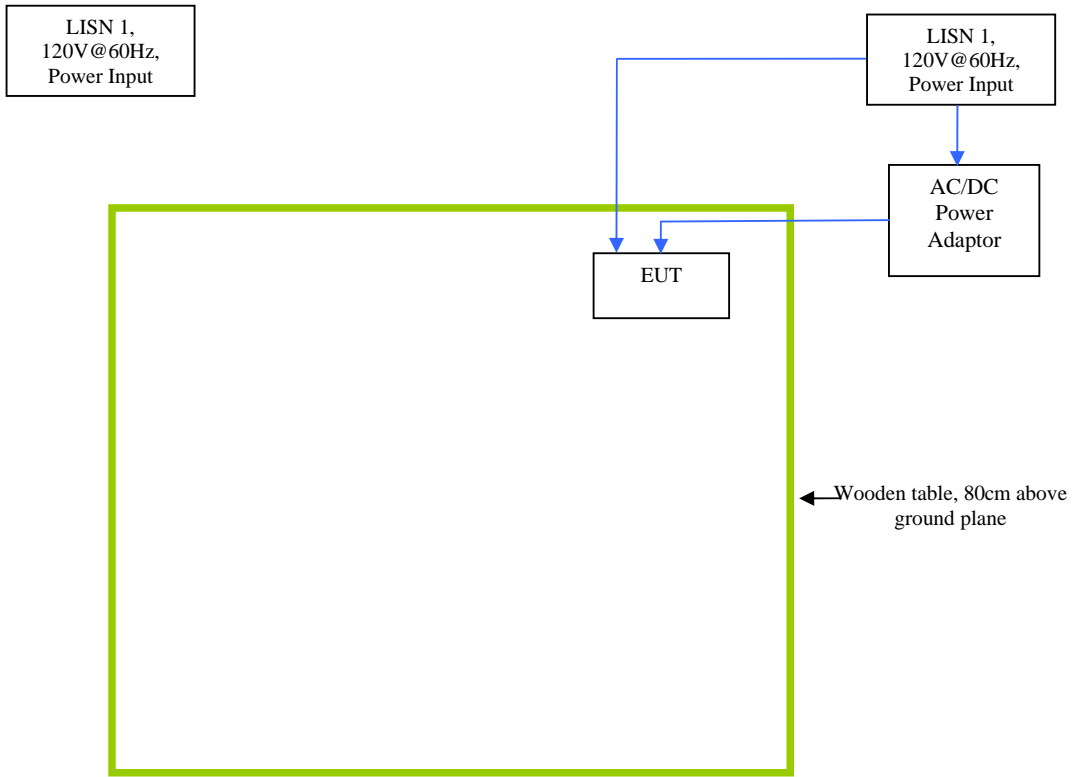

Block Configuration Diagram for AC Conducted Emission

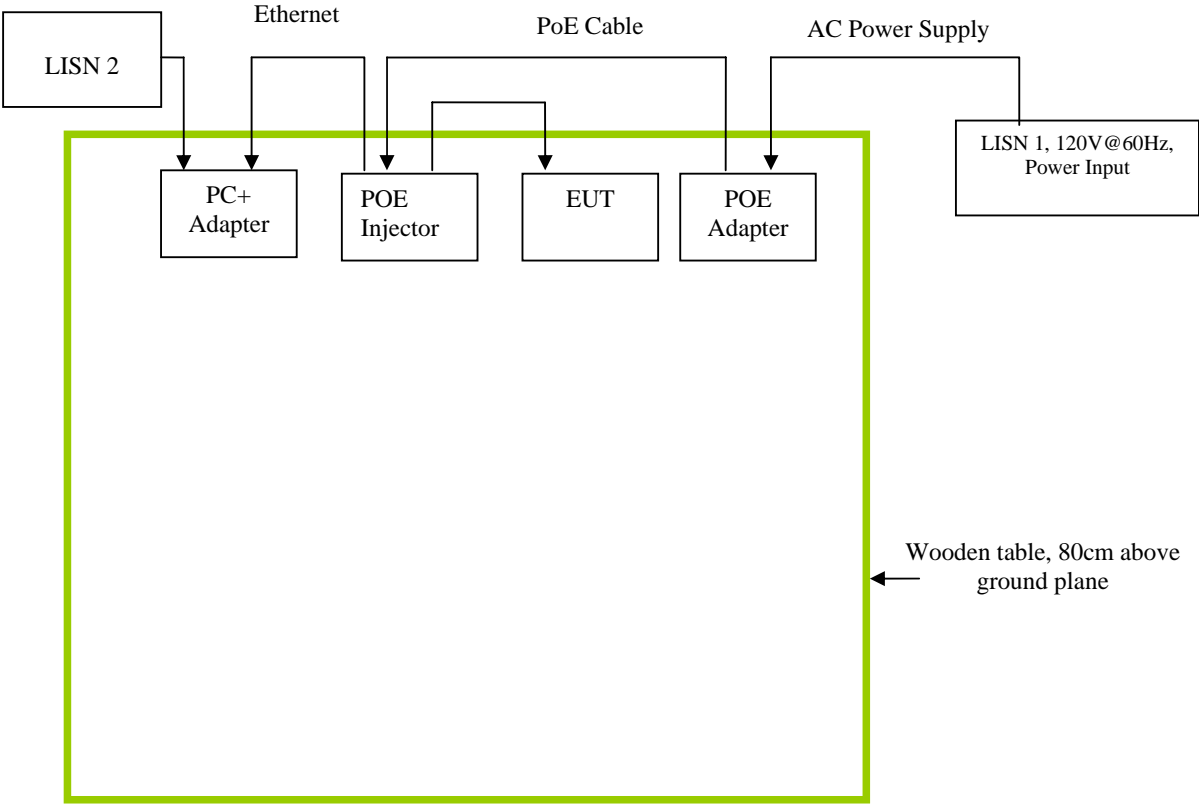

Annex D. EUT OPERATING CONDITIONS

The following is the description of how the EUT is exercised during testing.

Test	Description Of Operation
Emissions Testing	The EUT was controlled by itself.
Others Testing	The EUT was controlled by itself.

Annex E. USER MANUAL, BLOCK & CIRCUIT DIAGRAM

Please see attachment

Annex F. SIEMIC ACCREDITATION CERTIFICATES

SIEMIC ACREDITATION DETAILS: A2LA Certificate Number: 2742.01

		THE AMERICAN ASSOCIATION FOR LABORATORY ACCREDITATION
ACCREDITED LABORATORY		
A2LA has accredited SIEMIC LABORATORIES San Jose, CA for technical competence in the field of Electrical Testing		
This laboratory is accredited in accordance with the recognized International Standard ISO/IEC 17025:2005 <i>General Requirements for the Competence of Testing and Calibration Laboratories</i> . This accreditation demonstrates technical competence for a defined scope and the operation of a laboratory quality management system (refer to joint ISO-ILAC-IAF Communiqué dated 18 June 2005).		
	Presented this 11th day of July 2008.  President For the Accreditation Council Certificate Number 2742.01 Valid to September 30, 2010	
For the tests or types of tests to which this accreditation applies, please refer to the laboratory's Electrical Scope of Accreditation.		

	THE AMERICAN ASSOCIATION FOR LABORATORY ACCREDITATION
ACCREDITED PRODUCT CERTIFICATION BODY	
A2LA has accredited SIEMIC INC. San Jose, CA for technical competence as a Product Certification Body	
This product certification body is accredited in accordance with the recognized International Standard ISO/IEC Guide 65:1996 <i>General requirements for bodies operating product certification systems</i> . This accreditation demonstrates technical competence for a defined scope and the operation of a quality management system for a Telecommunications Certification Body (TCB) meeting FCC (U.S.), IDA (Singapore) and IC (Canada) requirements.	
	Presented this 9 th day of January 2009.  President For the Accreditation Council Certificate Number: 2742.02 Valid to: September 30, 2010
For the product certification schemes to which this accreditation applies, please refer to the certification body's Scope of Accreditation.	

SCOPE OF ACCREDITATION TO ISO/IEC GUIDE 65:1996

SIEMIC INC.
2206 Ringwood Ave.
San Jose, CA 95131
Mr. Snell Leong (Authorized Representative) Phone: 408 526 1188
www.siemic.com

PRODUCT CERTIFICATION CONFORMITY ASSESSMENT BODY (CAB)

Valid to: September 30, 2010

Certificate Number: 2742.02

In recognition of the successful completion of the A2LA Certification Body Accreditation Program evaluation, including the US Federal Communications Commission (FCC), Industry Canada (IC) and Singapore (IDA) requirements for the indicated types of product certifications, accreditation is granted to this organization to perform the following product certification schemes:

Economy

Scope

Federal Communication Commission - (FCC)

Unlicensed Radio Frequency Devices	A1, A2, A3, A4
Licensed Radio Frequency Devices	B1, B2, B3, B4
Telephone Terminal Equipment	C

**Please refer to FCC TCB Program Roles and Responsibilities, v04, released February 14, 2008 detailing scopes, roles and responsibilities. <http://www.fcc.gov/oet/ea/FCC-Overview-TCB-Program.pdf>*

Industry Canada - (IC)

Radio	All Radio Standards Specifications (RSS) in Category I Equipment Standards List Radio
-------	--

**Please refer to Industry Canada (IC) website at: http://www.ic.gc.ca/epic/site/smt-gst.nsf/en/n_sf01342e.html*

IDA – Singapore

Line Terminal Equipment	All Technical Specifications for Line Terminal Equipment – Table 1 of IDA MRA Recognition Scheme: 2008, Annex 2
Radio-Communication Equipment	All Technical Specifications for Radio-Communication Equipment – Table 2 of IDA MRA Recognition Scheme: 2008, Annex 2

**Please refer to Info-Communication Development Authority (IDA) Singapore website at:
http://www.ida.gov.sg/doc/Policies%20and%20Regulation/Policies_and_Regulation_Level2/20060609145118/MRA_RecScheme.pdf*

SIEMIC ACREDITATION DETAILS: FCC Test Site Registration No. 783147

FEDERAL COMMUNICATIONS COMMISSION

**Laboratory Division
7435 Oakland Mills Road
Columbia, MD 21046**

December 20, 2007

Registration Number: 783147

SIEMIC Laboratories
2206 Ringwood Avenue,
San Jose, CA 95131

Attention: Leslie Bai

Re: Measurement facility located at San Jose
3 & 10 meter site
Date of Renewal: December 20, 2007

Dear Sir or Madam:

Your request for renewal of the registration of the subject measurement facility has been received. The information submitted has been placed in your file and the registration has been renewed. The name of your organization will remain on the list of facilities whose measurement data will be accepted in conjunction with applications for Certification under Parts 15 or 18 of the Commission's Rules. Please note that the file must be updated for any changes made to the facility and the registration must be renewed at least every three years.

Measurement facilities that have indicated that they are available to the public to perform measurement services on a fee basis may be found on the FCC website www.fcc.gov under E-Filing, OET Equipment Authorization Electronic Filing, Test Firms.

Sincerely,

Phyllis Parrish
Industry Analyst

SIEMIC ACREDITATION DETAILS: Industry of Canada CAB ID : US0160



UNITED STATES DEPARTMENT OF COMMERCE
National Institute of Standards and Technology
Gaithersburg, Maryland 20899-

March 4, 2009

Mr. Leslie Bai
SIEMIC, Inc.
2206 Ringwood Avenue
San Jose, CA 95131

Dear Mr. Bai:

NIST is pleased to inform you that your laboratory has been recognized by Industry Canada (IC), under the Asia Pacific Economic Cooperation for Telecommunications Equipment Mutual Recognition Arrangement (APEC Tel MRA). Your laboratory is now designated to act as a Conformity Assessment Body (CAB) under Appendix B, **Phase I** Procedures, of the APEC Tel MRA. The pertinent information about your laboratory's designation is as follows:

CAB Name: SIEMIC, Inc.
Physical Location: 2206 Ringwood Avenue, San Jose, CA 95131 USA
Identification No.: US0160
Recognized Scope: CS-03 Part I, II, V, VI, VII and VIII

You may submit test data to IC to verify that the equipment to be imported into Canada satisfies the applicable requirements. The designation of your organization will remain in force as long as its accreditation for the designated scope remains valid and comply with the designation requirements.

Recognized CABs are listed on the NIST website at <http://ts.nist.gov/mra>. Please contact Ms. Ramona Saar at (301) 975-5521 or ramona.saar@nist.gov if you have any questions.

Sincerely,



David F. Alderman
Group Leader, Standards Coordination and Conformity Group
Standards Services Division

Enclosure

cc: CAB Program Manager

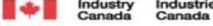

SIEMIC ACREDITATION DETAILS: Industry of Canada Test Site Registration No. 4842-1

 <p>May 23rd, 2008</p> <p>Siemic Inc. 2206 Ringwood Ave. San Jose CA 95131 USA</p> <p>Attention: Leslie Bai</p> <p>Dear Sir/Madame:</p>	<p>OUR FILE: 46405-4842 Submission No: 126429</p> <p>The Bureau has received your application for the registration / renewal of a 3/10m OATS. Be advised that the information received was satisfactory to Industry Canada. The following number(s) is now associated to the site(s) for which registration / renewal was sought (4842A-1). Please reference the appropriate site number in the body of test reports containing measurements performed on the site. In addition, please be informed that the Bureau is now utilizing a new site numbering scheme in order to simplify the electronic filing process. Our goal is to reduce the number of secondary codes associated to one particular company. The following changes have been made to your record.</p> <ul style="list-style-type: none"> - Your primary code is: 4842 - The company number associated to the site(s) located at the above address is: 4842A - The table below is a summary of the changes made to the unique site registration number(s): <table border="1" style="width: 100%; border-collapse: collapse; text-align: center;"> <thead> <tr> <th style="width: 25%;">New Site Number</th> <th style="width: 25%;">Obsolete Site Number</th> <th style="width: 40%;">Description of Site</th> <th style="width: 10%;">Expiry Date (YYYY-MM-DD)</th> </tr> </thead> <tbody> <tr> <td>4842A-1</td> <td>4842-1</td> <td>3m Chamber</td> <td>2010-05-23</td> </tr> </tbody> </table> <p>Furthermore, to obtain or renew a unique site number, the applicant shall demonstrate that the site has been accredited to ANSI C63.4-2003 or later. A scope of accreditation indicating the accreditation by a recognized accreditation body to ANSI C63.4-2003 shall be accepted. Please indicate in a letter the previous assigned site number if applicable and the type of site (example: 3 meter OATS or 3 meter chamber). If the test facility is not accredited to ANSI C63.4-2003 or later, the test facility shall submit test data demonstrating full compliance with the ANSI standard. The Bureau will evaluate the filing to determine if recognition shall be granted.</p> <p>The frequency for re-validation of the test site and the information that is required to be filed or retained by the testing party shall comply with the requirements established by the accrediting organization. However, in all cases, test site re-validation shall occur on an interval not to exceed two years. There is no fee or form associated with an OATS filing. OATS submissions are encouraged to be submitted electronically to the Bureau using the following URL: http://strategis.ic.gc.ca/epic/internet/inceb-bhst.nsf/en/h_tt00052e.html.</p> <p>If you have any questions, you may contact the Bureau by e-mail at certification.bureau@ic.gc.ca Please reference our file and submission number above for all correspondence.</p> <p>Yours sincerely,</p> <div style="text-align: center; margin-top: 20px;">  </div> <p>S. Proulx Test & Measurement Specialist Certification and Engineering Bureau 3701 Carling Ave., Building 94 Ottawa, Ontario K2H 8S2</p>	New Site Number	Obsolete Site Number	Description of Site	Expiry Date (YYYY-MM-DD)	4842A-1	4842-1	3m Chamber	2010-05-23
New Site Number	Obsolete Site Number	Description of Site	Expiry Date (YYYY-MM-DD)						
4842A-1	4842-1	3m Chamber	2010-05-23						

SIEMIC ACREDITATION DETAILS: FCC DOC CAB Recognition : US1109

FEDERAL COMMUNICATIONS COMMISSION

**Laboratory Division
7435 Oakland Mills Road
Columbia, MD 21046**

August 28, 2008

Siemic Laboratories
2206 Ringwood Ave.,
San Jose, CA 95131

Attention: Leslie Bai

Re: Accreditation of Siemic Laboratories
Designation Number: US1109
Test Firm Registration #: 540430

Dear Sir or Madam:

We have been notified by American Association for Laboratory Accreditation that Siemic Laboratories has been accredited as a Conformity Assessment Body (CAB).

At this time Siemic Laboratories is hereby designated to perform compliance testing on equipment subject to Declaration Of Conformity (DOC) and Certification under Parts 15 and 18 of the Commission's Rules.

This designation will expire upon expiration of the accreditation or notification of withdrawal of designation.

Sincerely,

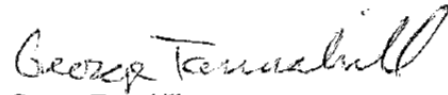

George Tannahill
Electronics Engineer

SIEMIC ACREDITATION DETAILS: Australia CAB ID : US0160



UNITED STATES DEPARTMENT OF COMMERCE
National Institute of Standards and Technology
Gaithersburg, Maryland 20899-

November 20, 2008

Mr. Leslie Bai
SIEMIC, Inc.
2206 Ringwood Avenue
San Jose, CA 95131

Dear Mr. Bai:

NIST is pleased to inform you that your laboratory has been recognized by the Australian Communications and Media Authority (ACMA) under the Asia Pacific Economic Cooperation for Telecommunications Equipment Mutual Recognition Arrangement (APEC Tel MRA). Your laboratory is now designated to act as a Conformity Assessment Body (CAB) under Appendix B, **Phase I** Procedures, of the APEC Tel MRA. The pertinent information about your laboratory's designation is as follows:

CAB Name: Siemic, Inc.
Physical Location: 2206 Ringwood Avenue, San Jose, CA 95131
Identification No.: US0160
Recognized Scope: EMC: AS/NZS 4251.1 (until 5/31/2009), AS/NZS 4251.2 (until 5/31/2009), AS/NZS CISPR 11, AS/NZS CISPR 14.1, AS/NZS CISPR 22, AS/NZS 61000.6.3, AS/NZS 61000.6.4
Radiocommunications: AS/NZS 4281, AS/NZS 4268, AS/NZS 4280.1, AS/NZS 4280.2, AS/NZS 4295, AS/NZS 4582, AS/NZS 4583, AS/NZS 4769.1, AS/NZS 4769.2, AS/NZS 4770, AS/NZS 4771
Telecommunications: AS/ACIF S002:05, AS/ACIF S003:06, AS/ACIF S004:06, AS/ACIF S006:01, AS/ACIF S016:01, AS/ACIF S031:01, AS/ACIF S038:01, AS/ACIF S040:01, AS/ACIF S041:05, AS/ACIF S043.2:06, AS/NZS 60950.1

You may submit test data to ACMA to verify that the equipment to be imported into Australia satisfies the applicable requirements. The designation of your organization will remain in force as long as its accreditation for the designated scope remains valid and comply with the designation requirements. Recognized CABs are listed on the NIST website at <http://ts.nist.gov/mra>. Please contact Ms. Ramona Saar, at (301) 975-5521 or ramona.saar@nist.gov if you have questions.

Sincerely,

David F. Alderman
Group Leader, Standards Coordination and Conformity Group
Standards Services Division

Enclosure

cc: Snell Leong, Siemic, Inc.; Ramona Saar, NIST



SIEMIC ACREDITATION DETAILS: Korea CAB ID: US0160



UNITED STATES DEPARTMENT OF COMMERCE
National Institute of Standards and Technology
Gaithersburg, Maryland 20899

October 1, 2008

Mr. Leslie Bai
SIEMIC, Inc.
2206 Ringwood Avenue
San Jose, CA 95131

Dear Mr. Bai:

NIST is pleased to inform you that your laboratory has been recognized by the Radio Research Agency (RRA) Korea Communications Commission (KCC) under the Asia Pacific Economic Cooperation for Telecommunications Equipment Mutual Recognition Arrangement (APEC Tel MRA). Your laboratory is now designated to act as a Conformity Assessment Body (CAB) under Appendix B, **Phase I** Procedures, of the APEC Tel MRA. The pertinent information about your laboratory's designation is as follows:

CAB Name: SIEMIC, Inc.
Physical Location: 2206 Ringwood Avenue, San Jose, CA 95131
Identification No.: US0160
Recognized Scope: **EMI:** KCC Notice 2008-39, RRL Notice 2008-3: CA Procedures for EMI
KN22: Test Method for EMI
EMS: KCC Notice 2008-38, RRL Notice 2008-4: CA Procedures for EMS
KN24, KN-61000-4-2, -4-3, -4-4, -4-5, -4-6, -4-8, -4-11: Test Method for EMS
Wireless: RRL Notice 2008-26, RRL Notice 2008-2, RRL Notice 2008-10,
RRL Notice 2007-49, RRL Notice 2007-20, RRL Notice 2007-21,
RRL Notice 2007-80, RRL Notice 2004-68
Wired: President Notice 20664, RRL Notice 2007-30,
RRL Notice 2008-7 with attachments 1, 3, 5, 6
President Notice 20664, RRL Notice 2008-7 with attachment 4

You may submit test data to RRA/KCC to verify that the equipment to be imported into Korea satisfies the applicable requirements. The designation of your organization will remain in force as long as its accreditation for the designated scope remains valid and comply with the designation requirements.

Recognized CABs are listed on the NIST website at <http://ts.nist.gov/mra>. If you have any questions please contact Ramona Saar at (301) 975-5521 or ramona.saar@nist.gov.

Sincerely,

David F. Alderman
Group Leader, Standards Coordination and Conformity Group
Standards Services Division

Enclosure

cc: Ramona Saar





SIEMIC ACREDITATION DETAILS: Taiwan BSMI Accreditation No. SL2-IN-E-1130R



UNITED STATES DEPARTMENT OF COMMERCE
National Institute of Standards and Technology
Gaithersburg, Maryland 20899

May 3, 2006

Mr. Leslie Bai
SIEMIC Laboratories
2206 Ringwood Avenue
San Jose, CA 95131

Dear Mr. Bai:

I am pleased to inform you that your laboratory has been recognized by the Chinese Taipei's Bureau of Standards, Metrology, and Inspection (BSMI) under the Asia Pacific Economic Cooperation (APEC) Mutual Recognition Arrangement (MRA). Your laboratory is now designated to act as a Conformity Assessment Body (CAB) under Appendix B, **Phase I** Procedures, of the APEC Tel MRA. You may submit test data to BSMI to verify that the equipment to be imported into Chinese Taipei satisfies the applicable requirements. The designation of your organization will remain in force as long as its accreditation for the designated scope remains valid and comply with the designation requirements. The pertinent designation information is as follows:

- BSMI number: **SL2-IN-E-1130R** (Must be applied to the test reports)
- U.S. Identification No: **US0160**
- Scope of Designation: **CNS 13438**
- Authorized signatory: **Mr. Leslie Bai**

The names of all recognized CABs will be posted on the NIST website at <http://ts.nist.gov/mra>. If you have any questions, please contact Mr. Dhillon at 301-975-5521. We appreciate your continued interest in our international conformity assessment activities.

Sincerely,

David F. Alderman
Group Leader, Standards Coordination and Conformity Group

cc: Jogindar Dhillon

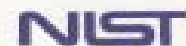

SIEMIC ACREDITATION DETAILS: Taiwan NCC CAB ID: US0160



UNITED STATES DEPARTMENT OF COMMERCE
National Institute of Standards and Technology
Gaithersburg, Maryland 20899

November 25, 2008

Mr. Leslie Bai
SIEMIC, Inc.
2206 Ringwood Avenue
San Jose, CA 95131

Dear Mr. Bai:

NIST is pleased to inform you that your laboratory has been recognized by the National Communications Commission (NCC) for the requested scope expansion under the Asia Pacific Economic Cooperation for Telecommunications Equipment Mutual Recognition Arrangement (APEC Tel MRA). Your laboratory is designated to act as a Conformity Assessment Body (CAB) under Appendix B, **Phase I** Procedures, of the APEC Tel MRA. The pertinent information about your laboratory's designation is as follows:

CAB Name: SIEMIC, Inc.
Physical Location: 2206 Ringwood Avenue, San Jose, CA 95131
Identification No.: US0160
Current Scope: LP0002
Additional Scope: PSTN01, ADSL01, ID0002, IS6100 and CNS 14336

You may submit test data to NCC to verify that the equipment to be imported into China satisfies the applicable requirements. The designation of your organization will remain in force as long as its accreditation for the designated scope remains valid and comply with the designation requirements.

Recognized CABs are listed on the NIST website at <http://ts.nist.gov/mra>. If you have any questions please contact Ramona Saar at (301) 975-5521 or ramona.saar@nist.gov.

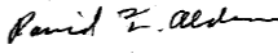
Sincerely,

David F. Alderman
Group Leader, Standards Coordination and Conformity Group
Standards Services Division

Enclosure

cc: Ramona Saar

NIST



SIEMIC, Inc.

Accessing global markets

Title: RF Test Report of HID Global Corporation
Model : R10D
To: FCC 15.225 2010, RSS-210 Issue 7: 2007

Serial# SL10071904-HID-012_R10D (FCC,IC)
Issue Date November 15 2010
Page 48 of 54
www.siemic.com

SIEMIC ACREDITATION DETAILS: Mexico NOM Recognition



CAMARA NACIONAL
DE LA INDUSTRIA
ELECTRONICA, DE
TELECOMUNICACIONES
E INFORMATICA

Laboratorio Valentín V. Rivero

México D.F. a 16 de octubre de 2006.

**LESLIE BAI
DIRECTOR OF CERTIFICATION
SIEMIC LABORATORIES, INC.
ACCESSING GLOBAL MARKETS
P R E S E N T E**

En contestación a su escrito de fecha 5 de septiembre del año en curso, le comento que estamos muy interesados en su intención de firmar un Acuerdo de Reconocimiento Mutuo, para lo cual adjunto a este escrito encontrara el Acuerdo en idioma inglés y español prellenado de los cuales le pido sea revisado y en su caso corregido, para que si esta de acuerdo poder firmarlo para mandarlo con las autoridades Mexicanas para su visto bueno y así poder ejercer dicho acuerdo.

Aprovecho este escrito para mencionarle que nuestro intermediario gestor será la empresa Isabel de México, S. A. de C. V., empresa que ha colaborado durante mucho tiempo con nosotros en lo relacionado a la evaluación de la conformidad y que cuenta con amplia experiencia en la gestión de la certificación de cumplimiento con Normas Oficiales Mexicanas de producto en México.

Me despido de usted enviándole un cordial saludo y esperando sus comentarios al Acuerdo que nos ocupa.

Atentamente:

**Ing. Faustino Gómez González
Gerente Técnico del Laboratorio de
CANIETI.**

Callejón T1
Hidromex Comidea
06100 Méxco. D.F.
Tel. 5264 6036 con 12 líneas
Fax 5264 6498
www.caniet.org

SIEMIC ACREDITATION DETAILS: Hong Kong OFTA CAB ID : US0160



UNITED STATES DEPARTMENT OF COMMERCE
National Institute of Standards and Technology
Gaithersburg, Maryland 20899

December 8, 2008

Mr. Leslie Bai
SIEMIC, Inc.
2206 Ringwood Avenue
San Jose, CA 95131

Dear Mr. Bai:

NIST is pleased to inform you that your laboratory has been recognized by the Office of the Telecommunications Authority (OFTA) under the Asia Pacific Economic Cooperation for Telecommunications Equipment Mutual Recognition Arrangement (APEC Tel MRA). Your laboratory is now designated to act as a Conformity Assessment Body (CAB) under Appendix B, **Phase I** Procedures, of the APEC Tel MRA. The pertinent information about your laboratory's designation is as follows:

CAB Name: SIEMIC, Inc.
Physical Location: 2206 Ringwood Avenue, San Jose, California 95131 USA
Identification No.: US0160
Recognized Scope: **Radio:** HKTA 1002, 1007, 1008, 1010, 1015, 1016, 1020, 1022, 1026, 1027, 1029, 1030, 1031, 1032, 1033, 1034, 1035, 1036, 1037, 1039, 1041, 1042, 1043, 1044, 1046, 1047, 1048, 1049, 1051
Telecom: HKTA 2011, 2012, 2013, 2014, 2017, 2018, 2022, 2024, 2026, 2027, 2028, 2029, 2030, 2031, 2032, 2033

You may submit test data to OFTA to verify that the equipment to be imported into Hong Kong satisfies the applicable requirements. The designation of your organization will remain in force as long as its accreditation for the designated scope remains valid and comply with the designation requirements.

Recognized CABs are listed on the NIST website at <http://ts.nist.gov/mra>. If you have any questions please contact Ramona Saar at (301) 975-5521 or ramona.saar@nist.gov.

Sincerely,

David F. Alderman
Group Leader, Standards Coordination and Conformity Group
Standards Services Division

Enclosure

cc: Ramona Saar

SIEMIC ACREDITATION DETAILS: Australia ACMA CAB ID: US0160



UNITED STATES DEPARTMENT OF COMMERCE
National Institute of Standards and Technology
Gaithersburg, Maryland 20899

November 20, 2008

Mr. Leslie Bai
SIEMIC, Inc.
2206 Ringwood Avenue
San Jose, CA 95131

Dear Mr. Bai:

NIST is pleased to inform you that your laboratory has been recognized by the Australian Communications and Media Authority (ACMA) under the Asia Pacific Economic Cooperation for Telecommunications Equipment Mutual Recognition Arrangement (APEC Tel MRA). Your laboratory is now designated to act as a Conformity Assessment Body (CAB) under Appendix B, **Phase I** Procedures, of the APEC Tel MRA. The pertinent information about your laboratory's designation is as follows:

CAB Name: Siemic, Inc.
Physical Location: 2206 Ringwood Avenue, San Jose, CA 95131
Identification No.: US0160
Recognized Scope: EMC: AS/NZS 4251.1 (until 5/31/2009), AS/NZS 4251.2 (until 5/31/2009), AS/NZS CISPR 11, AS/NZS CISPR 14.1, AS/NZS CISPR 22, AS/NZS 61000.6.3, AS/NZS 61000.6.4
Radiocommunications: AS/NZS 4281, AS/NZS 4268, AS/NZS 4280.1, AS/NZS 4280.2, AS/NZS 4295, AS/NZS 4582, AS/NZS 4583, AS/NZS 4769.1, AS/NZS 4769.2, AS/NZS 4770, AS/NZS 4771
Telecommunications: AS/ACIF S002:05, AS/ACIF S003:06, AS/ACIF S004:06, AS/ACIF S006:01, AS/ACIF S016:01, AS/ACIF S031:01, AS/ACIF S038:01, AS/ACIF S040:01, AS/ACIF S041:05, AS/ACIF S043.2:06, AS/NZS 60950.1

You may submit test data to ACMA to verify that the equipment to be imported into Australia satisfies the applicable requirements. The designation of your organization will remain in force as long as its accreditation for the designated scope remains valid and comply with the designation requirements. Recognized CABs are listed on the NIST website at <http://ts.nist.gov/mra>. Please contact Ms. Ramona Saar, at (301) 975-5521 or ramona.saar@nist.gov if you have questions.

Sincerely,

David F. Alderman
Group Leader, Standards Coordination and Conformity Group
Standards Services Division

Enclosure

cc: Snell Leong, Siemic, Inc.; Ramona Saar, NIST



SIEMIC ACREDITATION DETAILS: Australia NATA Recognition



Leslie Bai
SIEMIC, Inc.
2206 Ringwood Avenue
San Jose, CA 95131

November 4, 2008

Under Australian government legislation, the Australian Communications and Media Authority (ACMA) has determined the National Association of Testing Authorities, Australia (NATA) as an accreditation body as per Section 409(1) of the Telecommunications Act 1997 (Cth). Pursuant to Section 409(2) of the Telecommunications Act 1997 (Cth), I am pleased to advise that your laboratory has been determined as a Recognised Testing Authority (RTA).

This determination has been made on the basis of your accreditation by A2LA accreditation no. 2742.01 and the Mutual Recognition Agreement between NATA and A2LA. It is effective from 11 July 2008. RTA status applies only to the following standards and is contingent upon their continued inclusion in your laboratory's scope of accreditation.

**AS/ACIF S002, AS/ACIF S003, AS/ACIF S004,
AS/ACIF S006, AS/ACIF S016, AS/ACIF S031,
AS/ACIF S038, AS/ACIF S041 and
AS/ACIF S043.2**

As an RTA, your laboratory has the following obligations:

1. the laboratory shall continue to meet all of the accreditation criteria of A2LA;
2. the authorised representative of the laboratory shall notify NATA of changes to the staff or operations of the laboratory which would affect the performance of the tests for which the laboratory has been determined;
3. compliance of equipment shall be reported on test reports bearing the A2LA logo/endorsement.

Current information on the Australian Communications and Media Authority and regulatory requirements for telecommunications products within Australia can be obtained from the ACMA's web-site at "<http://www.acma.gov.au>". Further information about NATA may be gained by visiting "<http://www.nata.asn.au>".

Please note that AS/ACIF S040 and New Zealand standards do not form part of the RTA scheme.

Your RTA listing will appear on the NATA website shortly.

Kind Regards

Chris Norton,
Senior Scientific Officer
Measurement Science and Technology
National Association of Testing Authorities (NATA)
71-73 Flemington Road
North Melbourne Vic 3051
Australia
Ph: +61 3 9329 1633 Fx: +61 3 9326 5148
E-Mail: Christopher.Norton@nata.asn.au
Internet: www.nata.asn.au

SIEMIC ACREDITATION DETAILS: VCCI Radiated Test Site Registration No. R-3083

 
VCCI Council

CERTIFICATE

Company: SIEMIC Inc.
<Member No. 3081 >

Facility: SIEMIC Inc.
(Radiation 3 meter site)

Location of Facility:
2206 Ringwood Avenue, San Jose, CA 95131 USA

*This is to certify that the following measuring facility
has been registered in accordance with the Rules
for Voluntary Control Measures*

Registration No.: R-3083
Date of Registration: June 12 , 2009
This Certificate is valid until September 30 , 2010

VCCI Council 

SIEMIC ACREDITATION DETAILS: VCCI Conducted (Main Port) Test Site Registration No. C-3421

 
VCCI Council

CERTIFICATE

Company: SIEMIC Inc.
<Member No. 3081 >

Facility: SIEMIC Inc.
(Main Ports Conducted Interference Measurement)

Location of Facility:
2206 Ringwood Avenue, San Jose, CA 95131 USA

*This is to certify that the following measuring facility
has been registered in accordance with the Rules
for Voluntary Control Measures*

Registration No.: C-3421
Date of Registration: June 12 , 2009
This Certificate is valid until September 30 , 2010

VCCI Council 

SIEMIC ACREDITATION DETAILS: VCCI Conducted (Telecom Port) Test Site Registration No. T-1597

 
VCCI Council

CERTIFICATE

Company: SIEMIC Inc.
<Member No. 3081 >

Facility: SIEMIC Inc.
(Telecommunication Ports Conducted Interference Measurement)

Location of Facility:
2206 Ringwood Avenue, San Jose, CA 95131 USA

*This is to certify that the following measuring facility
has been registered in accordance with the Rules
for Voluntary Control Measures*

Registration No.: T-1597
Date of Registration: June 12 , 2009
This Certificate is valid until September 30 , 2010

VCCI Council 