



HEADQUARTERS: 914 WEST PATAPSCO AVENUE • BALTIMORE, MARYLAND 21230 • PHONE (410) 354-3300 • FAX (410) 354-3313

2/22/2024

Lutron Electronics Co., Inc.
7200 Suter Rd.
Coopersburg, PA 18036
USA

Dear Keith Kennedy,

Enclosed is the EMC Wireless test report for compliance testing of the Lutron Electronics Co., Inc. UN-D2MEMTRXX as tested to the requirements of FCC Part 15.247 and RSS-247 Issue 3 for Intentional Radiators. This test report pertains specifically to the 802.15.4 transmitter onboard which operates in the 2400-2483.5MHz band.

Thank you for using the services of Eurofins MET Labs. If you have any questions regarding these results or if MET can be of further service to you, please feel free to contact me.

Sincerely yours,
EUROFINS MET LABS

A handwritten signature in blue ink that reads "Nancy LaBrecque". The signature is written in a cursive, flowing style.

Nancy LaBrecque
Documentation Department

Reference: WIRA130151-FCC-IC-2.4GHz-802.15.4-R2

Certificates and reports shall not be reproduced except in full, without the written permission of Eurofins MET Labs.

The Nation's First Licensed Nationally Recognized Testing Laboratory

Maryland | California | Texas
www.metlabs.com

**802.15.4 (2.4GHz Band)
Test Report**

for the

Lutron Electronics Co., Inc.
UN-D2MEMTRXX

Tested under
FCC Part 15.247 and RSS-247 Issue 3
For Intentional Radiators



Bryan Taylor, Wireless Team Lead
Electromagnetic Compatibility Lab



Nancy LaBrecque
Documentation Department

Engineering Statement: The measurements shown in this report were made in accordance with the procedures indicated, and the emissions from this equipment were found to be within the limits applicable. I assume full responsibility for the accuracy and completeness of these measurements, and for the qualifications of all persons taking them. It is further stated that upon the basis of the measurements made, the equipment tested is capable of operation in accordance with the requirements of the FCC Rules Part 15.247 under normal use and maintenance.



Matthew Hinojosa
EMC Manager, Austin Electromagnetic Compatibility Lab

Report Status Sheet

Revision	Report Date	Reason for Revision
∅	1/18/2024	Initial Issue.
1	1/29/2024	Made updates requested by client
2	2/22/2024	Made updates requested by client

Table of Contents

I.	Executive Summary	8
	A. Purpose of Test	9
	B. Executive Summary	9
II.	Equipment Configuration	10
	A. Overview	11
	B. References	12
	C. Test Site	13
	D. Measurement Uncertainty	13
	E. Description of Test Sample	13
	F. Equipment Configuration	14
	G. Support Equipment	14
	H. Mode of Operation	16
	I. Method of Monitoring EUT Operation	16
	J. Modifications	16
	a) Modifications to EUT	16
	b) Modifications to Test Standard	16
	K. Disposition of EUT	16
III.	Electromagnetic Compatibility Criteria for Intentional Radiators	17
	§ 15.203 Antenna Requirement	18
	§ 15.207(a) Conducted Emissions Limits	19
	§ 15.247(a)(a) 6 dB and 99% Bandwidth	22
	RSS-GEN (6.7) 99% Bandwidth	23
	§ 15.247(b) Peak Power Output	25
	§ 15.247(e) Peak Power Spectral Density	30
	§ 15.247(d) RF Conducted Spurious Emissions Requirements and Band Edge	34
	§ 15.247(d) Radiated Spurious Emissions Requirements and Band Edge	40
IV.	Test Equipment	55

List of Tables

Table 1. Executive Summary	9
Table 2. EUT Summary Table.....	11
Table 3. References	12
Table 4. Uncertainty Calculations Summary.....	13
Table 5. Support Equipment.....	14
Table 6. Ports and Cabling Information	15
Table 7. Test Channels Utilized	16
Table 8. Conducted Limits for Intentional Radiators from FCC Part 15 § 15.207(a)	19
Table 9. Conducted Emissions, 15.207(a), Phase, Test Results	20
Table 10. Conducted Emissions, 15.207(a), Neutral, Test Results	21
Table 11. 99% and 6 dB Occupied Bandwidth, Test Results	23
Table 12. Output Power Requirements from §15.247(b)	25
Table 13. Peak Power Output, Test Results	26
Table 14. Peak Power Spectral Density, Test Results	30
Table 15. Restricted Bands of Operation.....	40
Table 16. Radiated Emissions Limits Calculated from FCC Part 15, § 15.209 (a)	41
Table 17. Test Equipment List	56

List of Figures

Figure 1. Block Diagram of Test Configuration.....	14
Figure 2. Block Diagram, Occupied Bandwidth Test Setup.....	23
Figure 3. Peak Power Output Test Setup.....	26
Figure 5. Low Channel, Peak Power.....	27
Figure 5. Mid Channel, Peak Power.....	28
Figure 5. High Channel, Peak Power.....	29
Figure 4. Block Diagram, Peak Power Spectral Density Test Setup.....	30
Figure 5. Low Channel, Power Spectral Density.....	31
Figure 6. Mid Channel, Power Spectral Density.....	32
Figure 7. High Channel, Power Spectral Density.....	33
Figure 8. Block Diagram, Conducted Spurious Emissions Test Setup.....	34
Figure 9. Low Channel, 30MHz – 40GHz Conducted Spurious Emissions.....	35
Figure 10. Mid Channel, 30MHz – 40GHz Conducted Spurious Emissions.....	36
Figure 11. High Channel, 30MHz – 40GHz Conducted Spurious Emissions.....	37
Figure 12. Low Channel, Low Band Edge.....	38
Figure 13. High Channel, High Band Edge.....	39
Figure 14. Low Channel, 30MHz – 1GHz Restricted Band Spurious Emissions.....	42
Figure 15. Low Channel, 1GHz – 40GHz Restricted Band Spurious Emissions.....	43
Figure 16. Middle Channel, 30MHz – 1GHz Restricted Band Spurious Emissions.....	44
Figure 17. Middle Channel, 1GHz – 40GHz Restricted Band Spurious Emissions.....	45
Figure 18. High Channel, 30MHz – 1GHz Restricted Band Spurious Emissions.....	46
Figure 19. High Channel, 1GHz – 40GHz Restricted Band Spurious Emissions.....	47
Figure 20. Restricted Band Edge Spurious Emissions (Vertical Polarity).....	48
Figure 21. Restricted Band Edge Spurious Emissions (Horizontal Polarity).....	49
Figure 22. Worst Case Cabinet Radiation, Below 1GHz.....	50
Figure 23. Worst Case Cabinet Radiation, Above 1GHz.....	50
Figure 24. Worst Case Cabinet Radiation, 9kHz – 30MHz, Coaxial Loop.....	51
Figure 25. Worst Case Cabinet Radiation, 9kHz – 30MHz, Coplanar Loop.....	51
Figure 26. Worst Case Cabinet Radiation, 30MHz – 1GHz, Vertical Polarity.....	52
Figure 27. Worst Case Cabinet Radiation, 30MHz – 1GHz, Horizontal Polarity.....	52
Figure 28. Worst Case Cabinet Radiation, 1GHz – 18GHz, Vertical Polarity.....	53
Figure 29. Worst Case Cabinet Radiation, 1GHz – 18GHz, Horizontal Polarity.....	53
Figure 30. Worst Case Cabinet Radiation, 18GHz – 40GHz, Vertical Polarity.....	54
Figure 31. Worst Case Cabinet Radiation, 18GHz – 40GHz, Horizontal Polarity.....	54

List of Terms and Abbreviations

AC	Alternating Current
ACF	Antenna Correction Factor
Cal	Calibration
<i>d</i>	Measurement Distance
dB	Decibels
dB μ A	Decibels above one microamp
dB μ V	Decibels above one microvolt
dB μ A/m	Decibels above one microamp per meter
dB μ V/m	Decibels above one microvolt per meter
DC	Direct Current
E	Electric Field
DSL	Digital Subscriber Line
ESD	Electrostatic Discharge
EUT	Equipment Under Test
<i>f</i>	Frequency
FCC	Federal Communications Commission
GRP	Ground Reference Plane
H	Magnetic Field
HCP	Horizontal Coupling Plane
Hz	Hertz
IEC	International Electrotechnical Commission
kHz	kilohertz
kPa	kilopascal
kV	kilovolt
LISN	Line Impedance Stabilization Network
MHz	Megahertz
μ H	microhenry
μ	microfarad
μ s	microseconds
NEBS	Network Equipment-Building System
PRF	Pulse Repetition Frequency
RF	Radio Frequency
RMS	Root-Mean-Square
TWT	Traveling Wave Tube
V/m	Volts per meter
VCP	Vertical Coupling Plane

I. Executive Summary

A. Purpose of Test

An EMC evaluation was performed to determine compliance of the UN-D2MEMTRXX, with the requirements of FCC Part 15.247 and RSS-247 Issue 3. Lutron Electronics Co., Inc. should retain a copy of this document which should be kept on file for at least two years after the manufacturing of the UN-D2MEMTRXX, has been permanently discontinued.

B. Executive Summary

The following tests were conducted on a sample of the equipment for the purpose of demonstrating compliance with FCC Part 15.247 and RSS-247 Issue 3, in accordance with Lutron Electronics Co., Inc. purchase order number 5317304. All tests were conducted using measurement procedures ANSI C63.4-2014 and ANSI C63.10-2013.

FCC Reference 47 CFR Part 15.247:2005	IC Reference RSS-247 Issue 2: 2017; RSS-GEN Issue 5: 2018	Description	Compliance
Title 47 of the CFR, Part 15 §15.203	---	Antenna Requirement	Compliant
Title 47 of the CFR, Part 15 §15.207(a)	RSS-GEN(8.8)	Conducted Emission Limits	Compliant
Title 47 of the CFR, Part 15 §15.247(a)(2)	RSS-247 (5.2)	6dB Occupied Bandwidth	Compliant
---	RSS-GEN(6.7)	99% Occupied Bandwidth	Compliant
Title 47 of the CFR, Part 15 §15.247(b)	RSS-247(5.4)	Peak Power Output	Compliant
Title 47 of the CFR, Part 15 §15.247(d); §15.209; §15.205	RSS-GEN (6.13), (8.9), & (8.10)	Radiated Spurious Emissions Requirements	Compliant
Title 47 of the CFR, Part 15 §15.247(d)	RSS-247(5.5)	RF Conducted Spurious Emissions Requirements	Compliant
Title 47 of the CFR, Part 15; §15.247(e)	RSS-247(5.2)	Peak Power Spectral Density	Compliant

Table 1. Executive Summary

II. Equipment Configuration

A. Overview

Eurofins MET Labs was contracted by Lutron Electronics Co., Inc. to perform testing on the UN-D2MEMTRXX, under Lutron Electronics Co., Inc.’s purchase order number 5317304.

This document describes the test setups, test methods, required test equipment, and the test limit criteria used to perform compliance testing of the UN-D2MEMTRXX.

The results obtained relate only to the item(s) tested.

Product Name:	Universal D2 Module Emitter	
Model(s) Tested:	UN-D2MEMTRXX	
Model(s) Covered:	UN-D2MEMTRXX	
Serial Number or Sample Number:	Test Sample 1	
EUT Specifications:	Primary Power: 18 – 20VDC	
	Type of Modulations:	O-QPSK
	Equipment Code:	DTS
	Peak RF Output Power:	18.99dBm
	EUT Frequency Ranges:	2405MHz – 2480MHz
	Antenna Gain ¹ :	5dBi (monopole)
Analysis:	The results obtained relate only to the item(s) tested.	
Environmental Test Conditions:	Temperature: 15-35° C	
	Relative Humidity: 30-60%	
	Barometric Pressure: 860-1060 mbar	
Evaluated by:	Bryan Taylor	
Report Date(s):	12/21/2023 through 1/17/2024	

Table 2. EUT Summary Table

¹ The antenna gain information was provided by Lutron Electronics Co., Inc. and may affect compliance.

B. References

CFR 47, Part 15, Subpart C	Federal Communication Commission, Code of Federal Regulations, Title 47, Part 15: General Rules and Regulations, Allocation, Assignment, and Use of Radio Frequencies
RSS-247, Issue 3, August 2023	Digital Transmission Systems (DTSS), Frequency Hopping Systems (FHSs) and Licence-Exempt Local Area Network (LE-LAN) Devices
RSS-GEN, Issue 5, March 2019	General Requirements and Information for the Certification of Radio Apparatus
ANSI C63.4:2014	Methods and Measurements of Radio-Noise Emissions from Low-Voltage Electrical And Electronic Equipment in the Range of 9 kHz to 40 GHz
ISO/IEC 17025:2017	General Requirements for the Competence of Testing and Calibration Laboratories
ANSI C63.10-2013	American National Standard for Testing Unlicensed Wireless Devices

Table 3. References

C. Test Site

All testing was performed at Eurofins MET Labs, 13501 McCallen Pass, Austin, TX 78753. All equipment used in making physical determinations is accurate and bears recent traceability to the National Institute of Standards and Technology.

Radiated Emissions measurements were performed in a 10 meter semi-anechoic chamber (equivalent to an Open Area Test Site). In accordance with §2.948(a)(3), a complete site description is contained at MET Laboratories.

D. Measurement Uncertainty

Test Method	Typical Expanded Uncertainty	K	Confidence Level
RF Frequencies	±4.52 Hz	2	95%
RF Power Conducted Emissions	±2.97 dB	2	95%
RF Power Radiated Emissions	±2.95 dB	2	95%

Table 4. Uncertainty Calculations Summary

E. Description of Test Sample

The EUT is a DC voltage, fully color tunable, dimmable LED product with integrated wireless communication. It contains a RF transceiver (EFR32MG24) with a reference crystal (38.4MHz) and an antenna that cannot be changed by the user. The device is used as part of an integrated lighting system. The purpose of the wireless communication is to send commands to and receive status information back from a control system.

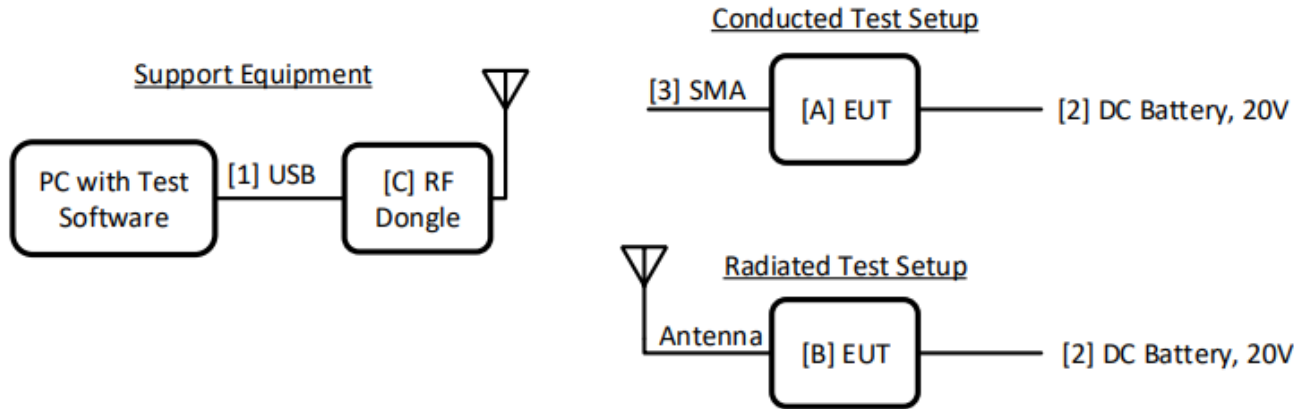

Figure 1. Block Diagram of Test Configuration

F. Equipment Configuration

The EUT was set up as outlined in Figure 1 above. The laptop computer was used to send test commands to force the transmitters to operate in the appropriate test mode.

G. Support Equipment

Support equipment necessary for the operation and testing of the EUT is included in the following list.

Ref. ID	Name / Description	Manufacturer	Model Number	Customer Supplied Calibration Data
None	Laptop Computer	Lenovo	ThinkPad	None
None	Lutron Radio Certification GUI	Lutron	Version 1.1.3	None

Table 5. Support Equipment

H. Ports and Cabling Information

Ref. ID	Name/Description	Model Number
A1	Conducted Test Unit	UN-D2MEMTRXX
A2	Backup - Conducted Test Unit	UN-D2MEMTRXX
B1	Radiated Test Unit	UN-D2MEMTRXX
B2	Backup - Radiated Test Unit	UN-D2MEMTRXX
C	RF Dongle	Digi USB
1	USB Cable - RF Dongle to Support PC	
2	DC supply cable from battery to DUT	
3	SMA Cable for conducted test ; 0.55 dB loss	

Table 6. Ports and Cabling Information

I. Mode of Operation

The transmitter uses the voltage-controlled oscillator, which is frequency modulated, and a power amplifier to produce the modulated carrier at 2.402GHz to 2.480GHz. The radio can switch between BLE 1Mbps(2.402GHz to 2.480GHz), BLE 2Mbps (2.402GHz to 2.480GHz) and 802.15.4 (2.405GHz to 2.480GHz) depending on the mode of operation. The modulation is either GFSK for BLE or O-QPSK for 802.15.4. The antenna is permanently attached and cannot be modified or replaced by the user.

User controlled Software is provided to enable the EUT to achieve 100% duty cycle during EMC testing in both BLE and 802.15.4 modes.

The support laptop provided a direct means of controlling transmitter parameters. Unless otherwise stated or shown, all tests were performed at worst-case modulation and data rates on the following channels.

Transmit Band	Modulation	Channel Frequencies Tested	Test Tool Power Setting ²
2400 – 2483.5MHz	802.15.4 (O-QPSK)	2405MHz / 2440MHz / 2480MHz	Product Default (20dBm)

Table 7. Test Channels Utilized

J. Method of Monitoring EUT Operation

A spectrum analyzer was used to confirm proper transmitter operation.

K. Modifications

a) Modifications to EUT

No modifications were made to the EUT.

b) Modifications to Test Standard

No modifications were made to the test standard.

L. Disposition of EUT

The test sample including all support equipment submitted to the Electro-Magnetic Compatibility Lab for testing was returned to Lutron Electronics Co., Inc. upon completion of testing.

² Note, the test tool power setting does not necessarily correspond to a power in dBm or Watts.

III. Electromagnetic Compatibility Criteria for Intentional Radiators

Electromagnetic Compatibility Criteria for Intentional Radiators

§ 15.203 Antenna Requirement

Test Requirement: § 15.203: An intentional radiator shall be designed to ensure that no antenna other than that furnished by the responsible party shall be used with the device. The use of a permanently attached antenna or of an antenna that uses a unique coupling to the intentional radiator shall be considered sufficient to comply with the provisions of this section. The manufacturer may design the unit so that a broken antenna can be replaced by the user, but the use of a standard antenna jack or electrical connector is prohibited.

The structure and application of the EUT were analyzed to determine compliance with Section 15.203 of the Rules. Section 15.203 states that the subject device must meet at least one of the following criteria:

- a.) Antenna must be permanently attached to the unit.
- b.) Antenna must use a unique type of connector to attach to the EUT.
- c.) Unit must be professionally installed. Installer shall be responsible for verifying that the correct antenna is employed with the unit.

Results: The EUT as tested is compliant the criteria of §15.203. The TX antenna is not accessible by the end user and it uses a unique coupling.

Test Engineer(s): Bryan Taylor

Test Date(s): 1/3/2024

Electromagnetic Compatibility Criteria for Intentional Radiators

§ 15.207(a) Conducted Emissions Limits

Test Requirement(s): § 15.207 (a): For an intentional radiator that is designed to be connected to the public utility (AC) power line, the radio frequency voltage that is conducted back onto the AC power line on any frequency or frequencies, within the band 150 kHz to 30MHz, shall not exceed the limits in the following table, as measured using a 50 μ H/50 Ω line impedance stabilization network (LISN). Compliance with the provisions of this paragraph shall be based on the measurement of the radio frequency voltage between each power line and ground at the power terminal. The lower limit applies at the boundary between the frequency ranges.

Frequency range (MHz)	§ 15.207(a), Conducted Limit (dB μ V)	
	Quasi-Peak	Average
0.15-0.5	66 - 56	56 - 46
0.5-5	56	46
5-30	60	50

Table 8. Conducted Limits for Intentional Radiators from FCC Part 15 § 15.207(a)

Test Procedure: The EUT was placed on a 0.8 m-high wooden table. The EUT was situated such that the back of the EUT was 0.4 m from one wall of the vertical ground plane, and the remaining sides of the EUT were no closer than 0.8 m from any other conductive surface. The EUT was powered from a 50 Ω /50 μ H Line Impedance Stabilization Network (LISN). The EMC receiver scanned the frequency range from 150 kHz to 30 MHz. Conducted Emissions measurements were made in accordance with ANSI C63.4-2014 "Methods and Measurements of Radio-Noise Emissions from Low-Voltage Electrical and Electronic Equipment in the Range of 9kHz to 40 GHz". The measurements were performed using a 50 Ω /50 μ H LISN as the input transducer to an EMI receiver. For the purpose of this testing, the transmitter was turned on.

Test Results: The EUT was compliant with this requirement. During these tests the Universal D2 Module Emitter was connected to a D2-PS-120 AC/DC power adapter.

Test Engineer(s): Michael Ermer

Test Date(s): 1/17/2024

15.207(a) Conducted Emissions Test Results

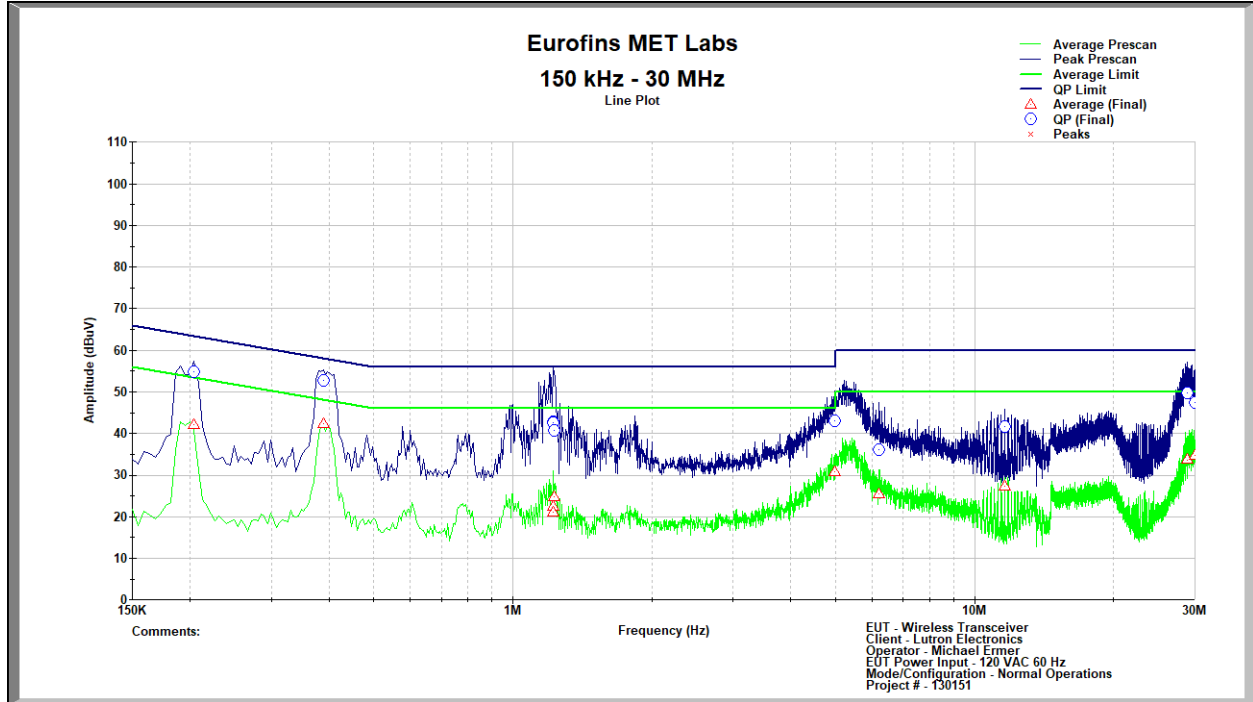

Conducted Emissions, 15.207(a), Phase

Frequency (MHz)	Quasi-Peak (dBµV/m)	Quasi-Peak Limit (dBµV/m)	Quasi-Peak Margin (dB)	Average (dBµV/m)	Average Limit (dBµV/m)	Average Margin (dB)
0.204	54.848	64.457	9.609	42.222	54.457	12.235
0.389	52.641	59.186	6.545	42.370	49.186	6.815
1.221	42.797	56.000	13.203	22.406	46.000	23.594
1.226	42.548	56.000	13.452	21.011	46.000	24.989
1.230	40.790	56.000	15.210	24.872	46.000	21.128
4.980	43.102	56.000	12.898	30.834	46.000	15.166
6.210	36.146	60.000	23.854	25.488	50.000	24.512
11.625	41.722	60.000	18.278	27.384	50.000	22.616
28.864	49.796	60.000	10.204	33.678	50.000	16.322
29.945	47.432	60.000	12.568	34.666	50.000	15.334

Table 9. Conducted Emissions, 15.207(a), Phase, Test Results

15.207(a) Conducted Emissions Test Results

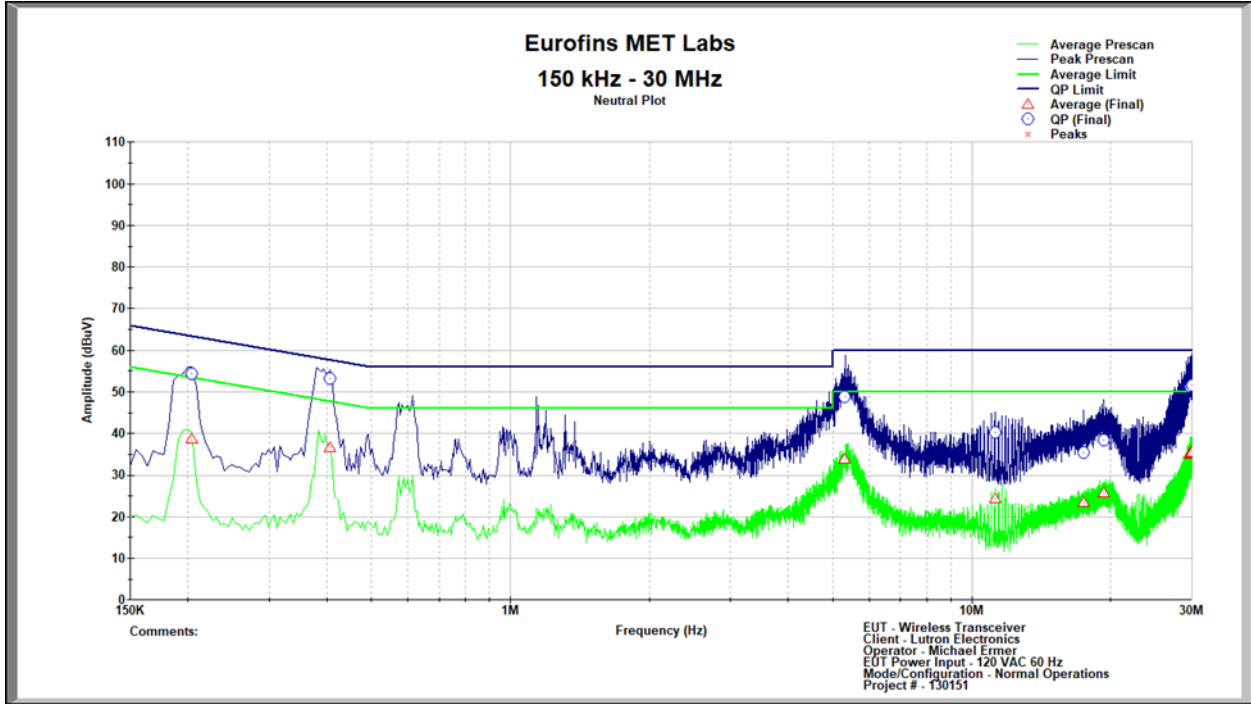

Conducted Emissions, 15.207(a), Neutral

Frequency (MHz)	Quasi-Peak (dBµV/m)	Quasi-Peak Limit (dBµV/m)	Quasi-Peak Margin (dB)	Average (dBµV/m)	Average Limit (dBµV/m)	Average Margin (dB)
0.204	54.423	64.457	10.034	38.544	54.457	15.913
0.406	53.328	58.671	5.343	36.640	48.671	12.031
5.309	48.828	60.000	11.172	33.795	50.000	16.205
11.225	40.318	60.000	19.682	24.404	50.000	25.596
17.438	35.506	60.000	24.494	23.327	50.000	26.673
19.302	38.464	60.000	21.536	25.610	50.000	24.390
29.679	51.513	60.000	8.487	35.036	50.000	14.964
29.720	51.325	60.000	8.675	35.210	50.000	14.790
29.899	51.858	60.000	8.142	35.445	50.000	14.555
29.976	51.776	60.000	8.224	35.486	50.000	14.514

Table 10. Conducted Emissions, 15.207(a), Neutral, Test Results

Electromagnetic Compatibility Criteria for Intentional Radiators

§ 15.247(a)(2) 6 dB Bandwidth

Test Requirements: § 15.247(a)(2): Operation under the provisions of this section is limited to frequency hopping and digitally modulated intentional radiators that comply with the following provisions:

For systems using digital modulation techniques, the EUT may operate in the 902-928 MHz, 2400-2483.5 MHz and 5725-5850 MHz bands. The minimum 6dB bandwidth shall be at least 500 kHz.

Test Procedure: The transmitter was on and transmitting at the highest output power. The bandwidth of the fundamental frequency was measured with the spectrum analyzer using a RBW approximately 1% of the total emission bandwidth, and the VBW > RBW. The 6 dB Bandwidth was measured and recorded. The measurements were performed on the low, mid and high channels.

Test Results The EUT was compliant with § 15.247 (a)(2).

The 6 dB Bandwidth was determined from the plots on the following pages.

Test Engineer(s): Bryan Taylor

Test Date(s): 1/8/2024

Electromagnetic Compatibility Criteria for Intentional Radiators

RSS-GEN (6.7) 99% Bandwidth

Test Requirements: The occupied bandwidth or the “99% emission bandwidth” is defined as the frequency rang between two points, one above and the other blow the carrier frequency, within which 99% of the total transmitted power of the fundamental transmitted emission is contained. The occupied bandwidth shall be reported for all equipment in addition to the specified bandwidth required in the applicable RSSs.

Test Procedure: The transmitter was connected to the spectrum analyzer through an attenuator. The bandwidth of the fundamental frequency was measured with the spectrum analyzer using a RBW approximately equal to 1% of the total emission bandwidth, and the VBW > RBW. The 99% Bandwidth was measured and recorded.

Test Results The 99% Bandwidth determined from the plots on the following pages.

Test Engineer(s): Bryan Taylor

Test Date(s): 1/8/2024

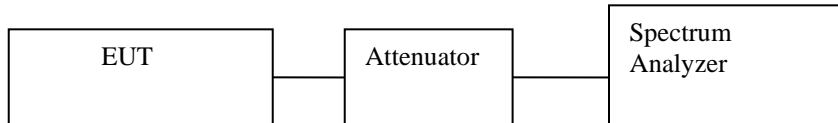
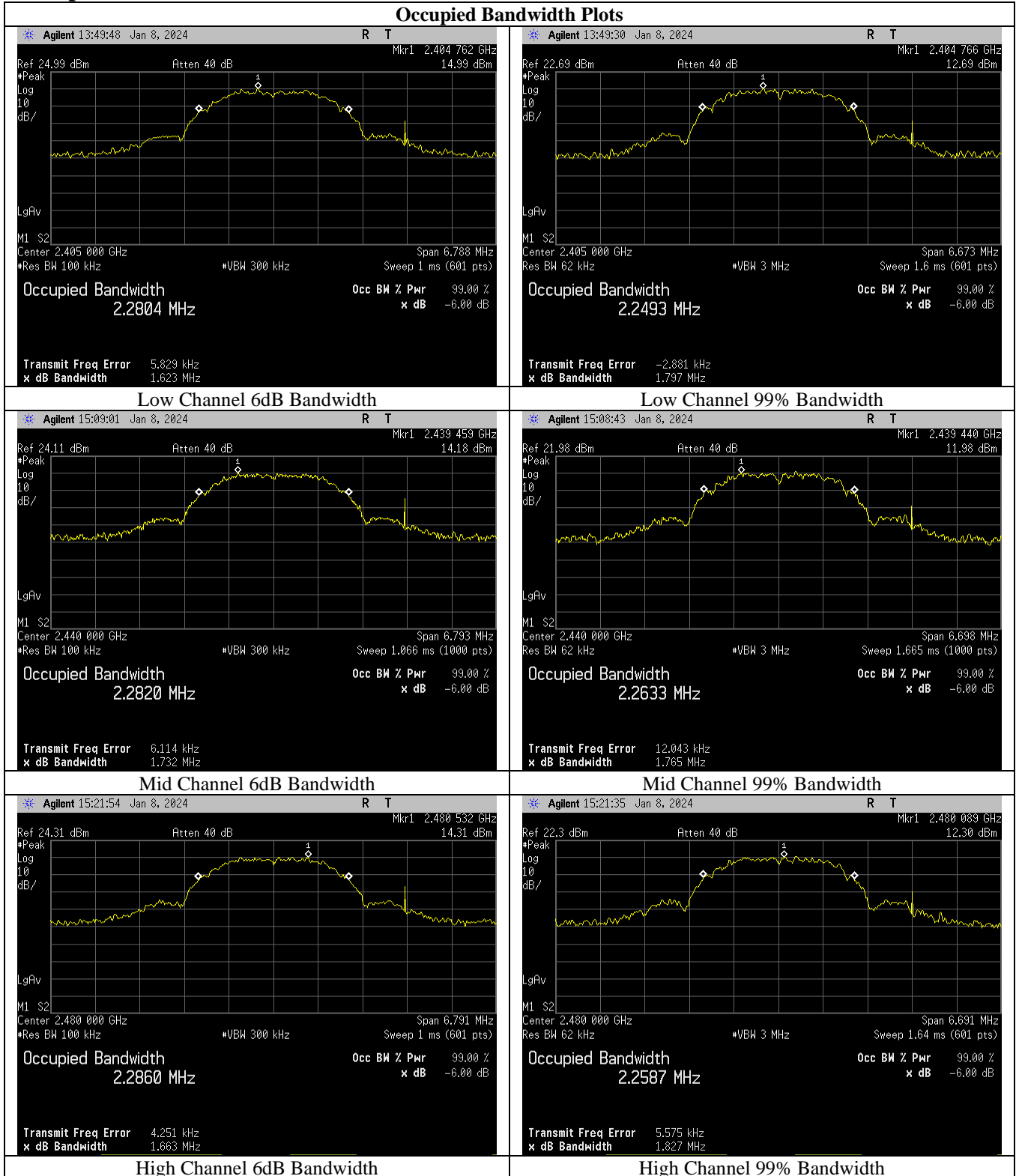

Figure 2. Block Diagram, Occupied Bandwidth Test Setup

Channel	Frequency (MHz)	6dB Bandwidth (MHz)	6dB Bandwidth Limit (MHz)	99% Bandwidth (MHz)	Result
Low	2405MHz	1.623MHz	0.5MHz	2.249MHz	Pass
Middle	2440MHz	1.732MHz	0.5MHz	2.263MHz	Pass
High	2480MHz	1.663MHz	0.5MHz	2.258MHz	Pass

Table 11. 99% and 6 dB Occupied Bandwidth, Test Results

Occupied Bandwidth Test Results



Electromagnetic Compatibility Criteria for Intentional Radiators

§ 15.247(b) Peak Power Output

Test Requirements: §15.247(b): The maximum peak output power of the intentional radiator shall not exceed the following:

Digital Transmission Systems (MHz)	Output Limit (Watts)
902-928	1.000
2400-2483.5	1.000
5725- 5850	1.000

Table 12. Output Power Requirements from §15.247(b)

§15.247(c): if transmitting antennas of directional gain greater than 6 dBi are used the peak output power from the intentional radiator shall be reduced below the stated values in the Table 12, as appropriate, by the amount in dB that the directional gain of the antenna exceeds 6 dBi.

Systems operating in the 2400 – 2483.5 MHz band and using a point to point application may employ transmitting antennas with directional gain greater than 6 dBi provided the maximum peak output power of the intentional radiator is reduced by 1 dB for every 3 dB that the directional gain of the antenna exceeds 6 dBi.

Systems operating in the 5725 – 5850 MHz band that are used exclusively for fixed, point-to-point operations may employ transmitting antennas with directional gain greater than 6 dBi without any corresponding reduction in transmitter peak output power.

Fixed, point-to-point operation excludes the use of point-to-multipoint systems, Omni-directional applications, and multiple co-located intentional radiators transmitting the same information. The operator of the spread spectrum intentional radiator or, if the equipment is professionally installed, the installer is responsible for ensuring that the system is used exclusively for fixed, point-to-point operations. The instruction manual furnished with the intentional radiator shall contain language in the installation instructions informing the operator and the installer of this responsibility.

Test Procedure: The transmitter was connected to a calibrated spectrum analyzer. The analyzer reference level was offset by cable loss connecting to the test sample. The peak power was measured at the low, mid and high channels of each band at the maximum power level.

Test Results: The EUT was compliant with the Peak Power Output limits of §15.247(b).

Test Engineer(s): Bryan Taylor

Test Date(s): 1/8/2024

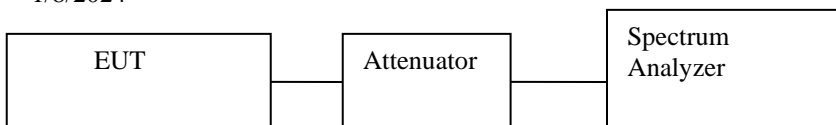

Figure 3. Peak Power Output Test Setup

Peak Power Output Test Results

Channel	Frequency (MHz)	Peak Power (dBm)	Peak Power Limit (dBm)	Result
Low	2405MHz	18.81	30	Pass
Middle	2440MHz	18.90	30	Pass
High	2480MHz	18.99	30	Pass

Table 13. Peak Power Output, Test Results

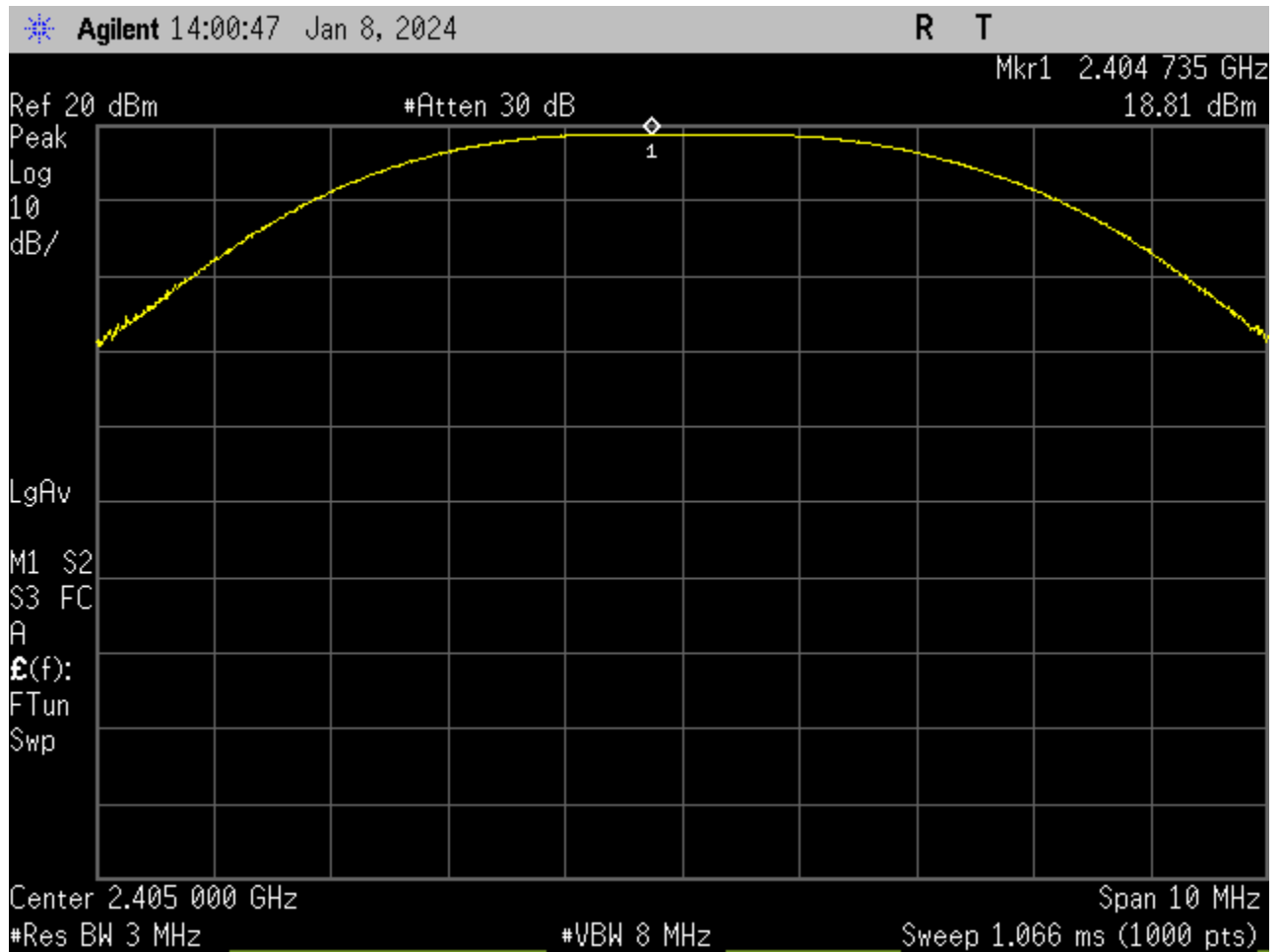

Figure 4. Low Channel, Peak Power

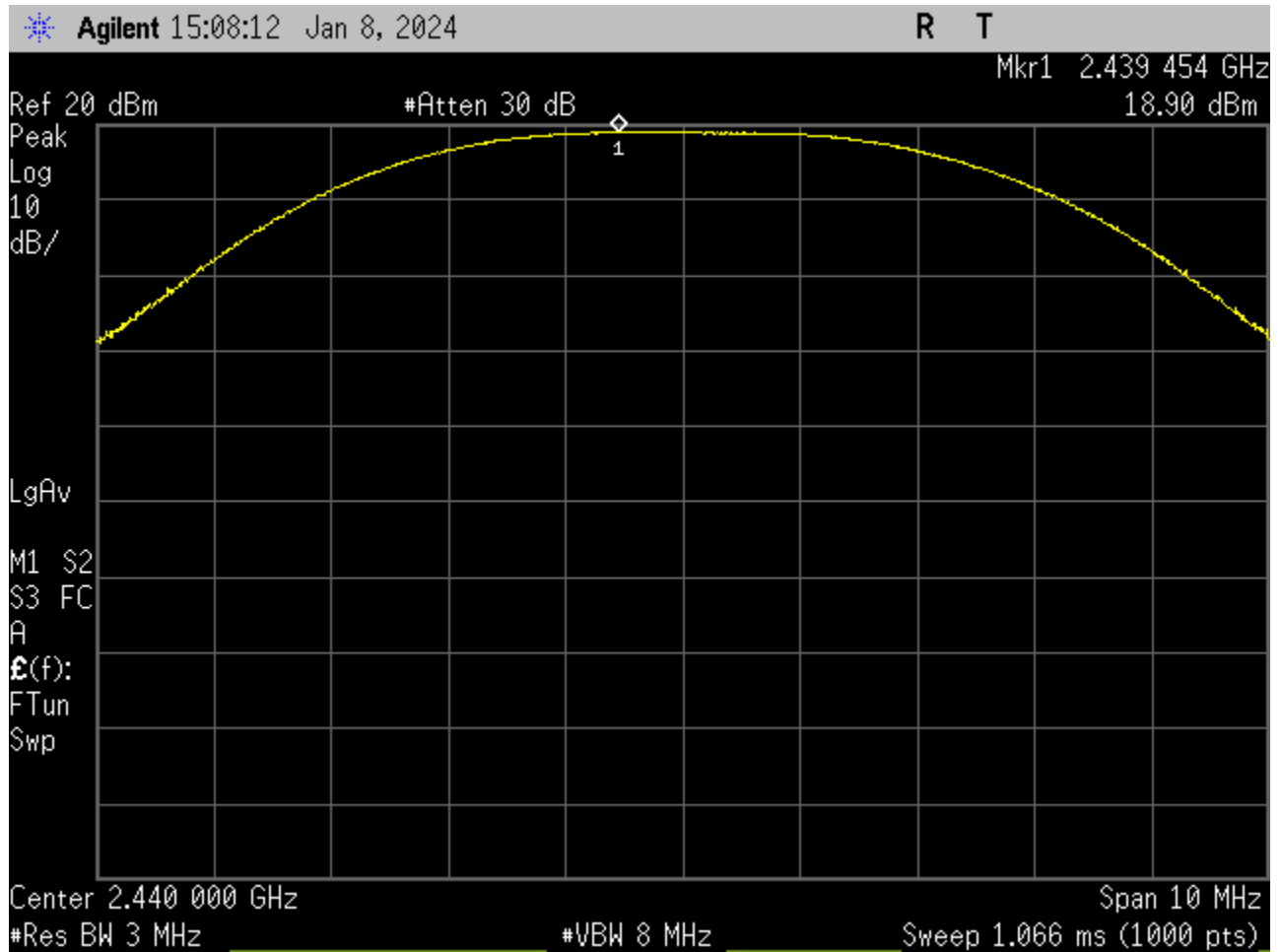

Figure 5. Mid Channel, Peak Power

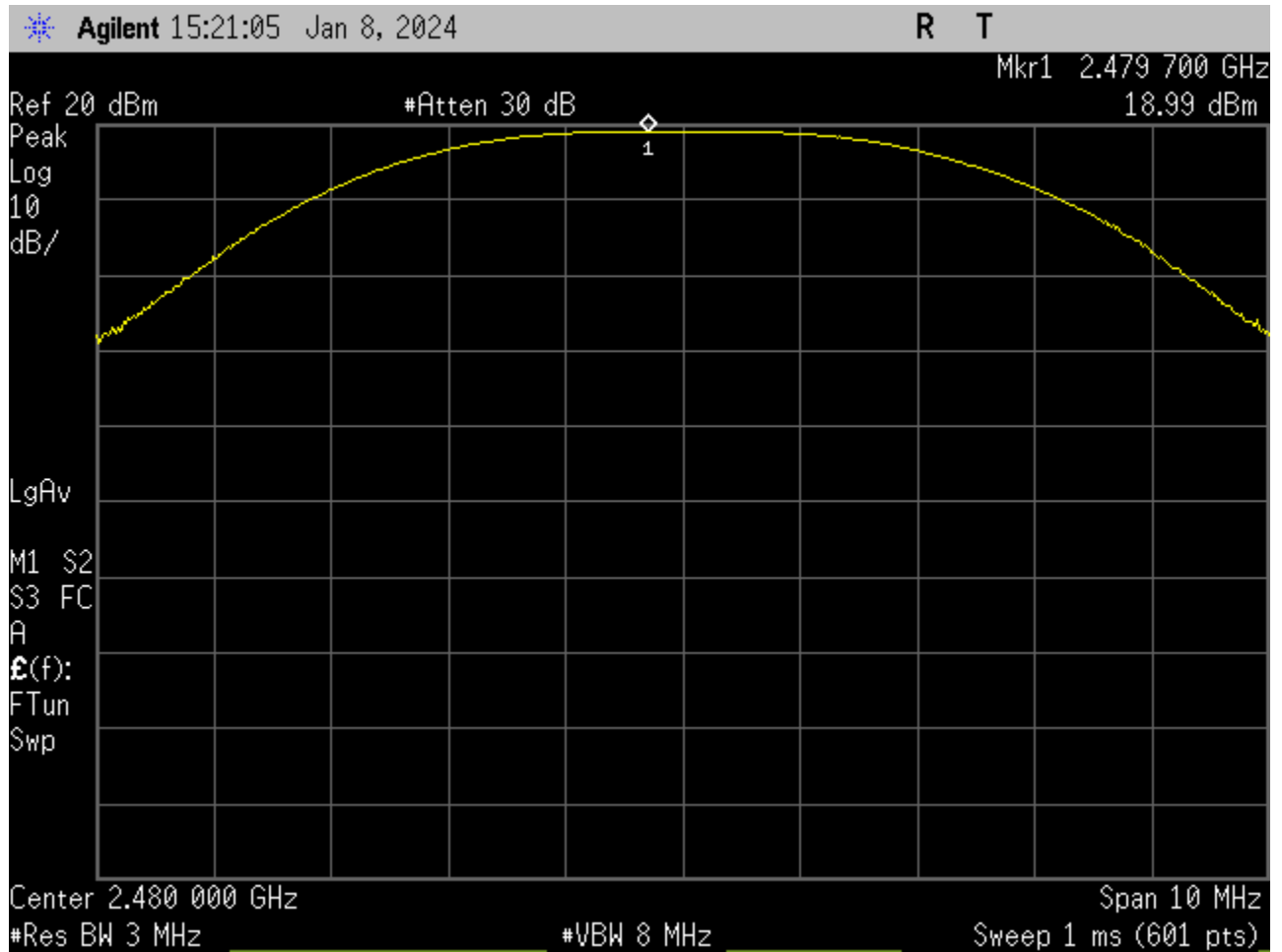

Figure 6. High Channel, Peak Power

Electromagnetic Compatibility Criteria for Intentional Radiators

§ 15.247(e) Peak Power Spectral Density

Test Requirements: §15.247(e): For digitally modulated systems, the peak power spectral density conducted from the intentional radiator to the antenna shall not be greater than 8dBm in any 3 kHz band during any time interval of continuous transmission.

Test Procedure: The transmitter was connected directly to a Spectrum Analyzer through an attenuator. The power level was set to the maximum level. The RBW was set between 3kHz and 100 kHz. The VBW was set to 3x the RBW. The spectrum analyzer was set to an auto sweep time and a peak detector was used. Measurements were carried out at the low, mid and high channels.

Test Results: The EUT was compliant with the peak power spectral density limits of § 15.247 (e).
The peak power spectral density was determined from plots on the following page(s).

Test Engineer: Bryan Taylor

Test Date: 1/8/2024

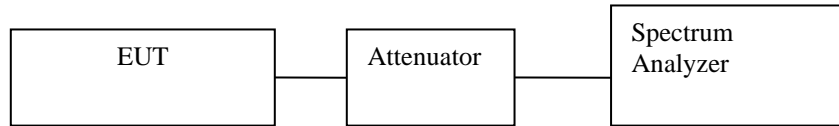

Figure 7. Block Diagram, Peak Power Spectral Density Test Setup

Channel	Frequency (MHz)	Peak Power Spectral Density (dBm / 8kHz)	Peak Power Spectral Density Limit (dBm / 8kHz)	Result
Low	2405MHz	1.86	8	Pass
Middle	2440MHz	1.62	8	Pass
High	2480MHz	1.92	8	Pass

Table 14. Peak Power Spectral Density, Test Results

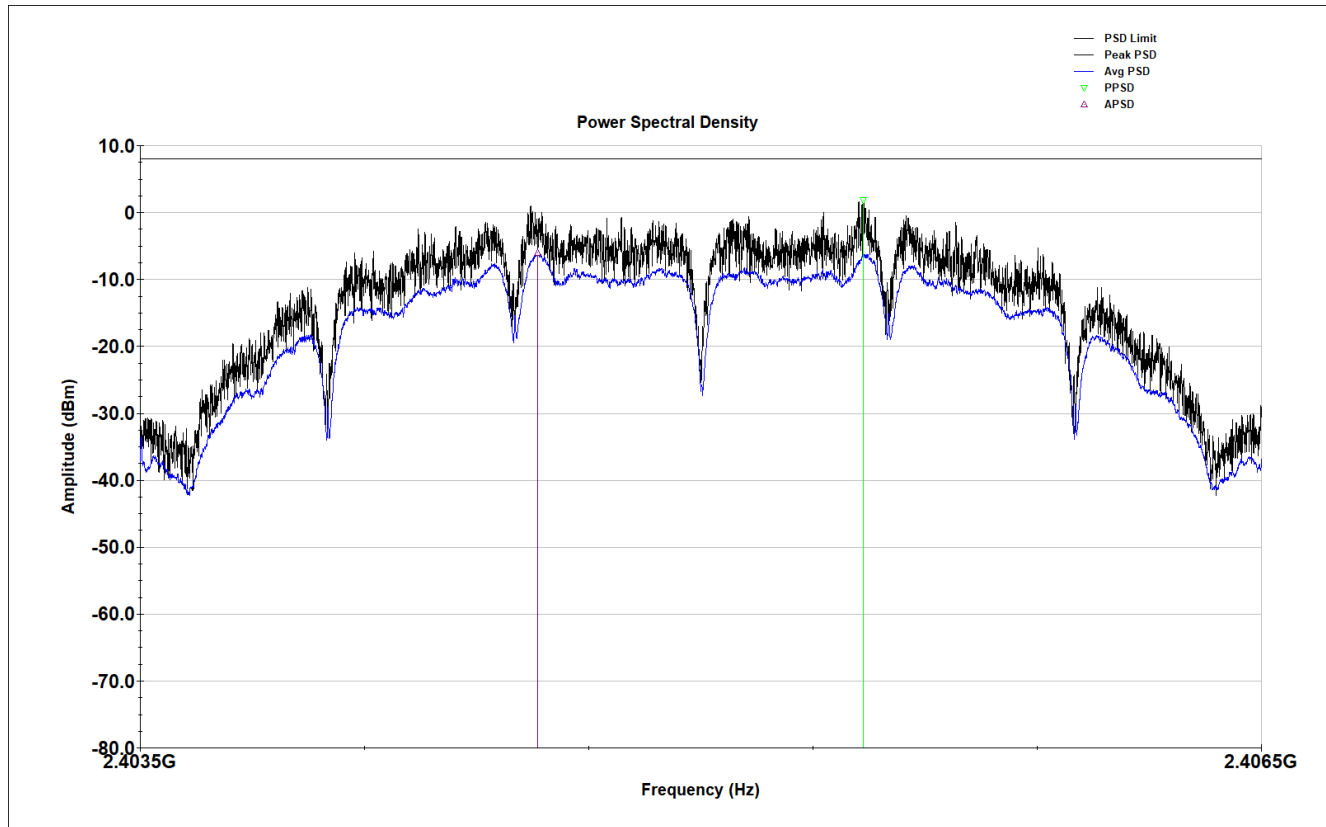

Figure 8. Low Channel, Power Spectral Density

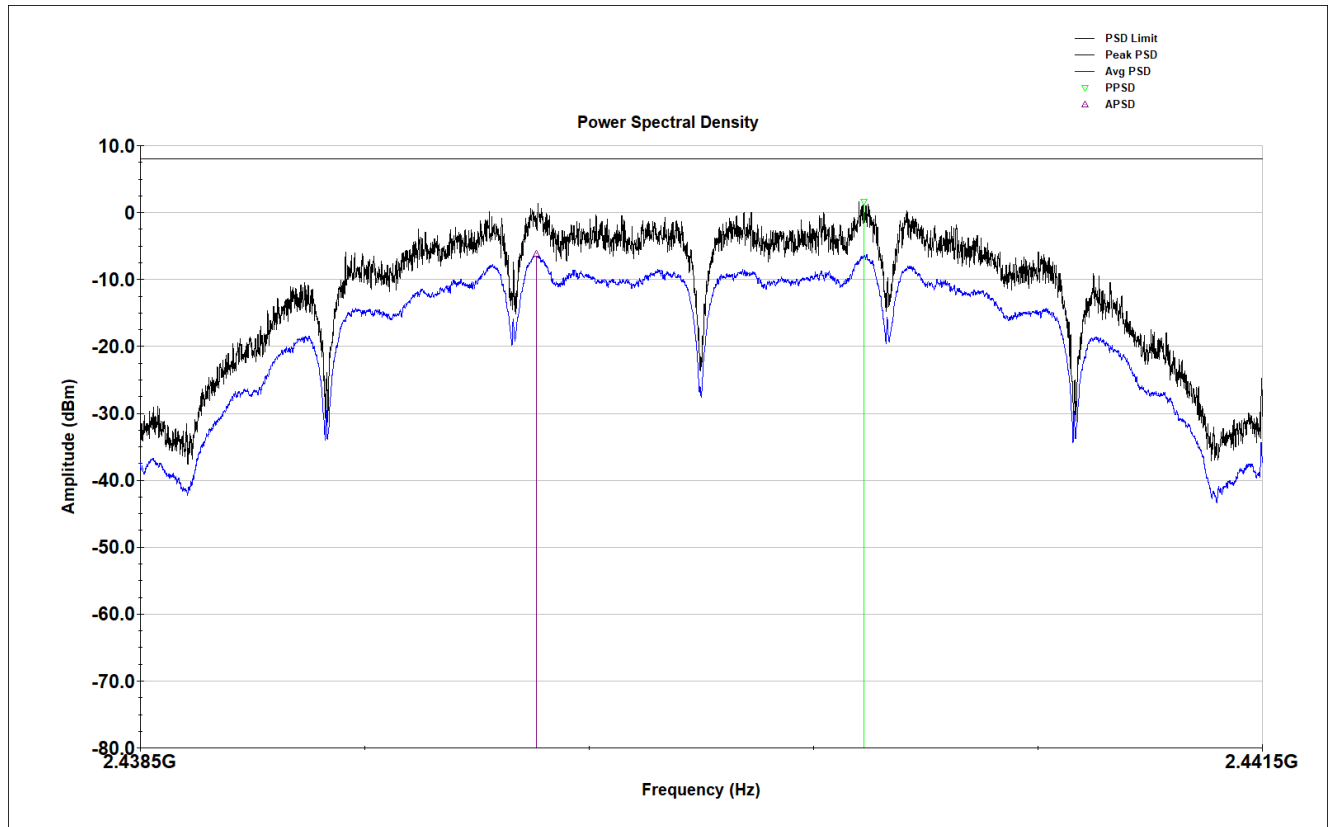

Figure 9. Mid Channel, Power Spectral Density

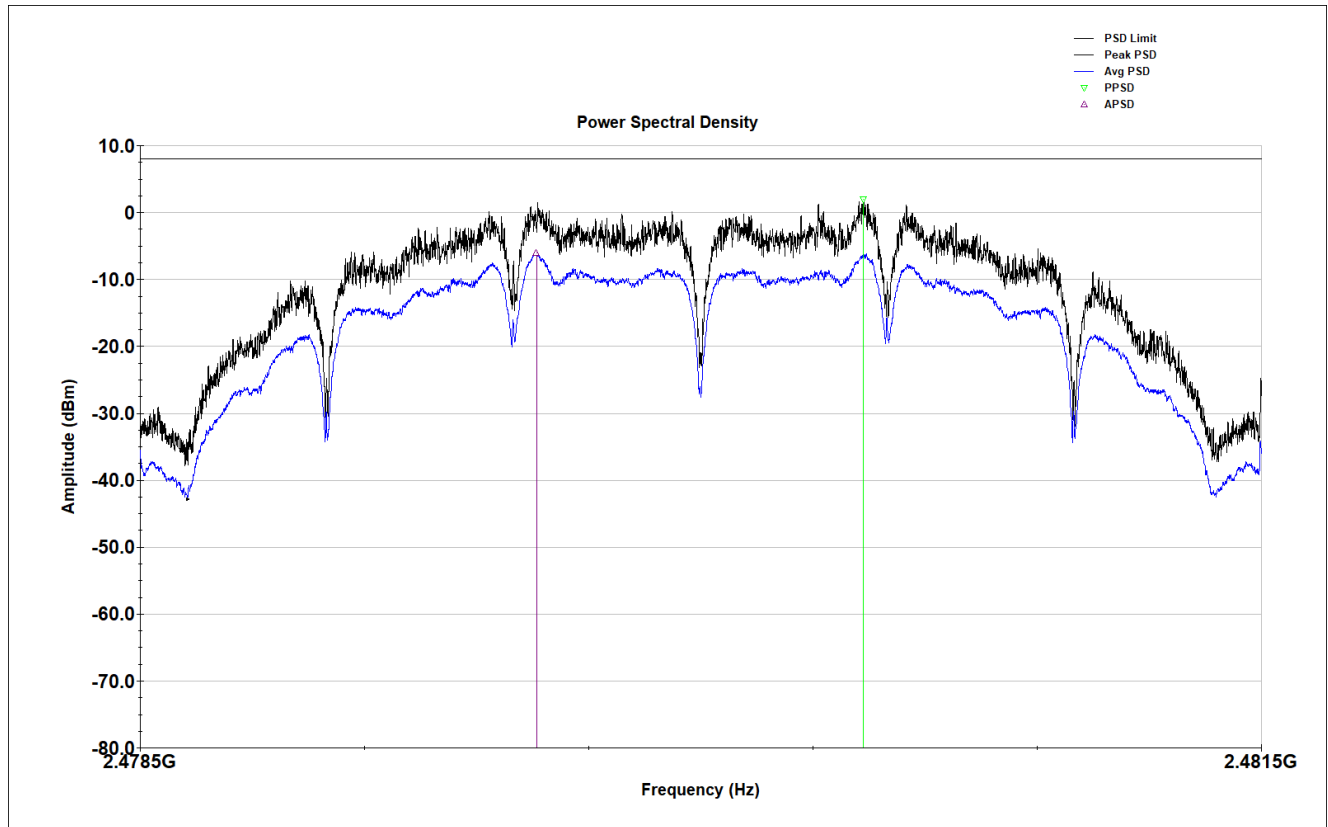

Figure 10. High Channel, Power Spectral Density

Electromagnetic Compatibility Criteria for Intentional Radiators

§ 15.247(d) RF Conducted Spurious Emissions Requirements

Test Requirement: **15.247(d)** In any 100 kHz bandwidth outside the frequency band in which the spread spectrum or digitally modulated intentional radiator is operating, the radio frequency power that is produced by the intentional radiator shall be at least 20 dB below that in the 100 kHz bandwidth within the band that contains the highest level of the desired power, based on either an RF conducted or a radiated measurement, provided the transmitter demonstrates compliance with the peak conducted power limits. If the transmitter complies with the conducted power limits based on the use of RMS averaging over a time interval, as permitted under paragraph (b)(3) of this section, the attenuation required under this paragraph shall be 30 dB instead of 20 dB.

Test Procedure: For intentional radiators with a digital device portion which operates below 10 GHz, the spectrum was investigated as per §15.33(a)(1) and §15.33(a)(4); i.e., the lowest RF signal generated or used in the device up to the 10th harmonic of the highest fundamental frequency or to 40 GHz, whichever is lower.

The transmitter was connected directly to a Spectrum Analyzer through an attenuator. The power level was set to the maximum level. The RBW was set to 100 kHz. The VBW was set to 3x the RBW. The spectrum analyzer was set to an auto sweep time and a peak detector was used. Measurements were carried out at the low, mid and high channels.

See following pages for detailed test results with RF Conducted Spurious Emissions.

Test Results: The EUT was compliant with the Conducted Spurious Emission limits of §15.247(d).

Test Engineer(s): Bryan Taylor

Test Date(s): 1/9/2024

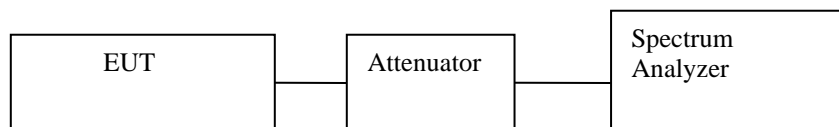

Figure 11. Block Diagram, Conducted Spurious Emissions Test Setup

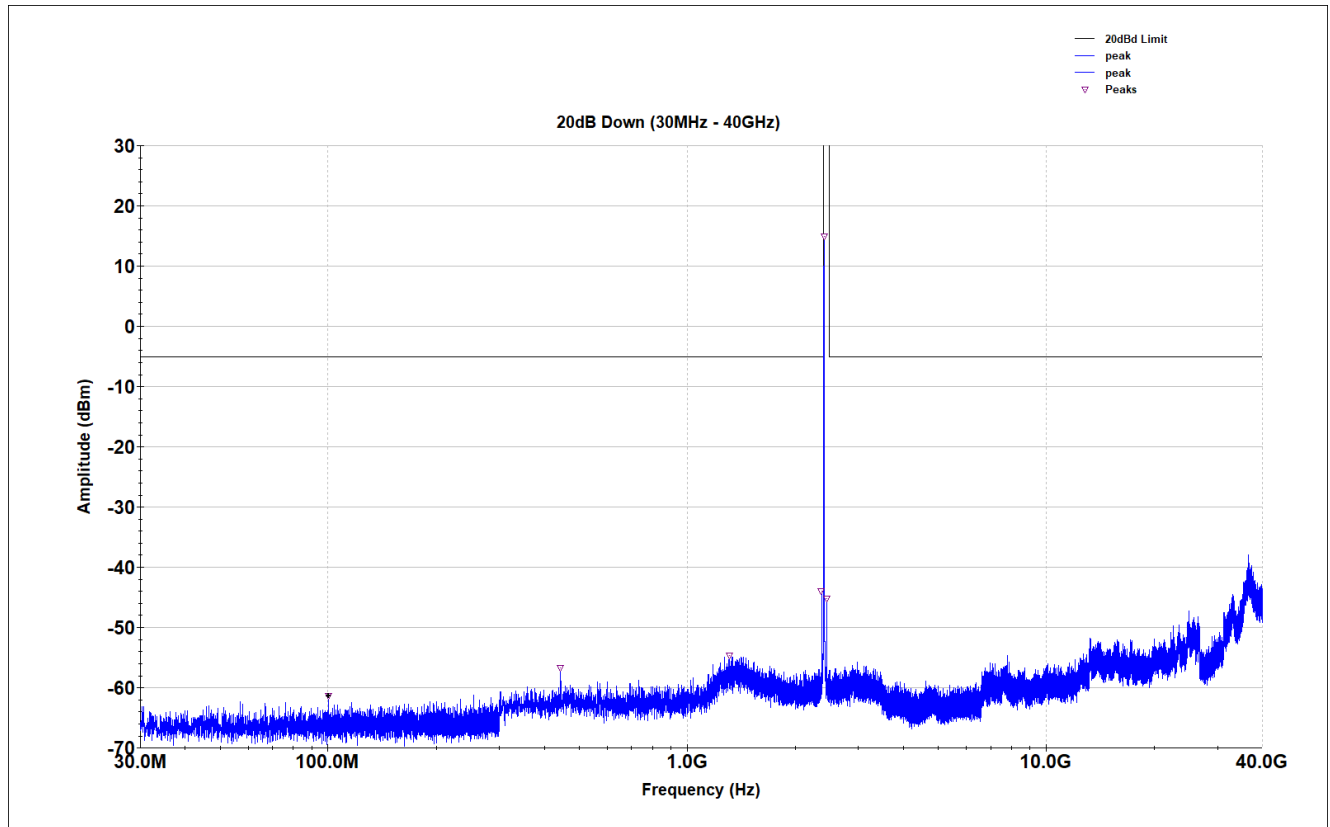

Figure 12. Low Channel, 30MHz – 40GHz Conducted Spurious Emissions

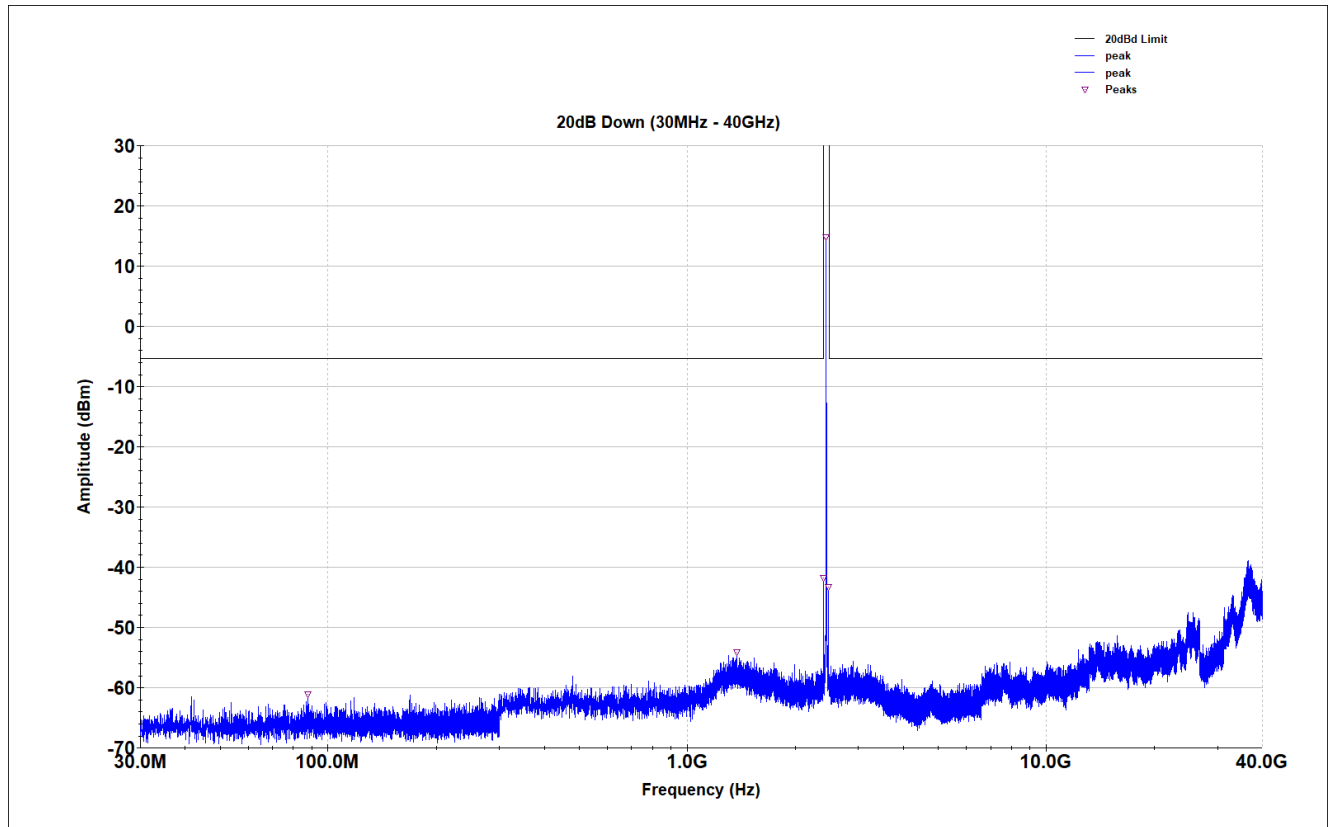

Figure 13. Mid Channel, 30MHz – 40GHz Conducted Spurious Emissions

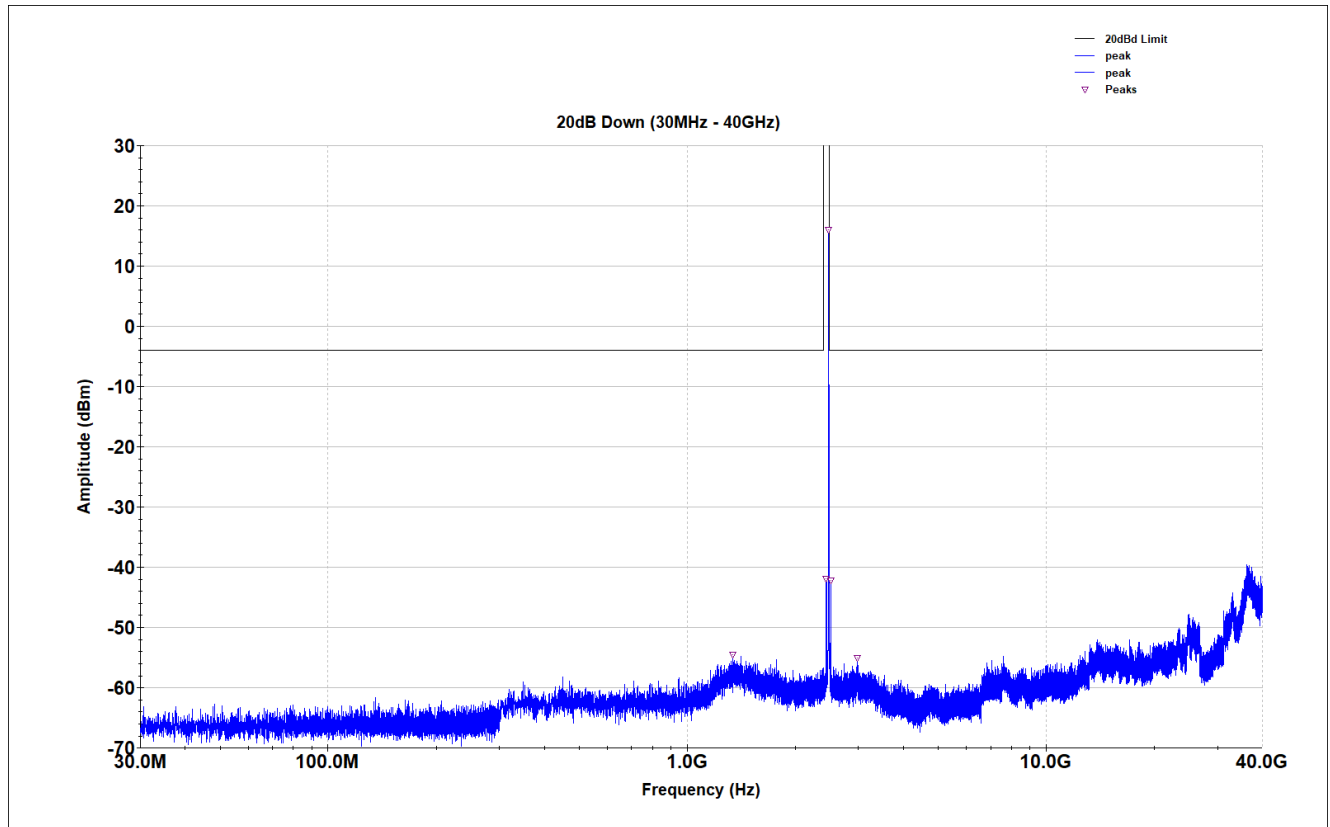
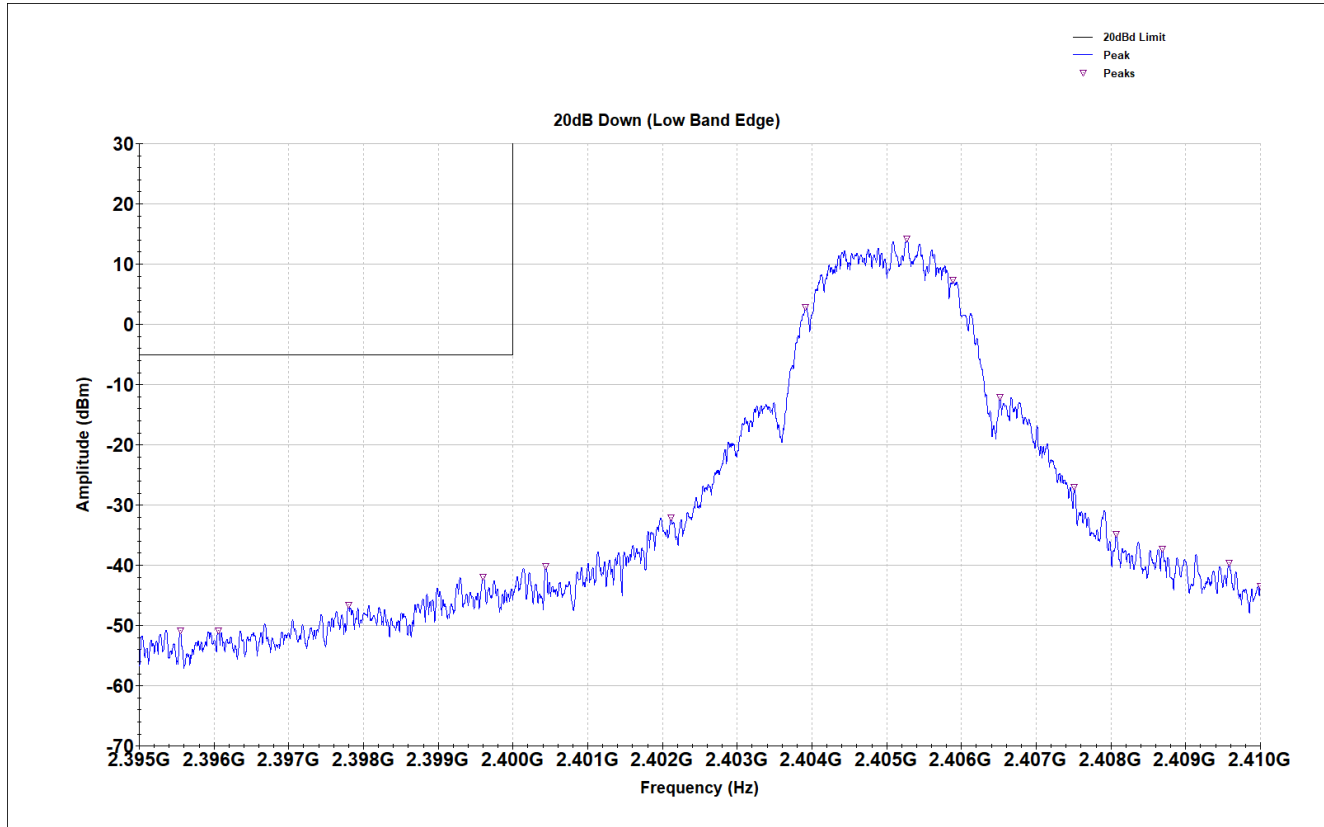
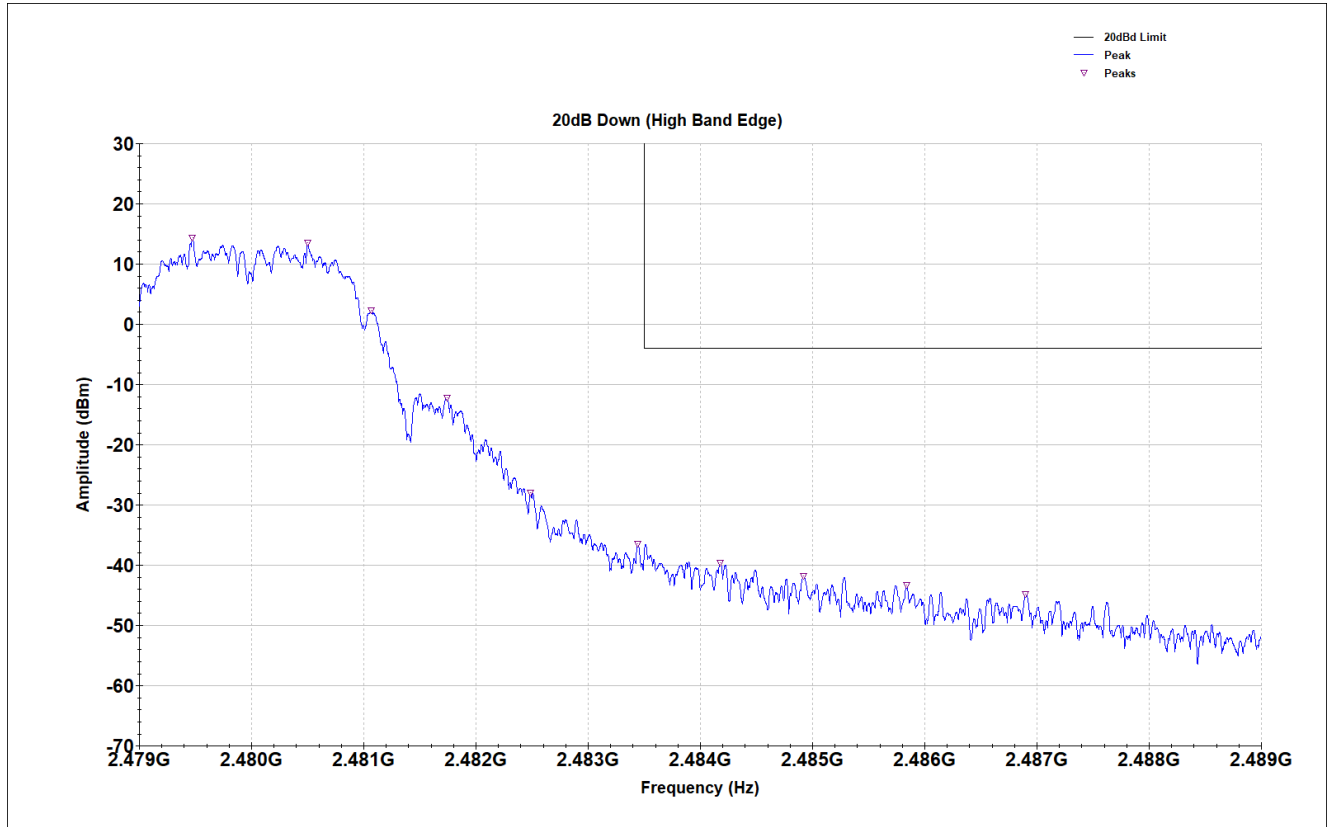

Figure 14. High Channel, 30MHz – 40GHz Conducted Spurious Emissions



Spurious Frequency (MHz)	Peak Amplitude (dBm)	-20dBd Limit (dBm)	Margin (dB)	Result
2395.549	-50.76	-5.06	45.7	Pass
2396.056	-50.8	-5.06	45.74	Pass
2397.799	-46.6	-5.06	41.54	Pass
2399.605	-41.97	-5.06	36.91	Pass

Figure 15. Low Channel, Low Band Edge



Spurious Frequency (MHz)	Peak Amplitude (dBm)	-20dBd Limit (dBm)	Margin (dB)	Result
2484.177	-39.64	-3.92	35.72	Pass
2484.919	-41.78	-3.92	37.86	Pass
2485.839	-43.28	-3.92	39.36	Pass
2486.901	-44.83	-3.92	40.91	Pass

Figure 16. High Channel, High Band Edge

Electromagnetic Compatibility Criteria for Intentional Radiators

§ 15.247(d) Radiated Spurious Emissions Requirements and Band Edge

Test Requirements: §15.247(d); §15.205: Emissions outside the frequency band.

§15.247(d): In any 100 kHz bandwidth outside the frequency band in which the spread spectrum or digitally modulated intentional radiator is operating, the radio frequency power that is produced by the intentional radiator shall be at least 20 dB below that in the 100 kHz bandwidth within the band that contains the highest level of the desired power, based on either an RF conducted or a radiated measurement. Attenuation below the general limits specified in § 15.209(a) is not required. In addition, radiated emissions which fall in the restricted bands, as defined in § 15.205(a), must also comply with the radiated emission limits specified in § 15.209(a).

§15.205(a): Except as shown in paragraph (d) of this section, only spurious emissions are permitted in any of the frequency bands listed below:

MHz	MHz	MHz	GHz
0.090–0.110-----	16.42–16.423	399.9–410	4.5–5.15
¹ 0.495–0.505-----	16.69475–16.69525	608–614	5.35–5.46
2.1735–2.1905-----	16.80425–16.80475	960–1240	7.25–7.75
4.125–4.128-----	25.5–25.67	1300–1427	8.025–8.5
4.17725–4.17775-----	37.5–38.25	1435–1626.5	9.0–9.2
4.20725–4.20775-----	73–74.6	1645.5–1646.5	9.3–9.5
6.215–6.218-----	74.8–75.2	1660–1710	10.6–12.7
6.26775–6.26825-----	108–121.94	1718.8–1722.2	13.25–13.4
6.31175–6.31225-----	123–138	2200–2300	14.47–14.5
8.291–8.294-----	149.9–150.05	2310–2390	15.35–16.2
8.362–8.366-----	156.52475–156.52525	2483.5–2500	17.7–21.4
8.37625–8.38675-----	156.7–156.9	2655–2900	22.01–23.12
8.41425–8.41475-----	162.0125–167.17	3260–3267	23.6–24.0
12.29–12.293-----	167.72–173.2	3332–3339	31.2–31.8
12.51975–12.52025-----	240–285	3345.8–3358.36.	43–36.5
12.57675–12.57725-----	322–335.4	3600–4400	(²)

Table 15. Restricted Bands of Operation

¹ Until February 1, 1999, this restricted band shall be 0.490 – 0.510 MHz.

² Above 38.6

Test Requirement(s): § 15.209 (a): Except as provided elsewhere in this subpart, the emissions from an intentional radiator shall not exceed the field strength levels specified in Table 16.

Frequency (MHz)	§ 15.209(a), Radiated Emission Limits (dBµV) @ 3m
30 - 88	40.00
88 - 216	43.50
216 - 960	46.00
Above 960	54.00

Table 16. Radiated Emissions Limits Calculated from FCC Part 15, § 15.209 (a)

Test Procedures: The radiated methodology referenced in ANSI C63.10: 2013 Section 11.12.1 was utilized in order to assess the unwanted emissions in the restricted bands.

A radiated scan was performed with the antenna of proper impedance installed. The transmitter was turned on. Measurements were performed of the low, mid and high Channels. The EUT was rotated orthogonally through all three axes if multiple mounting orientations are supported. Plots shown are corrected for both antenna correction factor and distance and compared to a 3 m limit line.

Radiated measurements below 30MHz were performed in a semi-anechoic chamber that has been correlated to an open area site.

Test Results: The EUT was compliant with the Radiated Spurious Emission limits of § 15.247(d).

Test Engineer(s): Bryan Taylor, Sergio Gutierrez

Test Date(s): 12/26/2023 – 1/9/2024

Radiated Spurious Emissions Test Results

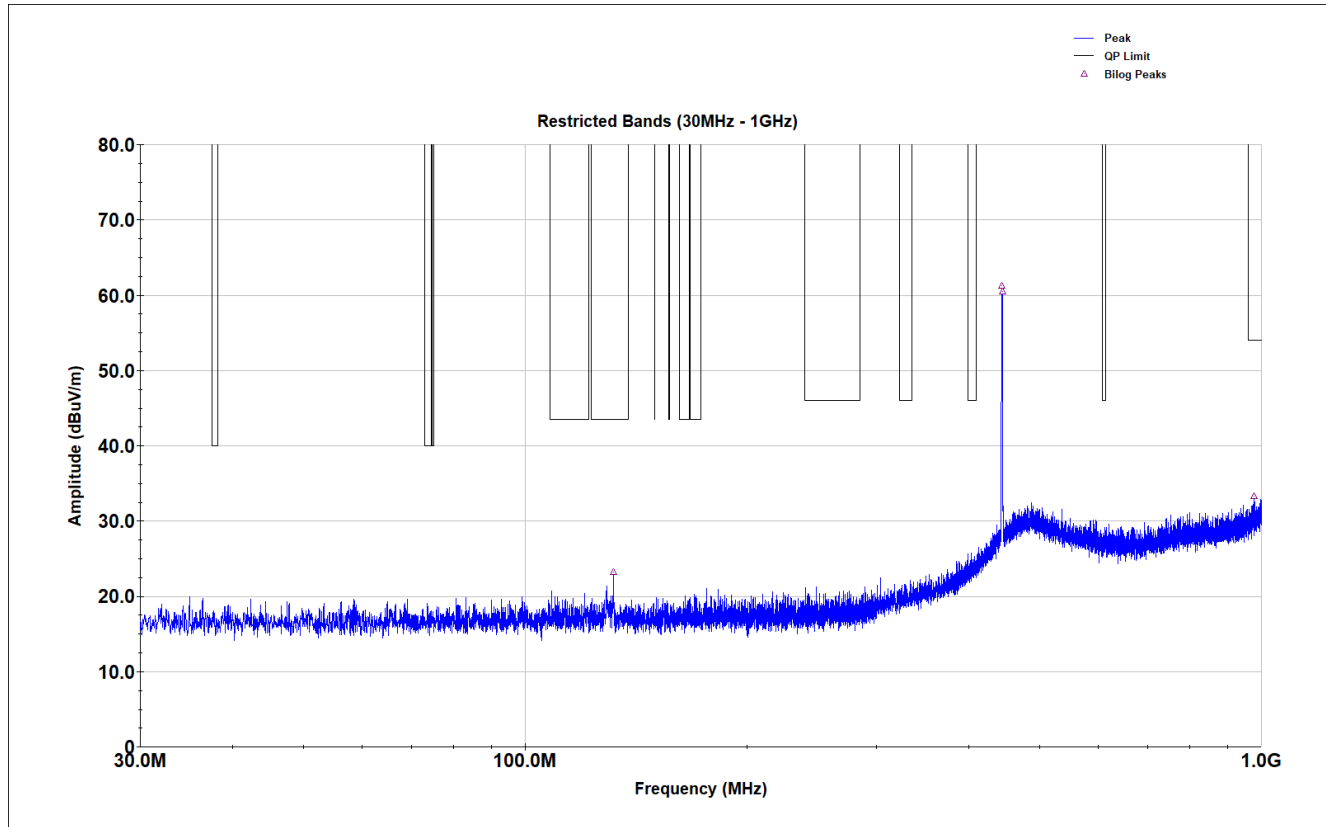

Figure 17. Low Channel, 30MHz – 1GHz Restricted Band Spurious Emissions

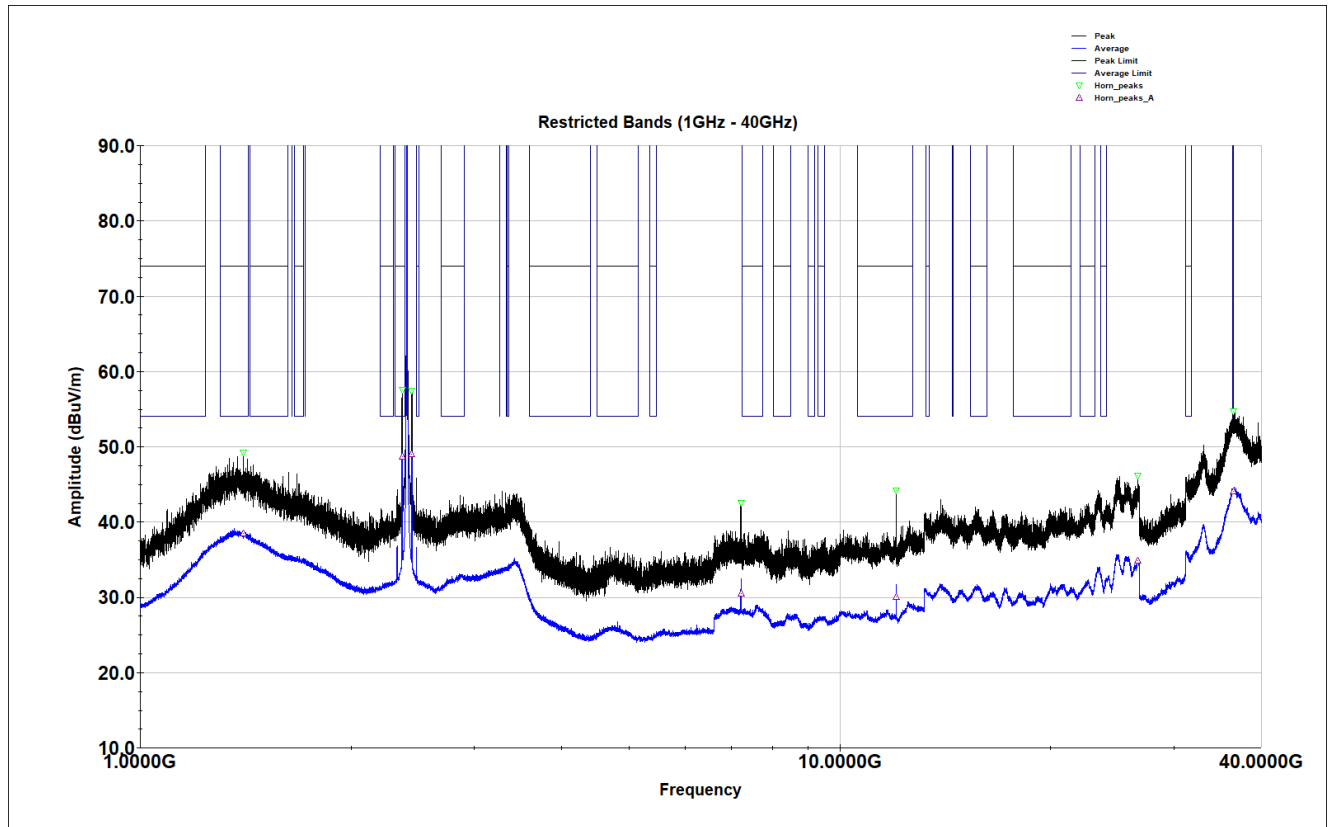

Figure 18. Low Channel, 1GHz – 40GHz Restricted Band Spurious Emissions

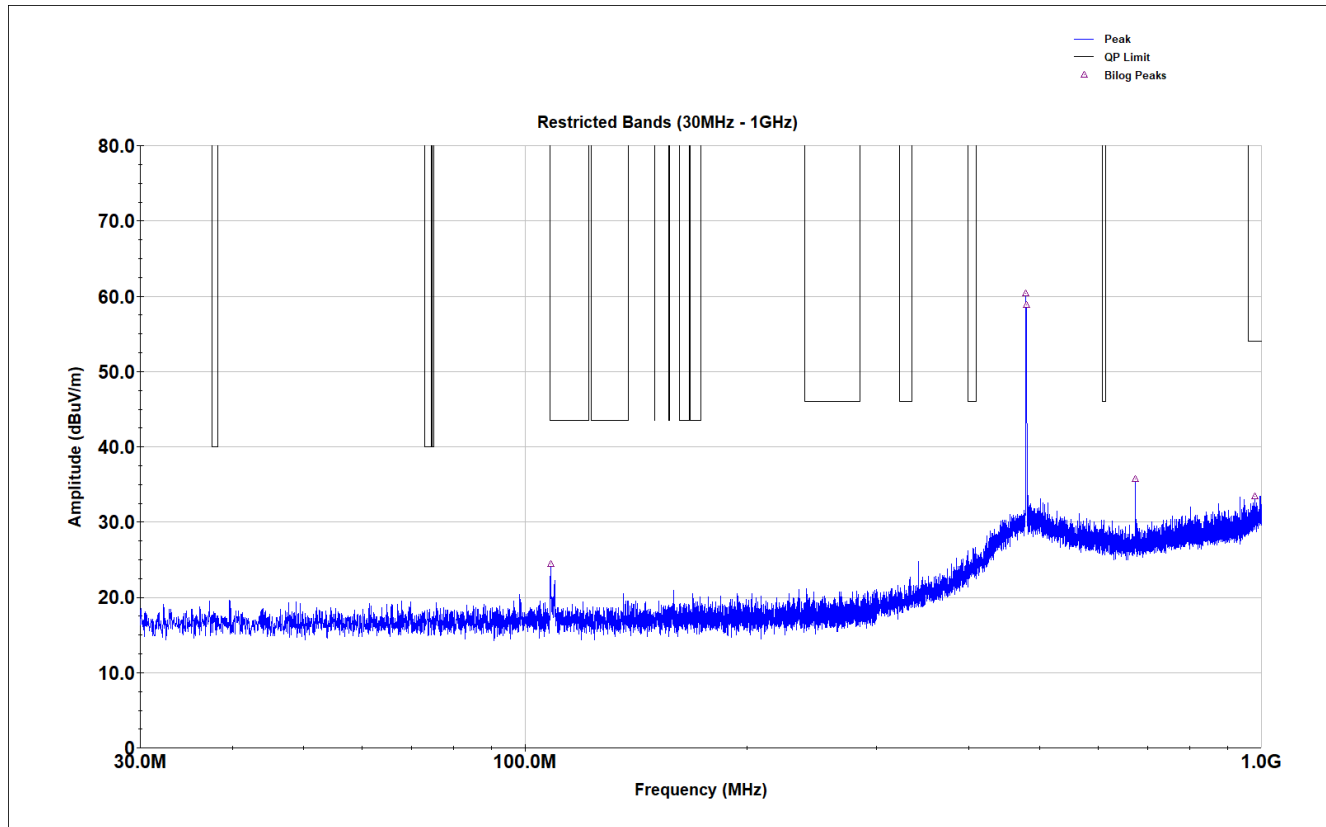

Figure 19. Middle Channel, 30MHz – 1GHz Restricted Band Spurious Emissions

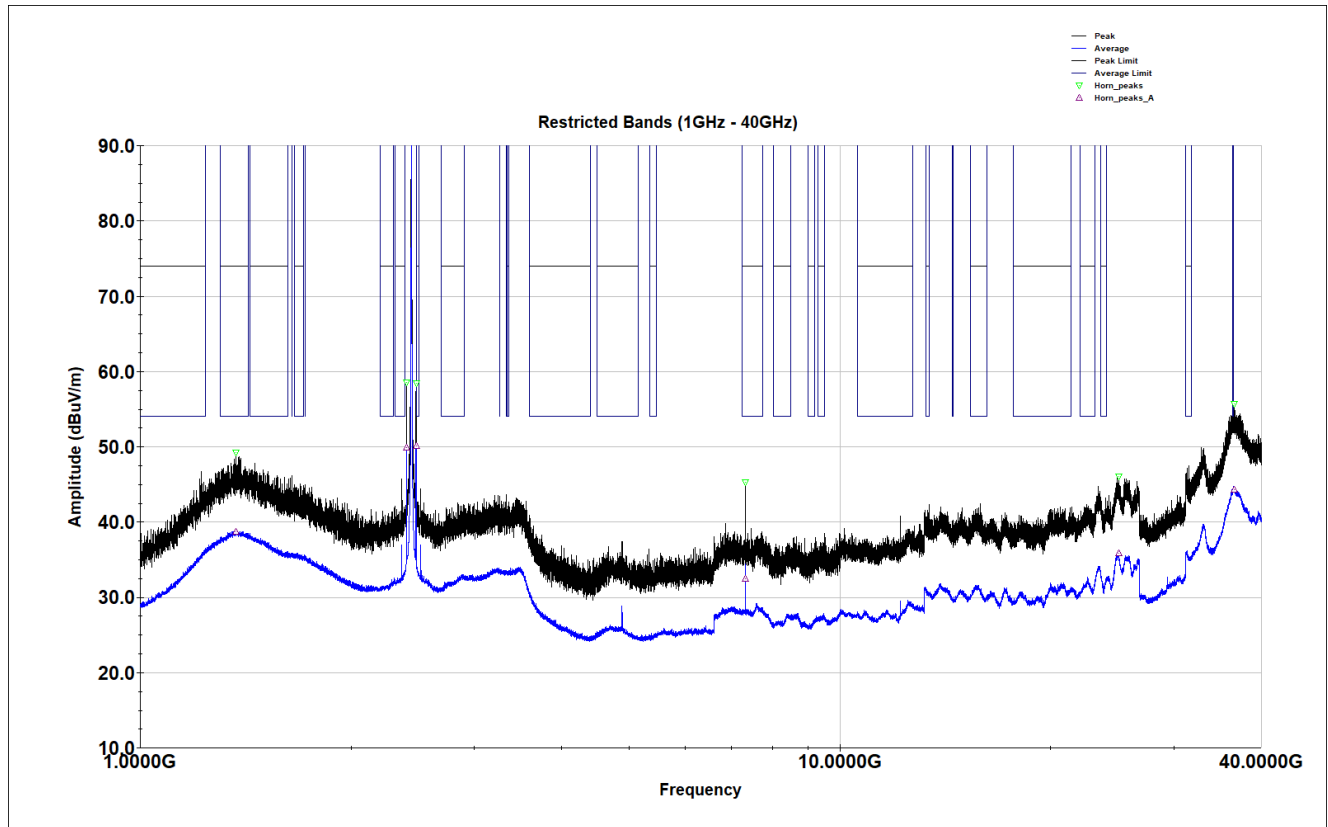

Figure 20. Middle Channel, 1GHz – 40GHz Restricted Band Spurious Emissions

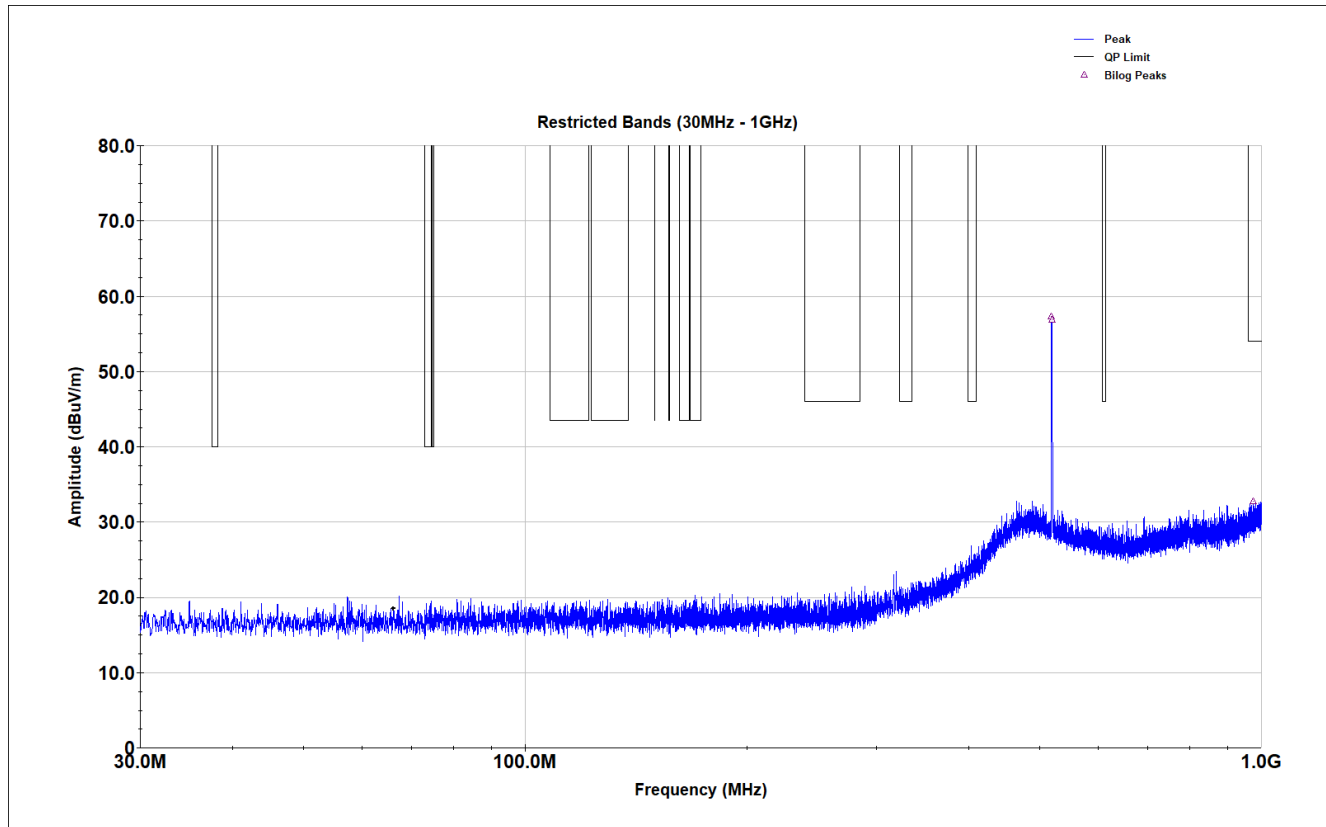

Figure 21. High Channel, 30MHz – 1GHz Restricted Band Spurious Emissions

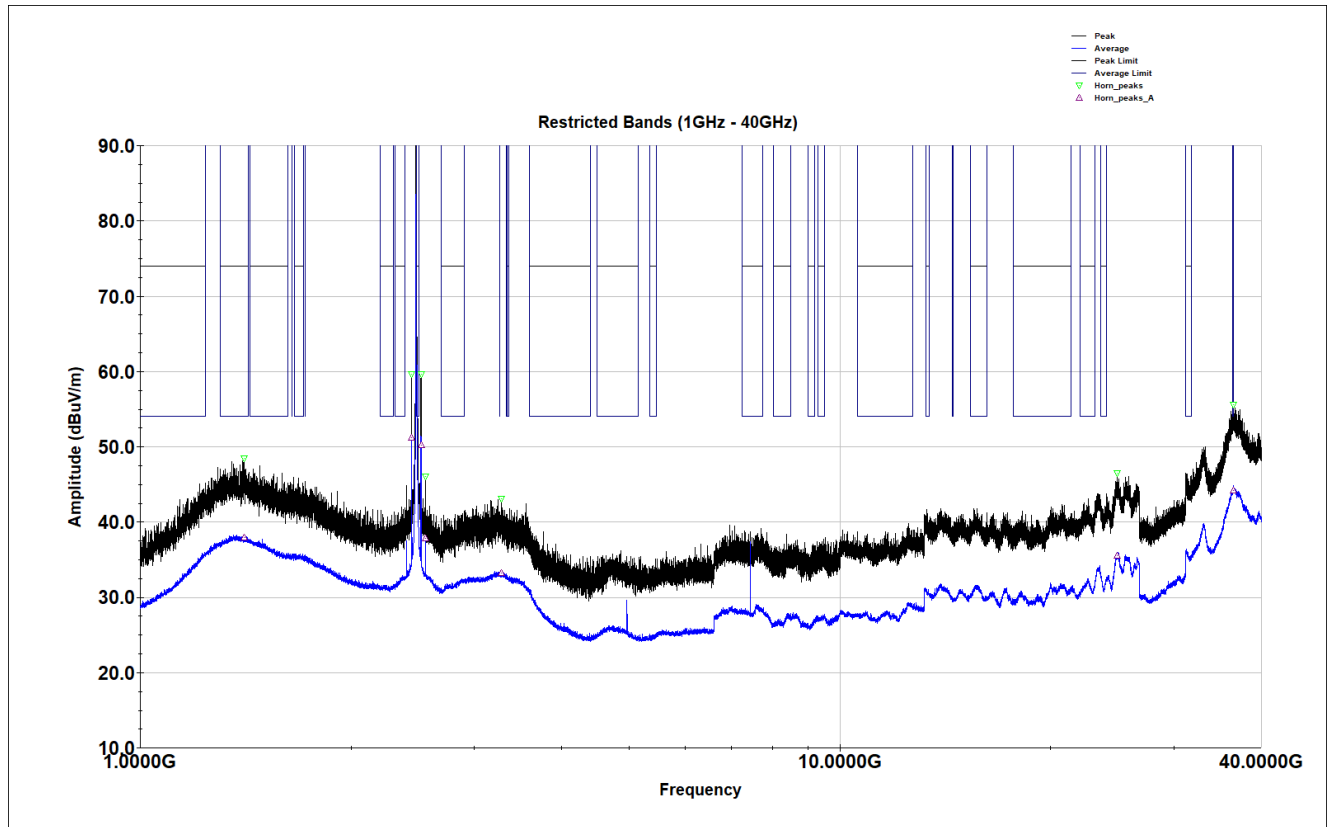
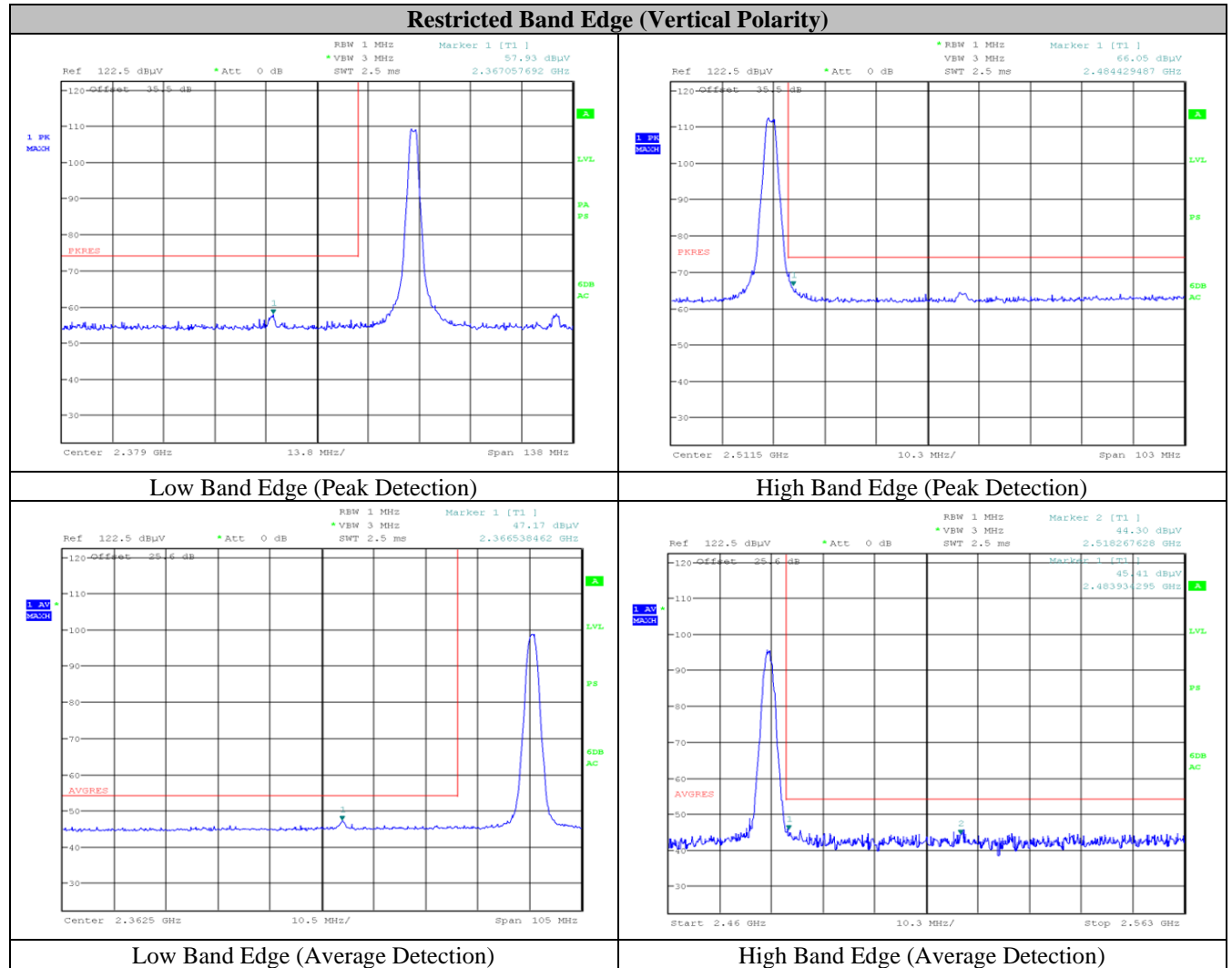

Figure 22. High Channel, 1GHz – 40GHz Restricted Band Spurious Emissions



Frequency	Peak Reading (dBuV/m)	Peak Limit (dBuV/m)	Peak Margin (dB)	Avg Reading (dBuV/m)	Avg Limit (dBuV/m)	Avg Margin (dBuV/m)	Result
2.367 GHz	57.93	74.00	16.07	47.17	54.00	6.83	Pass
2.484 GHz	66.05	74.00	7.95	44.30	54.00	9.7	Pass

Figure 23. Restricted Band Edge Spurious Emissions (Vertical Polarity)³

³ The average measurements include a duty cycle correction factor of -9.897dB due to a 32% duty cycle. Lutron Electronics Co., Inc. will provide documentation which justifies the use of this specific duty cycle correction factor.

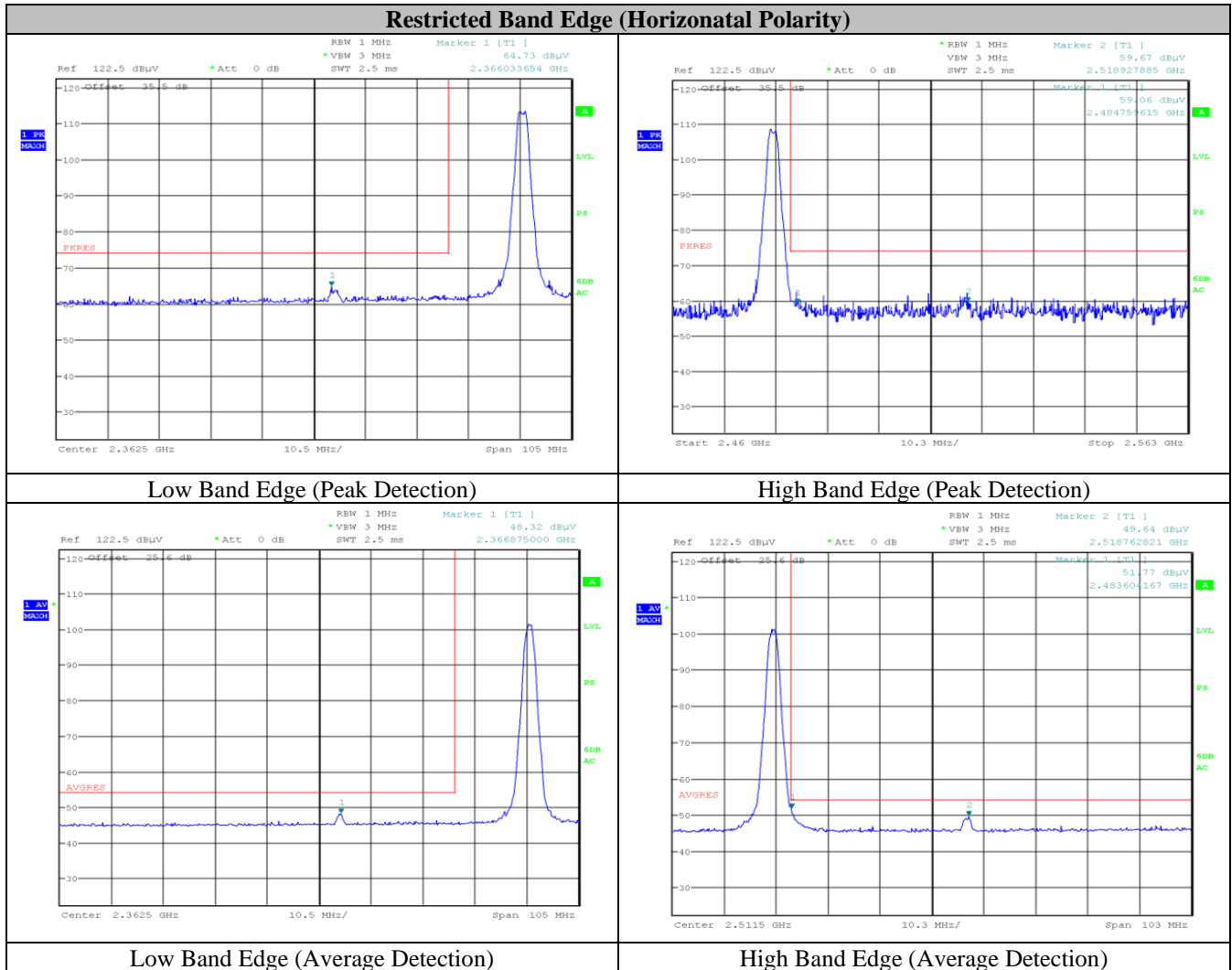

Frequency	Peak Reading (dBuV/m)	Peak Limit (dBuV/m)	Peak Margin (dB)	Avg Reading (dBuV/m)	Avg Limit (dBuV/m)	Avg Margin (dBuV/m)	Result
2.366 GHz	64.73	74.00	9.27	48.32	54.00	5.68	Pass
2.484 GHz	59.06	74.00	14.94	51.77	54.00	2.23	Pass
2.518 GHz	59.67	74.00	14.33	49.64	54.00	4.36	Pass

Figure 24. Restricted Band Edge Spurious Emissions (Horizontal Polarity)⁴

⁴ The average measurements include a duty cycle correction factor of -9.897dB due to a 32% duty cycle. Lutron Electronics Co., Inc. will provide documentation which justifies the use of this specific duty cycle correction factor.

Worst Case Cabinet Spurious Emissions

Frequency [MHz]	QPK Level [dBµV/m]	QPK Limit [dBµV/m]	QPK Margin [dB]	Correction [dB]	Polarization	Azimuth [deg]	Antenna Height [m]	Meas. BW [kHz]	Result
166.170	25.89	43.52	17.63	-9.56	H	36	3.45	120.000	Pass
274.680	24.97	46.02	21.05	-6.20	V	93.8	3.68	120.000	Pass
281.340	35.54	46.02	10.48	-6.14	H	18.3	3.5	120.000	Pass
329.100	36.85	46.02	9.17	-4.63	H	3.9	2.56	120.000	Pass

Figure 25. Worst Case Cabinet Radiation, Below 1GHz

Frequency [MHz]	PK+ Level [dBµV/m]	PK+ Limit [dBµV/m]	PK+ Margin [dB]	AVG Level [dBµV/m]	AVG Limit [dBµV/m]	AVG Margin [dB]	Correction [dB]	Polarization	Azimuth [deg]	Antenna Height [m]	Result
4,879.000	45.93	74.00	28.07	35.57	54.00	18.43	-3.36	V	280.9	2.98	Pass
4,883.000	41.16	74.00	32.84	28.63	54.00	25.37	-3.30	H	221.5	3.11	Pass
7,321.500	49.77	74.00	24.23	39.82	54.00	14.18	-2.78	V	271	3.91	Pass
12,202.500	48.27	74.00	25.73	35.68	54.00	18.32	-1.91	V	79.5	3.44	Pass
12,219.500	45.74	74.00	28.26	33.12	54.00	20.88	-1.95	H	42.5	2.2	Pass
19,520.000	49.78	74.00	24.22	36.46	54.00	17.54	12.33	V	249.6	2.58	Pass

Figure 26. Worst Case Cabinet Radiation, Above 1GHz

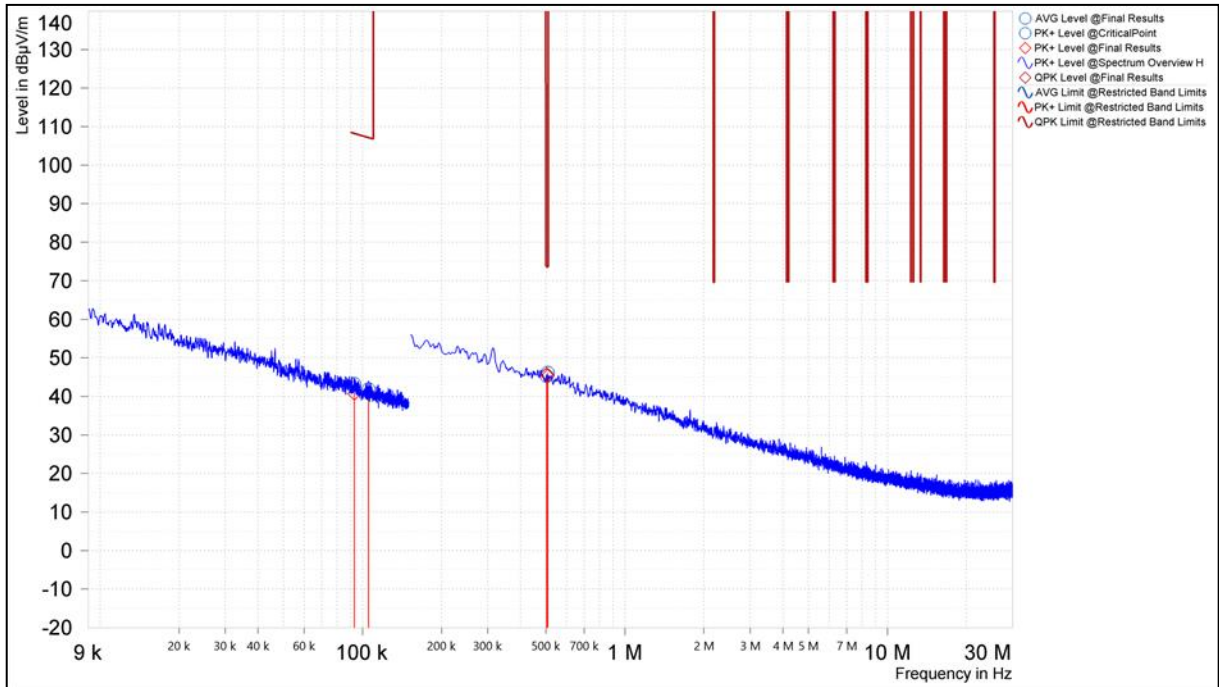

Figure 27. Worst Case Cabinet Radiation, 9kHz – 30MHz, Coaxial Loop

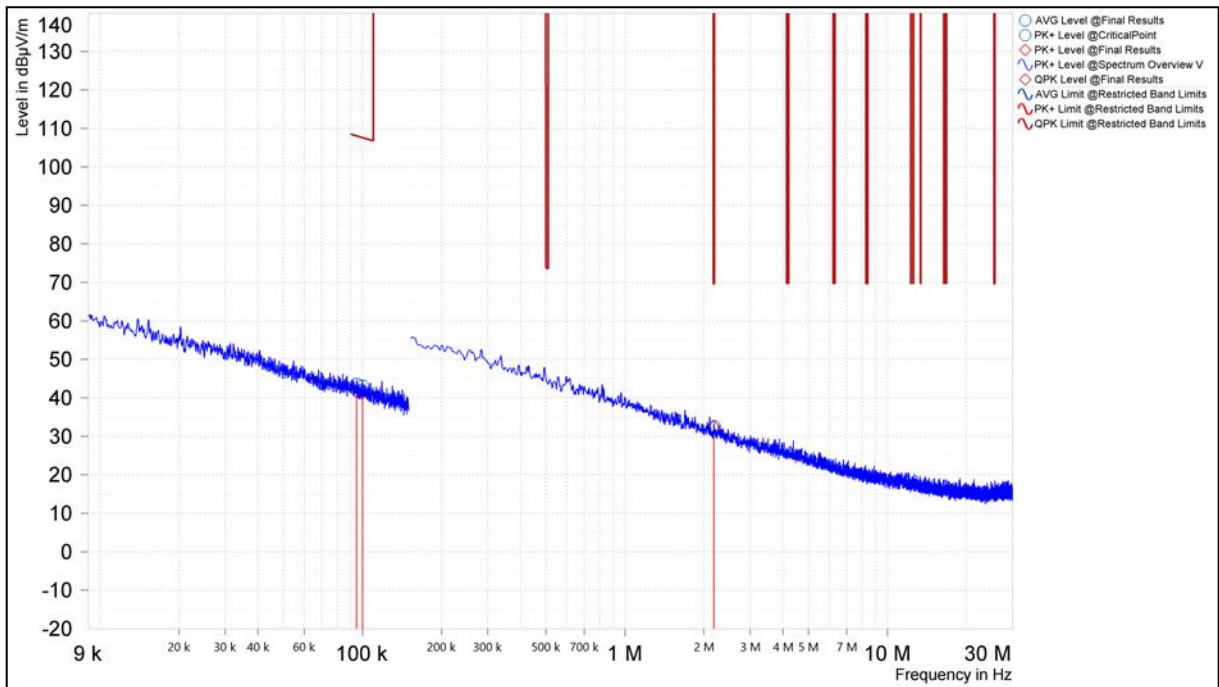

Figure 28. Worst Case Cabinet Radiation, 9kHz – 30MHz, Coplanar Loop

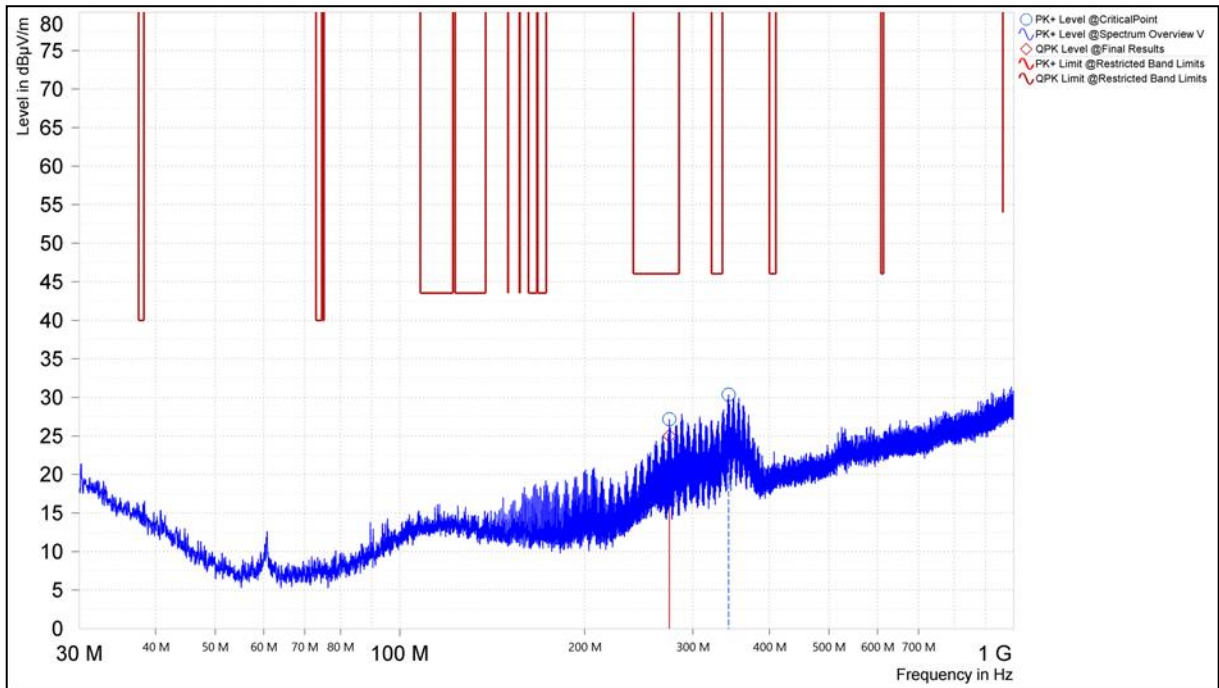

Figure 29. Worst Case Cabinet Radiation, 30MHz – 1GHz, Vertical Polarity

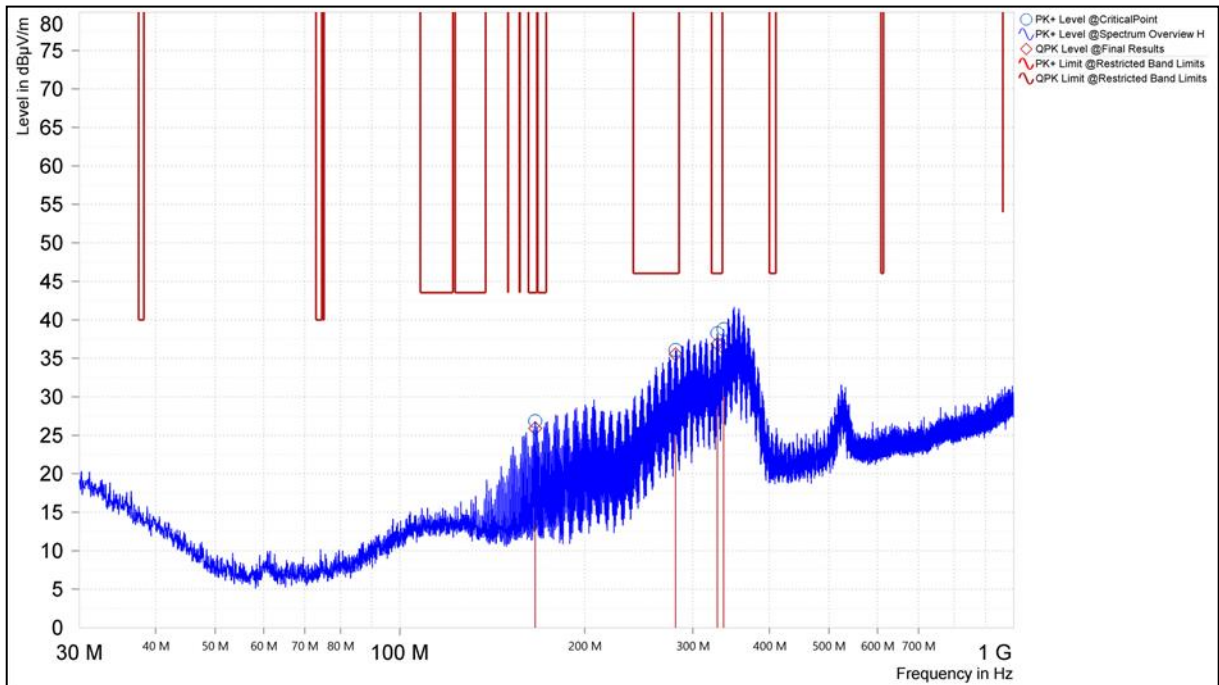

Figure 30. Worst Case Cabinet Radiation, 30MHz – 1GHz, Horizontal Polarity

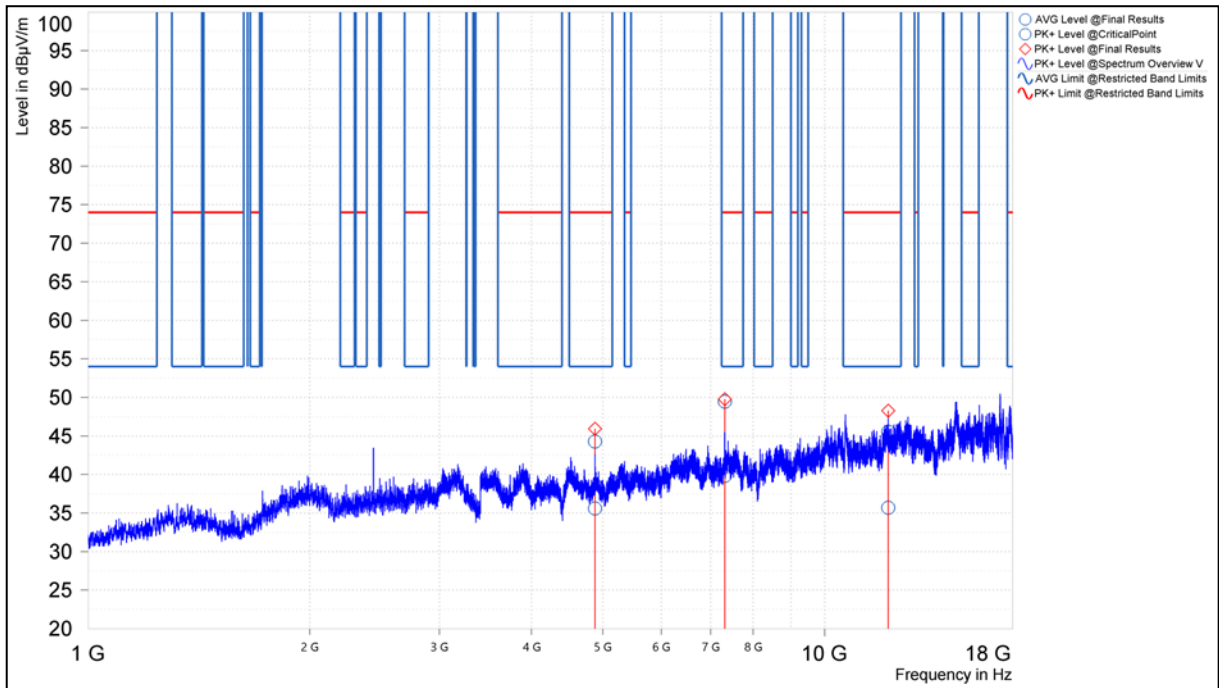

Figure 31. Worst Case Cabinet Radiation, 1GHz – 18GHz, Vertical Polarity

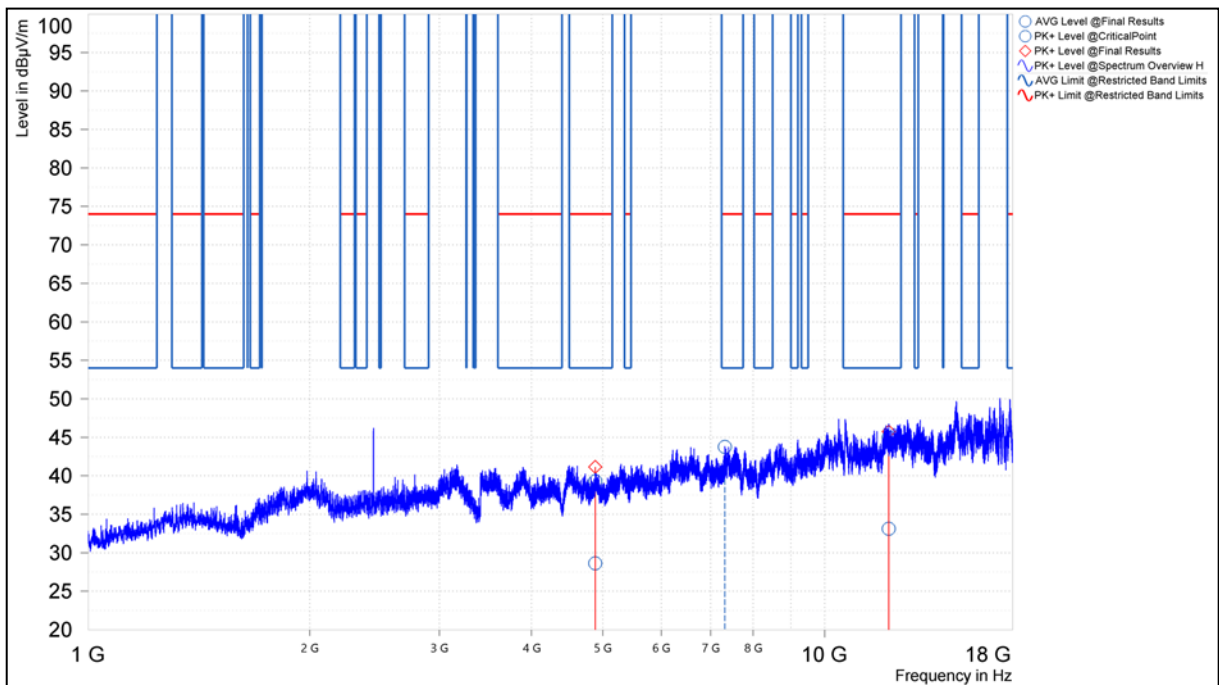

Figure 32. Worst Case Cabinet Radiation, 1GHz – 18GHz, Horizontal Polarity

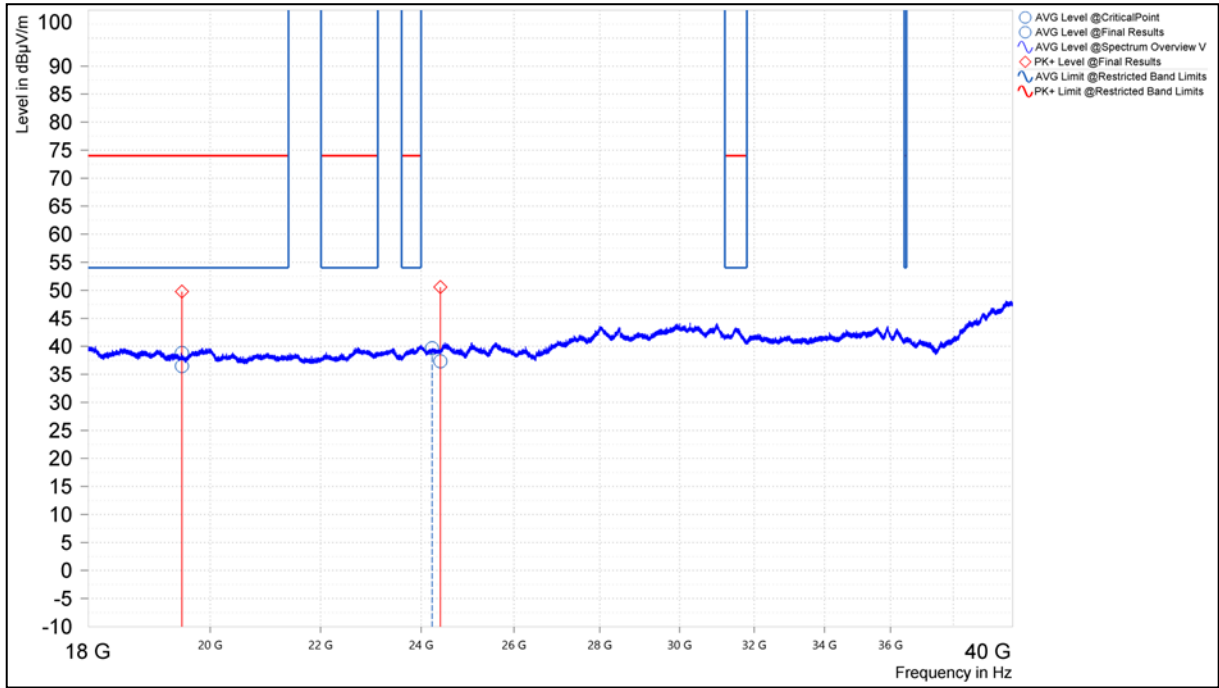

Figure 33. Worst Case Cabinet Radiation, 18GHz – 40GHz, Vertical Polarity

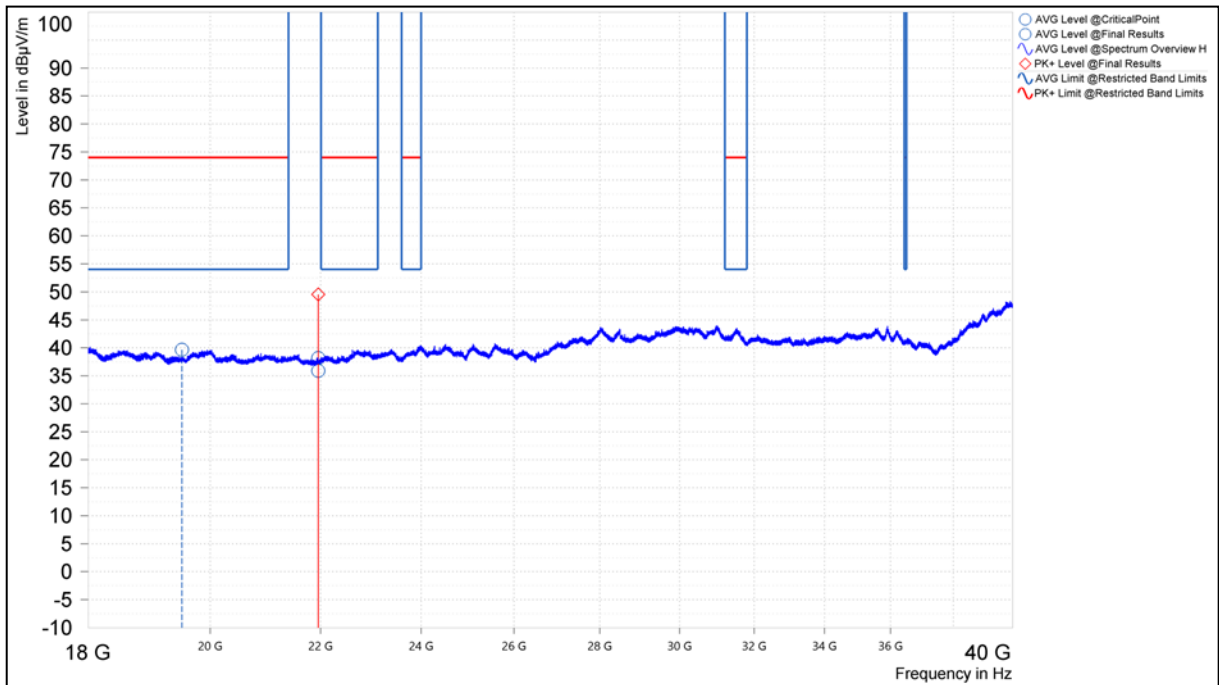

Figure 34. Worst Case Cabinet Radiation, 18GHz – 40GHz, Horizontal Polarity

IV. Test Equipment

Test Equipment

Calibrated test equipment utilized during testing was maintained in a current state of calibration per the requirements of ISO/IEC 17025:2017.

MET Asset #	Description	Manufacturer	Model	Last Cal Date	Cal Due Date
MY46180897	Spectrum Analyzer	Keysight	E4448A	7/27/2023	7/27/2024
1A1083	Receiver	Rohde & Schwarz	ESU40	11/20/2023	11/20/2024
1A1176	Active Loop Antenna (9KHz-30MHz)	ETS-Lindgren	6502	7/13/2023	7/13/2024
1A1050	Bilog Antenna (30MHz – 1GHz)	Schaffner	CBL 6112D	1/24/2023	1/24/2024
1A1183	Horn Antenna (1GHz – 18GHz)	ETS Lindgren	3117	1/4/2023	1/4/2024
1A1161	Horn Antenna (18GHz – 40GHz)	ETS Lindgren	3116C	7/11/2023	7/11/2024
1A1065	EMI Receiver	Rohde & Schwarz	ESCI	8/4/2023	8/4/2024
1A1087	Pulse Limiter	Rohde & Schwarz	ESH3Z2	12/21/2022	12/21/2023
1A1122	LISN	Teseq	NNB 51	9/19/2023	9/19/2024
1A1123	LISN	Teseq	NNB 51	12/20/2023	12/20/2024
1A1149	DC Milliohm Meter	GW Instek	GOM-802	9/20/2023	9/20/2024
1A1099	Generator	Com-Power	CGO-51000	See Note	
1A1088	Preamplifier	Rohde & Schwarz	TS-PR1	See Note	
1A1044	Generator	Com-Power	CG-520	See Note	
1A1073	Multi Device Controller	ETS	2090	See Note	
1A1074	System Controller	Panasonic	WV-CU101	See Note	
1A1080	Multi-Device	ETS	2090	See Note	
1A1180	Preamplifier	Miteq	AMF-7D-01001800-22-10P	See Note	

Table 17. Test Equipment List

Note: Functionally tested equipment is verified using calibrated instrumentation at the time of testing.

End of Report