



**MET Laboratories, Inc.** *Safety Certification - EMI - Telecom Environmental Simulation*

914 WEST PATAPSCO AVENUE • BALTIMORE, MARYLAND 21230-3432 • PHONE (410) 354-3300 • FAX (410) 354-3313

33439 WESTERN AVENUE • UNION CITY, CALIFORNIA 94587 • PHONE (510) 489-6300 • FAX (510) 489-6372

3162 BELICK STREET • SANTA CLARA, CA 95054 • PHONE (408) 748-3585 • FAX (510) 489-6372

13501 MCCALLEN PASS • AUSTIN, TEXAS 78753 • PHONE (512) 287-2500 • FAX (512) 287-2513

November 11, 2015

Lutron Electronics Co., Inc.  
7200 Suter Road  
Coopersburg, PA 18036

Dear Prasad Kulkarni,

Enclosed is the EMC Wireless test report for compliance testing of the Lutron Electronics Co., Inc., P51 Bridge (External Antenna) as tested to the requirements of Title 47 of the CFR, Ch. 1 (10-1-06 ed.), FCC Part 15 Subpart C and RSS-210 Issue 8, December 2010 for Intentional Radiators.

Thank you for using the services of MET Laboratories, Inc. If you have any questions regarding these results or if MET can be of further service to you, please feel free to contact me.

Sincerely yours,  
MET LABORATORIES, INC.

Jennifer Warnell  
Documentation Department

Reference: (\Lutron Electronics Co., Inc.\EMC86446B-FCC231 Rev. 1)

Certificates and reports shall not be reproduced except in full, without the written permission of MET Laboratories, Inc. .



**MET Laboratories, Inc.** *Safety Certification - EMI - Telecom Environmental Simulation*

914 WEST PATAPSCO AVENUE • BALTIMORE, MARYLAND 21230-3432 • PHONE (410) 354-3300 • FAX (410) 354-3313

33439 WESTERN AVENUE • UNION CITY, CALIFORNIA 94587 • PHONE (510) 489-6300 • FAX (510) 489-6372

3162 BELICK STREET • SANTA CLARA, CA 95054 • PHONE (408) 748-3585 • FAX (510) 489-6372

13501 MCCALLEN PASS • AUSTIN, TEXAS 78753 • PHONE (512) 287-2500 • FAX (512) 287-2513

**Electromagnetic Compatibility Criteria  
Test Report**

for the

**Lutron Electronics Co., Inc.  
P51 Bridge (External Antenna)**

**Tested under**  
the FCC Certification Rules  
contained in  
Title 47 of the CFR, Part 15.231 Subpart C & RSS-210  
for Intentional Radiators

**MET Report: EMC86446B-FCC231 Rev. 1**

November 11, 2015

**Prepared For:**

**Lutron Electronics Co., Inc.  
7200 Suter Road  
Coopersburg, PA 18036**

**Prepared By:**  
**MET Laboratories, Inc.**  
914 W. Patapsco Ave  
Baltimore, MD 21230

## Electromagnetic Compatibility Criteria Test Report

for the

**Lutron Electronics Co., Inc.**  
**P51 Bridge (External Antenna)**

**Tested under**  
the FCC Certification Rules  
contained in  
Title 47 of the CFR, Part 15.231 Subpart C & RSS-210  
for Intentional Radiators



Benjamin Taylor, Project Engineer  
Electromagnetic Compatibility Lab



Jennifer Warnell  
Documentation Department

**Engineering Statement:** The measurements shown in this report were made in accordance with the procedures indicated, and the emissions from this equipment were found to be within the limits applicable. I assume full responsibility for the accuracy and completeness of these measurements, and for the qualifications of all persons taking them. It is further stated that upon the basis of the measurements made, the equipment tested is capable of operation in accordance with the requirements of FCC Rules Part 15.231 and Industry Canada standard RSS-210 Issue 8, December 2010 under normal use and maintenance.



Asad Bajwa  
Director, Electromagnetic Compatibility Lab

## Report Status Sheet

Revision	Report Date	Reason for Revision
∅	November 2, 2015	Initial Issue.
1	November 11, 2015	Engineer corrections.

## Table of Contents

<b>I.</b>	<b>Executive Summary .....</b>	<b>1</b>
	A. Purpose of Test .....	2
	B. Executive Summary .....	2
<b>II.</b>	<b>Equipment Configuration .....</b>	<b>3</b>
	A. Overview .....	4
	B. References .....	4
	C. Test Site .....	5
	D. Description of Test Sample .....	5
	E. Ports and Cabling Information .....	5
	F. Mode of Operation .....	6
	G. Monitoring Method .....	6
	H. Modifications .....	6
	a) Modifications to EUT .....	6
	b) Modifications to Test Standard .....	6
	I. Disposition of EUT .....	6
<b>III.</b>	<b>Electromagnetic Compatibility Criteria for Intentional Radiators .....</b>	<b>7</b>
	§ 15.203 Antenna Requirement .....	8
	§ 15.231(a) Periodic Operation Requirements .....	9
	§ 15.231(c) Field Strength of Fundamental and Harmonics .....	10
	§ 15.231(c) 20dB Bandwidth .....	14
<b>IV.</b>	<b>Test Equipment .....</b>	<b>16</b>
<b>V.</b>	<b>Certification &amp; User's Manual Information .....</b>	<b>18</b>
	A. Certification Information .....	19
	B. Label and User's Manual Information .....	23

## List of Tables

Table 1. Executive Summary of EMC Part 15.231 Compliance Testing .....	2
Table 2. EUT Summary Table.....	4
Table 3. References .....	4
Table 4. Ports and Cabling Information .....	5
Table 5. 20dB Bandwidth Requirement Test Results.....	14
Table 6. Test Equipment List .....	17

## List of Plots

Plot 1. Duty Cycle Correction Factor Measurements .....	11
Plot 2. Fundamental Field Strength, 431 MHz with DCCF, Lowest TX Power .....	12
Plot 3. Fundamental Field Strength, 437 MHz with DCCF, Lowest TX Power .....	12
Plot 4. Spurious Emissions, 430 MHz, 30 MHz – 1 GHz .....	13
Plot 5. Spurious Emissions, 430 MHz, 1 GHz – 5 GHz.....	13
Plot 6. Spurious Emissions, 437 MHz, 1 GHz – 5 GHz.....	13

## List of Figures

Figure 1. Block Diagram of Test Configuration.....	5
--	---

## List of Terms and Abbreviations

<b>AC</b>	<b>Alternating Current</b>
<b>ACF</b>	<b>Antenna Correction Factor</b>
<b>Cal</b>	<b>Calibration</b>
<i>d</i>	<b>Measurement Distance</b>
<b>dB</b>	<b>Decibels</b>
<b>dB<math>\mu</math>A</b>	<b>Decibels above one microamp</b>
<b>dB<math>\mu</math>V</b>	<b>Decibels above one microvolt</b>
<b>dB<math>\mu</math>A/m</b>	<b>Decibels above one microamp per meter</b>
<b>dB<math>\mu</math>V/m</b>	<b>Decibels above one microvolt per meter</b>
<b>DC</b>	<b>Direct Current</b>
<b>E</b>	<b>Electric Field</b>
<b>EUT</b>	<b>Equipment Under Test</b>
<i>f</i>	<b>Frequency</b>
<b>FCC</b>	<b>Federal Communications Commission</b>
<b>GRP</b>	<b>Ground Reference Plane</b>
<b>H</b>	<b>Magnetic Field</b>
<b>HCP</b>	<b>Horizontal Coupling Plane</b>
<b>Hz</b>	<b>Hertz</b>
<b>kHz</b>	<b>kilohertz</b>
<b>kPa</b>	<b>kilopascal</b>
<b>kV</b>	<b>kilovolt</b>
<b>LISN</b>	<b>Line Impedance Stabilization Network</b>
<b>MHz</b>	<b>Megahertz</b>
<b><math>\mu</math>H</b>	<b>microhenry</b>
<b><math>\mu</math></b>	<b>microfarad</b>
<b><math>\mu</math>s</b>	<b>microseconds</b>
<b>PRF</b>	<b>Pulse Repetition Frequency</b>
<b>RF</b>	<b>Radio Frequency</b>
<b>RMS</b>	<b>Root-Mean-Square</b>
<b>TWT</b>	<b>Traveling Wave Tube</b>
<b>V/m</b>	<b>Volts per meter</b>
<b>VCP</b>	<b>Vertical Coupling Plane</b>

# I. Executive Summary



## A. Purpose of Test

An EMC evaluation was performed to determine compliance of the Lutron Electronics Co., Inc. P51 Bridge (External Antenna), with the requirements of Part 15, §15.231. All references are to the most current version of Title 47 of the Code of Federal Regulations in effect. In accordance with §2.1033, the following data is presented in support of the Certification of the P51 Bridge (External Antenna). Lutron Electronics Co., Inc. should retain a copy of this document which should be kept on file for at least two years after the manufacturing of the P51 Bridge (External Antenna), has been **permanently** discontinued.

## B. Executive Summary

The following tests were conducted on a sample of the equipment for the purpose of demonstrating compliance with Part 15, §15.231, in accordance with Lutron Electronics Co., Inc., purchase order number 392149. All tests were conducted using measurement procedure ANSI C63.4-2014.

FCC Reference	IC Reference	Description	Results
§15.203	N/A	Antenna Requirement	Compliant
§15.231(a)	RSS-210 (A1.1.1)	Periodic Operation Requirements	Compliant
§15.231(b)	RSS-210 (A1.1)	Field Strength of Fundamentals and Harmonics	Compliant
§15.231(c)	RSS-210 (A1.1.3)	20dB Bandwidth	Compliant

**Table 1. Executive Summary of EMC Part 15.231 Compliance Testing**

## II. Equipment Configuration

## A. Overview

MET Laboratories, Inc. was contracted by Lutron Electronics Co., Inc. to perform testing on the P51 Bridge (External Antenna), under Lutron Electronics Co., Inc.'s purchase order number 392149.

This document describes the test setups, test methods, required test equipment, and the test limit criteria used to perform compliance testing of the Lutron Electronics Co., Inc., P51 Bridge (External Antenna).

The results obtained relate only to the item(s) tested.

<b>Model(s) Tested:</b>	P51 Bridge (External [Helical] Antenna)	
<b>Model(s) Covered:</b>	P51 Bridge (External [Helical] Antenna)	
<b>EUT Specifications:</b>	Primary Power: 120 VAC, 60 Hz	
	FCC ID: JPZ0113 IC: 2851A-JZ0113	
	Max Field Strength:	79.64 dBuV/m
	EUT Frequency Ranges:	431 – 437 MHz
<b>Analysis:</b>	The results obtained relate only to the item(s) tested.	
<b>Environmental Test Conditions:</b>	Temperature: 15-35° C	
	Relative Humidity: 30-60%	
	Barometric Pressure: 860-1060 mbar	
<b>Evaluated by:</b>	Benjamin Taylor	
<b>Report Date(s):</b>	November 11, 2015	

Table 2. EUT Summary Table

## B. References

<b>CFR 47, Part 15, Subpart C</b>	Federal Communication Commission, Code of Federal Regulations, Title 47, Part 15: General Rules and Regulations, Allocation, Assignment, and Use of Radio Frequencies
<b>ANSI C63.4:2014</b>	Methods and Measurements of Radio-Noise Emissions from Low-Voltage Electrical And Electronic Equipment in the Range of 9 kHz to 40 GHz
<b>ISO/IEC 17025:2005</b>	General Requirements for the Competence of Testing and Calibration Laboratories
<b>ANSI C63.10-2013</b>	American National Standard for Testing Unlicensed Wireless Devices
<b>RSS-210, Issue 8, Dec. 2010</b>	Low-power Licence-exempt Radiocommunications Devices (All Frequency Bands): Category I Equipment
<b>RSS-GEN, Issue 4, Nov. 2014</b>	General Requirements and Information for the Certification of Radio Apparatus

Table 3. References

### C. Test Site

All testing was performed at MET Laboratories, Inc., 914 W. Patapsco Ave., Baltimore, MD 21230. All equipment used in making physical determinations is accurate and bears recent traceability to the National Institute of Standards and Technology.

Radiated Emissions measurements were performed in a 3 meter semi-anechoic chamber (equivalent to an Open Area Test Site). In accordance with §2.948(a)(3), a complete site description is contained at MET Laboratories.

### D. Description of Test Sample

The Lutron Electronics Co., Inc. P51 Bridge, Equipment Under Test (EUT), is a ceiling mounted WiFi enabled device which is used for the commissioning of the devices working on proprietary wireless protocol clear connect. Users can connect to P51 WiFi which acts as an access point via smart phones and can control and monitor various features using web based application. It is intended to be used by facility manager, electrical contractor, and energy service companies within a building.

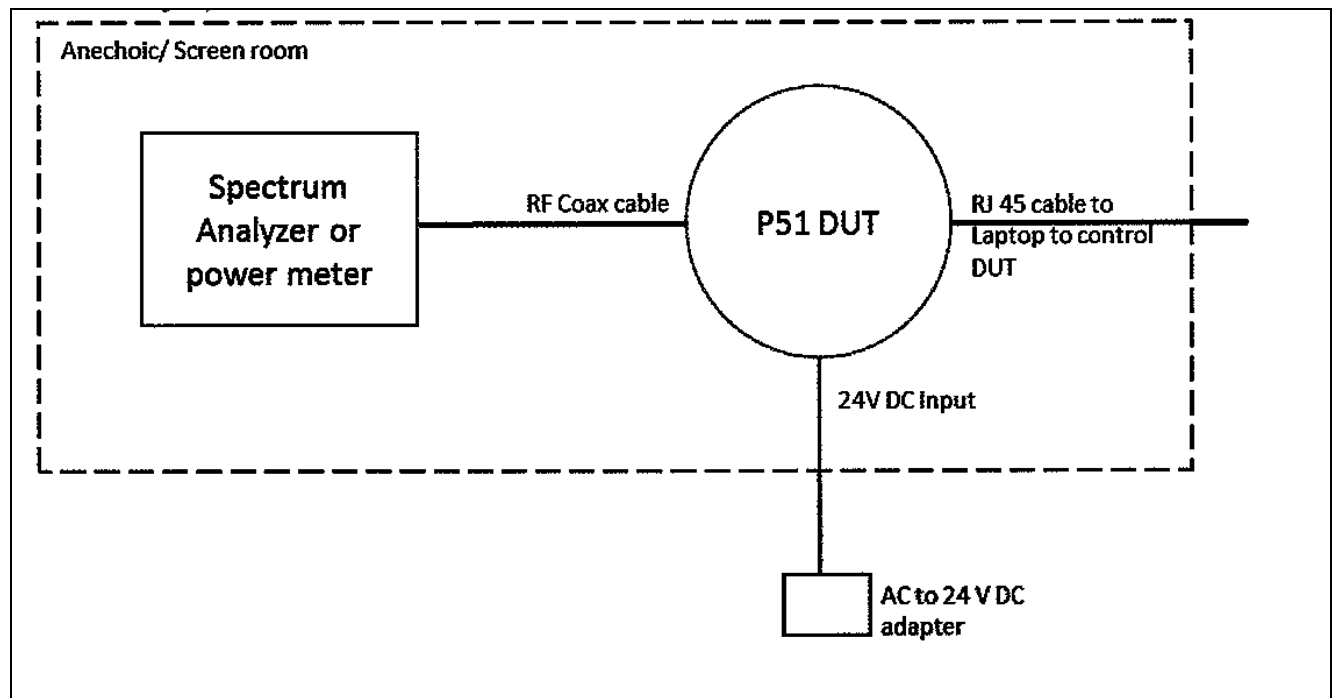

Figure 1. Block Diagram of Test Configuration

### E. Ports and Cabling Information

Ref. ID	Port Name on EUT	Cable Description	Qty.	Length (m)	Shielded (Y/N)	Termination Point
1	Data	RJ45 Ethernet cable	1	--	Yes	Laptop
2	DC Input	2 wires, 16-18 awg	1	2	No	AC to DC adapter
3	RF output	RF coaxial cable	1	0.3	Yes	Spectrum Analyzer

Table 4. Ports and Cabling Information

## **F. Mode of Operation**

EUT shall be working on IEEE 802.11 b/g/n standard during its normal operation. During this operation, EUT can communicate on different data rates (around 20 different data rates) and different channels in 2.4 GHz ISM band.

Example: Test Mode – In normal operation, EUT shall be sending IEEE802.11 b/g/n packets to communicate with clients and other access points. This communication can happen on any of the 20n different data rates and 11 different channels. For testing purposes, DUT will be configured to transmit continuous packets at maximum power on lowest, highest, and middle channels. DUT shall be configured for particular data rate and channel and power level using a software running on PC/Laptop via RJ45 Ethernet cable. Once configured to transmit, DUT shall continuously transmit as long as stop command is send via control software manually.

With a tact switch button presses the EUT will cycle between receive mode, Constant Packet mode and Continuous wave mode. Double tap of the tact switch changes the operating frequency of the DUT.

## **G. Monitoring Method**

The transmit power measured on Spectrum Analyzer in the 2.4 GHz and 431 to 437 MHz band shall be used as monitoring method if DUT is continuously transmitting or not.

## **H. Modifications**

### **a) Modifications to EUT**

No modifications were made to the EUT.

### **b) Modifications to Test Standard**

No modifications were made to the test standard.

## **I. Disposition of EUT**

The test sample including all support equipment submitted to the Electro-Magnetic Compatibility Lab for testing was returned to Lutron Electronics Co., Inc. upon completion of testing.

### **III. Electromagnetic Compatibility Criteria for Intentional Radiators**

## Electromagnetic Compatibility Criteria for Intentional Radiators

### § 15.203 Antenna Requirement

**Test Requirement:** § 15.203: An intentional radiator shall be designed to ensure that no antenna other than that furnished by the responsible party shall be used with the device. The use of a permanently attached antenna or of an antenna that uses a unique coupling to the intentional radiator shall be considered sufficient to comply with the provisions of this section. The manufacturer may design the unit so that a broken antenna can be replaced by the user, but the use of a standard antenna jack or electrical connector is prohibited.

The structure and application of the EUT were analyzed to determine compliance with Section 15.203 of the Rules. Section 15.203 states that the subject device must meet at least one of the following criteria:

- a.) Antenna must be permanently attached to the unit.
- b.) Antenna must use a unique type of connector to attach to the EUT.
- c.) Unit must be professionally installed. Installer shall be responsible for verifying that the correct antenna is employed with the unit.

**Results:** The EUT as tested is compliant with the criteria of §15.203. The EUT employs integrated antennas.

**Test Engineer(s):** Benjamin Taylor

**Test Date(s):** 09/08/15

## Electromagnetic Compatibility Criteria for Intentional Radiators

### § 15.231 (a) Periodic Operation Requirements

- Test Requirement(s):** § 15.231 (a): (a) The provisions of this section are restricted to periodic operation within the band 40.66–40.70 MHz and above 70 MHz. Except as shown in paragraph (e) of this section, the intentional radiator is restricted to the transmission of a control signal such as those used with alarm systems, door openers, remote switches, etc. Continuous trans-missions, voice, video and the radio control of toys are not permitted. Data is permitted to be sent with a control signal. The following conditions shall be met to comply with the provisions for this periodic operation: (1) A manually operated transmitter shall employ a switch that will automatically deactivate the transmitter within not more than 5 seconds of being released. (2) A transmitter activated automatically shall cease transmission within 5 seconds after activation.
- Test Procedure:** Per manufacturer declaration, the EUT ceases transmission within 5 seconds. A manual switch is not employed under typical operation (and so not able to be tested as such).
- Test Results:** The EUT was compliant with the requirements of this section.
- Test Engineer(s):** Benjamin Taylor
- Test Date(s):** 09/09/15



## Electromagnetic Compatibility Criteria for Intentional Radiators

### § 15.231(b) Field Strength of Fundamental and Harmonics

**Test Requirements:** §15.231(b): In addition to the provisions of §15.205, the field strength of emissions from intentional radiators operated under this section shall not exceed the following:

Fundamental frequency (MHz)	Field strength of fundamental (microvolts/ meter)	Field strength of spurious emissions (microvolts/meter)
40.66– 40.70	2,250	225
70–130	1,250	125
130–174	1,250* to 3,750	125* to 375
174–260	3,750	375
260–470	3,750* to 12,500	375* to 1,250
Above 470	12,500	1,250
<b>Note:</b> * Linear Interpolations		

(1) The above field strength limits are specified at a distance of 3 meters. The tighter limits apply at the band edges. (2) Intentional radiators operating under the provisions of this section shall demonstrate compliance with the limits on the field strength of emissions, as shown in the above table, based on the average value of the measured emissions. As an alternative, compliance with the limits in the above table may be based on the use of measurement instrumentation with a CISPR quasi-peak detector. The specific method of measurement employed shall be specified in the application for equipment authorization. If average emission measurements are employed, the provisions in §15.35 for averaging pulsed emissions and for limiting peak emissions apply. Further, compliance with the provisions of §15.205 shall be demonstrated using the measurement instrumentation specified in that section. (3) The limits on the field strength of the spurious emissions in the above table are based on the fundamental frequency of the intentional radiator. Spurious emissions shall be attenuated to the average (or, alternatively, CISPR quasi-peak) limits shown in this table or to the general limits shown in §15.209, whichever limit permits a higher field strength.

The field strength limit determined by the fundamental frequency of the EUT of 431 MHz, in accordance with 15.231(b), is not to exceed **80.73dBuV/m**, average value.

The field strength limit determined by the fundamental frequency of the EUT of 437 MHz, in accordance with 15.231(b), is not to exceed **80.93dBuV/m**, average value.

**Test Procedure:** The EUT was placed in a 3m semi anechoic chamber. A log periodic antenna was placed 3m from the EUT and used to measure the field strength of the fundamental. The EUT was rotated about all three orthogonal axis. The peak field strength was measured and then the average was calculated from the peak value by correcting for duty cycle. The duty cycle correction factor was calculated by  $20 \log$  (on time/period).

Plot 1 illustrates the duty cycle correction factor that was applied towards the fundamental emission measurement.

$$20 \log (6.04\text{mS}/74.962\text{mS}) = -21.87\text{dB} \text{ (maximum DCCF is } -20\text{dB)}$$

**Test Results:** Equipment complies with § 15.231 (b). The “low power” TX firmware build was necessary for compliance.

**Test Engineer:** Benjamin Taylor

**Test Date:** 09/09/15

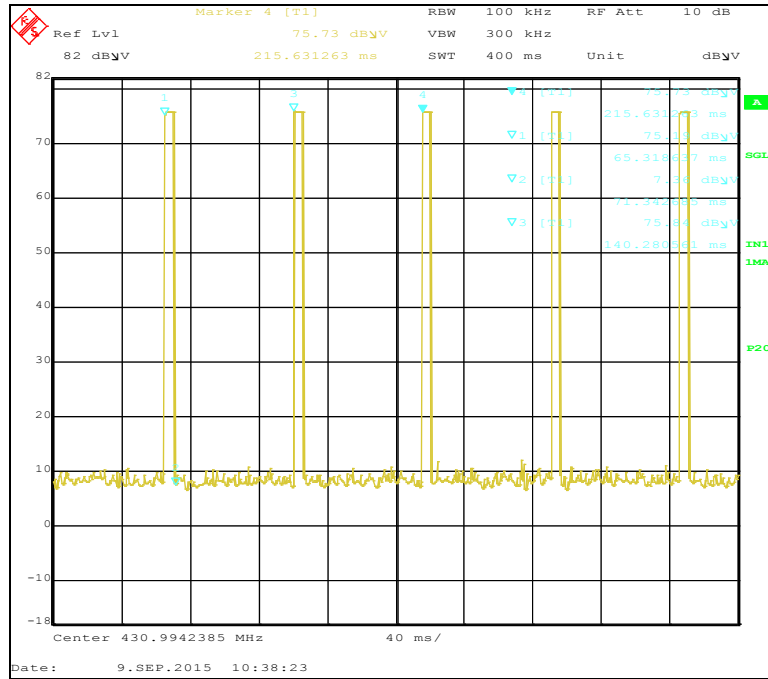

**Plot 1. Duty Cycle Correction Factor Measurements**

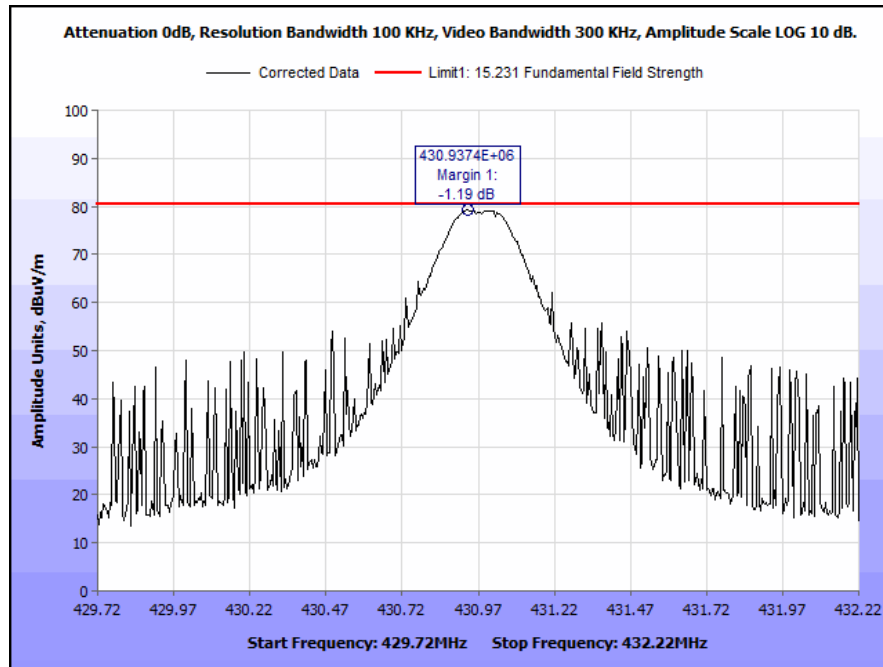

Plot 2. Fundamental Field Strength, 431 MHz with DCCF, Lowest TX Power

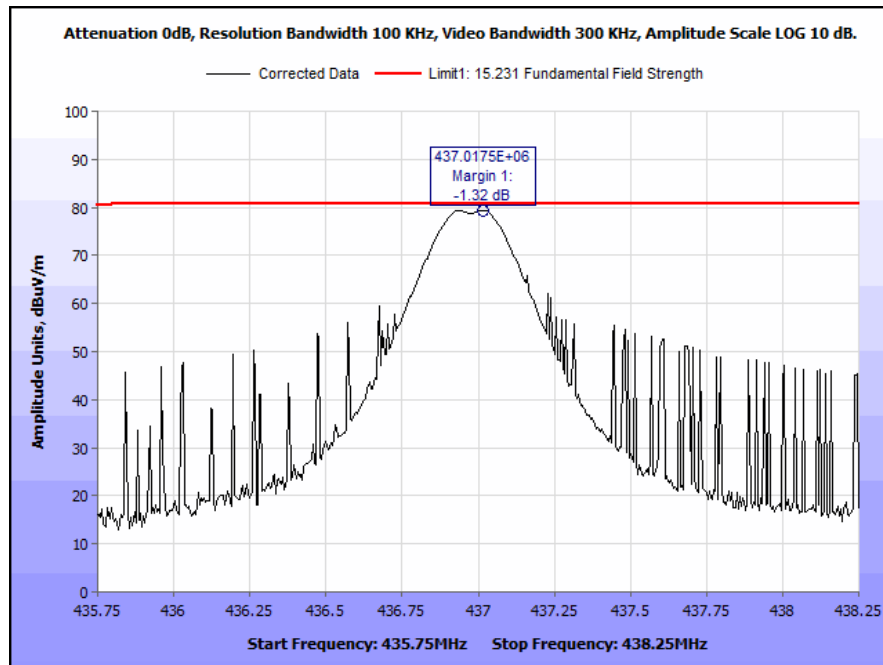

Plot 3. Fundamental Field Strength, 437 MHz with DCCF, Lowest TX Power

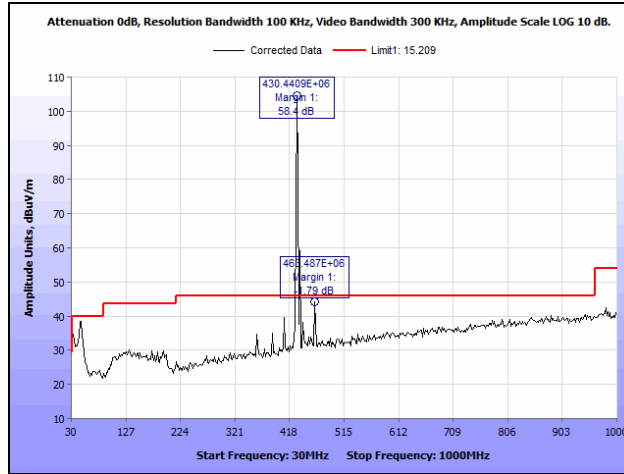

**Plot 4. Spurious Emissions, 430 MHz, 30 MHz – 1 GHz**

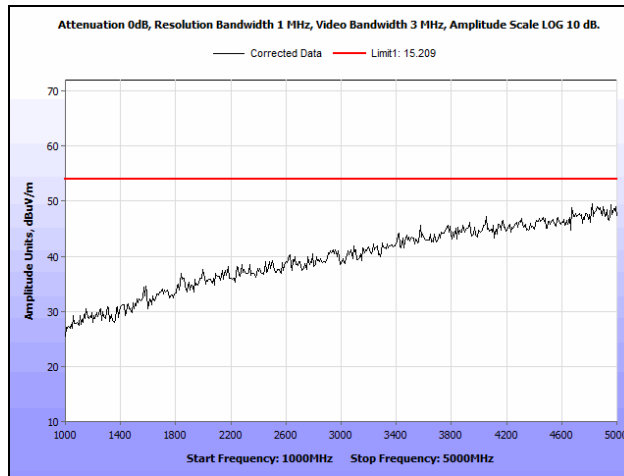

**Plot 5. Spurious Emissions, 430 MHz, 1 GHz – 5 GHz**

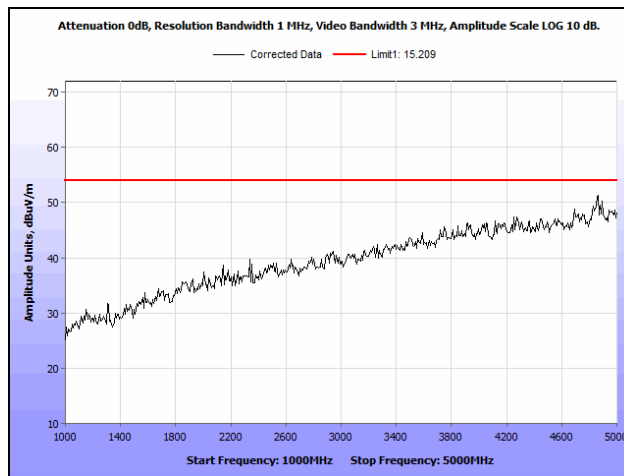

**Plot 6. Spurious Emissions, 437 MHz, 1 GHz – 5 GHz**

## Electromagnetic Compatibility Criteria for Intentional Radiators

### § 15.231(c) 20dB Bandwidth

**Test Requirements:** §15.231(c): The bandwidth of the emission shall be no wider than 0.25% of the center frequency for devices operating above 70MHz and below 900MHz. For devices operating above 900MHz, the emission shall be no wider than 0.5% of the center frequency. Bandwidth is determined at the points 20dB down from the modulated carrier.

**Test Results:** Equipment complies with § 15.231(c).

**Test Engineer:** Benjamin Taylor

**Test Date:** 09/09/15

Frequency (Mhz)	Occupied Bandwidth (kHz)	Limit (kHz)
431	400.8	1082.5
437	419.5	1082.5

Table 5. 20dB Bandwidth Requirement Test Results

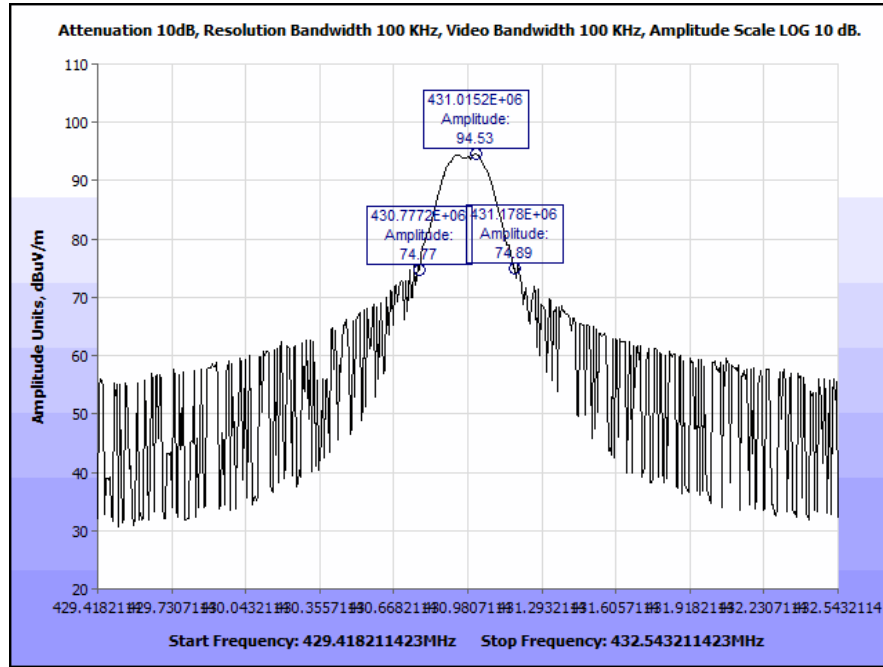

Plot 8. Occupied Bandwidth, 430.99 MHz

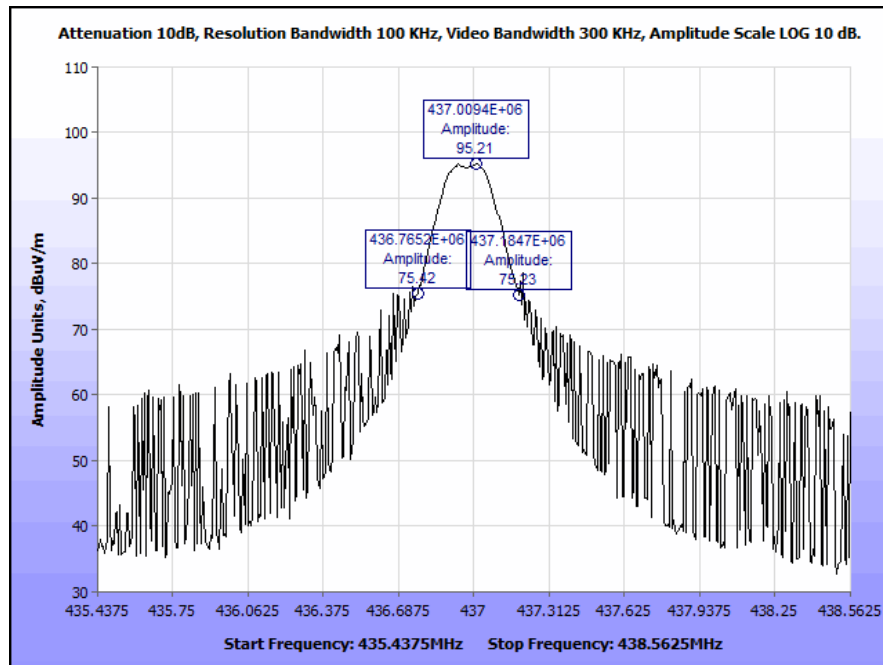

Plot 8. Occupied Bandwidth, 437 MHz

## IV. Test Equipment

## Test Equipment

Calibrated test equipment utilized during testing was maintained in a current state of calibration per the requirements of ISO/IEC 17025:2005.

MET #	Equipment	Manufacturer	Model#	Cal Date	Cal Due
1T4300	SEMI-ANECHOIC CHAMBER # 1 (NSA)	EMC TEST SYSTEMS	NONE	2/06/2015	2/06/2018
1T4751	ANTENNA - BILOG	SUNOL SCIENCES	JB6	7/20/2014	1/20/2016
1T4818	COMB GENERATOR	COM-POWER	CGO-520	SEE NOTE	
1T4870	THERM. / CLOCK / HUMIDITY MONITOR	CONTROL COMPANY	06-662-4, FB70258	3/14/2014	3/14/2016
1T4409	EMI RECEIVER	ROHDE & SCHWARZ	ESIB7	7/18/2014	7/18/2016
1T4483	ANTENNA; HORN	ETS-LINDGREN	3117	10/08/2015	4/08/2017

**Table 6. Test Equipment List**

Note: Functionally tested equipment is verified using calibrated instrumentation at the time of testing.



## **V. Certification & User's Manual Information**

## Certification & User's Manual Information

### A. Certification Information

The following is extracted from Title 47 of the Code of Federal Regulations, Part 2, Subpart I — Marketing of Radio frequency devices:

#### § 2.801 Radio-frequency device defined.

As used in this part, a radio-frequency device is any device which in its operation is capable of Emitting radio-frequency energy by radiation, conduction, or other means. Radio- frequency devices include, but are not limited to:

- (a) The various types of radio communication transmitting devices described throughout this chapter.
- (b) *The incidental, unintentional and intentional radiators defined in Part 15 of this chapter.*
- (c) The industrial, scientific, and medical equipment described in Part 18 of this chapter.
- (d) Any part or component thereof which in use emits radio-frequency energy by radiation, conduction, or other means.

#### § 2.803 Marketing of radio frequency devices prior to equipment authorization.

- (a) Except as provided elsewhere in this chapter, no person shall sell or lease, or offer for sale or lease (including advertising for sale or lease), or import, ship or distribute for the purpose of selling or leasing or offering for sale or lease, any radio frequency device unless:
  - (1) In the case of a device subject to certification, such device has been authorized by the Commission in accordance with the rules in this chapter and is properly identified and labeled as required by §2.925 and other relevant sections in this chapter; or
  - (2) In the case of a device that is not required to have a grant of equipment authorization issued by the Commission, but which must comply with the specified technical standards prior to use, such device also complies with all applicable administrative (including verification of the equipment or authorization under a Declaration of Conformity, where required), technical, labeling and identification requirements specified in this chapter.
- (d) Notwithstanding the provisions of paragraph (a) of this section, the offer for sale solely to business, commercial, industrial, scientific or medical users (but not an offer for sale to other parties or to end users located in a residential environment) of a radio frequency device that is in the conceptual, developmental, design or pre-production stage is permitted prior to equipment authorization or, for devices not subject to the equipment authorization requirements, prior to a determination of compliance with the applicable technical requirements *provided* that the prospective buyer is advised in writing at the time of the offer for sale that the equipment is subject to the FCC rules and that the equipment will comply with the appropriate rules before delivery to the buyer or to centers of distribution.

- (e)(1) Notwithstanding the provisions of paragraph (a) of this section, prior to equipment authorization or determination of compliance with the applicable technical requirements any radio frequency device may be operated, but not marketed, for the following purposes and under the following conditions:
- (i) *Compliance testing*;
  - (ii) Demonstrations at a trade show provided the notice contained in paragraph (c) of this section is displayed in a conspicuous location on, or immediately adjacent to, the device;
  - (iii) Demonstrations at an exhibition conducted at a business, commercial, industrial, scientific or medical location, but excluding locations in a residential environment, provided the notice contained in paragraphs (c) or (d) of this section, as appropriate, is displayed in a conspicuous location on, or immediately adjacent to, the device;
  - (iv) Evaluation of product performance and determination of customer acceptability, provided such operation takes place at the manufacturer's facilities during developmental, design or pre-production states; or
  - (v) Evaluation of product performance and determination of customer acceptability where customer acceptability of a radio frequency device cannot be determined at the manufacturer's facilities because of size or unique capability of the device, provided the device is operated at a business, commercial, industrial, scientific or medical user's site, but not at a residential site, during the development, design or pre-production stages.
- (e)(2) For the purpose of paragraphs (e)(1)(iv) and (e)(1)(v) of this section, the term *manufacturer's facilities* includes the facilities of the party responsible for compliance with the regulations and the manufacturer's premises, as well as the facilities of other entities working under the authorization of the responsible party in connection with the development and manufacture, but not the marketing, of the equipment.
- (f) For radio frequency devices subject to verification and sold solely to business, commercial, industrial, scientific and medical users (excluding products sold to other parties or for operation in a residential environment), parties responsible for verification of the devices shall have the option of ensuring compliance with the applicable technical specifications of this chapter at each end user's location after installation, provided that the purchase or lease agreement includes a proviso that such a determination of compliance be made and is the responsibility of the party responsible for verification of the equipment.

## Certification & User's Manual Information

The following is extracted from Title 47 of the Code of Federal Regulations, Part 2, Subpart J — Equipment Authorization Procedures:

### § 2.901 Basis and Purpose

- (a) In order to carry out its responsibilities under the Communications Act and the various treaties and international regulations, and in order to promote efficient use of the radio spectrum, the Commission has developed technical standards for radio frequency equipment and parts or components thereof. The technical standards applicable to individual types of equipment are found in that part of the rules governing the service wherein the equipment is to be operated.<sup>1</sup> *In addition to the technical standards provided, the rules governing the service may require that such equipment be verified by the manufacturer or importer, be authorized under a Declaration of Conformity, or receive an equipment authorization from the Commission by one of the following procedures: certification or registration.*
- (b) The following sections describe the verification procedure, the procedure for a Declaration of Conformity, and the procedures to be followed in obtaining certification from the Commission and the conditions attendant to such a grant.

### § 2.907 Certification.

- (a) Certification is an equipment authorization issued by the Commission, based on representation and test data submitted by the applicant.
- (b) Certification attaches to all units subsequently marketed by the grantee which are identical (see Section 2.908) to the sample tested except for permissive changes or other variations authorized by the Commission pursuant to Section 2.1043.

---

<sup>1</sup> In this case, the equipment is subject to the rules of Part 15. More specifically, the equipment falls under Subpart B (of Part 15), which deals with unintentional radiators.

## Certification & User's Manual Information

### § 2.948 Description of measurement facilities.

- (a) Each party making measurements of equipment that is subject to an equipment authorization under Part 15 or Part 18 of this chapter, regardless of whether the measurements are filed with the Commission or kept on file by the party responsible for compliance of equipment marketed within the U.S. or its possessions, shall compile a description of the measurement facilities employed.
- (1) If the measured equipment is subject to the verification procedure, the description of the measurement facilities shall be retained by the party responsible for verification of the equipment.
- (i) *If the equipment is verified through measurements performed by an independent laboratory, it is acceptable for the party responsible for verification of the equipment to rely upon the description of the measurement facilities retained by or placed on file with the Commission by that laboratory. In this situation, the party responsible for the verification of the equipment is not required to retain a duplicate copy of the description of the measurement facilities.*
- (ii) If the equipment is verified based on measurements performed at the installation site of the equipment, no specific site calibration data is required. It is acceptable to retain the description of the measurement facilities at the site at which the measurements were performed.
- (2) If the equipment is to be authorized by the Commission under the certification procedure, the description of the measurement facilities shall be filed with the Commission's Laboratory in Columbia, Maryland. The data describing the measurement facilities need only be filed once but must be updated as changes are made to the measurement facilities or as otherwise described in this section. At least every three years, the organization responsible for filing the data with the Commission shall certify that the data on file is current.

## Certification & User's Manual Information

### Label and User's Manual Information

The following is extracted from Title 47 of the Code of Federal Regulations, Part 15, Subpart A — General:

#### § 15.19 Labeling requirements.

(a) *In addition to the requirements in Part 2 of this chapter, a device subject to certification or verification shall be labeled as follows:*

- (1) Receivers associated with the operation of a licensed radio service, e.g., FM broadcast under Part 73 of this chapter, land mobile operation under Part 90, etc., shall bear the following statement in a conspicuous location on the device:

This device complies with Part 15 of the FCC Rules. Operation is subject to the condition that this device does not cause harmful interference.

- (2) A stand-alone cable input selector switch, shall bear the following statement in a conspicuous location on the device:

This device is verified to comply with Part 15 of the FCC Rules for use with cable television service.

- (3) All other devices shall bear the following statement in a conspicuous location on the device:

*This device complies with Part 15 of the FCC Rules. Operation is subject to the following two conditions: (1) This device may not cause harmful interference, and (2) this device must accept any interference received, including interference that may cause undesired operation.*

- (4) Where a device is constructed in two or more sections connected by wires and marketed together, the statement specified under paragraph (a) of this section is required to be affixed only to the main control unit.

- (5) When the device is so small or for such use that it is not practicable to place the statement specified under paragraph (a) of this section on it, the information required by this paragraph shall be placed in a prominent location in the instruction manual or pamphlet supplied to the user or, alternatively, shall be placed on the container in which the device is marketed. However, the FCC identifier or the unique identifier, as appropriate, must be displayed on the device.

#### § 15.21 Information to user.

The users manual or instruction manual for an intentional or unintentional radiator shall caution the user that changes or modifications not expressly approved by the party responsible for compliance could void the user's authority to operate the equipment.

## Verification & User's Manual Information

The following is extracted from Title 47 of the Code of Federal Regulations, Part 15, Subpart B — Unintentional Radiators:

### § 15.105 Information to the user.

- (a) For a Class A digital device or peripheral, the instructions furnished the user shall include the following or similar statement, placed in a prominent location in the text of the manual:

Note: This equipment has been tested and found to comply with the limits for a Class A digital device, pursuant to Part 15 of the FCC Rules. These limits are designed to provide reasonable protection against harmful interference when the equipment is operated in a commercial environment. This equipment generates, uses, and can radiate radio frequency energy and, if not installed and used in accordance with the instruction manual, may cause harmful interference to radio communications. Operation of this equipment in a residential area is likely to cause harmful interference in which case the user will be required to correct the interference at own expense.

- (b) For a Class B digital device or peripheral, the instructions furnished the user shall include the following or similar statement, placed in a prominent location in the text of the manual:

Note: This equipment has been tested and found to comply with the limits for a Class B digital device, pursuant to Part 15 of the FCC Rules. These limits are designed to provide reasonable protection against harmful interference when the equipment is operated in a residential environment. This equipment generates, uses, and can radiate radio frequency energy and, if not installed and used in accordance with the instruction manual, may cause harmful interference to radio communications. However, there is no guarantee that interference will not occur in a particular installation. If this equipment does cause harmful interference to radio or television reception, which can be determined by turning the equipment off and on, the user is encouraged to try to correct the interference by one or more of the following measures:

- Reorient or relocate the receiving antenna.
- Increase the separation between the equipment and receiver.
- Connect the equipment into an outlet on a circuit different from that to which the receiver is connected.
- Consult the dealer or an experienced radio/TV technician for help.

# End of Report