



Zacta

TEST REPORT

Report number : JPD-TR-17247-0

Issue date : December 29, 2017

The device, as described herewith, was tested pursuant to applicable test procedure and complies with the requirements of;

FCC Part15 Subpart C

The test results are traceable to the international or national standards.

Applicant	: KYOCERA Corporation
Equipment under test (EUT)	: Mobile Phone
Model number	: YKFA21
FCC ID	: JOYYKFA21

Date of test : November 27, 2017
December 5, 6, 15, 18, 19, 20, 2017

Test place : TÜV SÜD Zacta Ltd. Yonezawa Testing Center
5-4149-7, Hachimanpara, Yonezawa-shi,
Yamagata, 992-1128 Japan
Phone: +81-238-28-2881 Fax: +81-238-28-2888

Test results : Complied

The results in this report are applicable only to the equipment tested.
This report shall not be re-produced except in full without the written approval of TÜV SÜD Zacta Ltd.
This test report must not be used by the client to claim product certification, approval, or endorsement by NVLAP, NIST, ILAC-MRA, or any agency of the federal government.

Tested by : Tadahiro Seino Chiaki Kanno
Tadahiro Seino Chiaki Kanno

Tested by : Taiki Watanabe
Taiki Watanabe

Approved by : Hiroaki Suzuki
Hiroaki Suzuki
Lab Manager of RF Lab



Table of contents

	Page
1. Summary of Test	4
1.1 Purpose of test	4
1.2 Standards.....	4
1.3 List of applied test to the EUT.....	4
1.4 Modification to the EUT by laboratory.....	4
2. Equipment Under Test	5
2.1 General Description of equipment.....	5
2.2 EUT information	5
2.3 Variation of the family model(s)	6
2.4 Operating channels and frequencies	6
2.5 Operating mode.....	6
2.6 Operating flow	7
3. Configuration of equipment	8
3.1 Equipment(s) used	8
3.2 Cable(s) used.....	8
3.3 System configuration.....	8
4. 6dB Bandwidth	9
4.1 Measurement procedure	9
4.2 Limit	9
4.3 Measurement result.....	9
4.4 Trace data	10
5. Maximum Peak Output Power	11
5.1 Measurement procedure	11
5.2 Limit	11
5.3 Measurement result.....	11
6. Band Edge Compliance of RF Conducted Emissions	12
6.1 Measurement procedure	12
6.2 Limit	12
6.3 Measurement result.....	12
6.4 Trace data	13
7. Spurious emissions - Conducted -	14
7.1 Measurement procedure	14
7.2 Limit	14
7.3 Measurement result.....	14
7.4 Trace data	15
8. Spurious Emissions - Radiated -	18
8.1 Measurement procedure	18
8.2 Calculation method	19
8.3 Limit	19
8.4 Test data.....	20
9. Restricted Band of Operation	30
9.1 Measurement procedure	30
9.2 Limit	30



Zacta

9.3 Measurement Result	31
9.4 Test data.....	31
10. Transmitter Power Spectral Density.....	34
10.1 Measurement procedure	34
10.2 Limit	34
10.3 Measurement result.....	34
10.4 Trace data	35
11. AC Power Line Conducted Emissions.....	36
11.1 Measurement procedure	36
11.2 Calculation method	36
11.3 Limit.....	37
11.4 Test data.....	37
12. Antenna requirement.....	38
13. Uncertainty of measurement.....	39
14. Laboratory Information	40
Appendix A. Test equipment.....	41
Appendix B. Duty Cycle.....	42



Zacta

1. Summary of Test

1.1 Purpose of test

It is the original test in order to verify conformance to FCC Part 15 Subpart C.

1.2 Standards

CFR47 FCC Part 15 Subpart C

1.2.1 Test Methods

ANSI C63.10-2013, KDB558074 D01 DTS Meas Guidance v04

1.2.2 Deviation from standards

None

1.3 List of applied test to the EUT

Test items Section	Test items	Condition	Result
15.247(a)(2)	6dB Bandwidth	Conducted	PASS
15.247(b)(3)	Maximum Peak Output Power	Conducted	PASS
15.247(d)	Band Edge Compliance of RF Conducted Emissions	Conducted	PASS
15.247(d) 15.205 15.209	Spurious Emissions	Conducted Radiated	PASS
15.247(d) 15.205 15.209	Restricted Bands of Operation	Radiated	PASS
15.247(e)	Transmitter Power Spectral Density	Conducted	PASS
15.207	AC Power Line Conducted Emissions	Conducted	PASS

1.3.1 Test set up

Table-Top

1.4 Modification to the EUT by laboratory

None



2. Equipment Under Test

2.1 General Description of equipment

EUT is the Mobile Phone.

2.2 EUT information

Applicant	:	KYOCERA Corporation Yokohama Office 2-1-1 Kagahara, Tsuzuki-ku Yokohama-shi, Kanagawa, Japan Phone: +81-45-943-6253 Fax: +81-45-943-6314
Equipment under test	:	Mobile Phone
Trade name	:	Kyocera
Model number	:	YKFA21
Serial number	:	N/A
EUT condition	:	Pre-Production
Power ratings	:	Battery: DC 3.8V
Size	:	(W) 71.5mm × (D) 8.4mm × (H) 145.0mm
Environment	:	Indoor and Outdoor use
Terminal limitation	:	-20°C to 60°C
RF Specification Protocol	:	Bluetooth 4.2 + EDR
Frequency range	:	2402MHz-2480MHz
Number of RF Channels	:	40 Channels
Modulation method/ Data rate	:	GFSK (1Mbps)
Channel separation	:	2MHz
Conducted power	:	1.091mW
Antenna type	:	Internal antenna
Antenna gain	:	0.4dBi

2.3 Variation of the family model(s)

Not applicable

2.4 Operating channels and frequencies

Channel	Frequency [MHz]	Channel	Frequency [MHz]
0	2402	20	2442
1	2404	21	2444
2	2406	22	2446
3	2408	23	2448
4	2410	24	2450
5	2412	25	2452
6	2414	26	2454
7	2416	27	2456
8	2418	28	2458
9	2420	29	2460
10	2422	30	2462
11	2424	31	2464
12	2426	32	2466
13	2428	33	2468
14	2430	34	2470
15	2432	35	2472
16	2434	36	2474
17	2436	37	2476
18	2438	38	2478
19	2440	39	2480

2.5 Operating mode

The EUT had been tested under operating condition.
There are three channels have been tested as following:

Tested Channel	Frequency [MHz]
Low	2402
Middle	2440
High	2480

The pre-test has been conducted to determine the worst-case mode from all possible combinations between available modulations, data rates.

Tested Channel	Modulation Type	Data Rate
Low, Middle, High	GFSK	1Mbps

The field strength of spurious emissions was measured at each position of all three axis X, Y and Z to compare the level, and the maximum noise.

The worst emission was found in X axis and the worst case recorded.

2.6 Operating flow

[Tx mode]

- i) Test program setup to the DM tool
- ii) Select a Test mode
Operating frequency: Channel Low: 2402MHz, Channel Middle: 2440MHz, Channel High: 2480MHz
- iii) Start test mode

[Rx mode]

- i) Test program setup to the DM tool
- ii) Select a Test mode
Operating frequency: Channel Low: 2402MHz, Channel Middle: 2440MHz, Channel High: 2480MHz
- iii) Start test mode

3. Configuration of equipment

3.1 Equipment(s) used

No.	Equipment	Company	Model No.	Serial No.	FCC ID / DoC	Comment
1	Mobile Phone	KYOCERA	YKFA21	N/A	JOYYKFA21	EUT
2	AC Adapter	KYOCERA	AD03KC	N/A	N/A	*
3	USB conversion connector	ANKER	N/A	N/A	N/A	*

*: AC power line Conducted Emission Test.

3.2 Cable(s) used

No.	Cable	Length[m]	Shield	Connector	Comment
a	Micro USB cable(for AC Adapter)	1.0	Yes	Metal	*

*: AC power line Conducted Emission Test.

3.3 System configuration

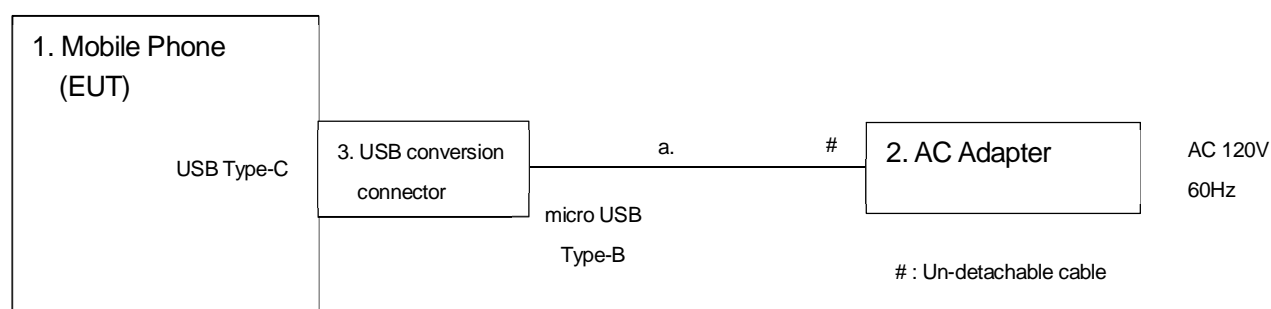

Note1: Numbers assigned to equipment or cables on this diagram correspond to the list in "3.1 Equipment(s) used" and "3.2 Cable(s) used".

4. 6dB Bandwidth

4.1 Measurement procedure

[FCC 15.247(a)(2), KDB558074 D01 v04, Section 8.2]

The bandwidth at 6dB down from the highest inband spectral density is measured with a spectrum analyzer connected to the antenna terminal, while EUT is operating in transmission mode at the appropriate center frequency.

The spectrum analyzer is set to;

- a) RBW = 100kHz.
- b) VBW \geq 3 x RBW.
- c) Sweep time = auto-couple.
- d) Detector = peak.
- e) Trace mode = max hold.

- Test configuration

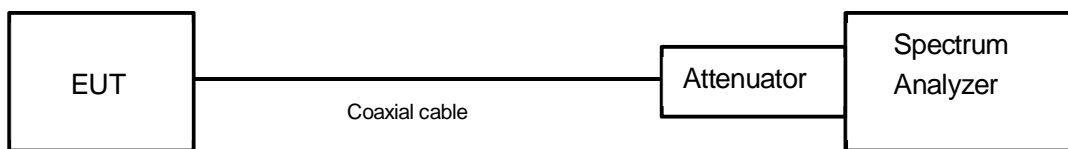

4.2 Limit

The minimum permissible 6dB bandwidth is 500kHz.

4.3 Measurement result

Date : November 27, 2017
 Temperature : 22.3 [°C]
 Humidity : 42.9 [%]
 Test place : Shielded room No.4

Test engineer : Chiaki Kanno

Channel	Frequency [MHz]	6dB bandwidth [MHz]
Low	2402	0.683
Middle	2440	0.682
High	2480	0.680



Zacta

4.4 Trace data

Channel Low

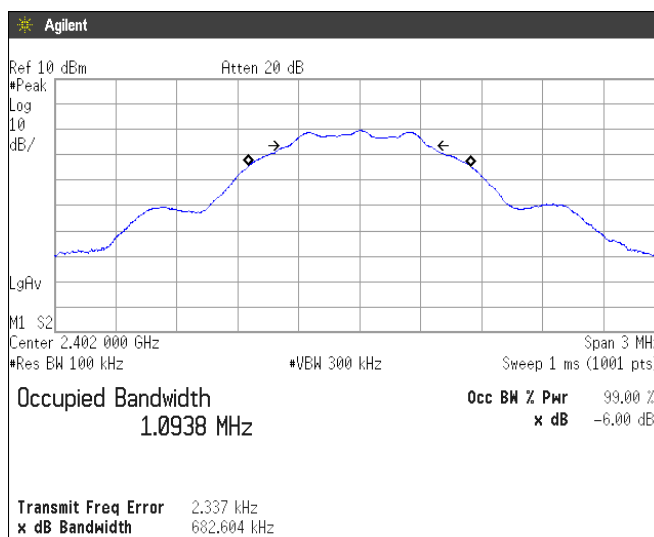

Channel Middle

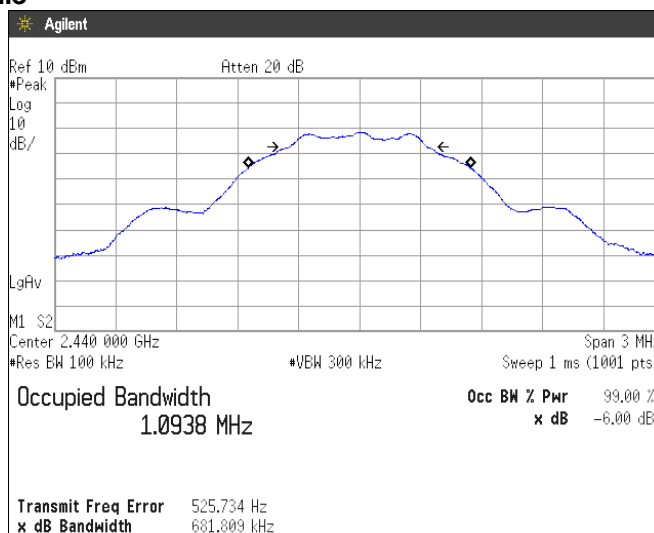

Channel High

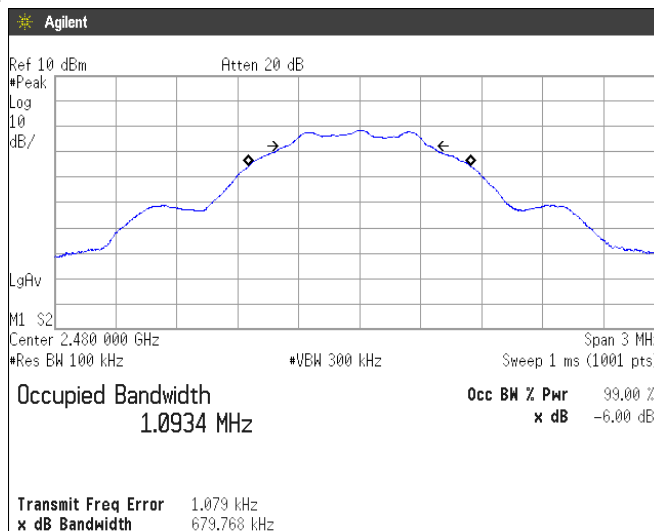

5. Maximum Peak Output Power

5.1 Measurement procedure

[FCC 15.247(b)(3), KDB558074 D01 v04, Section 9.1.3]

The peak power is measured with a power sensor connected to the antenna terminal, while EUT is operating in transmission mode at the appropriate center frequency.

- Test configuration

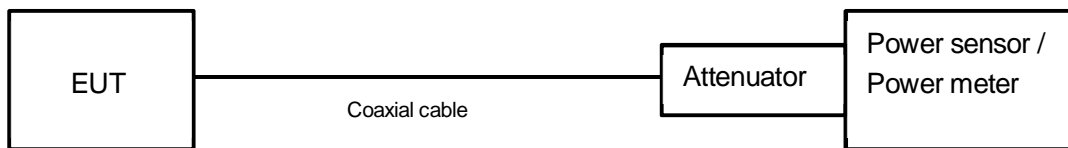

5.2 Limit

1W(1000mW) or less

5.3 Measurement result

Date : November 27, 2017
 Temperature : 22.3 [°C]
 Humidity : 42.9 [%]
 Test place : Shielded room No.4

Test engineer : Chiaki Kanno

Battery Full

Channel	Center Frequency (MHz)	Reading (dBm)	Factor (dB)	Level (dBm)	Peak Output Power (mW)	Limit (mW)	Result
Low	2402	-10.14	10.52	0.38	1.091	≤ 1000	PASS
Middle	2440	-11.08	10.52	-0.56	0.879	≤ 1000	PASS
High	2480	-11.08	10.52	-0.56	0.879	≤ 1000	PASS

Calculation;

$$\text{Reading (dBm)} + \text{Factor (dB)} = \text{Level (dBm)}$$

$$10\log P = \text{Level (dBm)}$$

$$P = 10^{(\text{Maximum Peak Output Power} / 10)} \text{ (mW)}$$

6. Band Edge Compliance of RF Conducted Emissions

6.1 Measurement procedure

[FCC 15.247(d), KDB558074 D01 v04, Section 11.0]

The Band Edge is measured with a spectrum analyzer connected to the antenna terminal, while EUT is operating in transmission mode at the appropriate center frequency.

The spectrum analyzer is set to;

- a) Span = Arbitrary setting. (Setting suitable for measurement.)
- b) RBW = 100kHz.
- c) VBW $\geq 3 \times$ RBW
- d) Sweep time = auto-couple.
- e) Detector = peak.
- f) Trace mode = max hold.

- Test configuration

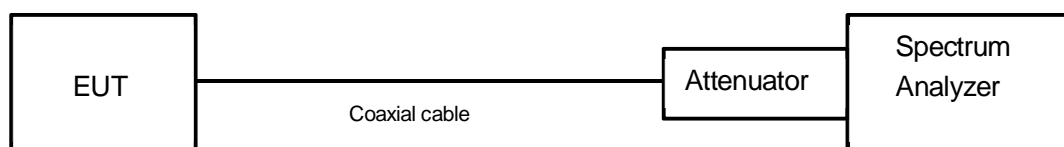

6.2 Limit

In any 100kHz bandwidth outside the frequency band the radio frequency power that is produced by the intentional radiator shall be at least 20dB below that in the 100kHz bandwidth within the band that contains the highest level of the desired power.

6.3 Measurement result

Date : November 27, 2017
 Temperature : 22.3 [°C]
 Humidity : 42.9 [%]
 Test place : Shielded room No.4

Test engineer : Chiaki Kanno

Channel	Frequency (MHz)	RF Power Level (dBm)	Band-edge Frequency (MHz)	Band-edge Level (dBm)	Difference Level (dBm)	Limit (dBm)	Result
Low	2402	-10.21	2399.85	-65.32	55.11	At least 20dB below from peak of RF	PASS
High	2480	-11.31	2491.65	-70.59	59.28	At least 20dB below from peak of RF	PASS



Zacta

6.4 Trace data

Channel Low

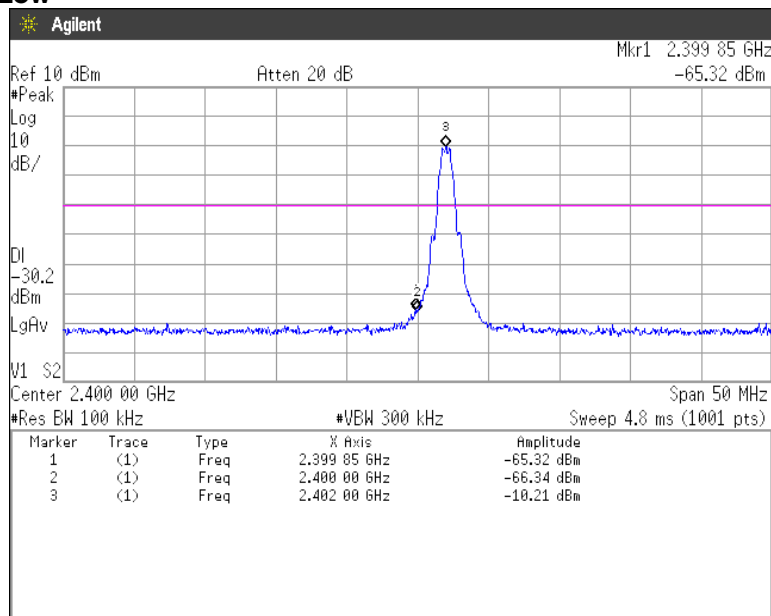

Channel High

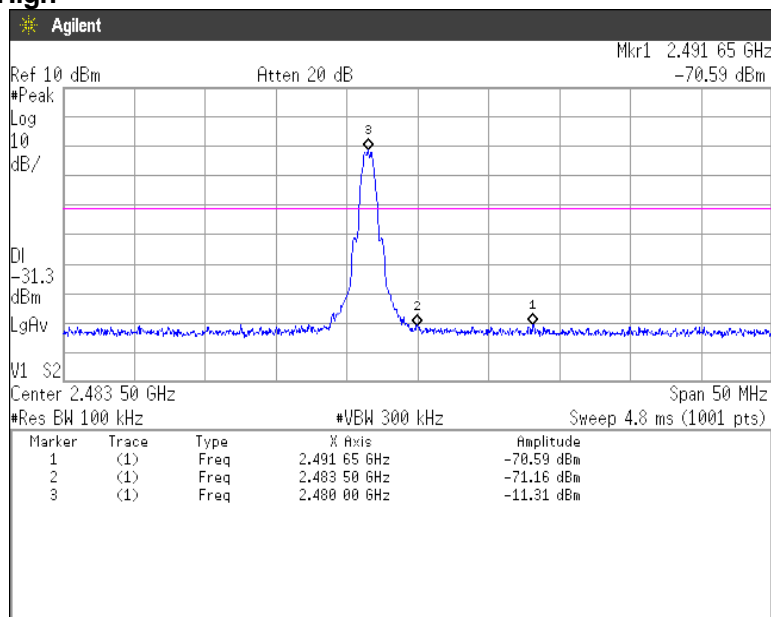

7. Spurious emissions - Conducted -

7.1 Measurement procedure

[FCC 15.247(d), KDB558074 D01 v04, Section 11.0]

The spurious emissions (Conducted) are measured with a spectrum analyzer connected to the antenna terminal, while EUT is operating in transmission mode at the appropriate center frequency.

The spectrum analyzer is set to;

- Span = wide enough to fully capture the emission being measured.
- RBW = 100 kHz.
- VBW \geq RBW.
- Sweep time = auto-couple.
- Detector = peak.
- Trace mode = max hold.

- Test configuration

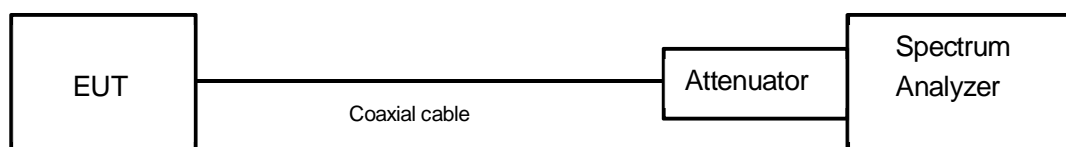

7.2 Limit

In any 100kHz bandwidth outside the frequency band the radio frequency power that is produced by the intentional radiator shall be at least 20dB below that in the 100kHz bandwidth within the band that contains the highest level of the desired power.

7.3 Measurement result

Date : November 27, 2017
 Temperature : 22.3 [°C]
 Humidity : 42.9 [%]
 Test place : Shielded room No.4

Test engineer :

Chiaki Kanno

Channel	Frequency [MHz]	Limit [dB]	Results Chart	Result
Low	2402	At least 20dB below from peak of RF	See the trace Data	PASS
Middle	2440	At least 20dB below from peak of RF	See the trace Data	PASS
High	2480	At least 20dB below from peak of RF	See the trace Data	PASS



Zacta

7.4 Trace data

Channel Low 30MHz-1GHz

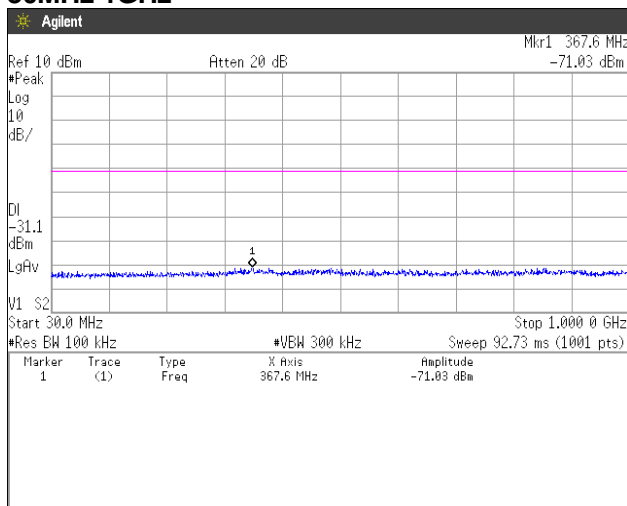

1GHz-5GHz

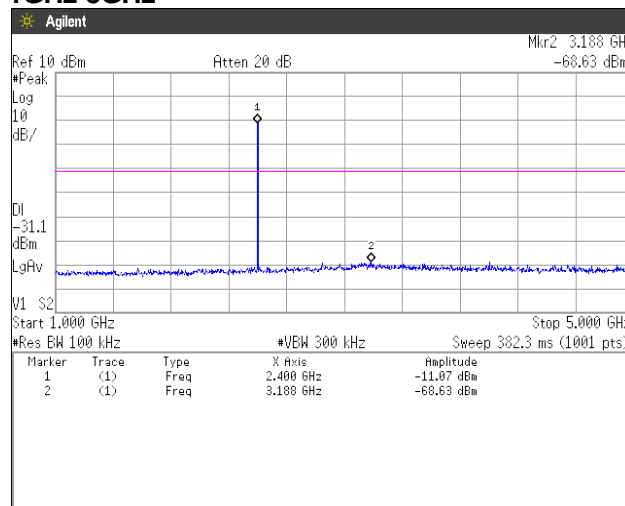

5GHz-10GHz

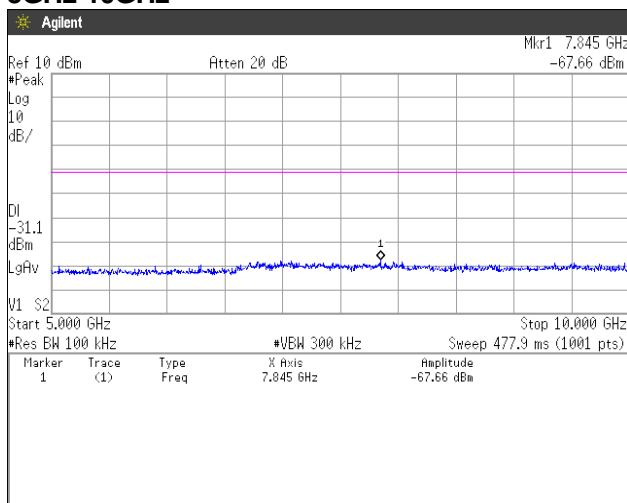

10GHz-15GHz

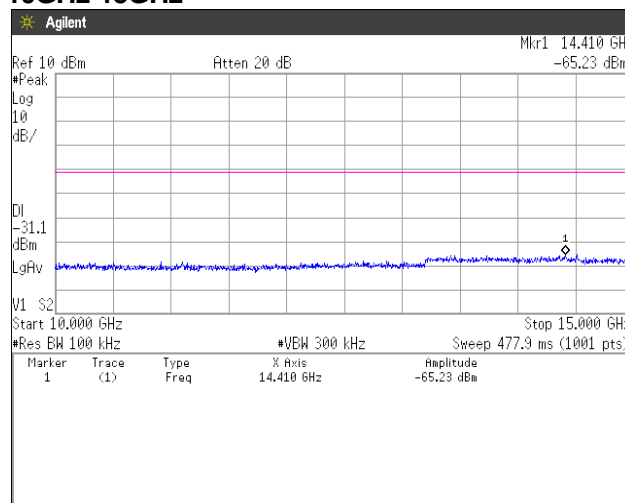

15GHz-20GHz

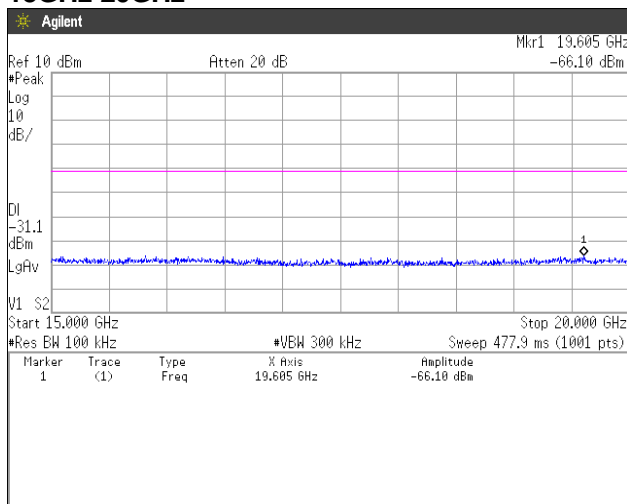

20GHz-25GHz

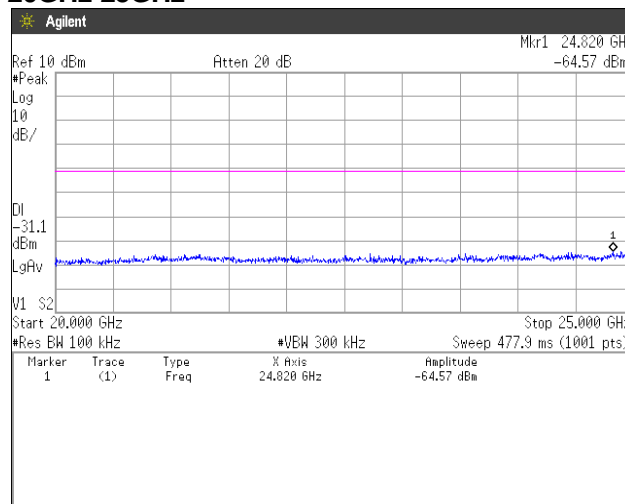



Zacta

Channel Middle 30MHz-1GHz

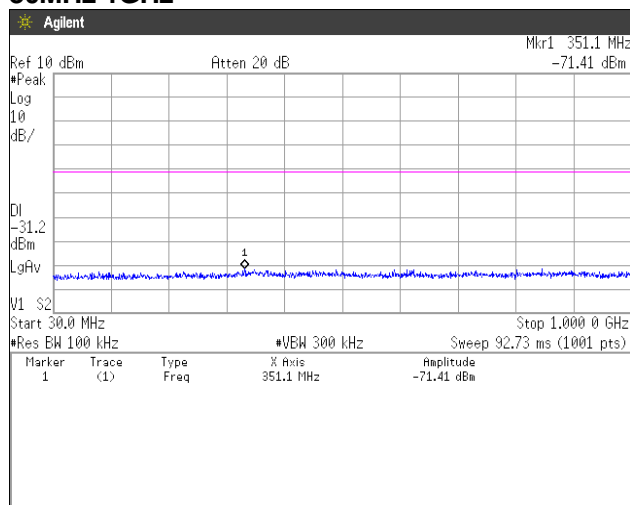

1GHz-5GHz

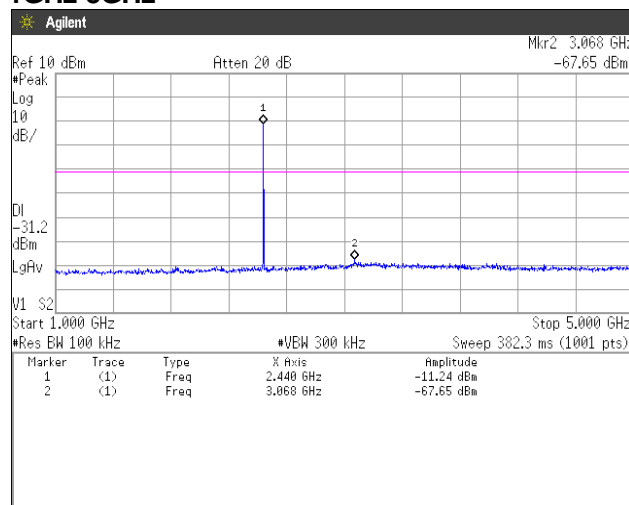

5GHz-10GHz

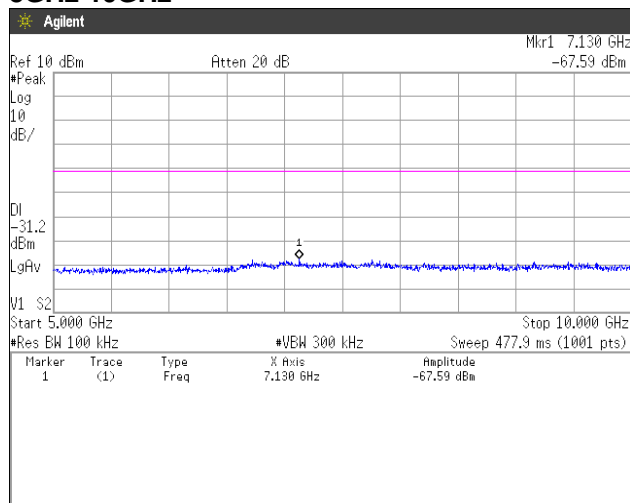

10GHz-15GHz

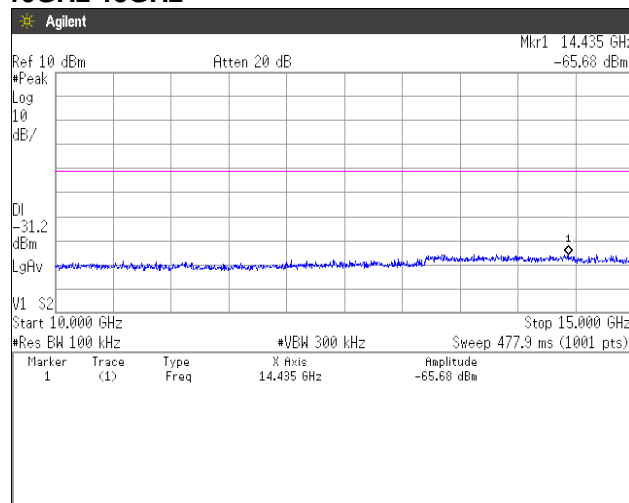

15GHz-20GHz

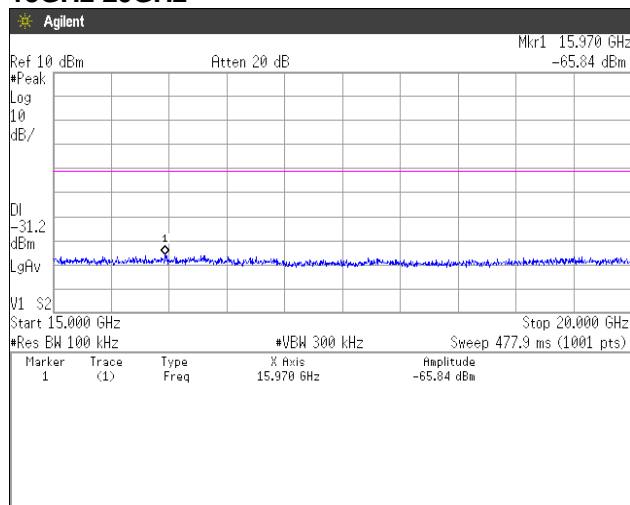

20GHz-25GHz

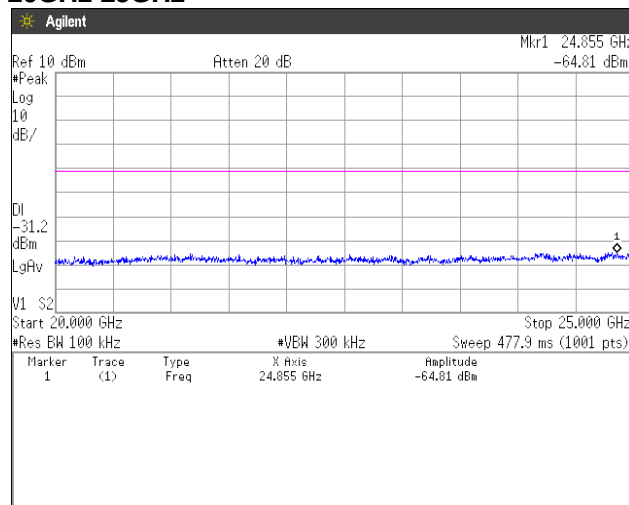



Zacta

Channel High 30MHz-1GHz

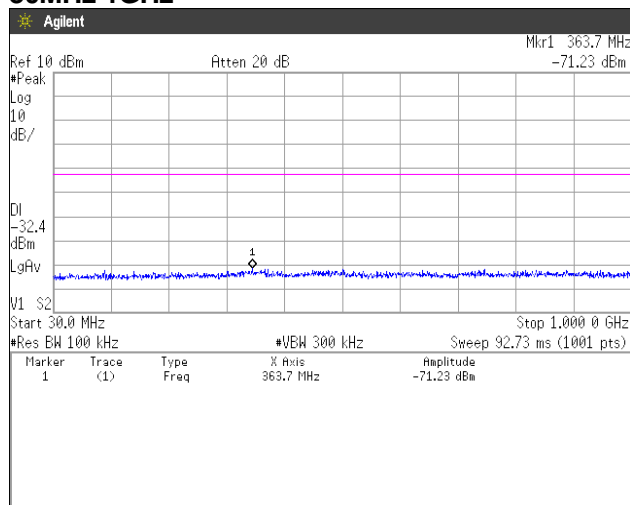

1GHz-5GHz

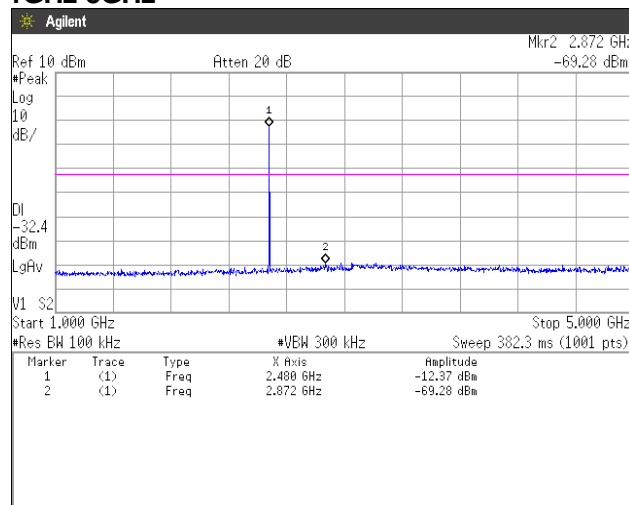

5GHz-10GHz

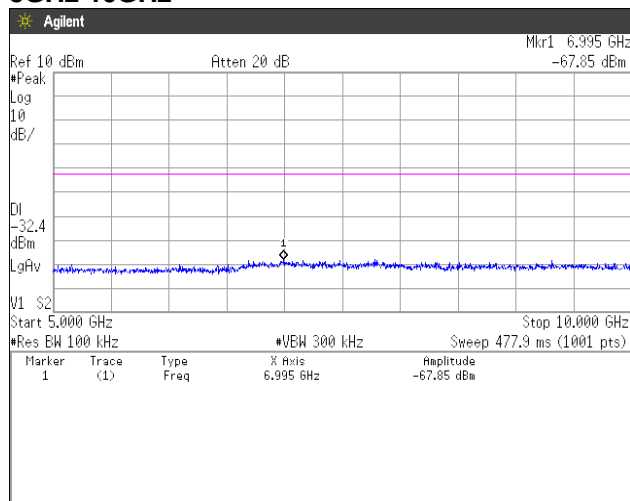

10GHz-15GHz

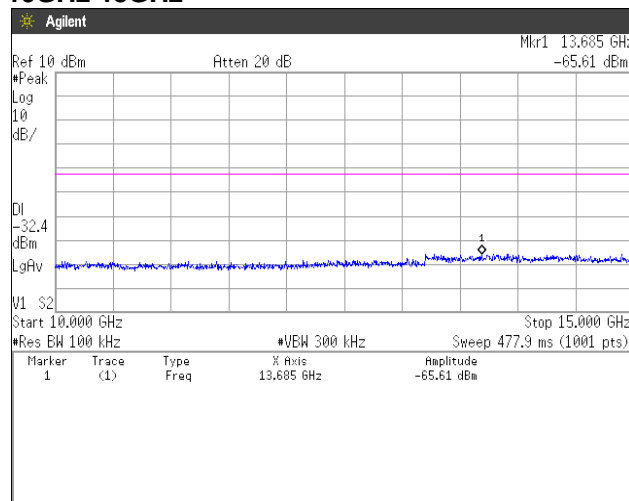

15GHz-20GHz

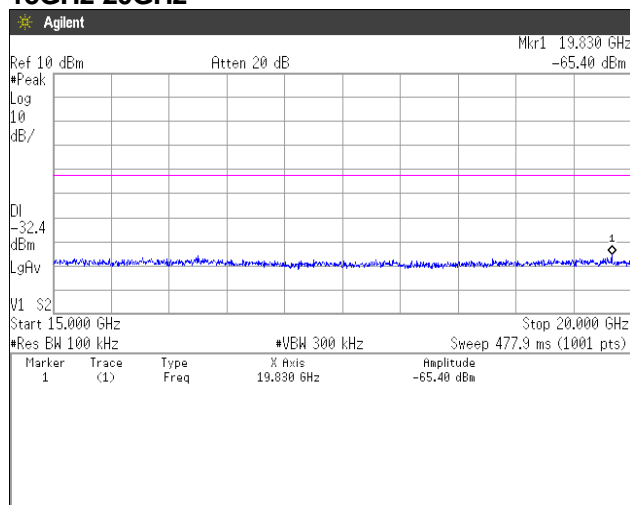

20GHz-25GHz

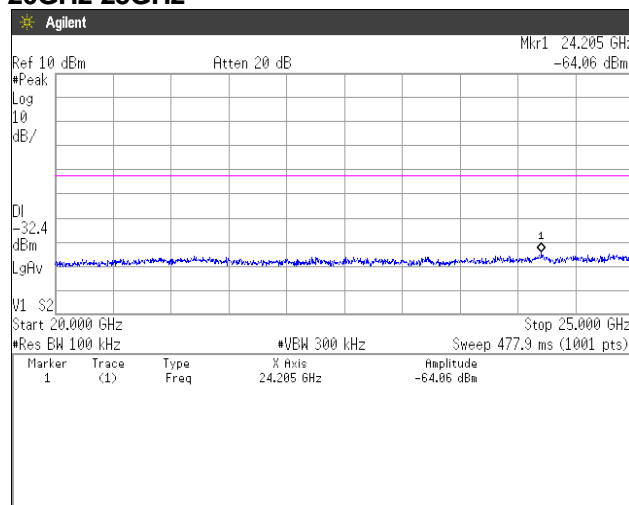

8. Spurious Emissions - Radiated -

8.1 Measurement procedure

[FCC 15.247(d), 15.205, 15.209, KDB 558074 D01 v04, Section 12.0]

Test was applied by following conditions.

Test method	:	ANSI C63.10
Frequency range	:	9kHz to 25GHz
Test place	:	3m Semi-anechoic chamber
EUT was placed on	:	Styrofoam table / (W)1.0m x (D)1.0m x (H)0.8m (below 1GHz) Styrofoam table / (W)0.6m x (D)0.6m x(H)1.5m (above 1GHz)
Antenna distance	:	3m
Test receiver setting	:	Below 1GHz
- Detector	:	Average (9kHz-90kHz, 110kHz-490kHz), Quasi-peak
- Bandwidth	:	200Hz, 120kHz
Spectrum analyzer setting	:	Above 1GHz
- Peak	:	RBW=1MHz, VBW=3MHz, Span=0Hz, Sweep=auto
- Average	:	RBW=1MHz, VBW=3kHz, Span=0Hz, Sweep=auto Display mode=Linear

Average Measurement Setting [VBW]

Mode	Duty Cycle (%)	T _{on} (us)	T _{off} (us)	1/T _{on} (kHz)	Determined VBW Setting
Bluetooth 4.2 LE	62.56	391	234	2.558	3kHz

Although these tests were performed other than open area test site, adequate comparison measurements were confirmed against 30 m open area test site.

Therefore sufficient tests were made to demonstrate that the alternative site produces results that correlate with the ones of tests made in an open field based on KDB 937606.

Radiated emission measurements are performed at 3m distance with the broadband antenna (Loop antenna, Biconical antenna, Log periodic antenna, Double ridged guide antenna and Broad-band horn Antenna). The antenna is positioned both the horizontal and vertical planes of polarization and height is varied 1m to 4m and stopped at height producing the maximum emission. As for the Loop antenna, it is positioned with its plane vertical, and the center of the Loop antenna is 1m above the ground plane.

The EUT is Placed on a turntable, which is 0.8m/1.5m above ground plane. The turntable shall be rotated for 360 degrees to determine the position of maximum emission level. The test results represent the worst case emission for each emission with manipulating the EUT, support equipment, interconnecting cables and varying the mode of operation. Sufficient time for the EUT, support equipment, and test equipment are allowed in order for them to warm up to their normal operating condition.

- Test configuration

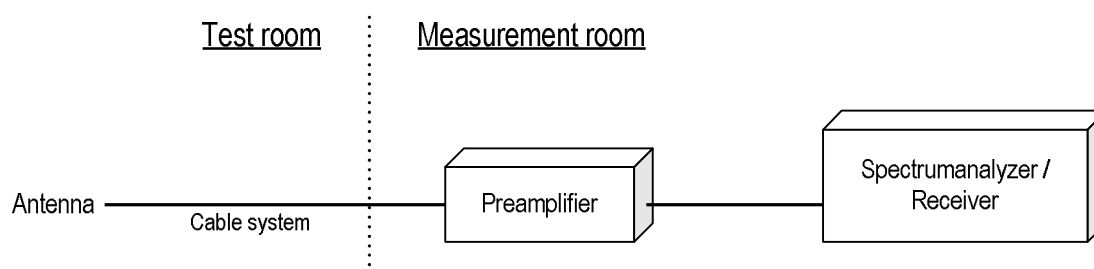

8.2 Calculation method

[9kHz to 150kHz]

Emission level = Reading + (Ant factor + Cable system loss)

Margin = Limit – Emission level

[150kHz to 25GHz]

Emission level = Reading + (Ant factor + Cable system loss - Amp. Gain)

Margin = Limit – Emission level

Example:

Limit @ 4804.0MHz : 74.0dBuV/m (Peak Limit)

S.A Reading = 39.9dBuV Cable system loss = 8.3dB

Result = 39.9 + 8.3 = 48.2dBuV/m

Margin = 74.0 - 48.2 = 25.8dB

8.3 Limit

Frequency [MHz]	Field strength		Distance [m]
	[uV/m]	[dBuV/m]	
0.009-0.490	2400 / F [kHz]	20logE [uV/m]	300
0.490-1.705	24000 / F [kHz]	20logE [uV/m]	30
1.705-30	30	29.5	30
30-88	100	40.0	3
88-216	150	43.5	3
216-960	200	46.0	3
Above 960	500	54.0	3

Note:

1. The lower limit shall apply at the transition frequencies.
2. Emission level [dBuV/m] = 20log Emission [uV/m]
3. As shown in 15.35(b), for frequencies above 1000MHz, the field strength limits are based on average detector, however, the peak field strength of any emission shall not exceed the maximum permitted average limits, specified above by more than 20dB under any condition modulation.



Zacta

8.4 Test data

Date	: December 5, 2017	Test engineer	: <u>Tadahiro Seino</u>
Temperature	: 23.4 [°C]		
Humidity	: 25.6 [%]		
Test place	: 3m Semi-anechoic chamber		
Date	: December 15, 2017	Test engineer	: <u>Taiki Watanabe</u>
Temperature	: 21.2 [°C]		
Humidity	: 32.1 [%]		
Test place	: 3m Semi-anechoic chamber		
Date	: December 18~19, 2017	Test engineer	: <u>Taiki Watanabe</u>
Temperature	: 21.3 [°C]		
Humidity	: 25.2 [%]		
Test place	: 3m Semi-anechoic chamber		



Zacta

8.4.1 Transmission mode

Channel Low BELOW 1GHz

***** RADIATED EMISSION *****
[3m Semi-anechoic chamber]

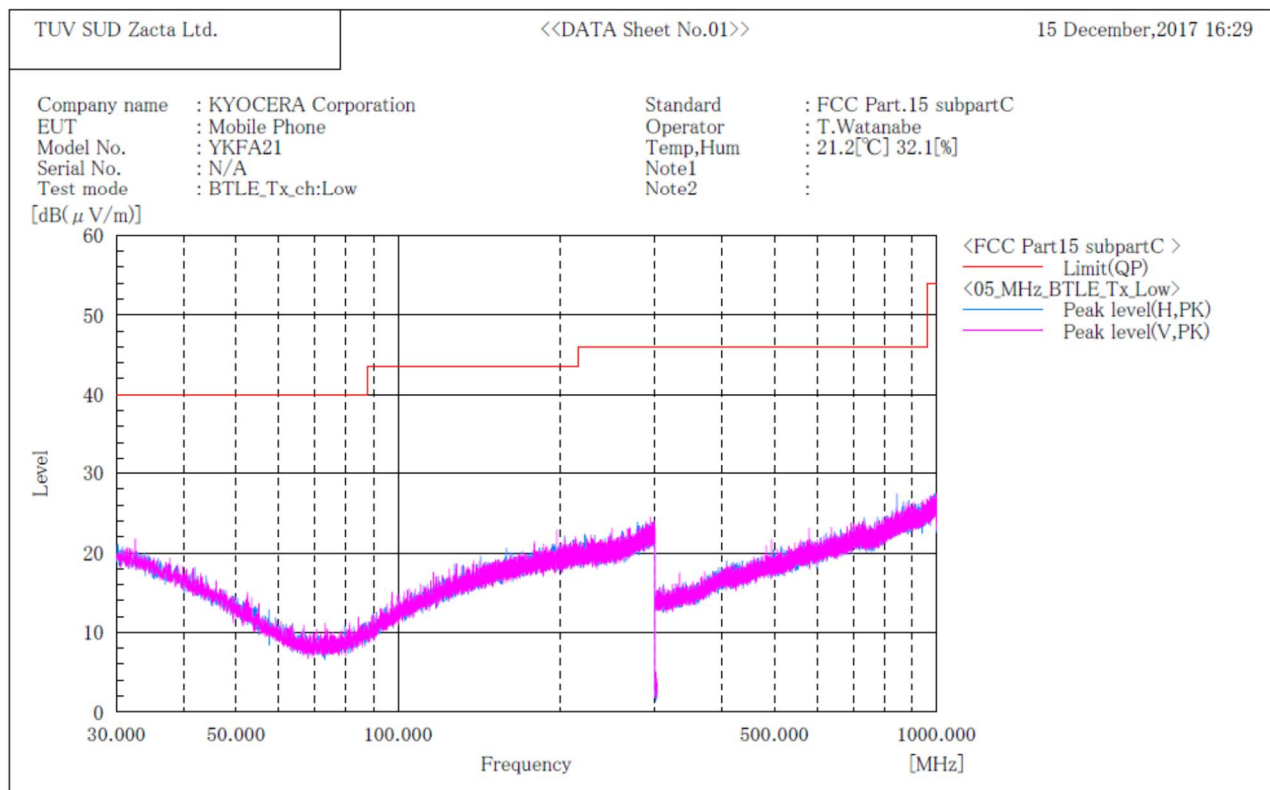

Final Result

No.	Frequency (P)	c.f	Height	Angle
	[MHz]	[dB(1/m)]	[cm]	[°]

Note:

1. Emission Level (Margin) = Limit - [Reading + Factor (Antenna + Cable – Amp)]
2. No emission were detected in frequency range 9kHz to 30MHz at the 3 meters distance.



Zacta

Channel Low ABOVE 1GHz

***** RADIATED EMISSION *****
[3m Semi-anechoic chamber]

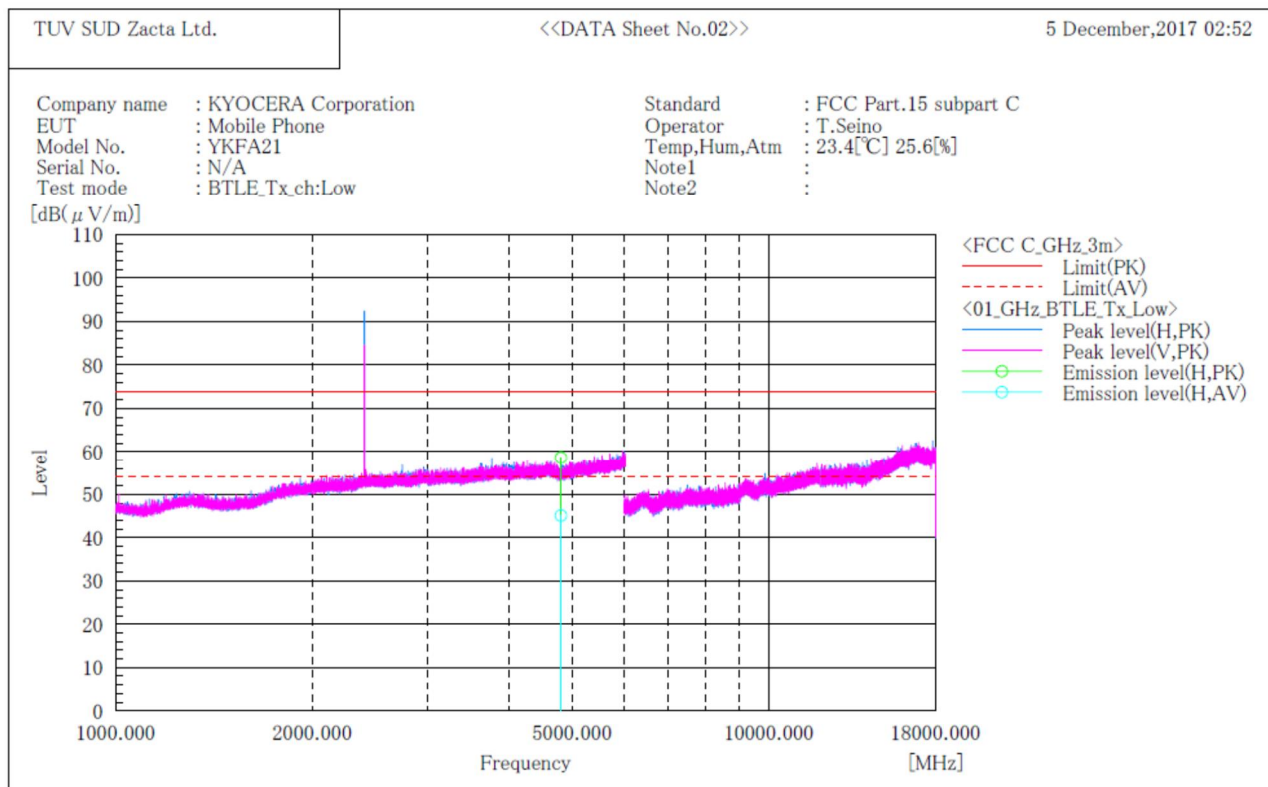

Final Result

No.	Frequency [MHz]	(P)	Reading PK [dB(μ V)]	Reading AV [dB(μ V)]	c.f [dB(1/m)]	Result PK [dB(μ V/m)]	Result AV [dB(μ V/m)]	Limit PK [dB(μ V/m)]	Limit AV [dB(μ V/m)]	Margin PK [dB]	Margin AV [dB]	Height [cm]	Angle [°]
1	4804.000	H	49.4	35.9	9.2	58.6	45.1	74.0	54.0	15.4	8.9	144.0	31.0

Note:

1. Emission Level (Margin) = Limit - [Reading + Factor (Antenna + Cable – Amp)]
2. No emission were detected in frequency range 18GHz to 25GHz at the 3 meters distance.



Zacta

**Channel Middle
BELOW 1GHz**

***** RADIATED EMISSION *****
[3m Semi-anechoic chamber]

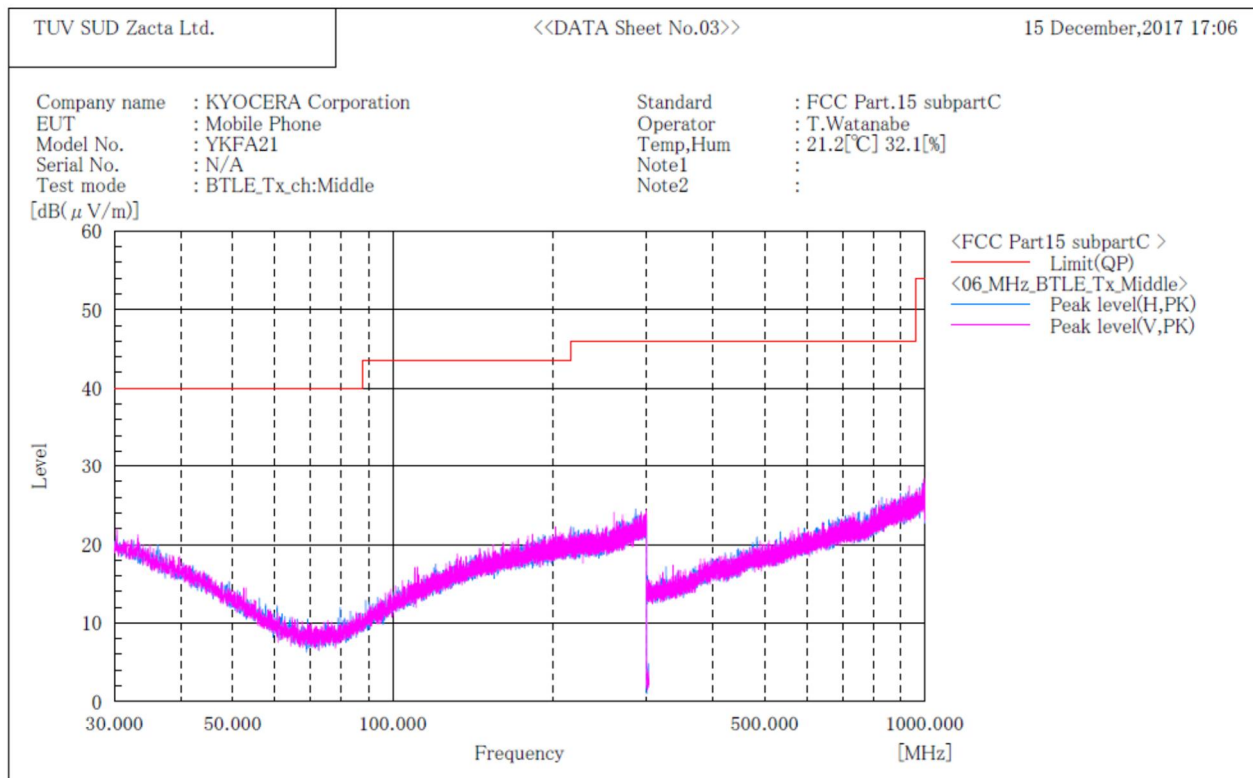

Final Result

No.	Frequency (P)	c. f	Height	Angle
	[MHz]	[dB(1/m)]	[cm]	[°]

Note:

1. Emission Level (Margin) = Limit - [Reading + Factor (Antenna + Cable – Amp)]
2. No emission were detected in frequency range 9kHz to 30MHz at the 3 meters distance.



Zacta

**Channel Middle
ABOVE 1GHz**

***** RADIATED EMISSION *****
[3m Semi-anechoic chamber]

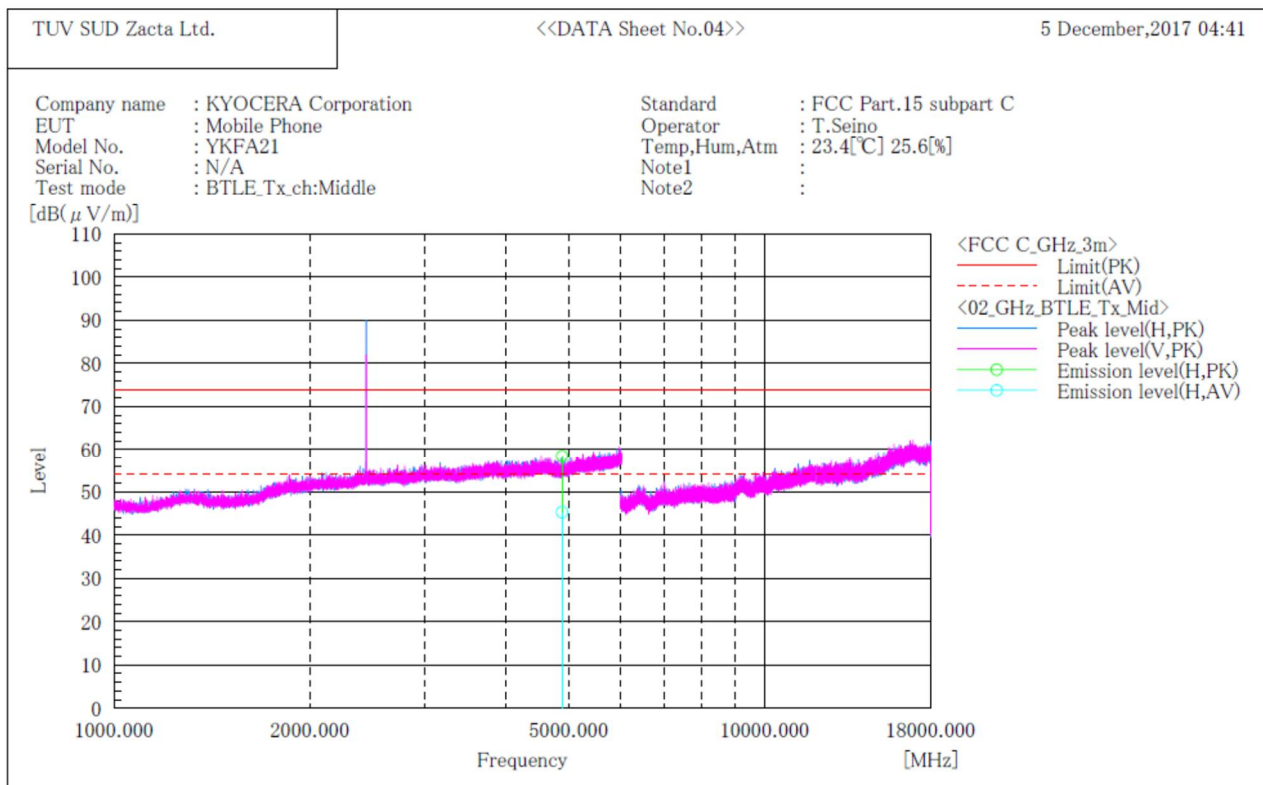

Final Result

No.	Frequency [MHz]	(P)	Reading PK [dB(μV)]	Reading AV [dB(μV)]	c. f [dB(1/m)]	Result PK [dB(μV/m)]	Result AV [dB(μV/m)]	Limit PK [dB(μV/m)]	Limit AV [dB(μV/m)]	Margin PK [dB]	Margin AV [dB]	Height [cm]	Angle [°]
1	4880.000	H	49.0	35.9	9.4	58.4	45.3	74.0	54.0	15.6	8.7	149.0	30.0

Note:

1. Emission Level (Margin) = Limit - [Reading + Factor (Antenna + Cable – Amp)]
2. No emission were detected in frequency range 18GHz to 25GHz at the 3 meters distance.



Zacta

**Channel High
BELOW 1GHz**

***** RADIATED EMISSION *****
[3m Semi-anechoic chamber]

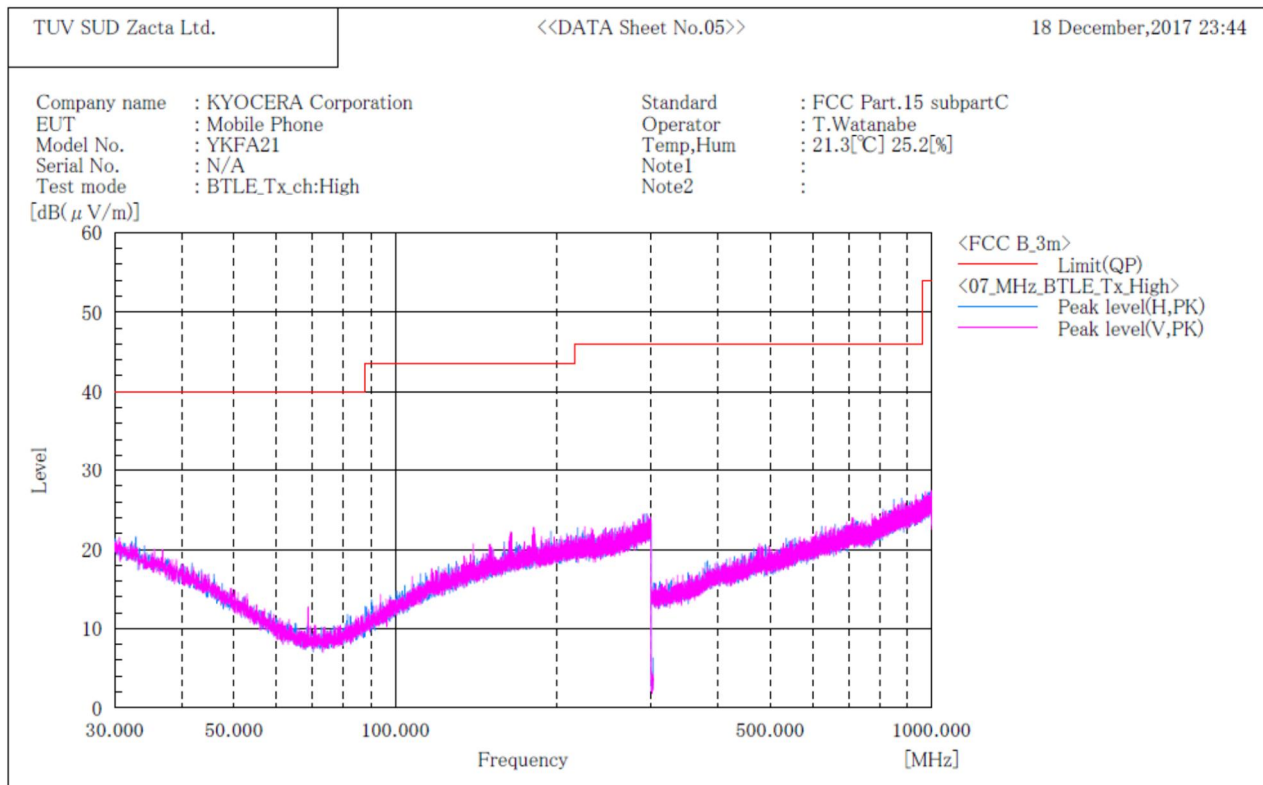

Final Result

No.	Frequency (P) [MHz]	c.f [dB(1/m)]	Height [cm]	Angle [°]
-----	------------------------	------------------	----------------	--------------

Note:

1. Emission Level (Margin) = Limit - [Reading + Factor (Antenna + Cable – Amp)]
2. No emission were detected in frequency range 9kHz to 30MHz at the 3 meters distance.



Zacta

**Channel High
ABOVE 1GHz**

***** RADIATED EMISSION *****
[3m Semi-anechoic chamber]

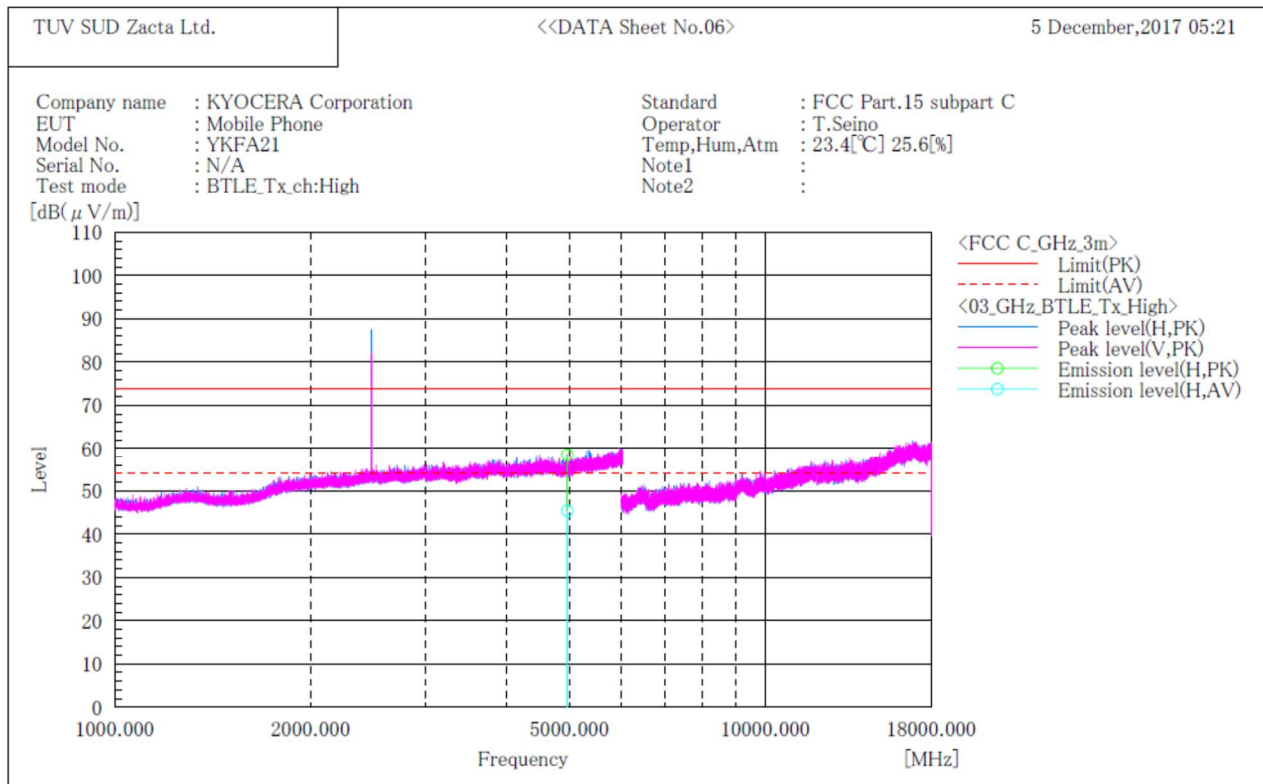

Final Result

No.	Frequency [MHz]	(P)	Reading PK [dB(μV)]	Reading AV [dB(μV)]	c.f [dB(1/m)]	Result PK [dB(μV/m)]	Result AV [dB(μV/m)]	Limit PK [dB(μV/m)]	Limit AV [dB(μV/m)]	Margin PK [dB]	Margin AV [dB]	Height [cm]	Angle [°]
1	4960.000	H	48.8	35.7	9.7	58.5	45.4	74.0	54.0	15.5	8.6	149.0	27.0

Note:

1. Emission Level (Margin) = Limit - [Reading + Factor (Antenna + Cable – Amp)]
2. No emission were detected in frequency range 18GHz to 25GHz at the 3 meters distance.



Zacta

8.4.2 Receive mode

Channel Low BELOW 1GHz

***** RADIATED EMISSION *****
[3m Semi-anechoic chamber]

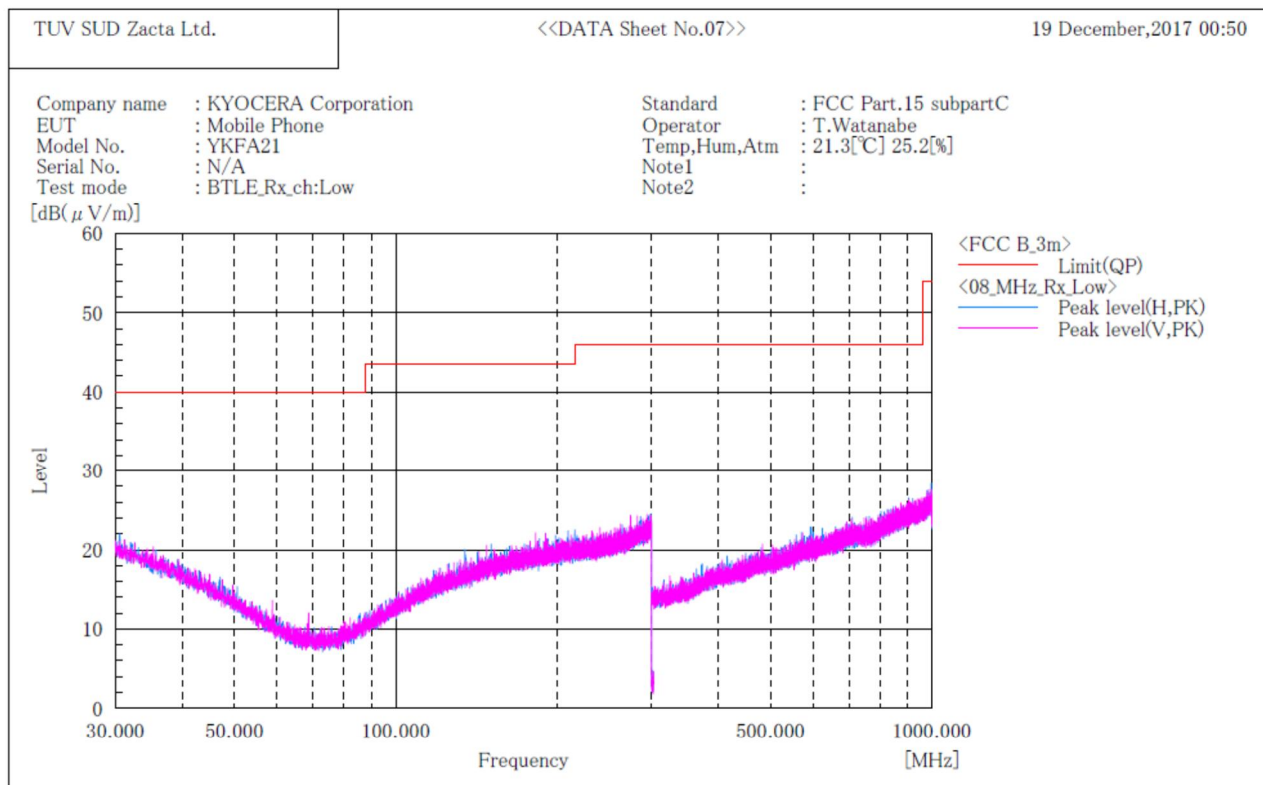

Final Result

No.	Frequency (P)	c. f	Height	Angle
	[MHz]	[dB(1/m)]	[cm]	[°]

Note:

1. Emission Level (Margin) = Limit - [Reading + Factor (Antenna + Cable – Amp)]
2. No emission were detected in frequency range 9kHz to 30MHz and 1GHz to 25GHz at the 3 meters distance.



Zacta

**Channel Middle
BELOW 1GHz**

***** RADIATED EMISSION *****
[3m Semi-anechoic chamber]

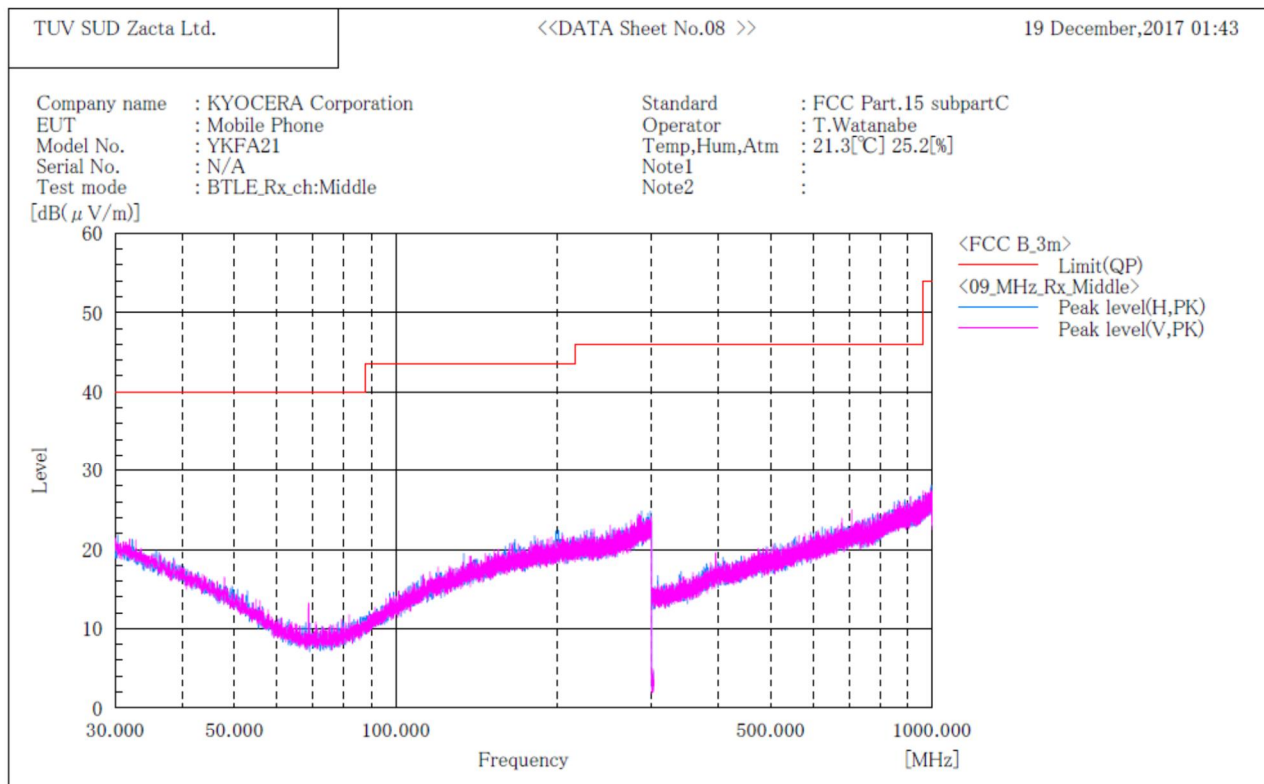

Final Result

No.	Frequency (P) [MHz]	c.f [dB(1/m)]	Height [cm]	Angle [°]

Note:

1. Emission Level (Margin) = Limit - [Reading + Factor (Antenna + Cable – Amp)]
2. No emission were detected in frequency range 9kHz to 30MHz and 1GHz to 25GHz at the 3 meters distance.



Zacta

**Channel High
BELOW 1GHz**

***** RADIATED EMISSION *****
[3m Semi-anechoic chamber]

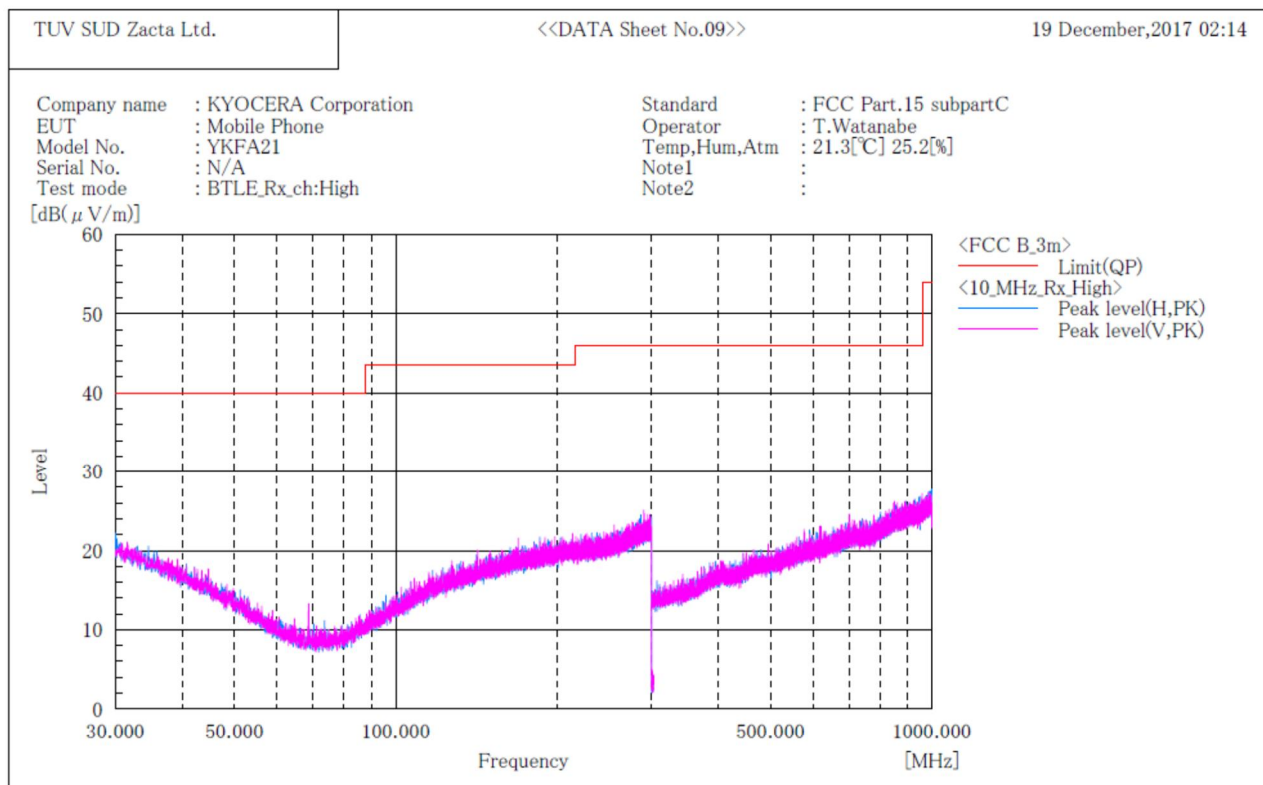

Final Result

No.	Frequency (P)	c. f	Height	Angle
	[MHz]	[dB(1/m)]	[cm]	[°]

Note:

1. Emission Level (Margin) = Limit - [Reading + Factor (Antenna + Cable – Amp)]
2. No emission were detected in frequency range 9kHz to 30MHz and 1GHz to 25GHz at the 3 meters distance.

9. Restricted Band of Operation

9.1 Measurement procedure

[FCC 15.247(d), 15.205, 15.209, KDB 558074 D01 v04, Section 12.0]

Test was applied by following conditions.

Test method	:	ANSI C63.10
Test place	:	3m Semi-anechoic chamber
EUT was placed on	:	Styrofoam table / (W)1.0m x (D)1.0m x (H)0.8m (below 1GHz) Styrofoam table / (W)0.6m x (D)0.6m x(H)1.5m (above 1GHz)
Antenna distance	:	3m
Spectrum analyzer setting	:	
- Peak	:	RBW=1MHz, VBW=3MHz, Span=Arbitrary setting, Sweep=auto
- Average	:	RBW=1MHz, VBW=3kHz, Span=Arbitrary setting, Sweep=auto Display mode=Linear

Average Measurement Setting [VBW]

Mode	Duty Cycle (%)	T _{on} (us)	T _{off} (us)	1/T _{on} (kHz)	Determined VBW Setting
Bluetooth 4.2 LE	62.56	391	234	2.558	3kHz

Although these tests were performed other than open area test site, adequate comparison measurements were confirmed against 30 m open are test site.

Therefore sufficient tests were made to demonstrate that the alternative site produces results that correlate with the ones of tests made in an open field based on KDB 937606.

Radiated emission measurements are performed at 3m distance with the broadband antenna (Double ridged guide antenna). The antenna is positioned both the horizontal and vertical planes of polarization and height is varied 1m to 4m and stopped at height producing the maximum emission.

The EUT is Placed on a turntable, which is 0.8m/1.5m above ground plane. The turntable shall be rotated for 360 degrees to determine the position of maximum emission level. The test results represent the worst case emission for each emission with manipulating the EUT, support equipment, interconnecting cables and varying the mode of operation. Sufficient time for the EUT, support equipment, and test equipment are allowed in order for them to warm up to their normal operating condition.

- Test configuration

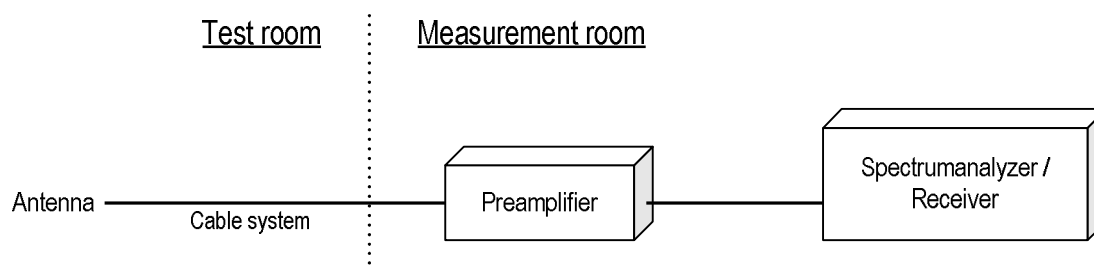

9.2 Limit

Emission at the boundary of the restricted band provided by 15.205 shall be lower than 15.209 limit.



Zacta

9.3 Measurement Result

Channel	Frequency [MHz]	Results Chart	Result
Low	2402	See the Trace Data	Pass
High	2480	See the Trace Data	Pass

9.4 Test data

Date : December 6, 2017
Temperature : 20.1 [°C]
Humidity : 31.8 [%]
Test place : 3m Semi-anechoic chamber

Test engineer :

Taiki Watanabe



Zacta

Channel Low Horizontal Peak

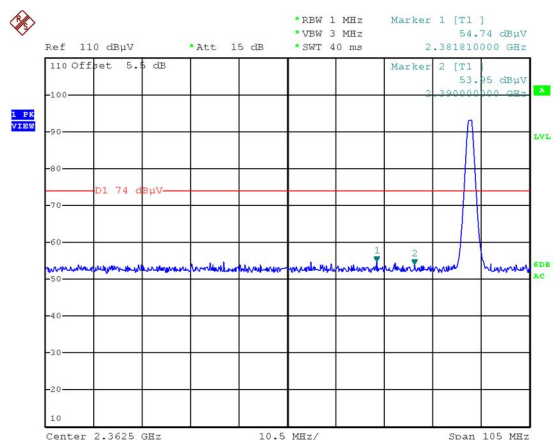

Date: 6.DEC.2017 12:14:15

Average

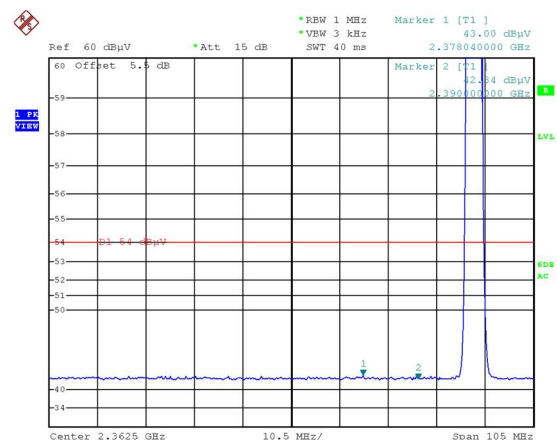

Date: 6.DEC.2017 12:15:17

Vertical Peak

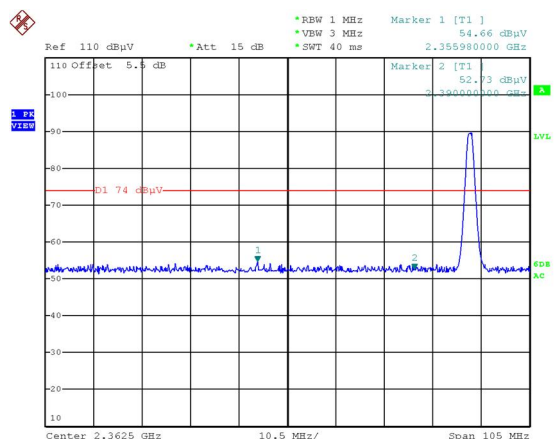

Date: 6.DEC.2017 12:23:22

Average

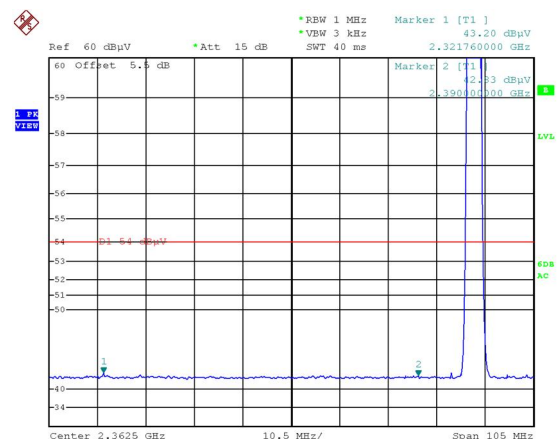

Date: 6.DEC.2017 12:24:28



Zacta

Channel High Horizontal Peak

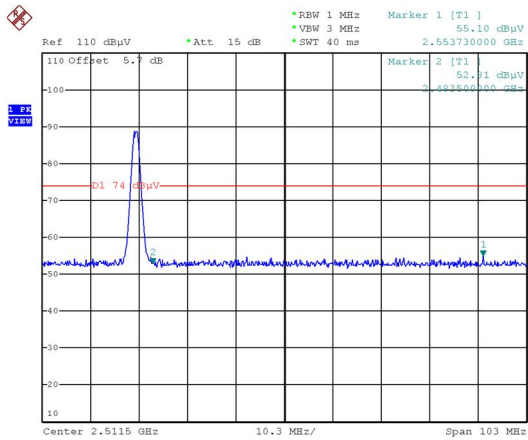

Date: 6.DEC.2017 12:34:29

Average

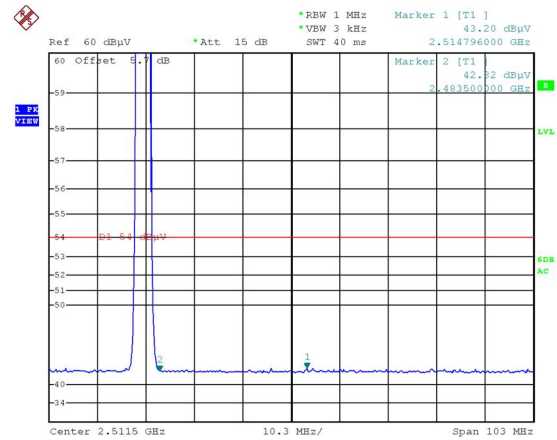

Date: 6.DEC.2017 12:35:58

Vertical Peak

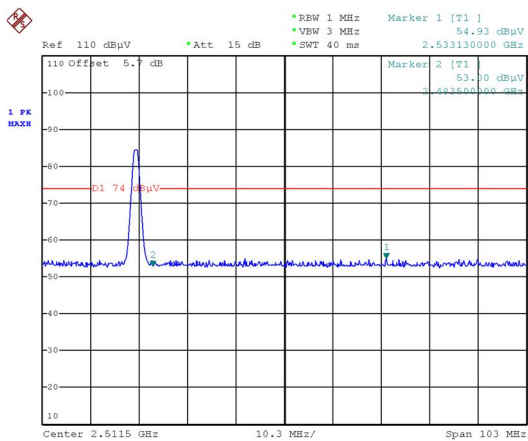

Date: 6.DEC.2017 12:39:24

Average

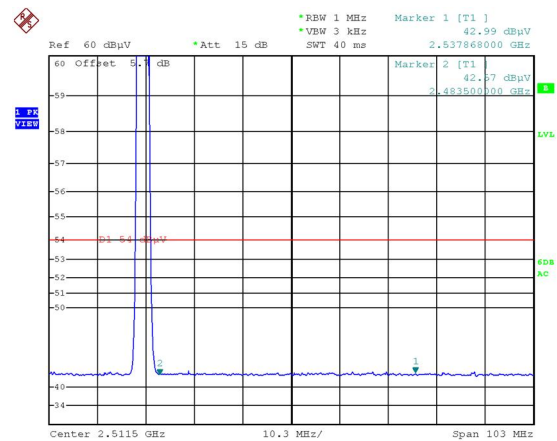

Date: 6.DEC.2017 12:40:17

10. Transmitter Power Spectral Density

10.1 Measurement procedure

[FCC 15.247(e), KDB558074 D01 v04, Section 10.2]

The peak power is measured with a spectrum analyzer connected to the antenna terminal, while EUT is operating in transmission mode at the appropriate center frequency.

The spectrum analyzer is set to;

- Span = 1.5 times the 6 dB bandwidth.
- RBW = 3kHz - 100kHz.
- VBW $\geq 3 \times$ RBW.
- Sweep time = auto-couple.
- Detector = peak.
- Trace mode = max hold.

- Test configuration

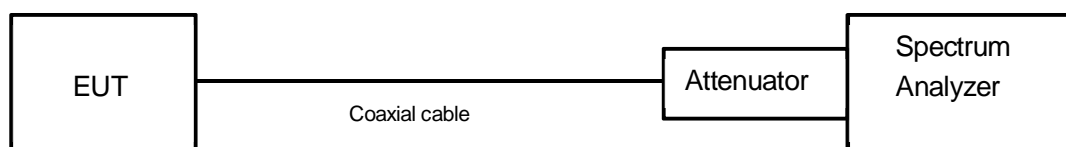

10.2 Limit

The peak power spectral density shall not be greater than 8dBm in any 3kHz band.

10.3 Measurement result

Date : November 27, 2017
 Temperature : 22.3 [°C]
 Humidity : 42.9 [%]
 Test place : Shielded room No.4

Test engineer : Chiaki Kanno

Channel	Center Frequency (MHz)	Reading (dBm)	Factor (dB)	Level (dBm)	Limit (dBm)	Margin (dBm)	Result
Low	2402	-25.42	10.52	-14.90	8.00	22.90	PASS
Middle	2440	-26.40	10.52	-15.88	8.00	23.88	PASS
High	2480	-26.42	10.52	-15.90	8.00	23.90	PASS

Calculation;

Transmitter Power Spectral Density Level (Margin) = Limit – (Reading + Factor)



Zacta

10.4 Trace data

Channel Low

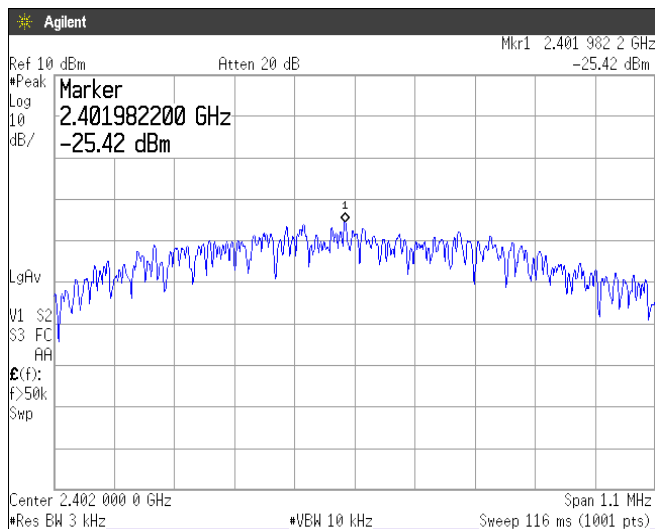

Channel Middle

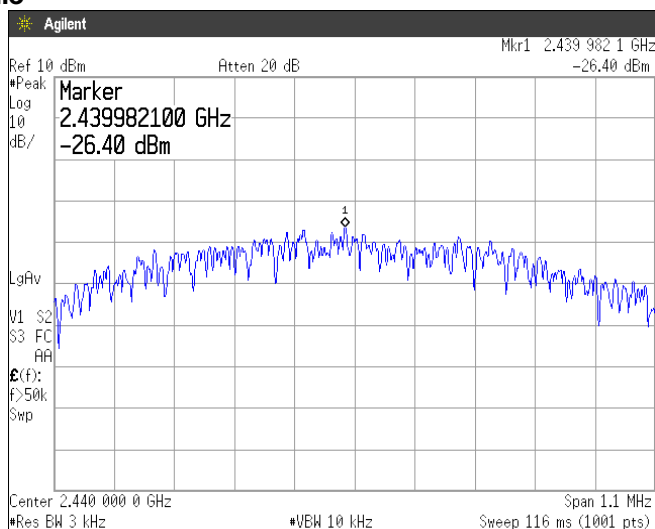

Channel High

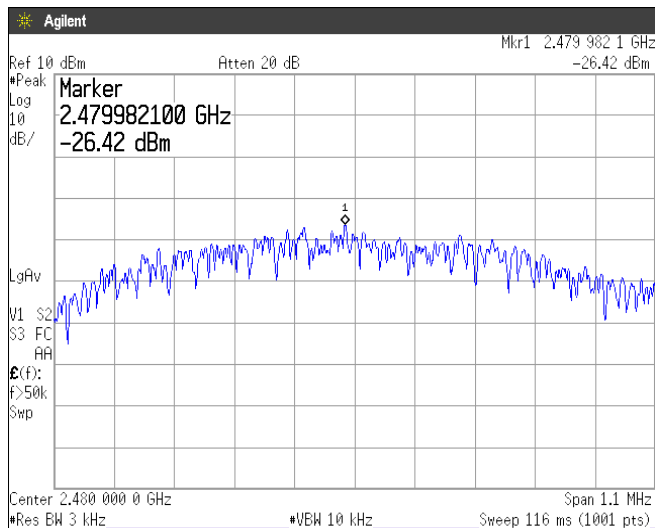

11. AC Power Line Conducted Emissions

11.1 Measurement procedure [FCC 15.207]

Test was applied by following conditions.

Test method	: ANSI C63.10
Frequency range	: 0.15MHz to 30MHz
Test place	: 3m Semi-anechoic chamber
EUT was placed on	: FRP table / (W)2.0m × (D)1.0m × (H)0.8m
Vertical Metal Reference Plane	: (W)2.0m × (H)2.0m 0.4m away from EUT
Test receiver setting	
- Detector	: Quasi-peak, Average
- Bandwidth	: 9kHz

EUT and peripherals are connected to 50Ω/50μH Line Impedance Stabilization Network (LISN) which are connected to reference ground plane, and are placed 80cm away from EUT. Excess of AC power cable is bundled in center.

LISN for peripheral is terminated in 50Ω.

EUT operating mode is selected to emit the maximum noise. Overall frequency range is investigated with spectrum analyzer using peak detector. Maximum emission configuration is determined by manipulating the EUT, peripherals, interconnecting cables. Then, emission measurements are performed with test receiver in above setting to each current-carrying conductor of the mains port. Sufficient time for EUT, peripherals and test equipment is provided in order for them to warm up to their normal operating condition. If the average limit is met when using a quasi-peak detector receiver, the EUT shall be deemed to meet both limits.

- Test configuration

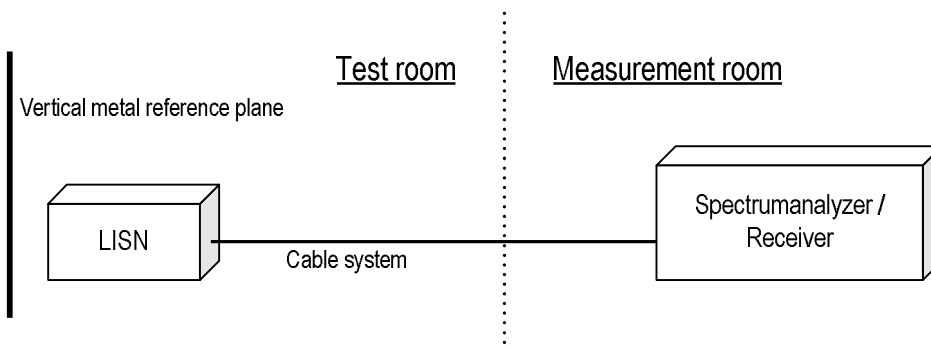

11.2 Calculation method

Emission level = Reading + (LISN. Factor + Cable system loss)

Margin = Limit – Emission level

Example:

Limit @ 6.770MHz : 60.0dBμV(Quasi-peak)
: 50.0dBμV(Average)

(Quasi peak) Reading = 41.2dBμV c.f = 10.3dB

Emission level = 41.2 + 10.3 = 51.5dBμV

Margin = 60.0 – 51.5 = 8.5dB

(Average) Reading = 35.0dBμV c.f = 10.3dB

Emission level = 35.0 + 10.3 = 45.3dBμV

Margin = 50.0 – 45.3 = 4.7dB



Zacta

11.3 Limit

Frequency [MHz]	Limit	
	QP [dBuV]	AV [dBuV]
0.15-0.5	66-56*	56-46*
0.5-5	56	46
5-30	60	50

*: The limit decreases linearly with the logarithm of the frequency in the range 0.15MHz to 0.5MHz.

11.4 Test data

***** CONDUCTED EMISSION at MAINS PORT *****
[3m Semi-anechoic chamber]

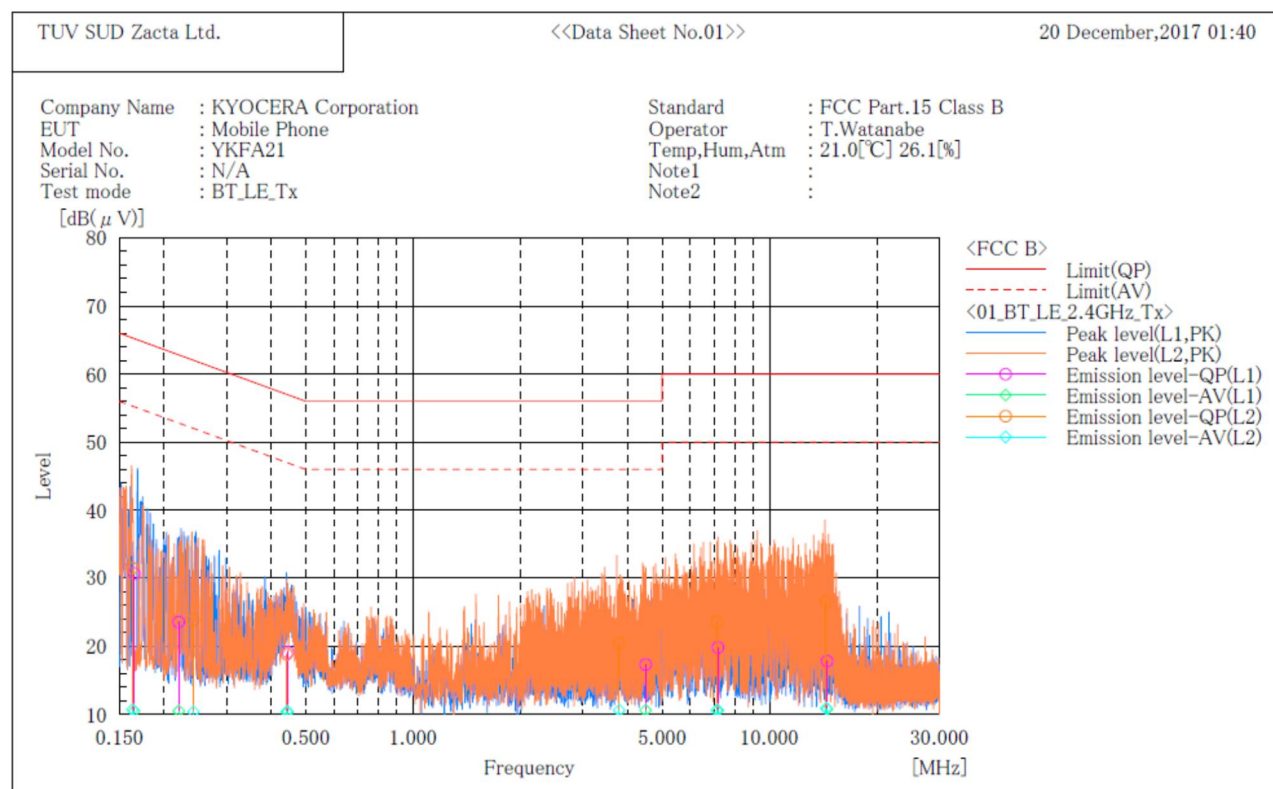

Final Result

--- L1 Phase ---

No.	Frequency [MHz]	Reading QP [dB(μV)]	Reading AV [dB(μV)]	c. f [dB]	Result QP [dB(μV)]	Result AV [dB(μV)]	Limit QP [dB(μV)]	Limit AV [dB(μV)]	Margin QP [dB]	Margin AV [dB]
1	0.165	20.2	0.1	10.4	30.6	10.5	65.2	55.2	34.6	44.7
2	0.220	13.2	0.2	10.3	23.5	10.5	62.8	52.8	39.3	42.3
3	0.445	8.8	0.1	10.3	19.1	10.4	57.0	47.0	37.9	36.6
4	4.494	6.9	0.2	10.4	17.3	10.6	56.0	46.0	38.7	35.4
5	7.168	9.3	0.1	10.5	19.8	10.6	60.0	50.0	40.2	39.4
6	14.521	7.1	0.1	10.7	17.8	10.8	60.0	50.0	42.2	39.2

--- L2 Phase ---

No.	Frequency [MHz]	Reading QP [dB(μV)]	Reading AV [dB(μV)]	c. f [dB]	Result QP [dB(μV)]	Result AV [dB(μV)]	Limit QP [dB(μV)]	Limit AV [dB(μV)]	Margin QP [dB]	Margin AV [dB]
1	0.163	21.0	0.3	10.4	31.4	10.7	65.3	55.3	33.9	44.6
2	0.242	13.5	0.1	10.3	23.8	10.4	62.0	52.0	38.2	41.6
3	0.442	8.5	0.1	10.3	18.8	10.4	57.0	47.0	38.2	36.6
4	3.789	10.0	0.2	10.4	20.4	10.6	56.0	46.0	35.6	35.4
5	7.111	13.0	0.1	10.5	23.5	10.6	60.0	50.0	36.5	39.4
6	14.415	15.8	0.2	10.7	26.5	10.9	60.0	50.0	33.5	39.1



Zacta

12. Antenna requirement

According to FCC section 15.203, an intentional radiator shall be designed to ensure that no antenna other than that furnished by the responsible party shall be used with the device.

The antenna is a special antenna mounted inside of the EUT. Therefore, the EUT complies with the antenna requirement of FCC section 15.203.

13. Uncertainty of measurement

Expanded uncertainties stated are calculated with a coverage Factor $k=2$.

Please note that these results are not taken into account when measurement uncertainty considerations contained in ETSI TR 100 028-0011 determining compliance or non-compliance with test result

Test item	Measurement uncertainty
Conducted emission, AMN (9kHz – 150kHz)	$\pm 3.8\text{dB}$
Conducted emission, AMN (150kHz – 30MHz)	$\pm 3.3\text{dB}$
Radiated emission (9kHz – 30MHz)	$\pm 3.0\text{dB}$
Radiated emission (30MHz – 1000MHz)	$\pm 4.7\text{dB}$
Radiated emission (1GHz – 6GHz)	$\pm 4.9\text{dB}$
Radiated emission (6GHz – 18GHz)	$\pm 5.2\text{dB}$
Radiated emission (18GHz – 40GHz)	$\pm 5.8\text{dB}$



Zacta

14. Laboratory Information

1. Location

Name: Yonezawa Testing Center
 Address: 5-4149-7, Hachimanpara, Yonezawa-shi, Yamagata, 992-1128 Japan
 Phone: +81-238-28-2881
 Fax: +81-238-28-2888

2. Accreditation and Registration

- 1) VLAC
Accreditation No.: VLAC-013
- 2) NVLAP
LAB CODE: 200306-0
- 3) BSMI
Laboratory Code: SL2-IN-E-6018, SL2-A1-E-6018

4) Industry Canada

Site number	Facility	Expiration date
4224A-4	3m Semi-anechoic chamber	2020-11-27
4224A-5	10m Semi-anechoic chamber No.1	2020-11-27
4224A-6	10m Semi-anechoic chamber No.2	2019-12-14

5) VCCI Council

Registration number	Expiration date
A-0166	2019-07-03

Appendix A. Test equipment

Antenna port conducted test

Equipment	Company	Model No.	Serial No.	Cal. Due	Cal. Date
Spectrum analyzer	Agilent Technologies	E4440A	US44302655	Jun. 30, 2018	Jun. 28, 2017
Attenuator	Weinschel	56-10	J4993	Nov. 30, 2017	Nov. 1, 2016
				Dec. 31, 2018	Dec. 4, 2017
Power meter	ROHDE&SCHWARZ	NRP2	103269	Jul. 31, 2018	Jul. 11, 2017
Power sensor	ROHDE&SCHWARZ	NRP-Z81	102459	Jul. 31, 2018	Jul. 11, 2017

Radiated emission

Equipment	Company	Model No.	Serial No.	Cal. Due	Cal. Date
EMI Receiver	ROHDE&SCHWARZ	ESCI	100765	Sep. 30, 2018	Sep. 13, 2017
Spectrum analyzer	Agilent Technologies	E4447A	MY46180188	Mar. 31, 2018	Mar. 15, 2017
Spectrum analyzer	Agilent Technologies	E4440A	US40420937	Oct. 31, 2018	Oct. 19, 2017
Preamplifier	ANRITSU	MH648A	M96057	Feb. 28, 2018	Feb. 1, 2017
Loop antenna	ROHDE&SCHWARZ	HFH2-Z2	100515	Feb. 28, 2018	Feb. 17, 2017
Attenuator	TDC	TAT-43B-06	N/A(S209)	May 31, 2018	May 23, 2017
Biconical antenna	Schwarzbeck	VHA9103/BBA9106	2155	Jul. 31, 2018	Jul. 18, 2017
Log periodic antenna	Schwarzbeck	UHALP9108A	0560	Jul. 31, 2018	Jul. 18, 2017
Attenuator	TME	CFA-01NPJ-6	N/A(S275)	Feb. 28, 2018	Feb. 3, 2017
Attenuator	TME	CFA-01NPJ-3	N/A(S272)	Feb. 28, 2018	Feb. 2, 2017
Preamplifier	TSJ	MLA-100M18-B02-40	1929118	Feb. 28, 2018	Feb. 3, 2017
Attenuator	AEROFLEX	26A-10	081217-08	May 31, 2018	May 24, 2017
Double ridged guide antenna	ETS LINDGREN	3117	00052315	Feb. 28, 2018	Feb. 23, 2017
Attenuator	Agilent Technologies	8491B	MY39268633	Feb. 28, 2018	Feb. 2, 2017
Broad-Band Horn Antenna	Schwarzbeck	BBHA9170	BBHA9170189	Jun. 30, 2018	Jun. 7, 2017
Double ridged guide antenna	A.H.Systems Inc.	SAS-574	469	Aug. 31, 2018	Aug. 8, 2017
Preamplifier	TSJ	MLA-1840-B03-35	1240332	Aug. 31, 2018	Aug. 8, 2017
Notch filter	Micro-Tronics	BRM50702	045	Apr. 30, 2018	Apr. 26, 2017
Microwave cable	HUBER+SUHNER	SUCOFLEX104/9m	MY30037/4	Feb. 28, 2018	Feb. 3, 2017
		SUCOFLEX104/1m	my24610/4	Feb. 28, 2018	Feb. 3, 2017
		SUCOFLEX104/8m	SN MY30031/4	Feb. 28, 2018	Feb. 2, 2017
		SUCOFLEX104/1.5m	MY32976/4	Dec. 31, 2017	Dec. 2, 2016
		SUCOFLEX104/1.5m	MY19309/4	Feb. 28, 2018	Feb. 3, 2017
		SUCOFLEX104/7m	41625/6	Feb. 28, 2018	Feb. 3, 2017
PC	DELL	DIMENSION E521	75465BX	N/A	N/A
Software	TOYO Corporation	EP5/RE-AJ	0611193/V5.6.0	N/A	N/A
Absorber	RIKEN	PFP30	N/A	N/A	N/A
3m Semi an-echoic Chamber	TOKIN	N/A	N/A(9002-NSA)	May 31, 2018	May 30, 2017
3m Semi an-echoic Chamber	TOKIN	N/A	N/A(9002-SVSWR)	May 31, 2018	May 31, 2017

Conducted emission at mains port

Equipment	Company	Model No.	Serial No.	Cal. Due	Cal. Date
EMI Receiver	ROHDE&SCHWARZ	ESCI	100765	Sep. 30, 2018	Sep. 13, 2017
Attenuator	HUBER+SUHNER	6810.01.A	N/A(S411)	Feb. 28, 2018	Feb. 2, 2017
Line impedance stabilization network for EUT	Kyoritsu Electrical Works, Ltd.	KNW-407F2	12-17-110-2	Apr. 30, 2018	Apr. 25, 2017
Coaxial cable	FUJIKURA	5D-2W/4m	N/A(S350)	Feb. 28, 2018	Feb. 2, 2017
Coaxial cable	FUJIKURA	5D-2W/1m	N/A(S193)	Feb. 28, 2018	Feb. 3, 2017
Coaxial cable	HUBER+SUHNER	RG214/U/10m	N/A(S194)	Feb. 28, 2018	Feb. 3, 2017
PC	DELL	DIMENSION	75465BX	N/A	N/A
Software	TOYO Corporation	EP5/CE-AJ	0611193/V5.4.11	N/A	N/A

*: The calibrations of the above equipment are traceable to NIST or equivalent standards of the reference organizations.

Appendix B. Duty Cycle

[Plot & Calculation]

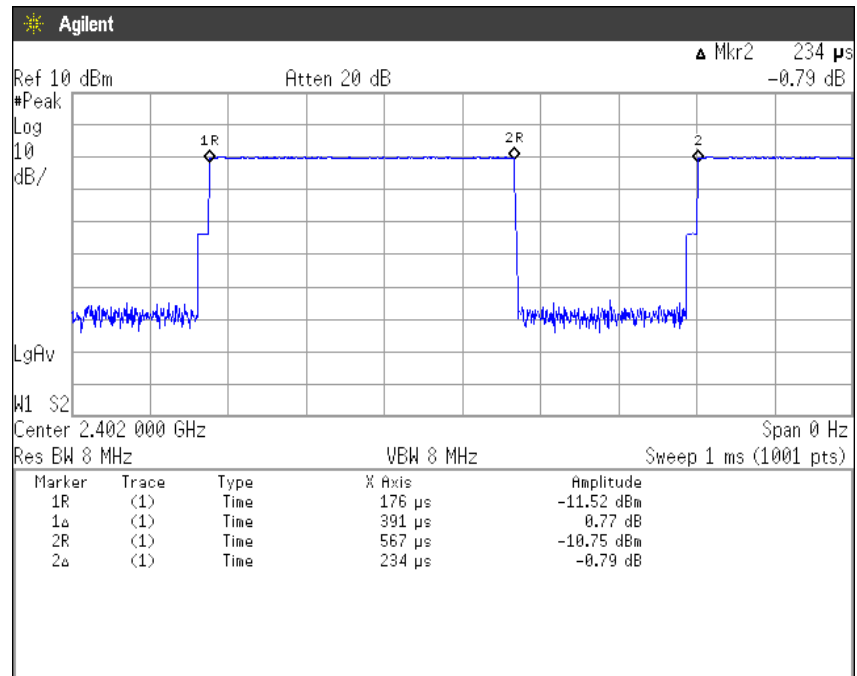

$$\text{Duty Cycle} = \text{Ton} / (\text{Ton} + \text{Toff}) = 391[\mu\text{s}] / (391[\mu\text{s}] + 234[\mu\text{s}]) = 62.56\%$$