



TEST REPORT



DT&C Co., Ltd.

42, Yurim-ro, 154Beon-gil, Cheoin-gu, Yongin-si, Gyeonggi-do, Korea, 17042
Tel : 031-321-2664, Fax : 031-321-1664

1. Report No : DRTFCC1612-0166
2. Customer
 - Name : Kyocera Corporation
 - Address : 2-1-1 Kagahara, Tsuzuki-ku Yokohama-shi, Kanagawa Japan 224-8502
3. Use of Report : FCC Original Grant
4. Product Name / Model Name : Mobile Phone / YKDA25
FCC ID : JOYYKDA25
5. Test Method Used : ANSI C63.10-2013
Test Specification : FCC Part 15 Subpart C.247
6. Date of Test : 2016-12-06 ~ 2016-12-22
7. Testing Environment : See appended Test Report.
8. Test Result : Refer to the attached Test Result.

Affirmation	Tested by	Technical Manager
	Name : Jaejin Lee  (Signature)	Name : Geunki Son  (Signature)

The test results presented in this test report are limited only to the sample supplied by applicant and the use of this test report is inhibited other than its purpose. This test report shall not be reproduced except in full, without the written approval of DT&C Co., Ltd.

2016 . 12 . 27 .

DT&C Co., Ltd.

If this report is required to confirmation of authenticity, please contact to report@dtnc.net

Test Report Version

Test Report No.	Date	Description
DRTFCC1612-0166	Dec. 27, 2016	Initial issue

Table of Contents

1. General Information	4
1.1 Testing Laboratory	4
1.2 Details of Applicant	4
1.3 Description of EUT	5
1.4 Auxiliary equipment for testing	5
1.5 Declaration by the applicant / manufacturer	5
1.6 Information about the FHSS characteristics	6
1.7 Test conditions	6
1.8 Measurement Uncertainty	6
1.9 Test Equipment List.....	7
1.10 Summary of Test Results	8
1.11 Conclusion of worst-case and operation mode	9
2. Maximum Peak Output Power Measurement	10
2.1 Test Setup	10
2.2 Limit.....	10
2.3 Test Procedure.....	10
2.4 Test Results	11
3. 20 dB BW	17
3.1 Test Setup	17
3.2 Limit.....	17
3.3 Test Procedure.....	17
3.4 Test Results	17
4. Carrier Frequency Separation	23
4.1 Test Setup	23
4.2 Limit.....	23
4.3 Procedure.....	23
4.4 Test Results	23
5. Number of Hopping Frequencies	28
5.1 Test Setup	28
5.2 Limit.....	28
5.3 Procedure.....	28
5.4 Test Results	28
6. Time of Occupancy (Dwell Time)	34
6.1 Test Setup	34
6.2 Limit.....	34
6.3 Test Procedure.....	34
6.4 Test Results	34
7. Transmitter Radiated Spurious Emissions and Conducted Spurious Emission	39
7.1 Test Setup	39
7.2 Limit.....	39
7.3. Test Procedures.....	40
7.3.1. Test Procedures for Radiated Spurious Emissions	40
7.3.2. Test Procedures for Conducted Spurious Emissions.....	41
7.4. Test Results	42
7.4.1. Radiated Emissions.....	42
7.4.2. Conducted Spurious Emissions	45
8. Transmitter AC Power Line Conducted Emission	69
8.1 Test Setup	69
8.2 Limit.....	69
8.3 Test Procedures.....	69
8.4. Test Results	70
9. Antenna Requirement	72
10. Occupied Bandwidth (99 %)	73
10.1 Test Setup	73
10.2 Limit.....	73
10.3 Test Procedure.....	73
10.4 Test Results	73
APPENDIX I	74
APPENDIX II	75

1. General Information

1.1 Testing Laboratory

DT&C Co., Ltd.		
Standard	Site number	Address
FCC	<input checked="" type="checkbox"/> 165783	42, Yurim-ro 154 beon-gil, Cheoin -gu, Yongin-si, Gyeonggi -do, South Korea 449-935
	<input type="checkbox"/> 804488	42, Yurim-ro 154 beon-gil, Cheoin -gu, Yongin-si, Gyeonggi -do, South Korea 449-935
	<input type="checkbox"/> 596748	42, Yurim-ro 154 beon-gil, Cheoin -gu, Yongin-si, Gyeonggi -do, South Korea 449-935
	<input type="checkbox"/> 678747	683-3, Yubang-dong, Cheoin-gu, Yongin-si, Gyeonggi-do, Korea, 449-080
IC	<input type="checkbox"/> 5740A-3	42, Yurim-ro 154 beon-gil, Cheoin -gu, Yongin-si, Gyeonggi -do, South Korea 449-935
	<input type="checkbox"/> 5740A-2	683-3, Yubang-dong, Cheoin-gu, Yongin-si, Gyeonggi-do, Korea, 449-080
www.dtnet.net		
Telephone	:	+ 82-31-321-2664
FAX	:	+ 82-31-321-1664

1.2 Details of Applicant

Applicant : Kyocera Corporation
 Address : 2-1-1 Kagahara, Tsuzuki-ku Yokohama-shi, Kanagawa Japan 224-8502
 Contact person : Yoshikazu Yamamoto

1.3 Description of EUT

EUT	Mobile Phone
Model Name	YKDA25
Add Model Name	NA
Serial Number	Identical prototype
Hardware version	WS2
Software version	006.0.1000
Power Supply	DC 3.8 V
Frequency Range	2402 MHz ~ 2480 MHz
Modulation Technique	GFSK, $\pi/4$ DQPSK, 8DPSK
Number of Channels	79
Antenna Type	Internal Antenna
Antenna Gain	PK : -2.1 dBi

1.4 Auxiliary equipment for testing

Equipment	Model Name	Serial No.	Manufacturer	Note
Laptop	PSCFJK-003004	YD068849Q	TOSHIBA	FCC DOC
-	-	-	-	-

1.5 Declaration by the applicant / manufacturer

- NA

1.6 Information about the FHSS characteristics

- This Bluetooth module has been tested by a Bluetooth Qualification Lab, and we confirm the following :
 - A) The hopping sequence is pseudorandom
 - B) All channels are used equally on average
 - C) The receiver input bandwidth equals the transmit bandwidth
 - D) The receiver hops in sequence with the transmit signal
- 15.247(g) : In accordance with the Bluetooth Industry Standard, the system is designed to comply with all of the regulations in Section 15.247 when the transmitter is presented with a continuous data (or information) system.
- 15.247(h) : In accordance with the Bluetooth Industry Standard, the system does not coordinate its channels selection / hopping sequence with other frequency hopping systems for the express purpose of avoiding the simultaneous occupancy of individual hopping frequencies by multiple transmitters.
- 15.247(h) : The EUT employs Adaptive Frequency Hopping (AFH) which identifies sources of interference namely devices operating in 802.11 WLAN and excludes them from the list of available channels. The process of re-mapping reduces the number of test channels from 79 channels to a minimum number of 20 channels.

1.7 Test conditions

Ambient Condition	
▪ Temperature	+22 °C ~ +24 °C
▪ Relative Humidity	40 % ~ 44 %

1.8 Measurement Uncertainty

Test items	Measurement uncertainty
Transmitter Output Power	0.94 dB (The confidence level is about 95 %, k = 2)
Conducted spurious emission	0.99 dB (The confidence level is about 95 %, k = 2)
AC conducted emission	2.4 dB (The confidence level is about 95 %, k = 2)
Radiated spurious emission (1 GHz Below)	5.1 dB (The confidence level is about 95 %, k = 2)
Radiated spurious emission (1 GHz ~ 18 GHz)	5.4 dB (The confidence level is about 95 %, k = 2)
Radiated spurious emission (18 GHz Above)	5.3 dB (The confidence level is about 95 %, k = 2)

1.9 Test Equipment List

Type	Manufacturer	Model	Cal.Date (yy/mm/dd)	Next.Cal.Date (yy/mm/dd)	S/N
MXA Signal Analyzer	Agilent Technologies	N9020A	16/08/18	17/08/18	MY46471172
MXA Signal Analyzer	Agilent Technologies	N9020A	16/10/11	17/10/11	MY46471251
BlueTooth Tester	TESCOM	TC-3000B	16/01/06	17/01/06	3000B770243
Power Splitter	Anritsu	K241B	16/10/18	17/10/18	1701061
DC Power Supply	Agilent Technologies	66332A	16/01/27	17/01/27	US37473831
Multimeter	FLUKE	17B	16/04/21	17/04/21	26030065WS
Vector Signal Generator	R&S	SMBV100A	16/01/05	17/01/05	255571
Signal Generator	R&S	SMF100A	16/06/23	17/06/23	102341
Power Meter & Wide Bandwidth Sensor	Anritsu	ML2496A/ MA2411B	16/06/23	17/06/23	1338004/ 1306053
Thermohyrometer	BODYCOM	BJ5478	16/02/25	17/02/25	1209
Loop Antenna	Schwarzbeck	FMZB1513	16/04/22	18/04/22	1513-128
Biglog Antenna	SCHAFFNER	VULB9160	16/08/05	18/08/05	3362
Horn Antenna	ETS	3117	16/05/03	18/05/03	140394
Horn Antenna	A.H.Systems.	SAS-574	15/04/30	17/04/30	154
Low Noise Pre Amplifier	tsj	MLA-010K01-B01-27	16/03/10	17/03/10	1844539
Amplifier	Agilent	8449B	16/02/24	17/02/24	3008A00370
High-pass filter	Wainwright	WHKX12-2580-3000-18000-80SS	16/09/09	17/09/09	3
High-pass filter	Wainwright	WHNX6-6320-8000-26500-40CC	16/09/13	17/09/13	1
EMI TEST RECEIVER	R&S	ESR7	16/02/25	17/02/25	101061
EMI TEST RECEIVER	R&S	ESCI	16/02/25	17/02/25	100364
SINGLE-PHASE MASTER	NF	4420	16/09/08	17/09/08	3049354420023
PULSE LIMITER	Rohde Schwarz	ESH3-Z2	16/01/05	17/01/05	101334
Artificial Mains Network	Narda S.T.S. / PMM	PMM L2-16B	16/06/22	17/06/22	000WX20305

1.10 Summary of Test Results

FCC Part RSS Std.	Parameter	Limit (Using in 2400~ 2483.5 MHz)	Test Condition	Status Note 1
15.247(a) RSS-247(5.1)	Carrier Frequency Separation	>= 25 kHz or >= Two thirds of the 20 dB BW, whichever is greater.	Conducted	C
	Number of Hopping Frequencies	>= 15 hops		C
	20 dB Bandwidth	N/A		C
	Dwell Time	=< 0.4 seconds		C
15.247(b) RSS-247(5.4)	Transmitter Output Power	For FCC =< 1 Watt , if CHs >= 75 Others =< 0.125 W For IC if CHs >= 75 =< 1 Watt For Conducted Power =< 4 Watt For e.i.r.p, Others =< 0.125 W For Conducted Power. =< 0.5 Watt For e.i.r.p		C
15.247(d) RSS-247(5.5)	Conducted Spurious Emissions	The radiated emission to any 100 kHz of out-band shall be at least 20 dB below the highest in-band spectral density.		C
RSS Gen(6.6)	Occupied Bandwidth (99 %)	N/A		N/A
15.247(d) 15.205 & 209 RSS-247(5.5) RSS-Gen (8.9 & 8.10)	Radiated Spurious Emissions	FCC 15.209 Limits RSS-Gen 8.9	Radiated	C ^{Note2}
15.207 RSS-Gen(8.8)	AC Conducted Emissions	FCC 15.207 Limits	AC Line Conducted	C
15.203 RSS-Gen(8.3)	Antenna Requirements	FCC 15.203	-	C
Note 1 : C = Comply NC = Not Comply NT = Not Tested NA = Not Applicable Note 2: This test item was performed in each axis and the worst case data was reported. Note 3 : The sample was tested according to the following specifications : - ANSI C63.10-2013				

1.11 Conclusion of worst-case and operation mode

The EUT has three type of modulation (GFSK, $\pi/4$ DQPSK and 8DPSK).

Therefore all applicable requirements were tested with all the modulations.

And packet type was tested at the worst case(DH5).

The field strength of spurious emission was measured in three orthogonal EUT positions (X-axis, Y-axis and Z-axis).

Tested frequency information,

- Hopping Function : Enable

	TX Frequency (MHz)	RX Frequency (MHz)
Hopping Band	2402 ~ 2480	2402 ~ 2480

- Hopping Function : Disable

	TX Frequency (MHz)	RX Frequency (MHz)
Lowest Channel	2402	2402
Middle Channel	2441	2441
Highest Channel	2480	2480

2. Maximum Peak Output Power Measurement

2.1 Test Setup

Refer to the APPENDIX I.

2.2 Limit

■ FCC Requirements

The maximum peak output power of the intentional radiator shall not exceed the following :

1. §15.247(a)(1), Frequency hopping systems shall have hopping channel carrier frequencies separated by a minimum of 25 kHz or the 20 dB bandwidth of the hopping channel, whichever is greater. Alternatively, frequency hopping systems operating in the 2400-2483.5 MHz band may have hopping channel carrier frequencies that are separated by 25 kHz or two-thirds of the 20 dB bandwidth of the hopping channel, whichever is greater, provided the systems operate with an output power no greater than 125 mW.
2. §15.247(b)(1), For frequency hopping systems operating in the 2400 – 2483.5 MHz employing at least 75 non-overlapping hopping channels, and all frequency hopping systems in the 5725 – 5805 MHz band : 1 Watt.

■ IC Requirements

1. RSS-247(5.4), For FHSs operating in the band 2400 - 2483.5 MHz, the maximum peak conducted output power shall not exceed 1.0 W and the e.i.r.p. shall not exceed 4 W if the hopset uses 75 or more hopping channels the maximum peak conducted output power shall not exceed 0.125 W and the e.i.r.p. shall not exceed 0.5 W if the hopset uses less than 75 hopping channels.

2.3 Test Procedure

1. The RF output power was measured with a spectrum analyzer connected to the RF Antenna connector (conducted measurement) while EUT was operating in transmit mode at the appropriate center frequency, A spectrum analyzer was used to record the shape of the transmit signal.
2. The bandwidth of the fundamental frequency was measured with the spectrum analyzer using ;
Span = approximately 5 times of the 20 dB bandwidth, centered on a hopping channel
RBW \geq 20 dB BW
VBW \geq RBW
Sweep = auto
Detector function = peak
Trace = max hold

2.4 Test Results

Modulation	Tested Channel	Frame Average Output Power		Peak Output Power	
		dBm	mW	dBm	mW
<u>GFSK</u>	Lowest	8.35	6.839	9.71	9.354
	Middle	7.86	6.109	9.22	8.356
	Highest	7.62	5.781	8.96	7.870
<u>$\pi/4$DQPSK</u>	Lowest	7.07	5.093	10.49	11.194
	Middle	6.49	4.457	10.09	10.209
	Highest	6.30	4.266	9.76	9.462
<u>8DPSK</u>	Lowest	7.18	5.224	10.70	11.749
	Middle	6.60	4.571	10.24	10.568
	Highest	6.38	4.345	9.96	9.908

Note 1 : The frame average output power was tested using an average power meter for reference only.

Note 2 : See next pages for actual measured spectrum plots.

Peak Output Power

Lowest Channel & Modulation : GFSK

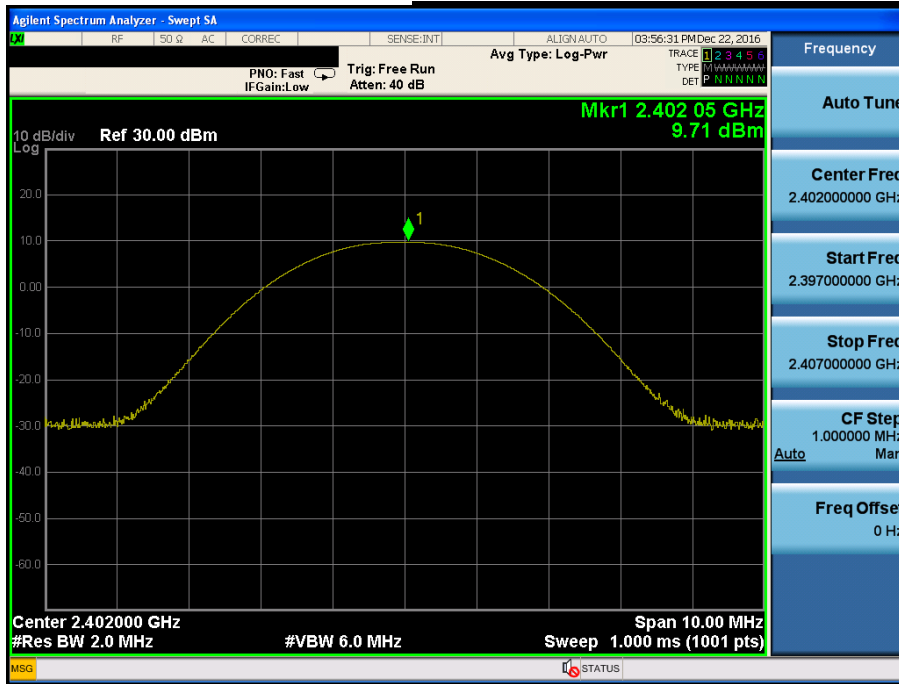

Peak Output Power

Middle Channel & Modulation : GFSK

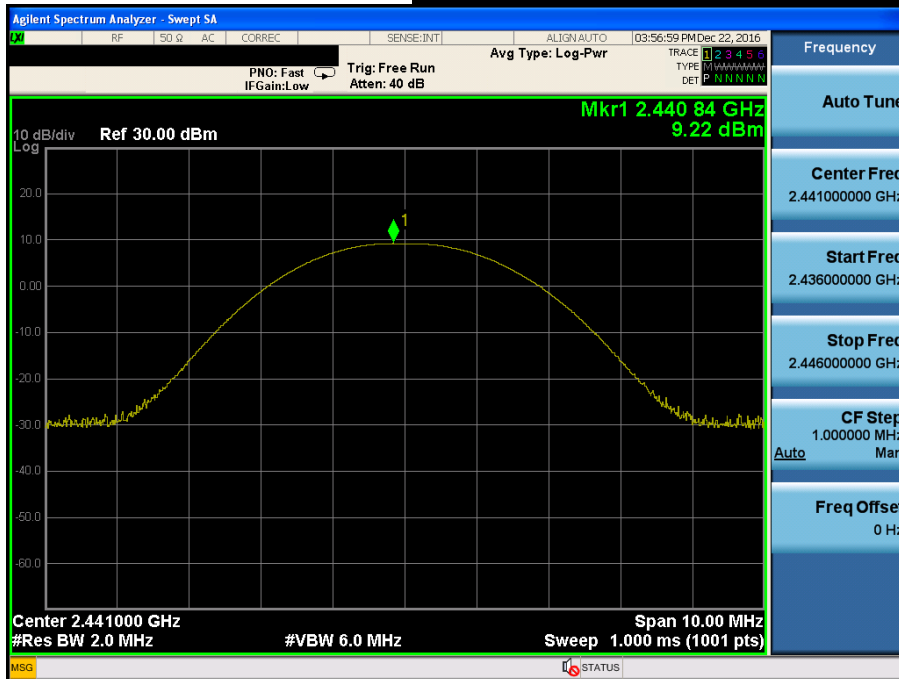

Peak Output Power

Highest Channel & Modulation : GFSK

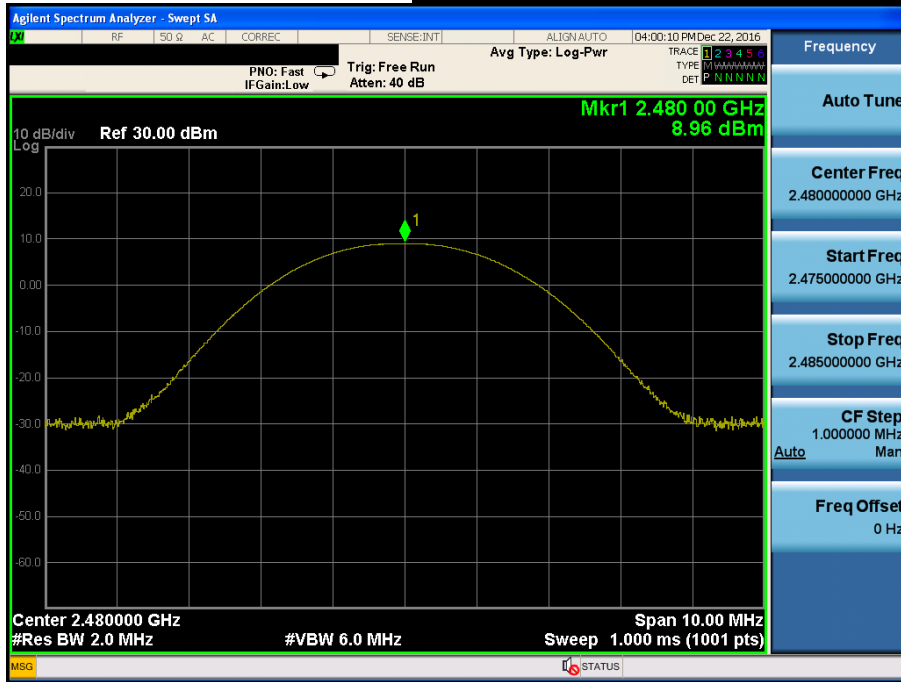

Peak Output Power

Lowest Channel & Modulation : $\pi/4$ DQPSK

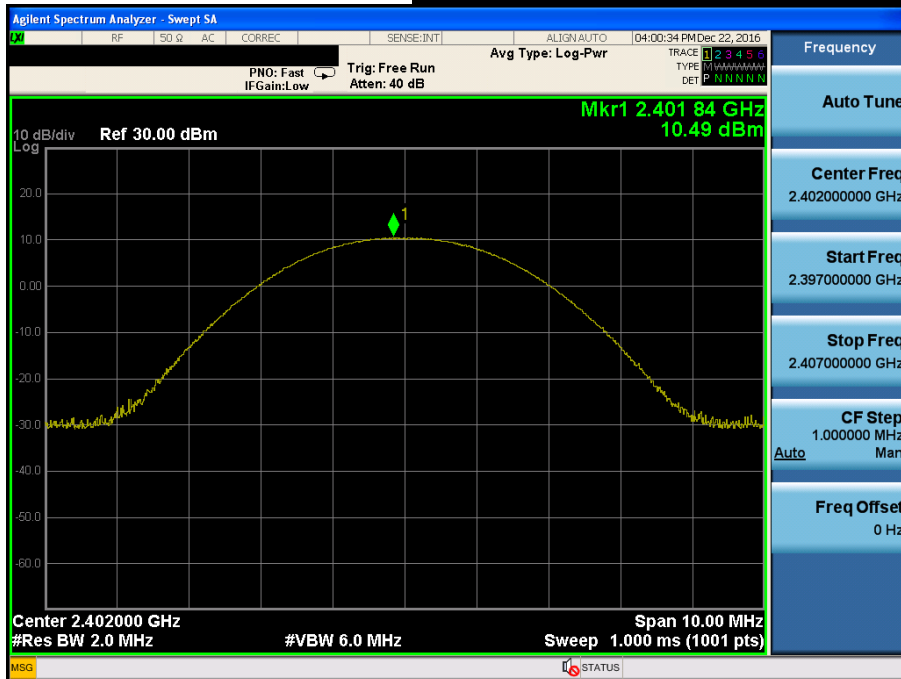

Peak Output Power

Middle Channel & Modulation : $\pi/4$ DQPSK

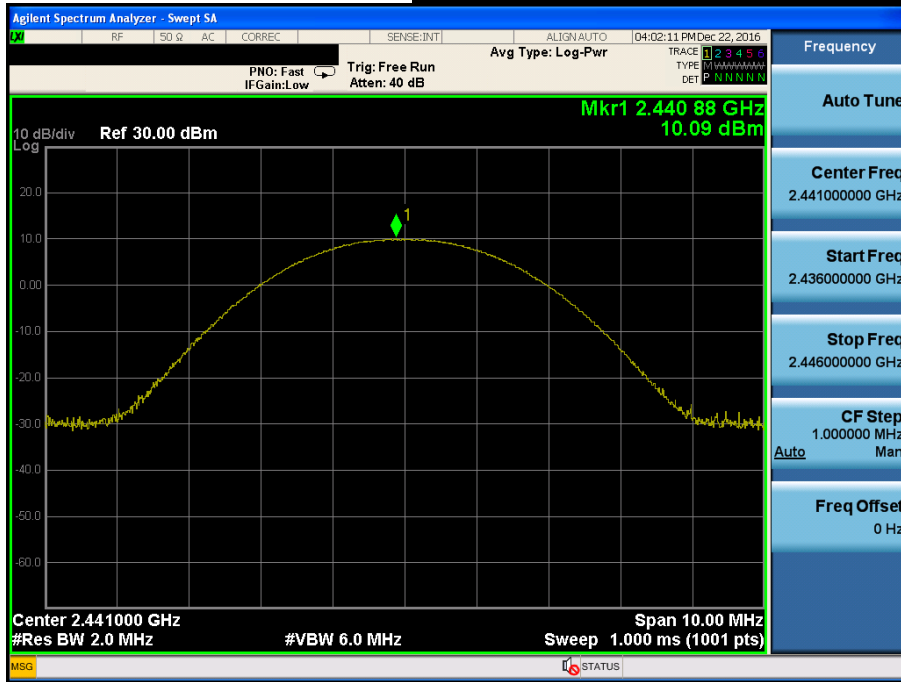

Peak Output Power

Highest Channel & Modulation : $\pi/4$ DQPSK

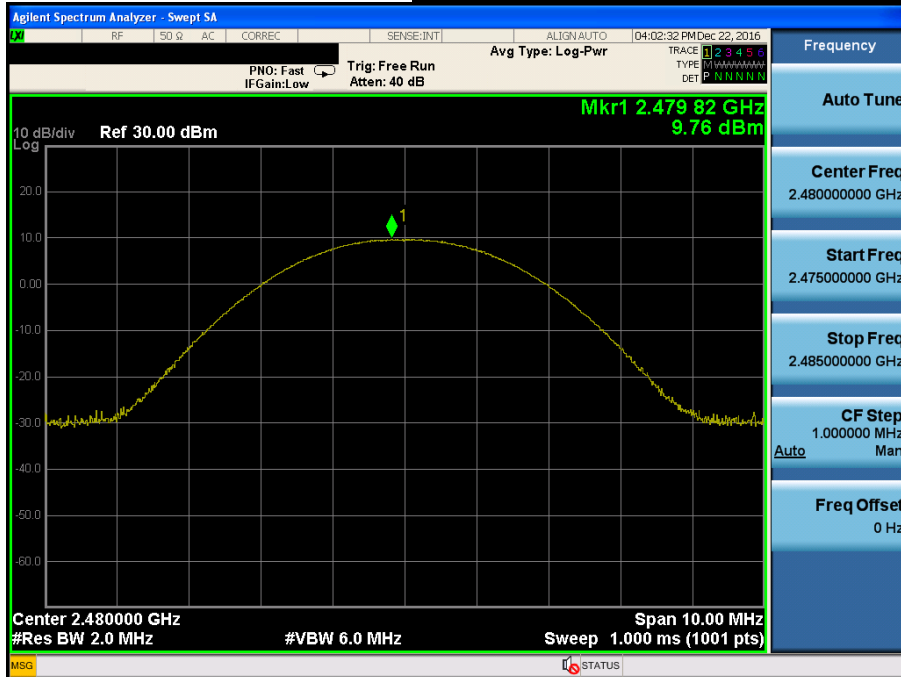

Peak Output Power

Lowest Channel & Modulation : 8DPSK

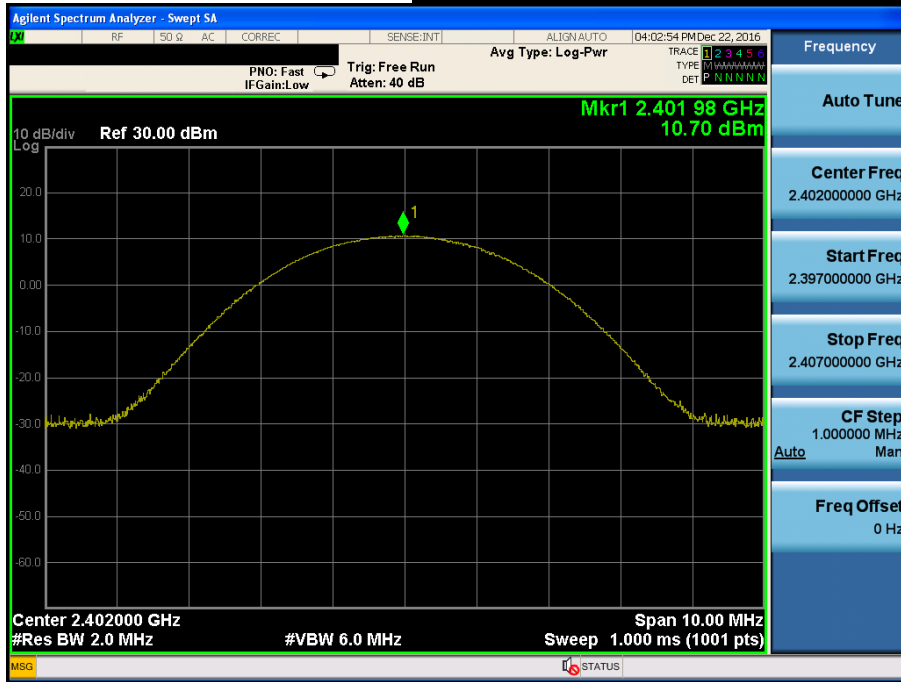

Peak Output Power

Middle Channel & Modulation : 8DPSK

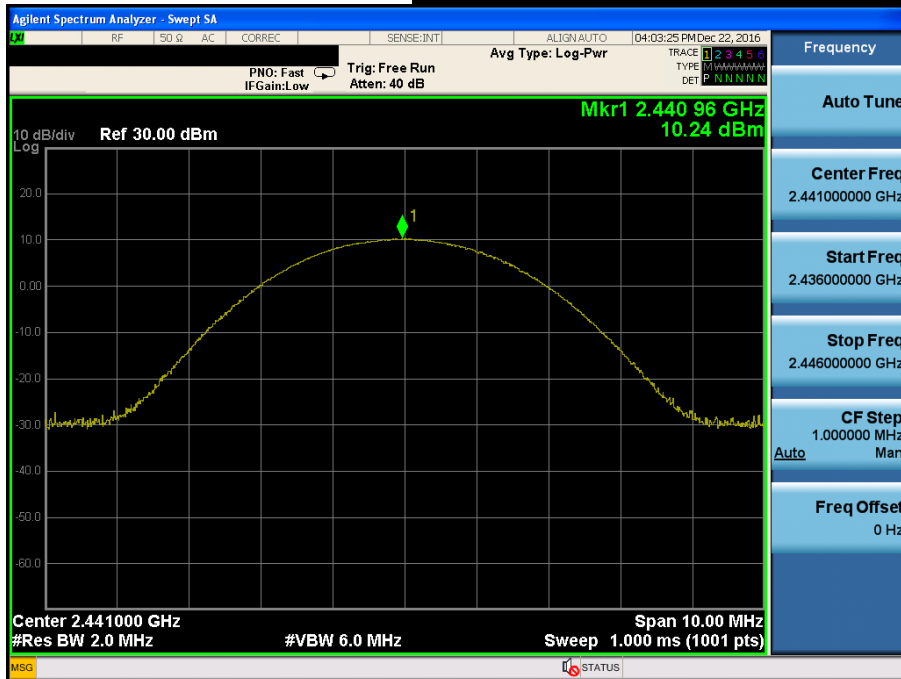

Peak Output Power

Highest Channel & Modulation : 8DPSK

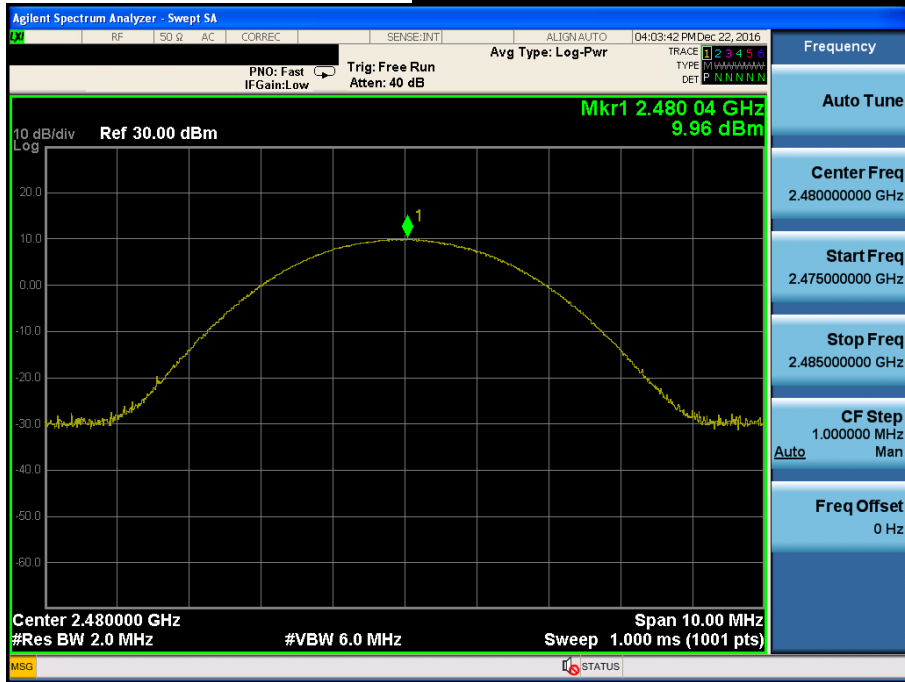

3. 20 dB BW

3.1 Test Setup

Refer to the APPENDIX I.

3.2 Limit

Limit : Not Applicable

3.3 Test Procedure

1. The 20 dB bandwidth were measured with a spectrum analyzer connected to RF antenna Connector (conducted measurement) while EUT was operating in transmit mode. The analyzer center frequency was set to the EUT carrier frequency, using the analyzer.
2. The bandwidth of the fundamental frequency was measured with the spectrum analyzer using below setting: RBW shall be in the range of 1% to 5% of the 20 dB bandwidth and VBW $\geq 3 \times$ RBW, Span = between two times and five times the 20 dB bandwidth.

3.4 Test Results

Modulation	Tested Channel	20 dB BW (MHz)
<u>GFSK</u>	Lowest	0.933
	Middle	0.942
	Highest	0.933
<u>$\pi/4$DQPSK</u>	Lowest	1.326
	Middle	1.320
	Highest	1.320
<u>8DPSK</u>	Lowest	1.323
	Middle	1.341
	Highest	1.335

Note 1 : See next pages for actual measured spectrum plots.

20 dB Bandwidth

Lowest Channel & Modulation : GFSK



20 dB Bandwidth

Middle Channel & Modulation : GFSK



20 dB Bandwidth

Highest Channel & Modulation : GFSK



20 dB Bandwidth

Lowest Channel & Modulation : $\pi/4$ DQPSK



20 dB Bandwidth

Middle Channel & Modulation : $\pi/4$ DQPSK



20 dB Bandwidth

Highest Channel & Modulation : $\pi/4$ DQPSK



20 dB Bandwidth

Lowest Channel & Modulation : 8DPSK



20 dB Bandwidth

Middle Channel & Modulation : 8DPSK



20 dB Bandwidth

Highest Channel & Modulation : 8DPSK



4. Carrier Frequency Separation

4.1 Test Setup

Refer to the APPENDIX I.

4.2 Limit

Limit : ≥ 25 kHz or \geq Two-Thirds of the 20 dB BW whichever is greater.

4.3 Procedure

The carrier frequency separation was measured with a spectrum analyzer connected to the antenna terminal, while EUT had its hopping function enabled.

After the trace being stable, the reading value between the peaks of the adjacent channels using the marker-delta function was recorded as the measurement results.

The spectrum analyzer is set to :

Span = wide enough to capture the peaks of two adjacent channels

RBW = Start with the RBW set to approximately 30% of the channel spacing; adjust as necessary to best identify the center of each individual channel.

VBW \geq RBW

Sweep = auto

Detector function = peak

Trace = max hold

4.4 Test Results

FH mode

Hopping Mode	Modulation	Peak of center channel (MHz)	Peak of adjacent Channel (MHz)	Test Result (MHz)
Enable	GFSK	2441.014	2442.014	1.000
	$\pi/4$ DQPSK	2440.846	2441.846	1.000
	8DPSK	2441.162	2442.162	1.000

AFH mode

Hopping Mode	Modulation	Peak of center channel (MHz)	Peak of adjacent Channel (MHz)	Test Result (MHz)
Enable	GFSK	2411.058	2412.058	1.000
	$\pi/4$ DQPSK	2411.055	2412.055	1.000
	8DPSK	2411.160	2412.160	1.000

Note 1 : See next pages for actual measured spectrum plots.

- Minimum Standard :

Frequency hopping systems shall have hopping channel carrier frequencies separated by a minimum of 25 kHz or the 20 dB bandwidth of the hopping channel, whichever is greater. Alternatively, frequency hopping systems operating in the 2400 - 2483.5 MHz band may have hopping channel carrier frequencies that are separated by 25 kHz or two-thirds of the 20 dB bandwidth of the hopping channel, whichever is greater, provided the systems operate with an output power no greater than 125 mW

Carrier Frequency Separation (FH) *Hopping mode : Enable & GFSK*



Carrier Frequency Separation (FH) *Hopping mode : Enable & π/4DQPSK*

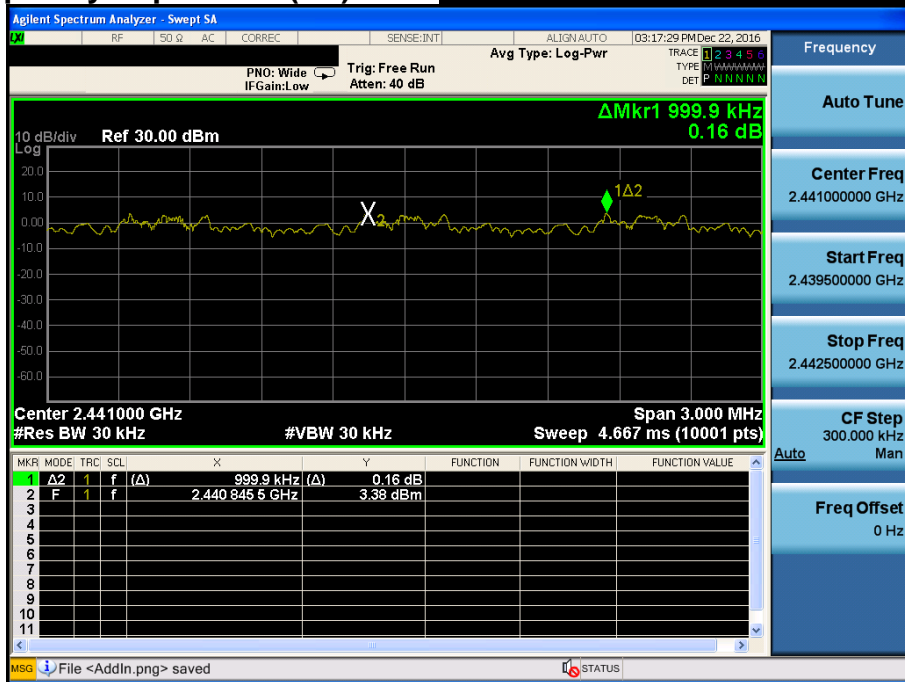

Carrier Frequency Separation (FH) *Hopping mode : Enable & 8DPSK*

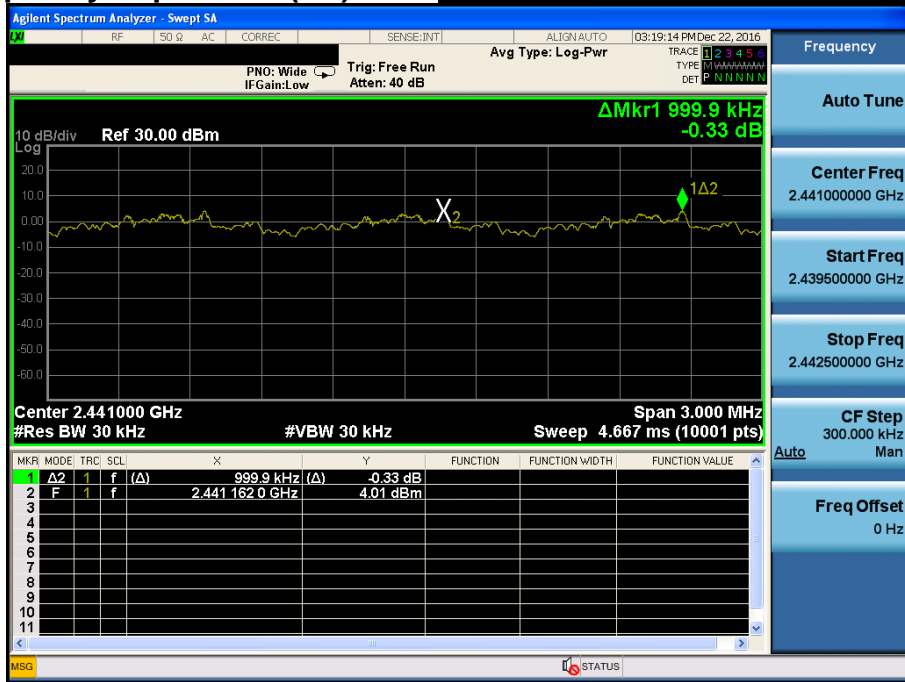

Carrier Frequency Separation (AFH) *Hopping mode : Enable & GFSK*



Carrier Frequency Separation (AFH) *Hopping mode : Enable & π/4DQPSK*

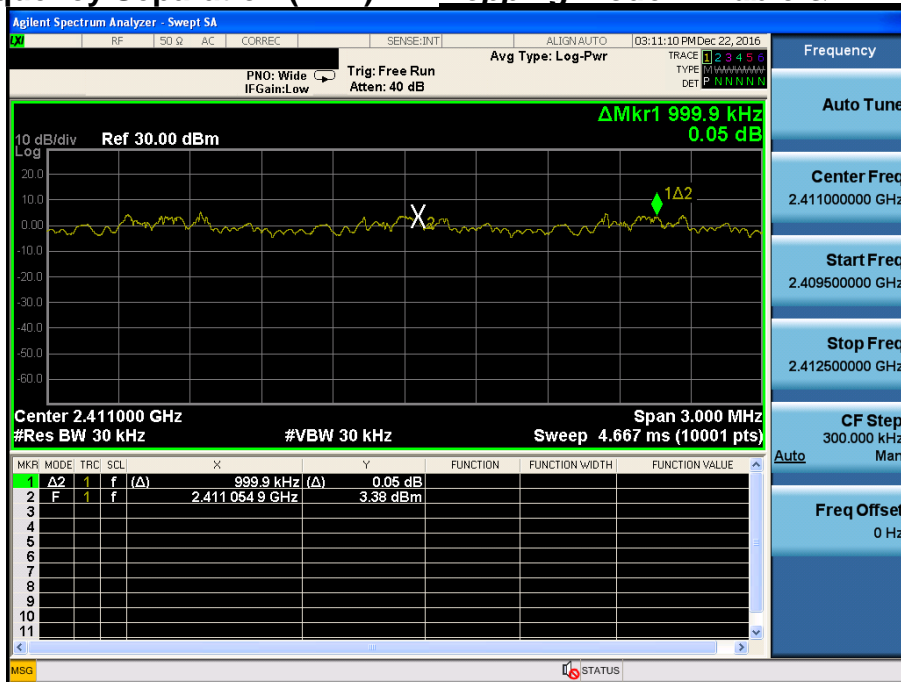

Carrier Frequency Separation (AFH) *Hopping mode : Enable & 8DPSK*

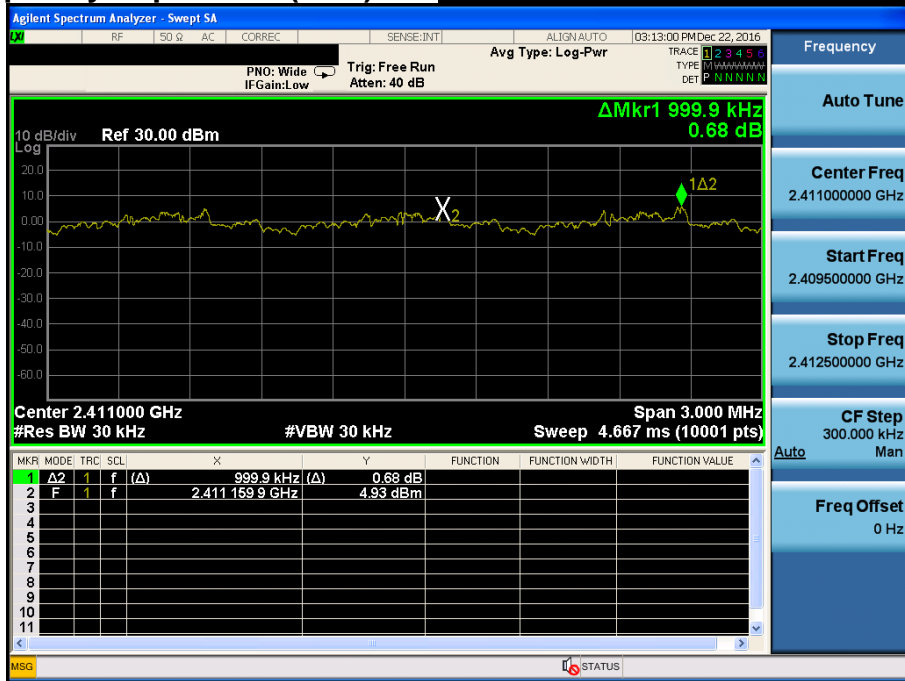

5. Number of Hopping Frequencies

5.1 Test Setup

Refer to the APPENDIX I.

5.2 Limit

Limit : ≥ 15 hops

5.3 Procedure

The number of hopping frequencies was measured with a spectrum analyzer connected to the antenna terminal, while EUT had its hopping function enabled.

To get higher resolution, two frequency ranges for FH mode within the 2400 ~ 2483.5 MHz were examined.

The spectrum analyzer is set to :

Span for FH mode = 50 MHz Start Frequency = 2391.5 MHz, Stop Frequency = 2441.5 MHz

Start Frequency = 2441.5 MHz, Stop Frequency = 2491.5 MHz

Span for AFH mode = 30 MHz Start Frequency = 2396.0 MHz, Stop Frequency = 2426.0 MHz

RBW = To identify clearly the individual channels, set the RBW to less than 30% of the channel spacing or the 20 dB bandwidth, whichever is smaller.

VBW \geq RBW Sweep = auto

Detector function = peak Trace = max hold

5.4 Test Results

FH mode

Hopping mode	Modulation	Test Result (Total Hops)
Enable	GFSK	79
	$\pi/4$ DQPSK	79
	8DPSK	79

AFH mode

Hopping mode	Modulation	Test Result (Total Hops)
Enable	GFSK	20
	$\pi/4$ DQPSK	20
	8DPSK	20

Note 1 : See next pages for actual measured spectrum plots.

- Minimum Standard :

At least 15 hops

Number of Hopping Frequencies 1(FH) *Hopping mode : Enable & GFSK*

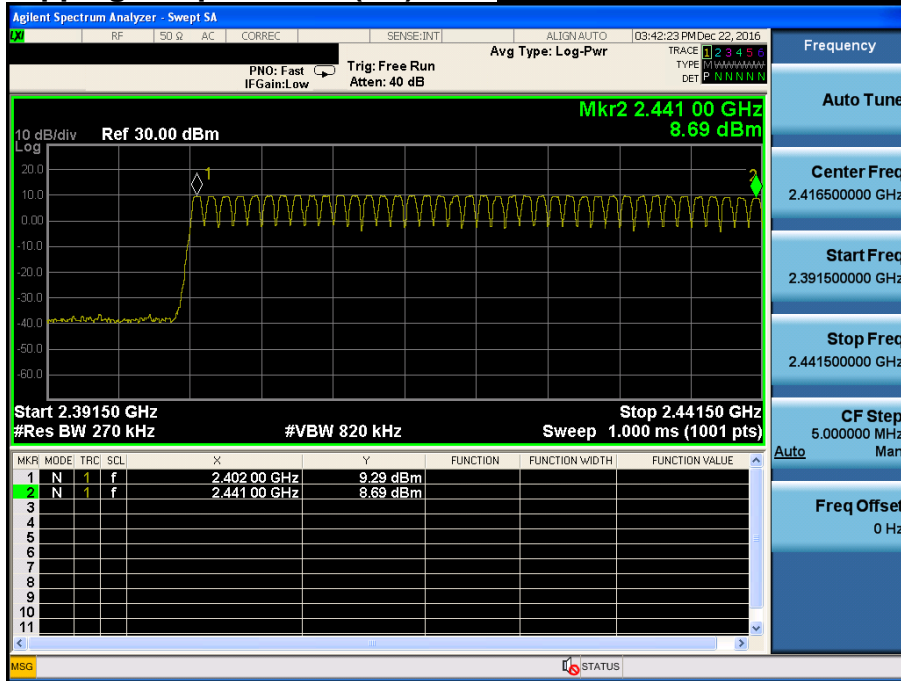

Number of Hopping Frequencies 2(FH) *Hopping mode : Enable & GFSK*

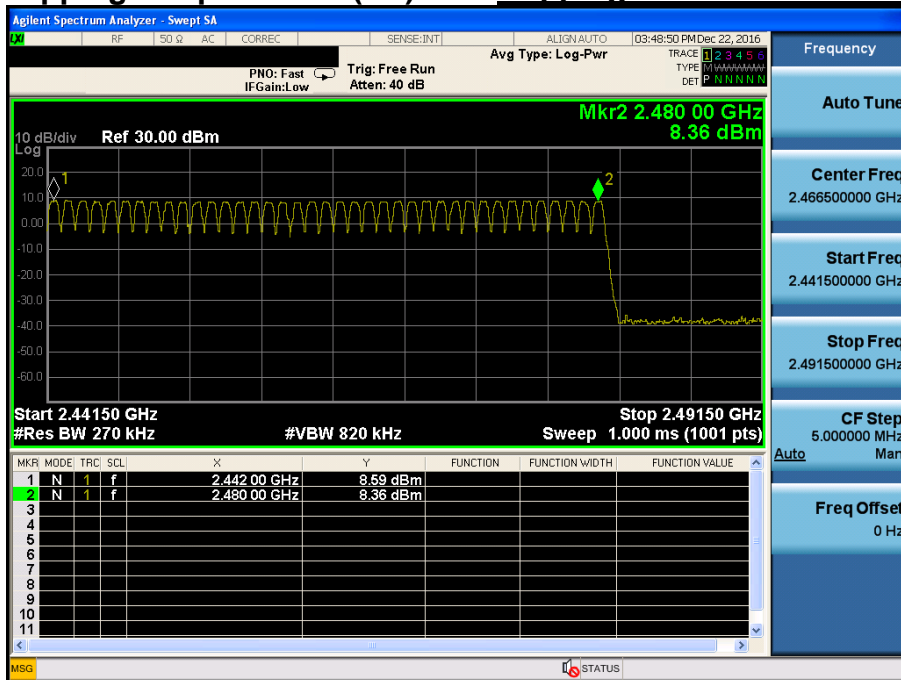

Number of Hopping Frequencies 1(FH)

Hopping mode : Enable & $\pi/4$ DQPSK

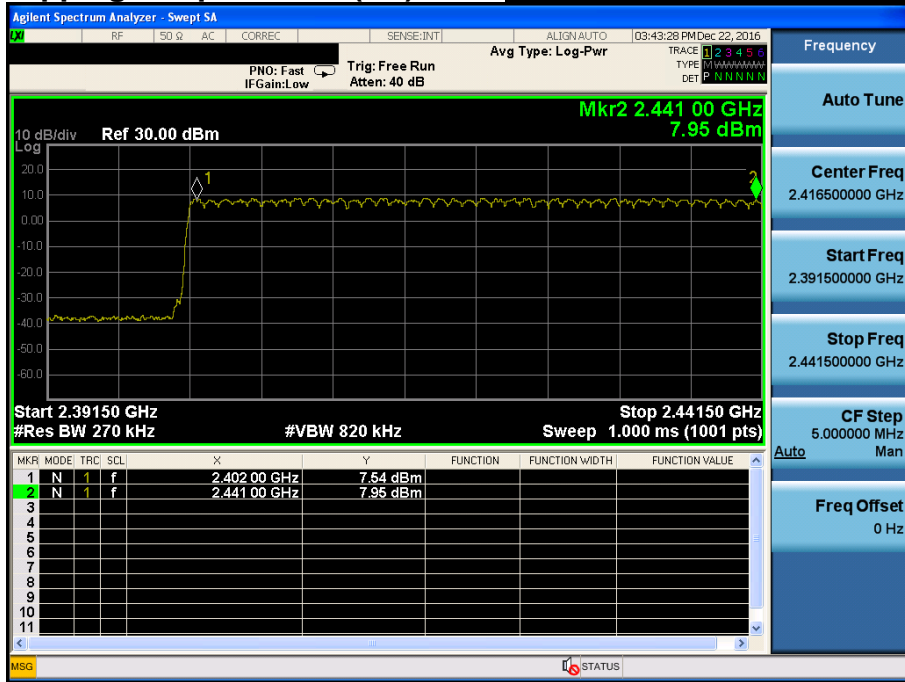

Number of Hopping Frequencies 2(FH)

Hopping mode : Enable & $\pi/4$ DQPSK

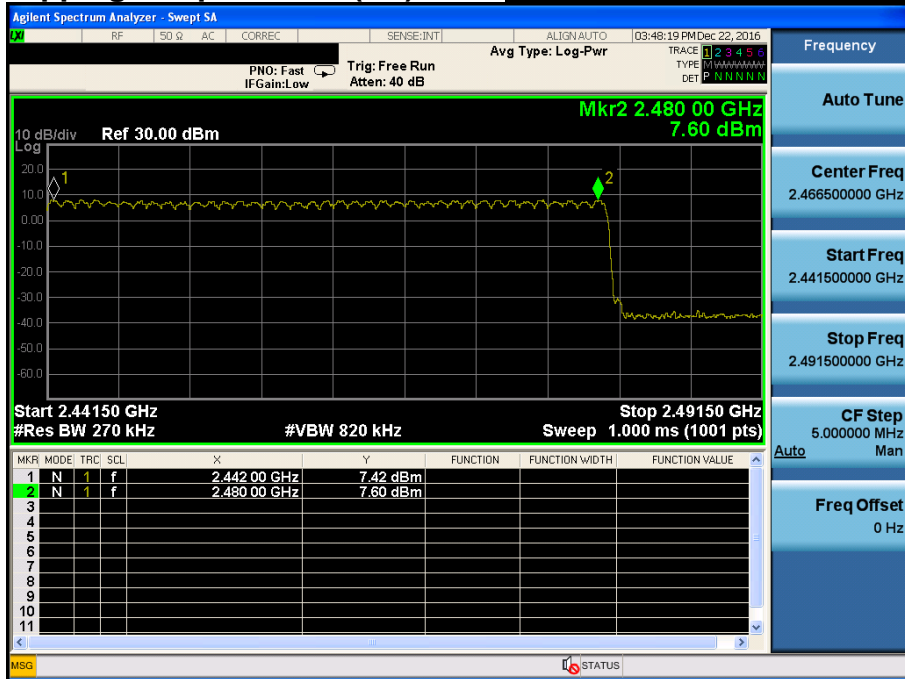

Number of Hopping Frequencies 1(FH) *Hopping mode : Enable & 8DPSK*

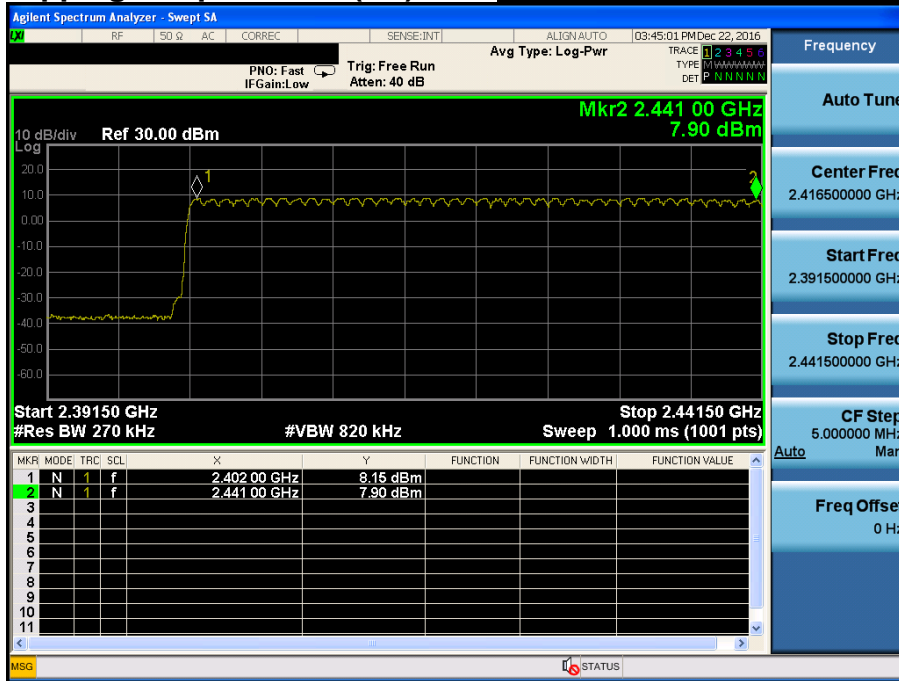

Number of Hopping Frequencies 2(FH) *Hopping mode : Enable & 8DPSK*

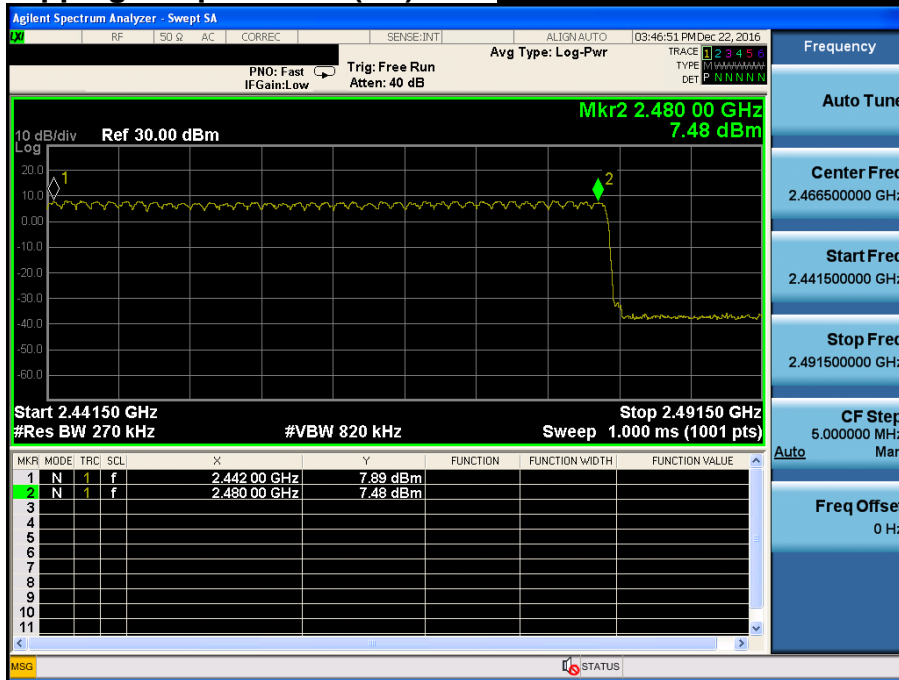

Number of Hopping Frequencies 1(AFH) *Hopping mode : Enable & GFSK*

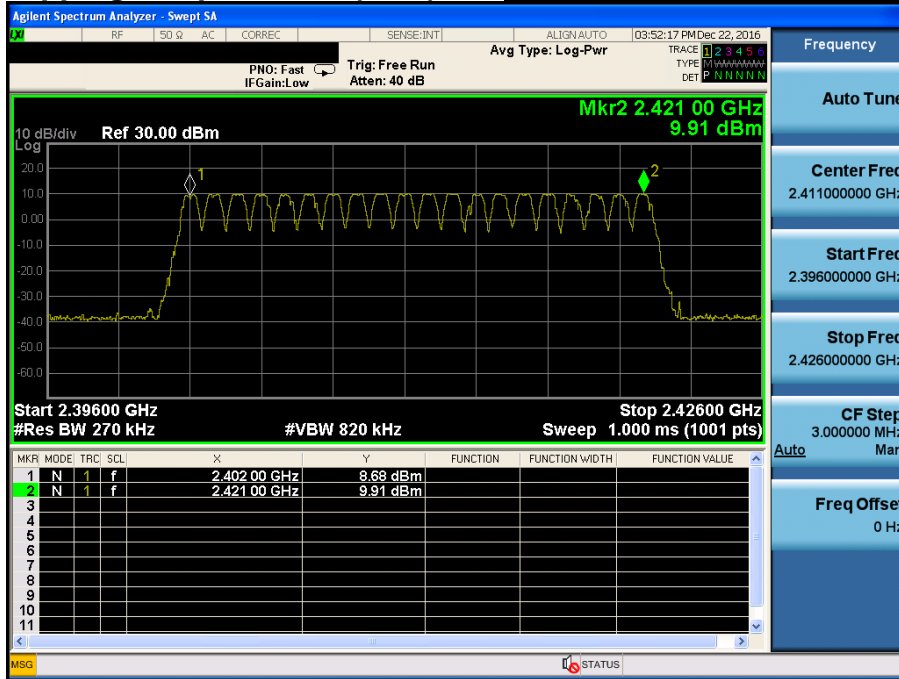

Number of Hopping Frequencies 1(AFH) *Hopping mode : Enable & $\pi/4$ DQPSK*

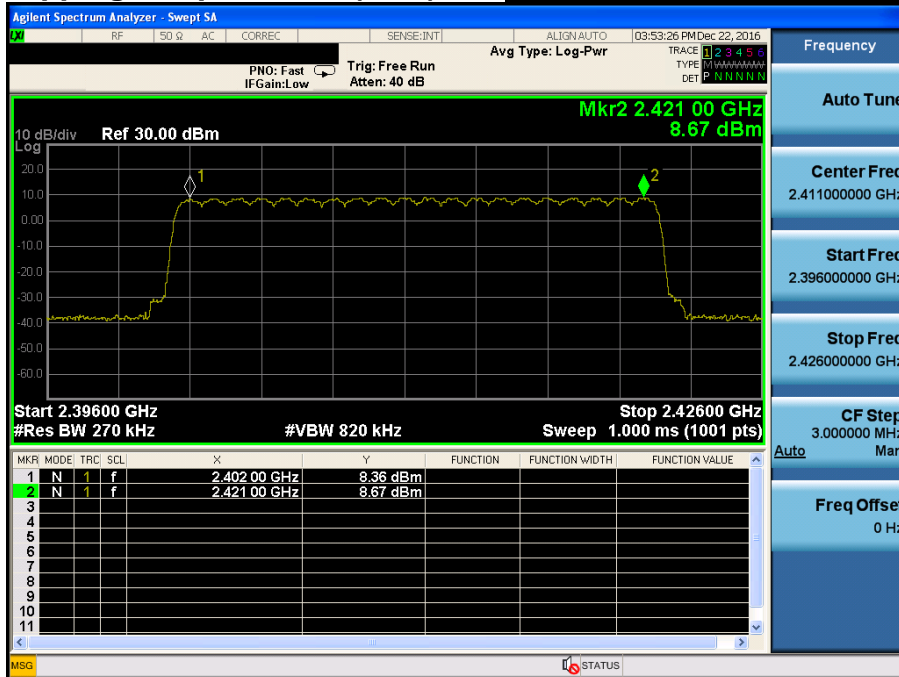

Number of Hopping Frequencies 1(AFH) *Hopping mode : Enable & 8DPSK*

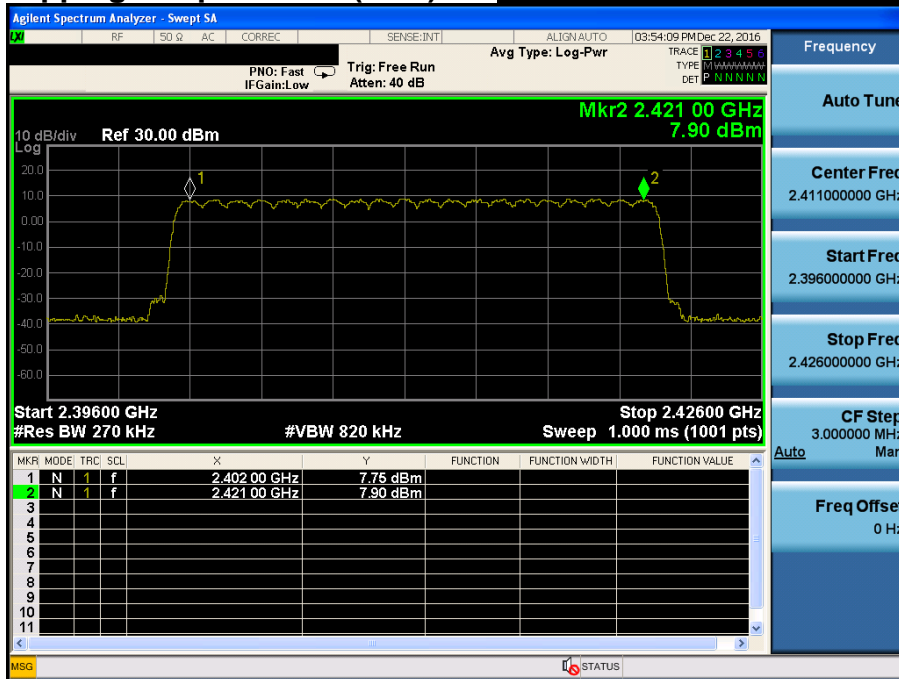

6. Time of Occupancy (Dwell Time)

6.1 Test Setup

Refer to the APPENDIX I.

6.2 Limit

The maximum permissible time of occupancy is 400 ms within a period of 400 ms multiplied by the number of hopping channels employed.

6.3 Test Procedure

The dwell time was measured with a spectrum analyzer connected to the antenna terminal, while EUT had its hopping function enabled.

The spectrum analyzer is set to :

Center frequency for FH mode = 2441 MHz

Center frequency for AFH mode = 2411 MHz

RBW = 1 MHz (RBW shall be \leq channel spacing and where possible RBW should be set $\gg 1 / T$, where T is the expected dwell time per channel)

VBW \geq RBW

Span = zero

Detector function = peak

Trace = max hold

6.4 Test Results

FH mode

Hopping mode	Packet Type	Number of hopping Channels	Burst On Time (ms)	Period (ms)	Test Result (sec)
Enable	DH 5	79	2.880	3.750	0.307
	2 DH 5	79	2.880	3.750	0.307
	3 DH 5	79	2.880	3.750	0.307

AFH mode

Hopping mode	Packet Type	Number of hopping Channels	Burst On Time (ms)	Period (ms)	Test Result (sec)
Enable	DH 5	20	2.880	3.750	0.154
	2 DH 5	20	2.880	3.750	0.154
	3 DH 5	20	2.880	3.750	0.154

Note 1 : Dwell Time = $0.4 \times \text{Hopping channel} \times \text{Burst ON time} \times ((\text{Hopping rate} \div \text{Time slots}) \div \text{Hopping channel})$

- Time slots for DH5 = 6 slots (TX = 5 slot / RX = 1 slot)
- Hopping Rate = 1600 for FH mode & 800 for AFH mode

Note 2 : See next pages for actual measured spectrum plots.

Time of Occupancy (FH)

Hopping mode : Enable & DH 5

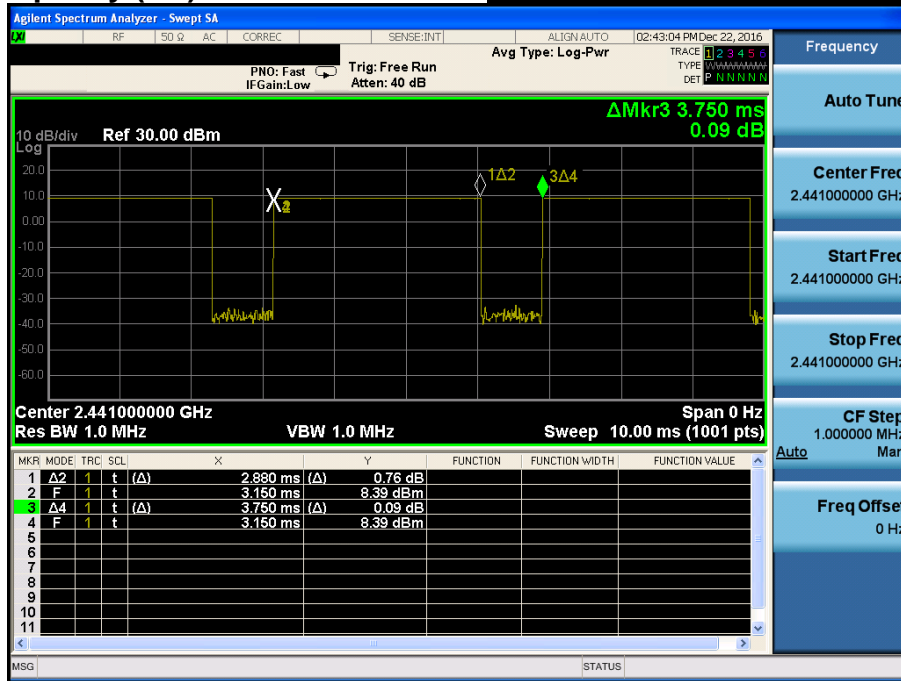

Time of Occupancy (FH)

Hopping mode : Enable & 2 DH 5

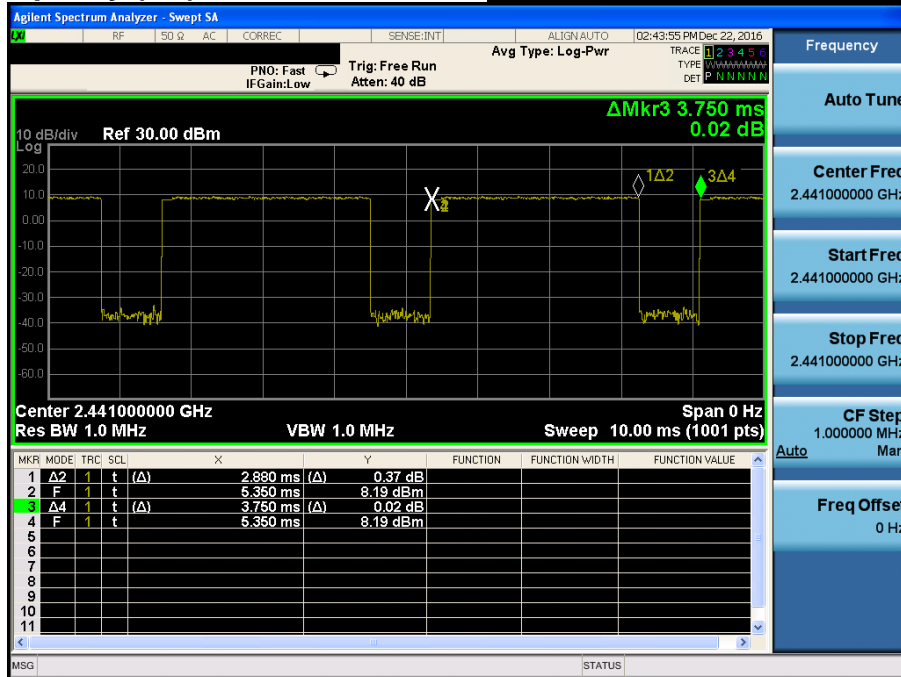

Time of Occupancy (FH)

Hopping mode : Enable & 3 DH 5

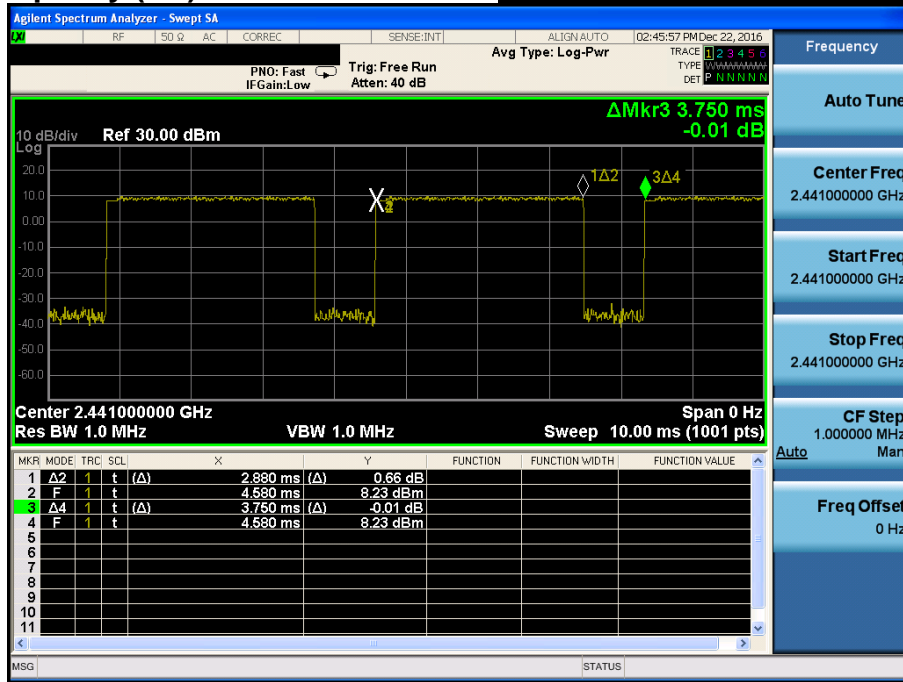

Time of Occupancy (AFH)

Hopping mode : Enable & DH 5

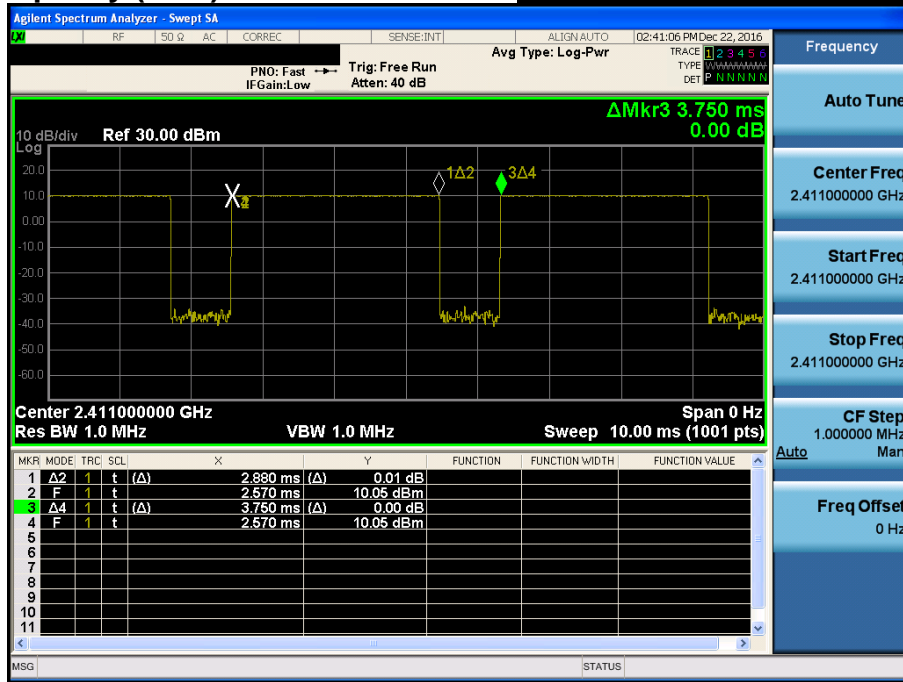

Time of Occupancy (AFH)

Hopping mode : Enable & 2 DH 5

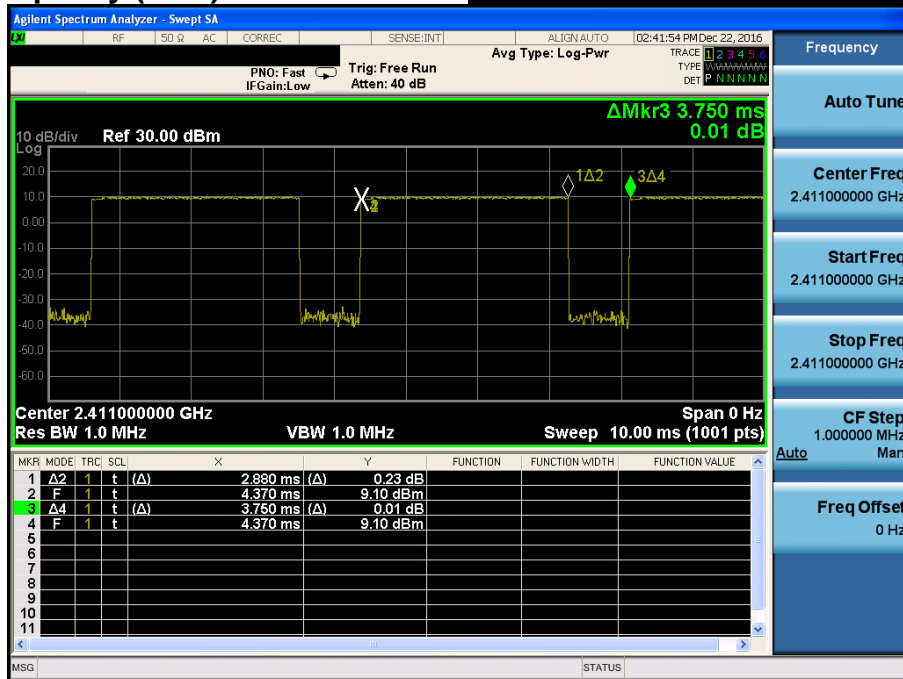

Time of Occupancy (AFH)

Hopping mode : Enable & 3 DH 5

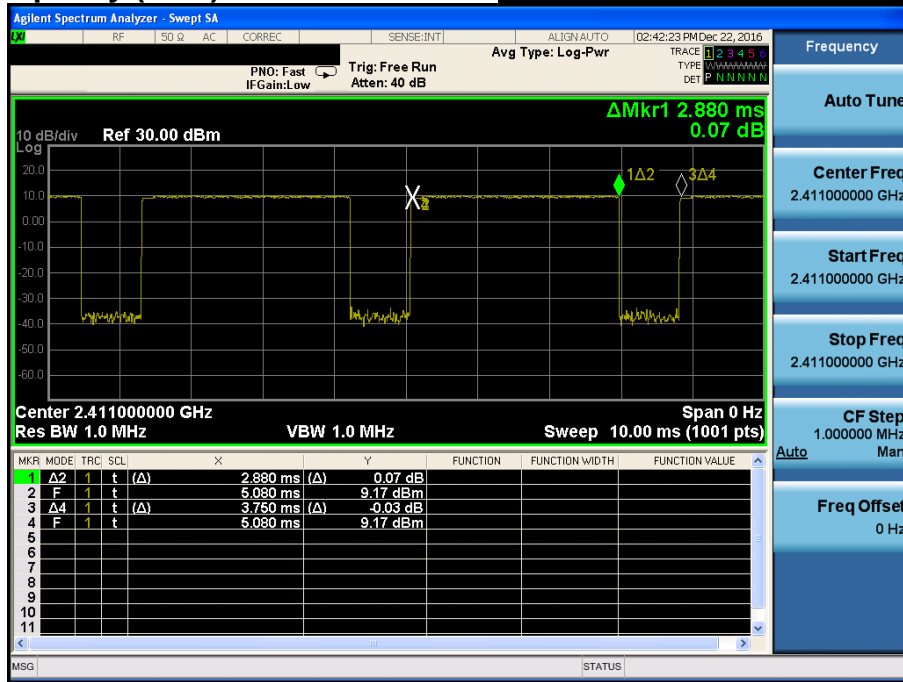

7. Transmitter Radiated Spurious Emissions and Conducted Spurious Emission

7.1 Test Setup

Refer to the APPENDIX I.

7.2 Limit

According to §15.247(d), in any 100 kHz bandwidth outside the frequency band in which the spread spectrum or digitally modulated intentional radiator is operating, the radio frequency power that is produced by the intentional radiator shall be at least 20 dB below that in the 100 kHz bandwidth within the band that contains the highest level of the desired power, based on either an RF conducted or a radiated measurement, provided the transmitter demonstrates compliance with the peak conducted power limits. If the transmitter complies with the conducted power limits based on the use of RMS averaging over a time interval, as permitted under paragraph(b)(3) of this section, the attenuation required under this paragraph shall be 30 dB instead of 20 dB. Attenuation below the general limits specified in section §15.209(a) is not required. In addition, radiated emission which in the restricted band, as define in section §15.205(a), must also comply the radiated emission limits specified in section §15.209(a) (see section §15.205(c))

According to § 15.209(a), except as provided elsewhere in this Subpart, the emissions from an intentional radiator shall not exceed the field strength levels specified in the following table

Frequency (MHz)	Limit (uV/m)	Measurement Distance (meter)
0.009 ~ 0.490	2400/F (kHz)	300
0.490 ~ 1705	24000/F (kHz)	30
1705 ~ 30.0	30	30
30 ~ 88	100 **	3
88 ~ 216	150 **	3
216 ~ 960	200 **	3
Above 960	500	3

** Except as provided in 15.209(g), fundamental emissions from intentional radiators operating under this Section shall not be located in the frequency bands 54 - 72 MHz, 76 - 88 MHz, 174 - 216 MHz or 470 - 806 MHz. However, operation within these frequency bands is permitted under other sections of this Part, e.g. 15.231 and 15.241.

According to § 15.205(a) and (b), only spurious emissions are permitted in any of the frequency bands listed below :

MHz	MHz	MHz	MHz	GHz	GHz
0.009 ~ 0.110	8.41425 ~ 8.41475	108 ~ 121.94	1300 ~ 1427	4.5 ~ 5.15	14.47 ~ 14.5
0.495 ~ 0.505	12.29 ~ 12.293	123 ~ 138	1435 ~ 1626.5	5.35 ~ 5.46	15.35 ~ 16.2
2.1735 ~ 2.1905	12.51975 ~ 12.52025	149.9 ~ 150.05	1645.5 ~ 1646.5	7.25 ~ 7.75	17.7 ~ 21.4
4.125 ~ 4.128	12.57675 ~ 12.57725	156.52475 ~ 156.52525	1660 ~ 1710	8.025 ~ 8.5	22.01 ~ 23.12
4.17725 ~ 4.17775	13.36 ~ 13.41	156.7 ~ 156.9	1718.8 ~ 1722.2	9.0 ~ 9.2	23.6 ~ 24.0
4.20725 ~ 4.20775	16.42 ~ 16.423	162.0125 ~ 167.17	2200 ~ 2300	9.3 ~ 9.5	31.2 ~ 31.8
6.215 ~ 6.218	16.69475 ~ 16.69525	167.72 ~ 173.2	2310 ~ 2390	10.6 ~ 12.7	36.43 ~ 36.5
6.26775 ~ 6.26825	16.80425 ~ 16.80475	240 ~ 285	2483.5 ~ 2500	13.25 ~ 13.4	Above 38.6
6.31175 ~ 6.31225	25.5 ~ 25.67	322 ~ 335.4	2655 ~ 2900		
8.291 ~ 8.294	37.5 ~ 38.25	399.90 ~ 410	3260 ~ 3267		
8.362 ~ 8.366	73 ~ 74.6	608 ~ 614	3332 ~ 3339		
8.37625 ~ 8.38675	74.8 ~ 75.2	960 ~ 1240	3345.8 ~ 3358		
			3600 ~ 4400		

The field strength of emissions appearing within these frequency bands shall not exceed the limits shown in §15.209. At frequencies equal to or less than 1000 MHz, compliance with the limits in §15.209 shall be demonstrated using measurement instrumentation employing a CISPR quasi-peak detector. Above 1000 MHz, compliance with the emission limits in §15.209 shall be demonstrated based on the average value of the measured emissions. The provisions in §15.35 apply to these measurements.

7.3. Test Procedures

7.3.1. Test Procedures for Radiated Spurious Emissions

1. The EUT is placed on a non-conductive table. For emission measurements at or below 1 GHz, the table height is 80 cm. For emission measurements above 1 GHz, the table height is 1.5 m. The table was rotated 360 degrees to determine the position of the highest radiation.
2. During performing radiated emission below 1 GHz, the EUT was set 3 meters away from the interference receiving antenna, which was mounted on the top of a variable-height antenna tower. During performing radiated emission above 1 GHz, the EUT was set 1 or 3 meter away from the interference-receiving antenna.
3. For measurements above 1GHz absorbers are placed on the floor between the turn table and the antenna mast in such a way so as to maximize the reduction of reflections. For measurements below 1 GHz, the absorbers are removed.
4. The antenna is a broadband antenna, and its height is varied from one meter to four meters above the ground to determine the maximum value of the field strength. Both horizontal and vertical polarizations of the antenna are set to make the measurement.
5. For each suspected emission, the EUT was arranged to its worst case and then the antenna was tuned to heights from 1 meter to 4 meters and the table was turned from 0 degrees to 360 degrees to find the maximum reading.
6. The test-receiver system was set to Peak Detect Function and Specified Bandwidth with Maximum Hold Mode.
7. If the emission level of the EUT in peak mode was 10 dB lower than the limit specified, then testing could be stopped and the peak values of the EUT would be reported. Otherwise the emissions that did not have 10 dB margin would be re-tested one by one using peak, quasi-peak or average method as specified and then reported in a data sheet.

NOTE 1. The resolution bandwidth and video bandwidth of test receiver/spectrum analyzer is 120 kHz for Quasi-peak detection (QP) at frequency below 1 GHz.

NOTE 2. The resolution bandwidth and video bandwidth of test receiver/spectrum analyzer is 1 MHz for Peak detection and frequency above 1 GHz.

NOTE 3. The resolution bandwidth of test receiver/spectrum analyzer is 1 MHz and the video bandwidth is 1 kHz for Average detection (AV) at frequency above 1 GHz.

7.3.2. Test Procedures for Conducted Spurious Emissions

1. The transmitter output was connected to the spectrum analyzer.
2. The **reference level** of the fundamental frequency was measured with the spectrum analyzer using RBW = 100 kHz, VBW = 300 kHz.
3. The conducted spurious emission was tested each ranges were set as below.

Frequency range : 9 kHz ~ 30 MHz

RBW = 100 kHz, VBW = 300 kHz, SWEEP TIME = AUTO, DETECTOR = PEAK, TRACE = MAX HOLD, SWEEP POINT : 40001

Frequency range : 30 MHz ~ 10 GHz, 10 GHz ~ 25 GHz

RBW = 1 MHz, VBW = 3 MHz, SWEEP TIME = AUTO, DETECTOR = PEAK, TRACE = MAX HOLD, SWEEP POINT : 40001

LIMIT LINE = 20 dB below of the reference level of above measurement procedure Step 2. (RBW = 100 kHz, VBW = 300 kHz)

If the emission level with above setting was close to the limit (ie, less than 3 dB margin) then zoom scan is required using RBW = 100 kHz, VBW = 300 kHz, SPAN = 100 MHz and BINS = 2001 to get accurate emission level within 100 kHz BW.

Also the path loss for conducted measurement setup was used as described on the Appendix I of this test report.

7.4. Test Results

7.4.1. Radiated Emissions

Note: Attached the worst data plots, refer to the Appendix II.

9 kHz ~ 25 GHz Data (Modulation : GFSK)

▪ Lowest Channel

Frequency (MHz)	ANT Pol	EUT Position (Axis)	Detector Mode	Reading (dBuV)	T.F (dB/m)	D.C.F (dB)	Distance Factor (dB)	Result (dBuV/m)	Limit (dBuV/m)	Margin (dB)
2381.12	H	X	PK	49.94	0.70	N/A	N/A	50.64	74.00	23.36
2381.51	H	X	AV	37.33	0.70	-24.79	N/A	13.24	54.00	40.76
4805.41	V	Z	PK	44.22	7.63	N/A	N/A	51.85	74.00	22.15
4804.93	V	Z	AV	31.24	7.63	-24.79	N/A	14.08	54.00	39.92

▪ Middle Channel

Frequency (MHz)	ANT Pol	EUT Position (Axis)	Detector Mode	Reading (dBuV)	T.F (dB/m)	D.C.F (dB)	Distance Factor (dB)	Result (dBuV/m)	Limit (dBuV/m)	Margin (dB)
4880.83	H	X	PK	45.04	7.36	N/A	N/A	52.40	74.00	21.60
4880.52	H	X	AV	31.66	7.36	-24.79	N/A	14.23	54.00	39.77

▪ Highest Channel

Frequency (MHz)	ANT Pol	EUT Position (Axis)	Detector Mode	Reading (dBuV)	T.F (dB/m)	D.C.F (dB)	Distance Factor (dB)	Result (dBuV/m)	Limit (dBuV/m)	Margin (dB)
2483.50	V	Z	PK	52.01	1.10	N/A	N/A	53.11	74.00	20.89
2483.62	V	Z	AV	37.72	1.10	-24.79	N/A	14.03	54.00	39.97
4960.20	H	X	PK	44.51	7.48	N/A	N/A	51.99	74.00	22.01
4960.30	H	X	AV	32.02	7.48	-24.79	N/A	14.71	54.00	39.29

▪ Note.

- No other spurious and harmonic emissions were found greater than listed emissions on above table.
- Information of Distance Factor

For finding emissions, the test distance might be reduced from 3m to 1m. In this case, the distance factor(-9.54dB) is applied to the result.

$$\text{Calculation of distance factor} = 20 \log(\text{applied distance} / \text{required distance}) = 20 \log(1 \text{ m} / 3 \text{ m}) = \underline{\underline{-9.54 \text{ dB}}}$$

When distance factor is "N/A", the distance is 3 m and distance factor is not applied.

- D.C.F Calculation. (D.C.F = Duty Cycle Correction Factor)

$$\text{Time to cycle through all channels} = \Delta t = T [\text{ms}] \times 20 \text{ minimum hopping channels}, \text{ where } T = \text{pulse width} = \underline{\underline{2.88 \text{ ms}}}$$

$$100 \text{ ms} / \Delta t [\text{ms}] = H \rightarrow \text{Round up to next highest integer, to account for worst case, } H' = \underline{\underline{100 / (2.88 \times 20) = 1.7 \approx 2}}$$

$$\text{The Worst Case Dwell Time} = T [\text{ms}] \times H' = \underline{\underline{2.88 \text{ ms} \times 2 = 5.76 \text{ ms}}}$$

$$\text{D.C.F} = 20 \log(\text{The Worst Case Dwell Time} / 100 \text{ ms}) \text{ dB} = \underline{\underline{20 \log(5.76 / 100) = -24.79 \text{ dB}}}$$

- Sample Calculation.

$$\text{Margin} = \text{Limit} - \text{Result} \quad / \quad \text{Result} = \text{Reading} + \text{T.F} + \text{D.C.F} \quad / \quad \text{T.F} = \text{AF} + \text{CL} - \text{AG}$$

Where, T.F = Total Factor, AF = Antenna Factor, CL = Cable Loss, AG = Amplifier Gain.

9 kHz ~ 25 GHz Data (Modulation : $\pi/4$ DQPSK)

▪ Lowest Channel

Frequency (MHz)	ANT Pol	EUT Position (Axis)	Detector Mode	Reading (dBuV)	T.F (dB/m)	D.C.F (dB)	Distance Factor (dB)	Result (dBuV/m)	Limit (dBuV/m)	Margin (dB)
2380.23	H	X	PK	49.74	0.70	N/A	N/A	50.44	74.00	23.56
2380.33	H	X	AV	37.15	0.70	-24.79	N/A	13.06	54.00	40.94
4805.02	V	Z	PK	44.23	7.63	N/A	N/A	51.86	74.00	22.14
4804.89	V	Z	AV	31.41	7.63	-24.79	N/A	14.25	54.00	39.75

▪ Middle Channel

Frequency (MHz)	ANT Pol	EUT Position (Axis)	Detector Mode	Reading (dBuV)	T.F (dB/m)	D.C.F (dB)	Distance Factor (dB)	Result (dBuV/m)	Limit (dBuV/m)	Margin (dB)
4881.48	V	Z	PK	44.19	7.33	N/A	N/A	51.52	74.00	22.48
4881.44	V	Z	AV	31.60	7.33	-24.79	N/A	14.14	54.00	39.86

▪ Highest Channel

Frequency (MHz)	ANT Pol	EUT Position (Axis)	Detector Mode	Reading (dBuV)	T.F (dB/m)	D.C.F (dB)	Distance Factor (dB)	Result (dBuV/m)	Limit (dBuV/m)	Margin (dB)
2483.70	H	X	PK	51.23	1.10	N/A	N/A	52.33	74.00	21.67
2483.52	H	X	AV	38.63	1.10	-24.79	N/A	14.94	54.00	39.06
4959.43	V	Z	PK	44.70	7.48	N/A	N/A	52.18	74.00	21.82
4959.57	V	Z	AV	31.86	7.48	-24.79	N/A	14.55	54.00	39.45

 ▪ **Note.**

1. No other spurious and harmonic emissions were found greater than listed emissions on above table.

2. Information of Distance Factor

For finding emissions, the test distance might be reduced from 3m to 1m. In this case, the distance factor(-9.54dB) is applied to the result.

- Calculation of distance factor = $20 \log(\text{applied distance} / \text{required distance}) = 20 \log(1 \text{ m} / 3 \text{ m}) = \underline{-9.54 \text{ dB}}$

When distance factor is "N/A", the distance is 3 m and distance factor is not applied.

3. D.C.F Calculation. (D.C.F = Duty Cycle Correction Factor)

- Time to cycle through all channels = $\Delta t = T [\text{ms}] \times 20$ minimum hopping channels, where T = pulse width = **2.88 ms**

- $100 \text{ ms} / \Delta t [\text{ms}] = H \rightarrow$ Round up to next highest integer, to account for worst case, $H' = 100 / (2.88 \times 20) = 1.7 \approx 2$

- The Worst Case Dwell Time = $T [\text{ms}] \times H' = 2.88 \text{ ms} \times 2 = 5.76 \text{ ms}$

- D.C.F = $20 \log(\text{The Worst Case Dwell Time} / 100 \text{ ms}) \text{ dB} = 20 \log(5.76 / 100) = \underline{-24.79 \text{ dB}}$

4. Sample Calculation.

Margin = Limit – Result / Result = Reading + T.F + D.C.F / T.F = AF + CL – AG

Where, T.F = Total Factor, AF = Antenna Factor, CL = Cable Loss, AG = Amplifier Gain.

9 kHz ~ 25 GHz Data (Modulation : 8DPSK)

▪ Lowest Channel

Frequency (MHz)	ANT Pol	EUT Position (Axis)	Detector Mode	Reading (dBuV)	T.F (dB/m)	D.C.F (dB)	Distance Factor (dB)	Result (dBuV/m)	Limit (dBuV/m)	Margin (dB)
2382.59	H	X	PK	49.00	0.72	N/A	N/A	49.72	74.00	24.28
2382.30	H	X	AV	37.27	0.72	-24.79	N/A	13.20	54.00	40.80
4802.92	V	Z	PK	44.23	7.63	N/A	N/A	51.86	74.00	22.14
4803.38	V	Z	AV	31.23	7.63	-24.79	N/A	14.07	54.00	39.93

▪ Middle Channel

Frequency (MHz)	ANT Pol	EUT Position (Axis)	Detector Mode	Reading (dBuV)	T.F (dB/m)	D.C.F (dB)	Distance Factor (dB)	Result (dBuV/m)	Limit (dBuV/m)	Margin (dB)
4881.16	H	X	PK	44.10	7.33	N/A	N/A	51.43	74.00	22.57
4880.84	H	X	AV	31.65	7.33	-24.79	N/A	14.19	54.00	39.81

▪ Highest Channel

Frequency (MHz)	ANT Pol	EUT Position (Axis)	Detector Mode	Reading (dBuV)	T.F (dB/m)	D.C.F (dB)	Distance Factor (dB)	Result (dBuV/m)	Limit (dBuV/m)	Margin (dB)
2483.69	V	Z	PK	51.68	1.10	N/A	N/A	52.78	74.00	21.22
2483.52	V	Z	AV	38.48	1.10	-24.79	N/A	14.79	54.00	39.21
4960.53	H	X	PK	44.66	7.48	N/A	N/A	52.14	74.00	21.86
4960.14	H	X	AV	32.05	7.48	-24.79	N/A	14.74	54.00	39.26

 ▪ Note.

1. No other spurious and harmonic emissions were found greater than listed emissions on above table.

2. Information of Distance Factor

For finding emissions, the test distance might be reduced from 3m to 1m. In this case, the distance factor(-9.54dB) is applied to the result.

- Calculation of distance factor = $20 \log(\text{applied distance} / \text{required distance}) = 20 \log(1 \text{ m} / 3 \text{ m}) = \underline{-9.54 \text{ dB}}$

When distance factor is "N/A", the distance is 3 m and distance factor is not applied.

3. D.C.F Calculation. (D.C.F = Duty Cycle Correction Factor)

- Time to cycle through all channels = $\Delta t = T [\text{ms}] \times 20$ minimum hopping channels, where T = pulse width = **2.88 ms**

- $100 \text{ ms} / \Delta t [\text{ms}] = H \rightarrow$ Round up to next highest integer, to account for worst case, $H' = 100 / (2.88 \times 20) = 1.7 \approx 2$

- The Worst Case Dwell Time = $T [\text{ms}] \times H' = 2.88 \text{ ms} \times 2 = 5.76 \text{ ms}$

- D.C.F = $20 \text{ Log}(\text{The Worst Case Dwell Time} / 100 \text{ ms}) \text{ dB} = 20 \log(5.76 / 100) = \underline{-24.79 \text{ dB}}$

4. Sample Calculation.

Margin = Limit – Result / Result = Reading + T.F + D.C.F / T.F = AF + CL – AG

Where, T.F = Total Factor, AF = Antenna Factor, CL = Cable Loss, AG = Amplifier Gain.

7.4.2. Conducted Spurious Emissions

Low Band-edge

Lowest Channel & Modulation : GFSK

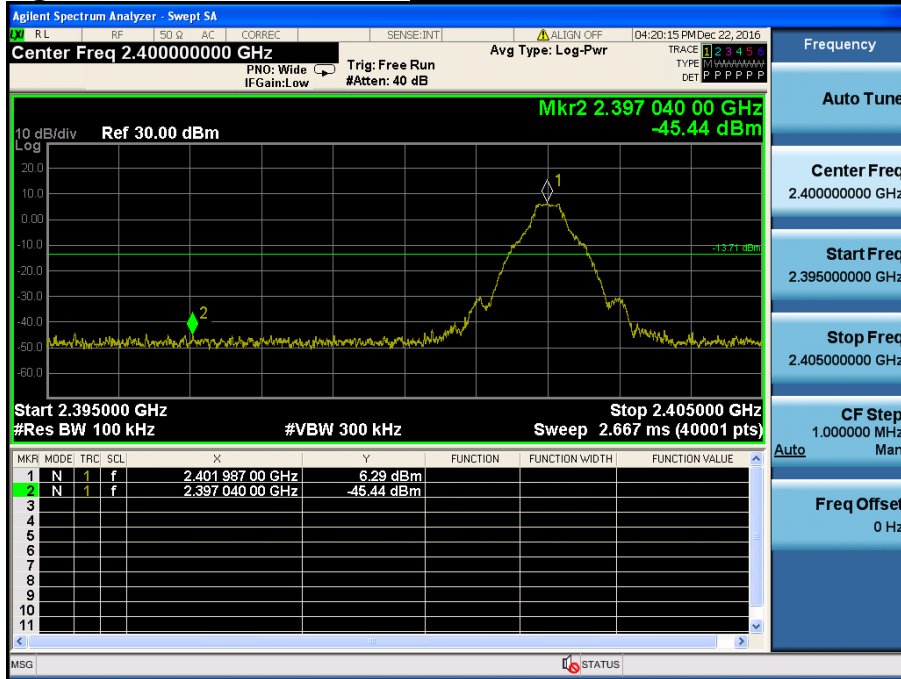

Low Band-edge

Hopping mode & Modulation : GFSK

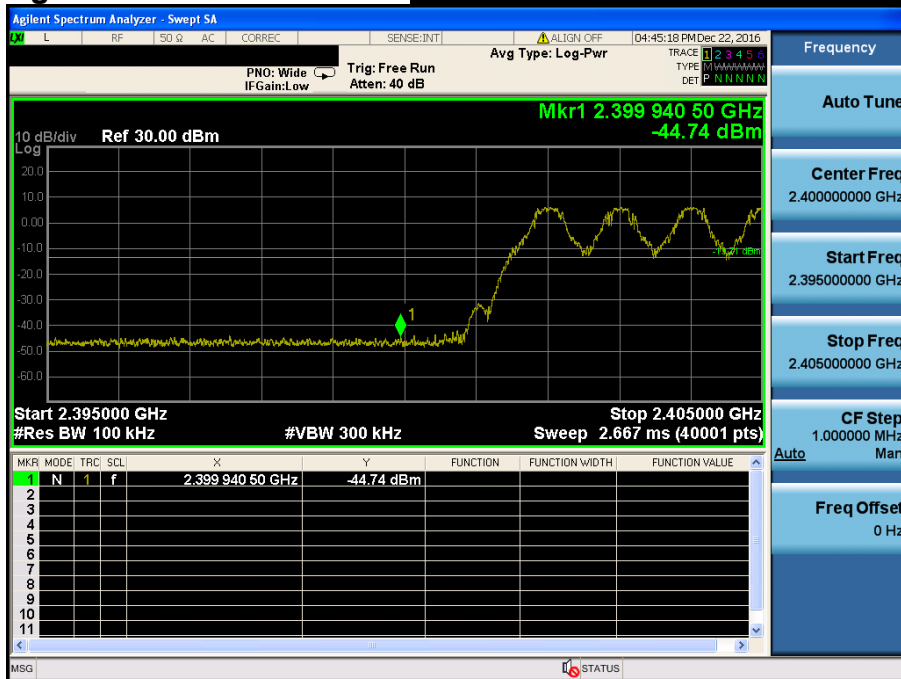

Conducted Spurious Emissions **Lowest Channel & Modulation : GFSK**

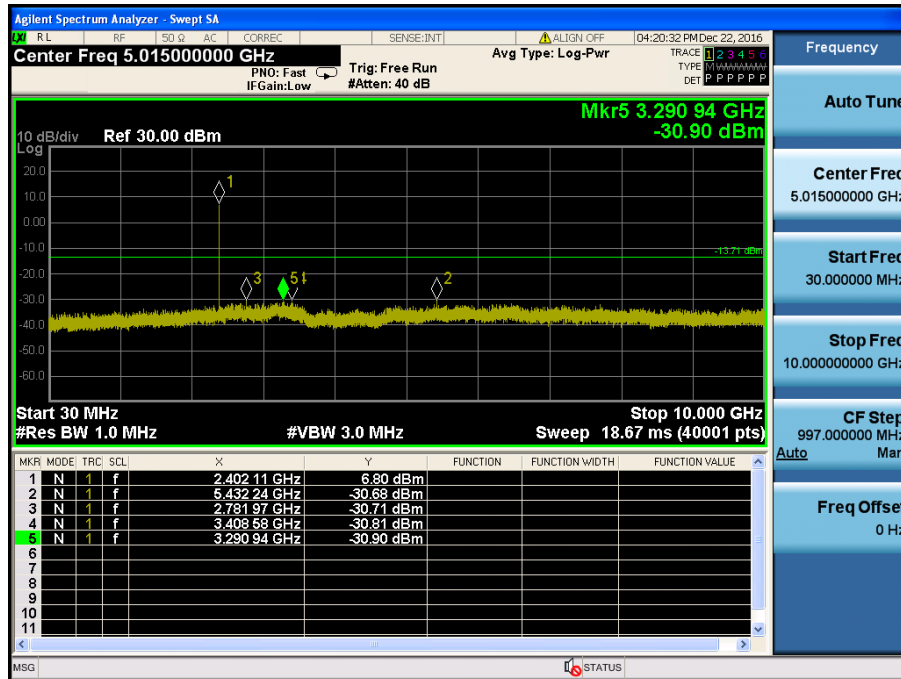
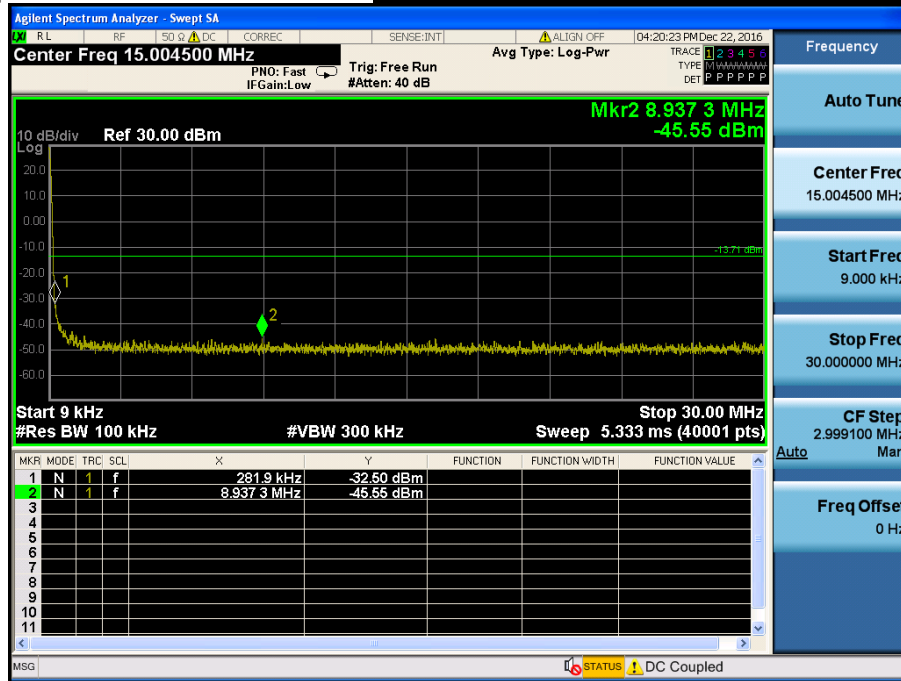

Conducted Spurious Emissions **Lowest Channel & Modulation : GFSK**

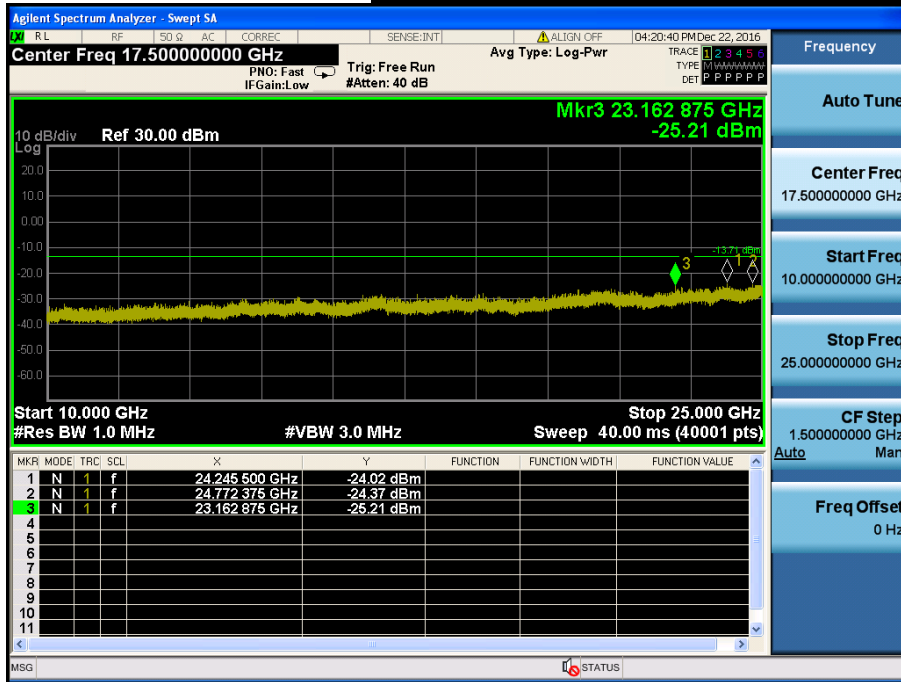

Reference for limit

Middle Channel & Modulation : GFSK

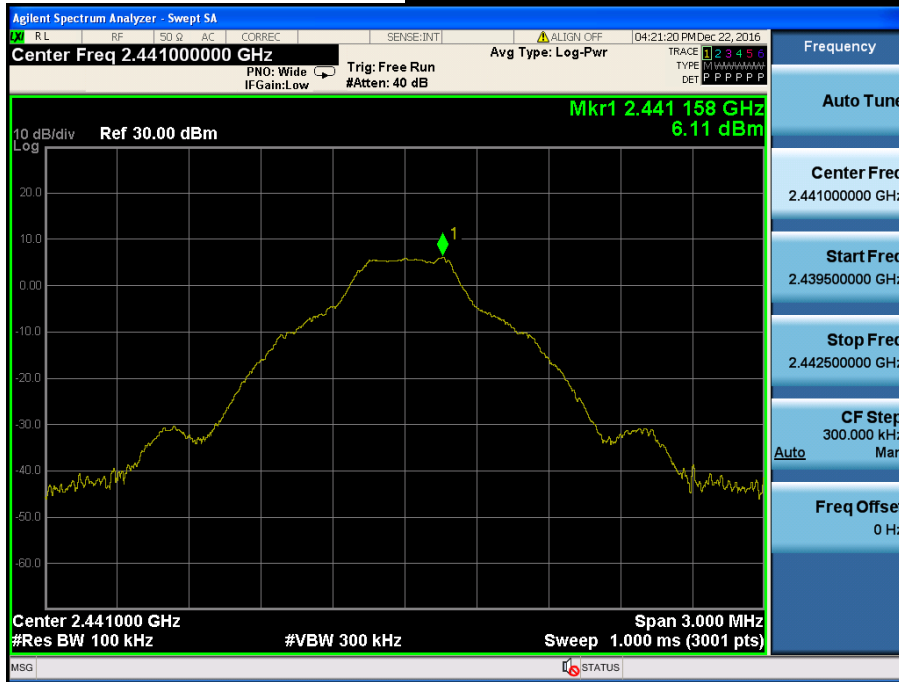

Conducted Spurious Emissions

Middle Channel & Modulation : GFSK

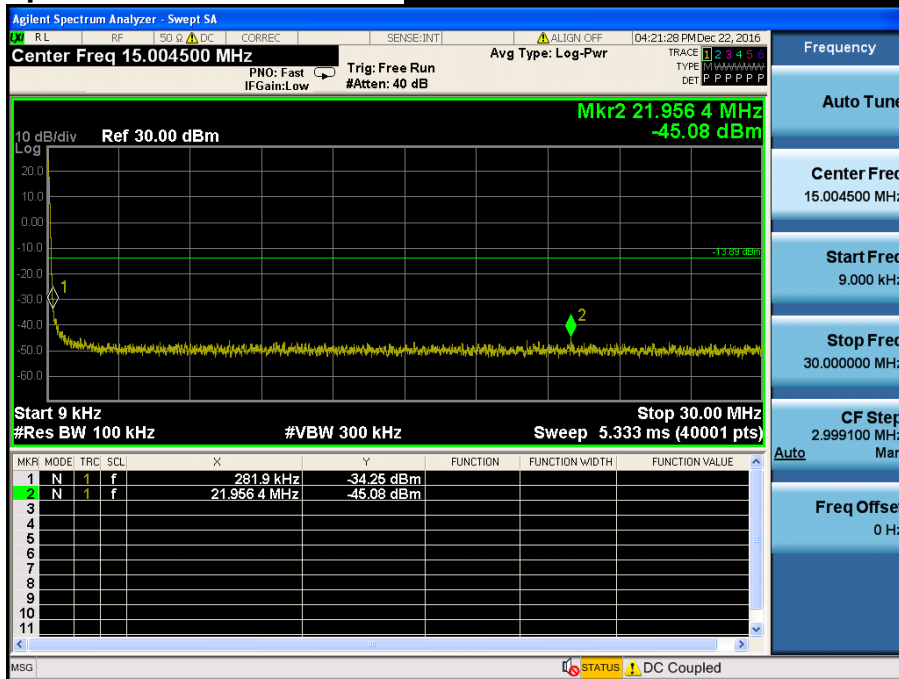

Conducted Spurious Emissions *Middle Channel & Modulation : GFSK*

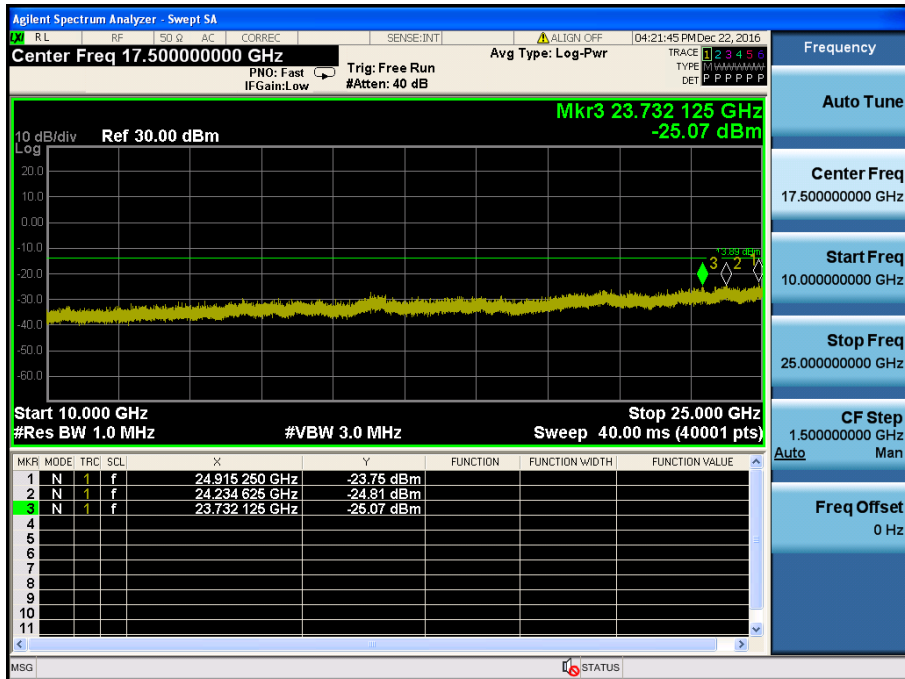
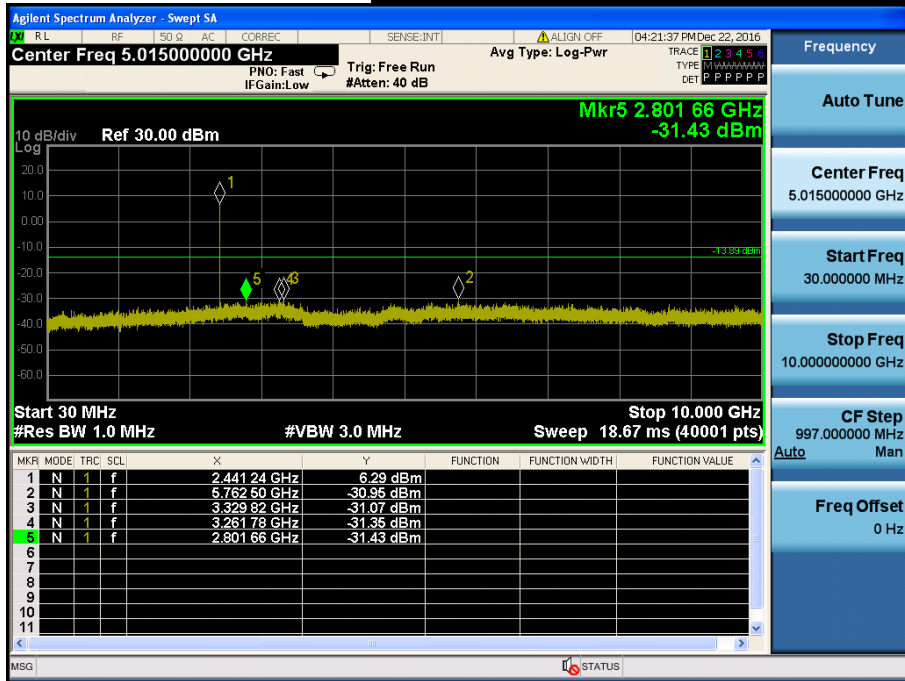

High Band-edge

Highest Channel & Modulation : GFSK

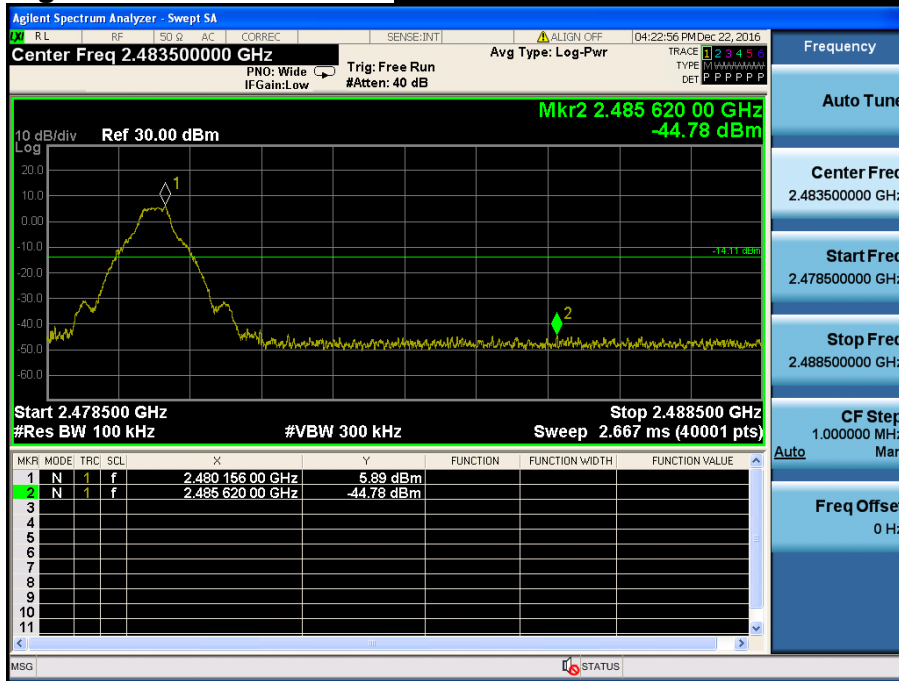

High Band-edge

Hopping mode & Modulation : GFSK

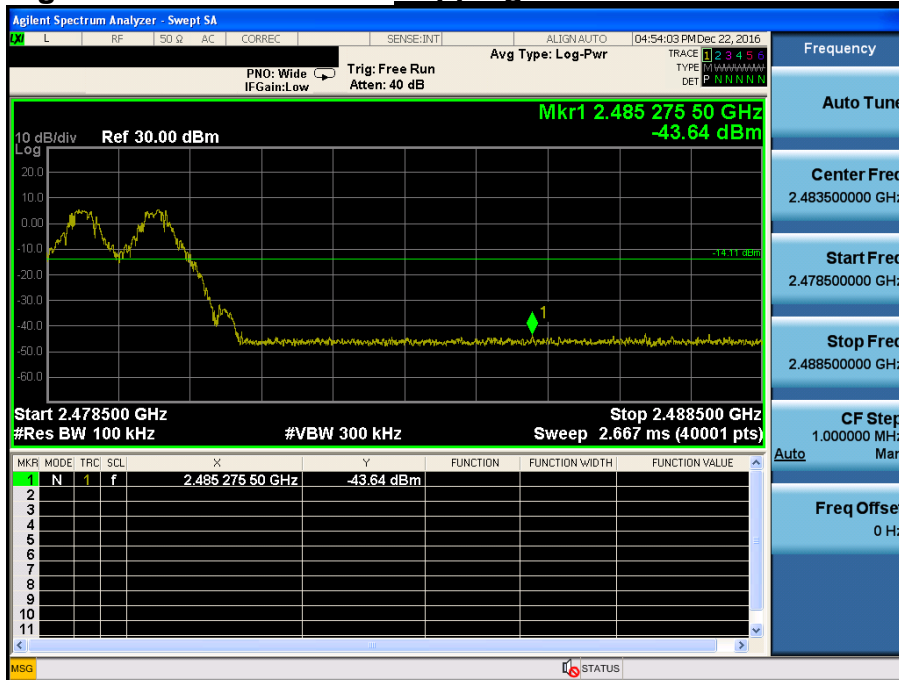

Conducted Spurious Emissions **Highest Channel & Modulation : GFSK**

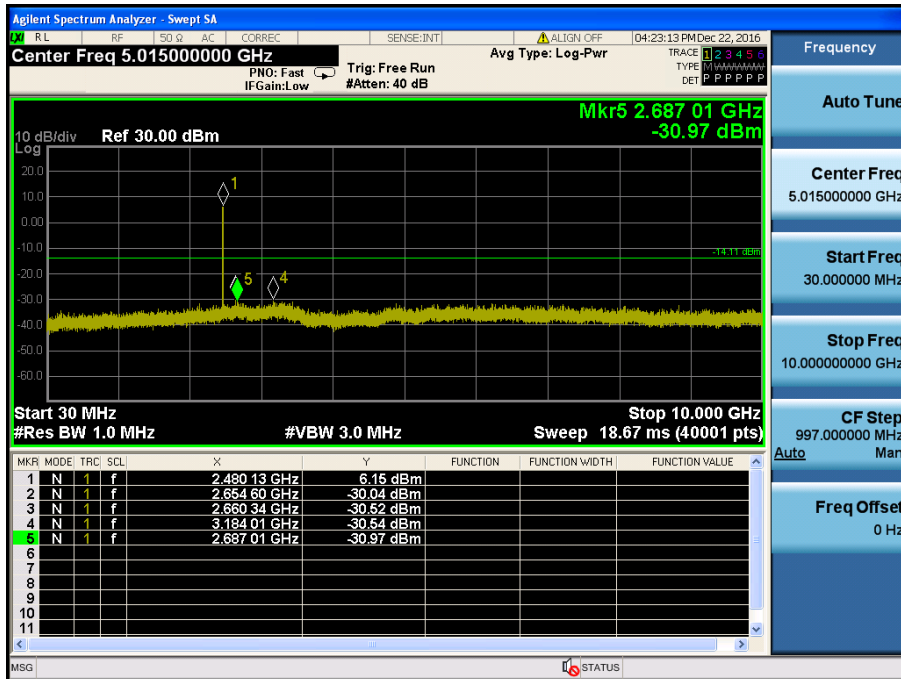
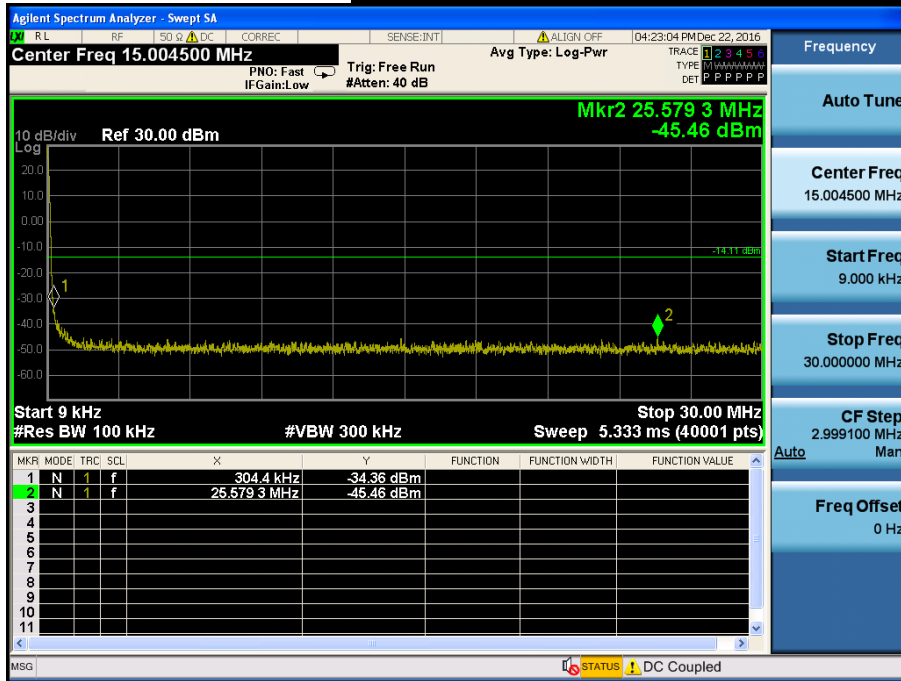

Conducted Spurious Emissions **Highest Channel & Modulation : GFSK**

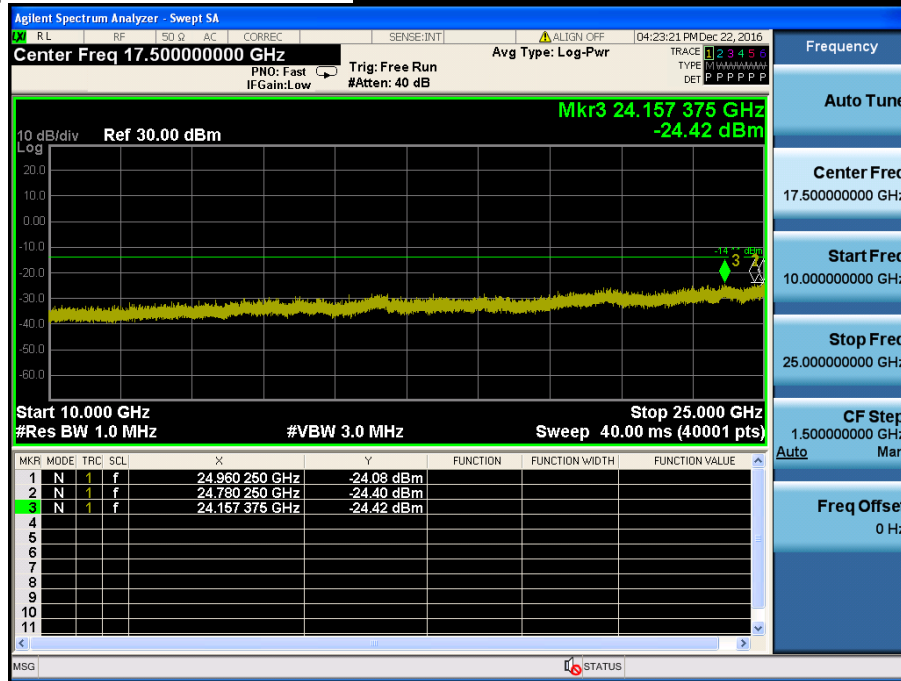

Low Band-edge

Lowest Channel & Modulation : $\pi/4$ DQPSK

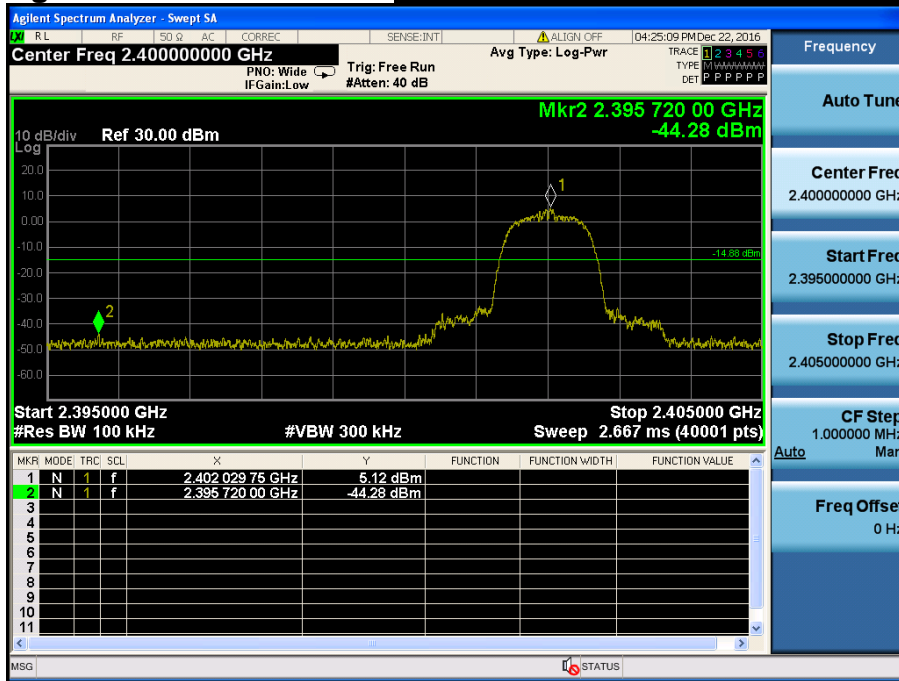

Low Band-edge

Hopping mode & Modulation : $\pi/4$ DQPSK

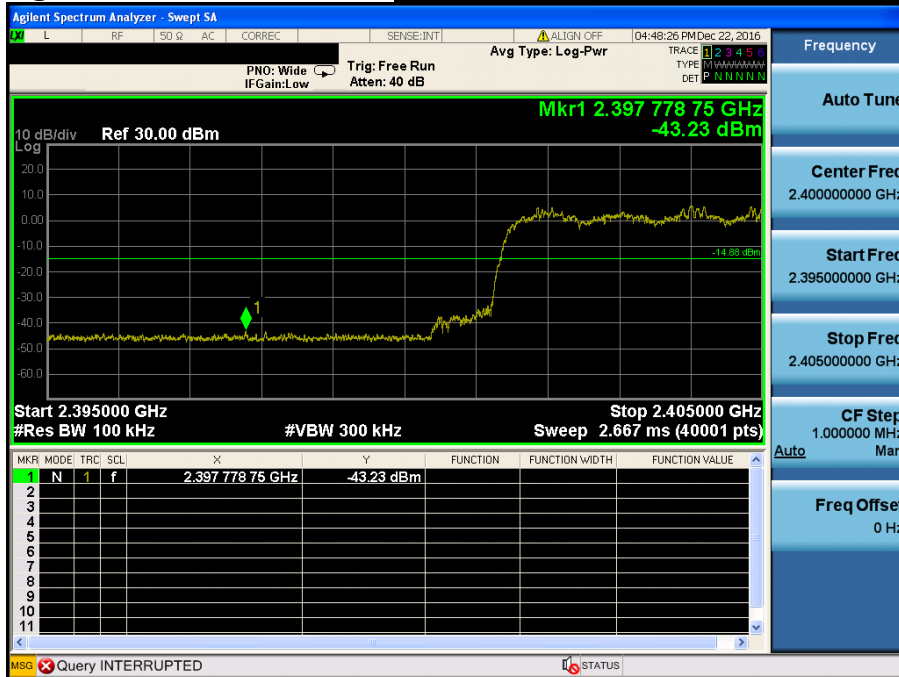

Conducted Spurious Emissions **Lowest Channel & Modulation : $\pi/4$ DQPSK**

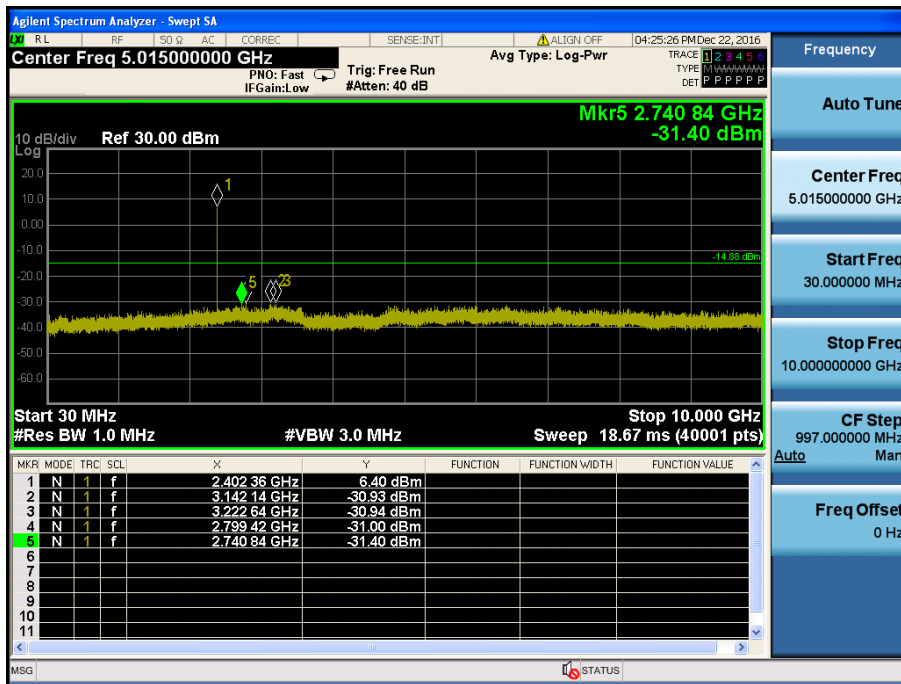
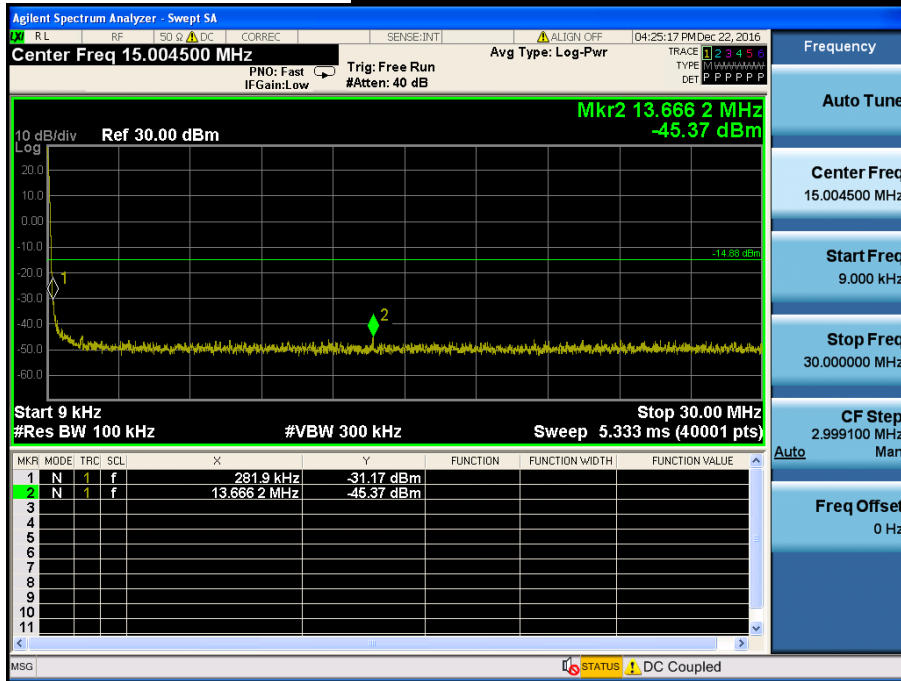

Conducted Spurious Emissions **Lowest Channel & Modulation : $\pi/4$ DQPSK**

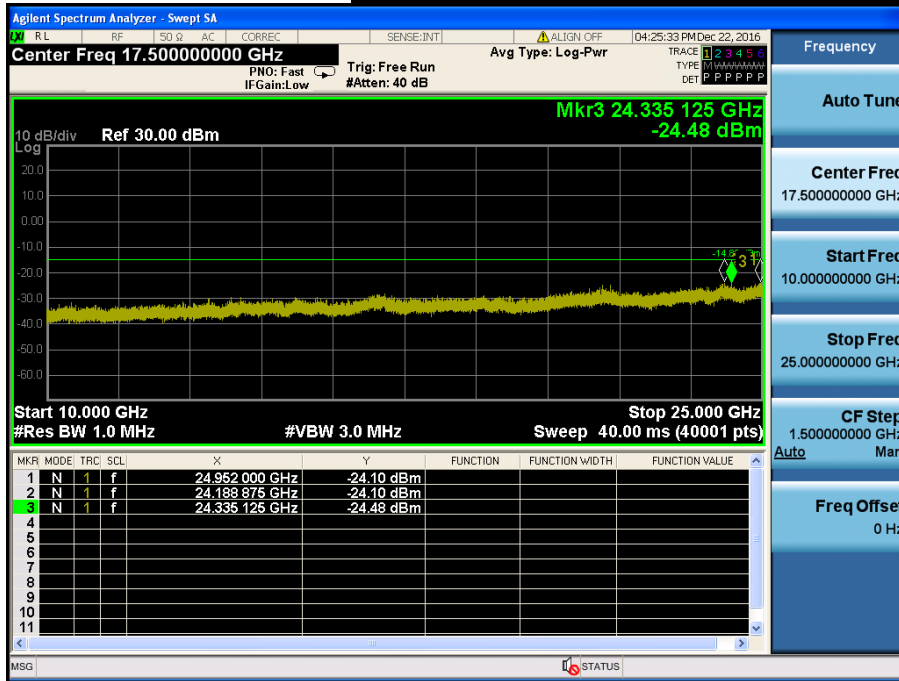

Reference for limit

Middle Channel & Modulation : $\pi/4$ DQPSK

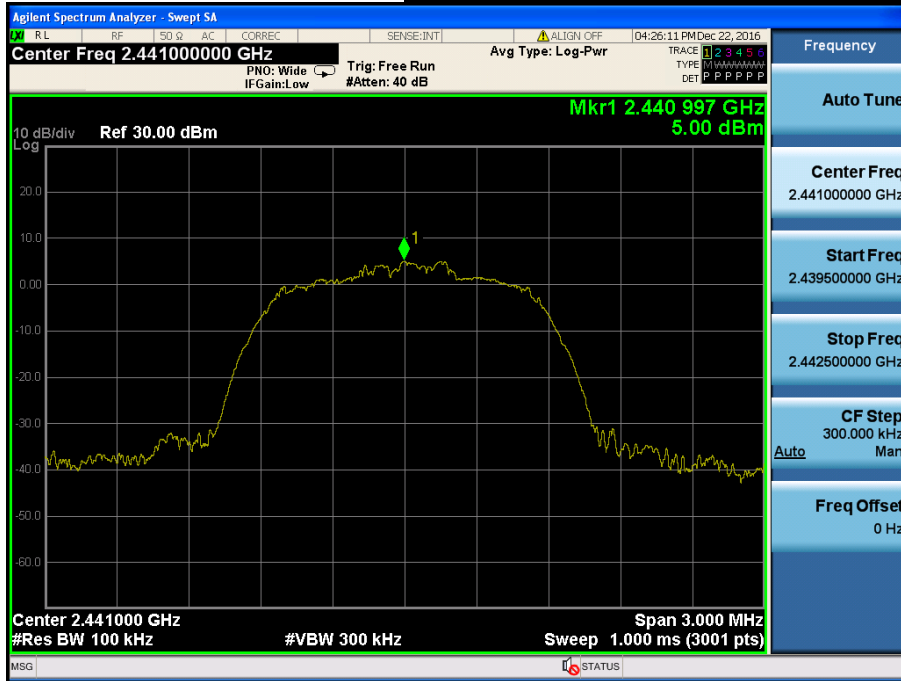

Conducted Spurious Emissions

Middle Channel & Modulation : $\pi/4$ DQPSK

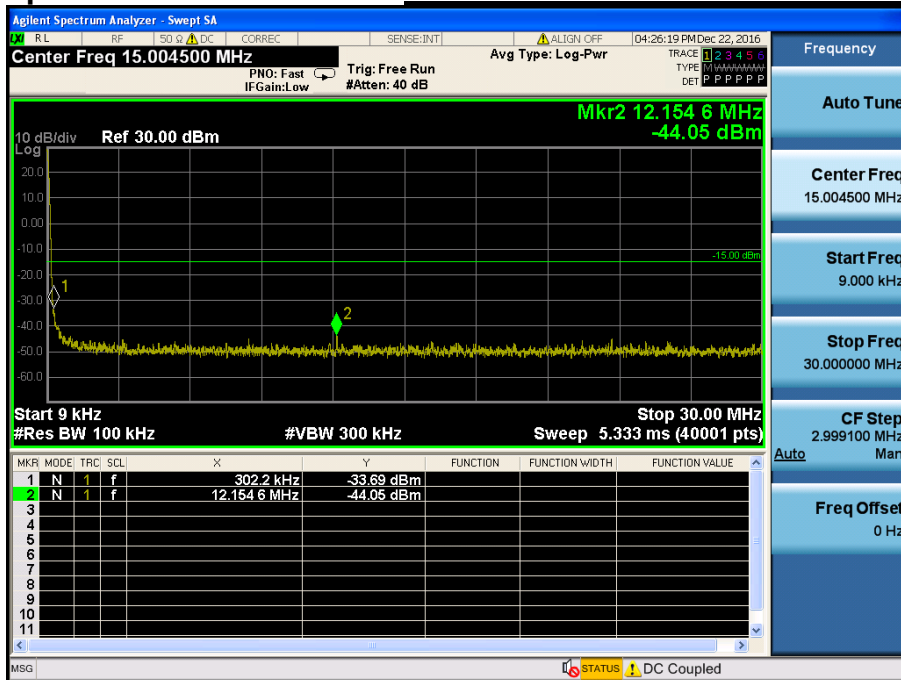

Conducted Spurious Emissions *Middle Channel & Modulation : $\pi/4$ DQPSK*

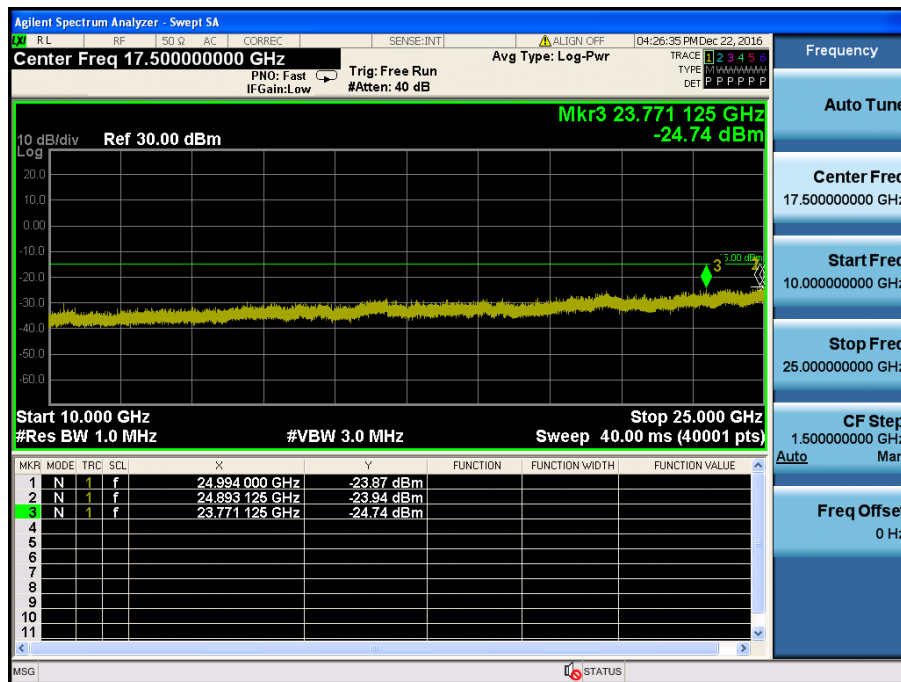
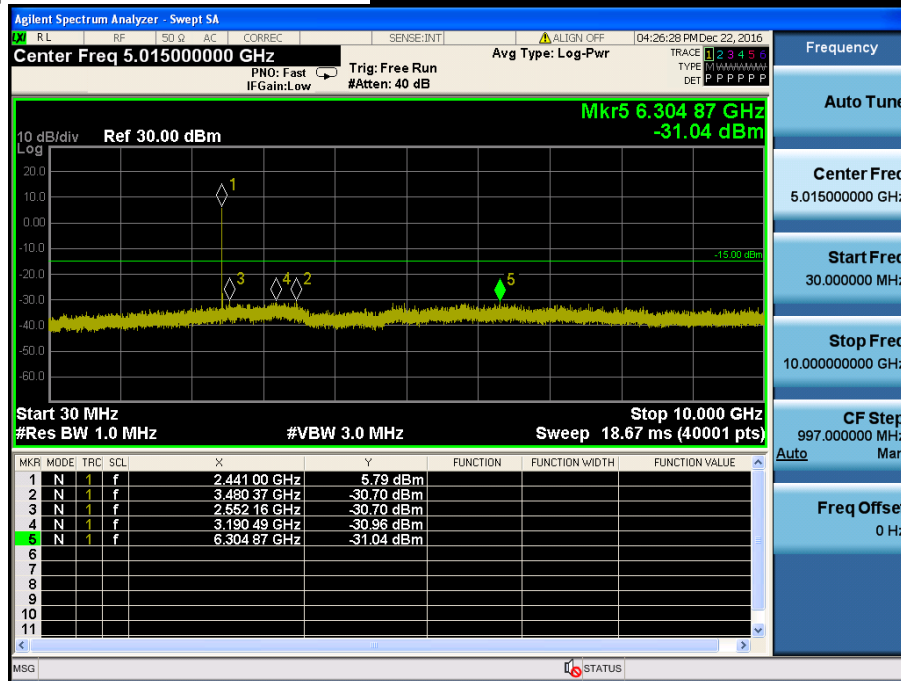

High Band-edge

Highest Channel & Modulation : $\pi/4$ DQPSK

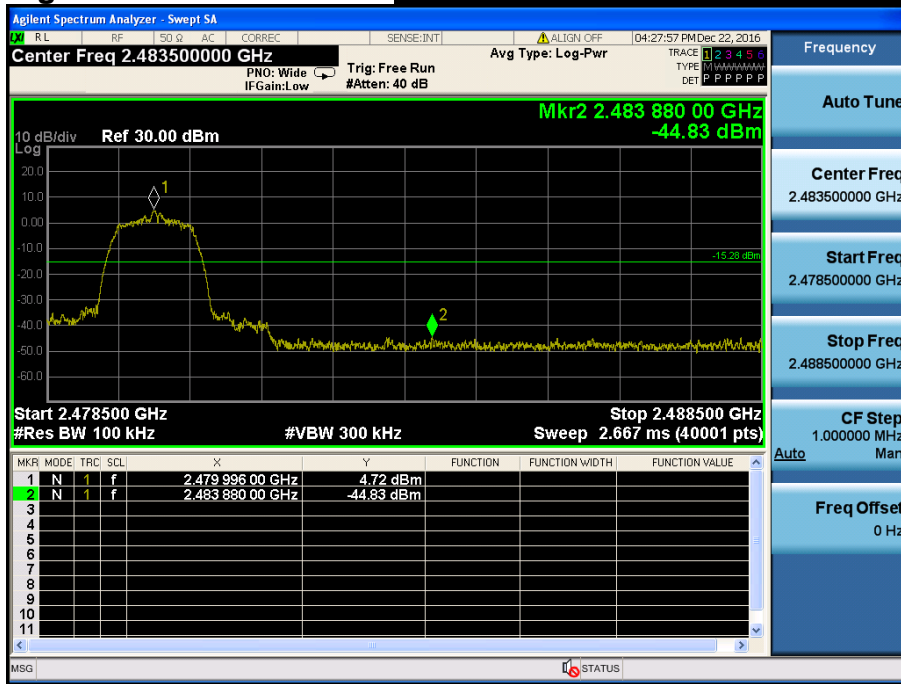

High Band-edge

Hopping mode & Modulation : $\pi/4$ DQPSK



Conducted Spurious Emissions *Highest Channel & Modulation : $\pi/4$ DQPSK*

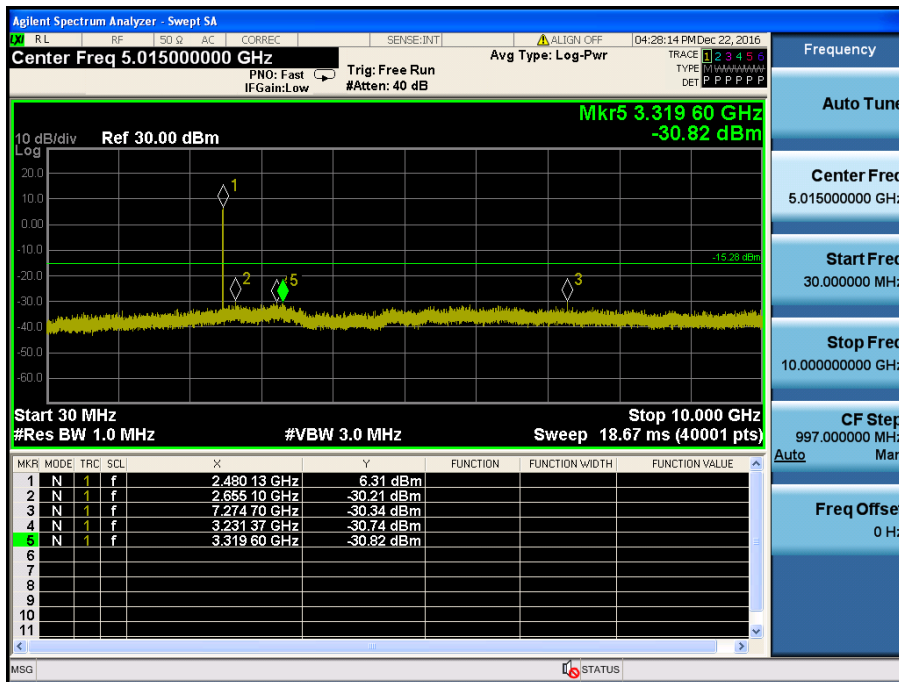
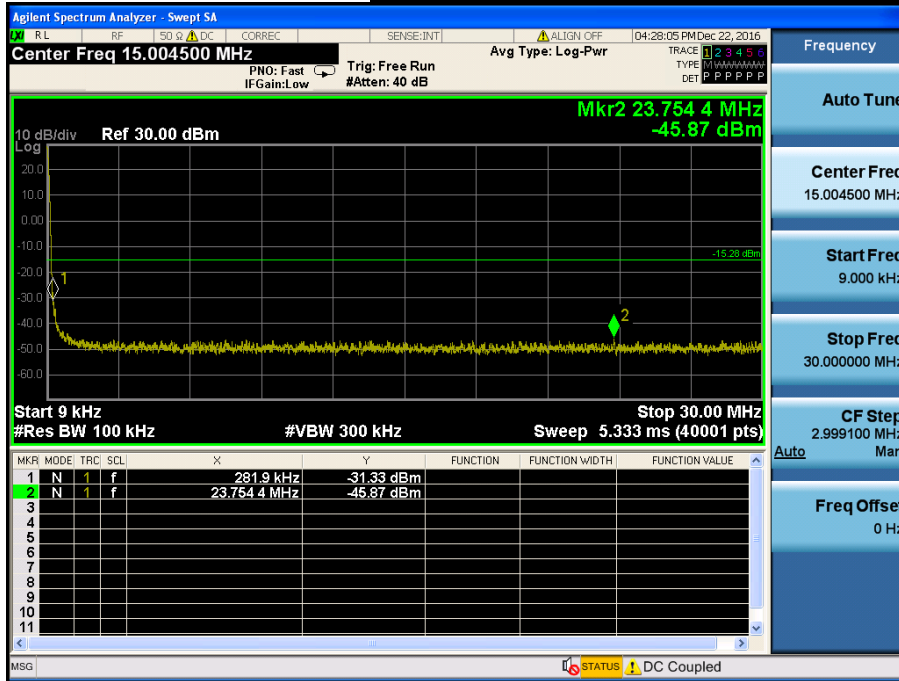

Conducted Spurious Emissions *Highest Channel & Modulation : $\pi/4$ DQPSK*

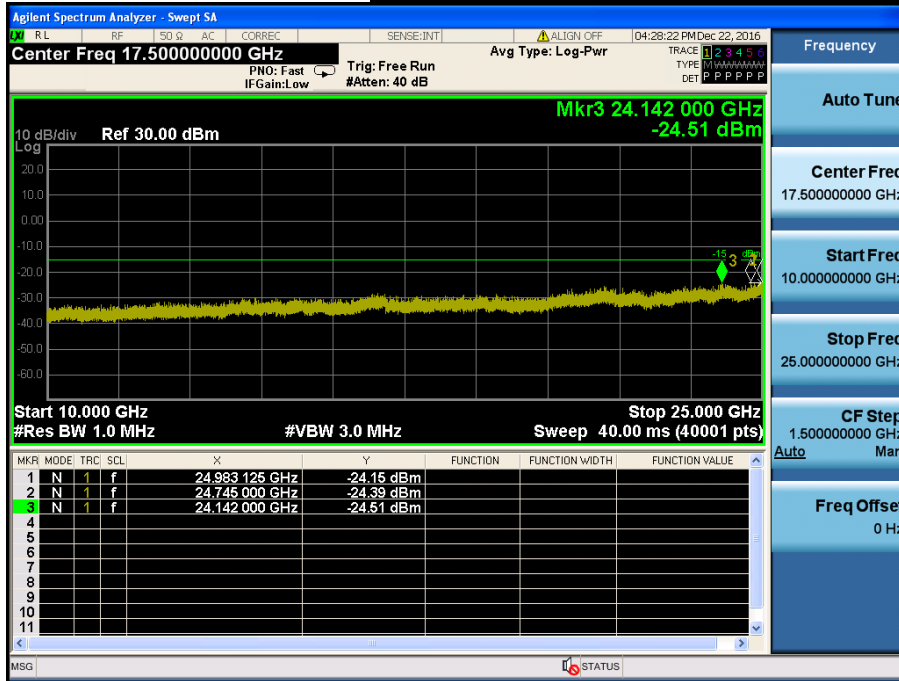

Low Band-edge

Lowest Channel & Modulation : 8DPSK

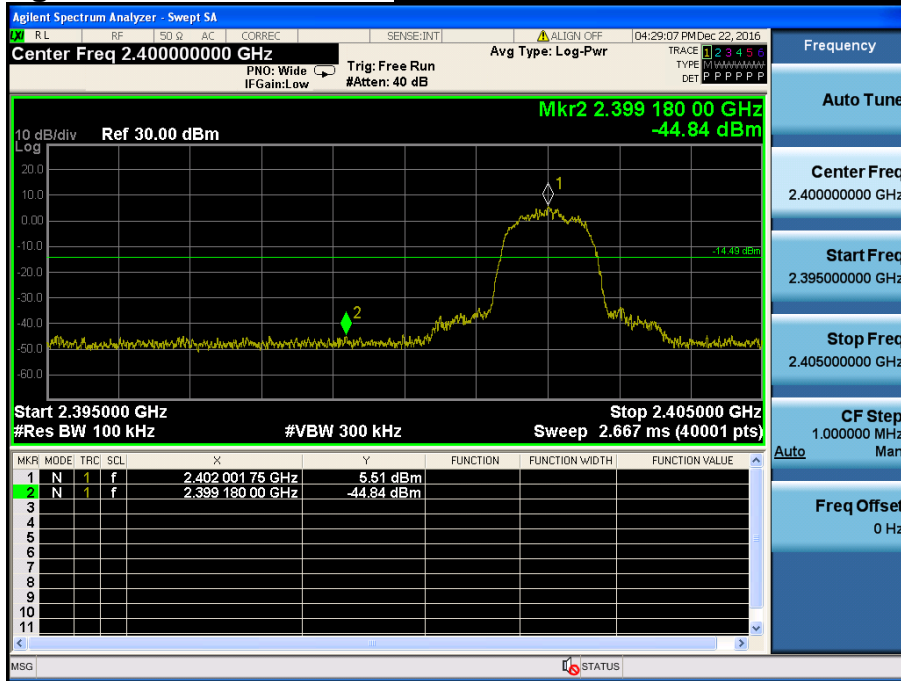

Low Band-edge

Hopping mode & Modulation : 8DPSK

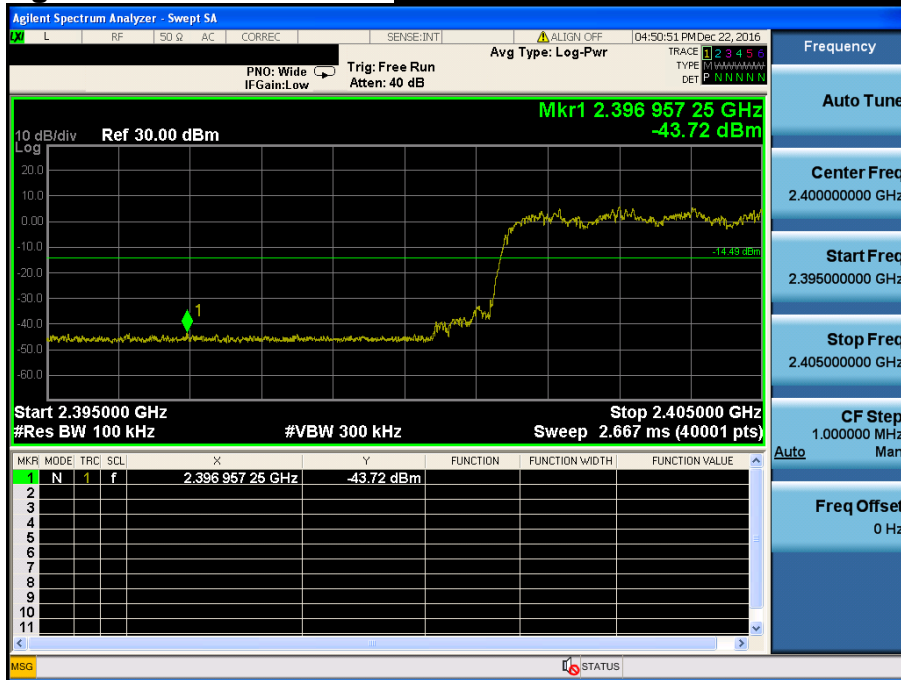

Conducted Spurious Emissions **Lowest Channel & Modulation : 8DPSK**

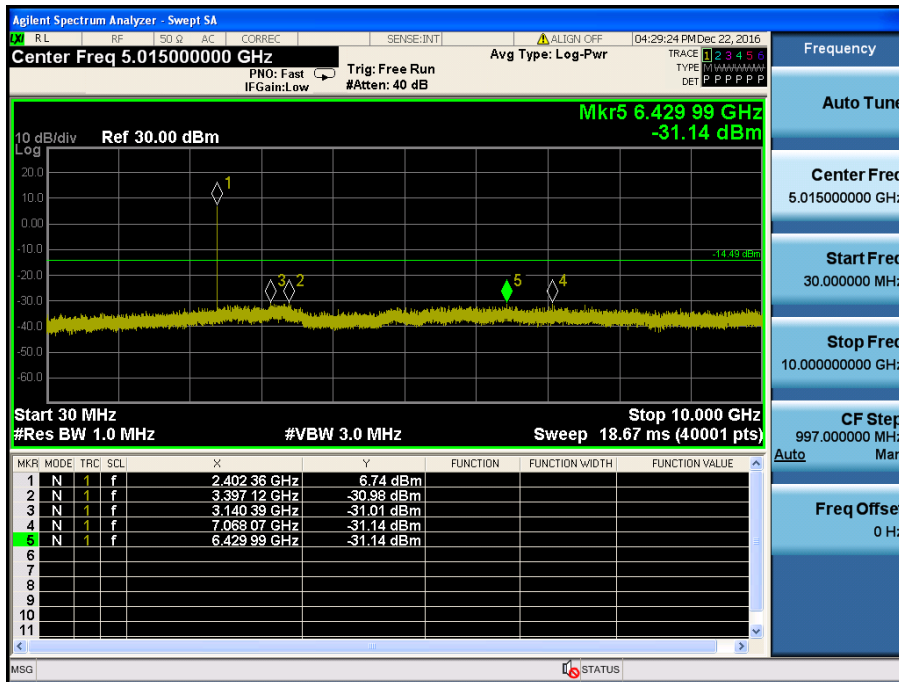
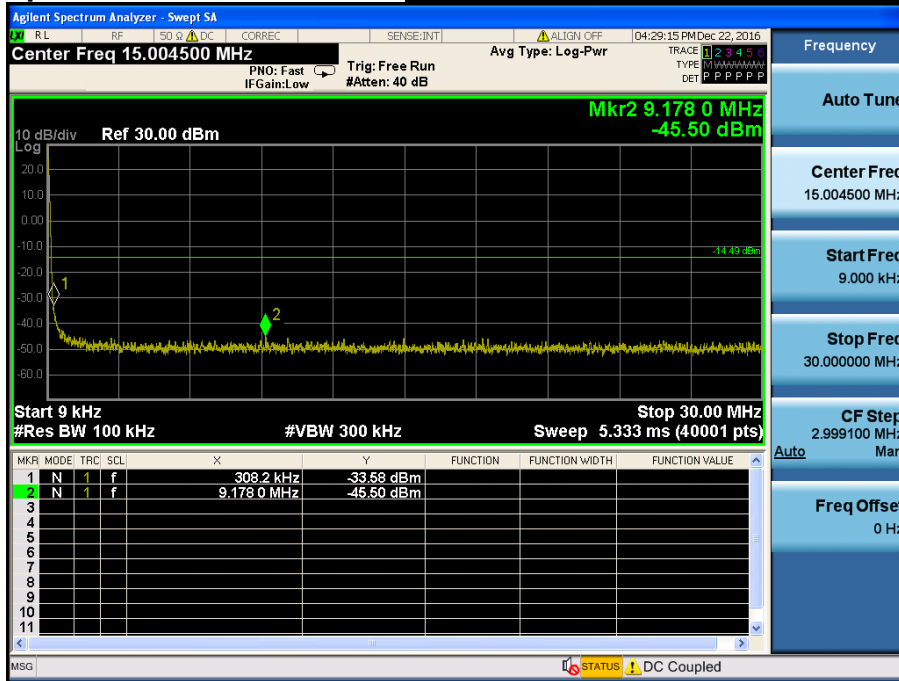

Conducted Spurious Emissions ***Lowest Channel & Modulation : 8DPSK***

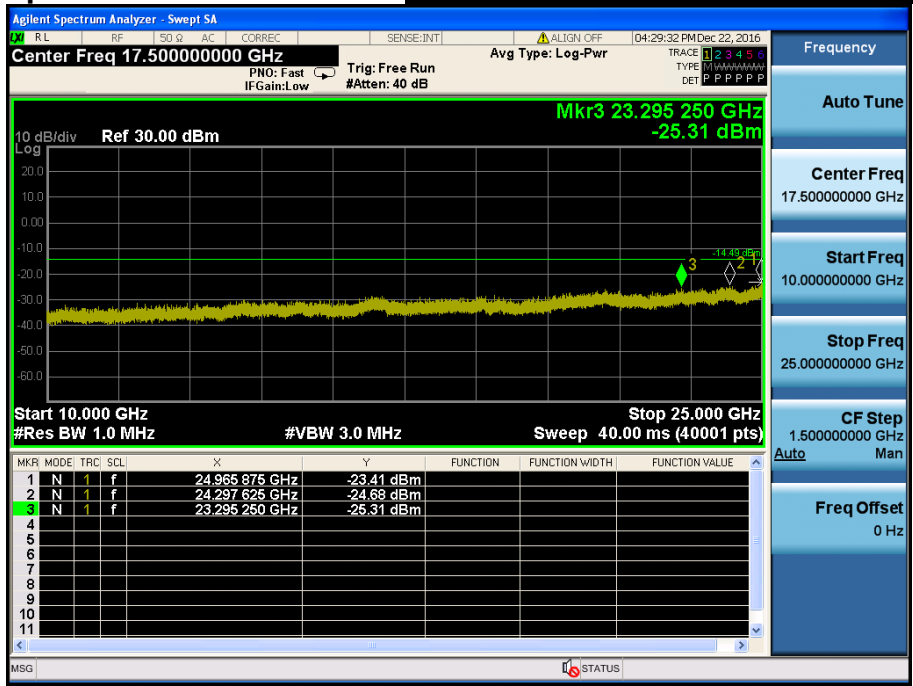

Reference for limit

Middle Channel & Modulation : 8DPSK

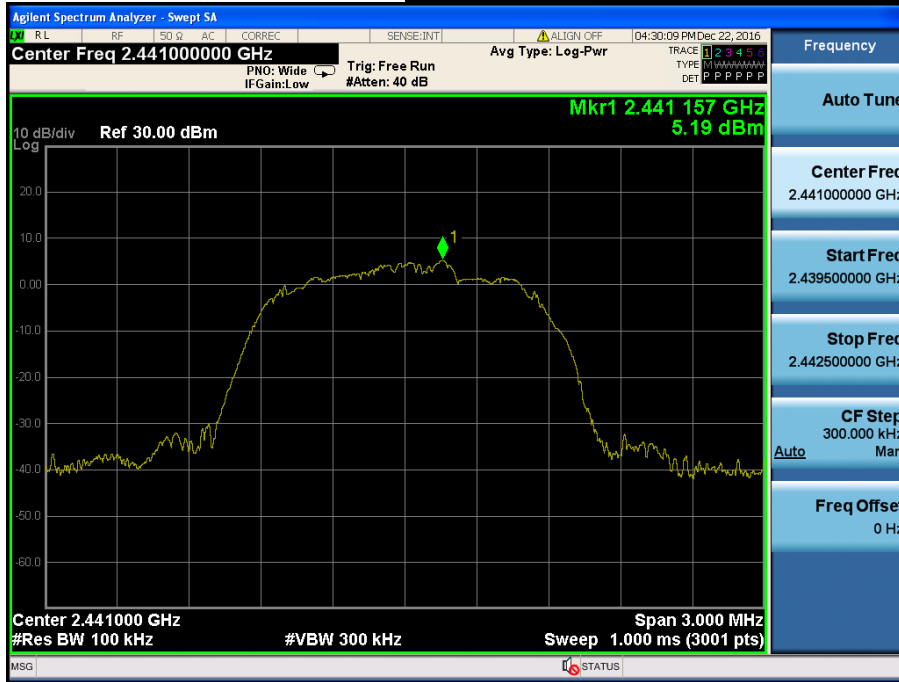

Conducted Spurious Emissions

Middle Channel & Modulation : 8DPSK

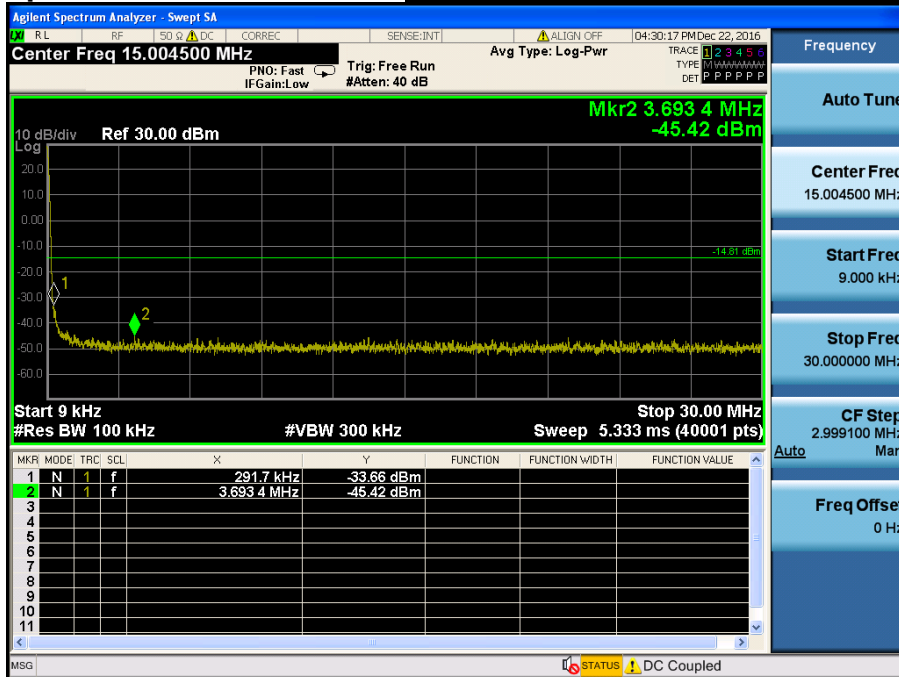

Conducted Spurious Emissions *Middle Channel & Modulation : 8DPSK*

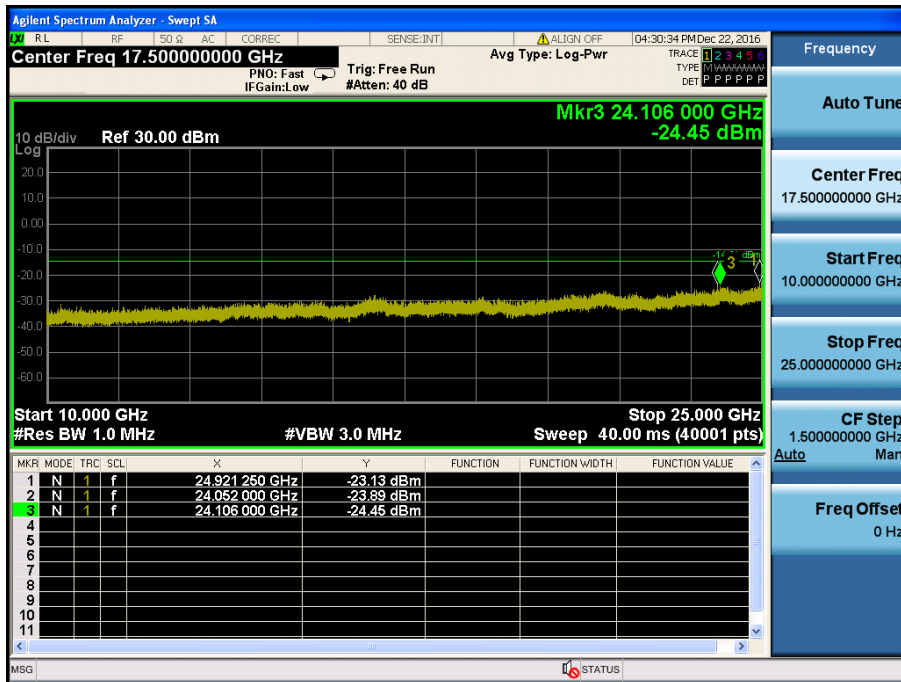
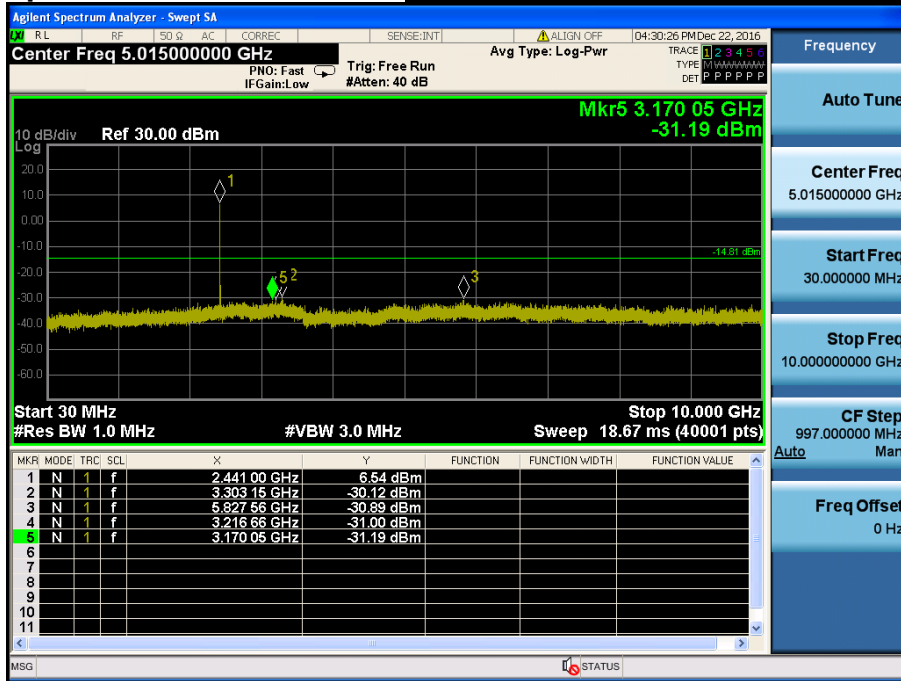

High Band-edge

Highest Channel & Modulation : 8DPSK

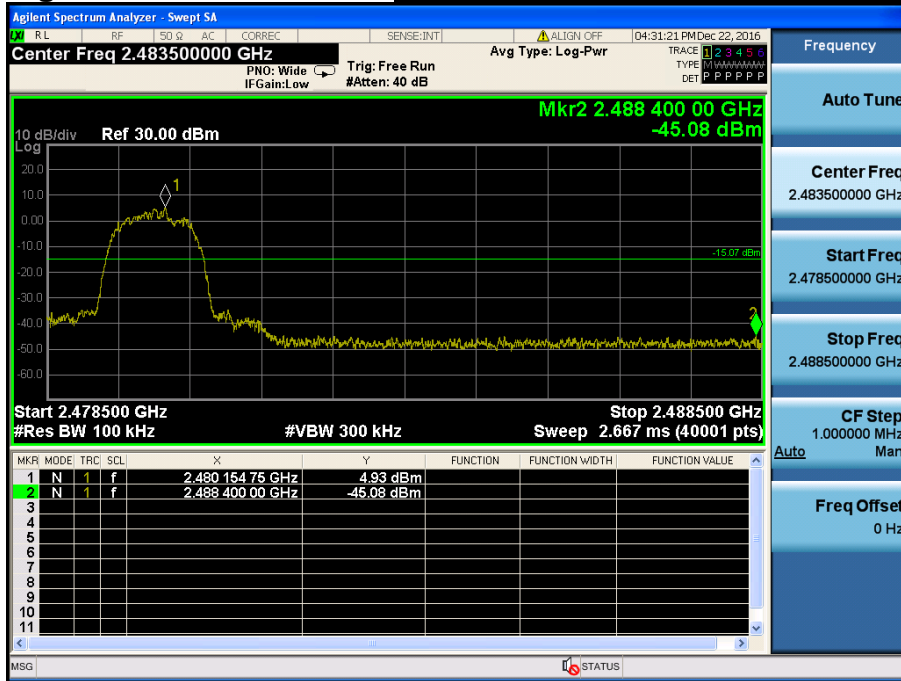

High Band-edge

Hopping mode & Modulation : 8DPSK

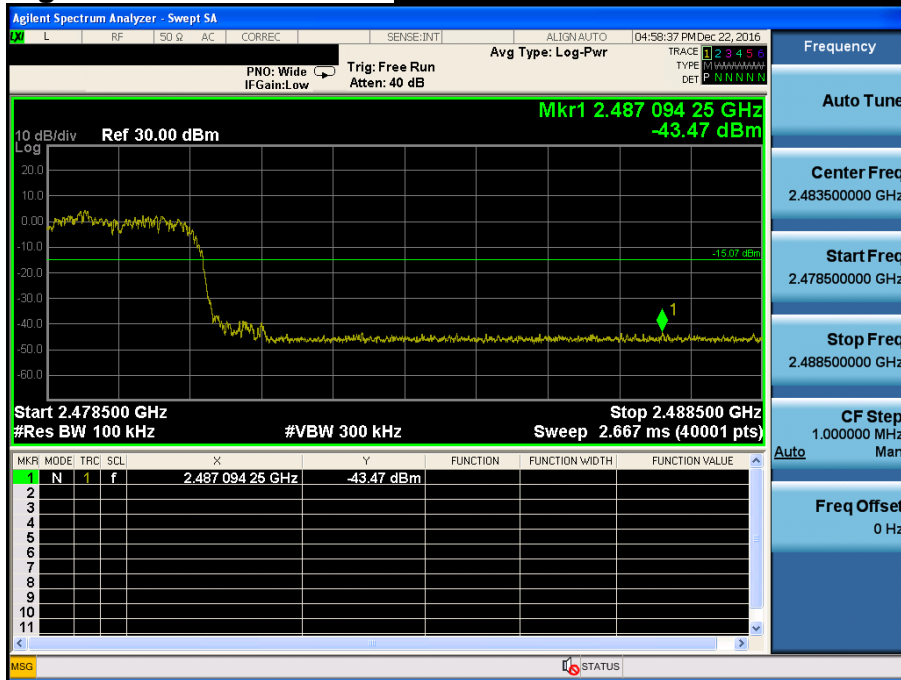

Conducted Spurious Emissions *Highest Channel & Modulation : 8DPSK*

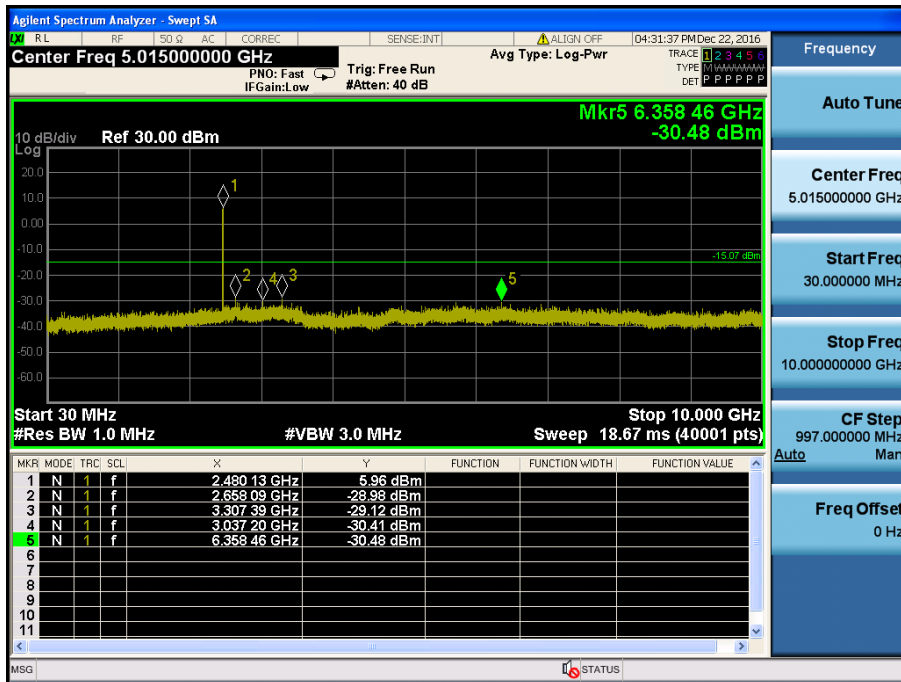
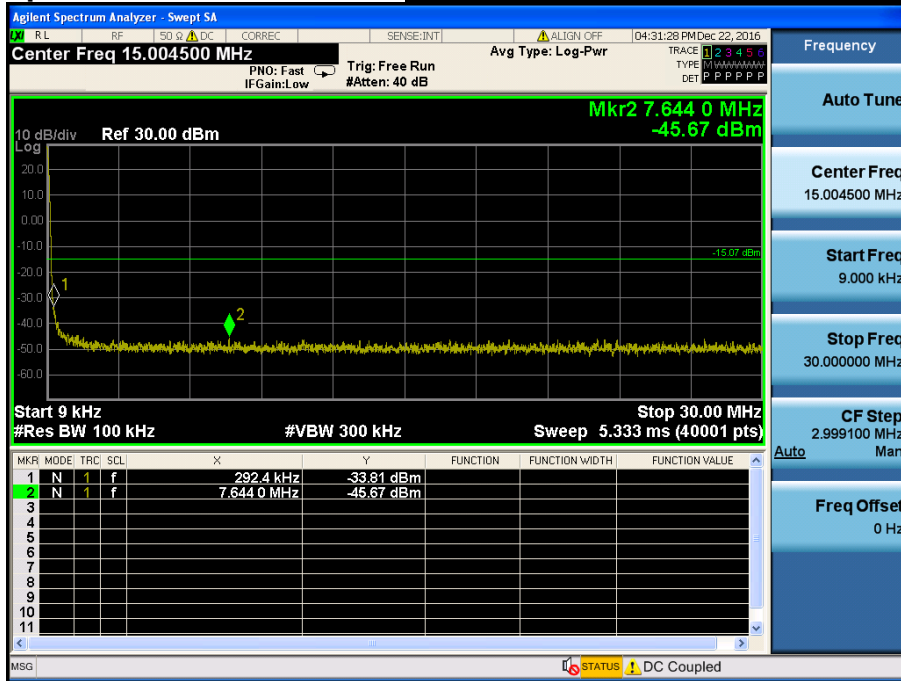

Conducted Spurious Emissions ***Highest Channel & Modulation : 8DPSK***

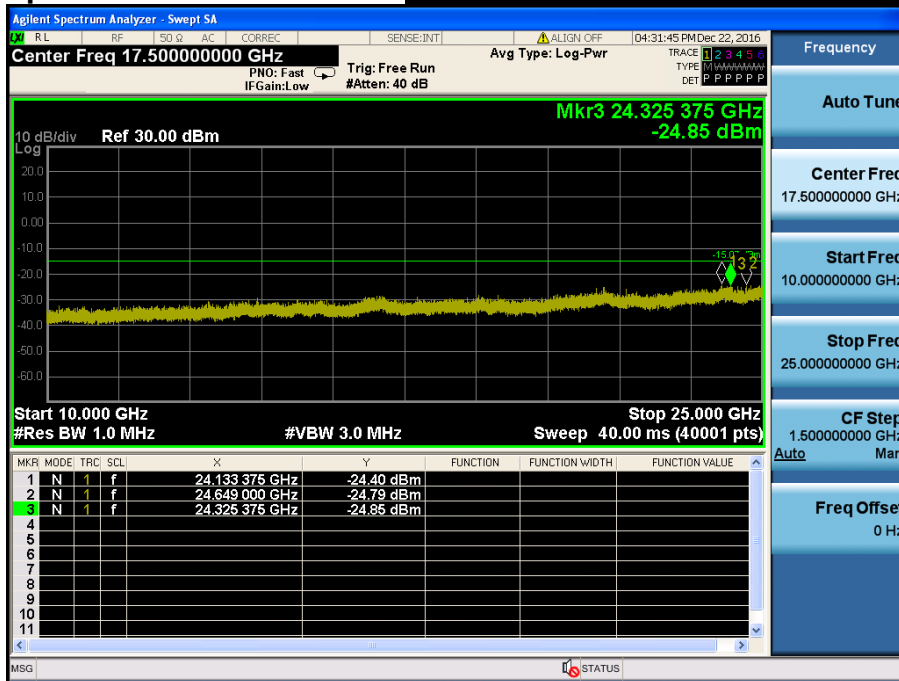

8. Transmitter AC Power Line Conducted Emission

8.1 Test Setup

See test photographs for the actual connections between EUT and support equipment.

8.2 Limit

According to §15.207(a) for an intentional radiator that is designed to be connected to the public utility (AC) power line, the radio frequency voltage that is conducted back onto the AC power line on any frequency or frequencies, within the band 150 kHz to 30 MHz, shall not exceed the limits in the following table, as measured using a 50 uH/50 ohm line impedance stabilization network (LISN).

Compliance with the provision of this paragraph shall on the measurement of the radio frequency voltage between each power line and ground at the power terminal. The lower applies at the boundary between the frequency ranges.

Frequency Range (MHz)	Conducted Limit (dBuV)	
	Quasi-Peak	Average
0.15 ~ 0.5	66 to 56 *	56 to 46 *
0.5 ~ 5	56	46
5 ~ 30	60	50

* Decreases with the logarithm of the frequency

8.3 Test Procedures

Conducted emissions from the EUT were measured according to the ANSI C63.10.

1. The test procedure is performed in a 6.5 m × 3.5 m × 3.5 m (L × W × H) shielded room. The EUT along with its peripherals were placed on a 1.0 m (W) × 1.5 m (L) and 0.8 m in height wooden table and the EUT was adjusted to maintain a 0.4 meter space from a vertical reference plane.
2. The EUT was connected to power mains through a line impedance stabilization network (LISN) which provides 50 ohm coupling impedance for measuring instrument and the chassis ground was bounded to the horizontal ground plane of shielded room.
3. All peripherals were connected to the second LISN and the chassis ground also bounded to the horizontal ground plane of shielded room.
4. The excess power cable between the EUT and the LISN was bundled. The power cables of peripherals were unbundled. All connecting cables of EUT and peripherals were moved to find the maximum emission.

8.4. Test Results

AC Line Conducted Emissions (Graph) = Modulation : GFSK

Results of Conducted Emission

DT&C		Date : 2016-12-22	
Order No.	: DTNC1612-07601	Reference No.	:
Model No.	: DA25	Power Supply	: 120 V 60 Hz
Serial No.	:	Temp/Humi.	: 24 °C 44 % R.H.
Test Condition	: Bluetooth BDR	Operator	: Jaejin Lee
Memo	: 2441 MHz		
LIMIT	: FCC P15.207 QP		
	: FCC P15.207 AV		

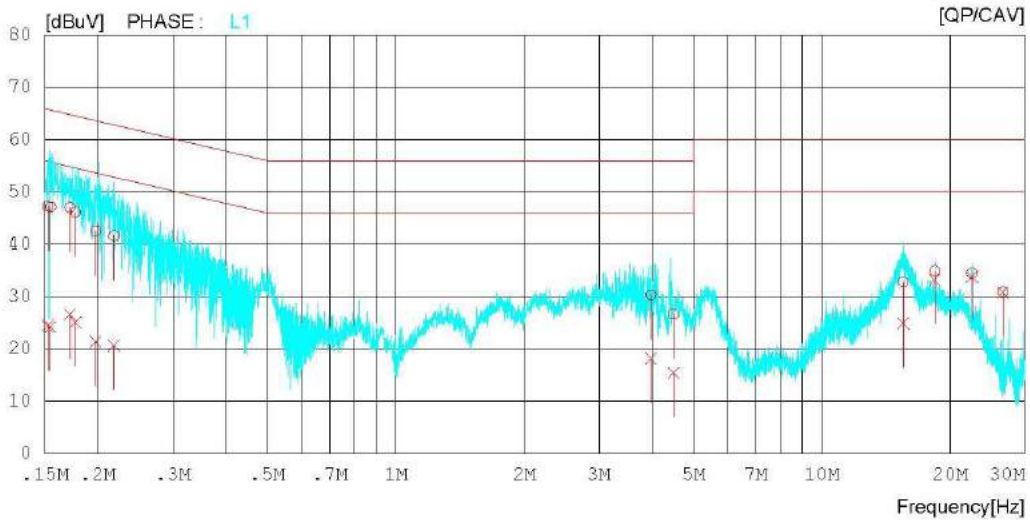
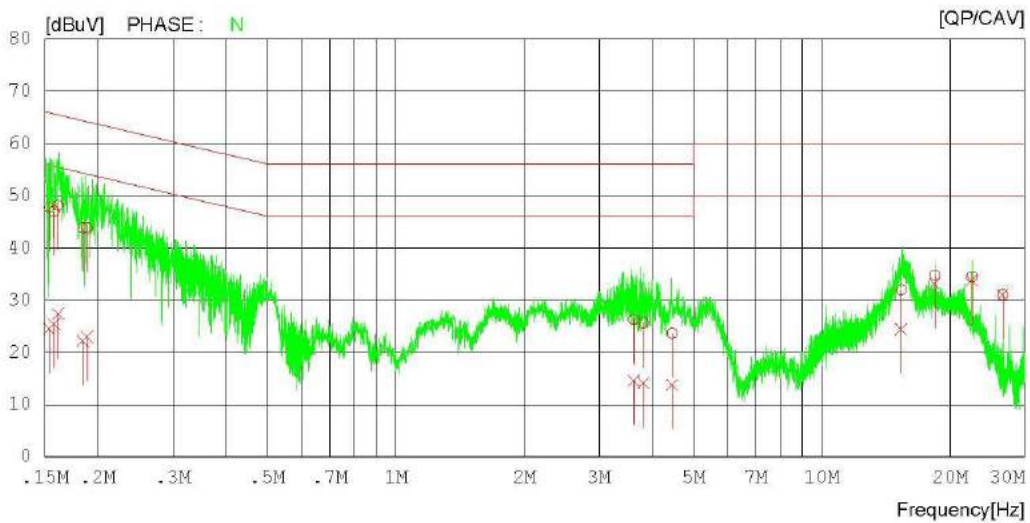

AC Line Conducted Emissions (List) = Modulation : GFSK

Results of Conducted Emission

DT&C Date : 2016-12-22

Order No. : DTNC1612-07601 Reference No. :
 Model No. : DA25 Power Supply : 120 V 60 Hz
 Serial No. : Temp/Humi. : 24°C 44 % R.H.
 Test Condition : Bluetooth BDR Operator : Jaejin Lee

Memo : 2441 MHz

LIMIT : FCC P15.207 QP
 FCC P15.207 AV

NO	FRFQ [MHz]	READING		C.FACTOR [dB]	RESULT		LIMIT		MARGIN		PHASE
		QP [dBuV]	CAV [dBuV]		QP [dBuV]	CAV [dBuV]	QP [dBuV]	CAV [dBuV]			
1	0.15339	36.01	12.79	11.70	47.71	24.49	65.81	55.81	18.10	31.32	N
2	0.15750	35.33	13.77	11.65	46.98	25.42	65.59	55.59	18.61	30.17	N
3	0.16094	36.47	15.70	11.60	48.07	27.30	65.42	55.42	17.35	28.12	N
4	0.18421	32.44	10.80	11.35	43.79	22.15	64.29	54.29	20.50	32.14	N
5	0.18850	32.49	11.70	11.31	43.80	23.01	64.10	54.10	20.30	31.09	N
6	3.62562	16.01	4.30	10.26	26.27	14.56	56.00	46.00	29.73	31.44	N
7	3.81802	15.37	3.87	10.25	25.62	14.12	56.00	46.00	30.38	31.88	N
8	4.45629	13.36	3.51	10.29	23.65	13.80	56.00	46.00	32.35	32.20	N
9	15.35601	21.47	13.92	10.48	31.95	24.40	60.00	50.00	28.05	25.60	N
10	18.43176	24.30	22.61	10.49	34.79	33.10	60.00	50.00	25.21	16.90	N
11	22.52853	23.91	23.25	10.54	34.45	33.79	60.00	50.00	25.55	16.21	N
12	26.62426	20.37	20.35	10.59	30.96	30.94	60.00	50.00	29.04	19.06	N
13	0.15218	35.56	12.69	11.75	47.30	24.44	65.88	55.88	18.58	31.44	L1
14	0.15473	35.49	12.50	11.72	47.21	24.22	65.74	55.74	18.53	31.52	L1
15	0.17171	35.56	15.06	11.52	47.08	26.58	64.88	54.88	17.80	28.30	L1
16	0.17695	34.74	13.61	11.46	46.20	25.07	64.63	54.63	18.43	29.56	L1
17	0.19750	31.39	10.20	11.21	42.60	21.41	63.71	53.71	21.11	32.30	L1
18	0.21769	30.56	9.57	11.11	41.67	20.68	62.91	52.91	21.24	32.23	L1
19	3.97375	20.06	7.88	10.29	30.35	18.17	56.00	46.00	25.65	27.83	L1
20	4.48767	16.37	5.11	10.33	26.70	15.44	56.00	46.00	29.30	30.56	L1
21	15.54931	22.47	14.58	10.35	32.82	24.93	60.00	50.00	27.18	25.07	L1
22	18.43226	24.54	22.85	10.42	34.96	33.27	60.00	50.00	25.04	16.73	L1
23	22.52824	24.01	23.37	10.49	34.50	33.86	60.00	50.00	25.50	16.14	L1
24	26.62426	20.31	20.29	10.53	30.94	30.82	60.00	50.00	29.16	19.18	L1

9. Antenna Requirement

Describe how the EUT complies with the requirement that either its antenna is permanently attached, or that it employs a unique antenna connector, for every antenna proposed for use with the EUT.

Conclusion: Comply

The antenna is attached on the main PCB using the special spring tension. (Refer to Internal Photo file.)

- Minimum Standard :

An intentional radiator shall be designed to ensure that no antenna other than that furnished by the responsible party shall be used with the device. The use of a permanently attached antenna or of an antenna that uses a unique coupling to the intentional radiator shall be considered sufficient to comply with the provisions.
--

10. Occupied Bandwidth (99 %)

10.1 Test Setup

Refer to the APPENDIX I.

10.2 Limit

Limit : Not Applicable

10.3 Test Procedure

The 99 % power bandwidth was measured with a calibrated spectrum analyzer.

The resolution bandwidth (RBW) shall be in the range of 1 % to 5 % of the occupied bandwidth (OBW) and video bandwidth (VBW) shall be approximately $3 \times$ RBW.

Spectrum analyzer plots are included on the following pages.

10.4 Test Results

Not Applicable

APPENDIX I

Test set up diagrams

▪ Radiated Measurement

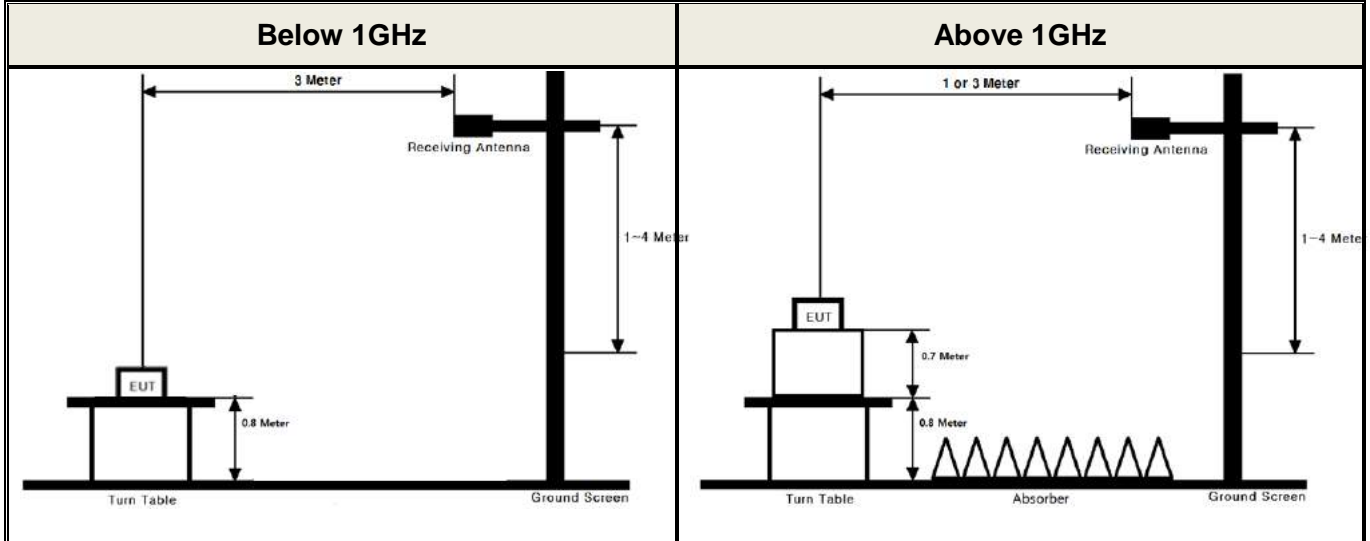

▪ Conducted Measurement

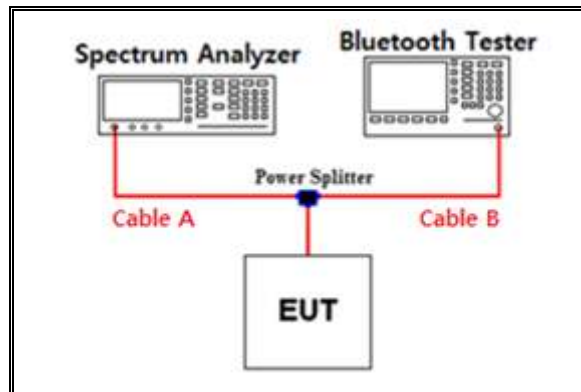

Path loss information

Frequency (GHz)	Path Loss (dB)	Frequency (GHz)	Path Loss (dB)
0.03	7.06	15	8.52
1	7.31	20	8.79
2.402 & 2.441 & 2.480	7.64	25	9.85
5	7.88	-	-
10	8.37	-	-

Note 1 : The path loss from EUT to Spectrum analyzer were measured and used for test.
 Path loss (= S/A's Correction factor) = Cable A + Power splitter

APPENDIX II

Unwanted Emissions (Radiated) Test Plot

GFSK & Lowest Channel & X & Hor

Detector Mode : PK

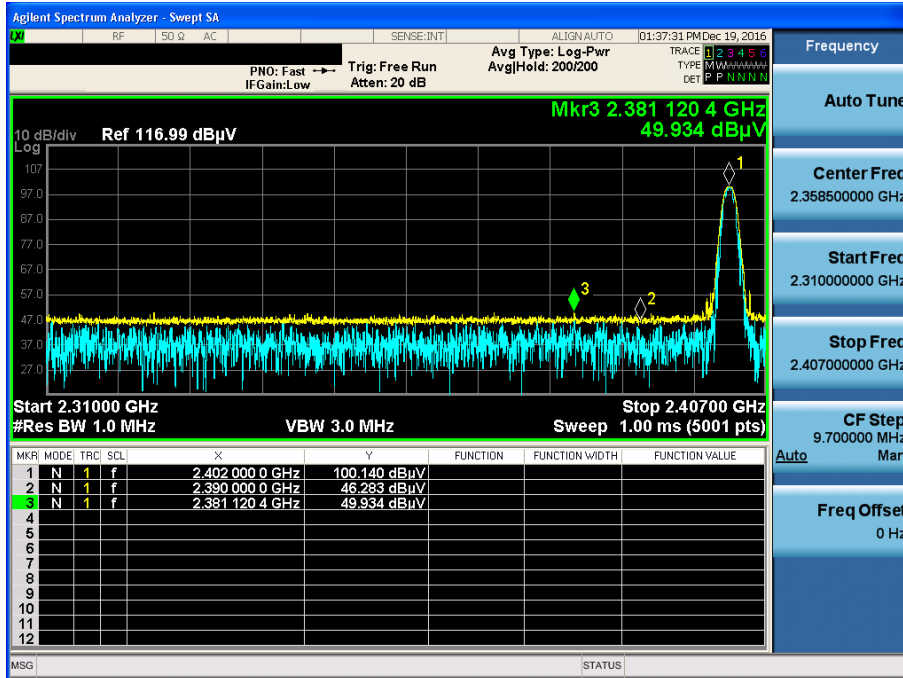

GFSK & Lowest Channel & X & Hor

Detector Mode : AV

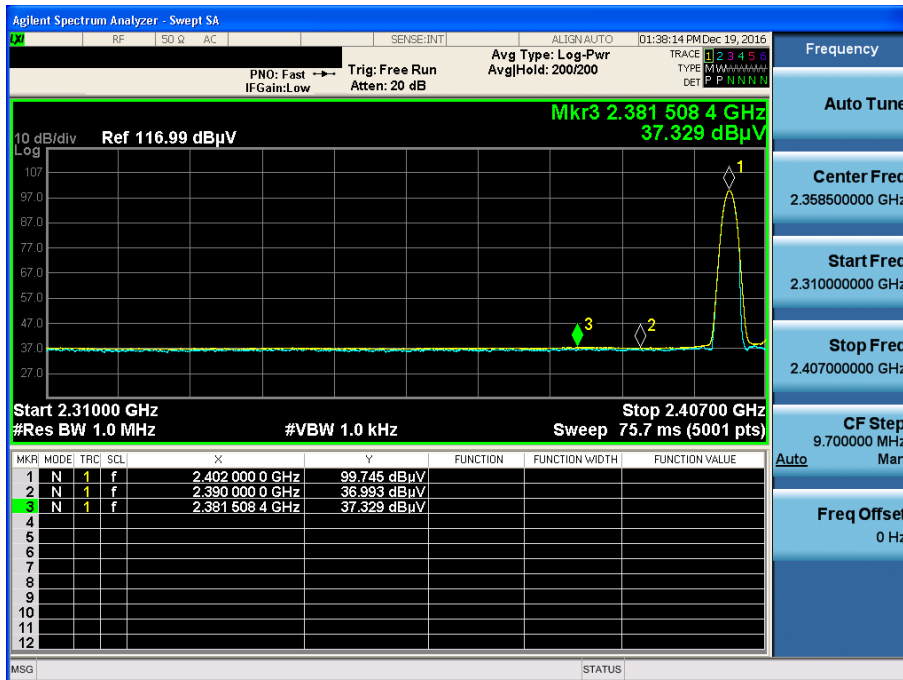

GFSK & Highest Channel & Z & Ver

Detector Mode : PK

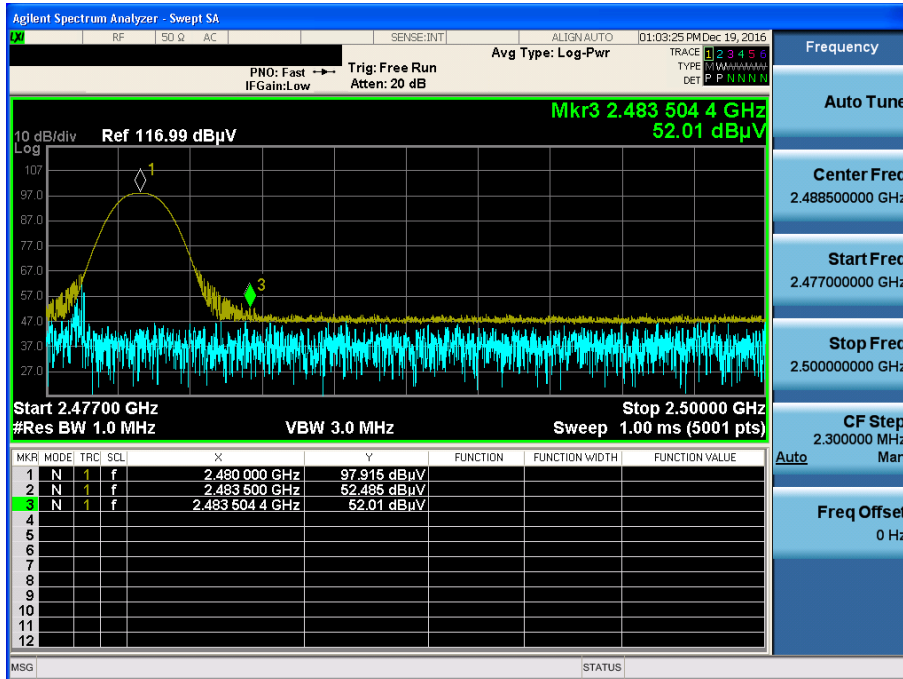

GFSK & Highest Channel & Z & Ver

Detector Mode : AV

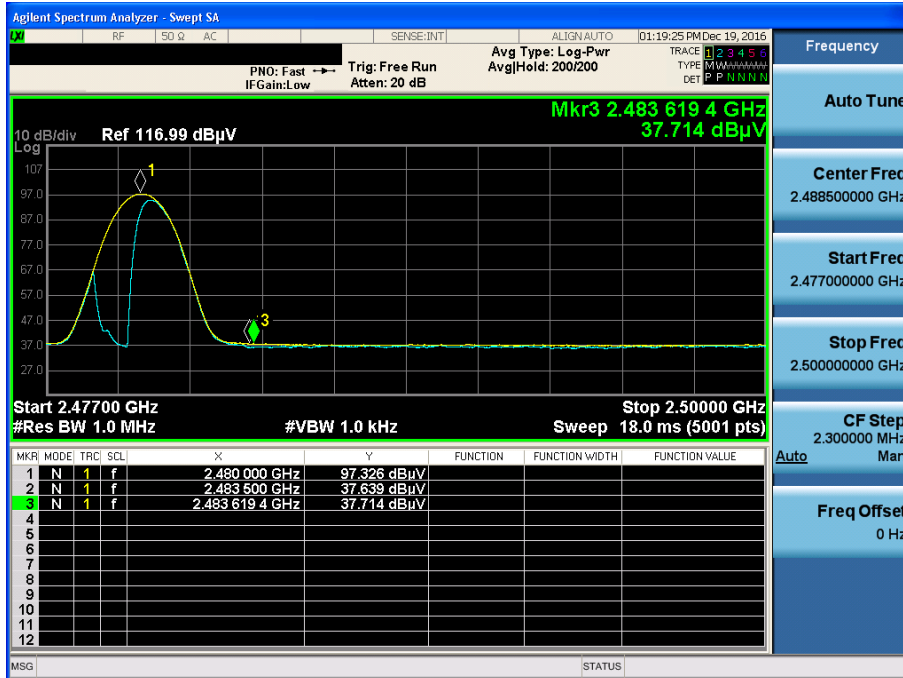

π /4DQPSK & Lowest Channel & X & Hor

Detector Mode : PK

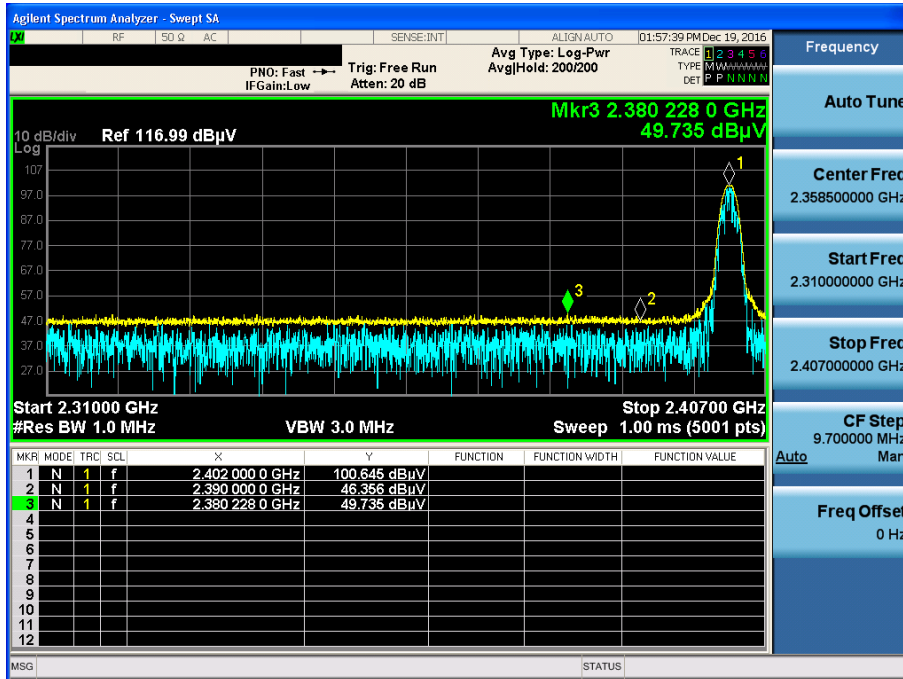

π /4DQPSK & Lowest Channel & X & Hor

Detector Mode : AV

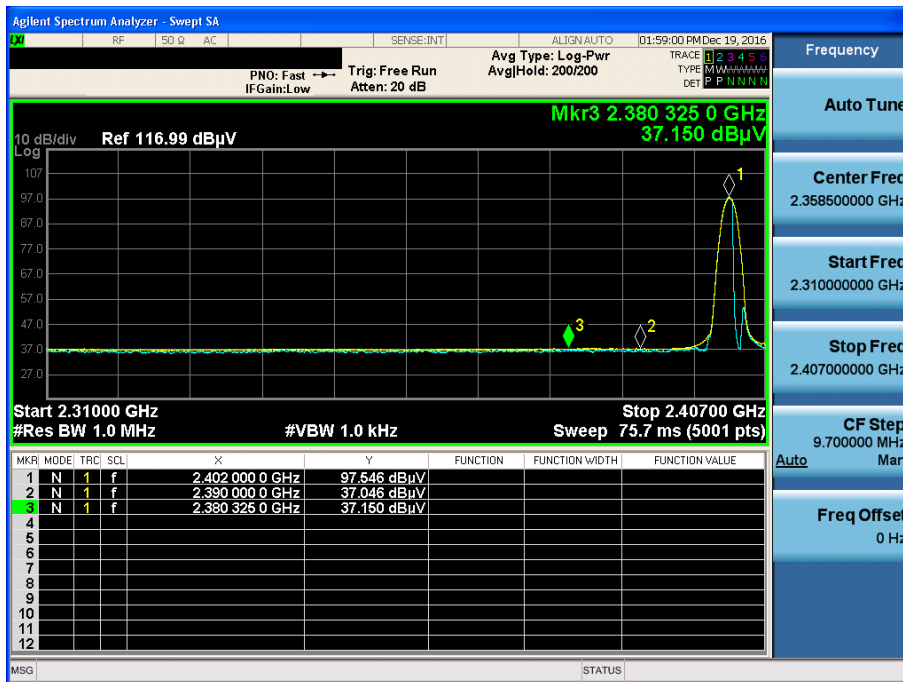

$\pi/4$ DQPSK & Highest Channel & X & Hor

Detector Mode : PK

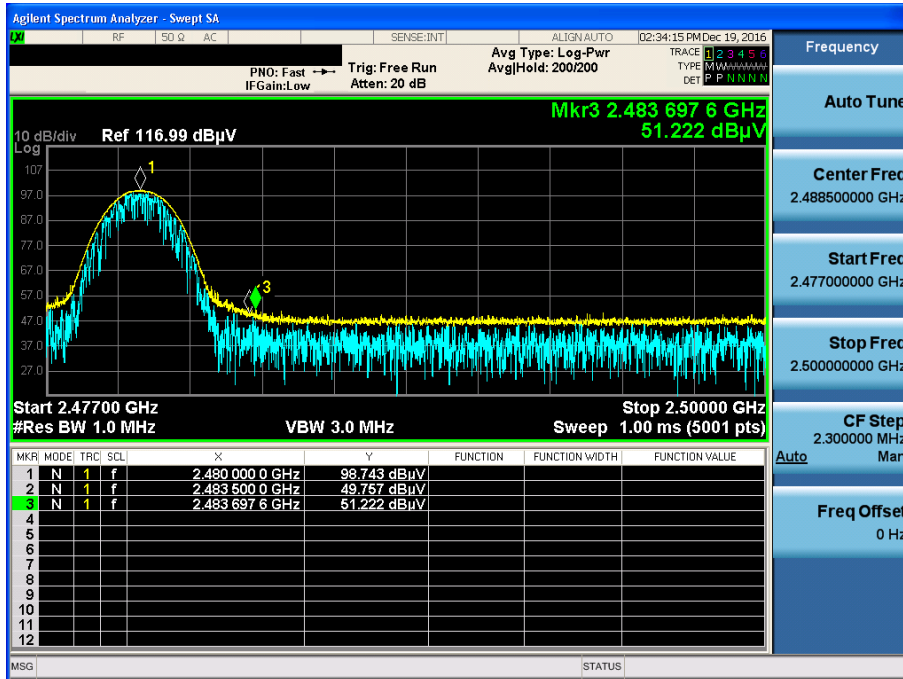

$\pi/4$ DQPSK & Highest Channel & X & Hor

Detector Mode : AV

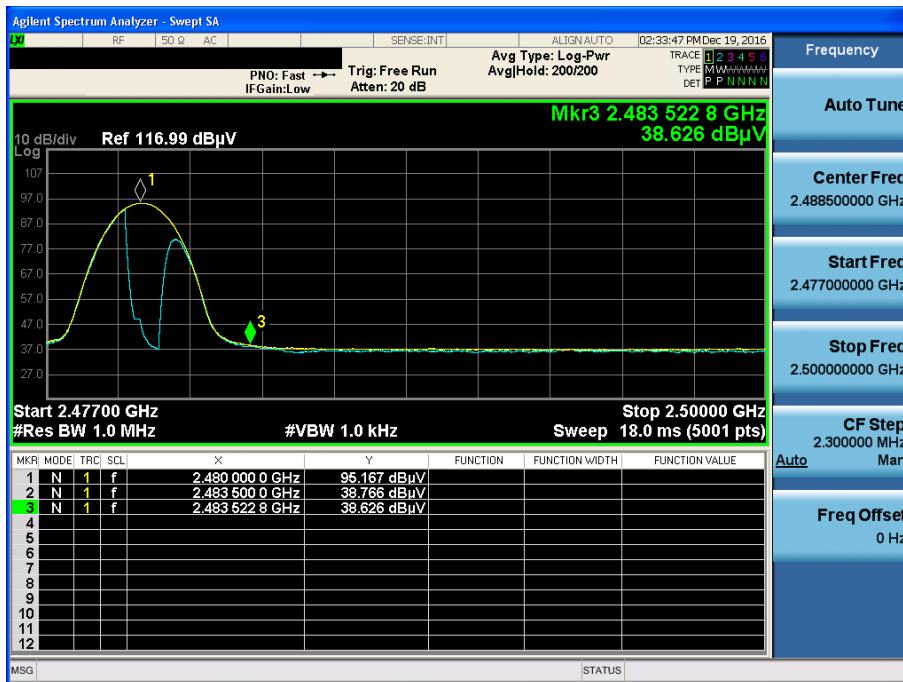

8DPSK & Lowest Channel & X & Hor

Detector Mode : PK

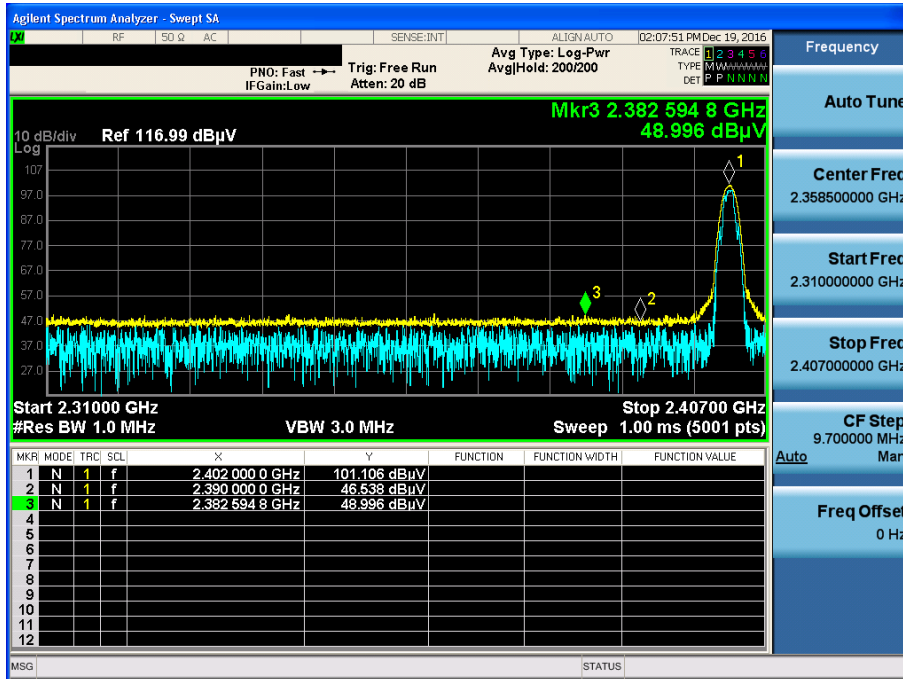

8DPSK & Lowest Channel & X & Hor

Detector Mode : AV

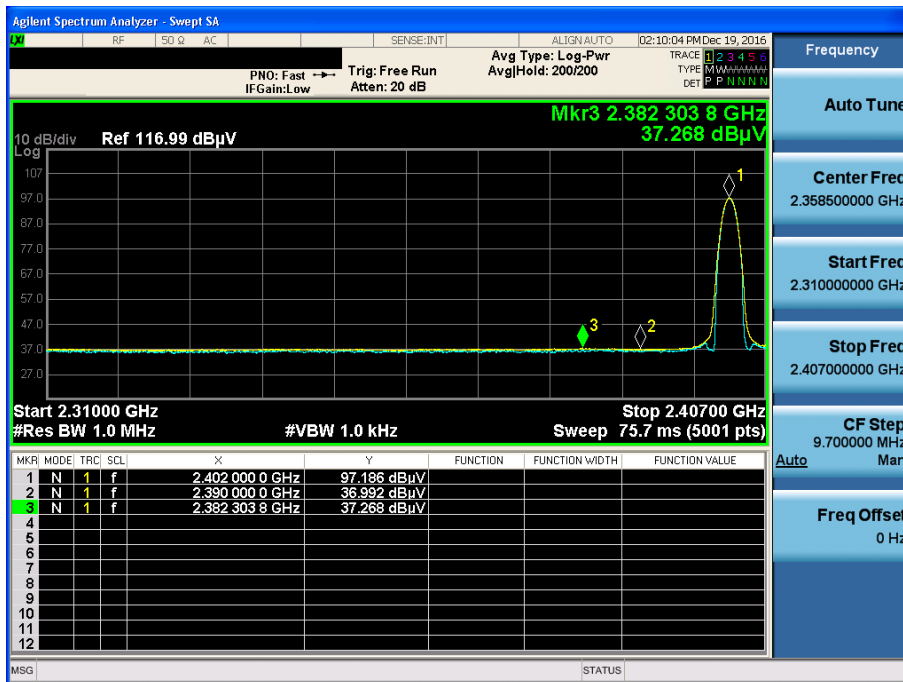

8DPSK & Highest Channel & Z & Ver

Detector Mode : PK

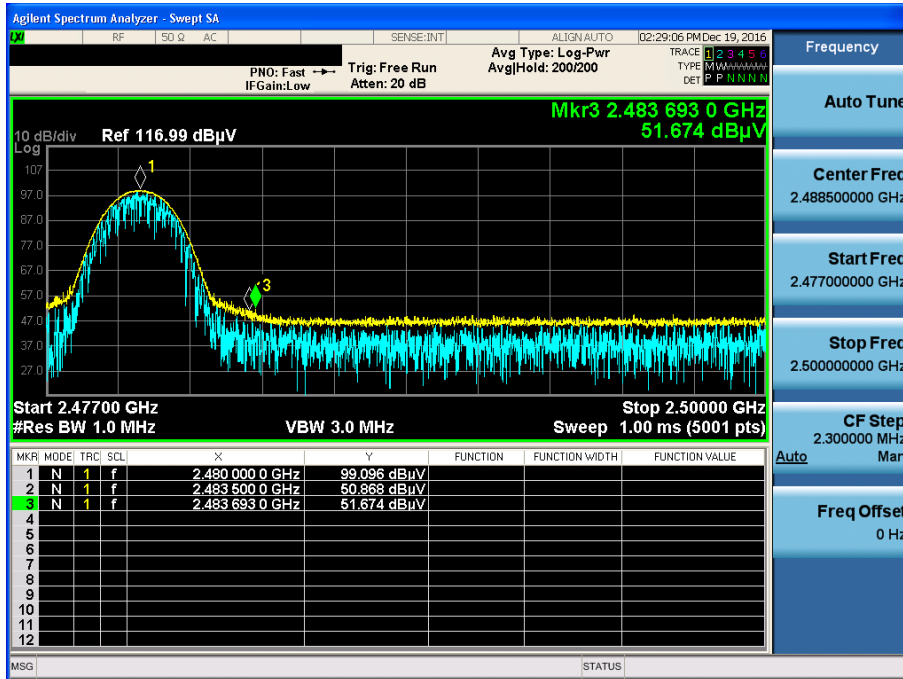

8DPSK & Highest Channel & Z & Ver

Detector Mode : AV



GFSK & Middle Channel & X & Hor

Detector Mode : PK

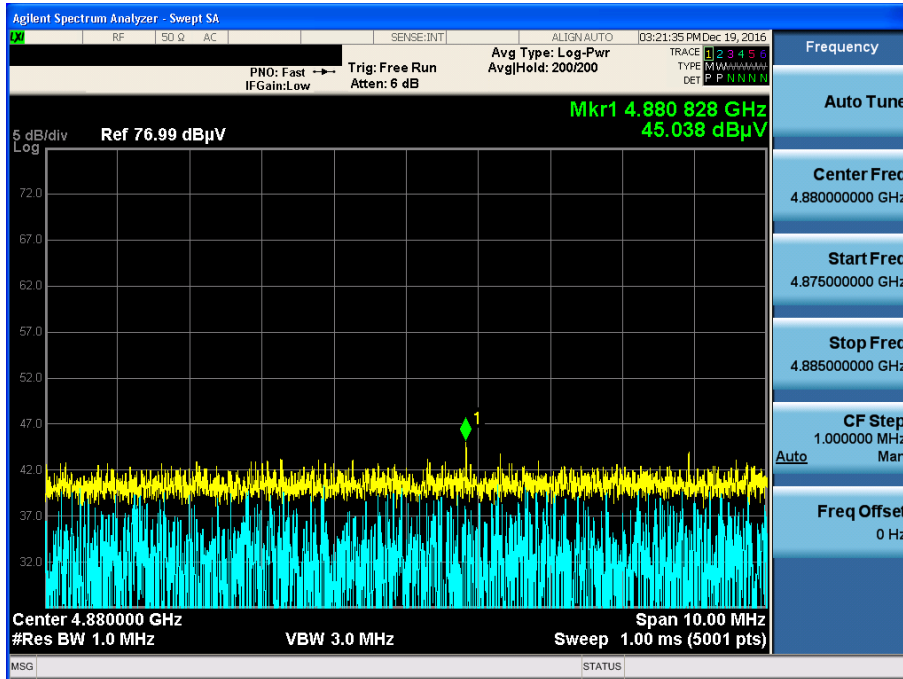

$\pi/4$ DQPSK & Highest Channel & Z & Ver

Detector Mode : PK

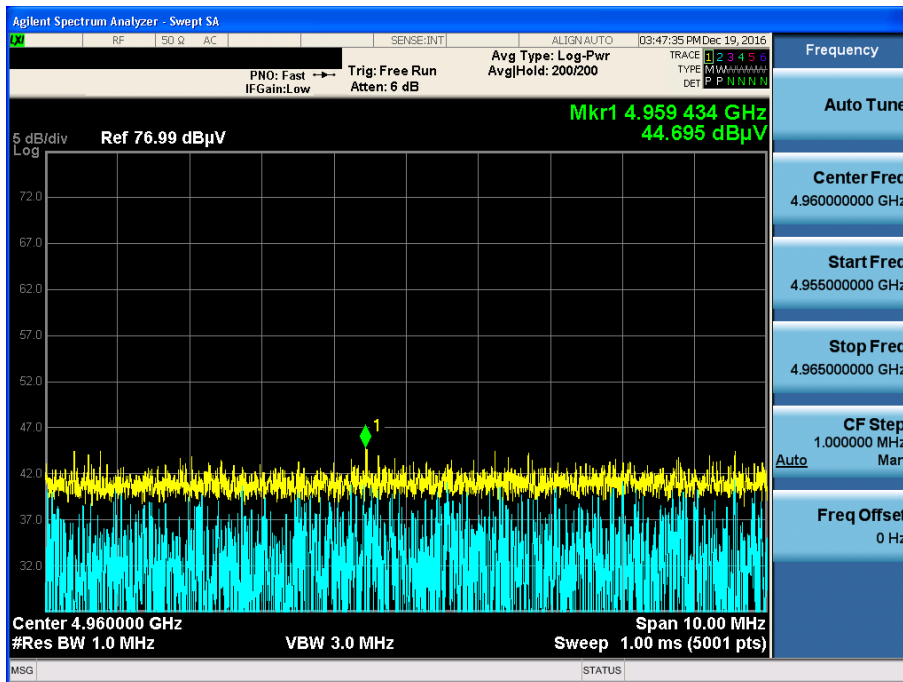

8DPSK & Highest Channel X & Hor

Detector Mode : PK

