

Antenna Gain

ANT0	LTE Band 1	+0.6dBi
ANT0	LTE Band 2	+0.1dBi
ANT0	LTE Band 3	+0.1dBi
ANT0	LTE Band 4	+0.1dBi
ANT0	LTE Band 5	-2.6dBi
ANT0	LTE Band 8	-2.6dBi
ANT0	LTE Band 12	-3.0dBi
ANT0	LTE Band 28	-3.0dBi
ANT0	LTE Band 38	+0.2dBi
ANT0	LTE Band 39	-0.1dBi
ANT0	LTE Band 41	+1.5dBi

ANT0	UMTS Band 1	+0.6dBi
ANT0	UMTS Band 2	+0.1dBi
ANT0	UMTS Band 4	+0.1dBi
ANT0	UMTS Band 5	-2.6dBi
ANT0	UMTS Band 8	-2.6dBi

ANT0	GSM850	-2.6dBi
ANT0	GSM900	-2.6dBi
ANT0	GSM1800	+0.1dBi
ANT0	GSM1900	+0.1dBi

ANT4	Bluetooth/WLAN	+0.2dBi
ANT4	WLAN W52_W53	+4.8dBi
ANT4	WLAN W56	+5.4dBi

LTE Band 1

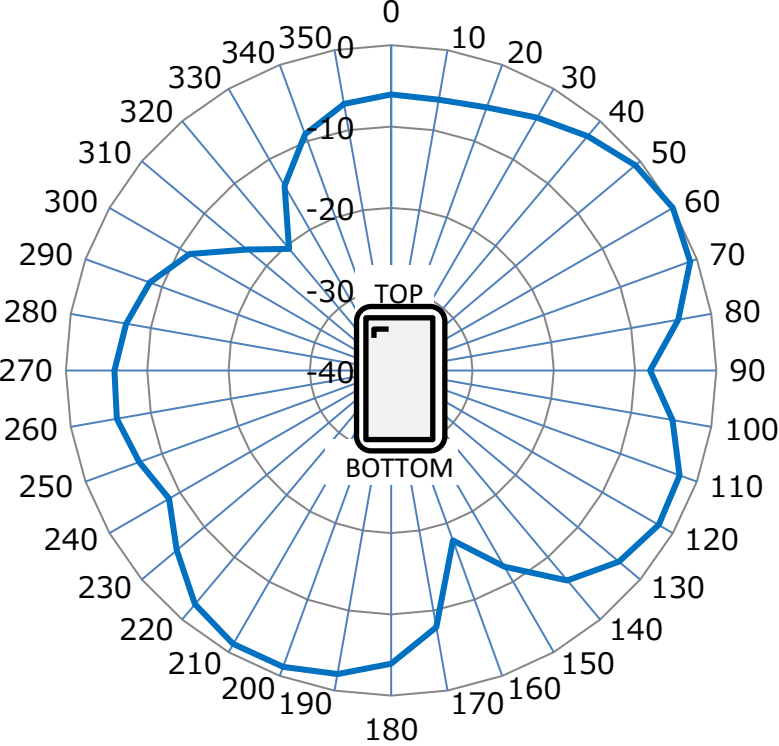

Front panel direction : upside

Peak Gain : 0.6 [dBi]

LTE Band 2

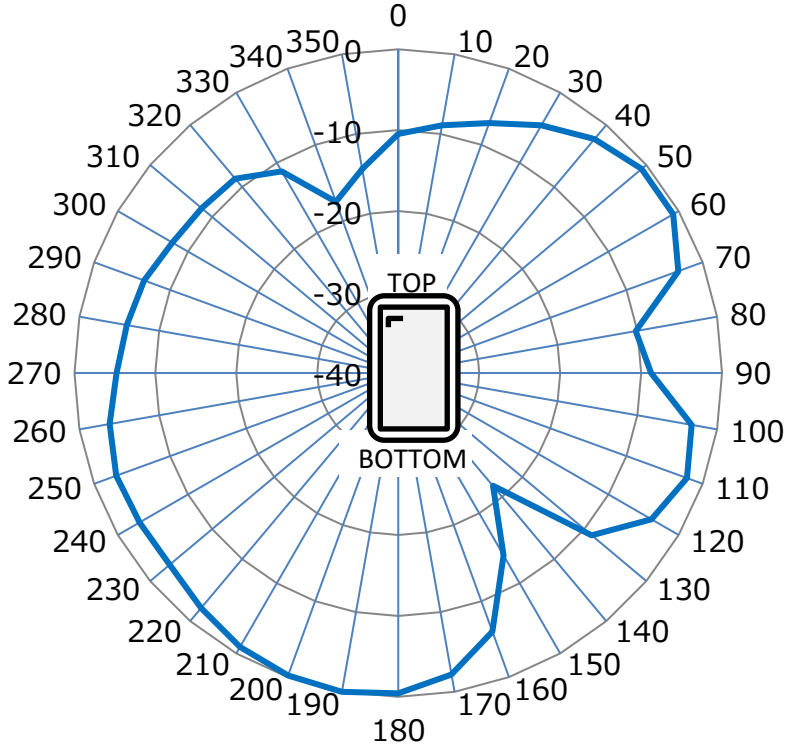

Front panel direction : upside

Peak Gain : 0.1 [dBi]

LTE Band 3

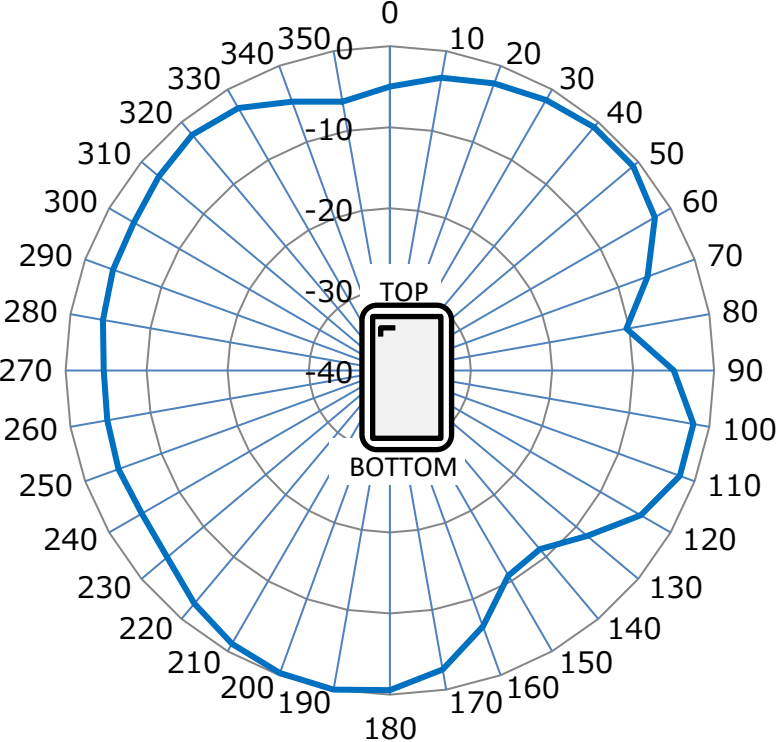

Front panel direction : upside

Peak Gain : 0.1 [dBi]

LTE Band 4

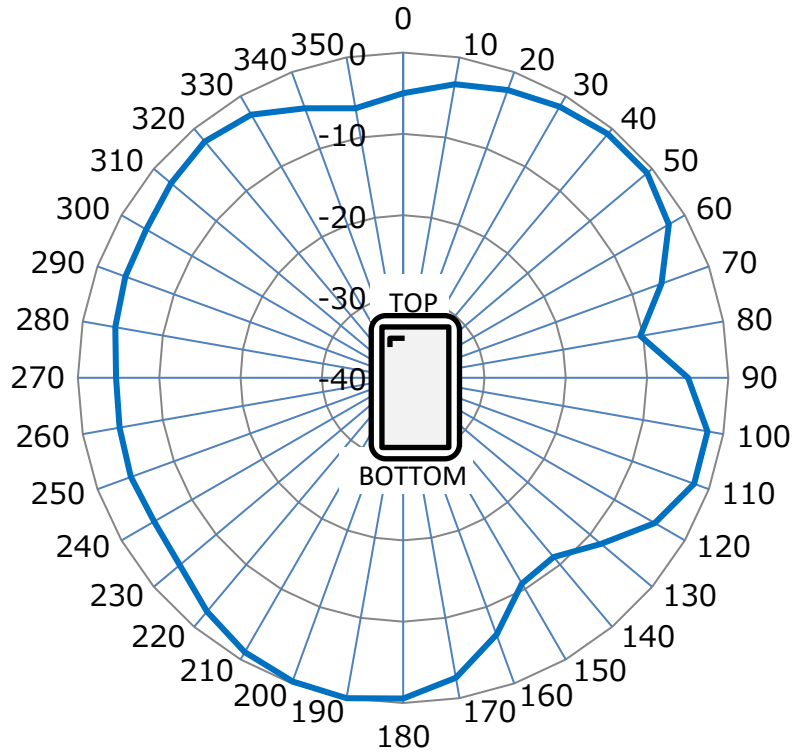

Front panel direction : upside

Peak Gain : 0.1 [dBi]

LTE Band 5

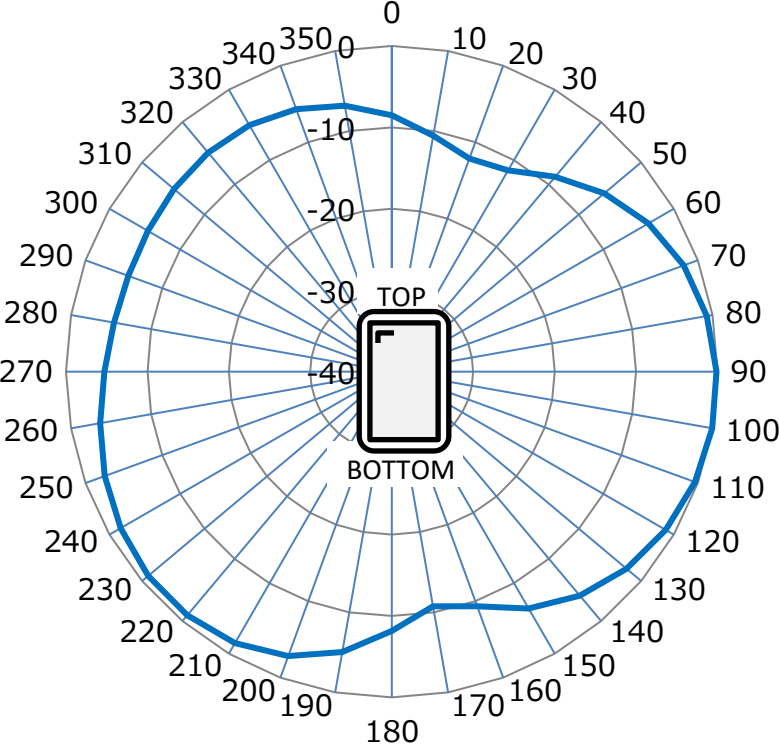

Front panel direction : upside

Peak Gain : -2.6 [dBi]

LTE Band 8

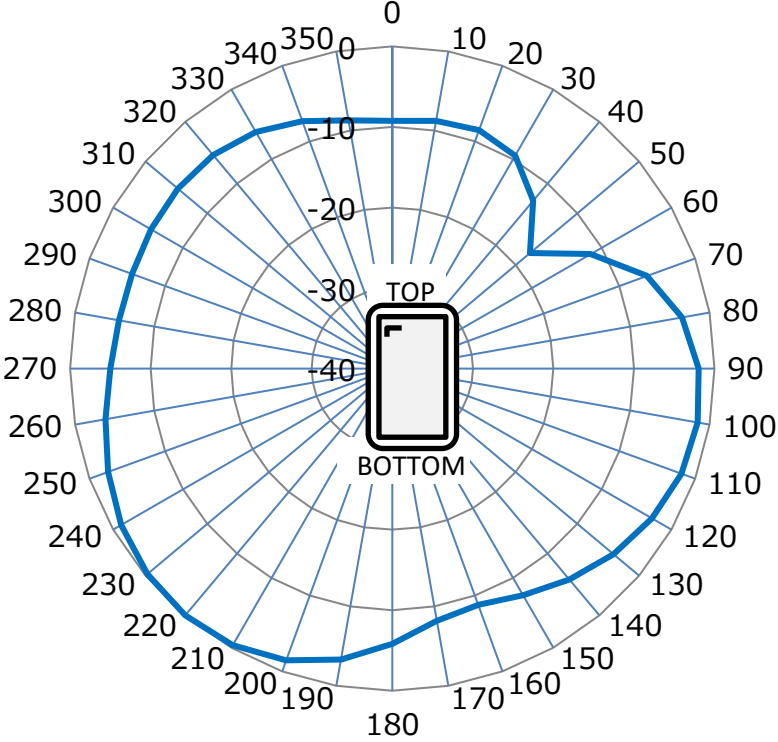

Front panel direction : upside

Peak Gain : -2.6 [dBi]

LTE Band 12

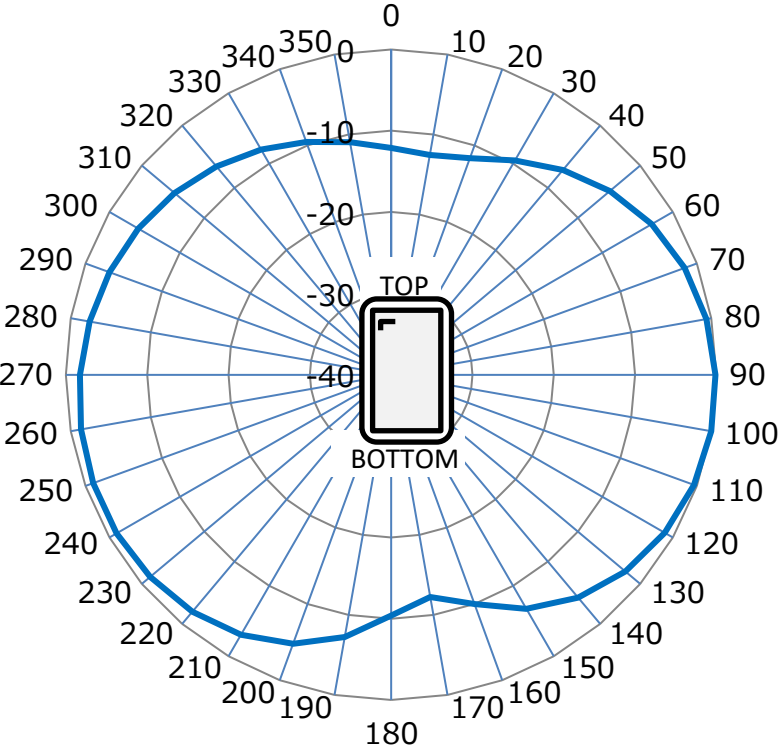

Front panel direction : upside

Peak Gain : -3.0 [dBi]

LTE Band 28

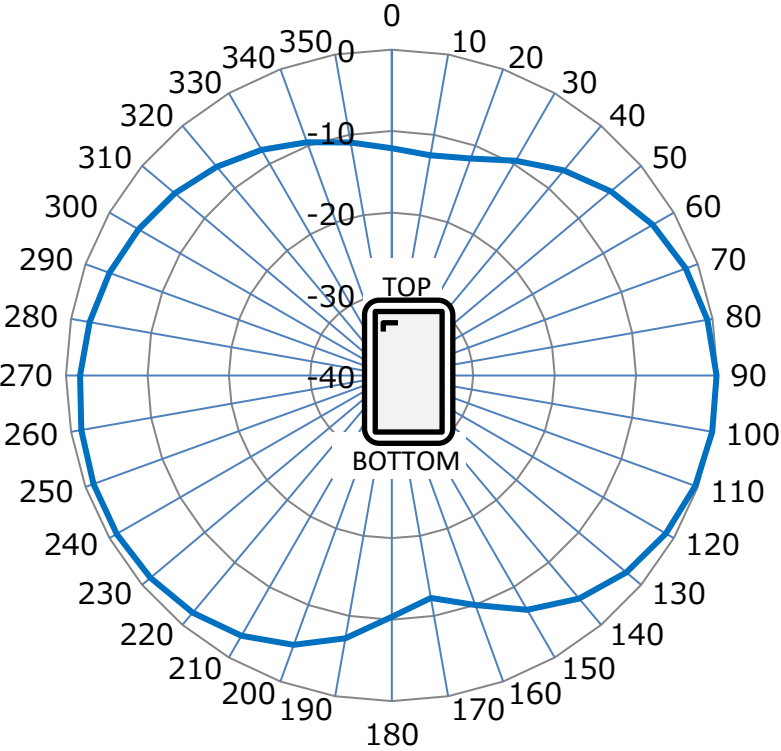

Front panel direction : upside

Peak Gain : -3.0 [dBi]

LTE Band 38

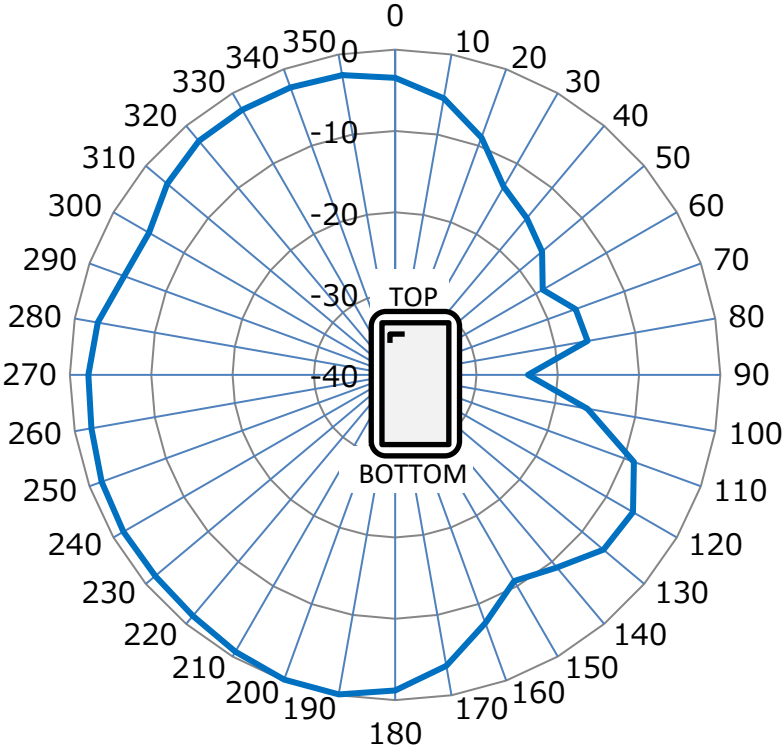

Front panel direction : upside

Peak Gain : 0.2 [dBi]

LTE Band 39

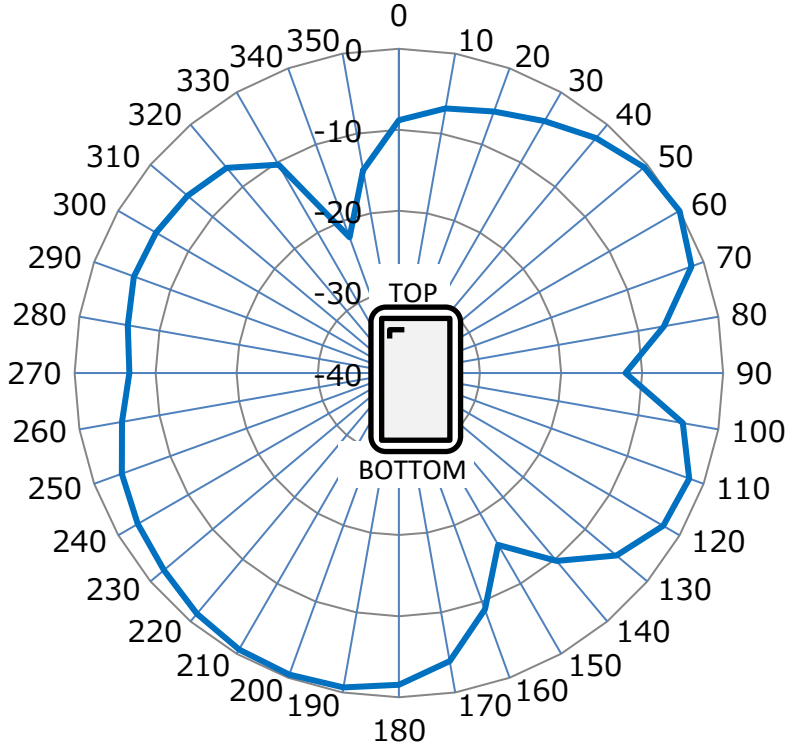

Front panel direction : upside

Peak Gain : -0.1 [dBi]

LTE Band 41

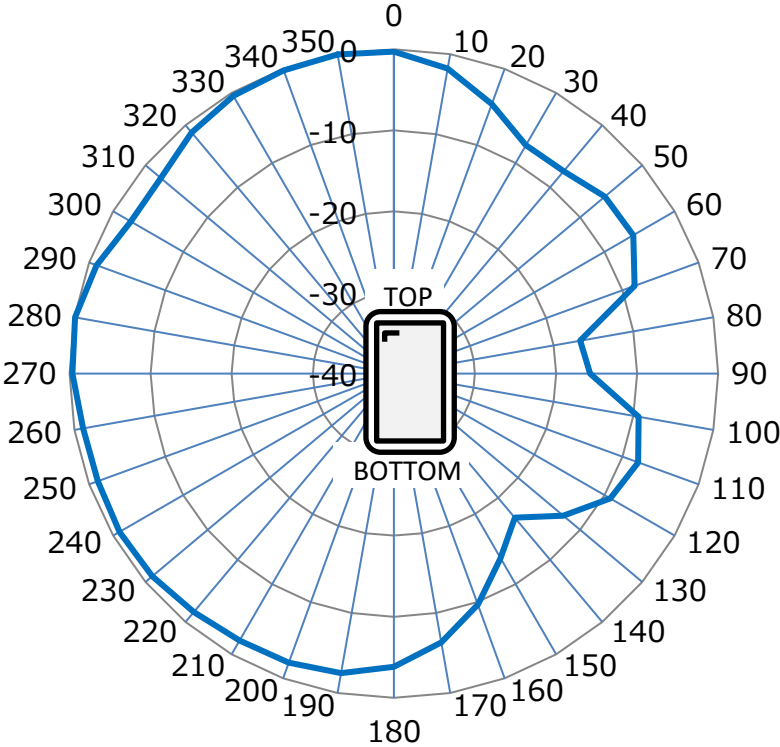

Front panel direction : upside

Peak Gain : 1.5 [dBi]

UMTS Band 1

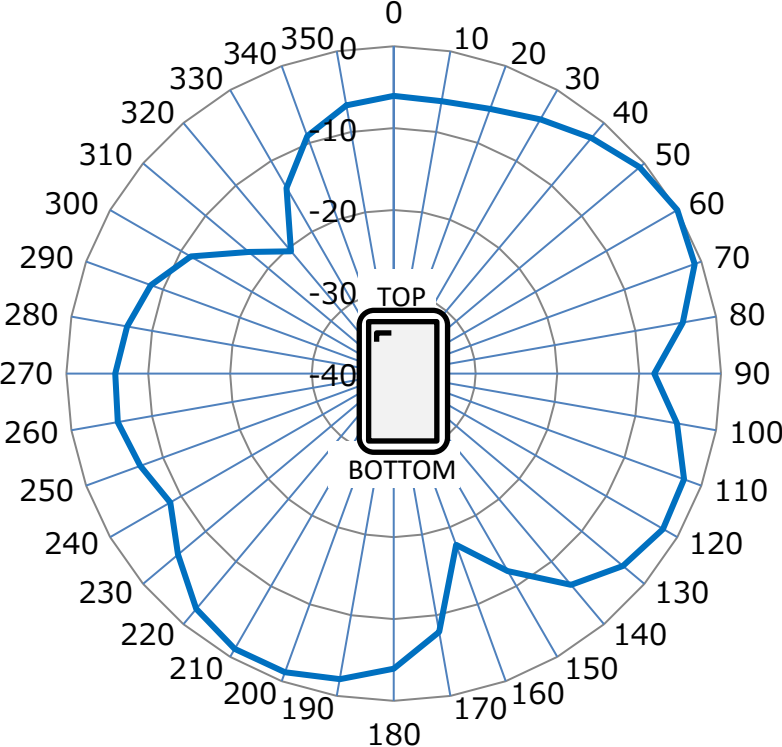

Front panel direction : upside

Peak Gain : 0.6 [dBi]

UMTS Band 2

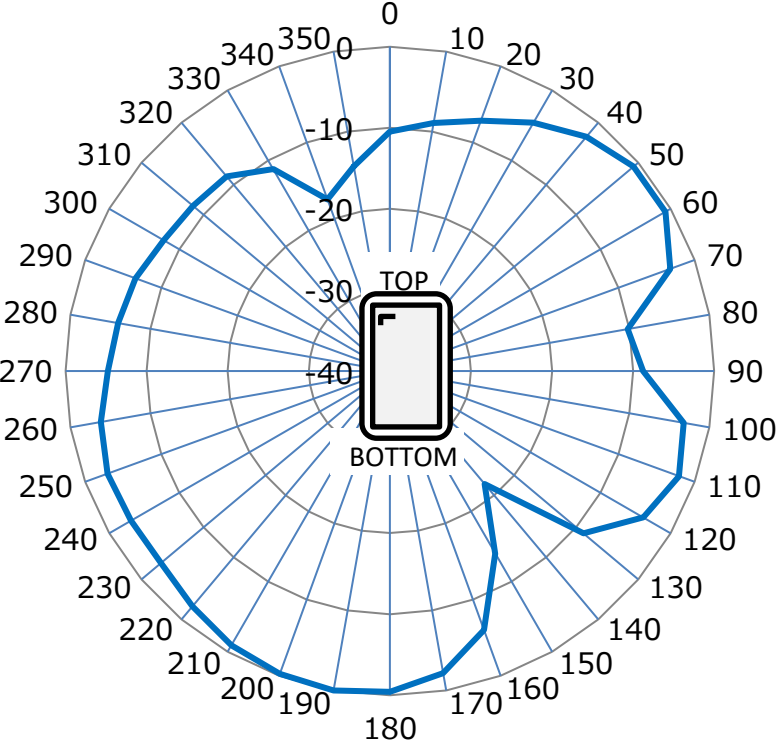

Front panel direction : upside

Peak Gain : 0.1 [dBi]

UMTS Band 4

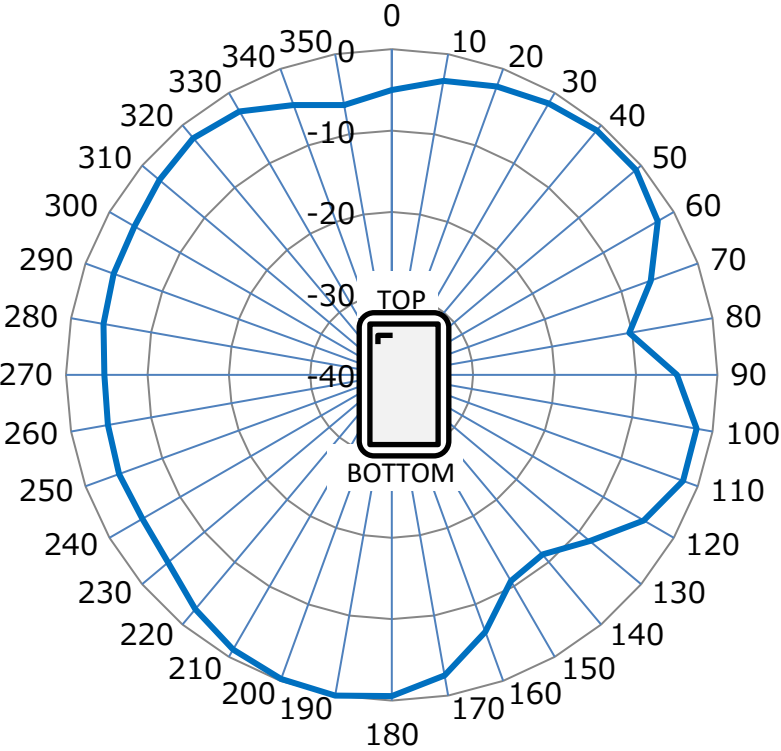

Front panel direction : upside

Peak Gain : 0.1 [dBi]

UMTS Band 5

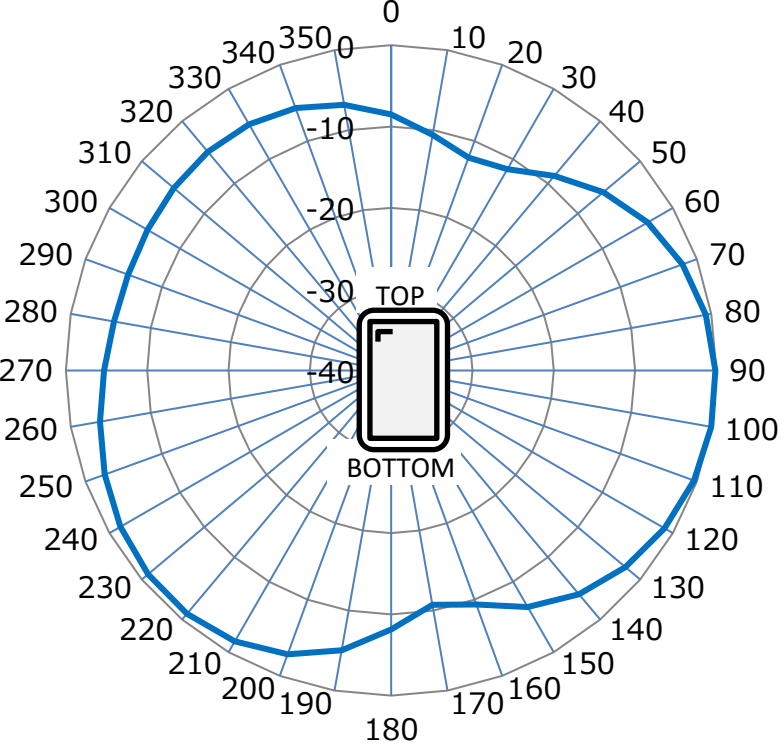

Front panel direction : upside

Peak Gain : -2.6 [dBi]

UMTS Band 8

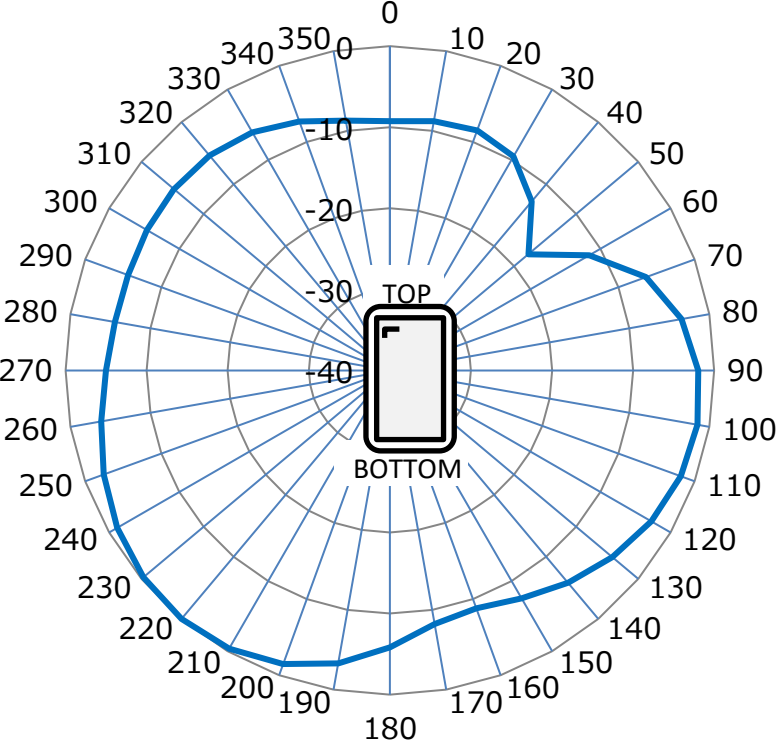

Front panel direction : upside

Peak Gain : -2.6 [dBi]

GSM850

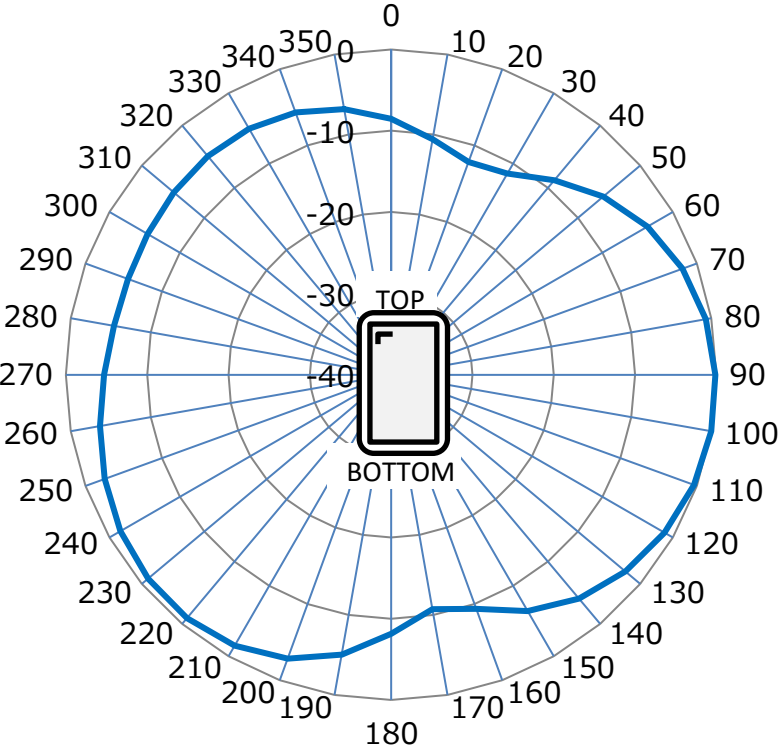

Front panel direction : upside

Peak Gain : -2.6 [dBi]

GSM900

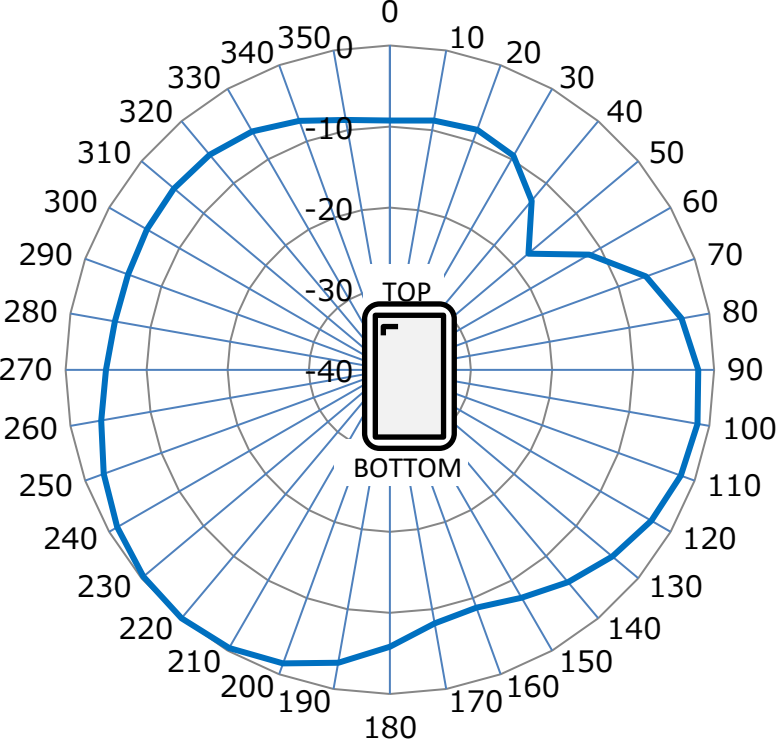

Front panel direction : upside

Peak Gain : -2.6 [dBi]

GSM1800

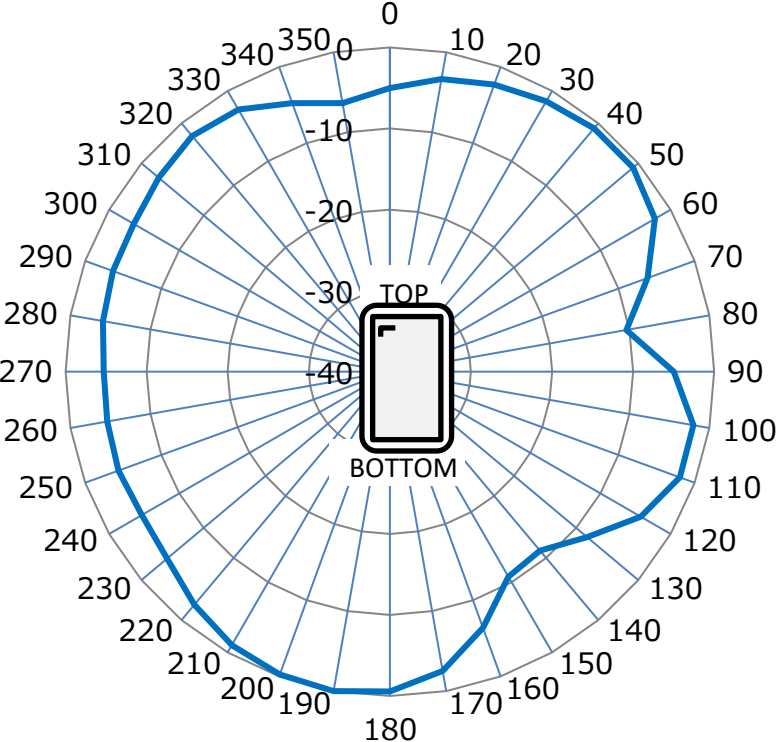

Front panel direction : upside

Peak Gain : 0.1 [dBi]

GSM1900

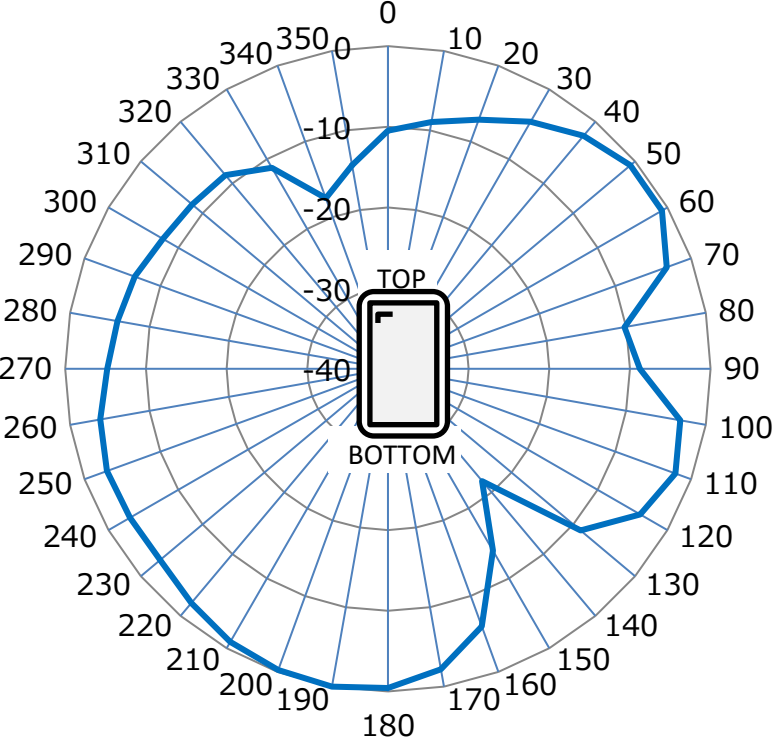

Front panel direction : upside

Peak Gain : 0.1 [dBi]

Bluetooth / WLAN

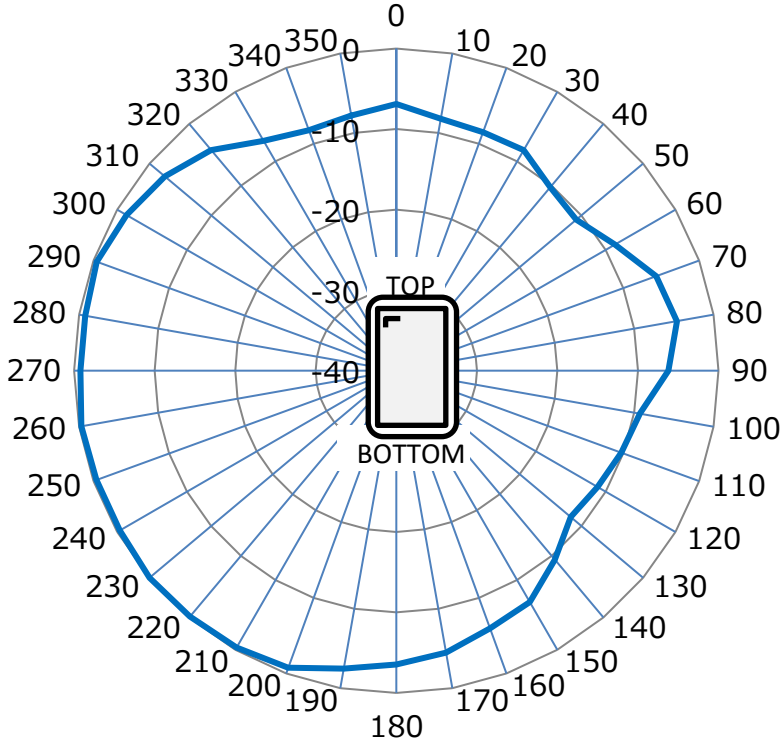

Front panel direction : upside

Peak Gain : 0.2 [dBi]

WLAN W52_W53

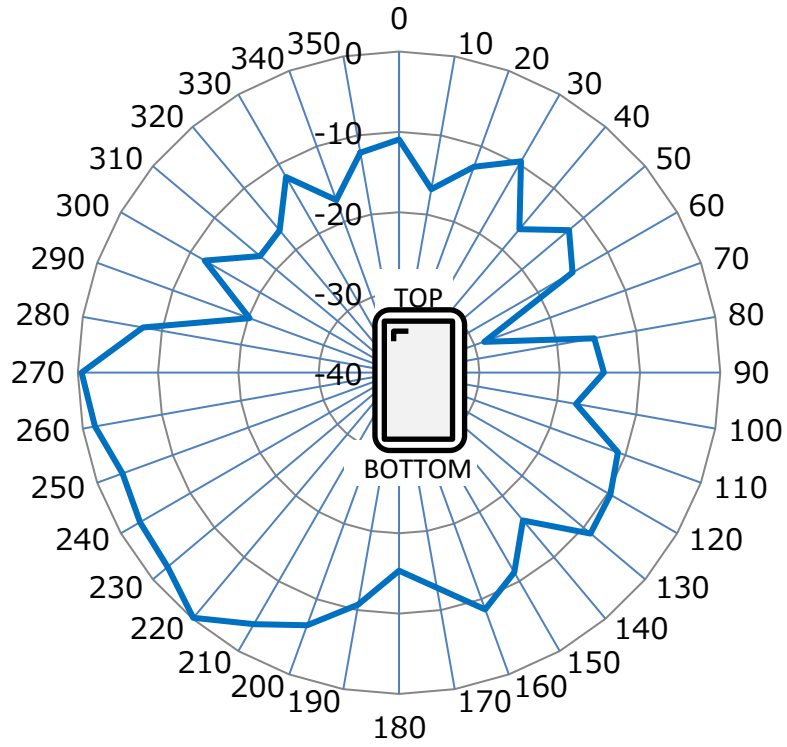

Front panel direction : upsid

Peak Gain : 4.8 [dBi]

WLAN W56

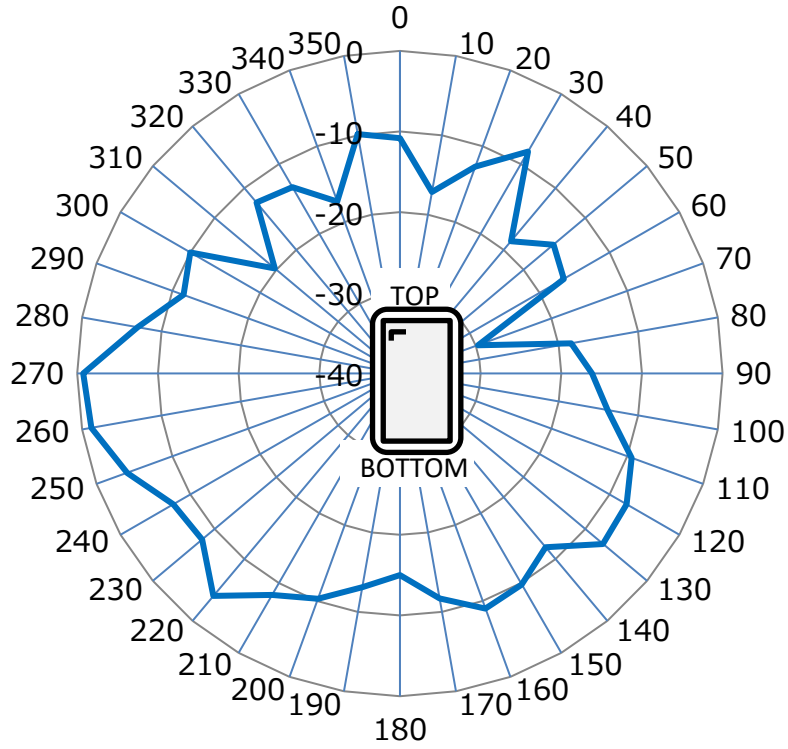

Front panel direction : upsid

Peak Gain : 5.4 [dBi]

ANT0 (Main antenna)

LTE

B1/B2/B3/B4/B5/B8/B12/B28/B38/B39/B41

UMTS

B1/B2/B4/B5/B8

GSM

850/900/1800/1900

Top

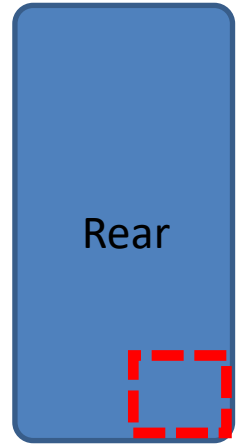

Rear

Bottom

Rear view

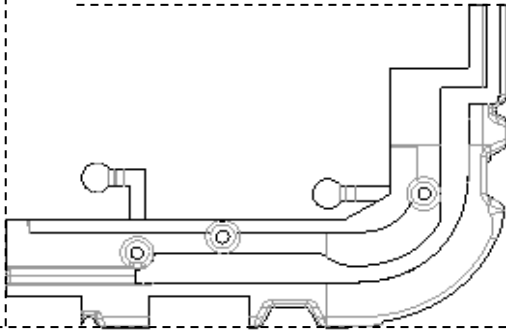

Side view

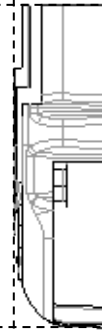

19.77

Bottom view

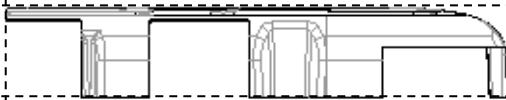

5.47

5.47

29.83

[mm]

ANT4

BT/WLAN 2.4G

WLAN W52/W53/W56

Top

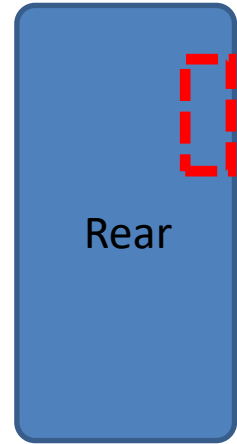

Rear

Bottom

Rear view

Side view

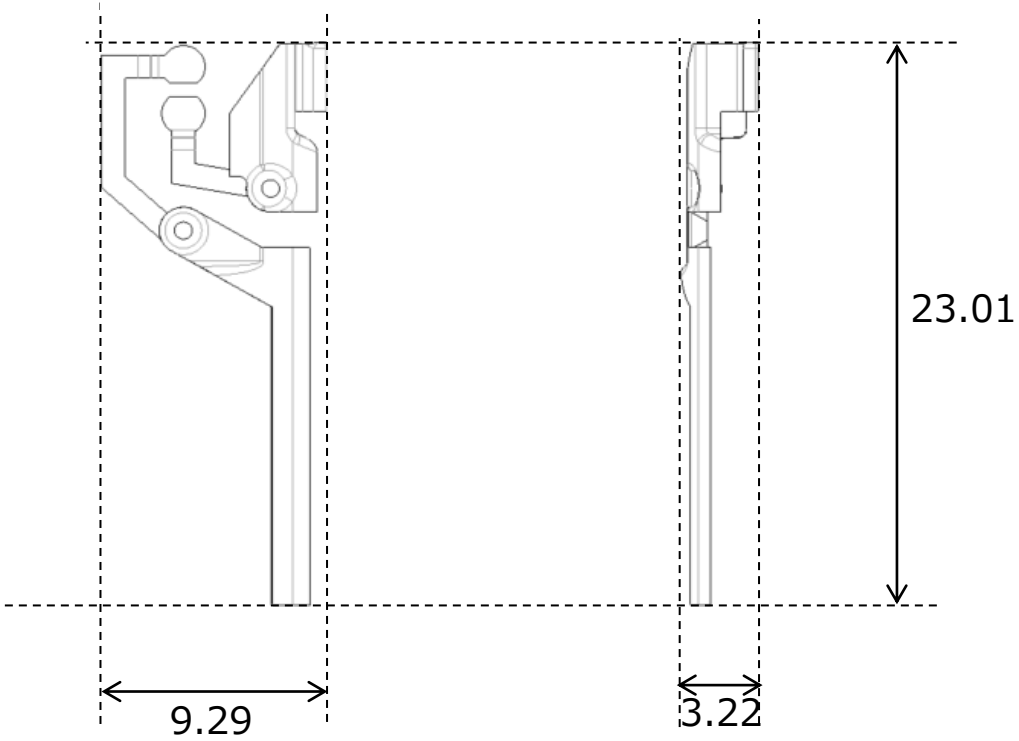

[mm]

Distance from ANT0(Main antenna) to the sideline

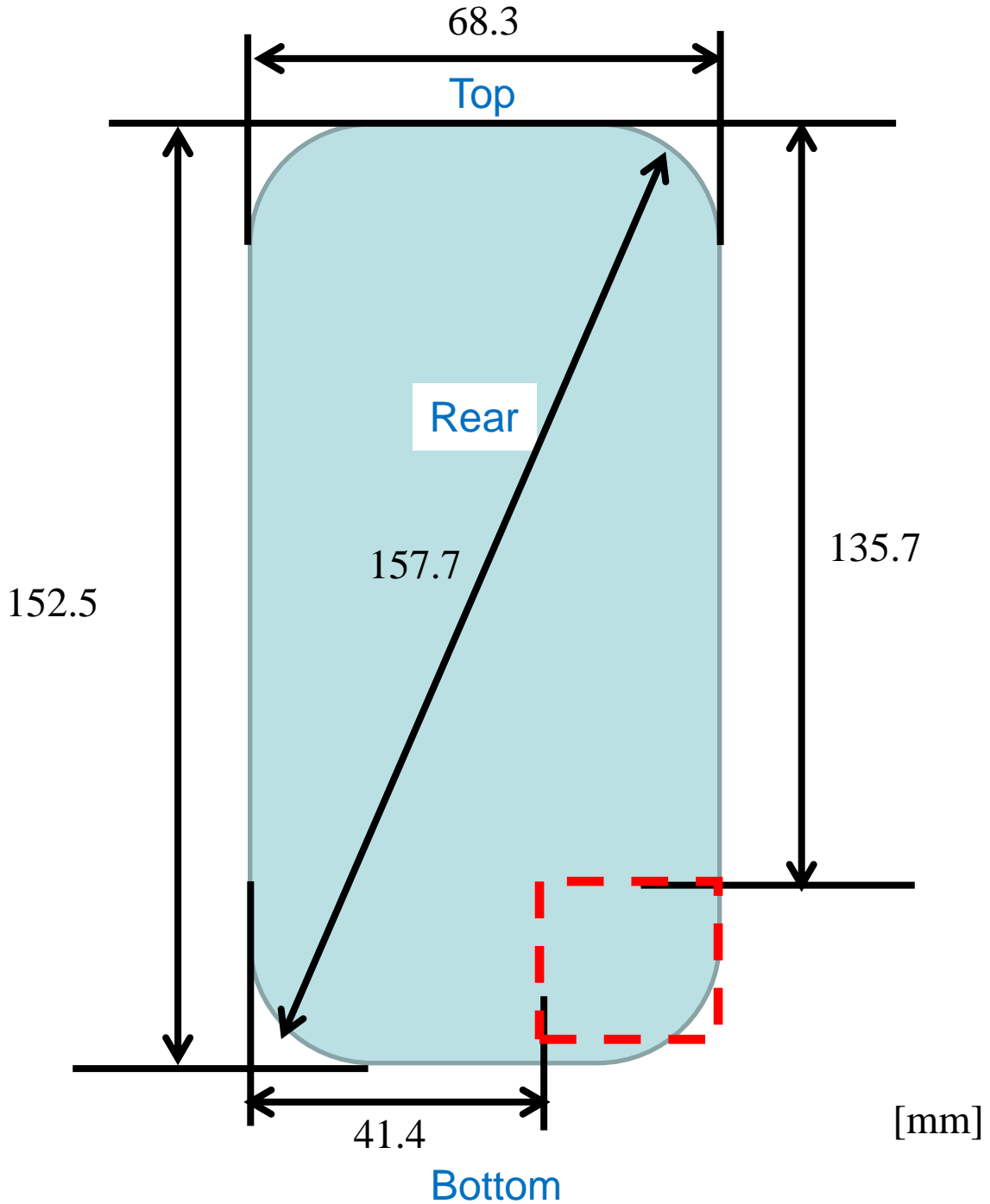

ANT0 (Main antenna)

LTE: B1/B2/B3/B4/B5/B8/B12/B28/B38/B39/B41

UMTS: B1/B2/B4/B5/B8

GSM: 850/900/1800/1900

Distance from ANT4 (Bluetooth/WLAN antenna) to the sideline

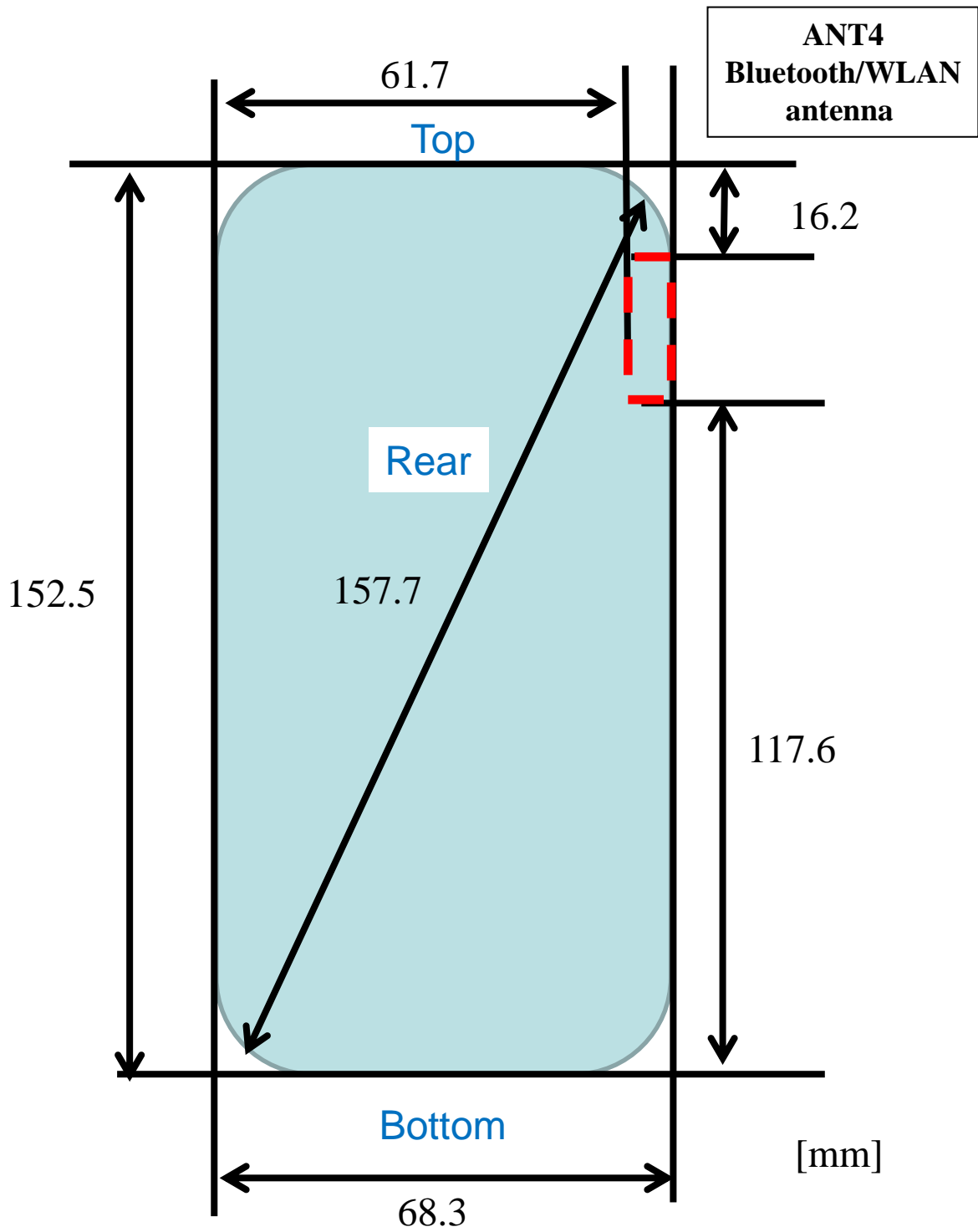

Distance between ANT0 and ANT4

**ANT4
Bluetooth/WLAN
antenna**

