



A D T

# FCC TEST REPORT (BLUETOOTH)

**REPORT NO.:** RF140502C06-2 R1

**MODEL NO.:** KYY24

**FCC ID:** JOYKYY24

**RECEIVED:** May 02, 2014

**TESTED:** May 14, 2014 ~ May 25, 2014

**ISSUED:** Jun. 27, 2014

**APPLICANT:** Kyocera Corporation c/o Kyocera Communications, Inc.

**ADDRESS:** 9520 Towne Centre Drive, Suite 200 San Diego, CA 92121

**ISSUED BY:** Bureau Veritas Consumer Products Services  
(H.K.) Ltd., Taoyuan Branch

**LAB ADDRESS:** No. 47, 14th Ling, Chia Pau Vil., Lin Kou Dist.,  
New Taipei City, Taiwan ( R.O.C )

**TEST LOCATION:** No. 19, Hwa Ya 2nd Rd, Wen Hwa Tsuen, Kwei  
Shan Hsiang, Taoyuan Hsien 333, Taiwan, R.O.C.

This report should not be used by the client to claim product certification, approval, or endorsement by TAF or any government agencies.



This report is for your exclusive use. Any copying or replication of this report to or for any other person or entity, or use of our name or trademark, is permitted only with our prior written permission. This report sets forth our findings solely with respect to the test samples identified herein. The results set forth in this report are not indicative or representative of the quality or characteristics of the lot from which a test sample was taken or any similar or identical product unless specifically and expressly noted. Our report includes all of the tests requested by you and the results thereof based upon the information that you provided to us. You have 60 days from date of issuance of this report to notify us of any material error or omission caused by our negligence, provided, however, that such notice shall be in writing and shall specifically address the issue you wish to raise. A failure to raise such issue within the prescribed time shall constitute your unqualified acceptance of the completeness of this report, the tests conducted and the correctness of the report contents. Unless specific mention, the uncertainty of measurement has been explicitly taken into account to declare the compliance or non-compliance to the specification.



# TABLE OF CONTENTS

- RELEASE CONTROL RECORD ..... 5
- 1. CERTIFICATION..... 6
- 2. SUMMARY OF TEST RESULTS ..... 7
  - 2.1 MEASUREMENT UNCERTAINTY ..... 8
- 3. GENERAL INFORMATION..... 9
  - 3.1 GENERAL DESCRIPTION OF EUT..... 9
  - 3.2 DESCRIPTION OF TEST MODES..... 10
    - 3.2.1 TEST MODE APPLICABILITY AND TESTED CHANNEL DETAIL..... 11
  - 3.3 DESCRIPTION OF SUPPORT UNITS..... 15
    - 3.3.1 CONFIGURATION OF SYSTEM UNDER TEST ..... 15
  - 3.4 GENERAL DESCRIPTION OF APPLIED STANDARDS..... 15
- 4. TEST TYPES AND RESULTS (FOR BLUETOOTH EDR) ..... 16
  - 4.1 RADIATED EMISSION AND BANDEDGE MEASUREMENT ..... 16
    - 4.1.1 LIMITS OF RADIATED EMISSION AND BANDEDGE MEASUREMENT ..... 16
    - 4.1.2 TEST INSTRUMENTS..... 17
    - 4.1.3 TEST PROCEDURES ..... 18
    - 4.1.4 DEVIATION FROM TEST STANDARD ..... 18
    - 4.1.5 TEST SETUP ..... 19
    - 4.1.6 EUT OPERATING CONDITIONS ..... 19
    - 4.1.7 TEST RESULTS..... 20
  - 4.2 CONDUCTED EMISSION MEASUREMENT ..... 24
    - 4.2.1 LIMITS OF CONDUCTED EMISSION MEASUREMENT ..... 24
    - 4.2.2 TEST INSTRUMENTS..... 24
    - 4.2.3 TEST PROCEDURES ..... 25
    - 4.2.4 DEVIATION FROM TEST STANDARD ..... 25
    - 4.2.5 TEST SETUP ..... 25
    - 4.2.6 EUT OPERATING CONDITIONS ..... 25
    - 4.2.7 TEST RESULTS..... 26
  - 4.3 NUMBER OF HOPPING FREQUENCY USED..... 28
    - 4.3.1 LIMIT OF HOPPING FREQUENCY USED ..... 28
    - 4.3.2 TEST SETUP ..... 28
    - 4.3.3 TEST INSTRUMENTS..... 28
    - 4.3.4 TEST PROCEDURE..... 28
    - 4.3.5 DEVIATION FROM TEST STANDARD ..... 28
    - 4.3.6 TEST RESULTS..... 28
  - 4.4 DWELL TIME ON EACH CHANNEL ..... 30
    - 4.4.1 LIMITS OF DWELL TIME USED ..... 30
    - 4.4.2 TEST SETUP ..... 30
    - 4.4.3 TEST INSTRUMENTS..... 30
    - 4.4.4 TEST PROCEDURES ..... 30
    - 4.4.5 DEVIATION FROM TEST STANDARD ..... 30
    - 4.4.6 TEST RESULTS..... 31
  - 4.5 CHANNEL BANDWIDTH..... 37
    - 4.5.1 LIMITS OF CHANNEL BANDWIDTH ..... 37
    - 4.5.2 TEST SETUP ..... 37
    - 4.5.3 TEST INSTRUMENTS..... 37
    - 4.5.4 TEST PROCEDURE..... 37
    - 4.5.5 DEVIATION FROM TEST STANDARD ..... 37
    - 4.5.6 EUT OPERATING CONDITION..... 37
    - 4.5.7 TEST RESULTS..... 38
  - 4.6 HOPPING CHANNEL SEPARATION ..... 39
    - 4.6.1 LIMITS OF HOPPING CHANNEL SEPARATION..... 39



4.6.2	TEST SETUP .....	39
4.6.3	TEST INSTRUMENTS .....	39
4.6.4	TEST PROCEDURE .....	39
4.6.5	DEVIATION FROM TEST STANDARD .....	39
4.6.6	TEST RESULTS.....	40
4.7	MAXIMUM OUTPUT POWER .....	41
4.7.1	LIMITS OF MAXIMUM OUTPUT POWER MEASUREMENT .....	41
4.7.2	TEST SETUP .....	41
4.7.3	TEST INSTRUMENTS .....	41
4.7.4	TEST PROCEDURE .....	41
4.7.5	DEVIATION FROM TEST STANDARD .....	41
4.7.6	EUT OPERATING CONDITION.....	41
4.7.7	TEST RESULTS.....	42
4.8	CONDUCTED OUT OF BAND EMISSION MEASUREMENT .....	43
4.8.1	LIMITS OF CONDUCTED OUT OF BAND EMISSION MEASUREMENT .....	43
4.8.2	TEST INSTRUMENTS.....	43
4.8.3	TEST PROCEDURE.....	43
4.8.4	DEVIATION FROM TEST STANDARD .....	43
4.8.5	EUT OPERATING CONDITION.....	43
4.8.6	TEST RESULTS.....	43
5.	TEST TYPES AND RESULTS (FOR BLUETOOTH LE 4.0).....	47
5.1	RADIATED EMISSION AND BANDEDGE MEASUREMENT .....	47
5.1.1	LIMITS OF RADIATED EMISSION AND BANDEDGE MEASUREMENT .....	47
5.1.2	TEST INSTRUMENTS.....	47
5.1.3	TEST PROCEDURES .....	48
5.1.4	DEVIATION FROM TEST STANDARD .....	48
5.1.5	TEST SETUP .....	49
5.1.6	EUT OPERATING CONDITIONS .....	49
5.1.7	TEST RESULTS.....	50
5.2	CONDUCTED EMISSION MEASUREMENT .....	54
5.2.1	LIMITS OF CONDUCTED EMISSION MEASUREMENT .....	54
5.2.2	TEST INSTRUMENTS.....	54
5.2.3	TEST PROCEDURES .....	54
5.2.4	DEVIATION FROM TEST STANDARD .....	54
5.2.5	TEST SETUP .....	54
5.2.6	EUT OPERATING CONDITIONS .....	54
5.2.7	TEST RESULTS.....	55
5.3	6dB BANDWIDTH MEASUREMENT .....	57
5.3.1	LIMITS OF 6dB BANDWIDTH MEASUREMENT .....	57
5.3.2	TEST SETUP .....	57
5.3.3	TEST INSTRUMENTS.....	57
5.3.4	TEST PROCEDURE.....	57
5.3.5	DEVIATION FROM TEST STANDARD .....	57
5.3.6	EUT OPERATING CONDITIONS .....	57
5.3.7	TEST RESULTS.....	58
5.4	CONDUCTED OUTPUT POWER .....	59
5.4.1	LIMITS OF MAXIMUM OUTPUT POWER MEASUREMENT .....	59
5.4.2	TEST SETUP .....	59
5.4.3	INSTRUMENTS .....	59
5.4.4	TEST PROCEDURES .....	59
5.4.5	DEVIATION FROM TEST STANDARD .....	59
5.4.6	EUT OPERATING CONDITIONS .....	59
5.4.7	TEST RESULTS.....	59
5.5	POWER SPECTRAL DENSITY MEASUREMENT.....	60
5.5.1	LIMITS OF POWER SPECTRAL DENSITY MEASUREMENT .....	60



A D T

5.5.2	TEST SETUP .....	60
5.5.3	TEST INSTRUMENTS .....	60
5.5.4	TEST PROCEDURE .....	60
5.5.5	DEVIATION FROM TEST STANDARD .....	60
5.5.6	EUT OPERATING CONDITION.....	60
5.5.7	TEST RESULTS.....	61
5.6	CONDUCTED OUT OF BAND EMISSION MEASUREMENT .....	62
5.6.1	LIMITS OF OUT OF BAND EMISSION MEASUREMENT .....	62
5.6.2	TEST SETUP .....	62
5.6.3	TEST INSTRUMENTS .....	62
5.6.4	TEST PROCEDURE .....	62
5.6.5	DEVIATION FROM TEST STANDARD .....	62
5.6.6	EUT OPERATING CONDITION.....	62
5.6.7	TEST RESULTS.....	63
6.	PHOTOGRAPHS OF THE TEST CONFIGURATION.....	64
7.	INFORMATION ON THE TESTING LABORATORIES .....	65
8.	APPENDIX A – MODIFICATIONS RECORDERS FOR ENGINEERING CHANGES TO THE EUT BY THE LAB .....	66



A D T

## RELEASE CONTROL RECORD

ISSUE NO.	REASON FOR CHANGE	DATE ISSUED
RF140502C06-2	Original release	Jun. 11, 2014
RF140502C06-2 R1	Revise Battery model name	Jun. 27, 2014



## 1. CERTIFICATION

**PRODUCT:** Mobile Phone  
**MODEL NO.:** KYY24  
**BRAND:** TORQUE G01  
**APPLICANT:** Kyocera Corporation c/o Kyocera Communications, Inc.  
**TESTED:** May 14, 2014 ~ May 25, 2014  
**TEST SAMPLE:** Identical Prototype  
**STANDARDS:** **FCC Part 15, Subpart C (Section 15.247)**  
ANSI C63.10-2009

The above equipment (model: KYY24) has been tested by **Bureau Veritas Consumer Products Services (H.K.) Ltd., Taoyuan Branch**, and found compliance with the requirement of the above standards. The test record, data evaluation & Equipment Under Test (EUT) configurations represented herein are true and accurate accounts of the measurements of the sample's EMC characteristics under the conditions specified in this report.

**PREPARED BY :** Vera Huang , **DATE :** Jun. 27, 2014  
Vera Huang / Specialist

**APPROVED BY :** Sam chen , **DATE :** Jun. 27, 2014  
Sam Chen / Senior Project Engineer

## 2. SUMMARY OF TEST RESULTS

The EUT has been tested according to the following specifications:

APPLIED STANDARD: FCC Part 15, Subpart C (Bluetooth EDR)			
STANDARD SECTION	TEST TYPE AND LIMIT	RESULT	REMARK
15.207	AC Power Conducted Emission	PASS	Meet the requirement of limit. Minimum passing margin is -6.22dB at 13.56250MHz.
15.247(a)(1) (iii)	Number of Hopping Frequency Used	PASS	Meet the requirement of limit.
15.247(a)(1) (iii)	Dwell Time on Each Channel	PASS	Meet the requirement of limit.
15.247(a)(1)	1. Hopping Channel Separation 2. Spectrum Bandwidth of a Frequency Hopping Sequence Spread Spectrum System	PASS	Meet the requirement of limit.
15.247(b)	Maximum Peak Output Power	PASS	Meet the requirement of limit.
15.247(d)	Transmitter Radiated Emissions	PASS	Meet the requirement of limit. Minimum passing margin is -12.09dB at 2483.5MHz.
15.247(d)	Band Edge Measurement	PASS	Meet the requirement of limit.
15.203	Antenna Requirement	PASS	No antenna connector is used.

**NOTE:** If The Frequency Hopping System operating in 2400-2483.5MHz band and the output power less than 125mW. The hopping channel carrier frequencies separated by a minimum of 25kHz or two-thirds of the 20dB bandwidth of hopping channel whichever is greater.



A D T

APPLIED STANDARD: FCC PART 15, SUBPART C (SECTION 15.247) (Bluetooth LE 4.0)			
STANDARD SECTION	TEST TYPE AND LIMIT	RESULT	REMARK
15.207	AC Power Conducted Emission	PASS	Meet the requirement of limit. Minimum passing margin is -7.19dB at 13.55469MHz.
15.205 & 15.209	Radiated Emissions	PASS	Meet the requirement of limit. Minimum passing margin is -12.09dB at 2483.5MHz.
15.247(d)	Band Edge Measurement	PASS	Meet the requirement of limit.
15.247(d)	Antenna Port Emission	PASS	Meet the requirement of limit.
15.247(a)(2)	6dB bandwidth	PASS	Meet the requirement of limit.
15.247(b)	Conducted power	PASS	Meet the requirement of limit.
15.247(e)	Power Spectral Density	PASS	Meet the requirement of limit.
15.203	Antenna Requirement	PASS	No antenna connector is used.

## 2.1 MEASUREMENT UNCERTAINTY

Where relevant, the following measurement uncertainty levels have been estimated for tests performed on the EUT as specified in CISPR 16-4-2:

MEASUREMENT	FREQUENCY	UNCERTAINTY
Conducted emissions	9kHz~30MHz	2.44 dB
Radiated emissions	30MHz ~ 200MHz	2.93 dB
	200MHz ~ 1000MHz	2.95 dB
	1GHz ~ 18GHz	2.26 dB
	18GHz ~ 40GHz	1.94 dB

This uncertainty represents an expanded uncertainty expressed at approximately the 95% confidence level using a coverage factor of  $k = 2$ .





A D T

### 3. GENERAL INFORMATION

#### 3.1 GENERAL DESCRIPTION OF EUT

<b>EUT</b>	Mobile Phone	
<b>MODEL NO.</b>	KYY24	
<b>POWER SUPPLY</b>	5.0Vdc (adapter or host equipment) 3.8Vdc (battery)	
<b>MODULATION TYPE</b>	<b>Bluetooth EDR</b>	GFSK, $\pi/4$ -DQPSK, 8DPSK
	<b>Bluetooth LE 4.0</b>	GFSK
<b>TRANSFER RATE</b>	<b>Bluetooth EDR</b>	1/2/3Mbps
	<b>Bluetooth LE 4.0</b>	1Mbps
<b>OPERATING FREQUENCY</b>	2402 ~ 2480MHz	
<b>NUMBER OF CHANNEL</b>	<b>Bluetooth EDR</b>	79
	<b>Bluetooth LE 4.0</b>	40
<b>CHANNEL SPACING</b>	<b>Bluetooth EDR</b>	1MHz
	<b>Bluetooth LE 4.0</b>	2MHz
<b>OUTPUT POWER</b>	<b>Bluetooth EDR</b>	13.062mW
	<b>Bluetooth LE 4.0</b>	1.406mW
<b>ANTENNA TYPE</b>	Monopole antenna with 0dBi gain	
<b>ANTENNA CONNECTOR</b>	NA	
<b>DATA CABLE</b>	Refer to Note as below	
<b>I/O PORTS</b>	Refer to user's manual	
<b>ACCESSORY DEVICES</b>	Refer to Note as below	

**NOTE:**

1. The EUT contains following accessory devices.

ITEM	BRAND	MODEL	SPECIFICATION
Battery	KYOCERA	5AAXB081JAA-	3.8Vdc, 3000mAh
Earphone	HOSIDEN	HDH0261	1.5m cable

2. The above EUT information was declared by manufacturer and for more detailed features description, please refer to the manufacturer's specifications or User's Manual.

### 3.2 DESCRIPTION OF TEST MODES

#### Bluetooth EDR:

79 channels are provided to this EUT:

CHANNEL	FREQ. (MHz)	CHANNEL	FREQ. (MHz)	CHANNEL	FREQ. (MHz)	CHANNEL	FREQ. (MHz)
0	2402	20	2422	40	2442	60	2462
1	2403	21	2423	41	2443	61	2463
2	2404	22	2424	42	2444	62	2464
3	2405	23	2425	43	2445	63	2465
4	2406	24	2426	44	2446	64	2466
5	2407	25	2427	45	2447	65	2467
6	2408	26	2428	46	2448	66	2468
7	2409	27	2429	47	2449	67	2469
8	2410	28	2430	48	2450	68	2470
9	2411	29	2431	49	2451	69	2471
10	2412	30	2432	50	2452	70	2472
11	2413	31	2433	51	2453	71	2473
12	2414	32	2434	52	2454	72	2474
13	2415	33	2435	53	2455	73	2475
14	2416	34	2436	54	2456	74	2476
15	2417	35	2437	55	2457	75	2477
16	2418	36	2438	56	2458	76	2478
17	2419	37	2439	57	2459	77	2479
18	2420	38	2440	58	2460	78	2480
19	2421	39	2441	59	2461		

#### Bluetooth LE 4.0:

40 channels are provided to this EUT:

CHANNEL	FREQ. (MHz)	CHANNEL	FREQ. (MHz)	CHANNEL	FREQ. (MHz)	CHANNEL	FREQ. (MHz)
0	2402	10	2422	20	2442	30	2462
1	2404	11	2424	21	2444	31	2464
2	2406	12	2426	22	2446	32	2466
3	2408	13	2428	23	2448	33	2468
4	2410	14	2430	24	2450	34	2470
5	2412	15	2432	25	2452	35	2472
6	2414	16	2434	26	2454	36	2474
7	2416	17	2436	27	2456	37	2476
8	2418	18	2438	28	2458	38	2478
9	2420	19	2440	29	2460	39	2480



A D T

### 3.2.1 TEST MODE APPLICABILITY AND TESTED CHANNEL DETAIL

#### BLUETOOTH EDR

EUT CONFIGURE MODE	APPLICABLE TO				DESCRIPTION
	RE≥1G	RE<1G	PLC	APCM	
-	√	√	√	√	-

Where **RE≥1G**: Radiated Emission above 1GHz      **RE<1G**: Radiated Emission below 1GHz  
**PLC**: Power Line Conducted Emission      **APCM**: Antenna Port Conducted Measurement

- NOTE:** 1. For Radiated emission test, pre-tested GFSK, π/4-DQPSK, 8DPSK modulation type and found 8DPSK was the worse, therefore chosen for the final test and presented in the test report.  
 2. The EUT had been pre-tested on the positioned of each 3 axis. The worst case was found when positioned on **Z-plane**.

#### RADIATED EMISSION TEST (ABOVE 1GHz):

- Pre-Scan has been conducted to determine the worst-case mode from all possible combinations between available modulations, data rates and antenna ports (if EUT with antenna diversity architecture).
- Following channel(s) was (were) selected for the final test as listed below.

EUT CONFIGURE MODE	AVAILABLE CHANNEL	TESTED CHANNEL	MODULATION TYPE	PACKET TYPE
-	0 to 78	0, 39, 78	8DPSK	DH5

#### RADIATED EMISSION TEST (BELOW 1GHz):

- Pre-Scan has been conducted to determine the worst-case mode from all possible combinations between available modulations, data rates and antenna ports (if EUT with antenna diversity architecture).
- Following channel(s) was (were) selected for the final test as listed below.

EUT CONFIGURE MODE	AVAILABLE CHANNEL	TESTED CHANNEL	MODULATION TYPE	PACKET TYPE
-	0 to 78	78	8DPSK	DH5

#### POWER LINE CONDUCTED EMISSION TEST:

EUT CONFIGURE MODE	AVAILABLE CHANNEL	TESTED CHANNEL	MODULATION TYPE	PACKET TYPE
-	0 to 78	78	8DPSK	DH5



**ANTENNA PORT CONDUCTED MEASUREMENT:**

- This item includes all test value of each mode, but only includes spectrum plot of worst value of each mode.
- Pre-Scan has been conducted to determine the worst-case mode from all possible combinations between available modulations, data rates and antenna ports (if EUT with antenna diversity architecture).
- Following channel(s) was (were) selected for the final test as listed below.

EUT CONFIGURE MODE	AVAILABLE CHANNEL	TESTED CHANNEL	MODULATION TYPE	PACKET TYPE
-	0 to 78	0, 39, 78	GFSK	DH5
-	0 to 78	0, 39, 78	$\pi/4$ -DQPSK	DH5
-	0 to 78	0, 39, 78	8DPSK	DH5

**Test CONDITION:**

APPLICABLE TO	ENVIRONMENTAL CONDITIONS	INPUT POWER	TESTED BY
RE $\geq$ 1G	25deg. C, 65%RH	120Vac, 60Hz	Harry Hsueh
RE $<$ 1G	25deg. C, 65%RH	120Vac, 60Hz	Harry Hsueh
PLC	25deg. C, 65%RH	120Vac, 60Hz	Peter Weng
APCM	25deg. C, 65%RH	120Vac, 60Hz	Howard Kao



A D T

### BLUETOOTH LE 4.0:

EUT CONFIGURE MODE	APPLICABLE TO				DESCRIPTION
	RE $\geq$ 1G	RE<1G	PLC	APCM	
-	√	√	√	√	-

Where **RE $\geq$ 1G**: Radiated Emission above 1GHz **RE<1G**: Radiated Emission below 1GHz  
**PLC**: Power Line Conducted Emission **APCM**: Antenna Port Conducted Measurement

**NOTE:** The EUT had been pre-tested on the positioned of each 3 axis. The worst case was found when positioned on **Z-plane**.

### RADIATED EMISSION TEST (ABOVE 1GHz):

- Pre-Scan has been conducted to determine the worst-case mode from all possible combinations between available modulations, data rates and antenna ports (if EUT with antenna diversity architecture).
- Following channel(s) was (were) selected for the final test as listed below.

EUT CONFIGURE MODE	AVAILABLE CHANNEL	TESTED CHANNEL	MODULATION TYPE	DATA RATE (Mbps)
-	0 to 39	0, 19, 39	GFSK	1.0

### RADIATED EMISSION TEST (BELOW 1GHz):

- Pre-Scan has been conducted to determine the worst-case mode from all possible combinations between available modulations, data rates and antenna ports (if EUT with antenna diversity architecture).
- Following channel(s) was (were) selected for the final test as listed below.

EUT CONFIGURE MODE	AVAILABLE CHANNEL	TESTED CHANNEL	MODULATION TYPE	DATA RATE (Mbps)
-	0 to 39	39	GFSK	1.0

### POWER LINE CONDUCTED EMISSION TEST:

EUT CONFIGURE MODE	AVAILABLE CHANNEL	TESTED CHANNEL	MODULATION TYPE	DATA RATE (Mbps)
-	0 to 39	39	GFSK	1.0



A D T

**ANTENNA PORT CONDUCTED MEASUREMENT:**

- Pre-Scan has been conducted to determine the worst-case mode from all possible combinations between available modulations, data rates and antenna ports (if EUT with antenna diversity architecture).
- Following channel(s) was (were) selected for the final test as listed below.

EUT CONFIGURE MODE	AVAILABLE CHANNEL	TESTED CHANNEL	MODULATION TYPE	DATA RATE (Mbps)
-	0 to 39	0, 19, 39	GFSK	1.0

**Test CONDITION:**

APPLICABLE TO	ENVIRONMENTAL CONDITIONS	INPUT POWER	TESTED BY
RE $\geq$ 1G	25deg. C, 65%RH	120Vac, 60Hz	Harry Hsueh
RE $<$ 1G	25deg. C, 65%RH	120Vac, 60Hz	Harry Hsueh
PLC	25deg. C, 65%RH	120Vac, 60Hz	Peter Weng
APCM	25deg. C, 65%RH	120Vac, 60Hz	Howard Kao

### 3.3 DESCRIPTION OF SUPPORT UNITS

The EUT has been tested as an independent unit together with other necessary accessories or support units. The following support units or accessories were used to form a representative test configuration during the tests.

NO.	PRODUCT	BRAND	MODEL NO.	SERIAL NO.	FCC ID
1	Adapter	KDDI(MITSUMI)	0301PQA	N/A	N/A

NO.	SIGNAL CABLE DESCRIPTION OF THE ABOVE SUPPORT UNITS
1	N/A

**NOTE:**

1. All power cords of the above support units are non shielded (1.8m).
2. Item 1 was provided by client.

#### 3.3.1 CONFIGURATION OF SYSTEM UNDER TEST

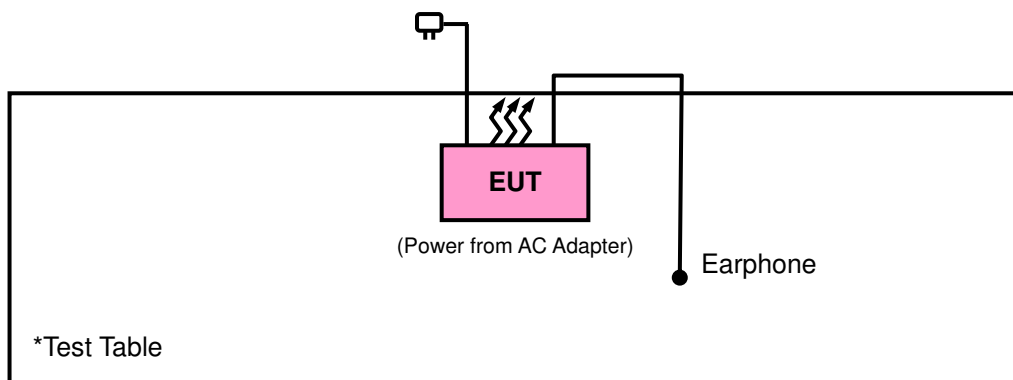

### 3.4 GENERAL DESCRIPTION OF APPLIED STANDARDS

The EUT is a RF Product. According to the specifications of the manufacturer, it must comply with the requirements of the following standards:

- FCC Part 15, Subpart C (15.247)**
- ANSI C63.10-2009**
- 558074 D01 DTS Meas Guidance v03r01**
- FCC Public Notice DA 00-705**

All test items have been performed and recorded as per the above standards.

## 4. TEST TYPES AND RESULTS (FOR BLUETOOTH EDR)

### 4.1 RADIATED EMISSION AND BANDEDGE MEASUREMENT

#### 4.1.1 LIMITS OF RADIATED EMISSION AND BANDEDGE MEASUREMENT

Radiated emissions which fall in the restricted bands must comply with the radiated emission limits specified as below table. Other emissions shall be at least 20dB below the highest level of the desired power:

FREQUENCIES (MHz)	FIELD STRENGTH (microvolts/meter)	MEASUREMENT DISTANCE (meters)
0.009 ~ 0.490	2400/F(kHz)	300
0.490 ~ 1.705	24000/F(kHz)	30
1.705 ~ 30.0	30	30
30 ~ 88	100	3
88 ~ 216	150	3
216 ~ 960	200	3
Above 960	500	3

**NOTE:**

1. The lower limit shall apply at the transition frequencies.
2. Emission level (dBuV/m) = 20 log Emission level (uV/m).
3. For frequencies above 1000MHz, the field strength limits are based on average detector, however, the peak field strength of any emission shall not exceed the maximum permitted average limits, specified above by more than 20dB under any condition of modulation.





A D T

**4.1.2 TEST INSTRUMENTS**

DESCRIPTION & MANUFACTURER	MODEL NO.	SERIAL NO.	DATE OF CALIBRATION	DUE DATE OF CALIBRATION
Test Receiver ROHDE & SCHWARZ	ESCI	100412	Sep. 13, 2013	Sep. 12, 2014
Spectrum Analyzer ROHDE & SCHWARZ	FSU43	101261	Dec. 21, 2013	Dec. 20, 2014
BILOG Antenna SCHWARZBECK	VULB9168	9168-472	Feb. 27, 2014	Feb. 26, 2015
HORN Antenna SCHWARZBECK	BBHA 9120 D	9120D- 209	Sep. 12, 2013	Sep. 11, 2014
HORN Antenna SCHWARZBECK	BBHA 9170	9170-480	Dec. 18, 2013	Dec. 17, 2014
Loop Antenna	HFH2-Z2	100070	Mar. 06, 2014	Mar. 05, 2016
Preamplifier EMCI	EMC 012645	980115	Dec. 26, 2013	Dec. 25, 2014
Preamplifier EMCI	EMC 184045	980116	Jan. 13, 2014	Jan. 12, 2015
Preamplifier EMCI	EMC 330H	980112	Dec. 27, 2013	Dec. 26, 2014
RF signal cable HUBER+SUHNNER	SUCOFLEX 104	309219/4	Oct. 18, 2013	Oct. 17, 2014
RF signal cable HUBER+SUHNNER	SUCOFLEX 104	250130/4	Oct. 18, 2013	Oct. 17, 2014
RF signal cable Worken	RG-213	NA	Nov. 07, 2013	Nov. 06, 2014
Software BV ADT	E3 6.120103	NA	NA	NA
Antenna Tower MF	MFA-440H	NA	NA	NA
Turn Table MF	MFT-201SS	NA	NA	NA
Antenna Tower & Turn Table Controller MF	MF-7802	NA	NA	NA
Bluetooth Tester	CBT	100946	Jul. 29, 2013	Jul. 28, 2014
Power Meter	ML2495A	1232002	Aug. 23, 2013	Aug. 22, 2014
Power Sensor	MA2411B	1207325	Aug. 23, 2013	Aug. 22, 2014

- NOTE:**
1. The calibration interval of the above test instruments is 12 months and the calibrations are traceable to NML/ROC and NIST/USA.
  2. The calibration interval of the loop antenna is 24 months and the calibrations are traceable to NML/ROC and NIST/USA.
  3. The test was performed in HwaYa Chamber 10.
  4. The horn antenna and HP preamplifier (model: 8449B) are used only for the measurement of emission frequency above 1GHz if tested.
  5. The FCC Site Registration No. is 690701.
  6. The IC Site Registration No. is IC 7450F-10.

#### 4.1.3 TEST PROCEDURES

- a. The EUT was placed on the top of a rotating table 0.8 meters above the ground at a 3 meters semi-anechoic chamber. The table was rotated 360 degrees to determine the position of the highest radiation.
- b. The EUT was set 3 meters away from the interference-receiving antenna, which was mounted on the top of a variable-height antenna tower.
- c. The antenna is a broadband antenna, and its height is varied from one meter to four meters above the ground to determine the maximum value of the field strength. Both horizontal and vertical polarizations of the antenna are set to make the measurement.
- d. For each suspected emission, the EUT was arranged to its worst case and then the antenna was tuned to heights from 1 meter to 4 meters and the rotatable table was turned from 0 degrees to 360 degrees to find the maximum reading.
- e. The test-receiver system was set to Peak Detect Function and Specified Bandwidth with Maximum Hold Mode.
- f. If the emission level of the EUT in peak mode was lower than the limit specified, then testing could be stopped and the peak values of the EUT would be reported. Otherwise the emissions would be re-tested one by one using peak, quasi-peak or average method as specified and then reported in a data sheet.

#### NOTE:

1. The resolution bandwidth and video bandwidth of test receiver/spectrum analyzer is 120kHz for Quasi-peak detection at frequency below 1GHz.
2. The resolution bandwidth of test receiver/spectrum analyzer is 1MHz and video bandwidth is 3MHz for Peak detection at frequency above 1GHz.
3. The resolution bandwidth of test receiver/spectrum analyzer is 1MHz and the video bandwidth is 10Hz for Average detection (AV) at frequency above 1GHz.

#### 4.1.4 DEVIATION FROM TEST STANDARD

No deviation.

### 4.1.5 TEST SETUP

Frequency Range 30MHz ~ 1GHz

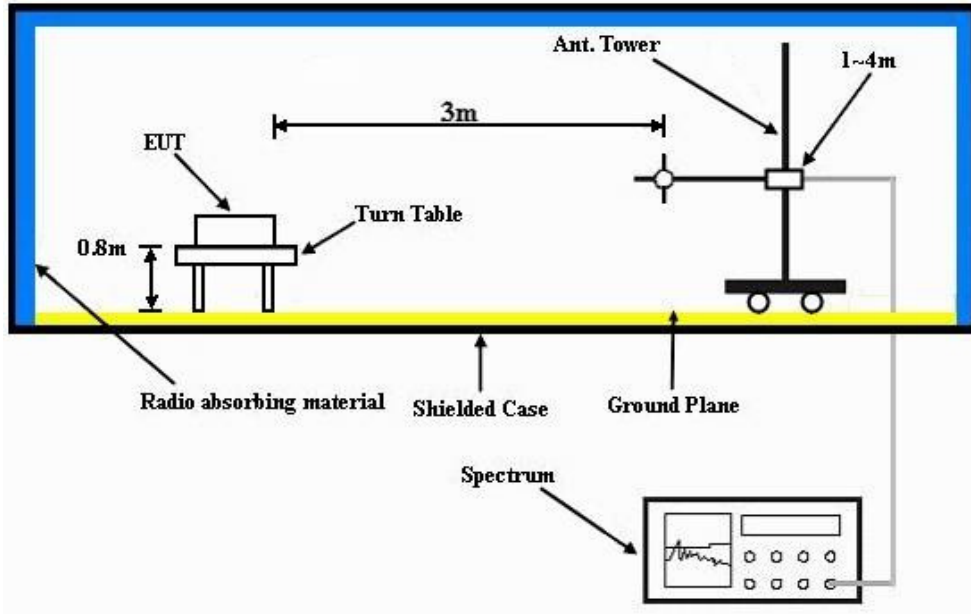

Frequency Range above 1GHz

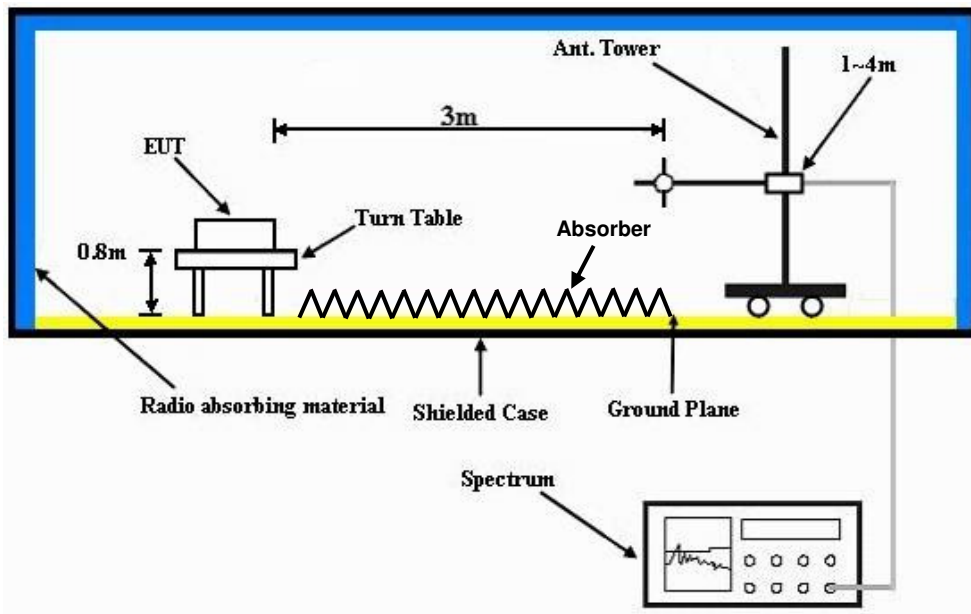

For the actual test configuration, please refer to the attached file (Test Setup Photo).

### 4.1.6 EUT OPERATING CONDITIONS

- Placed the EUT on a testing table.
- Use the software to control the EUT under transmission condition continuously at specific channel frequency.



A D T

#### 4.1.7 TEST RESULTS

#### ABOVE 1GHz WORST-CASE DATA

#### 8DPSK

EUT TEST CONDITION		MEASUREMENT DETAIL	
CHANNEL	Channel 0	FREQUENCY RANGE	1GHz ~ 25GHz
INPUT POWER	120Vac, 60 Hz	DETECTOR FUNCTION	Peak (PK) Average (AV)
ENVIRONMENTAL CONDITIONS	25deg. C, 65%RH	TESTED BY	Harry Hsueh

ANTENNA POLARITY & TEST DISTANCE: HORIZONTAL AT 3 M										
FREQ. (MHz)	EMISSION LEVEL (dBuV/m)	READ LEVEL (dBuV)	LIMIT (dBuV/m)	MARGIN (dB)	ANTENNA FACTOR (dB/m)	CABLE LOSS (dB)	PREAMP FACTOR (dB)	ANTENNA HEIGHT (cm)	TABLE ANGLE (Degree)	REMARK
2346	39.18	37.61	54	-14.82	31.74	5.33	35.5	119	152	Average
2346	56.3	54.73	74	-17.7	31.74	5.33	35.5	119	152	Peak
2402	98.72	96.99			31.8	5.4	35.47	119	152	Average
2402	102.43	100.7			31.8	5.4	35.47	119	152	Peak
2494	38.96	36.94	54	-15.04	31.9	5.53	35.41	119	152	Average
2494	56.28	54.26	74	-17.72	31.9	5.53	35.41	119	152	Peak
ANTENNA POLARITY & TEST DISTANCE: VERTICAL AT 3 M										
FREQ. (MHz)	EMISSION LEVEL (dBuV/m)	READ LEVEL (dBuV)	LIMIT (dBuV/m)	MARGIN (dB)	ANTENNA FACTOR (dB/m)	CABLE LOSS (dB)	PREAMP FACTOR (dB)	ANTENNA HEIGHT (cm)	TABLE ANGLE (Degree)	REMARK
2378	39.67	38.01	54	-14.33	31.78	5.37	35.49	134	206	Average
2378	55.63	53.97	74	-18.37	31.78	5.37	35.49	134	206	Peak
2402	101.98	100.25			31.8	5.4	35.47	134	206	Average
2402	105.74	104.01			31.8	5.4	35.47	134	206	Peak
2494	39.55	37.53	54	-14.45	31.9	5.53	35.41	134	206	Average
2494	56.32	54.3	74	-17.68	31.9	5.53	35.41	134	206	Peak

#### REMARKS:

- Emission Level = Read Level + Antenna Factor + Cable Loss - Preamp Factor  
Margin value = Emission level – Limit value
- 2402MHz: Fundamental frequency.



A D T

EUT TEST CONDITION		MEASUREMENT DETAIL	
CHANNEL	Channel 39	FREQUENCY RANGE	1GHz ~ 25GHz
INPUT POWER	120Vac, 60 Hz	DETECTOR FUNCTION	Peak (PK) Average (AV)
ENVIRONMENTAL CONDITIONS	25deg. C, 65%RH	TESTED BY	Harry Hsueh

**ANTENNA POLARITY & TEST DISTANCE: HORIZONTAL AT 3 M**

FREQ. (MHz)	EMISSION LEVEL (dBuV/m)	READ LEVEL (dBuV)	LIMIT (dBuV/m)	MARGIN (dB)	ANTENNA FACTOR (dB/m)	CABLE LOSS (dB)	PREAMP FACTOR (dB)	ANTENNA HEIGHT (cm)	TABLE ANGLE (Degree)	REMARK
2352	39.24	37.65	54	-14.76	31.76	5.33	35.5	119	146	Average
2352	56.04	54.45	74	-17.96	31.76	5.33	35.5	119	146	Peak
2441	99.68	97.81			31.85	5.46	35.44	119	146	Average
2441	103.36	101.49			31.85	5.46	35.44	119	146	Peak
2500	39.76	37.74	54	-14.24	31.9	5.53	35.41	119	146	Average
2500	55.68	53.66	74	-18.32	31.9	5.53	35.41	119	146	Peak

**ANTENNA POLARITY & TEST DISTANCE: VERTICAL AT 3 M**

FREQ. (MHz)	EMISSION LEVEL (dBuV/m)	READ LEVEL (dBuV)	LIMIT (dBuV/m)	MARGIN (dB)	ANTENNA FACTOR (dB/m)	CABLE LOSS (dB)	PREAMP FACTOR (dB)	ANTENNA HEIGHT (cm)	TABLE ANGLE (Degree)	REMARK
2354	40.62	39.03	54	-13.38	31.76	5.33	35.5	104	149	Average
2354	56.54	54.95	74	-17.46	31.76	5.33	35.5	104	149	Peak
2441	102.88	101.01			31.85	5.46	35.44	104	149	Average
2441	106.9	105.03			31.85	5.46	35.44	104	149	Peak
2486	39.94	37.95	54	-14.06	31.88	5.53	35.42	104	149	Average
2486	55.69	53.7	74	-18.31	31.88	5.53	35.42	104	149	Peak

**REMARKS:**

- Emission Level = Read Level + Antenna Factor + Cable Loss - Preamp Factor  
Margin value = Emission level – Limit value
- 2441MHz: Fundamental frequency.



A D T

EUT TEST CONDITION		MEASUREMENT DETAIL	
CHANNEL	Channel 78	FREQUENCY RANGE	1GHz ~ 25GHz
INPUT POWER	120Vac, 60 Hz	DETECTOR FUNCTION	Peak (PK) Average (AV)
ENVIRONMENTAL CONDITIONS	25deg. C, 65%RH	TESTED BY	Harry Hsueh

**ANTENNA POLARITY & TEST DISTANCE: HORIZONTAL AT 3 M**

FREQ. (MHz)	EMISSION LEVEL (dBuV/m)	READ LEVEL (dBuV)	LIMIT (dBuV/m)	MARGIN (dB)	ANTENNA FACTOR (dB/m)	CABLE LOSS (dB)	PREAMP FACTOR (dB)	ANTENNA HEIGHT (cm)	TABLE ANGLE (Degree)	REMARK
2346	39.61	38.04	54	-14.39	31.74	5.33	35.5	180	0	Average
2346	57.28	55.71	74	-16.72	31.74	5.33	35.5	180	0	Peak
2480	99.74	97.78			31.88	5.5	35.42	180	0	Average
2480	104.84	102.88			31.88	5.5	35.42	180	0	Peak
2483.5	40.62	38.66	54	-13.38	31.88	5.5	35.42	180	0	Average
2483.5	56.54	54.58	74	-17.46	31.88	5.5	35.42	180	0	Peak

**ANTENNA POLARITY & TEST DISTANCE: VERTICAL AT 3 M**

FREQ. (MHz)	EMISSION LEVEL (dBuV/m)	READ LEVEL (dBuV)	LIMIT (dBuV/m)	MARGIN (dB)	ANTENNA FACTOR (dB/m)	CABLE LOSS (dB)	PREAMP FACTOR (dB)	ANTENNA HEIGHT (cm)	TABLE ANGLE (Degree)	REMARK
2320	38.56	37.05	54	-15.44	31.73	5.3	35.52	102	205	Average
2320	55.83	54.32	74	-18.17	31.73	5.3	35.52	102	205	Peak
2480	104.34	102.38			31.88	5.5	35.42	102	205	Average
2480	108.12	106.16			31.88	5.5	35.42	102	205	Peak
<b>2483.5</b>	<b>41.91</b>	<b>39.95</b>	<b>54</b>	<b>-12.09</b>	<b>31.88</b>	<b>5.5</b>	<b>35.42</b>	<b>102</b>	<b>205</b>	<b>Average</b>
2483.5	58.22	56.26	74	-15.78	31.88	5.5	35.42	102	205	Peak

**REMARKS:**

- Emission Level = Read Level + Antenna Factor + Cable Loss - Preamp Factor  
Margin value = Emission level – Limit value
- 2480MHz: Fundamental frequency.



A D T

**BELOW 1GHz WORST-CASE DATA:**

EUT TEST CONDITION		MEASUREMENT DETAIL	
CHANNEL	Channel 78	FREQUENCY RANGE	30MHz ~ 1GHz
INPUT POWER	120Vac, 60 Hz	DETECTOR FUNCTION	Peak (PK) Quasi-peak (QP)
ENVIRONMENTAL CONDITIONS	25deg. C, 65%RH	TESTED BY	Harry Hsueh

**ANTENNA POLARITY & TEST DISTANCE: HORIZONTAL AT 3 M**

FREQ. (MHz)	EMISSION LEVEL (dBuV/m)	READ LEVEL (dBuV)	LIMIT (dBuV/m)	MARGIN (dB)	ANTENNA FACTOR (dB/m)	CABLE LOSS (dB)	PREAMP FACTOR (dB)	ANTENNA HEIGHT (cm)	TABLE ANGLE (Degree)	REMARK
95.34	27.75	49.12	43.5	-15.75	9.34	1.28	31.99	156	210	Peak
182.55	24.84	45.07	43.5	-18.66	10.4	1.61	32.24	155	332	Peak
230.88	12.96	31.15	46	-33.04	12.13	1.85	32.17	156	201	Peak
406.4	23.33	35.21	46	-22.67	17.99	2.34	32.21	156	215	Peak
482.7	24.06	34.68	46	-21.94	18.93	2.56	32.11	155	165	Peak
556.2	22.04	31.23	46	-23.96	20.25	2.76	32.2	145	178	Peak

**ANTENNA POLARITY & TEST DISTANCE: VERTICAL AT 3 M**

FREQ. (MHz)	EMISSION LEVEL (dBuV/m)	READ LEVEL (dBuV)	LIMIT (dBuV/m)	MARGIN (dB)	ANTENNA FACTOR (dB/m)	CABLE LOSS (dB)	PREAMP FACTOR (dB)	ANTENNA HEIGHT (cm)	TABLE ANGLE (Degree)	REMARK
47.82	26.81	49.65	40	-13.19	8.48	0.9	32.22	165	145	Peak
91.02	24.29	45.97	43.5	-19.21	8.98	1.11	31.77	105	145	Peak
182.55	18.1	38.33	43.5	-25.4	10.4	1.61	32.24	165	115	Peak
386.8	24.9	37.54	46	-21.1	17.2	2.34	32.18	156	124	Peak
514.9	21.69	30.99	46	-24.31	20.13	2.7	32.13	165	215	Peak
700.4	25.03	30.91	46	-20.97	23.1	3.11	32.09	155	154	Peak

**REMARKS:** Emission Level = Read Level + Antenna Factor + Cable Loss - Preamp Factor  
Margin value = Emission level – Limit value



A D T

## 4.2 CONDUCTED EMISSION MEASUREMENT

### 4.2.1 LIMITS OF CONDUCTED EMISSION MEASUREMENT

FREQUENCY OF EMISSION (MHz)	CONDUCTED LIMIT (dB $\mu$ V)	
	Quasi-peak	Average
0.15 ~ 0.5	66 to 56	56 to 46
0.5 ~ 5	56	46
5 ~ 30	60	50

- NOTE:**
1. The lower limit shall apply at the transition frequencies.
  2. The limit decreases in line with the logarithm of the frequency in the range of 0.15 to 0.50MHz.
  3. All emanations from a class A/B digital device or system, including any network of conductors and apparatus connected thereto, shall not exceed the level of field strengths specified above.

### 4.2.2 TEST INSTRUMENTS

DESCRIPTION & MANUFACTURER	MODEL NO.	SERIAL NO.	DATE OF CALIBRATION	DUE DATE OF CALIBRATION
Test Receiver ROHDE & SCHWARZ	ESCS30	100288	Apr. 24, 2014	Apr. 23, 2015
RF signal cable Woken	5D-FB	Cable-HYCO2-01	Dec. 27, 2013	Dec. 26, 2014
LISN ROHDE & SCHWARZ (EUT)	ESH2-Z5	100100	Dec. 23, 2013	Dec. 22, 2014
LISN ROHDE & SCHWARZ (Peripheral)	ESH3-Z5	100312	Jul. 08, 2013	Jul. 07, 2014
Software ADT	BV ADT_Cond_ V7.3.7.3	NA	NA	NA

- NOTE:**
1. The calibration interval of the above test instruments is 12 months and the calibrations are traceable to NML/ROC and NIST/USA.
  2. The test was performed in HwaYa Shielded Room 2.
  3. The VCCI Site Registration No. is C-2047.



#### 4.2.3 TEST PROCEDURES

- The EUT was placed 0.4 meters from the conducting wall of the shielded room with EUT being connected to the power mains through a line impedance stabilization network (LISN). Other support units were connected to the power mains through another LISN. The two LISNs provide 50 ohm/ 50uH of coupling impedance for the measuring instrument.
- Both lines of the power mains connected to the EUT were checked for maximum conducted interference.
- The frequency range from 150kHz to 30MHz was searched. Emission levels under (Limit - 20dB) was not recorded.

**NOTE:** All modes of operation were investigated and the worst-case emissions are reported.

#### 4.2.4 DEVIATION FROM TEST STANDARD

No deviation.

#### 4.2.5 TEST SETUP

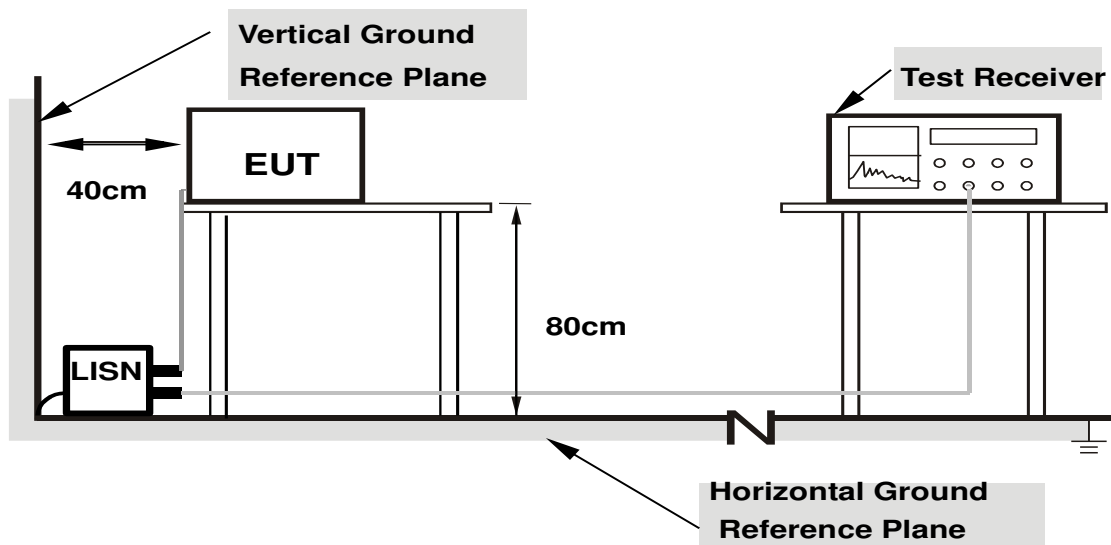

- Note:**
- Support units were connected to second LISN.
  - Both of LISNs (AMN) are 80 cm from EUT and at least 80 from other units and other metal planes

For the actual test configuration, please refer to the attached file (Test Setup Photo).

#### 4.2.6 EUT OPERATING CONDITIONS

Same as section 4.1.6.

**4.2.7 TEST RESULTS**

**CONDUCTED WORST-CASE DATA :**

<b>PHASE</b>	Line 1	<b>6dB BANDWIDTH</b>	9kHz
--------------	--------	----------------------	------

No	Freq. [MHz]	Corr. Factor (dB)	Reading Value [dB (uV)]		Emission Level [dB (uV)]		Limit [dB (uV)]		Margin (dB)	
			Q.P.	AV.	Q.P.	AV.	Q.P.	AV.	Q.P.	AV.
			1	0.20078	0.28	44.33	34.77	44.61	35.05	63.58
2	0.31016	0.29	41.67	30.33	41.96	30.62	59.97	49.97	-18.01	-19.35
3	0.75156	0.32	42.84	25.84	43.16	26.16	56.00	46.00	-12.84	-19.84
4	1.54688	0.35	40.86	26.14	41.21	26.49	56.00	46.00	-14.79	-19.51
5	13.55859	0.52	46.68	42.53	47.20	43.05	60.00	50.00	-12.80	-6.95
6	28.80078	0.46	43.18	40.47	43.64	40.93	60.00	50.00	-16.36	-9.07

**REMARKS:**

1. Q.P. and AV. are abbreviations of quasi-peak and average individually.
2. The emission levels of other frequencies were very low against the limit.
3. Margin value = Emission level - Limit value
4. Correction factor = Insertion loss + Cable loss
5. Emission Level = Correction Factor + Reading Value

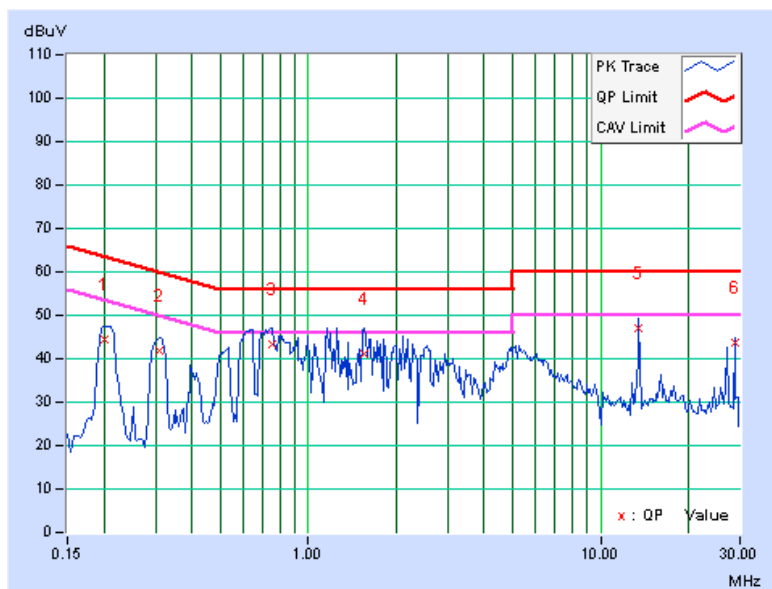

PHASE	Line 2	6dB BANDWIDTH	9kHz
-------	--------	---------------	------

No	Freq. [MHz]	Corr. Factor (dB)	Reading Value [dB (uV)]		Emission Level [dB (uV)]		Limit [dB (uV)]		Margin (dB)	
			Q.P.	AV.	Q.P.	AV.	Q.P.	AV.	Q.P.	AV.
			1	0.21250	0.28	36.31	27.94	36.59	28.22	63.11
2	0.30625	0.29	32.47	22.53	32.76	22.82	60.07	50.07	-27.31	-27.25
3	0.95078	0.34	35.20	20.00	35.54	20.34	56.00	46.00	-20.46	-25.66
4	1.37500	0.35	41.61	26.67	41.96	27.02	56.00	46.00	-14.04	-18.98
5	13.56250	0.55	47.31	43.23	47.86	43.78	60.00	50.00	-12.14	-6.22
6	27.12109	0.52	39.62	36.57	40.14	37.09	60.00	50.00	-19.86	-12.91

**REMARKS:**

1. Q.P. and AV. are abbreviations of quasi-peak and average individually.
2. The emission levels of other frequencies were very low against the limit.
3. Margin value = Emission level - Limit value
4. Correction factor = Insertion loss + Cable loss
5. Emission Level = Correction Factor + Reading Value

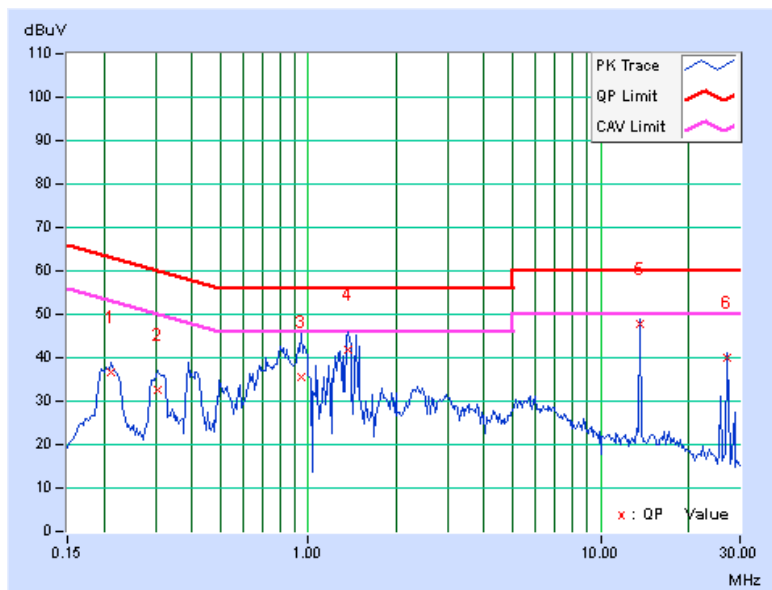

### 4.3 NUMBER OF HOPPING FREQUENCY USED

#### 4.3.1 LIMIT OF HOPPING FREQUENCY USED

At least 15 channels frequencies, and should be equally spaced.

#### 4.3.2 TEST SETUP

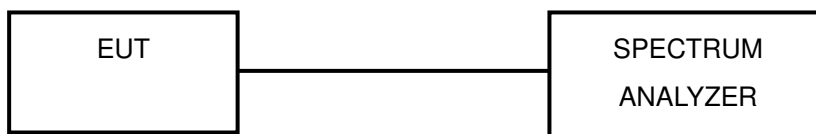

#### 4.3.3 TEST INSTRUMENTS

Refer to section 4.1.2 to get information of above instrument.

#### 4.3.4 TEST PROCEDURE

- a. Check the calibration of the measuring instrument (SA) using either an internal calibrator or a known signal from an external generator.
- b. Turn on the EUT and connect its antenna terminal to measurement via a low loss cable. Then set it to any one measured frequency within its operating range and make sure the instrument is operated in its linear range.
- c. Set the SA on MaxHold Mode, and then keep the EUT in hopping mode. Record all the signals from each channel until each one has been recorded.
- d. Set the SA on View mode and then plot the result on SA screen.
- e. Repeat above procedures until all frequencies measured were complete.

#### 4.3.5 DEVIATION FROM TEST STANDARD

No deviation.

#### 4.3.6 TEST RESULTS

There are 79 hopping frequencies in the hopping mode. Please refer to next page for the test result. On the plot, it shows that the hopping frequencies are equally spaced.



A D T

# 8DPSK

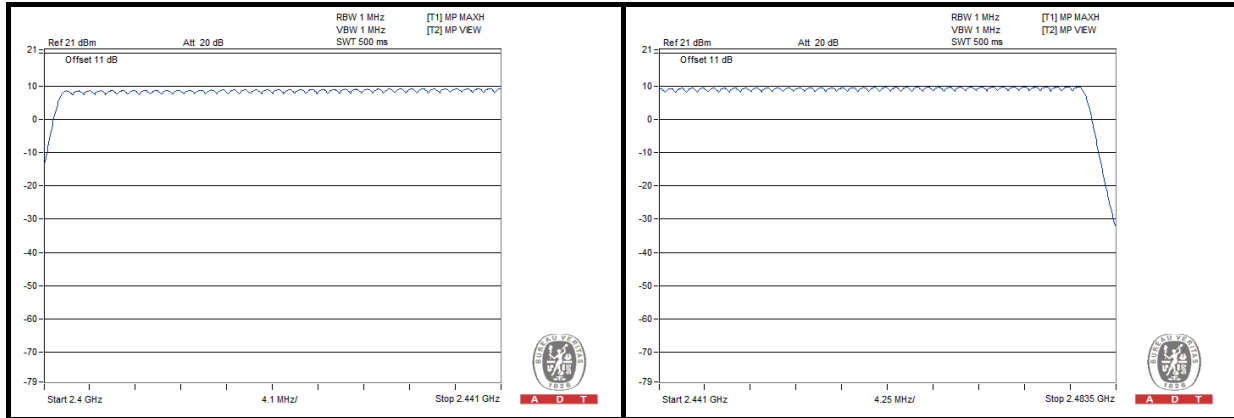

## 4.4 DWELL TIME ON EACH CHANNEL

### 4.4.1 LIMITS OF DWELL TIME USED

The average time of occupancy on any channel shall not be greater than 0.4 seconds within a period of 0.4 seconds multiplied by the number of hopping channels employed.

### 4.4.2 TEST SETUP

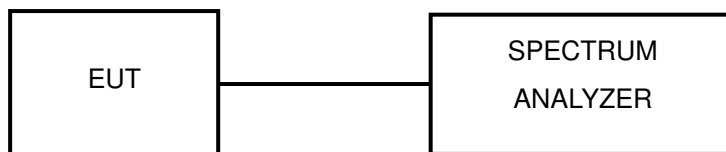

### 4.4.3 TEST INSTRUMENTS

Refer to section 4.1.2 to get information of above instrument.

### 4.4.4 TEST PROCEDURES

- a. Check the calibration of the measuring instrument (SA) using either an internal calibrator or a known signal from an external generator.
- b. Turn on the EUT and connect its antenna terminal to measurement via a low loss cable. Then set it to any one measured frequency within its operating range and make sure the instrument is operated in its linear range.
- c. Adjust the center frequency of SA on any frequency be measured and set SA to zero span mode. And then, set RBW and VBW of spectrum analyzer to proper value.
- d. Measure the time duration of one transmission on the measured frequency. And then plot the result with time difference of this time duration.
- e. Repeat above procedures until all different time-slot modes have been completed.

### 4.4.5 DEVIATION FROM TEST STANDARD

No deviation.



A D T

#### 4.4.6 TEST RESULTS

##### GFSK

Mode	Average Hopping Channel	Package Transfer Time (usec)	Result (sec)	Limit (sec)
DH1	10.00	475.96	0.15	0.4
DH3	5.00	1714.74	0.27	0.4
DH5	3.40	2996.80	0.32	0.4

##### NOTE:

1. Dwell Time=79(channels) x 0.4(s) x average hopping channel x package transfer time
2. 79 channels come from the Hopping Channel number
3. Average Hopping Channel = hops/sweep time
4. t: Package Transfer Time(us)
5. Test plots of the transmitting time slot are shown as below.



A D T

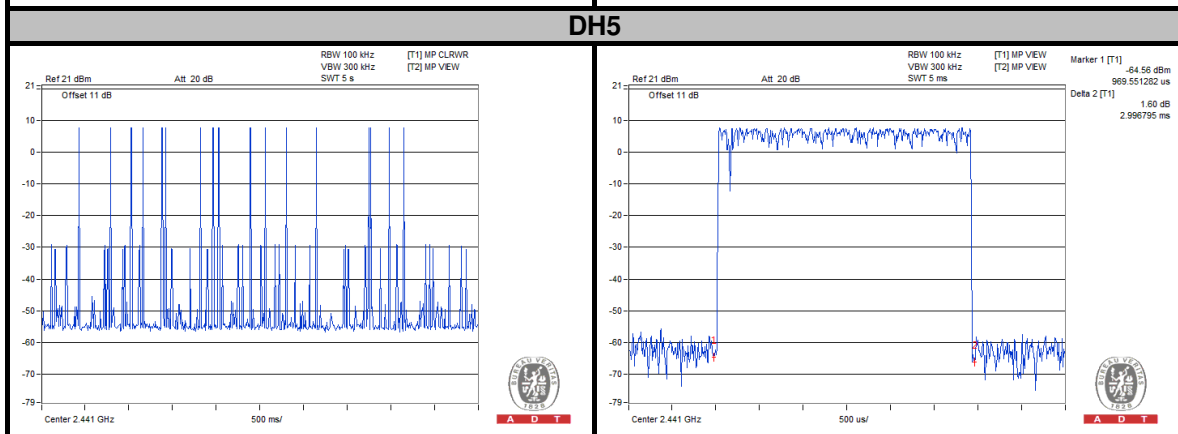
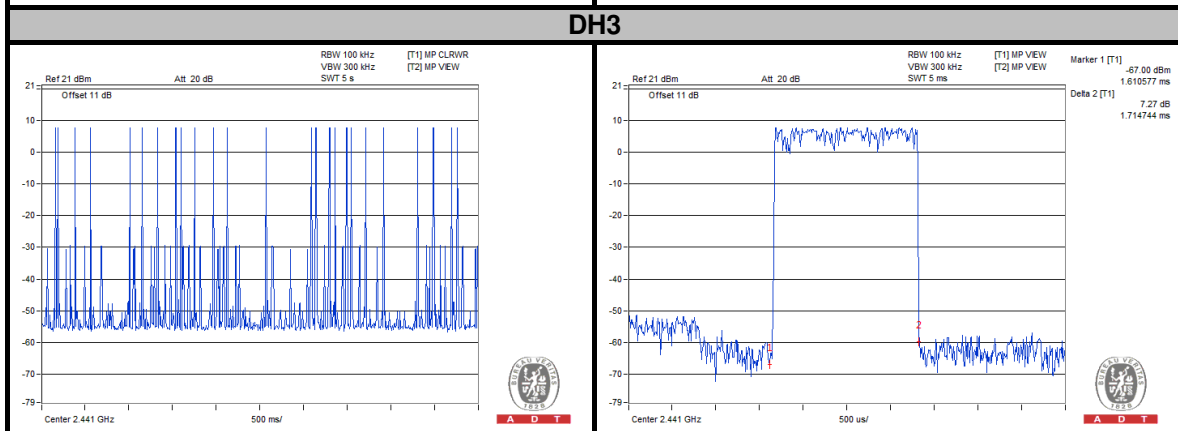
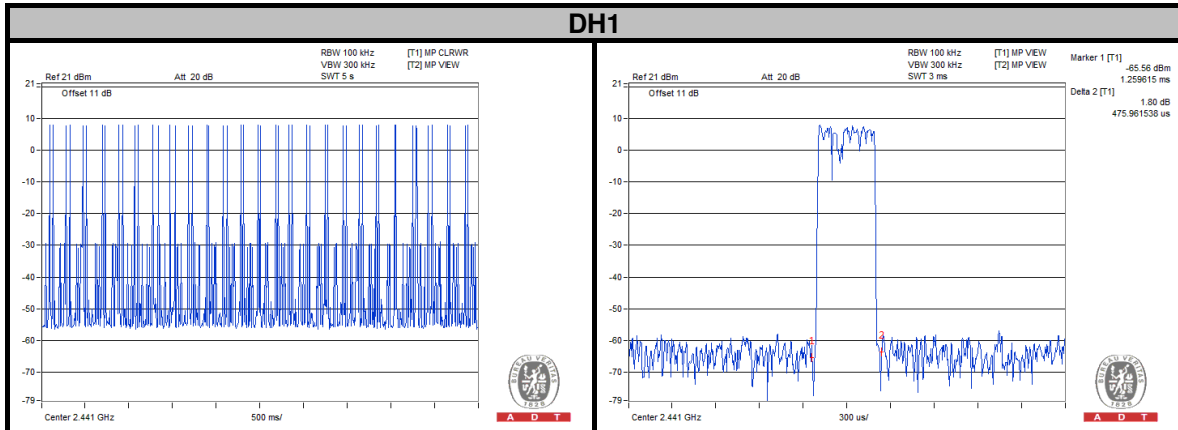





A D T

#### $\pi/4$ -DQPSK

Mode	Average Hopping Channel	Package Transfer Time (usec)	Result (sec)	Limit (sec)
DH1	10.00	461.54	0.15	0.4
DH3	5.00	1690.71	0.27	0.4
DH5	3.60	2940.71	0.33	0.4

**NOTE:**

1. Dwell Time=79(channels) x 0.4(s) x average hopping channel x package transfer time
2. 79 channels come from the Hopping Channel number
3. Average Hopping Channel = hops/sweep time
4. t: Package Transfer Time(us)
5. Test plots of the transmitting time slot are shown as below.



A D T

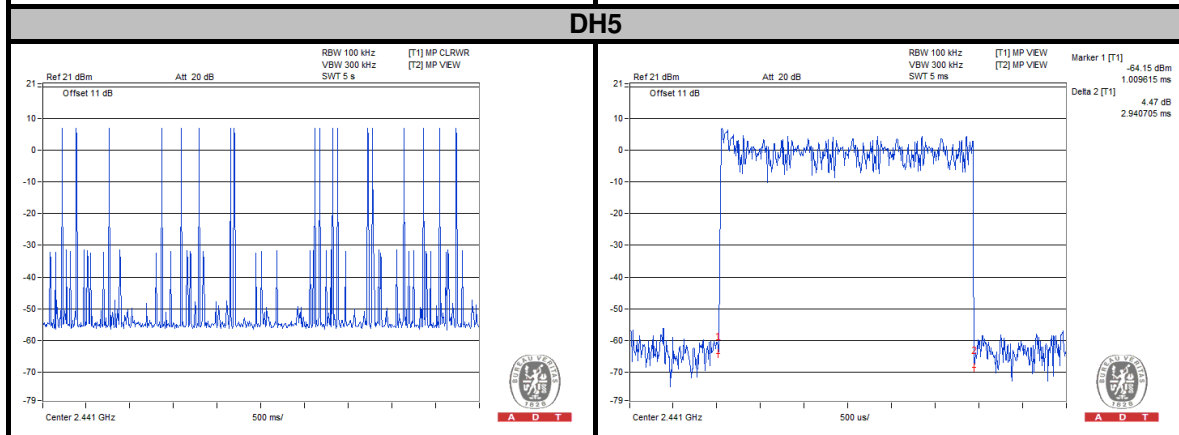
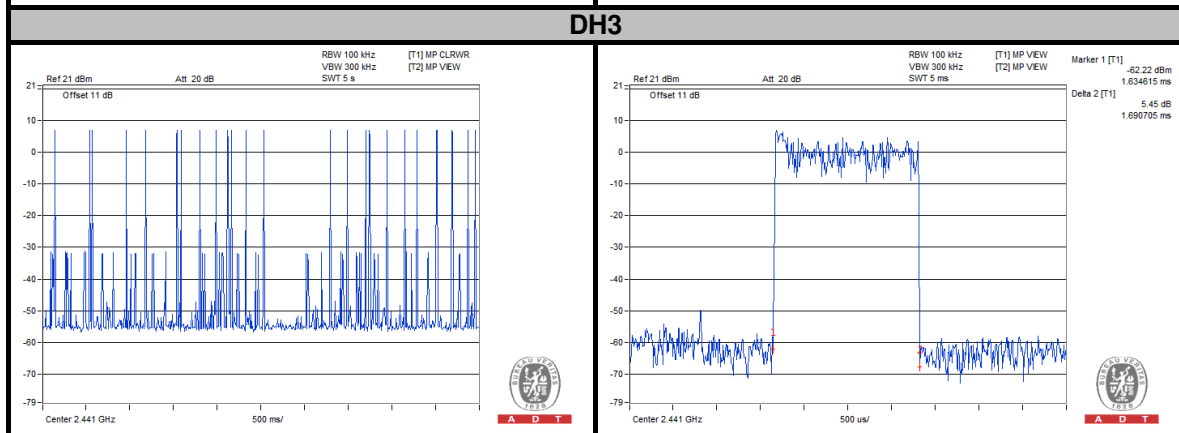
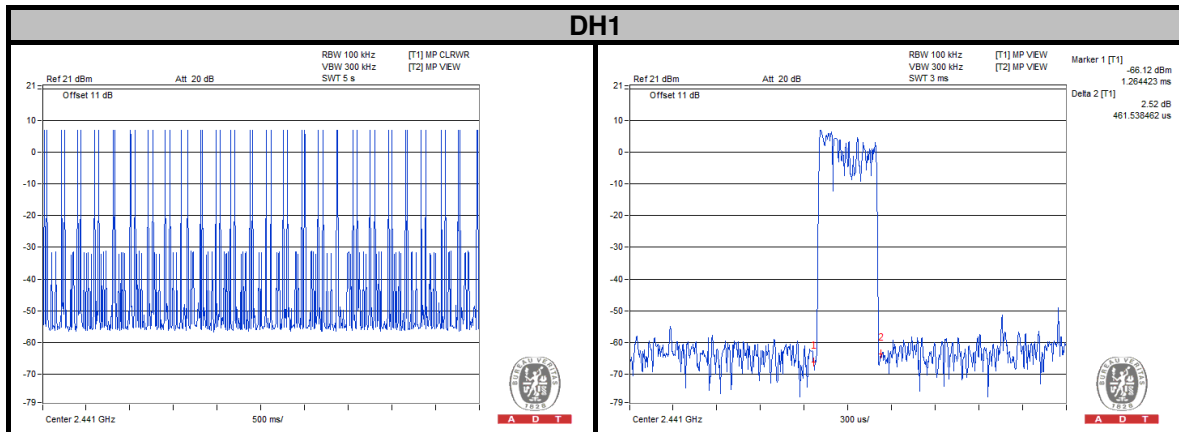



A D T

### 8DPSK

Mode	Average Hopping Channel	Package Transfer Time (usec)	Result (sec)	Limit (sec)
DH1	10.20	456.73	0.15	0.4
DH3	5.20	1714.74	0.28	0.4
DH5	3.20	2948.72	0.30	0.4

**NOTE:**

1. Dwell Time=79(channels) x 0.4(s) x average hopping channel x package transfer time
2. 79 channels come from the Hopping Channel number
3. Average Hopping Channel = hops/sweep time
4. t: Package Transfer Time(us)
5. Test plots of the transmitting time slot are shown as below.



A D T

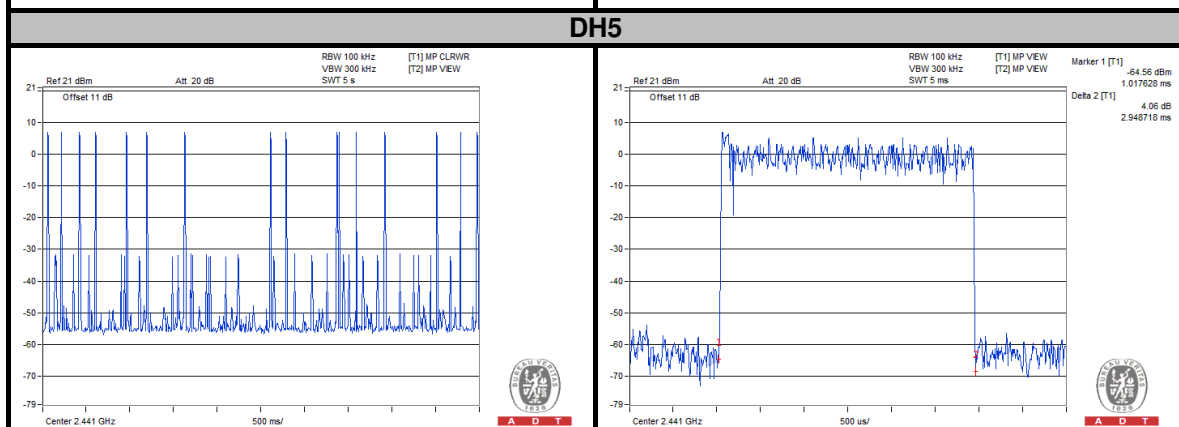
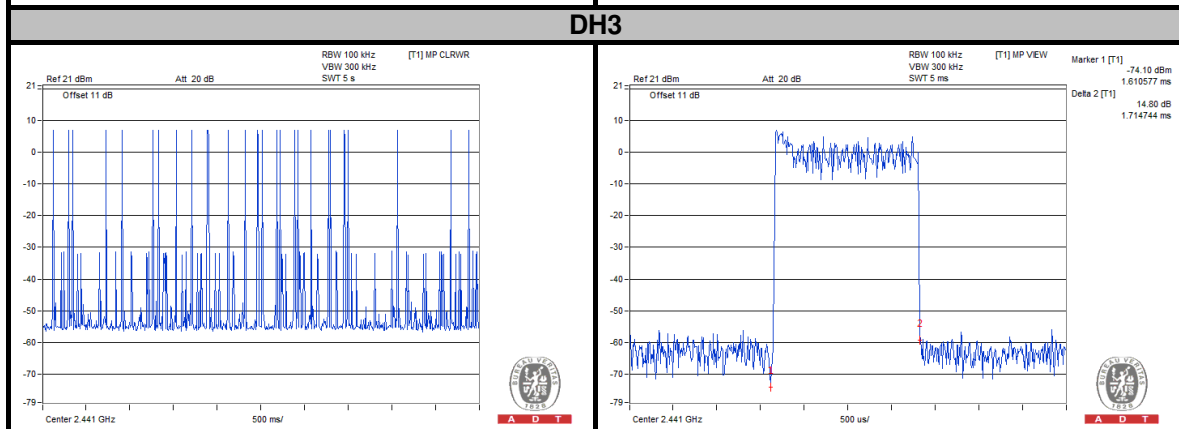
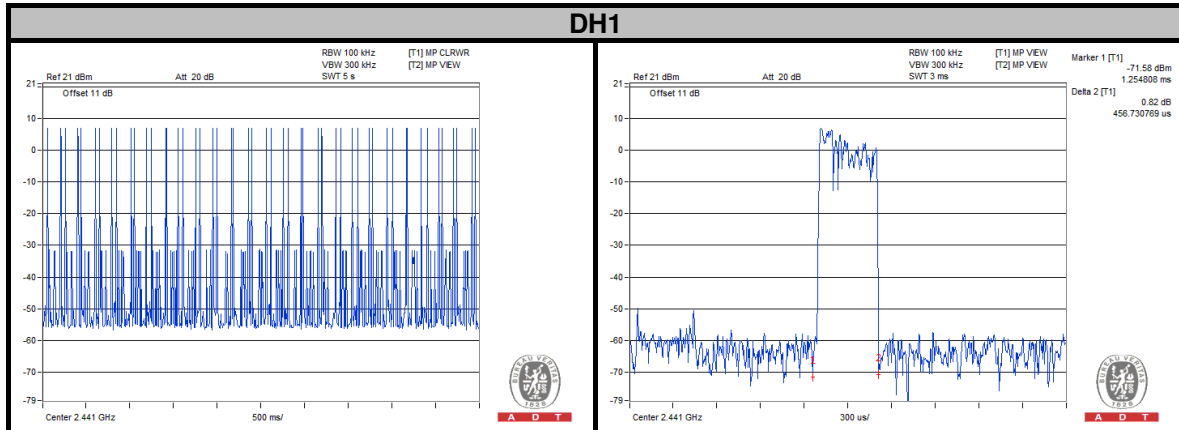

## 4.5 CHANNEL BANDWIDTH

### 4.5.1 LIMITS OF CHANNEL BANDWIDTH

For frequency hopping system operating in the 2400-2483.5MHz, If the 20dB bandwidth of hopping channel is greater than 25kHz, two-thirds 20dB bandwidth of hopping channel shall be a minimum limit for the hopping channel separation.

### 4.5.2 TEST SETUP

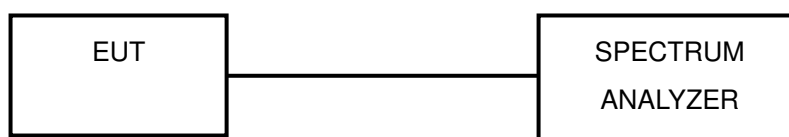

### 4.5.3 TEST INSTRUMENTS

Refer to section 4.1.2 to get information of above instrument.

### 4.5.4 TEST PROCEDURE

- a. Check the calibration of the measuring instrument using either an internal calibrator or a known signal from an external generator.
- b. Turn on the EUT and connect it to measurement instrument. Then set it to any one convenient frequency within its operating range. Set a reference level on the measuring instrument equal to the highest peak value.
- c. Measure the frequency difference of two frequencies that were attenuated 20dB from the reference level. Record the frequency difference as the emission bandwidth.
- d. Repeat above procedures until all frequencies measured were complete.

### 4.5.5 DEVIATION FROM TEST STANDARD

No deviation.

### 4.5.6 EUT OPERATING CONDITION

The software provided by client enabled the EUT to transmit and receive data at lowest, middle and highest channel frequencies individually.



A D T

### 4.5.7 TEST RESULTS

CHANNEL	FREQUENCY (MHz)	20dB BANDWIDTH (MHz)		
		GFSK	$\pi/4$ -DQPSK	8DPSK
0	2402	0.963	1.33	1.31
39	2441	1.02	1.32	1.31
78	2480	1.02	1.33	1.31

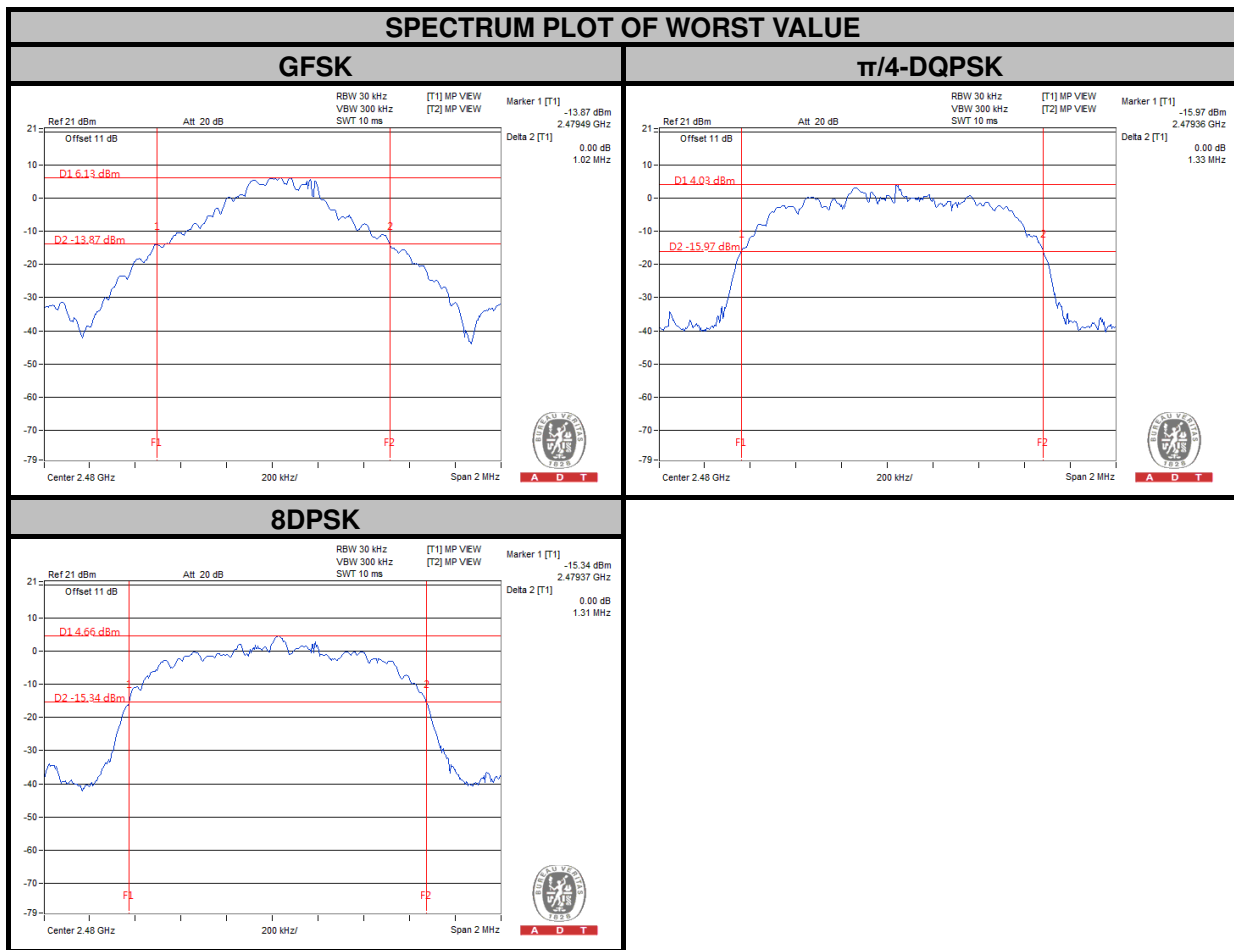

## 4.6 HOPPING CHANNEL SEPARATION

### 4.6.1 LIMITS OF HOPPING CHANNEL SEPARATION

At least 25kHz or two-third of 20dB hopping channel bandwidth (whichever is greater).

### 4.6.2 TEST SETUP

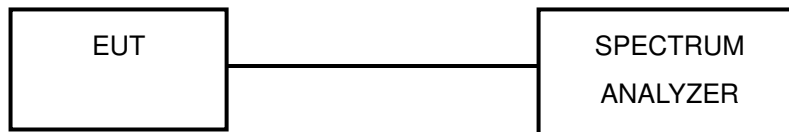

### 4.6.3 TEST INSTRUMENTS

Refer to section 4.1.2 to get information of above instrument.

### 4.6.4 TEST PROCEDURE

- a. Check the calibration of the measuring instrument using either an internal calibrator or a known signal from an external generator.
- b. Turn on the EUT and connect it to measurement instrument. Then set it to any one convenient frequency within its operating range.
- c. By using the MaxHold function record the separation of two adjacent channels.
- d. Measure the frequency difference of these two adjacent channels by SA MARK function. And then plot the result on SA screen.
- e. Repeat above procedures until all frequencies measured were complete.

### 4.6.5 DEVIATION FROM TEST STANDARD

No deviation.



A D T

### 4.6.6 TEST RESULTS

CHAN.	FREQ. (MHz)	ADJACENT CHANNEL SEPARATION (MHz)			20dB BANDWIDTH (MHz)			MINIMUM LIMIT (MHz)			PASS / FAIL
		GFSK	$\pi/4$ -DQPSK	8DPSK	GFSK	$\pi/4$ -DQPSK	8DPSK	GFSK	$\pi/4$ -DQPSK	8DPSK	
0	2402	1.01	1.00	1.00	0.963	1.33	1.31	0.642	0.887	0.873	PASS
39	2441	1.01	1.00	1.00	1.02	1.32	1.31	0.680	0.880	0.873	PASS
78	2480	1.01	1.01	1.00	1.02	1.33	1.31	0.680	0.887	0.873	PASS

**NOTE:**

- The minimum limit is two-third 20dB bandwidth.

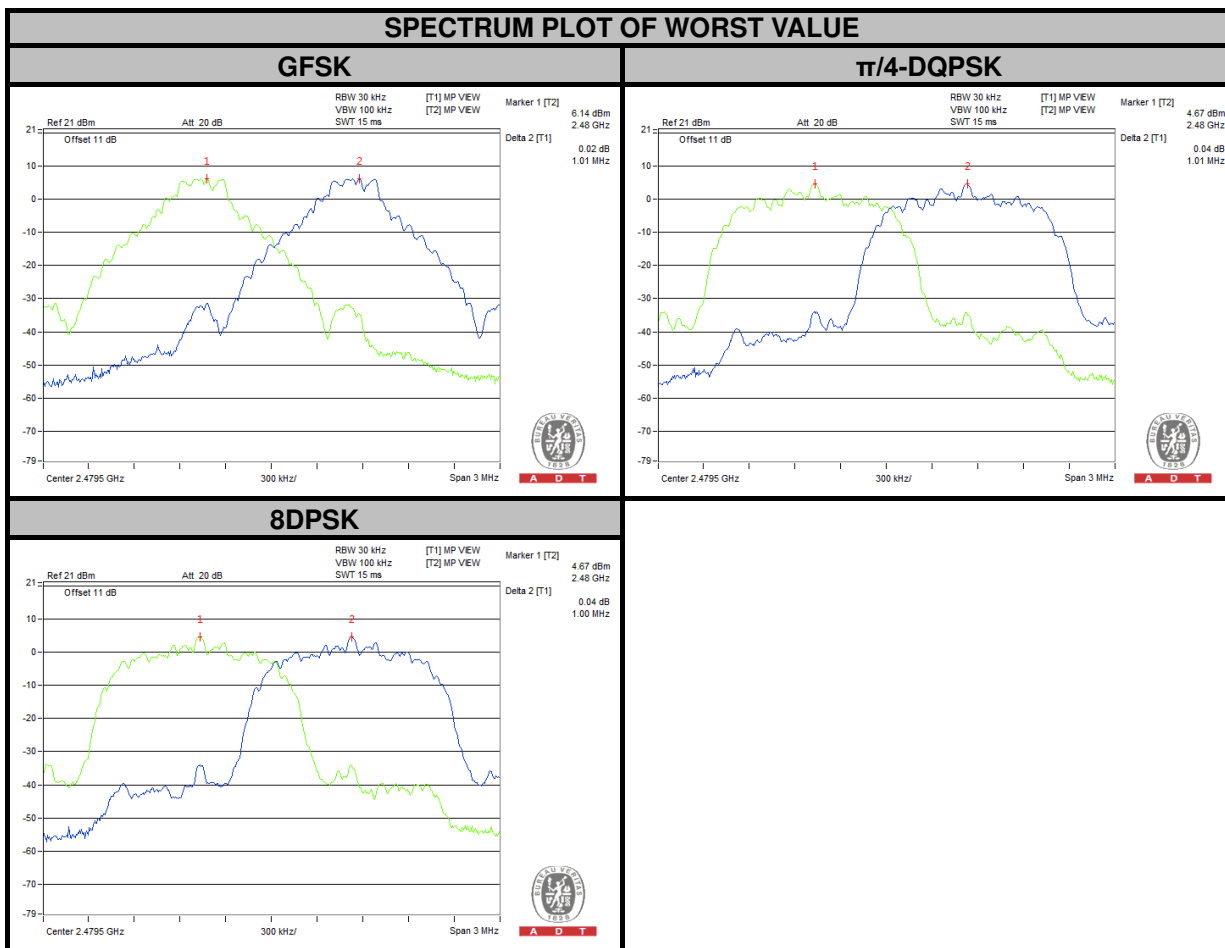



## 4.7 MAXIMUM OUTPUT POWER

### 4.7.1 LIMITS OF MAXIMUM OUTPUT POWER MEASUREMENT

The Maximum Output Power Measurement is 125mW.

### 4.7.2 TEST SETUP

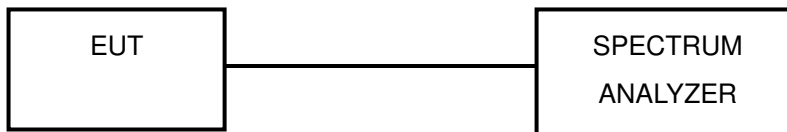

### 4.7.3 TEST INSTRUMENTS

Refer to section 4.1.2 to get information of above instrument.

### 4.7.4 TEST PROCEDURE

- Check the calibration of the measuring instrument using either an internal calibrator or a known signal from an external generator.
- Turn on the EUT and connect it to measurement instrument. Then set it to any one convenient frequency within its operating range. Set a reference level on the measuring instrument equal to the highest peak value.
- The center frequency of the spectrum analyzer is set to the fundamental frequency and using 3MHz RBW and 10 MHz VBW.
- Measure the captured power within the band and recording the plot.
- Repeat above procedures until all frequencies required were complete.

### 4.7.5 DEVIATION FROM TEST STANDARD

No deviation.

### 4.7.6 EUT OPERATING CONDITION

The software provided by client enabled the EUT to transmit and receive data at lowest, middle and highest channel frequencies individually.



A D T

### 4.7.7 TEST RESULTS

CHANNEL	FREQUENCY (MHz)	OUTPUT POWER (mW)			OUTPUT POWER (dBm)			POWER LIMIT (mW)	PASS / FAIL
		GFSK	$\pi/4$ -DQPSK	8DPSK	GFSK	$\pi/4$ -DQPSK	8DPSK		
0	2402	7.780	8.690	9.441	8.91	9.39	9.75	125	PASS
39	2441	9.183	10.375	11.246	9.63	10.16	10.51	125	PASS
78	2480	10.641	11.995	13.062	10.27	10.79	11.16	125	PASS

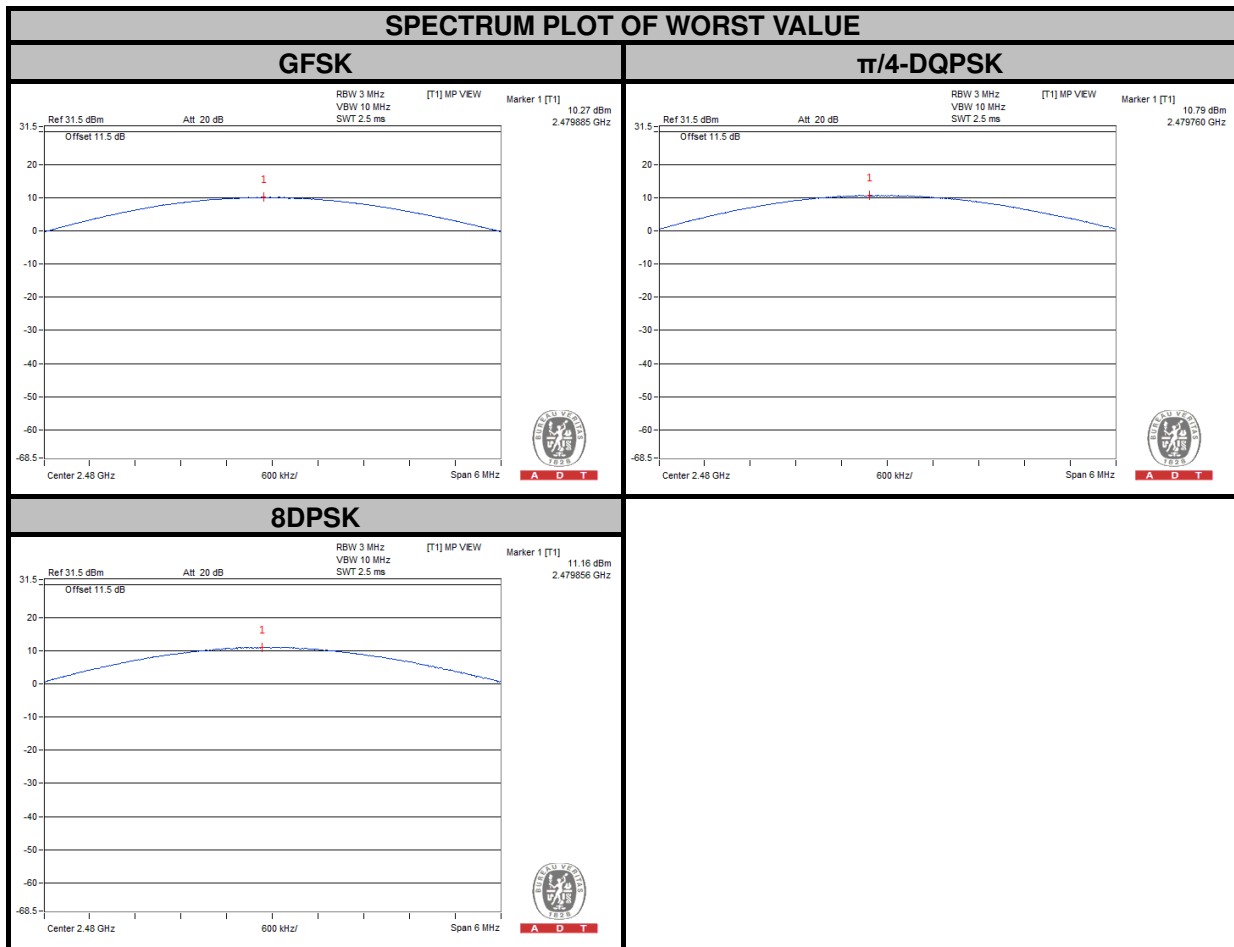



A D T

## **4.8 CONDUCTED OUT OF BAND EMISSION MEASUREMENT**

### **4.8.1 LIMITS OF CONDUCTED OUT OF BAND EMISSION MEASUREMENT**

Below  $-20\text{dB}$  of the highest emission level of operating band (in  $100\text{kHz}$  RBW).

### **4.8.2 TEST INSTRUMENTS**

Refer to section 4.1.2 to get information of above instrument.

### **4.8.3 TEST PROCEDURE**

1. Set RBW =  $100\text{ kHz}$ .
2. Set VBW =  $300\text{ kHz}$ .
3. Set span to encompass the spectrum to be examined.
4. Detector = peak.
5. Trace Mode = max hold.
6. Sweep = auto couple.

### **4.8.4 DEVIATION FROM TEST STANDARD**

No deviation.

### **4.8.5 EUT OPERATING CONDITION**

The software provided by client enabled the EUT to transmit continuously.

### **4.8.6 TEST RESULTS**

The spectrum plots are attached on the following images. D1 line indicates the highest level, D2 line indicates the  $20\text{dB}$  offset below D1. It shows compliance with the requirement.



A D T

# GFSK

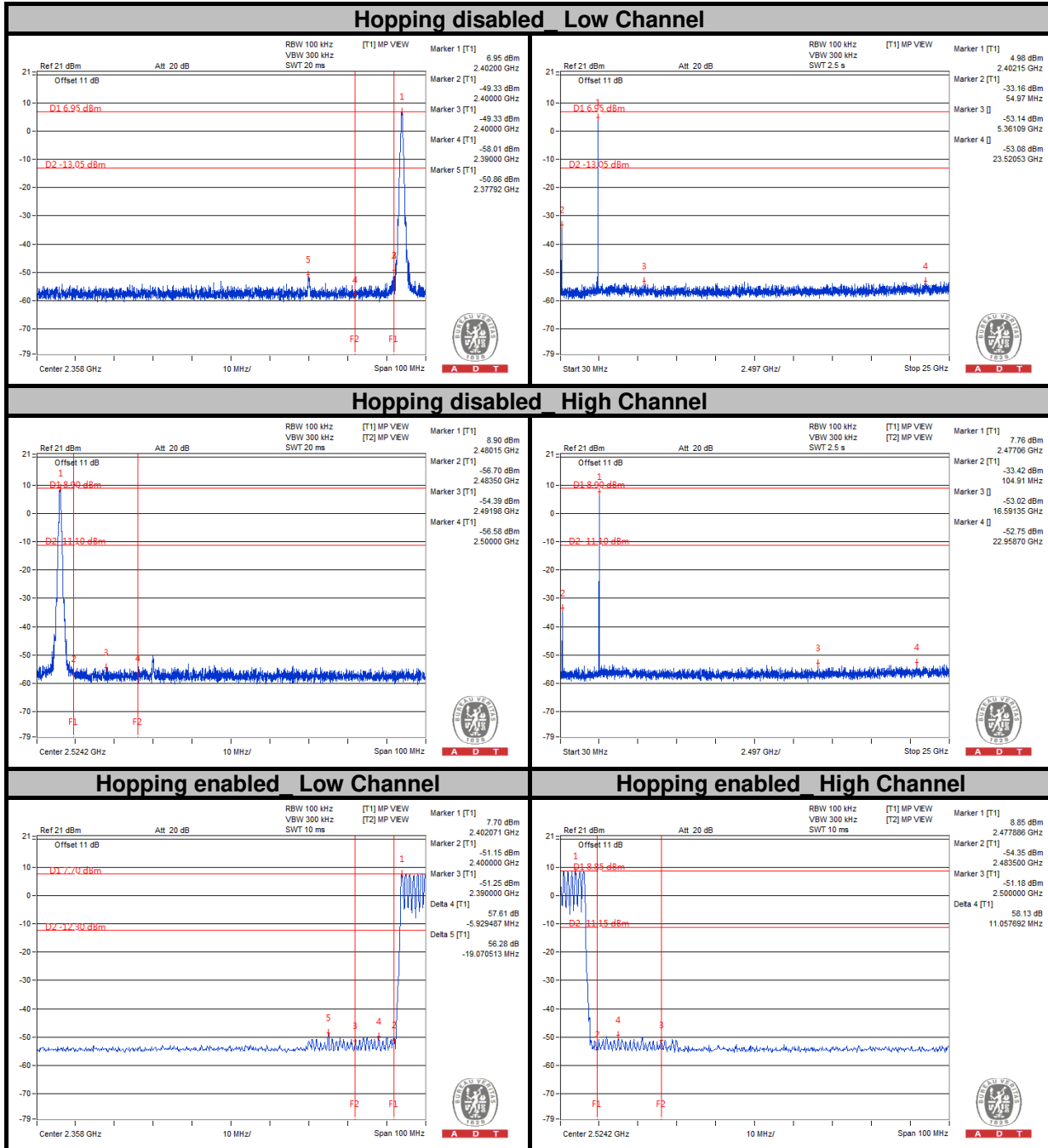



A D T

### $\pi/4$ -DQPSK

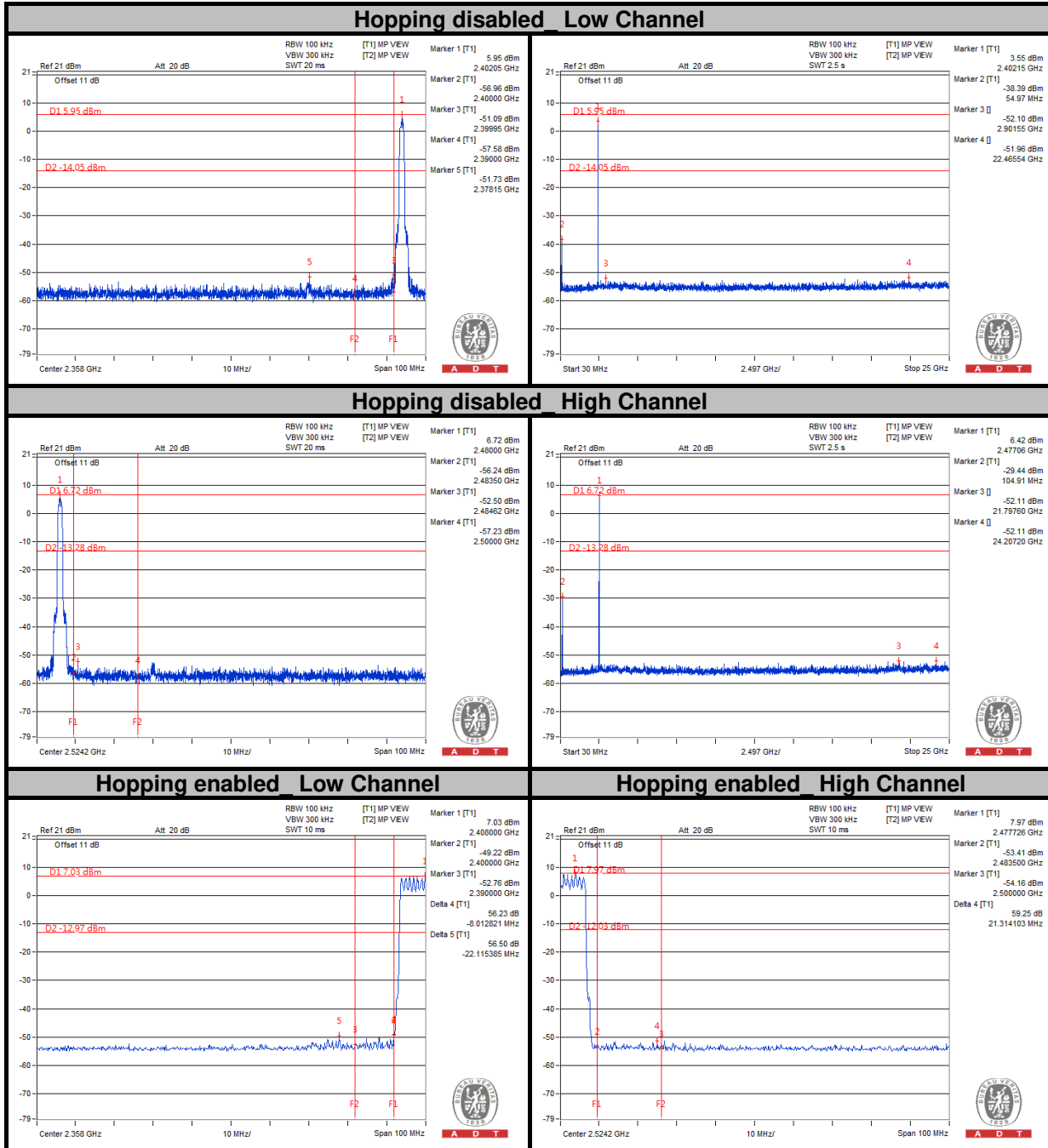



A D T

# 8DPSK

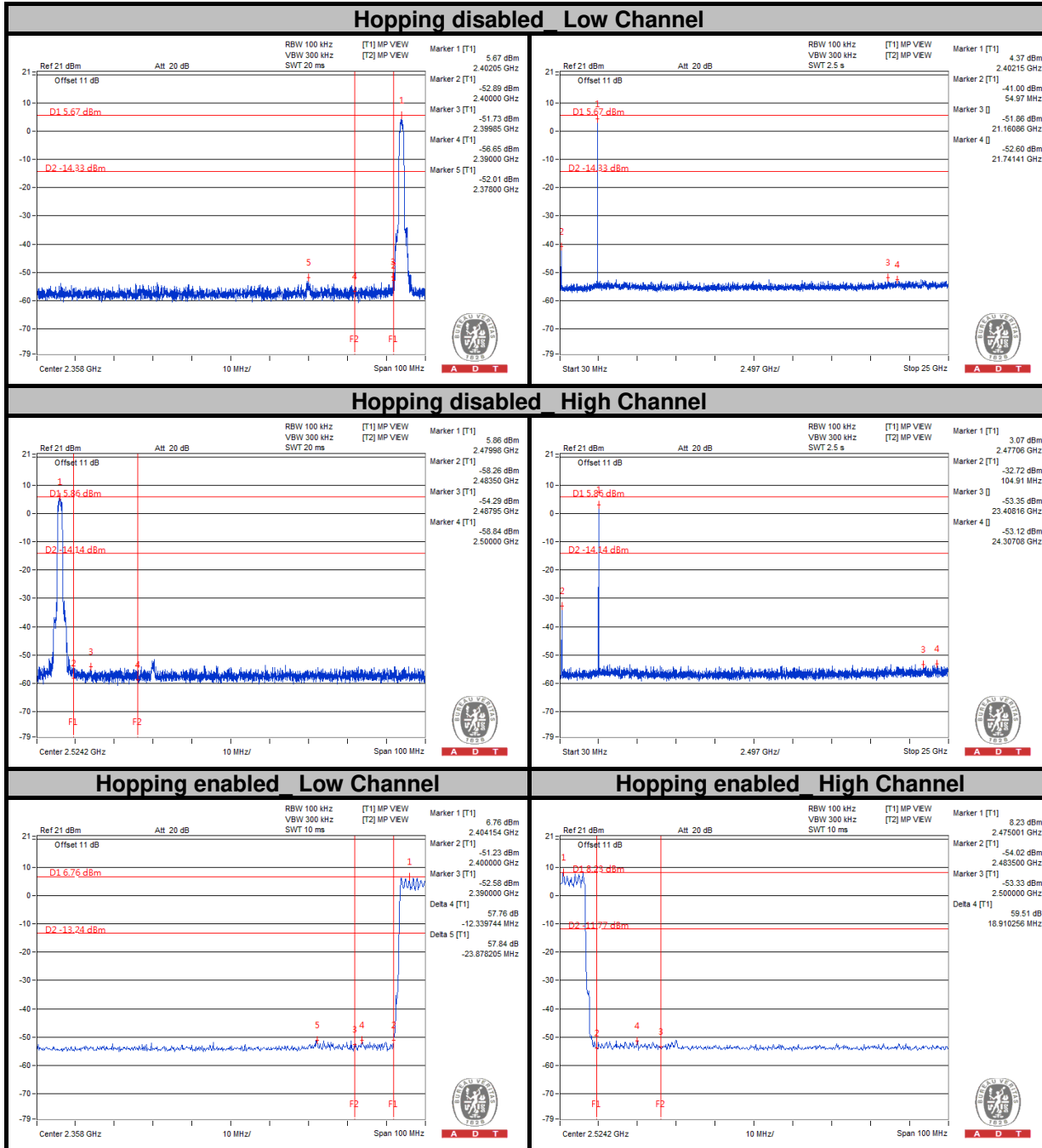

## 5. TEST TYPES AND RESULTS (FOR BLUETOOTH LE 4.0)

### 5.1 RADIATED EMISSION AND BANDEDGE MEASUREMENT

#### 5.1.1 LIMITS OF RADIATED EMISSION AND BANDEDGE MEASUREMENT

Radiated emissions which fall in the restricted bands must comply with the radiated emission limits specified as below table. Other emissions shall be at least 20dB below the highest level of the desired power:

FREQUENCIES (MHz)	FIELD STRENGTH (microvolts/meter)	MEASUREMENT DISTANCE (meters)
0.009 ~ 0.490	2400/F(kHz)	300
0.490 ~ 1.705	24000/F(kHz)	30
1.705 ~ 30.0	30	30
30 ~ 88	100	3
88 ~ 216	150	3
216 ~ 960	200	3
Above 960	500	3

**NOTE:**

1. The lower limit shall apply at the transition frequencies.
2. Emission level (dBuV/m) = 20 log Emission level (uV/m).
3. For frequencies above 1000MHz, the field strength limits are based on average detector, however, the peak field strength of any emission shall not exceed the maximum permitted average limits, specified above by more than 20dB under any condition of modulation.

#### 5.1.2 TEST INSTRUMENTS

Same as section 4.1.2.

### 5.1.3 TEST PROCEDURES

- a. The EUT was placed on the top of a rotating table 0.8 meters above the ground at a 3 meters semi-anechoic chamber. The table was rotated 360 degrees to determine the position of the highest radiation.
- b. The EUT was set 3 meters away from the interference-receiving antenna, which was mounted on the top of a variable-height antenna tower.
- c. Height of receiving antenna is varied from one meter to four meters above the ground to determine the maximum value of the field strength. Both horizontal and vertical polarizations of the antenna are set to make the measurement.
- d. For each suspected emission, the EUT was arranged to its worst case and then the antenna was tuned to heights from 1 meter to 4 meters and the rotatable table was turned from 0 degrees to 360 degrees to find the maximum reading.
- e. The test-receiver system was set to Peak Detect Function and Specified Bandwidth with Maximum Hold Mode.
- f. If the emission level of the EUT in peak mode was lower than the limit specified, then testing could be stopped and the peak values of the EUT would be reported. Otherwise the emissions would be re-tested one by one using peak, quasi-peak or average method as specified and then reported in a data sheet.

#### NOTE:

1. The resolution bandwidth and video bandwidth of test receiver/spectrum analyzer is 120kHz for Quasi-peak detection at frequency below 1GHz.
2. The resolution bandwidth of test receiver/spectrum analyzer is 1MHz and video bandwidth is 3MHz for Peak detection at frequency above 1GHz.
3. The resolution bandwidth of test receiver/spectrum analyzer is 1MHz and the video bandwidth is 10Hz for Average detection (AV) at frequency above 1GHz.
4. All modes of operation were investigated and the worst-case emissions are reported.

### 5.1.4 DEVIATION FROM TEST STANDARD

No deviation.



### 5.1.5 TEST SETUP

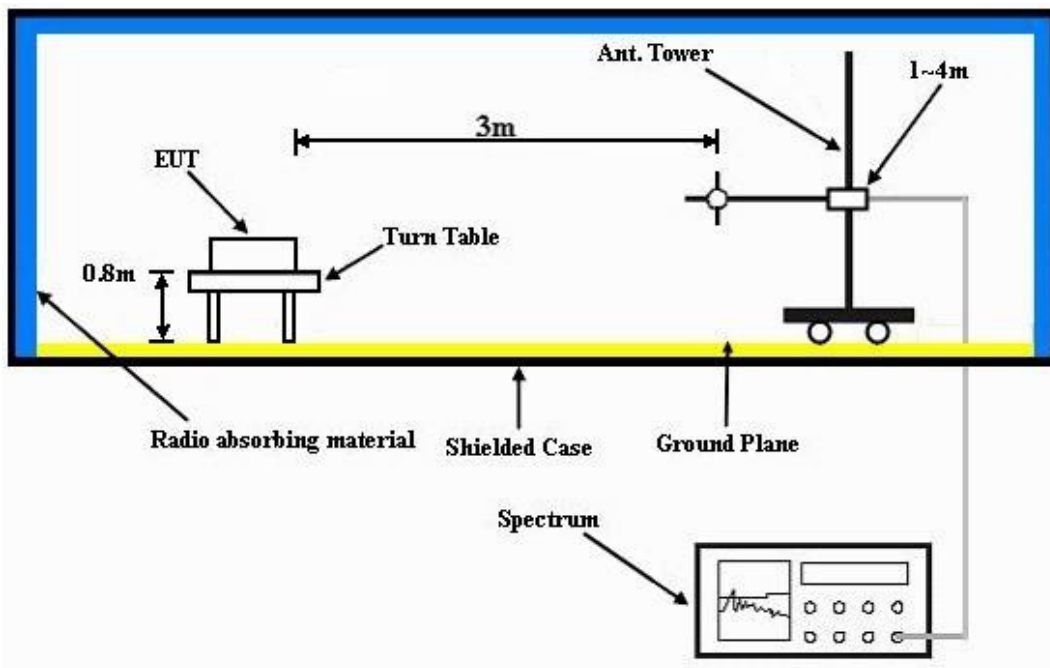

For the actual test configuration, please refer to the attached file (Test Setup Photo).

### 5.1.6 EUT OPERATING CONDITIONS

- a. Placed the EUT on a testing table.
- b. Use the software to control the EUT under transmission condition continuously at specific channel frequency.



A D T

5.1.7 TEST RESULTS

ABOVE 1GHz WORST-CASE DATA

EUT TEST CONDITION		MEASUREMENT DETAIL	
CHANNEL	Channel 0	FREQUENCY RANGE	1GHz ~ 25GHz
INPUT POWER (SYSTEM)	120Vac, 60 Hz	DETECTOR FUNCTION	Peak (PK) Average (AV)
ENVIRONMENTAL CONDITIONS	25deg. C, 65%RH	TESTED BY	Harry Hsueh

ANTENNA POLARITY & TEST DISTANCE: HORIZONTAL AT 3 M

FREQ. (MHz)	EMISSION LEVEL (dBuV/m)	READ LEVEL (dBuV)	LIMIT (dBuV/m)	MARGIN (dB)	ANTENNA FACTOR (dB/m)	CABLE LOSS (dB)	PREAMP FACTOR (dB)	ANTENNA HEIGHT (cm)	TABLE ANGLE (Degree)	REMARK
2368	38.65	37.01	54	-15.35	31.76	5.37	35.49	122	138	Average
2368	56.19	54.55	74	-17.81	31.76	5.37	35.49	122	138	Peak
2402	89.76	88.03			31.8	5.4	35.47	122	138	Average
2402	93.2	91.47			31.8	5.4	35.47	122	138	Peak
2498	39.96	37.94	54	-14.04	31.9	5.53	35.41	122	138	Average
2498	57.47	55.45	74	-16.53	31.9	5.53	35.41	122	138	Peak

ANTENNA POLARITY & TEST DISTANCE: VERTICAL AT 3 M

FREQ. (MHz)	EMISSION LEVEL (dBuV/m)	READ LEVEL (dBuV)	LIMIT (dBuV/m)	MARGIN (dB)	ANTENNA FACTOR (dB/m)	CABLE LOSS (dB)	PREAMP FACTOR (dB)	ANTENNA HEIGHT (cm)	TABLE ANGLE (Degree)	REMARK
2364	39.65	38.02	54	-14.35	31.76	5.37	35.5	105	263	Average
2364	56.83	55.2	74	-17.17	31.76	5.37	35.5	105	263	Peak
2402	93.43	91.7			31.8	5.4	35.47	105	263	Average
2402	97.53	95.8			31.8	5.4	35.47	105	263	Peak
2484	38.91	36.95	54	-15.09	31.88	5.5	35.42	105	263	Average
2484	56.97	55.01	74	-17.03	31.88	5.5	35.42	105	263	Peak

REMARKS:

- Emission Level = Read Level + Antenna Factor + Cable Loss - Preamp Factor  
Margin value = Emission level – Limit value
- 2402MHz: Fundamental frequency.



A D T

EUT TEST CONDITION		MEASUREMENT DETAIL	
CHANNEL	Channel 19	FREQUENCY RANGE	1GHz ~ 25GHz
INPUT POWER (SYSTEM)	120Vac, 60 Hz	DETECTOR FUNCTION	Peak (PK) Average (AV)
ENVIRONMENTAL CONDITIONS	25deg. C, 65%RH	TESTED BY	Harry Hsueh

ANTENNA POLARITY & TEST DISTANCE: HORIZONTAL AT 3 M										
FREQ. (MHz)	EMISSION LEVEL (dBuV/m)	READ LEVEL (dBuV)	LIMIT (dBuV/m)	MARGIN (dB)	ANTENNA FACTOR (dB/m)	CABLE LOSS (dB)	PREAMP FACTOR (dB)	ANTENNA HEIGHT (cm)	TABLE ANGLE (Degree)	REMARK
2360	38.65	37.02	54	-15.35	31.76	5.37	35.5	118	142	Average
2360	55.51	53.88	74	-18.49	31.76	5.37	35.5	118	142	Peak
2440	90.55	88.7			31.85	5.46	35.46	118	142	Average
2440	93.97	92.12			31.85	5.46	35.46	118	142	Peak
2494	40.65	38.63	54	-13.35	31.9	5.53	35.41	118	142	Average
2494	55.47	53.45	74	-18.53	31.9	5.53	35.41	118	142	Peak
ANTENNA POLARITY & TEST DISTANCE: VERTICAL AT 3 M										
FREQ. (MHz)	EMISSION LEVEL (dBuV/m)	READ LEVEL (dBuV)	LIMIT (dBuV/m)	MARGIN (dB)	ANTENNA FACTOR (dB/m)	CABLE LOSS (dB)	PREAMP FACTOR (dB)	ANTENNA HEIGHT (cm)	TABLE ANGLE (Degree)	REMARK
2318	39.56	38.05	54	-14.44	31.73	5.3	35.52	100	231	Average
2318	55.27	53.76	74	-18.73	31.73	5.3	35.52	100	231	Peak
2440	95.88	94.03			31.85	5.46	35.46	100	231	Average
2440	98.87	97.02			31.85	5.46	35.46	100	231	Peak
2498	38.96	36.94	54	-15.04	31.9	5.53	35.41	100	231	Average
2498	55.81	53.79	74	-18.19	31.9	5.53	35.41	100	231	Peak

**REMARKS:**

- Emission Level = Read Level + Antenna Factor + Cable Loss - Preamp Factor  
Margin value = Emission level – Limit value
- 2440MHz: Fundamental frequency.



A D T

EUT TEST CONDITION		MEASUREMENT DETAIL	
CHANNEL	Channel 39	FREQUENCY RANGE	1GHz ~ 25GHz
INPUT POWER (SYSTEM)	120Vac, 60 Hz	DETECTOR FUNCTION	Peak (PK) Average (AV)
ENVIRONMENTAL CONDITIONS	25deg. C, 65%RH	TESTED BY	Harry Hsueh

ANTENNA POLARITY & TEST DISTANCE: HORIZONTAL AT 3 M										
FREQ. (MHz)	EMISSION LEVEL (dBuV/m)	READ LEVEL (dBuV)	LIMIT (dBuV/m)	MARGIN (dB)	ANTENNA FACTOR (dB/m)	CABLE LOSS (dB)	PREAMP FACTOR (dB)	ANTENNA HEIGHT (cm)	TABLE ANGLE (Degree)	REMARK
2364	40.65	39.02	54	-13.35	31.76	5.37	35.5	180	0	Average
2364	57.44	55.81	74	-16.56	31.76	5.37	35.5	180	0	Peak
2480	90.05	88.09			31.88	5.5	35.42	180	0	Average
2480	94.1	92.14			31.88	5.5	35.42	180	0	Peak
2496	40.99	38.97	54	-13.01	31.9	5.53	35.41	180	0	Average
2496	56.76	54.74	74	-17.24	31.9	5.53	35.41	180	0	Peak
ANTENNA POLARITY & TEST DISTANCE: VERTICAL AT 3 M										
FREQ. (MHz)	EMISSION LEVEL (dBuV/m)	READ LEVEL (dBuV)	LIMIT (dBuV/m)	MARGIN (dB)	ANTENNA FACTOR (dB/m)	CABLE LOSS (dB)	PREAMP FACTOR (dB)	ANTENNA HEIGHT (cm)	TABLE ANGLE (Degree)	REMARK
2366	38.65	37.01	54	-15.35	31.76	5.37	35.49	101	236	Average
2366	55.81	54.17	74	-18.19	31.76	5.37	35.49	101	236	Peak
2480	95.62	93.66			31.88	5.5	35.42	101	236	Average
2480	99.24	97.28			31.88	5.5	35.42	101	236	Peak
<b>2483.5</b>	<b>41.91</b>	<b>39.95</b>	<b>54</b>	<b>-12.09</b>	<b>31.88</b>	<b>5.5</b>	<b>35.42</b>	<b>101</b>	<b>236</b>	<b>Average</b>
2483.5	57.45	55.49	74	-16.55	31.88	5.5	35.42	101	236	Peak

**REMARKS:**

- Emission Level = Read Level + Antenna Factor + Cable Loss - Preamp Factor  
Margin value = Emission level – Limit value
- 2480MHz: Fundamental frequency.



A D T

**BELOW 1GHz WORST-CASE DATA :**

EUT TEST CONDITION		MEASUREMENT DETAIL	
CHANNEL	Channel 39	FREQUENCY RANGE	30MHz ~ 1GHz
INPUT POWER (SYSTEM)	120Vac, 60 Hz	DETECTOR FUNCTION	Peak (PK) Quasi-peak (QP)
ENVIRONMENTAL CONDITIONS	25deg. C, 65%RH	TESTED BY	Harry Hsueh

ANTENNA POLARITY & TEST DISTANCE: HORIZONTAL AT 3 M										
FREQ. (MHz)	EMISSION LEVEL (dBuV/m)	READ LEVEL (dBuV)	LIMIT (dBuV/m)	MARGIN (dB)	ANTENNA FACTOR (dB/m)	CABLE LOSS (dB)	PREAMP FACTOR (dB)	ANTENNA HEIGHT (cm)	TABLE ANGLE (Degree)	REMARK
95.07	27.81	49.22	43.5	-15.69	9.3	1.28	31.99	156	214	Peak
139.89	18.85	40.44	43.5	-24.65	9.3	1.38	32.27	165	210	Peak
172.83	24.54	45.15	43.5	-18.96	10.11	1.52	32.24	155	145	Peak
396.6	21.95	33.88	46	-24.05	17.95	2.34	32.22	156	225	Peak
479.9	24.05	34.69	46	-21.95	18.92	2.56	32.12	132	201	Peak
626.2	22.87	30.01	46	-23.13	22.1	2.93	32.17	145	145	Peak
ANTENNA POLARITY & TEST DISTANCE: VERTICAL AT 3 M										
FREQ. (MHz)	EMISSION LEVEL (dBuV/m)	READ LEVEL (dBuV)	LIMIT (dBuV/m)	MARGIN (dB)	ANTENNA FACTOR (dB/m)	CABLE LOSS (dB)	PREAMP FACTOR (dB)	ANTENNA HEIGHT (cm)	TABLE ANGLE (Degree)	REMARK
47.82	26.39	49.23	40	-13.61	8.48	0.9	32.22	132	125	Peak
90.75	23.91	45.59	43.5	-19.59	8.98	1.11	31.77	165	220	Peak
185.79	19.2	39.44	43.5	-24.3	10.4	1.61	32.25	145	156	Peak
400.1	23.8	35.58	46	-22.2	18.1	2.34	32.22	154	145	Peak
489.7	22.14	32.65	46	-23.86	18.97	2.63	32.11	166	201	Peak
667.5	24.57	30.68	46	-21.43	22.97	3.05	32.13	155	203	Peak

**REMARKS:** Emission Level = Read Level + Antenna Factor + Cable Loss - Preamp Factor  
Margin value = Emission level – Limit value



A D T

## **5.2 CONDUCTED EMISSION MEASUREMENT**

### **5.2.1 LIMITS OF CONDUCTED EMISSION MEASUREMENT**

Same as section 4.2.1.

### **5.2.2 TEST INSTRUMENTS**

Same as section 4.2.2.

### **5.2.3 TEST PROCEDURES**

Same as section 4.2.3.

### **5.2.4 DEVIATION FROM TEST STANDARD**

No deviation.

### **5.2.5 TEST SETUP**

Same as section 4.2.5.

### **5.2.6 EUT OPERATING CONDITIONS**

Same as section 4.1.6.

5.2.7 TEST RESULTS

CONDUCTED WORST-CASE DATA :

PHASE	Line 1	6dB BANDWIDTH	9kHz
-------	--------	---------------	------

No	Freq.	Corr. Factor	Reading Value		Emission Level		Limit		Margin	
	[MHz]		[dB (uV)]		[dB (uV)]		[dB (uV)]		(dB)	
			Q.P.	AV.	Q.P.	AV.	Q.P.	AV.	Q.P.	AV.
1	0.21250	0.28	45.96	35.30	46.24	35.58	63.11	53.11	-16.87	-17.53
2	0.32188	0.29	41.03	26.87	41.32	27.16	59.66	49.66	-18.34	-22.50
3	0.75156	0.32	42.82	26.17	43.14	26.49	56.00	46.00	-12.86	-19.51
4	1.28516	0.35	43.06	28.02	43.41	28.37	56.00	46.00	-12.59	-17.63
<b>5</b>	<b>13.55469</b>	<b>0.52</b>	<b>46.45</b>	<b>42.29</b>	<b>46.97</b>	<b>42.81</b>	<b>60.00</b>	<b>50.00</b>	<b>-13.03</b>	<b>-7.19</b>
6	28.80078	0.46	44.13	41.55	44.59	42.01	60.00	50.00	-15.41	-7.99

REMARKS:

1. Q.P. and AV. are abbreviations of quasi-peak and average individually.
2. The emission levels of other frequencies were very low against the limit.
3. Margin value = Emission level - Limit value
4. Correction factor = Insertion loss + Cable loss
5. Emission Level = Correction Factor + Reading Value

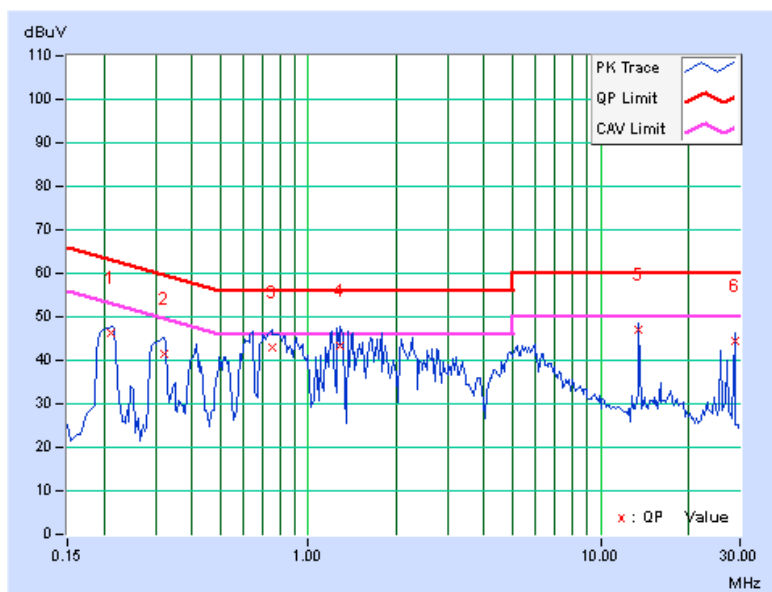

PHASE	Line 2	6dB BANDWIDTH	9kHz
-------	--------	---------------	------

No	Freq. [MHz]	Corr. Factor (dB)	Reading Value		Emission Level		Limit		Margin	
			[dB (uV)]		[dB (uV)]		[dB (uV)]		(dB)	
			Q.P.	AV.	Q.P.	AV.	Q.P.	AV.	Q.P.	AV.
1	0.20469	0.28	34.14	27.23	34.42	27.51	63.42	53.42	-29.00	-25.91
2	0.29063	0.29	33.21	17.90	33.50	18.19	60.51	50.51	-27.01	-32.32
3	0.97031	0.34	35.08	19.78	35.42	20.12	56.00	46.00	-20.58	-25.88
4	1.34375	0.35	39.44	24.60	39.79	24.95	56.00	46.00	-16.21	-21.05
5	13.56250	0.55	44.24	40.05	44.79	40.60	60.00	50.00	-15.21	-9.40
6	27.12109	0.52	38.46	35.57	38.98	36.09	60.00	50.00	-21.02	-13.91

**REMARKS:**

1. Q.P. and AV. are abbreviations of quasi-peak and average individually.
2. The emission levels of other frequencies were very low against the limit.
3. Margin value = Emission level - Limit value
4. Correction factor = Insertion loss + Cable loss
5. Emission Level = Correction Factor + Reading Value

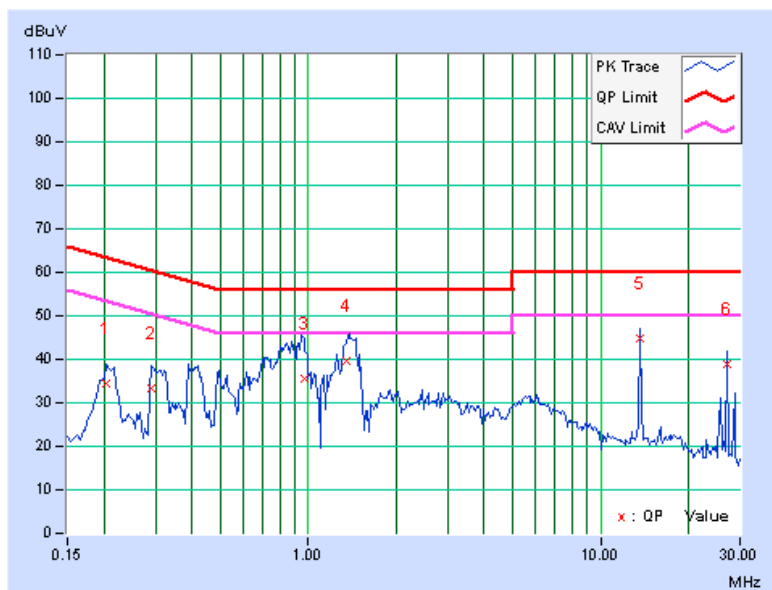



## 5.3 6dB BANDWIDTH MEASUREMENT

### 5.3.1 LIMITS OF 6dB BANDWIDTH MEASUREMENT

The minimum of 6dB Bandwidth Measurement is 0.5MHz.

### 5.3.2 TEST SETUP

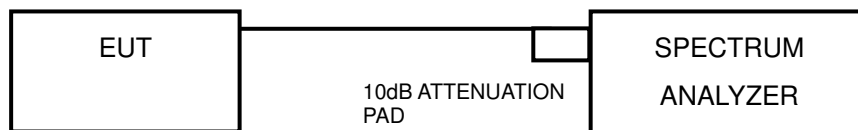

### 5.3.3 TEST INSTRUMENTS

Refer to section 4.1.2 to get information of above instrument.

### 5.3.4 TEST PROCEDURE

1. Set resolution bandwidth (RBW) = approximately 1% of the emission bandwidth
2. Set the video bandwidth (VBW)  $\geq 3 \times$  RBW, Detector = Peak.
3. Trace mode = max hold.
4. Sweep = auto couple.
5. Measure the maximum width of the emission that is constrained by the frequencies associated with the two amplitude points (upper and lower) that are attenuated by 6 dB relative to the maximum level measured in the fundamental emission.

### 5.3.5 DEVIATION FROM TEST STANDARD

No deviation.

### 5.3.6 EUT OPERATING CONDITIONS

The software provided by client to enable the EUT under transmission condition continuously at lowest, middle and highest channel frequencies individually.



A D T

### 5.3.7 TEST RESULTS

CHANNEL	FREQUENCY (MHz)	6dB BANDWIDTH (KHz)	MINIMUM LIMIT (MHz)	PASS / FAIL
0	2402	674.91	0.5	PASS
19	2440	677.76	0.5	PASS
39	2480	676.81	0.5	PASS

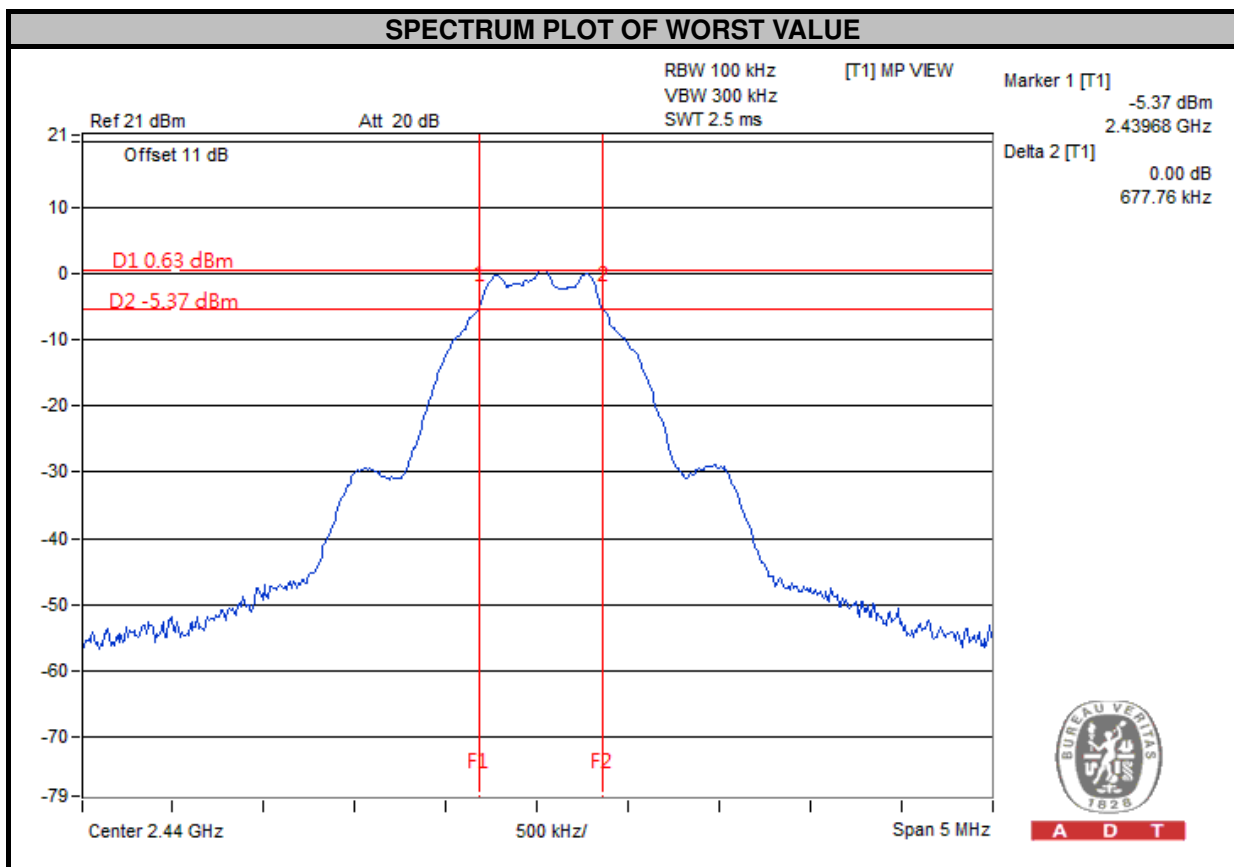

A D T

## 5.4 CONDUCTED OUTPUT POWER

### 5.4.1 LIMITS OF MAXIMUM OUTPUT POWER MEASUREMENT

For systems using digital modulation in the 2400-2483.5 MHz bands: 1 Watt (30dBm).

### 5.4.2 TEST SETUP

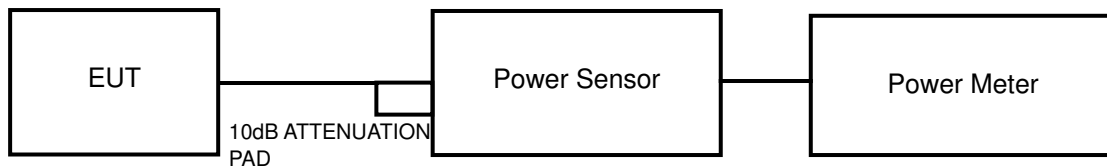

### 5.4.3 INSTRUMENTS

Refer to section 4.1.2 to get information of above instrument.

### 5.4.4 TEST PROCEDURES

A peak power sensor was used on the output port of the EUT. A power meter was used to read the response of the peak power sensor. Record the peak power level.

### 5.4.5 DEVIATION FROM TEST STANDARD

No deviation.

### 5.4.6 EUT OPERATING CONDITIONS

Same as section 4.3.6.

### 5.4.7 TEST RESULTS

CHANNEL	FREQUENCY (MHz)	PEAK POWER (mW)	PEAK POWER (dBm)	LIMIT (dBm)	PASS/FAIL
0	2402	1.122	0.50	30	PASS
19	2440	1.242	0.94	30	PASS
39	2480	1.406	1.48	30	PASS

## 5.5 POWER SPECTRAL DENSITY MEASUREMENT

### 5.5.1 LIMITS OF POWER SPECTRAL DENSITY MEASUREMENT

The Maximum of Power Spectral Density Measurement is 8dBm.

### 5.5.2 TEST SETUP

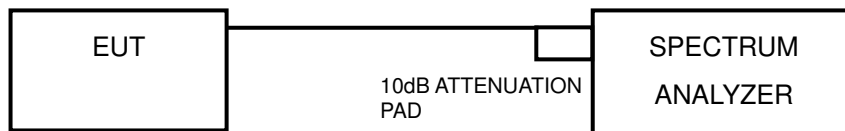

### 5.5.3 TEST INSTRUMENTS

Refer to section 4.1.2 to get information of above instrument.

### 5.5.4 TEST PROCEDURE.

- Set the RBW = 3 kHz, VBW =10 kHz, Detector = peak.
- Sweep time = auto couple, Trace mode = max hold, allow trace to fully stabilize.
- Use the peak marker function to determine the maximum power level in any 100 kHz band segment within the fundamental EBW.

### 5.5.5 DEVIATION FROM TEST STANDARD

No deviation.

### 5.5.6 EUT OPERATING CONDITION

Same as section 4.3.6.



A D T

### 5.5.7 TEST RESULTS

Channel	FREQUENCY (MHz)	PSD (dBm/3kHz)	Limit (dBm/3kHz)	PASS / FAIL
0	2402	-14.88	8	PASS
19	2440	-14.48	8	PASS
39	2480	-14.03	8	PASS

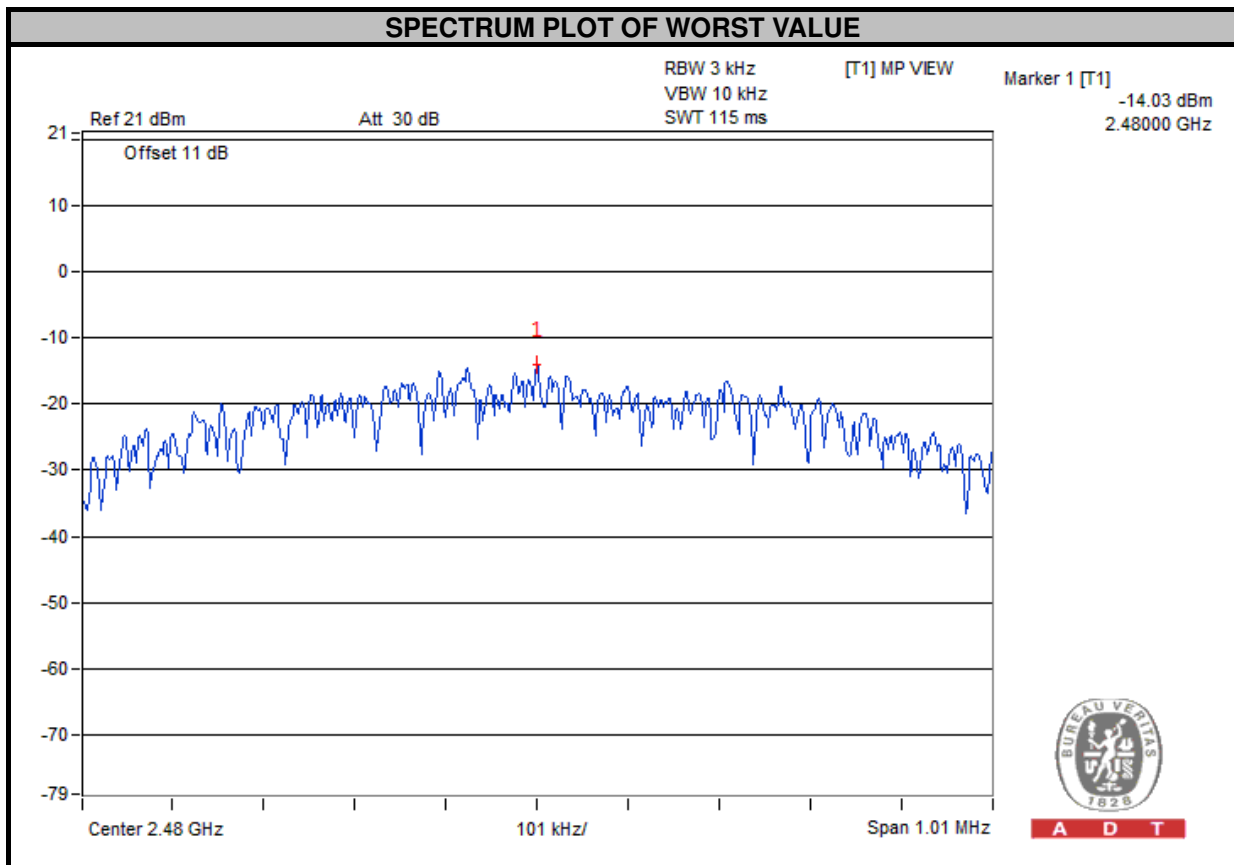

## 5.6 CONDUCTED OUT OF BAND EMISSION MEASUREMENT

### 5.6.1 LIMITS OF OUT OF BAND EMISSION MEASUREMENT

Below  $-20\text{dB}$  of the highest emission level of operating band (in 100kHz Resolution Bandwidth).

### 5.6.2 TEST SETUP

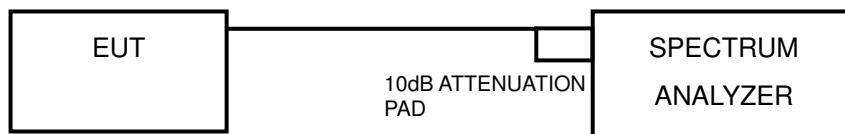

### 5.6.3 TEST INSTRUMENTS

Refer to section 4.1.2 to get information of above instrument.

### 5.6.4 TEST PROCEDURE

#### MEASUREMENT PROCEDURE REF

1. Set the RBW = 100 kHz.
2. Set the VBW  $\geq$  300 kHz.
3. Detector = peak.
4. Sweep time = auto couple.
5. Trace mode = max hold.
6. Allow trace to fully stabilize.
7. Use the peak marker function to determine the maximum power level in any 100 kHz band segment within the fundamental EBW.

#### MEASUREMENT PROCEDURE OOB

1. Set RBW = 100 kHz.
2. Set VBW  $\geq$  300 kHz.
3. Ensure that the number of measurement points  $\geq$  span/RBW
4. According to measurement points to set differ measurement span.
5. Detector = peak.
6. Trace Mode = max hold.
7. Sweep = auto couple.

### 5.6.5 DEVIATION FROM TEST STANDARD

No deviation.

### 5.6.6 EUT OPERATING CONDITION

Same as section 4.3.6.



A D T

### 5.6.7 TEST RESULTS

The spectrum plots are attached on the following images. D1 line indicates the highest level, and D2 line indicates the 20dB offset below D1. It shows compliance with the requirement.

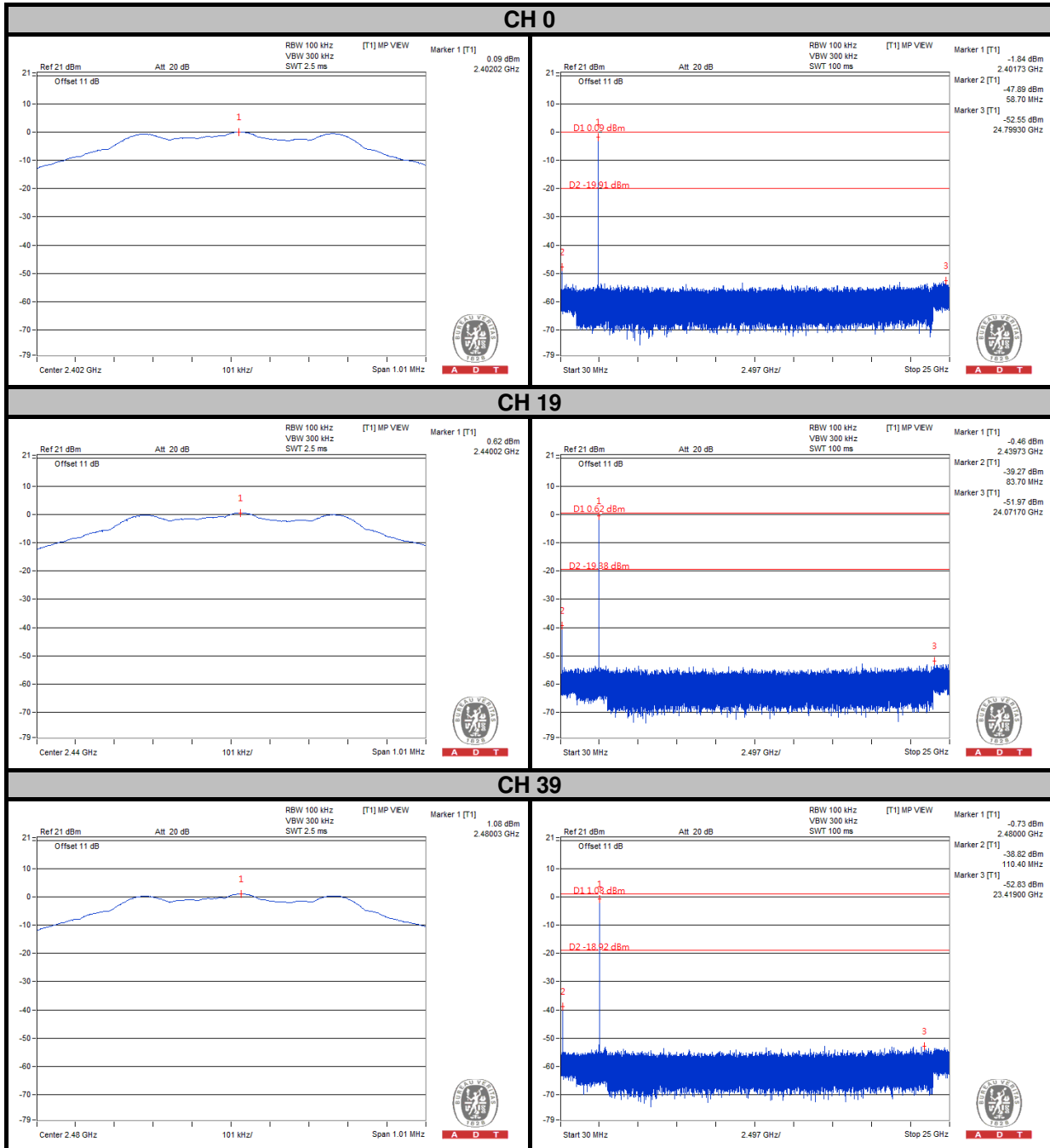



A D T

## 6. PHOTOGRAPHS OF THE TEST CONFIGURATION

Please refer to the attached file (Test Setup Photo).





## 7. INFORMATION ON THE TESTING LABORATORIES

We, Bureau Veritas Consumer Products Services (H.K.) Ltd., Taoyuan Branch, were founded in 1988 to provide our best service in EMC, Radio, Telecom and Safety consultation. Our laboratories are accredited and approved according to ISO/IEC 17025.

If you have any comments, please feel free to contact us at the following:

**Linko EMC/RF Lab:**

Tel: 886-2-26052180

Fax: 886-2-26051924

**Hsin Chu EMC/RF Lab:**

Tel: 886-3-5935343

Fax: 886-3-5935342

**Hwa Ya EMC/RF/Safety Telecom Lab:**

Tel: 886-3-3183232

Fax: 886-3-3270892

**Email:** [service.adt@tw.bureauveritas.com](mailto:service.adt@tw.bureauveritas.com)

**Web Site:** [www.bureauveritas-adt.com](http://www.bureauveritas-adt.com)

The address and road map of all our labs can be found in our web site also.



A D T

## 8. APPENDIX A – MODIFICATIONS RECORDERS FOR ENGINEERING CHANGES TO THE EUT BY THE LAB

No any modifications are made to the EUT by the lab during the test.

---END---