

RF TEST REPORT

Test item : Mobile Phone
Model No. : KYY21
Order No. : DEMC1303-01111
Date of receipt : 2013-03-26
Test duration : 2013-04-15 ~ 2013-05-10
Date of issue : 2013-05-14
Use of report : FCC Original Grant

Applicant : KYOCERA Corporation
2-1-1 Kagahara, Tsuzuki-ku, Yokohama-Shi, Kanagawa 224-8502, Japan

Test laboratory : Digital EMC Co., Ltd.
683-3, Yubang-Dong, Cheoin-Gu, Yongin-Si, Kyunggi-Do, 449-080, Korea

Test specification : §22(H), §24(E)
Test environment : See appended test report
Test result : Pass Fail

The test results presented in this test report are limited only to the sample supplied by applicant and the use of this test report is inhibited other than its purpose. This test report shall not be reproduced except in full, without the written approval of DIGITAL EMC CO., LTD.

Tested by:



Engineer
JaeJin Lee

Witnessed by:

N/A

Reviewed by:



Deputy General Manager
WonJung Lee

Test Report Version

Test Report No.	Date	Description
DRTFCC1305-0494	May. 14, 2013	Initial issue

Table of Contents

1. GENERAL INFORMATION	4
2. INTRODUCTION	5
2.1. EUT DESCRIPTION.....	5
2.2. MEASURING INSTRUMENT CALIBRATION	5
2.3. TEST FACILITY	5
3. DESCRIPTION OF TESTS.....	6
3.1 ERP & EIRP	6
3.2 PEAK TO AVERAGE RATIO	7
3.3 OCCUPIED BANDWIDTH.....	8
3.4 SPURIOUS AND HARMONIC EMISSIONS AT ANTENNA TERMINAL.....	9
3.5 RADIATED SPURIOUS EMISSIONS	10
3.6 FREQUENCY STABILITY / VARIATION OF AMBIENT TEMPERATURE	11
4. LIST OF TEST EQUIPMENT.....	12
5. SUMMARY OF TEST RESULTS	13
6. SAMPLE CALCULATION	14
7. TEST DATA	15
7.1 CONDUCTED OUTPUT POWER	15
7.2 PEAK TO AVERAGE RATIO	17
7.3 OCCUPIED BANDWIDTH	17
7.4 SPURIOUS AND HARMONIC EMISSIONS AT ANTENNA TERMINAL.....	17
7.5 BAND EDGE.....	17
7.6 EFFECTIVE RADIATED POWER.....	18
7.7 EQUIVALENT ISOTROPIC RADIATED POWER.....	19
7.8 RADIATED SPURIOUS EMISSIONS	20
7.8.1 RADIATED SPURIOUS EMISSIONS (GSM850)	20
7.8.2 RADIATED SPURIOUS EMISSIONS (CDMA850).....	21
7.8.3 RADIATED SPURIOUS EMISSIONS (WCDMA850)	22
7.8.4 RADIATED SPURIOUS EMISSIONS (GSM1900)	23
7.9 FREQUENCY STABILITY / VARIATION OF AMBIENT TEMPERATURE	24
7.9.1 FREQUENCY STABILITY (GSM850)	24
7.9.2 FREQUENCY STABILITY (CDMA850).....	25
7.9.3 FREQUENCY STABILITY (WCDMA850)	26
7.9.4 FREQUENCY STABILITY (GSM1900)	27
8. TEST PLOTS.....	28
8.1 Peak to Average Ratio	28
8.2 Occupied Bandwidth 99 % Bandwidth	29
8.3 Spurious Emissions at Antenna Terminal	37
8.4 Band Edge	52

1. GENERAL INFORMATION

Applicant Name: KYOCERA Corporation

Address: 2-1-1 Kagahara, Tsuzuki-ku, Yokohama-Shi, Kanagawa 224-8502, Japan

FCC ID : JOYKYY21

FCC Classification : Licensed Portable Transmitter Held to Ear (PCE)

EUT Type : Mobile Phone

Model Name : KYY21

Add Model Name : N/A

Supplying power : Standard Battery
- Type: Li-Ion Battery
- M/N: KYY21UAA
- Rating: DC 3.8V & 2700mAh 10.3Wh

Antenna Information : Internal Antenna
- Type: Built-In type

Tx Frequency : GSM850: 824.20 ~ 848.80 MHz
GSM1900: 1850.2 ~ 1909.80 MHz
CDMA850: 824.70 ~ 848.31 MHz
WCDMA850: 826.40 ~ 846.60 MHz

Rx Frequency : GSM850: 869.20 ~ 893.80 MHz
GSM1900: 1930.20 ~ 1989.80 MHz
CDMA850: 869.70 ~ 893.31 MHz
WCDMA850: 871.40 ~ 891.60 MHz

Max. RF Output Power : GSM850: 1.517W ERP(31.81dBm)
GSM1900: 1.110W EIRP(30.45dBm)
CDMA850: 0.215W ERP(23.33dBm)
WCDMA850: 0.239W ERP(23.78dBm)

Emission Designator(s) : GSM850: 247KGXW
GSM1900: 249KGXW
CDMA850: 1M27F9W
WCDMA850: 4M15F9W

2. INTRODUCTION

2.1. EUT DESCRIPTION

The Equipment Under Test(EUT) supports a Cellular band(GSM/GPRS/WCDMA/HSDPA/CDMA) and a PCS band(GSM/GPRS) Phone with Bluetooth, WLAN and NFC.

2.2. MEASURING INSTRUMENT CALIBRATION

The measuring equipment, which was utilized in performing the tests documented herein, has been calibrated in accordance with the manufacturer's recommendations for utilizing calibration equipment, which is traceable to recognized national standards.

2.3. TEST FACILITY

The 3&10M test site and conducted measurement facility used to collect the radiated data are located at the 683-3, Yubang-Dong, Yongin-Si, Gyunggi-Do, 449-080, South Korea. The site is constructed in conformance with the requirements.

- 3 & 10M test site registration Number: 678747

3. DESCRIPTION OF TESTS

3.1 ERP & EIRP

(Effective Radiated Power & Equivalent Isotropic Radiated Power)

Test Set-up

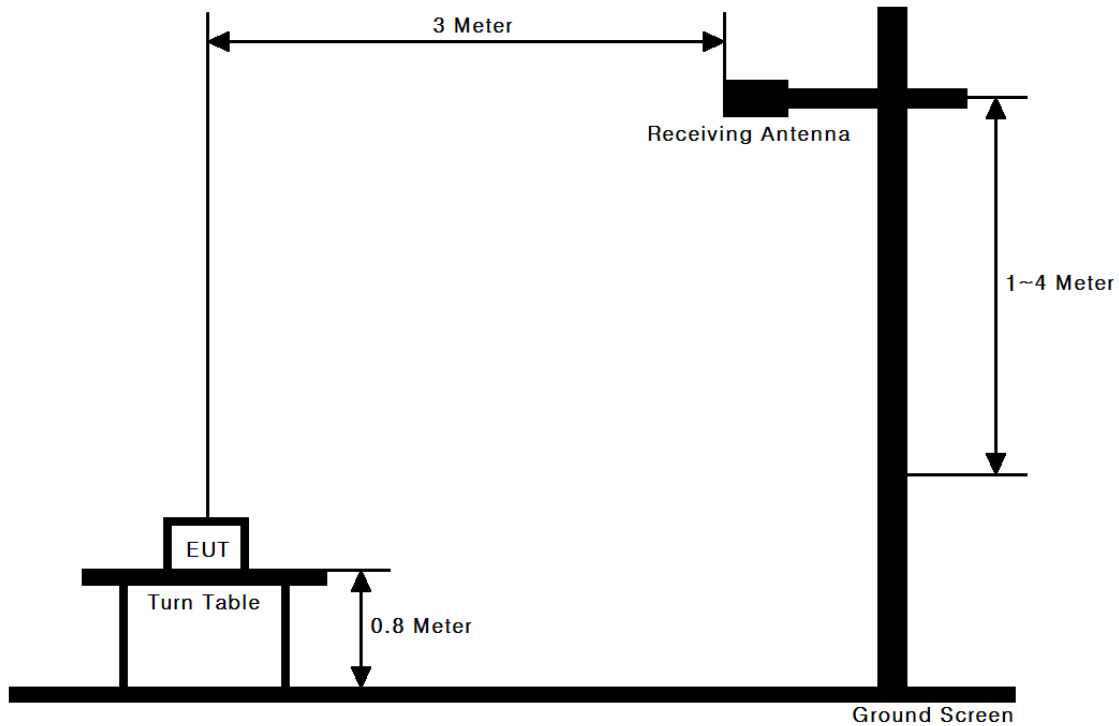

Test Procedure

These measurements were performed at 3&10m test site. The equipment under test is placed on a wooden turntable 0.8-meters above the ground plane and 3-meters from the receive antenna.

The receive antenna height and turntable rotations were adjusted for the highest reading on the receive spectrum analyzer.

A half-wave dipole was substituted in place of the EUT. This dipole antenna was driven by a signal generator and the level of the signal generator was adjusted to obtain the same receive spectrum analyzer reading.

For readings above 1GHz, the above procedure is repeated using horn antennas and the difference between the gain of the horn and an isotropic antenna are taken into consideration.

3.2 PEAK TO AVERAGE RATIO

A peak to average ratio measurement is performed at the conducted port of the EUT. For CDMA and WCDMA signals, the spectrum analyzers Complementary Cumulative Distribution Function (CCDF) measurement profile is used to determine the largest deviation between the average and the peak power of the EUT in a given bandwidth. The CCDF curve shows how much time the peak waveform spends at or above a given average power level. The percent of time the signal spends at or above the level defines the probability for that particular power level.

For GSM signals, an average and a peak trace are used on a spectrum analyzer to determine the largest deviation between the average and the peak power of the EUT in a bandwidth greater than the emission bandwidth. Plots of the EUT's Peak- to- Average Ratio are shown herein.

3.3 OCCUPIED BANDWIDTH.

Test set-up

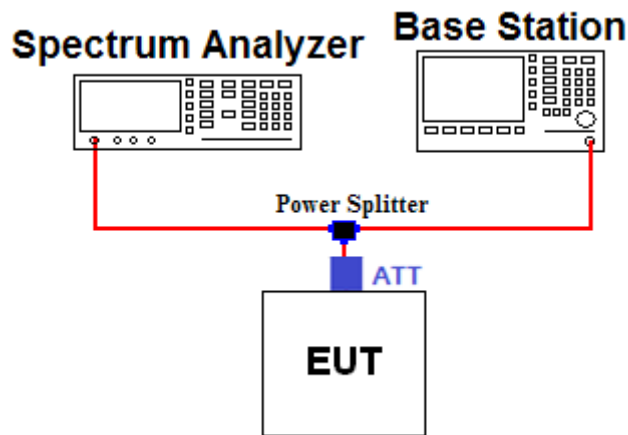

Test Procedure

The EUT was setup to maximum output power at its lowest channel. The occupied bandwidth was measured using a spectrum analyzer. The measurements are repeated for the highest and a middle channel. The EUT's occupied bandwidth is measured as the width of the signal between two points, one below the carrier center frequency and one above the carrier frequency, outside of which all emissions are attenuated at least 26 dB below the transmitter power. Plots of the EUT's occupied bandwidth are shown herein.

3.4 SPURIOUS AND HARMONIC EMISSIONS AT ANTENNA TERMINAL.

Test set-up

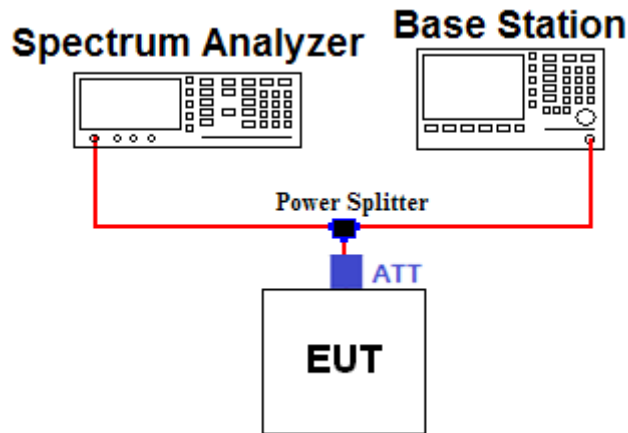

Test Procedure

The level of the carrier and the various conducted spurious and harmonic frequencies is measured by means of a calibrated spectrum analyzer.

The EUT was setup to maximum output power at its lowest channel. The spectrum is scanned from the lowest frequency generated in the equipment up to a frequency including its 10th harmonic. The Resolution BW of the analyzer is set to 1 % of the emission bandwidth to show compliance with -13dBm limit [$43+10\log(P)$], in the 1 MHz bands immediately outside and adjacent to the edge of the frequency block.

A display line was placed at -13dBm to show compliance. The high, lowest and a middle channel were tested for out of band measurements.

Band Edge Requirement

In the 1MHz bands immediately outside and adjacent to the frequency block, a resolution bandwidth of at least 1 percent of the emission bandwidth of the fundamental emission of the transmitter may be employed to measure the out of band Emissions.

3.5 RADIATED SPURIOUS EMISSIONS

Test Set-up

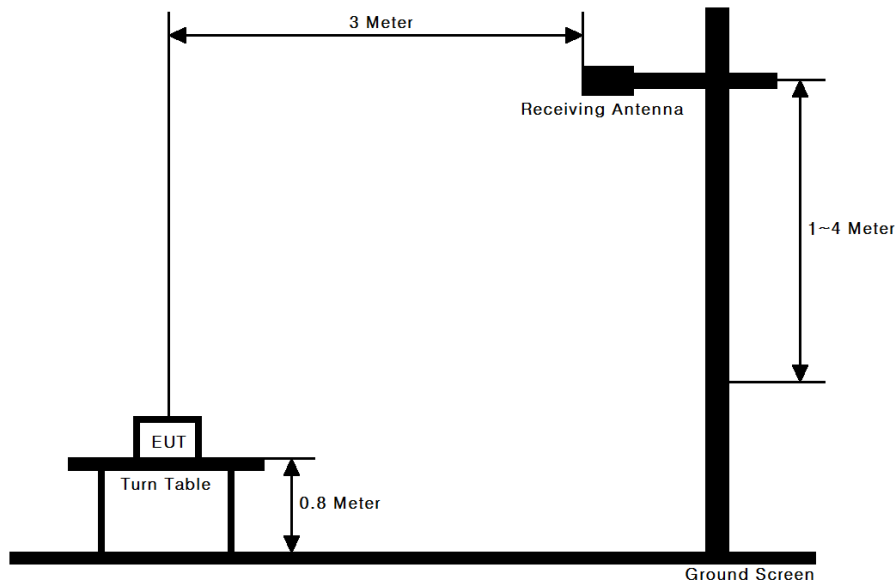

Test Procedure

This measurement was performed at 3meter test range. The equipment under test is placed on a wooden turntable 0.8-meters above the ground plane and 3-meters from the receive antenna.

The receive antenna height and turntable rotations were adjusted for the highest reading on the receive spectrum analyzer.

For radiated power measurements below 1GHz, a half-wave dipole was substituted in place of the EUT. This dipole antenna was driven by a signal generator and the level of the signal generator was adjusted to obtain the same spectrum analyzer reading.

For radiated power measurements above 1GHz, a Horn antenna was substituted in place of the EUT. This Horn antenna was driven by a signal generator and the level of the signal generator was adjusted to obtain the same spectrum analyzer reading. The difference between the gain of the horn and an isotropic antenna are taken into consideration.

This measurement was performed with the EUT oriented in 3 orthogonal axis.

3.6 FREQUENCY STABILITY / VARIATION OF AMBIENT TEMPERATURE

Test Set-up

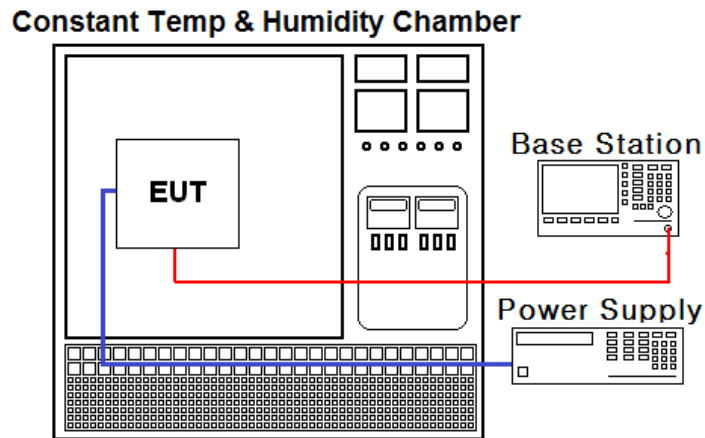

Test Procedure

The frequency stability of the transmitter is measured by:

- a.) **Temperature:** The temperature is varied from - 30 °C to + 50 °C using an environmental chamber.
- b.) **Primary Supply Voltage:** The primary supply voltage is varied from battery end point to 115 % of the voltage normally at the input to the device or at the power supply terminals if cables are not normally supplied.

Specification - the frequency stability shall be sufficient to ensure that the fundamental emission stays within the authorized frequency block. The frequency stability of the transmitter shall be maintained within $\pm 0.00025\%$ (± 2.5 ppm) of the center frequency.

Time Period and Procedure:

The carrier frequency of the transmitter is measured at room temperature. (25°C to provide a reference).

1. The equipment is turned on in a "standby" condition for one minute before applying power to the transmitter. Measurement of the carrier frequency of the transmitter is made within one minute after applying power to the transmitter.
2. Frequency measurements are made at 10°C intervals ranging from -30°C to +50°C. A period of at least one half-hour is provided to allow stabilization of the equipment at each temperature level.

NOTE: The EUT is tested down to the battery endpoint.

4. LIST OF TEST EQUIPMENT

Type	Manufacturer	Model	Cal. Date (yy/mm/dd)	Next. Cal. Date (yy/mm/dd)	S/N
Spectrum Analyzer	Agilent	E4440A	12/10/22	13/10/22	US45303022
8960 Series 10 Wireless Comms. Test Set	Agilent	E5515C	13/02/28	14/02/28	GB43461134
Thermo hygrometer	BODYCOM	BJ5478	13/01/14	14/01/14	090205-4
TEMP & HUMIDITY Chamber	JISCO	KR-100/J-RHC2	12/09/17	13/09/17	30604493/021031
Signal Generator	Rohde Schwarz	SMR20	13/02/27	14/02/27	101251
Vector Signal Generator	Rohde Schwarz	SMJ100A	13/01/08	14/01/08	100148
Amplifier	EMPOWER	BBS3Q7ELU	12/09/18	13/09/18	1020
DC Power Supply	H.P	6622A	13/02/27	14/02/27	3448A03760
Digital Multi-meter	H.P	34401A	13/02/27	14/02/27	3146A13475
Attenuator (3dB)	WEINSCHEL	56-3	12/09/17	13/09/17	Y2342
Attenuator (10dB)	WEINSCHEL	23-10-34	12/09/17	13/09/17	BP4386
Power Splitter	Anritsu	K241B	12/09/17	13/09/17	020611
High-Pass Filter	Wainwright	WHKX1.0	12/09/17	13/09/17	9
High-Pass Filter	Wainwright	WHNX2.1	12/09/17	13/09/17	1
Amplifier (22dB)	H.P	8447E	13/01/08	14/01/08	2945A02865
Amplifier (30dB)	Agilent	8449B	13/02/27	14/02/27	3008A01590
Dipole Antenna	Schwarzbeck	VHA9103	12/03/22	14/03/22	2116
Dipole Antenna	Schwarzbeck	VHA9103	12/03/22	14/03/22	2117
Dipole Antenna	Schwarzbeck	UHA9105	12/03/22	14/03/22	2261
Dipole Antenna	Schwarzbeck	UHA9105	12/03/22	14/03/22	2262
HORN ANT	ETS	3115	11/09/06	13/09/06	21097
HORN ANT	ETS	3115	12/02/20	14/02/20	6419
HORN ANT	A.H.Systems	SAS-574	13/03/20	15/03/20	154
HORN ANT	ETS	3160-09	12/10/22	14/10/22	00102642

5. SUMMARY OF TEST RESULTS

FCC Part Section(s)	RSS Section(s)	Parameter	Status Note 1
2.1046	RSS-132 (4.4) RSS-133 (4.1)	Conducted Output Power	C
22.913(a) 24.232(c)	RSS-132 (4.4) [SRSP-503(5.1.3)] RSS-133 (6.4) [SRSP-510(5.1.2)]	Effective Radiated Power Equivalent Isotropic Radiated Power	C
22.917(a) 24.238(a) 2.1049	RSS-Gen (4.6.1) RSS-133 (2.3)	Occupied Bandwidth	C
22.917(a) 24.238(a) 2.1051	RSS-132 (4.5.1) RSS-133 (6.5.1)	Band Edge Spurious and Harmonic Emissions at Antenna Terminal	C
24.232(d)	RSS-133 (6.4)	Peak to Average Ratio	C
22.917(a) 24.238(a) 2.1053	RSS-132 (4.5.1) RSS-133 (6.5.1)	Radiated Spurious and Harmonic Emissions	C
22.355 24.235 2.1055	RSS-132 (4.3) RSS-133 (6.3)	Frequency Stability	C
<p>Note 1: C=Comply NC=Not Comply NT=Not Tested NA=Not Applicable</p>			

The sample was tested according to the following specification:
 ANSI/TIA/EIA-603-C-2004

6. SAMPLE CALCULATION

A. Emission Designator

GSM850 Emission Designator

Emission Designator = **247KGXW**

GSM OBW = 247.16 kHz

(Measured at the 99.75% power bandwidth)

G = Phase Modulation

X = Cases not otherwise covered

W = Combination (Audio/Data)

GSM1900 Emission Designator

Emission Designator = **249KGXW**

GSM OBW = 248.68 kHz

(Measured at the 99.75% power bandwidth)

G = Phase Modulation

X = Cases not otherwise covered

W = Combination (Audio/Data)

CDMA850 Emission Designator

Emission Designator = **1M27F9W**

CDMA OBW = 1.2702 MHz

(Measured at the 99.75% power bandwidth)

F = Frequency Modulation

9 = Composite Digital Information

W = Combination (Audio/Data)

WCDMA850 Emission Designator

Emission Designator = **4M15F9W**

WCDMA OBW = 4.1532MHz

(Measured at the 99.75% power bandwidth)

F = Frequency Modulation

9 = Composite Digital Information

W = Combination (Audio/Data)

7. TEST DATA

7.1 CONDUCTED OUTPUT POWER

A base station simulator was used to establish communication with the EUT. The base station simulator parameters were set to produce the maximum power from the EUT. This device was tested under all configurations and the highest power is reported. Conducted Output Powers of EUT are reported below.

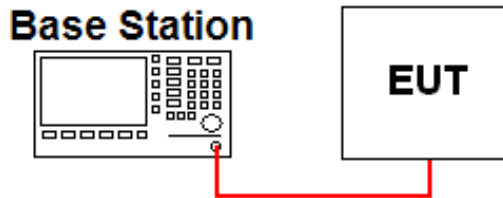

▪ GSM / GPRS

Band	Channel	Test Result(dBm)								
		GSM	GPRS 1 TX Slot	GPRS 2 TX Slot	GPRS 3 TX Slot	GPRS 4 TX Slot	EDGE 1 TX Slot	EDGE 2 TX Slot	EDGE 3 TX Slot	EDGE 4 TX Slot
Cellular	128	32.80	32.80	29.70	28.10	26.80	N/A	N/A	N/A	N/A
	190	32.90	32.80	29.70	28.20	26.90	N/A	N/A	N/A	N/A
	251	32.90	32.90	29.80	28.20	26.90	N/A	N/A	N/A	N/A
PCS	512	29.70	29.60	26.60	24.80	23.60	N/A	N/A	N/A	N/A
	661	29.70	29.70	26.60	24.80	23.70	N/A	N/A	N/A	N/A
	810	29.70	29.60	26.70	24.90	23.70	N/A	N/A	N/A	N/A

The output power was measured using the Agilent E5515C

▪ CDMA

Band	Channel	1X RRT				EvDo (Rev.0)		EvDo (Rev.A)	
		RC1	RC3	FCH+ SCH	FCH	FTAP	RTAP	FETAP	RETAP
		SO55	SO55	TDSO SO32	TDSO SO32				
Cellular	1013	23.42	23.43	23.40	23.42	N/A	N/A	N/A	N/A
	0384	23.45	23.48	23.44	23.47	N/A	N/A	N/A	N/A
	0777	23.38	23.41	23.39	23.41	N/A	N/A	N/A	N/A

The output power was measured using the Agilent E5515C

▪ WCDMA

3GPP Release Version	Mode		Power (dBm)			MPR	B _c	β _d	B _c /β _d	Sub-Test
	Channel		4132	4183	4233					
99	WCDMA	RMC	23.42	23.52	23.58	-	-	-	-	-
		ARM	23.38	23.51	23.57					
5	HSDPA (Cellular)		23.38	23.50	23.55	0	2/15	15/15	2/15	1
5			23.35	23.46	23.53	0	12/15	15/15	12/15	2
5			22.98	23.01	23.02	0.5	15/15	8/15	15/8	3
5			22.95	22.99	23.01	0.5	15/15	4/15	15/4	4

The output power was measured using the Agilent E5515C

7.2 PEAK TO AVERAGE RATIO

- Plots of the EUT’s Peak- to- Average Ratio are shown in Clause 8.1

7.3 OCCUPIED BANDWIDTH

c	Channel	Test Result(KHz)
GSM850	128	247.16
	190	243.01
	251	237.59
CDMA850	1013	1270.20
	384	1267.60
	777	1262.90
WCDMA850	4132	4131.40
	4183	4153.20
	4233	4139.50
GSM1900	512	248.68
	661	242.19
	810	245.99

- Plots of the EUT’s Occupied Bandwidth are shown in Clause 8.2

7.4 SPURIOUS AND HARMONIC EMISSIONS AT ANTENNA TERMINAL

- Plots of the EUT’s Conducted Spurious Emissions are shown in Clause 8.3

7.5 BAND EDGE

- Plots of the EUT’s Band Edge are shown in Clause 8.4

7.6 EFFECTIVE RADIATED POWER

- GSM850 data

CH.	EUT Position (Axis)	TEST CONDITIONS Power Step: 5							
		Reading Value (dBm)	Pol. (H/V)	LEVEL@ TX ANTENNA TERMINAL (dBm)	Antenna Gain (dBd)	ERP (dBm)	ERP (W)	Power Supply	Note.
128	X	-2.61	H	30.10	1.20	31.30	1.349	DC 3.8V	-
190	X	-3.34	H	30.66	1.15	31.81	1.517	DC 3.8V	-
251	Y	-5.57	V	30.57	1.05	31.62	1.452	DC 3.8V	-

- CDMA850 data

CH.	EUT Position (Axis)	TEST CONDITIONS							
		Reading Value (dBm)	Pol. (H/V)	LEVEL@ TX ANTENNA TERMINAL (dBm)	Antenna Gain (dBd)	ERP (dBm)	ERP (W)	Power Supply	Note.
1013	X	-10.61	H	22.13	1.20	23.33	0.215	DC 3.8V	-
384	X	-11.84	H	22.16	1.15	23.31	0.214	DC 3.8V	-
777	Y	-15.03	V	21.14	1.05	22.19	0.166	DC 3.8V	-

- WCDMA850 data

CH.	EUT Position (Axis)	TEST CONDITIONS							
		Reading Value (dBm)	Pol. (H/V)	LEVEL@ TX ANTENNA TERMINAL (dBm)	Antenna Gain (dBd)	ERP (dBm)	ERP (W)	Power Supply	Note.
4132	X	-10.35	H	22.59	1.19	23.78	0.239	DC 3.8V	-
4183	X	-12.11	H	22.15	1.15	23.30	0.214	DC 3.8V	-
4233	X	-12.87	H	21.57	1.10	22.67	0.185	DC 3.8V	-

NOTES:

Effective Radiated Power Output Measurements by Substitution Method according to ANSI/TIA/EIA-603-C-2004, Aug. 17, 2004:

The EUT is placed on a wooden turn table 3-meters from the receive antenna. The receive antenna height and turntable rotation is adjusted for the highest reading on the receive spectrum analyzer. For CDMA signals, a peak detector is used, with RBW = VBW = 3 MHz. For WCDMA signals, a peak detector is used, with RBW = VBW = 5MHz. For AMPS, GSM, and TDMA signals, a peak detector is used, with RBW = VBW = 1 MHz.

A half-wave dipole is substituted in place of the EUT. This dipole antenna is driven by a signal generator and the level of the signal generator is adjusted to obtain the same receive spectrum analyzer reading. The conducted power at the terminals of the dipole is measured. The ERP is recorded.

This device was tested under all configurations and the highest power is reported in GSM mode. This EUT was tested with the fully charged battery. Also, we have done x, y, z planes in EUT and horizontal and vertical polarization of detecting antenna. The worst case data is reported.

7.7 EQUIVALENT ISOTROPIC RADIATED POWER

- GSM1900 data

CH.	EUT Position (Axis)	TEST CONDITIONS Power Step: 0							
		Reading Value (dBm)	Pol. (H/V)	LEVEL@ TX ANTENNA TERMINAL (dBm)	Antenna Gain (dBi)	EIRP (dBm)	EIRP (W)	Power Supply	Note.
512	Y	-9.97	V	21.83	8.62	30.45	1.110	DC 3.8V	GSM
661	Y	-10.42	V	20.75	8.71	29.46	0.883	DC 3.8V	GSM
810	Y	-11.01	V	20.01	8.80	28.81	0.760	DC 3.8V	GSM

NOTES:

Effective Radiated Power Output Measurements by Substitution Method according to ANSI/TIA/EIA-603-C-2004, Aug. 17, 2004:

The EUT is placed on a wooden turn table 3-meters from the receive antenna. The receive antenna height and turntable rotation is adjusted for the highest reading on the receive spectrum analyzer. For CDMA signals, a peak detector is used, with RBW = VBW = 3 MHz. For WCDMA signals, a peak detector is used, with RBW = VBW = 5MHz. For AMPS, GSM, and TDMA signals, a peak detector is used, with RBW = VBW = 1 MHz.

A half-wave dipole is substituted in place of the EUT. This dipole antenna is driven by a signal generator and the level of the signal generator is adjusted to obtain the same receive spectrum analyzer reading. The conducted power at the terminals of the dipole is measured. The ERP is recorded.

This device was tested under all configurations and the highest power is reported in GSM mode. This EUT was tested with the fully charged battery. Also, we have done x, y, z planes in EUT and horizontal and vertical polarization of detecting antenna. The worst case data is reported.

7.8 RADIATED SPURIOUS EMISSIONS

7.8.1 RADIATED SPURIOUS EMISSIONS (GSM850)

Channel (ERP)	Freq. (MHz)	EUT Position (Axis)	POL (H/V)	LEVEL@ ANTENNA TERMINAL (dBm)	SUBSTITUTE ANTENNA GAIN (dBd)	CORRECT GENERATOR LEVEL (dBm)	Result (dBc)	Limit (dBc)
128 (1.349W)	1648.44	Z	H	-57.14	5.88	-51.26	82.56	44.30
	2472.53	Z	V	-62.60	7.11	-55.49	86.79	
	-	-	-	-	-	-	-	
	-	-	-	-	-	-	-	
190 (1.517W)	1673.17	Z	H	-56.38	5.96	-50.42	82.23	44.81
	2509.63	Z	V	-62.23	7.12	-55.11	86.92	
	-	-	-	-	-	-	-	
	-	-	-	-	-	-	-	
251 (1.452W)	1697.77	Z	H	-55.11	6.03	-49.08	80.70	44.62
	2546.41	Z	V	-60.94	7.14	-53.80	85.42	
	-	-	-	-	-	-	-	
	-	-	-	-	-	-	-	

- Limit Calculation = $43 + 10 \log_{10} (\text{ERP [W]})$ [dBc]

- No other spurious and harmonic emissions were reported greater than listed emissions above table.

NOTES:

Effective Radiated Power Output Measurements by Substitution Method according to ANSI/TIA/EIA-603-C-2004, Aug. 17, 2004:

The EUT is placed on a wooden turn table 3-meters from the receive antenna. The receive antenna height and turntable rotation is adjusted for the highest reading on the receive spectrum analyzer.

A half-wave dipole was substituted in place of the EUT. This dipole antenna was driven by a signal generator and the level of the signal generator was adjusted to obtain the same receive spectrum analyzer reading. This spurious level is recorded. For readings above 1GHz, the above procedure is repeated using horn antennas and the difference between the gain of the horn and an isotropic or dipole antenna are taken into consideration.

This device was tested under all configurations and the highest power is reported in GSM mode and using a Power Control Level of "0" in the PCS Band and "5" in the Cellular Band.

This EUT was tested with the fully charged battery. Also, we have done x, y, z planes in EUT and horizontal and vertical polarization of detecting antenna.

The worst case data is reported.

7.8.2 RADIATED SPURIOUS EMISSIONS (CDMA850)

Channel (EIRP)	Freq. (MHz)	EUT Position (Axis)	POL (H/V)	LEVEL@ ANTENNA TERMINAL (dBm)	SUBSTITUTE ANTENNA GAIN (dBd)	CORRECT GENERATOR LEVEL (dBm)	Result (dBc)	Limit (dBc)
1013 (0.215W)	1649.37	Z	V	-61.77	5.89	-55.88	79.21	36.33
	-	-	-	-	-	-	-	
	-	-	-	-	-	-	-	
384 (0.214W)	1673.02	Z	V	-64.54	5.96	-58.58	81.90	36.31
	-	-	-	-	-	-	-	
	-	-	-	-	-	-	-	
777 (0.166W)	1695.91	Z	V	-62.28	6.02	-56.26	78.45	35.19
	-	-	-	-	-	-	-	
	-	-	-	-	-	-	-	

- Limit Calculation = $43 + 10 \log_{10} (ERP [W])$ [dBc]
- No other spurious and harmonic emissions were reported greater than listed emissions above table.

NOTES:

Effective Radiated Power Output Measurements by Substitution Method according to ANSI/TIA/EIA-603-C-2004, Aug. 17, 2004:

The EUT is placed on a wooden turn table 3-meters from the receive antenna. The receive antenna height and turntable rotation is adjusted for the highest reading on the receive spectrum analyzer.

A half-wave dipole was substituted in place of the EUT. This dipole antenna was driven by a signal generator and the level of the signal generator was adjusted to obtain the same receive spectrum analyzer reading. This spurious level is recorded. For readings above 1GHz, the above procedure is repeated using horn antennas and the difference between the gain of the horn and an isotropic or dipole antenna are taken into consideration.

This device was tested under all configurations and the highest power is reported.

This EUT was tested with the fully charged battery. Also, we have done x, y, z planes in EUT and horizontal and vertical polarization of detecting antenna.

The worst case data is reported.

7.8.3 RADIATED SPURIOUS EMISSIONS (WCDMA850)

Channel (EIRP)	Freq. (MHz)	EUT Position (Axis)	POL (H/V)	LEVEL@ ANTENNA TERMINAL (dBm)	SUBSTITUTE ANTENNA GAIN (dBd)	CORRECT GENERATOR LEVEL (dBm)	Result (dBc)	Limit (dBc)
4132 (0.239W)	1651.41	X	H	-63.18	5.89	-57.29	81.07	36.78
	-	-	-	-	-	-	-	
	-	-	-	-	-	-	-	
4183 (0.214W)	1675.80	X	H	-65.11	5.96	-59.15	82.45	36.30
	-	-	-	-	-	-	-	
	-	-	-	-	-	-	-	
4233 (0.185W)	1694.62	X	H	-65.37	6.02	-59.35	82.02	35.67
	-	-	-	-	-	-	-	
	-	-	-	-	-	-	-	

- Limit Calculation = $43 + 10 \log_{10} (ERP [W])$ [dBc]
- No other spurious and harmonic emissions were reported greater than listed emissions above table.

NOTES:

Effective Radiated Power Output Measurements by Substitution Method according to ANSI/TIA/EIA-603-C-2004, Aug. 17, 2004:

The EUT is placed on a wooden turn table 3-meters from the receive antenna. The receive antenna height and turntable rotation is adjusted for the highest reading on the receive spectrum analyzer.

A half-wave dipole was substituted in place of the EUT. This dipole antenna was driven by a signal generator and the level of the signal generator was adjusted to obtain the same receive spectrum analyzer reading. This spurious level is recorded. For readings above 1GHz, the above procedure is repeated using horn antennas and the difference between the gain of the horn and an isotropic or dipole antenna are taken into consideration.

This device was tested under all configurations and the highest power is reported.

This EUT was tested with the fully charged battery. Also, we have done x, y, z planes in EUT and horizontal and vertical polarization of detecting antenna.

The worst case data is reported.

7.8.4 RADIATED SPURIOUS EMISSIONS (GSM1900)

Channel (EIRP)	Freq. (MHz)	EUT Position (Axis)	POL (H/V)	LEVEL@ ANTENNA TERMINAL (dBm)	SUBSTITUTE ANTENNA GAIN (dBi)	CORRECT GENERATOR LEVEL (dBm)	Result (dBc)	Limit (dBc)
512 (1.110W)	3700.38	Y	H	-58.39	9.60	-48.79	79.24	43.45
	-	-	-	-	-	-	-	
	-	-	-	-	-	-	-	
	-	-	-	-	-	-	-	
661 (0.883W)	3760.14	Y	H	-59.35	9.58	-49.77	79.23	42.46
	-	-	-	-	-	-	-	
	-	-	-	-	-	-	-	
	-	-	-	-	-	-	-	
810 (0.760W)	3819.72	Y	H	-57.41	9.55	-47.86	76.66	41.81
	-	-	-	-	-	-	-	
	-	-	-	-	-	-	-	
	-	-	-	-	-	-	-	

- Limit Calculation = 43 + 10 log₁₀ (EIRP [W]) [dBc]

- No other spurious and harmonic emissions were reported greater than listed emissions above table.

NOTES:

Effective Radiated Power Output Measurements by Substitution Method according to ANSI/TIA/EIA-603-C-2004, Aug. 17, 2004:

The EUT is placed on a wooden turn table 3-meters from the receive antenna. The receive antenna height and turntable rotation is adjusted for the highest reading on the receive spectrum analyzer.

A half-wave dipole was substituted in place of the EUT. This dipole antenna was driven by a signal generator and the level of the signal generator was adjusted to obtain the same receive spectrum analyzer reading. This spurious level is recorded. For readings above 1GHz, the above procedure is repeated using horn antennas and the difference between the gain of the horn and an isotropic or dipole antenna are taken into consideration.

This device was tested under all configurations and the highest power is reported in GSM mode and using a Power Control Level of “0” in the PCS Band and “5” in the Cellular Band.

This EUT was tested with the fully charged battery. Also, we have done x, y, z planes in EUT and horizontal and vertical polarization of detecting antenna.

The worst case data is reported.

7.9 FREQUENCY STABILITY / VARIATION OF AMBIENT TEMPERATURE

7.9.1 FREQUENCY STABILITY (GSM850)

OPERATING FREQUENCY : 836,599,988 Hz
 CHANNEL : 190(Mid)
 REFERENCE VOLTAGE : 3.80 V DC
 DEVIATION LIMIT : ± 0.00025 % or 2.5 ppm

VOLTAGE (%)	POWER (V DC)	TEMP (°C)	FREQ (Hz)	Deviation	
				(ppm)	(%)
100%	3.80	+25(Ref)	836,599,988	0.000	0.00000000
100%		-30	836,599,976	-0.014	-0.00000143
100%		-20	836,599,983	-0.006	-0.00000060
100%		-10	836,600,009	0.025	0.00000251
100%		0	836,600,015	0.032	0.00000323
100%		+10	836,600,013	0.030	0.00000299
100%		+20	836,599,988	0.000	0.00000000
100%		+30	836,600,018	0.036	0.00000359
100%		+40	836,600,023	0.042	0.00000418
100%		+50	836,600,011	0.027	0.00000275
85%		3.23	+25	836,599,988	0.000
115%	4.37	+25	836,600,015	0.032	0.00000323
BATT.ENDPOINT	3.20	+25	836,599,990	0.002	0.00000024

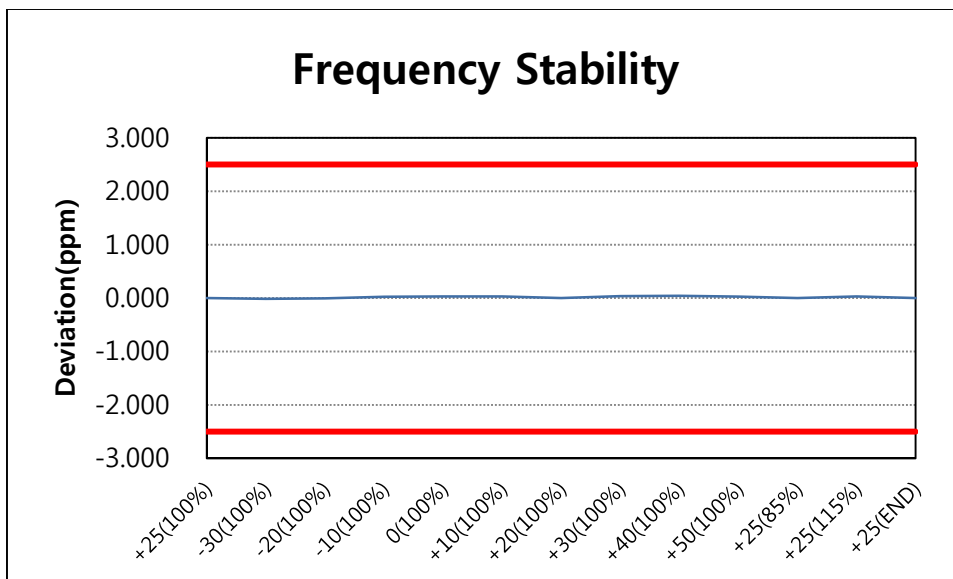

7.9.2 FREQUENCY STABILITY (CDMA850)

OPERATING FREQUENCY : 836,520,001 Hz
 CHANNEL : 384(Mid)
 REFERENCE VOLTAGE : 3.80 V DC
 DEVIATION LIMIT : ± 0.00025 % or 2.5 ppm

VOLTAGE (%)	POWER (V DC)	TEMP (°C)	FREQ (Hz)	Deviation	
				(ppm)	(%)
100%	3.80	+25(Ref)	836,520,001	0.000	0.00000000
100%		-30	836,519,993	-0.010	-0.00000096
100%		-20	836,519,992	-0.011	-0.00000108
100%		-10	836,520,005	0.005	0.00000048
100%		0	836,519,993	-0.010	-0.00000096
100%		+10	836,520,002	0.001	0.00000012
100%		+20	836,520,004	0.004	0.00000036
100%		+30	836,519,994	-0.008	-0.00000084
100%		+40	836,520,005	0.005	0.00000048
100%		+50	836,519,993	-0.010	-0.00000096
85%	3.23	+25	836,520,009	0.010	0.00000096
115%	4.37	+25	836,519,995	-0.007	-0.00000072
BATT.ENDPOINT	3.20	+25	836,520,007	0.007	0.00000072

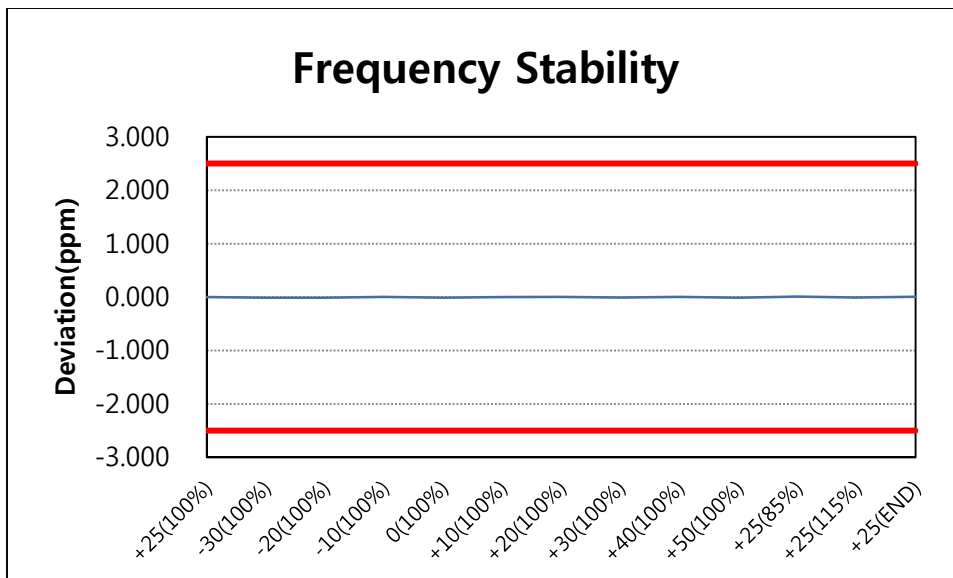

7.9.3 FREQUENCY STABILITY (WCDMA850)

OPERATING FREQUENCY : 836,600,006 Hz
 CHANNEL : 4183(Mid)
 REFERENCE VOLTAGE : 3.80 V DC
 DEVIATION LIMIT : ± 0.00025 % or 2.5 ppm

VOLTAGE (%)	POWER (V DC)	TEMP (°C)	FREQ (Hz)	Deviation	
				(ppm)	(%)
100%	3.80	+25(Ref)	836,600,006	0.000	0.00000000
100%		-30	836,599,995	-0.013	-0.00000131
100%		-20	836,600,007	0.001	0.00000012
100%		-10	836,599,996	-0.012	-0.00000120
100%		0	836,600,004	-0.002	-0.00000024
100%		+10	836,599,992	-0.017	-0.00000167
100%		+20	836,600,006	0.000	0.00000000
100%		+30	836,600,003	-0.004	-0.00000036
100%		+40	836,599,992	-0.017	-0.00000167
100%		+50	836,599,993	-0.016	-0.00000155
85%		3.23	+25	836,600,005	-0.001
115%	4.37	+25	836,600,009	0.004	0.00000036
BATT.ENDPOINT	3.20	+25	836,600,004	-0.002	-0.00000024

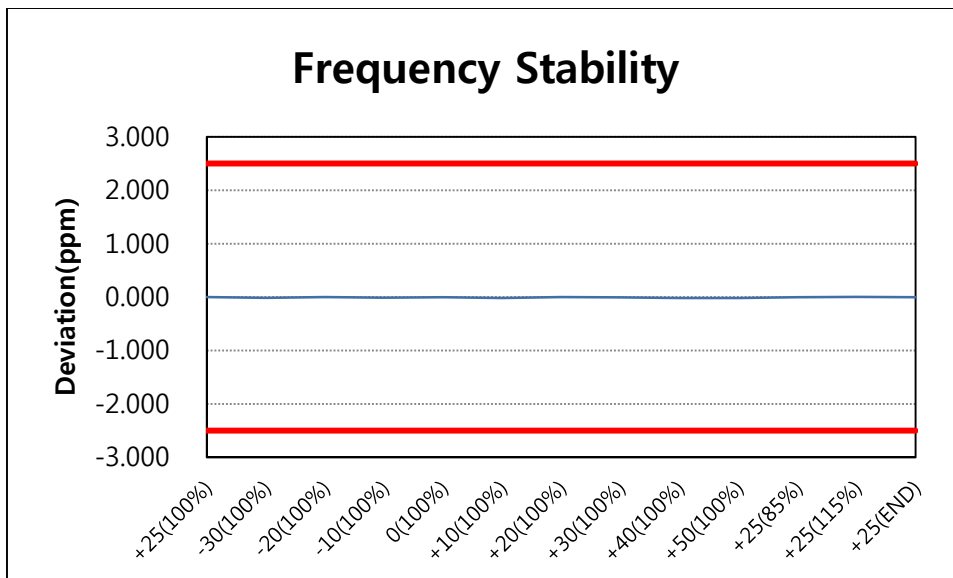

7.9.4 FREQUENCY STABILITY (GSM1900)

OPERATING FREQUENCY : 1,879,999,978 Hz
 CHANNEL : 661(Mid)
 REFERENCE VOLTAGE : 3.80 V DC
 DEVIATION LIMIT : ± 0.00025 % or 2.5 ppm

VOLTAGE (%)	POWER (V DC)	TEMP (°C)	FREQ (Hz)	Deviation	
				(ppm)	(%)
100%	3.80	+25(Ref)	1,879,999,978	0.000	0.00000000
100%		-30	1,879,999,979	0.001	0.00000005
100%		-20	1,880,000,025	0.025	0.00000250
100%		-10	1,879,999,985	0.004	0.00000037
100%		0	1,879,999,974	-0.002	-0.00000021
100%		+10	1,879,999,983	0.003	0.00000027
100%		+20	1,880,000,021	0.023	0.00000229
100%		+30	1,880,000,025	0.025	0.00000250
100%		+40	1,880,000,022	0.023	0.00000234
100%		+50	1,879,999,976	-0.001	-0.00000011
85%	3.23	+25	1,879,999,981	0.002	0.00000016
115%	4.37	+25	1,879,999,976	-0.001	-0.00000011
BATT.ENDPOINT	3.20	+25	1,880,000,024	0.024	0.00000244

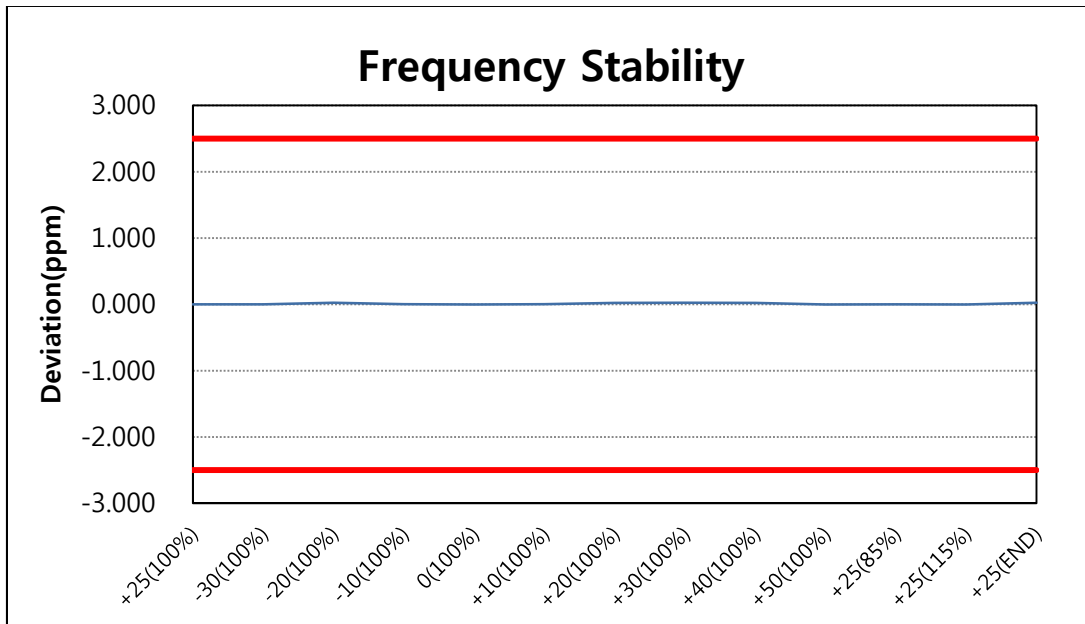

8. TEST PLOTS

8.1 Peak to Average Ratio

GSM1900 & Channel: 661

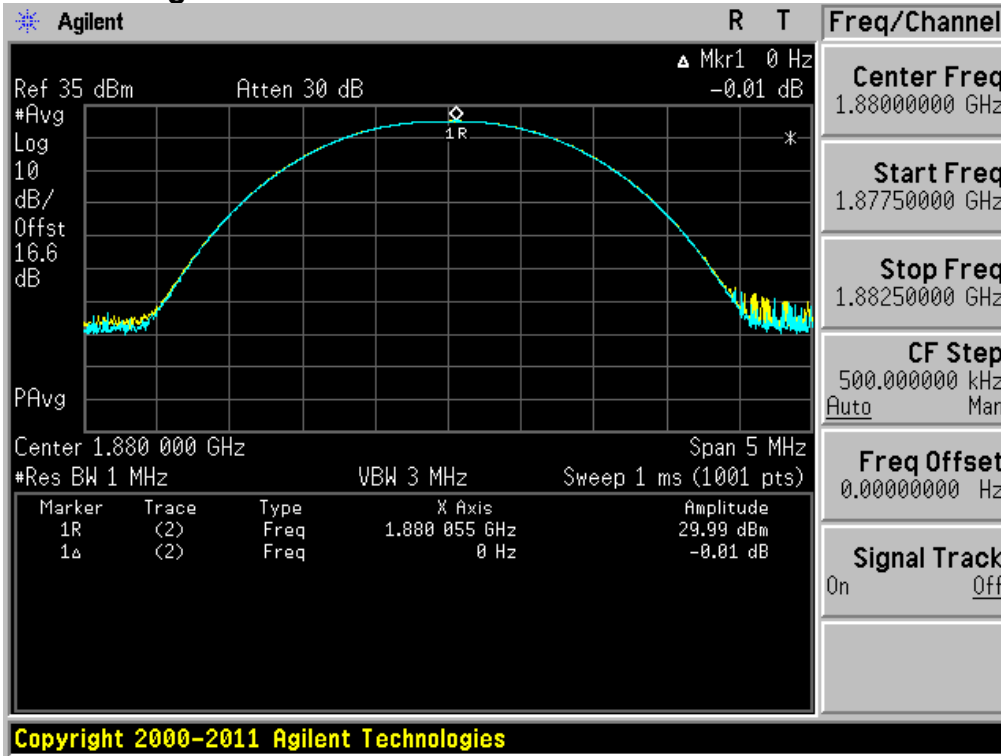

8.2 Occupied Bandwidth 99 % Bandwidth

GSM850 & Channel: 128

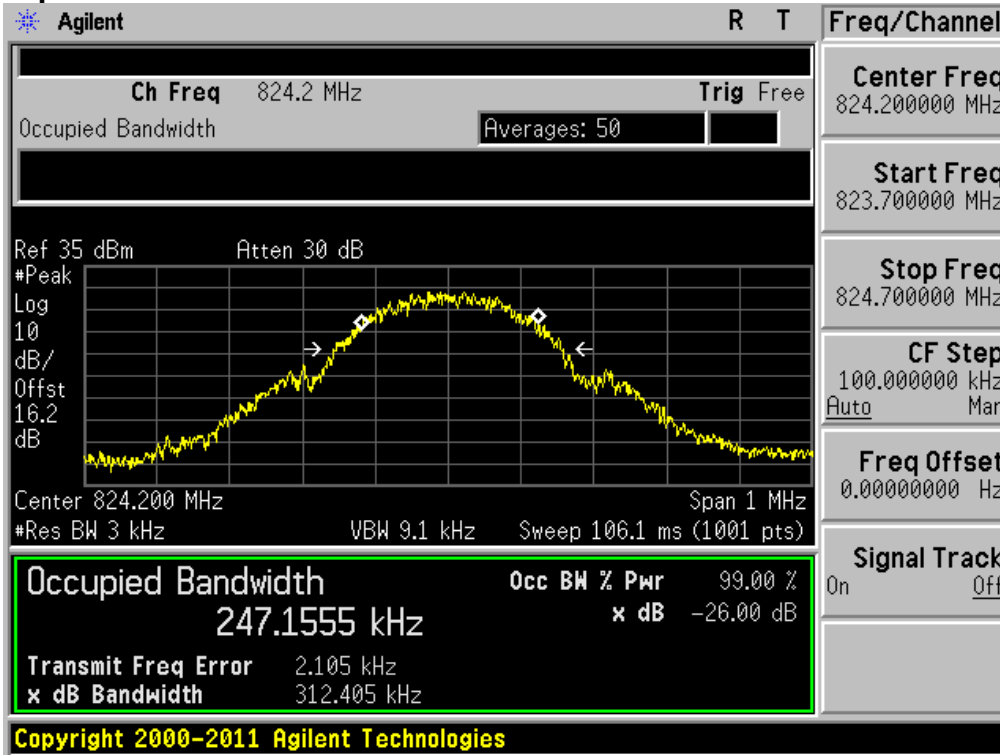

GSM850 & Channel: 190

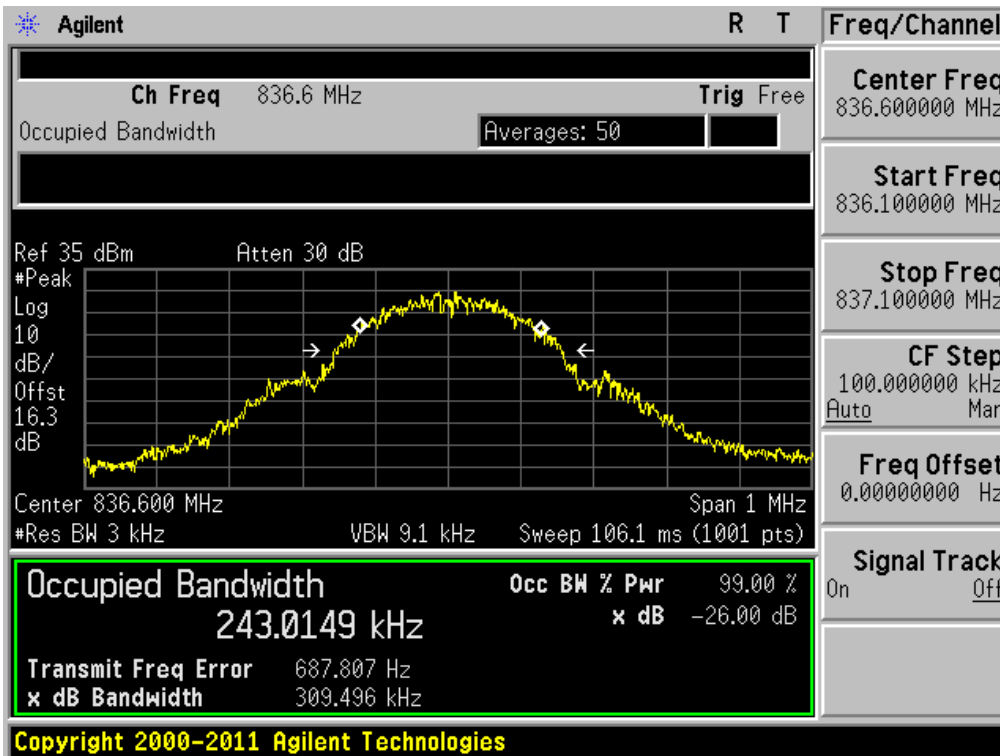

GSM850 & Channel: 251

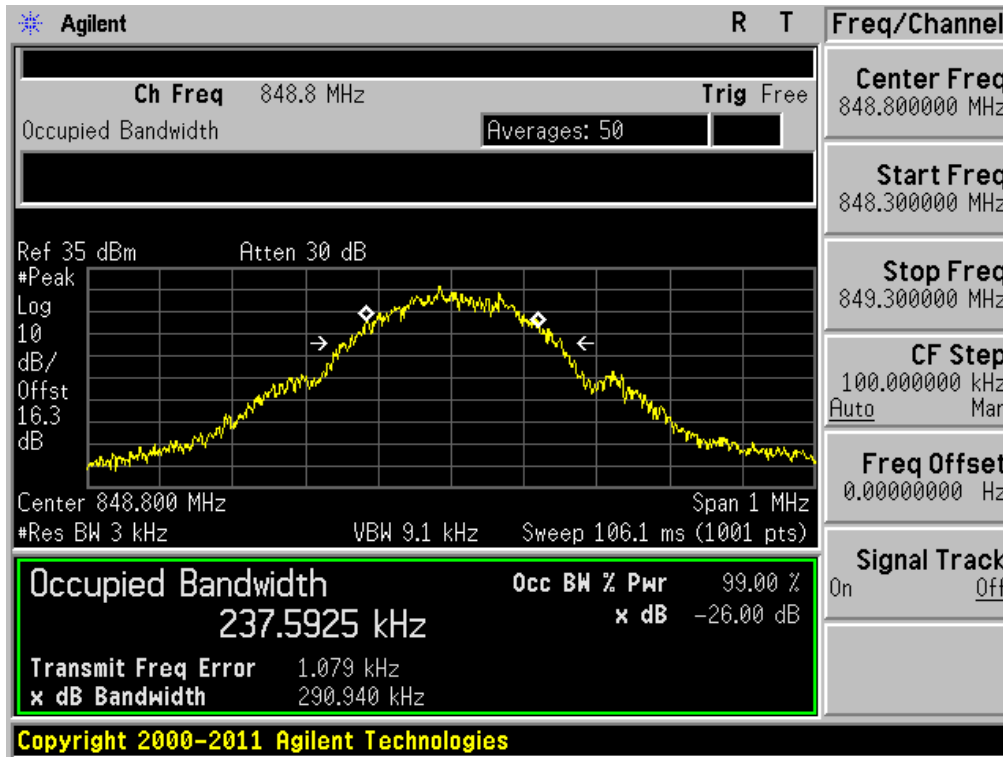

CDMA850 & Channel: 1013

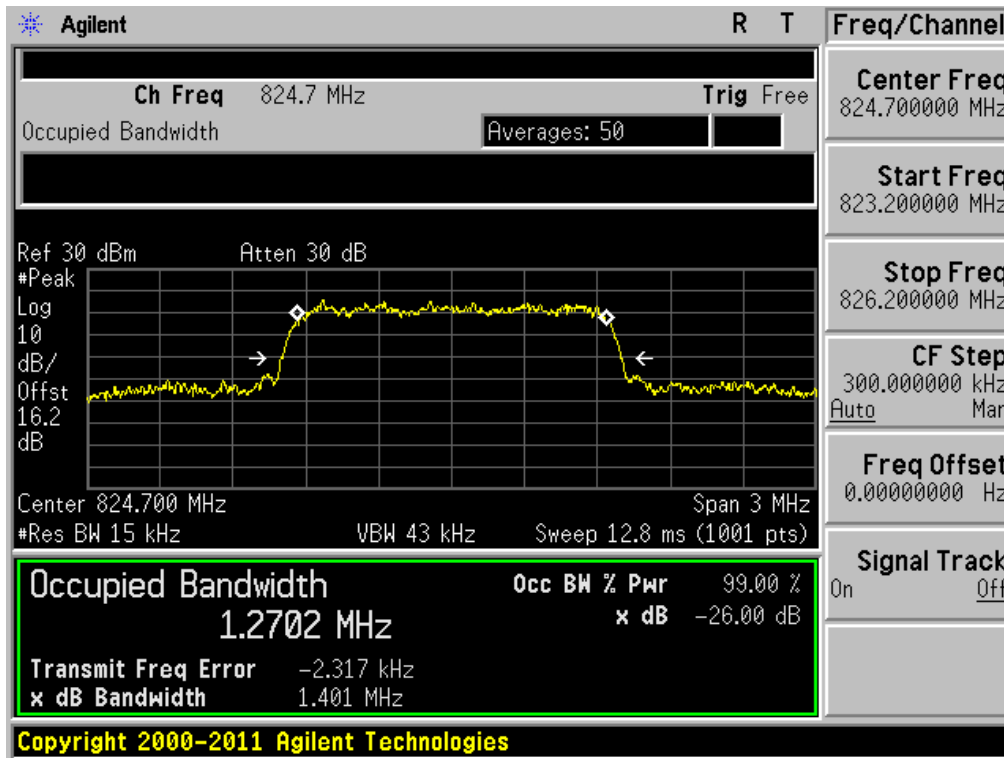

CDMA850 & Channel: 384

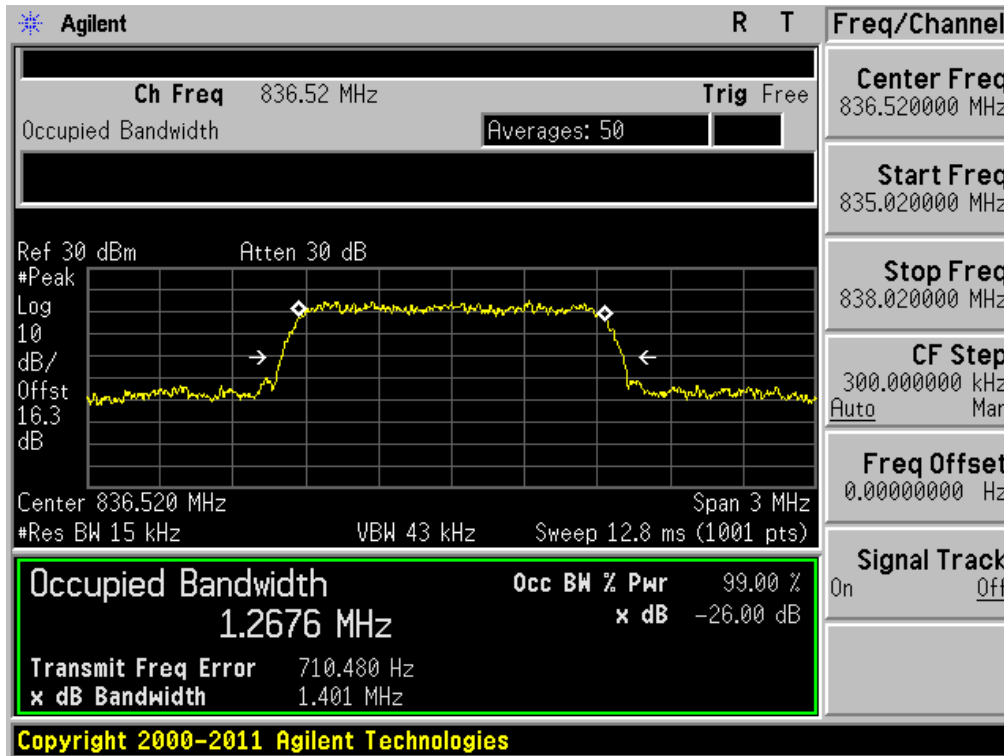

CDMA850 & Channel: 777

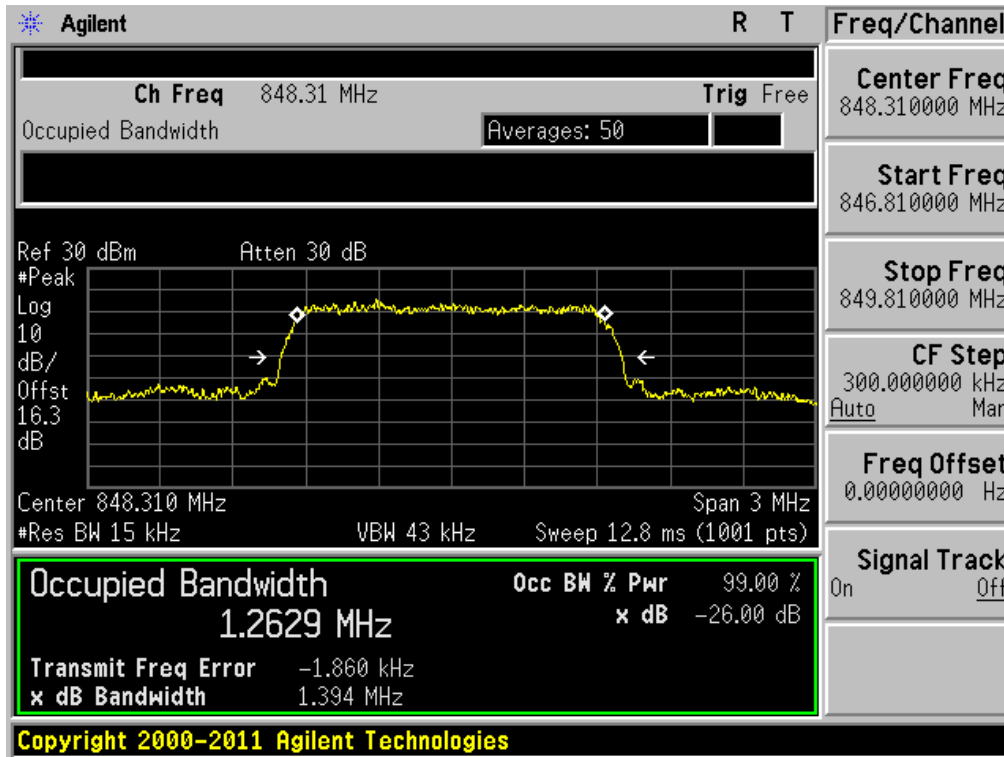

WCDMA850 & Channel: 4132

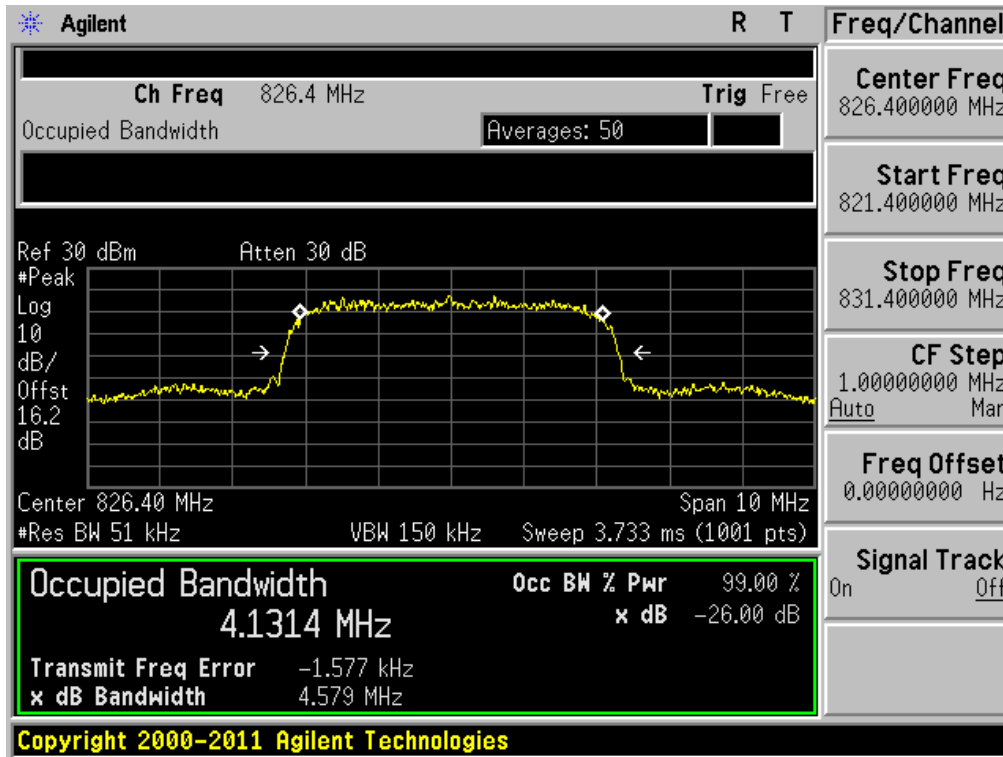

WCDMA850 & Channel: 4183

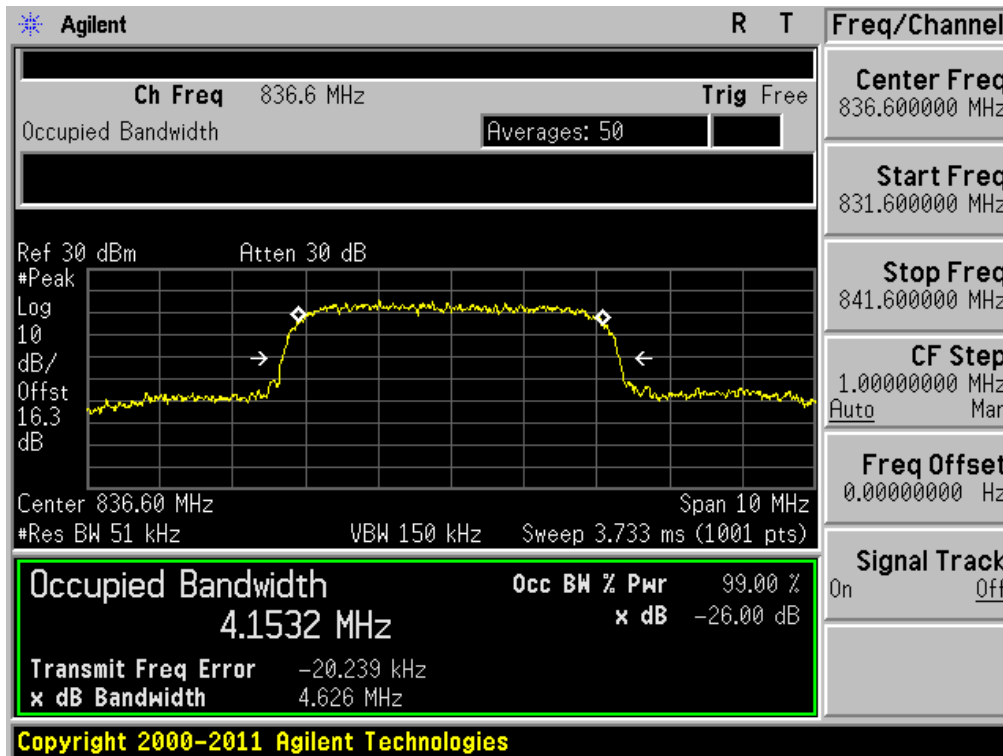

WCDMA850 & Channel: 4233

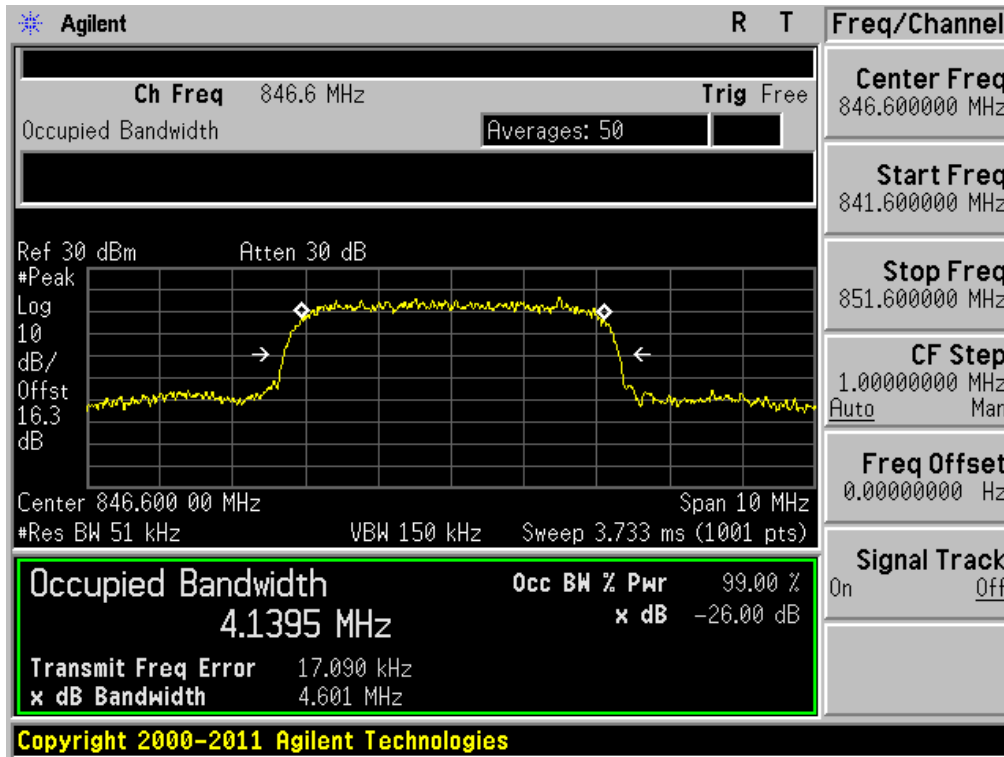

GSM 1900 & Channel: 512

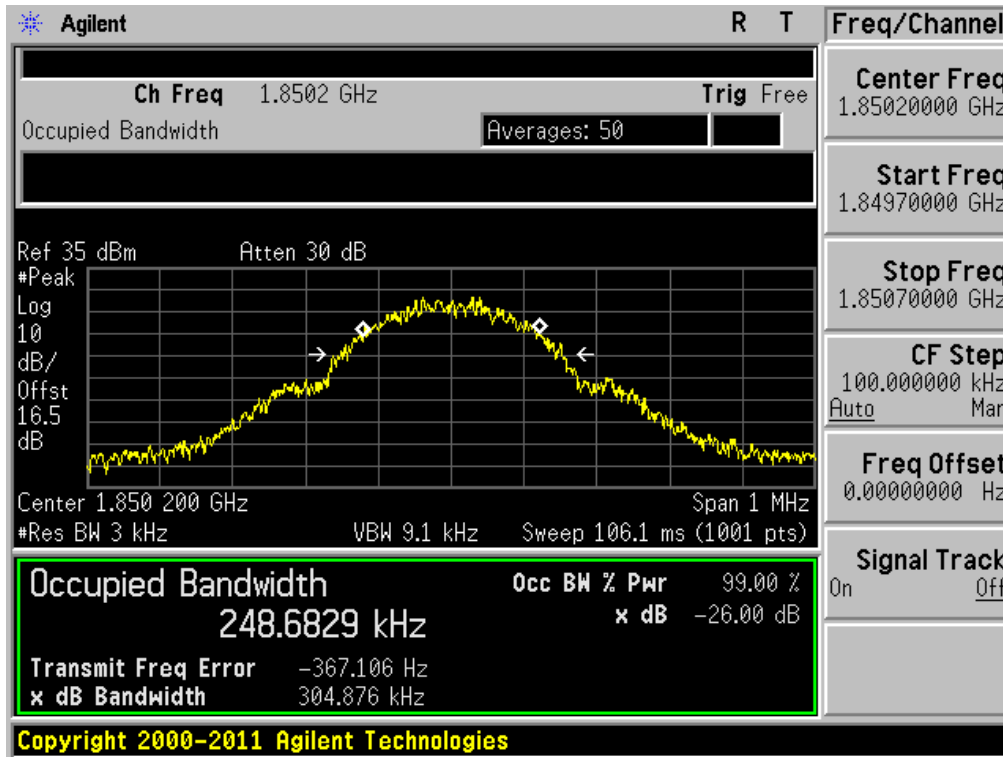

GSM 1900 & Channel: 661

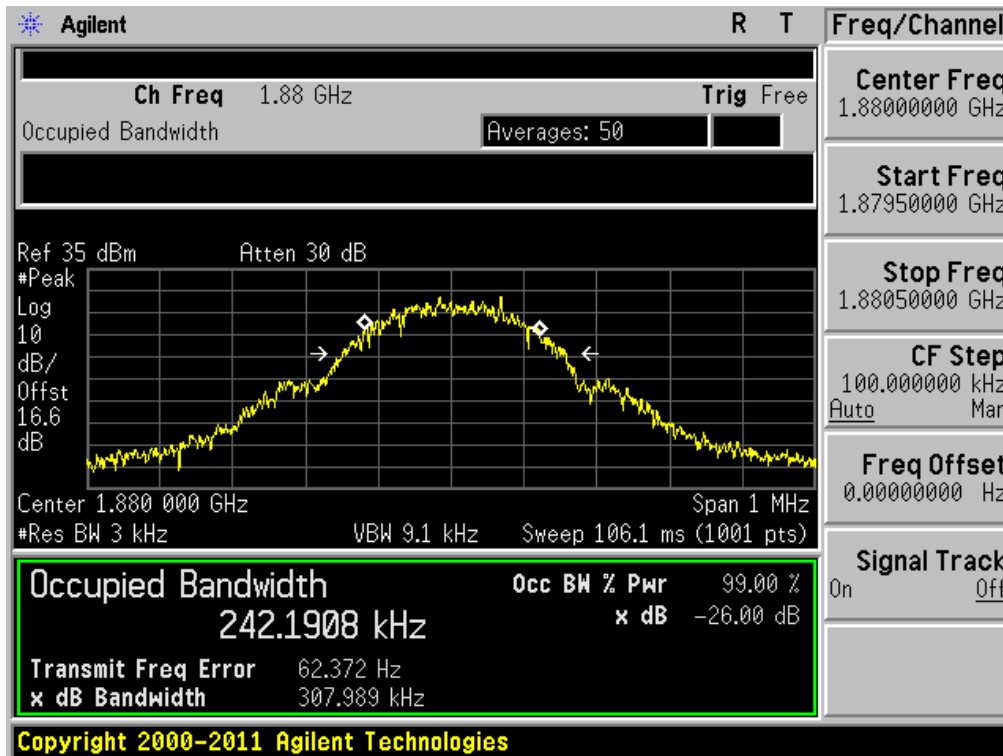

GSM 1900 & Channel: 810

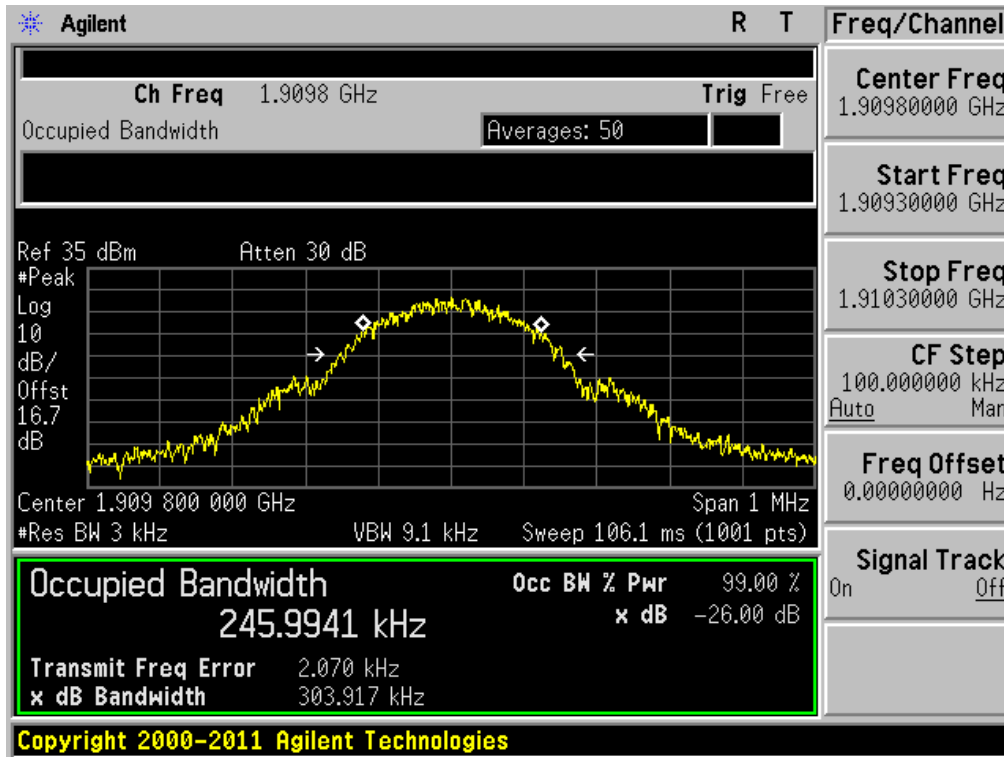

8.3 Spurious Emissions at Antenna Terminal

GSM850 & Channel: 128

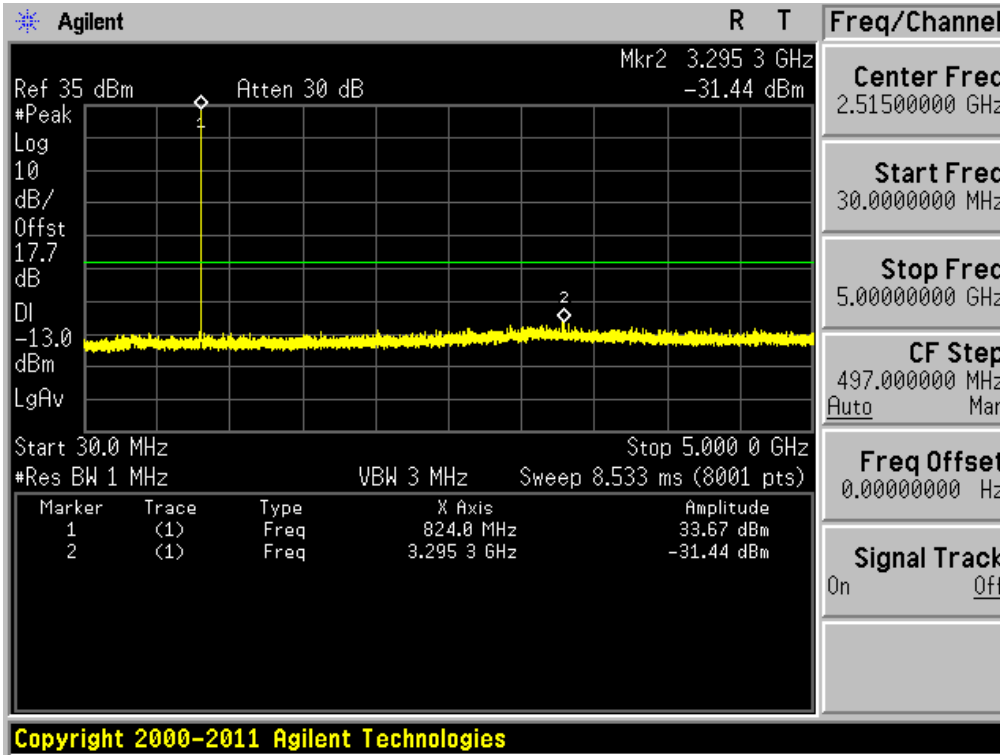

GSM850 & Channel: 128

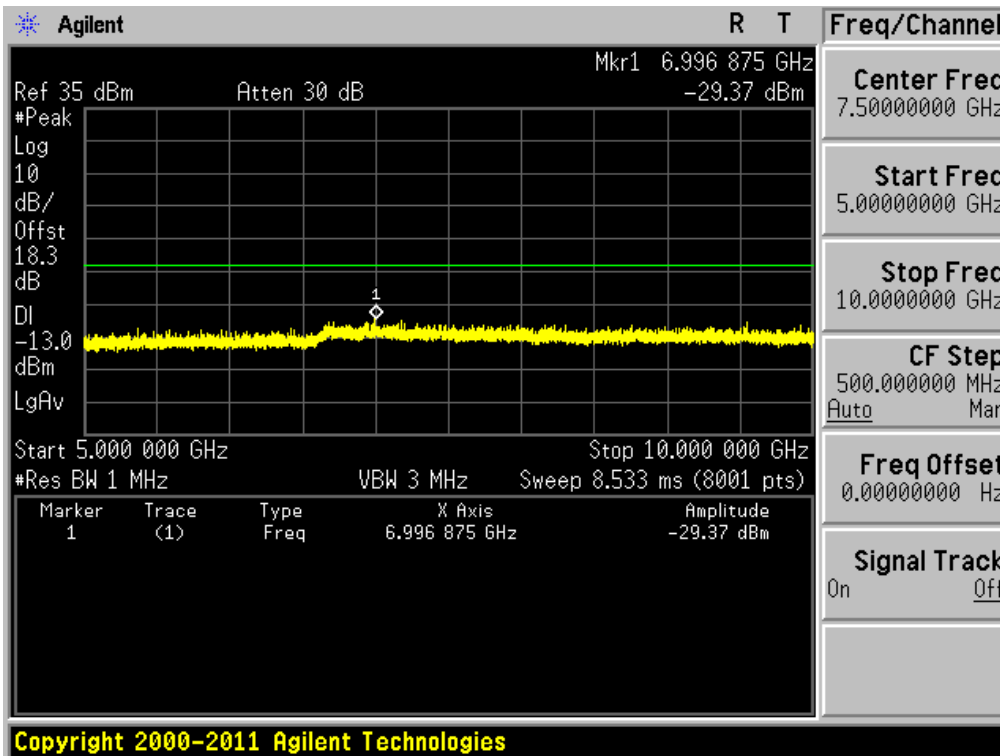

GSM850 & Channel: 190

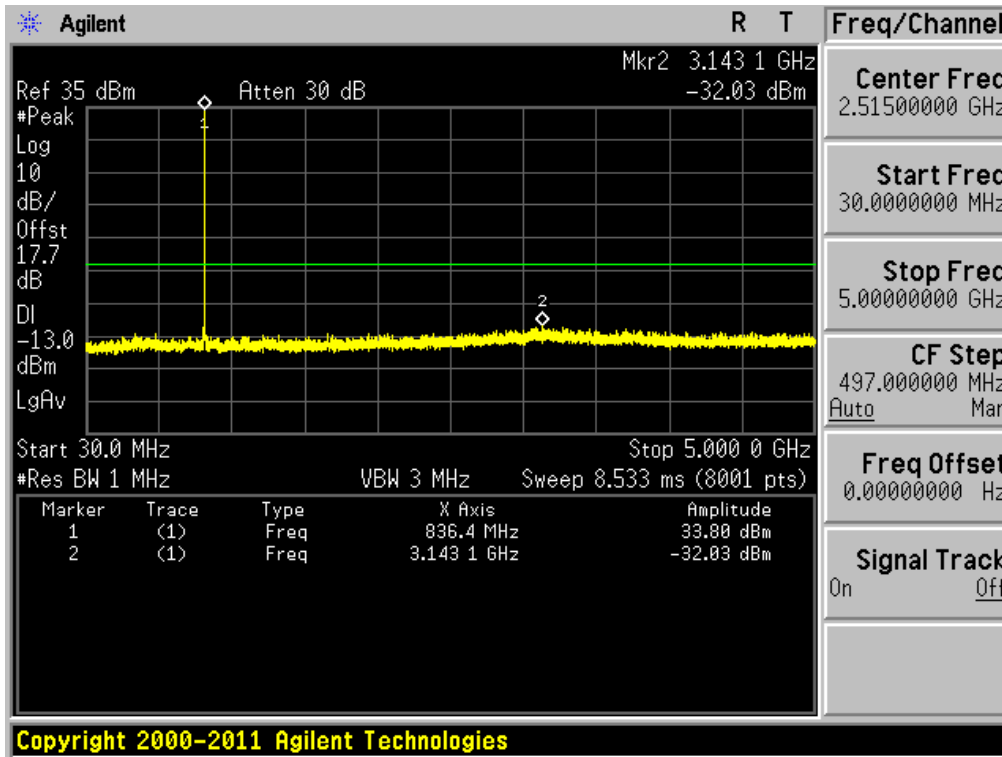

GSM850 & Channel: 190

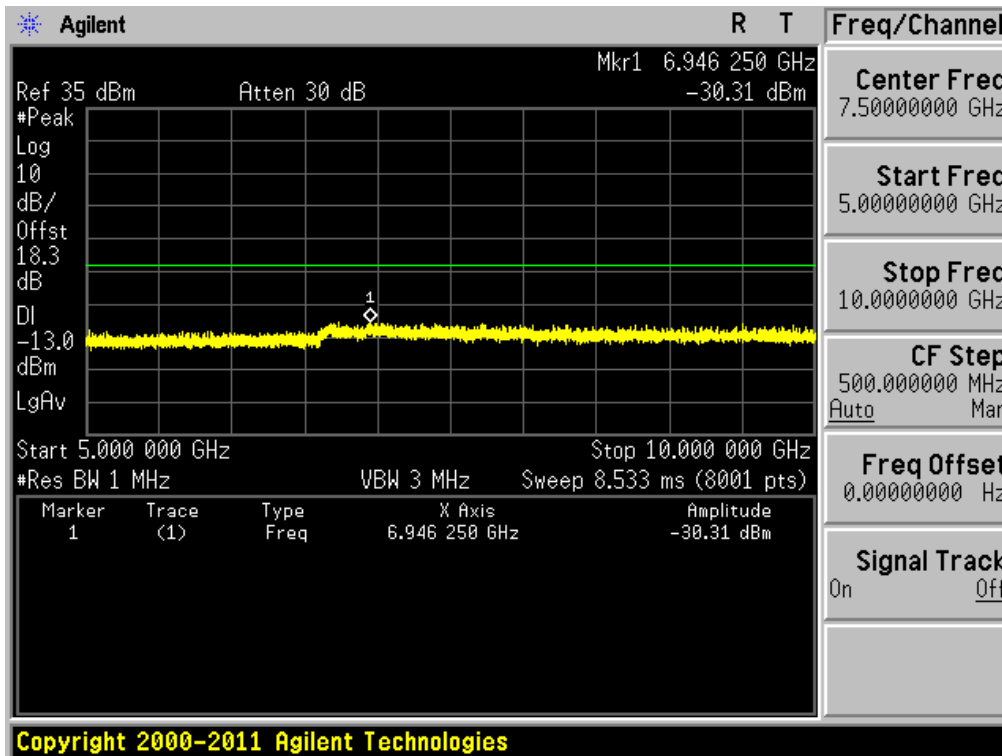

GSM850 & Channel: 251

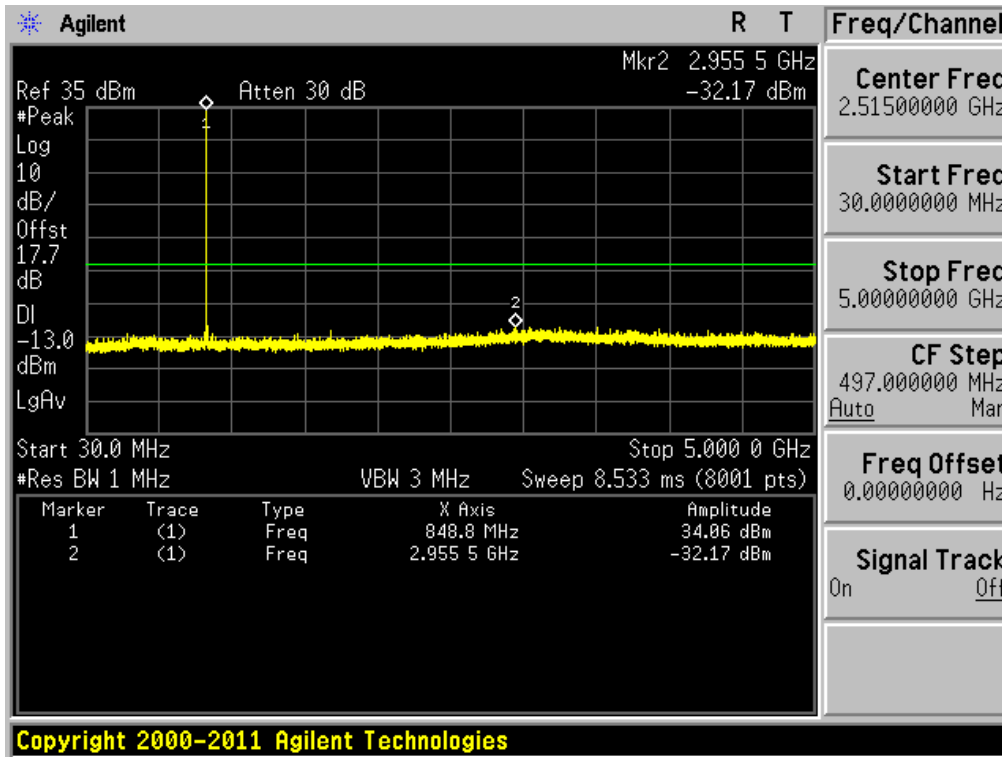

GSM850 & Channel: 251

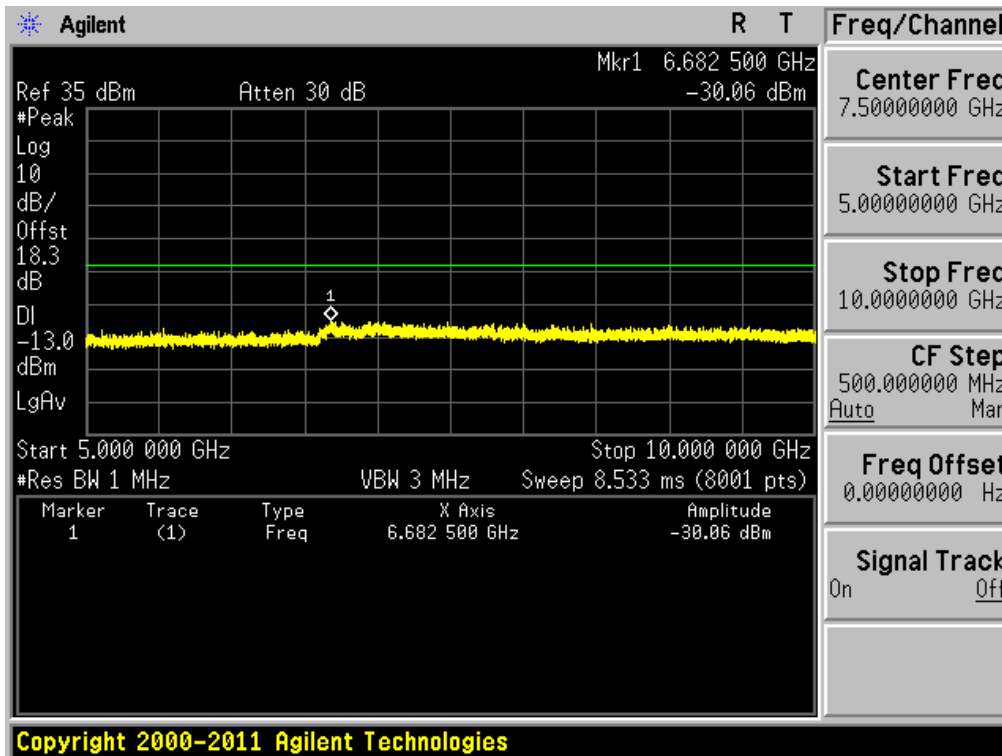

CDMA850 & Channel: 1013

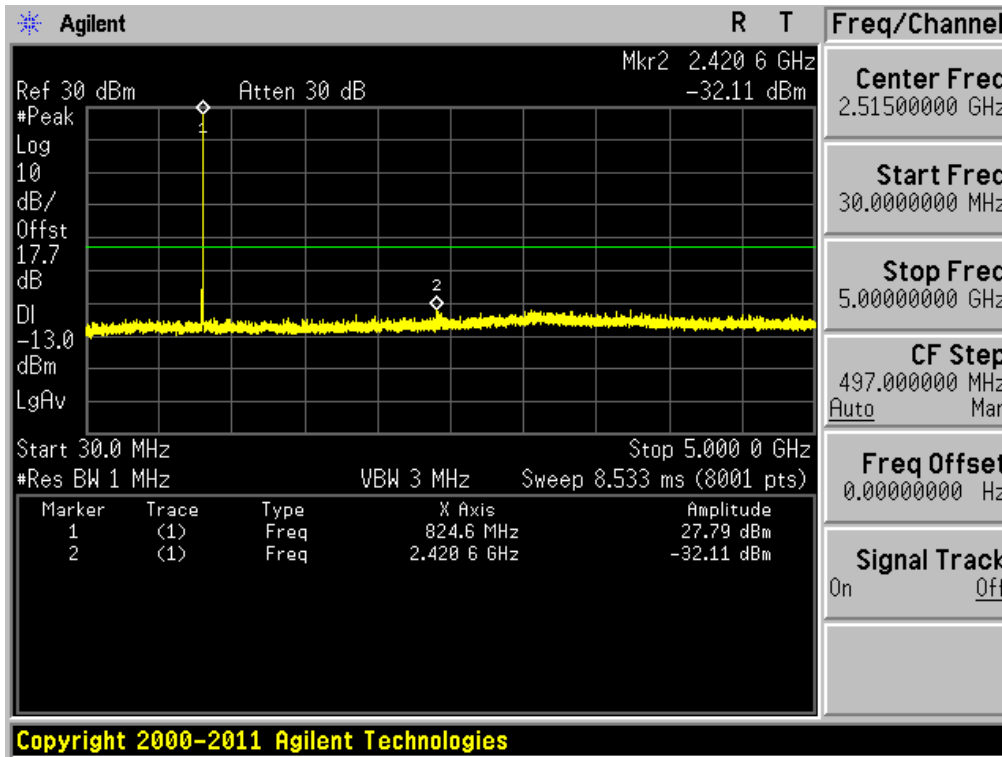

CDMA850 & Channel: 1013

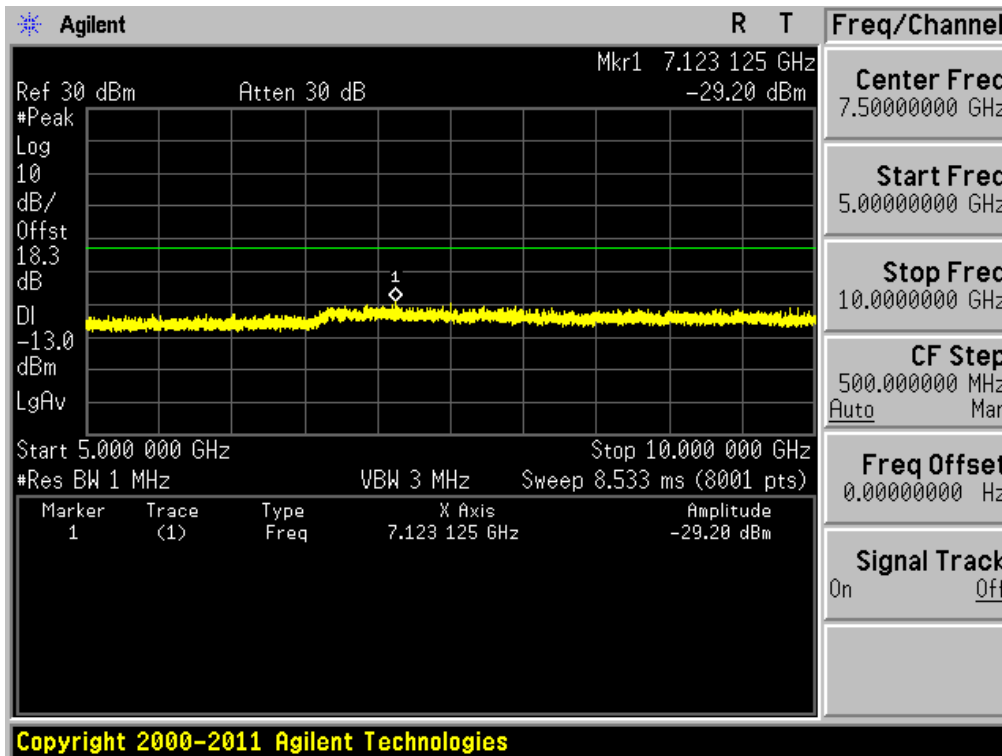

CDMA850 & Channel: 384

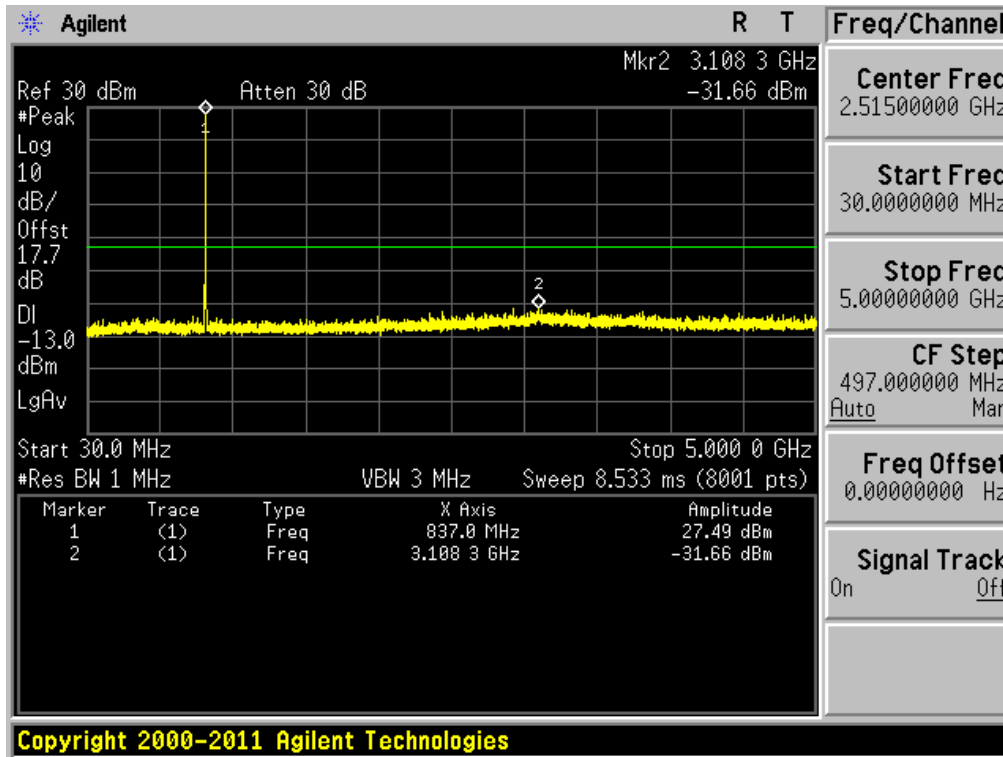

CDMA850 & Channel: 384

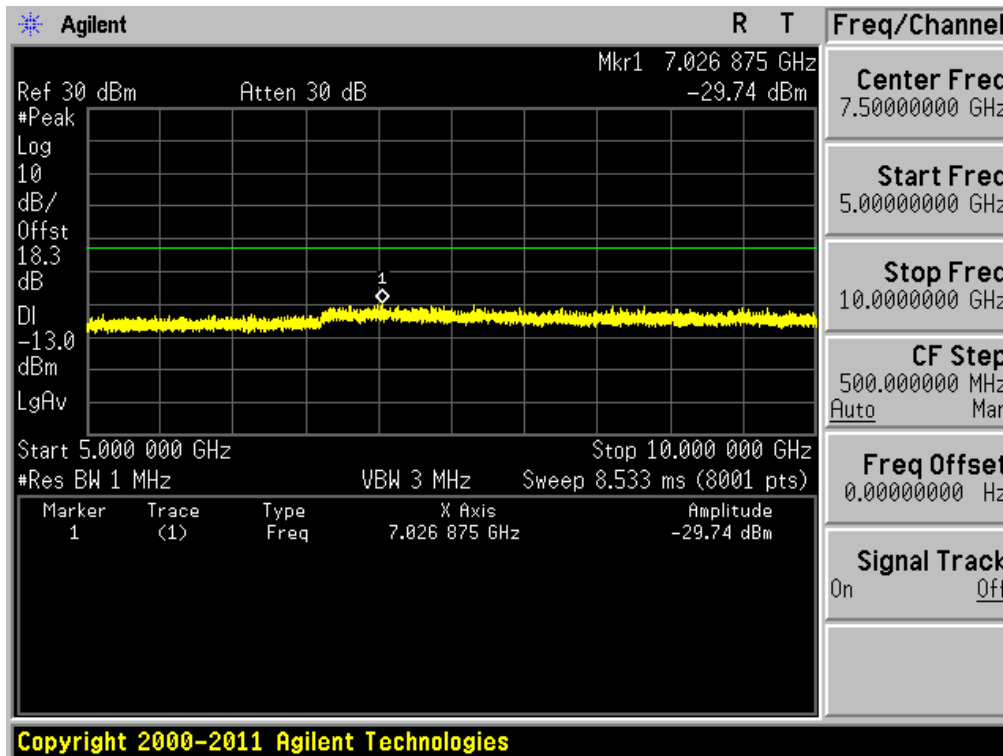

CDMA850 & Channel: 777

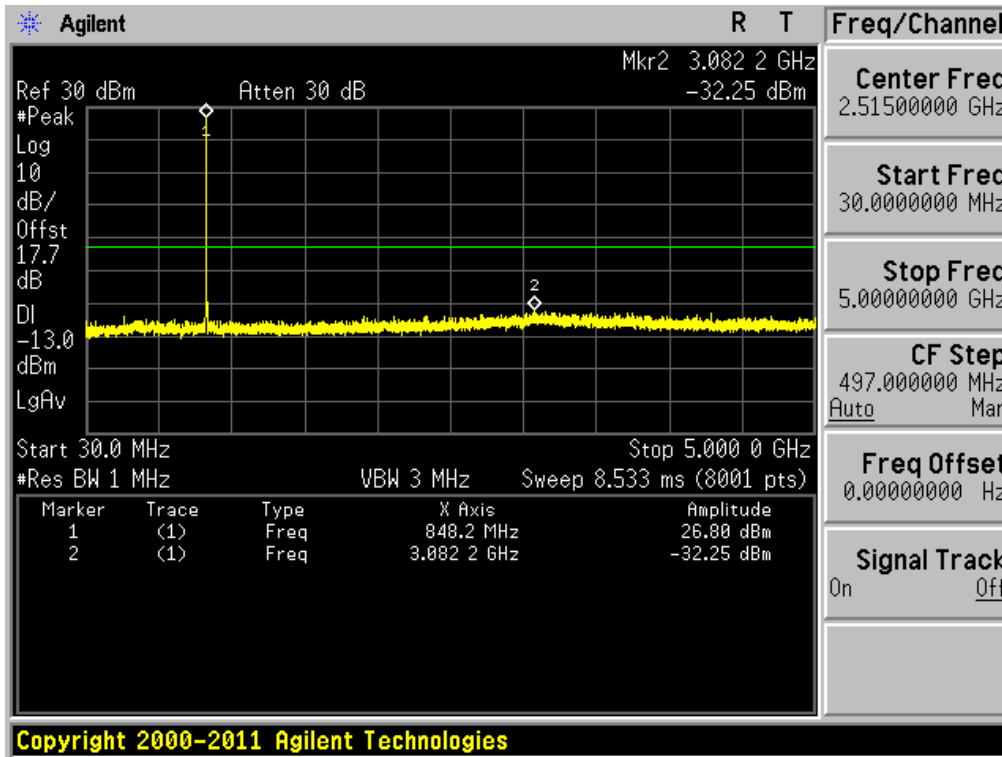

CDMA850 & Channel: 777

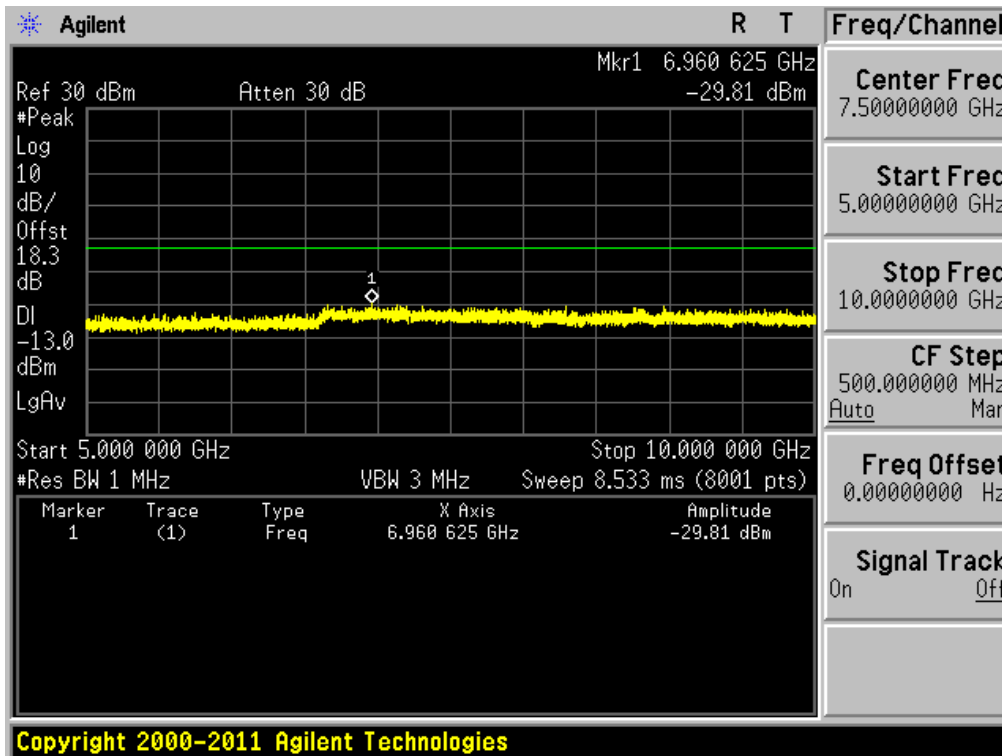

WCDMA850 & Channel: 4132

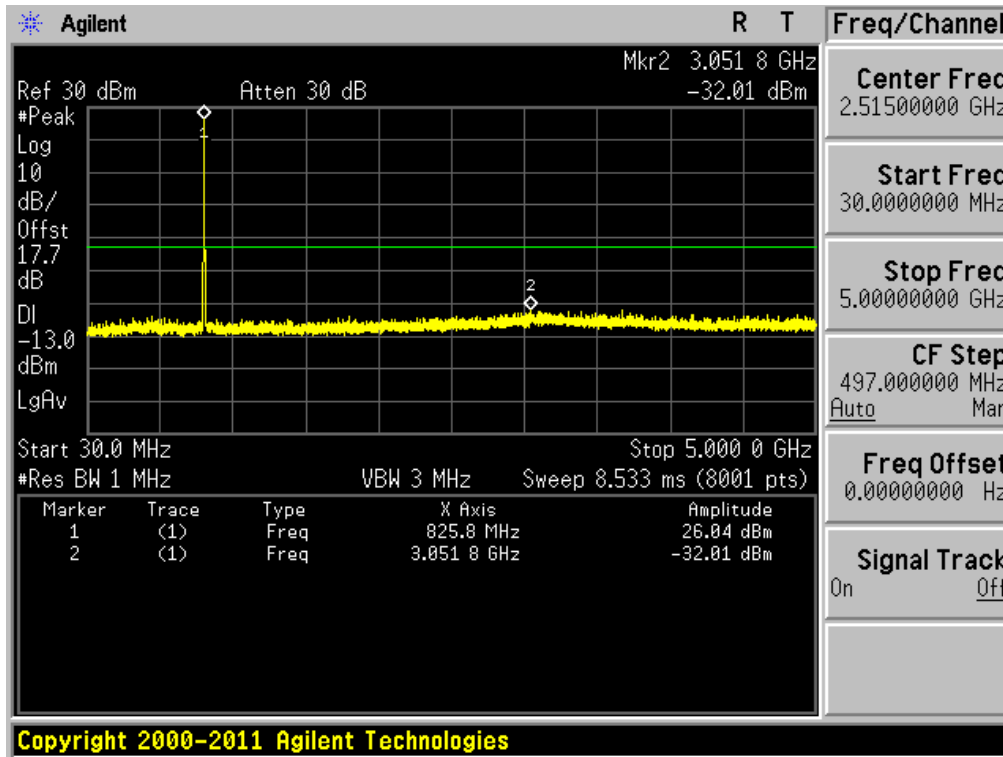

WCDMA850 & Channel: 4132

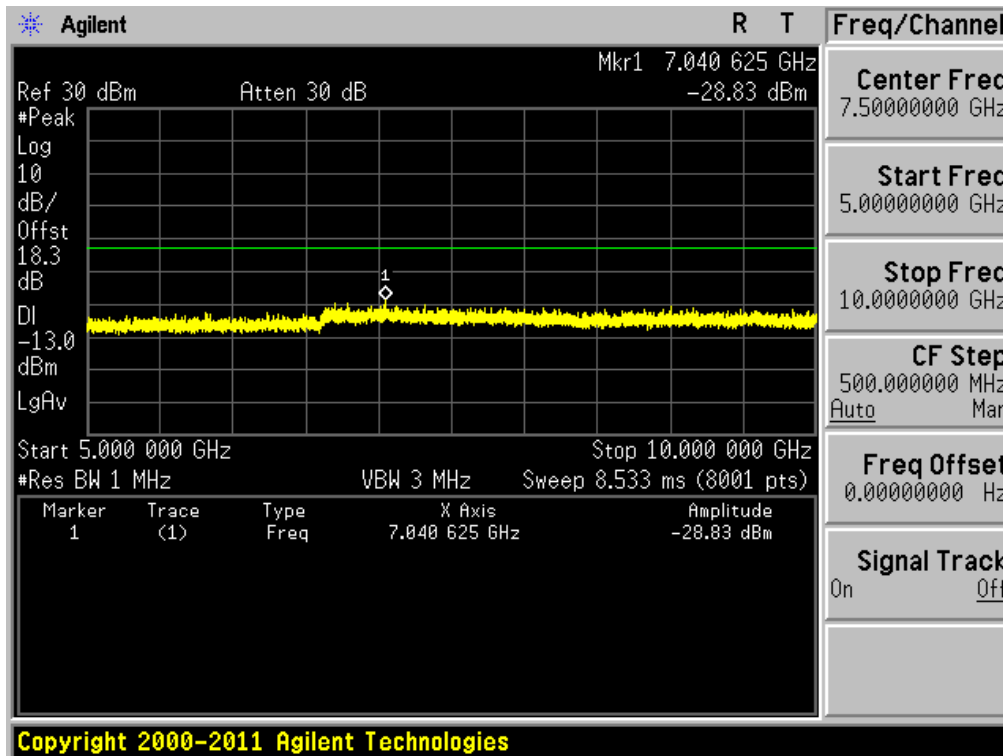

WCDMA850 & Channel: 4183

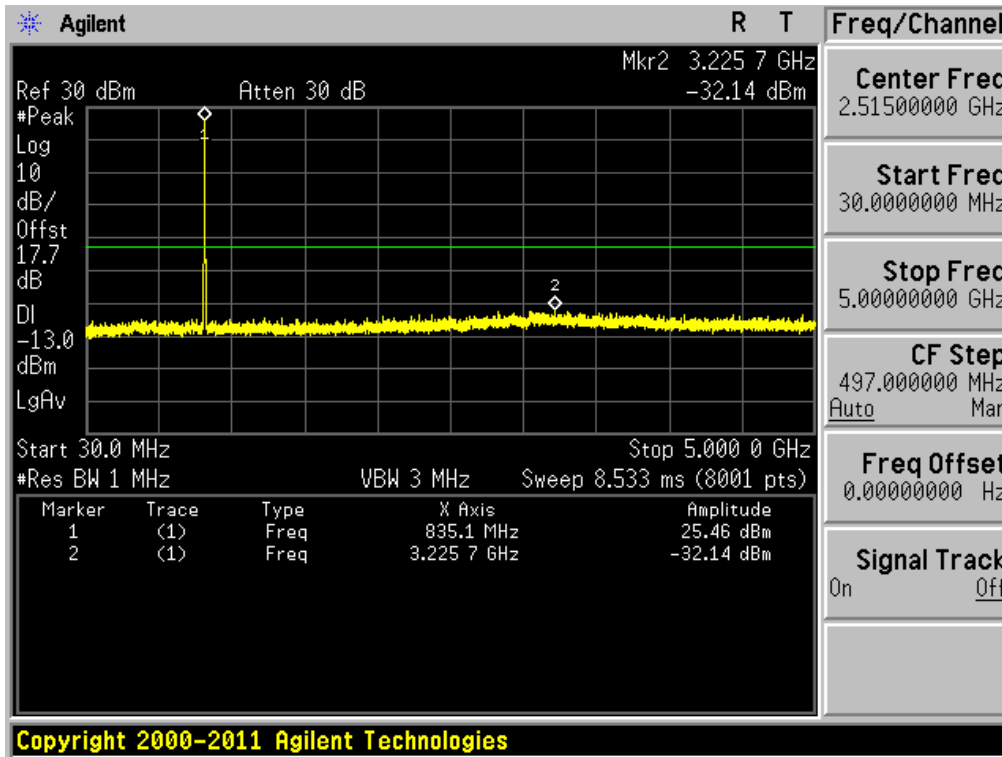

WCDMA850 & Channel: 4183

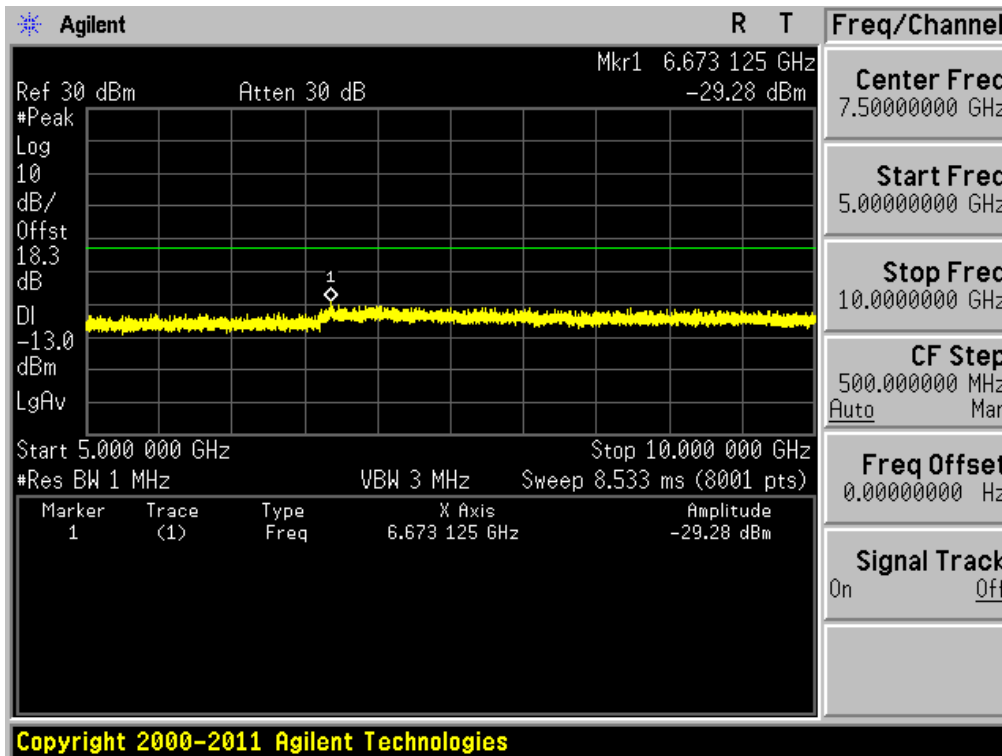

WCDMA850 & Channel: 4233

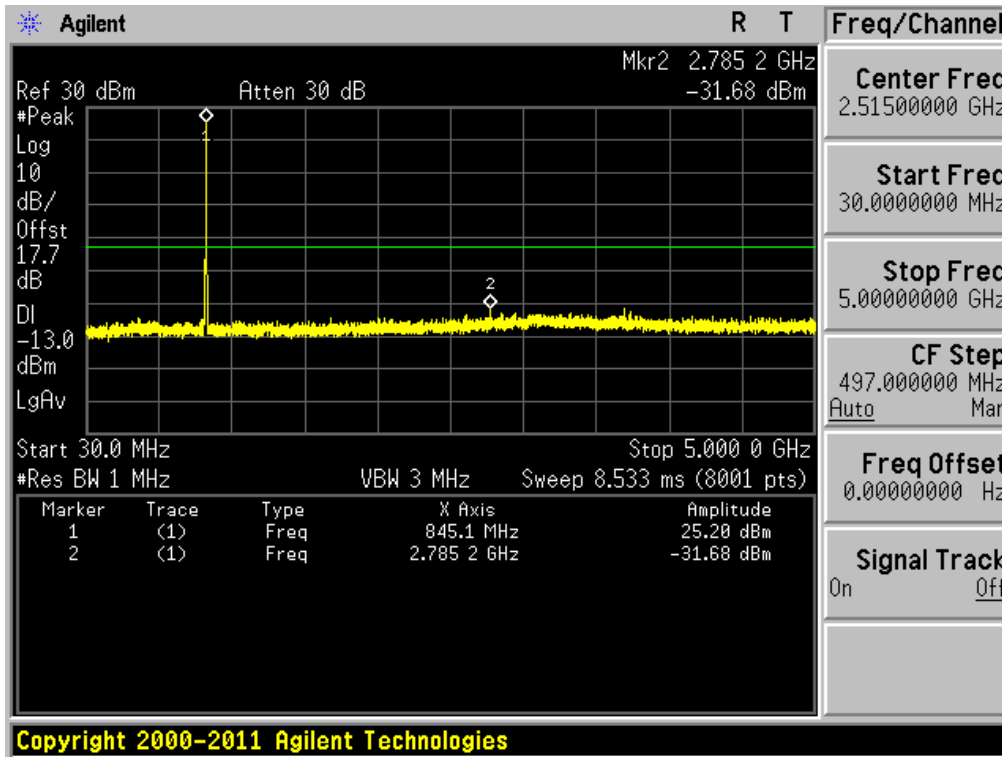

WCDMA850 & Channel: 4233

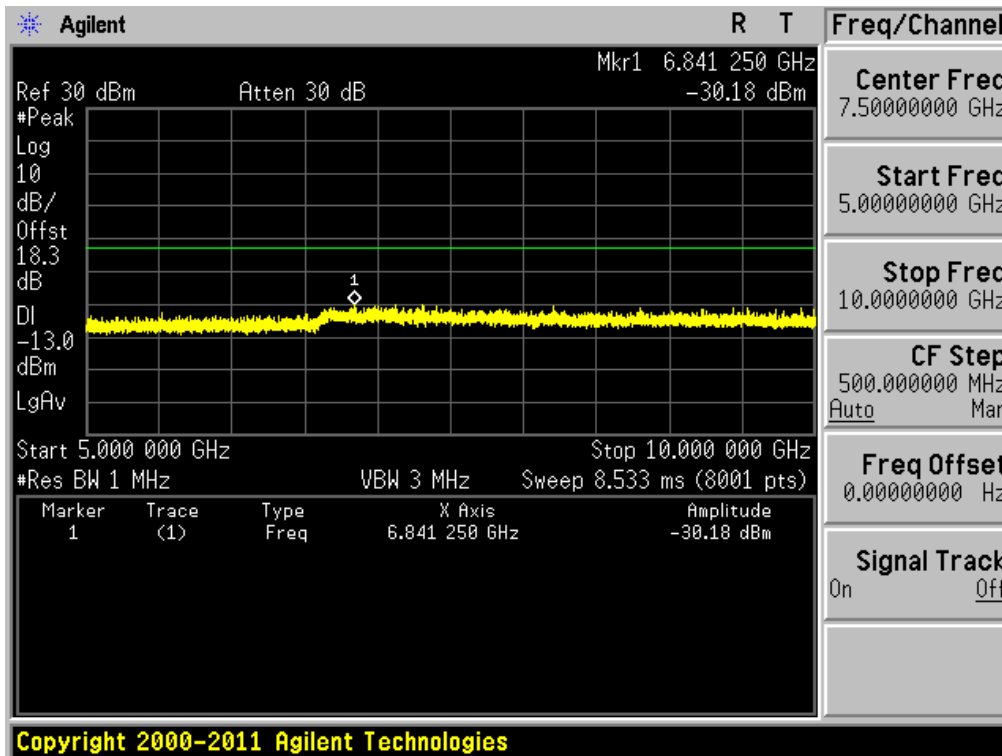

PCS1900 & Channel: 512

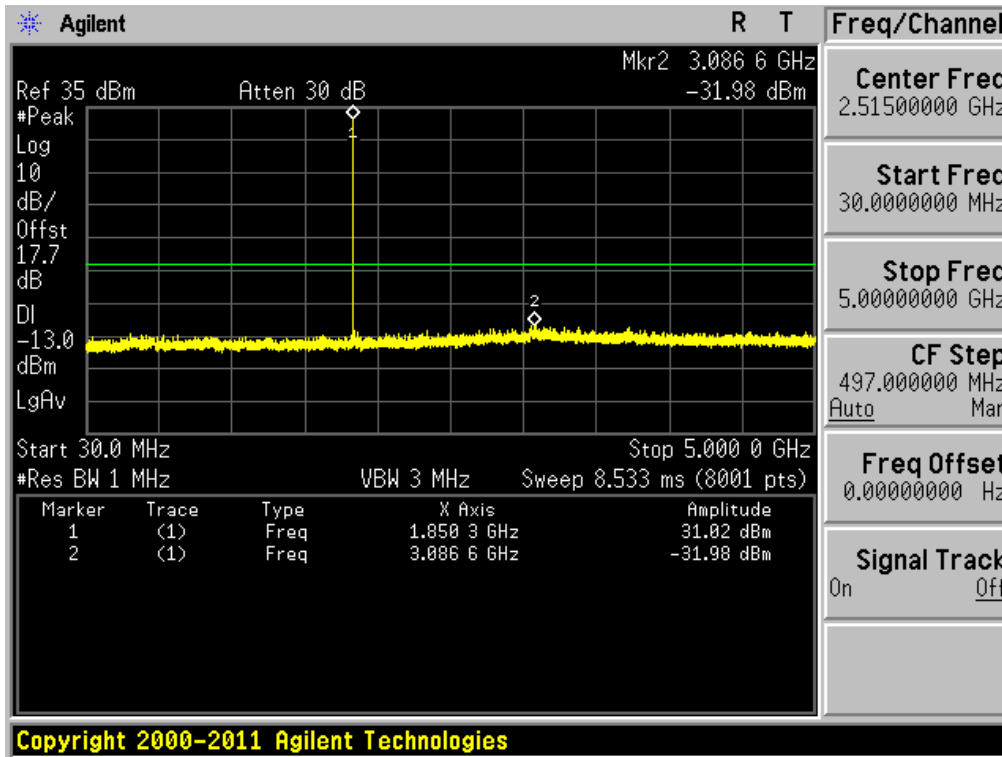

PCS1900 & Channel: 512

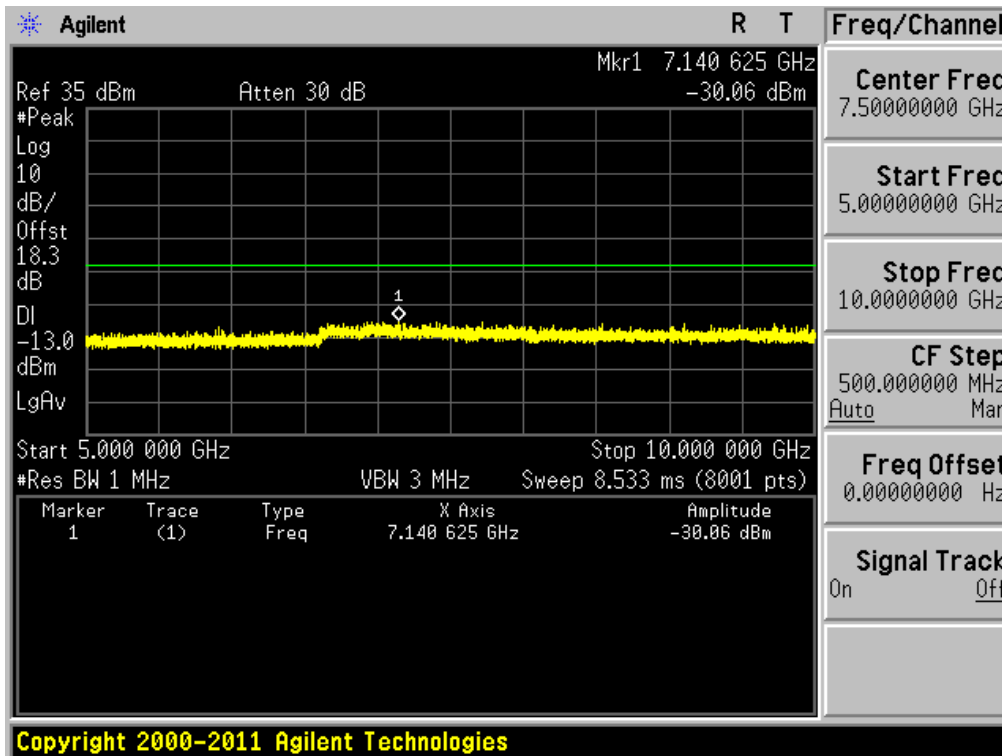

PCS1900 & Channel: 512

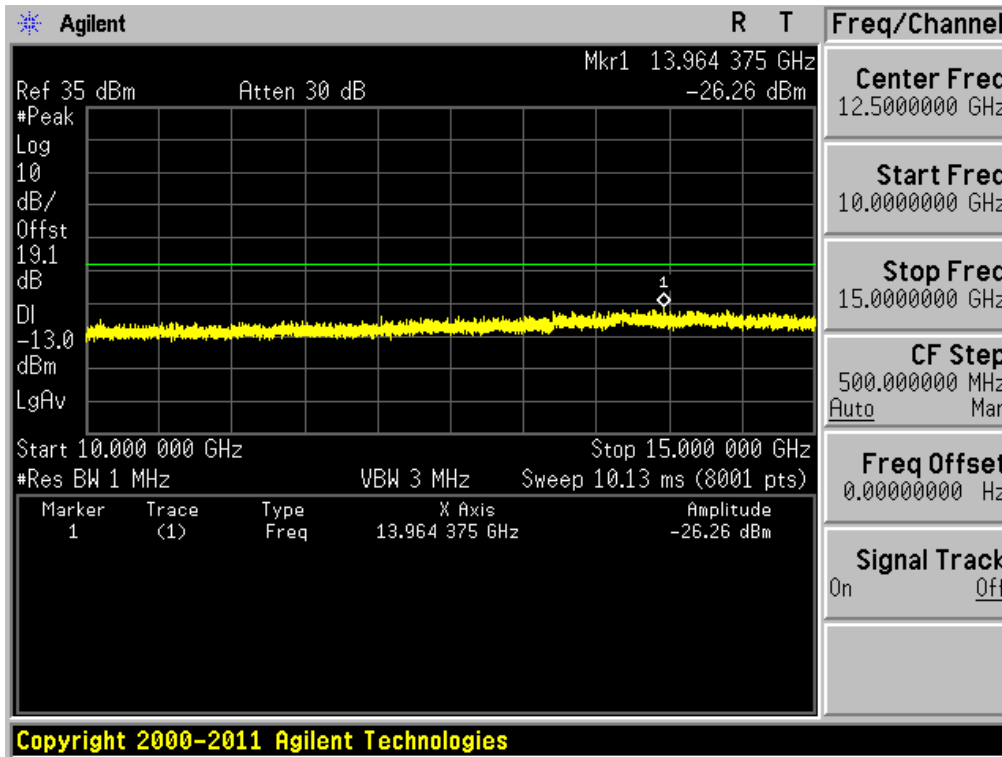

PCS1900 & Channel: 512

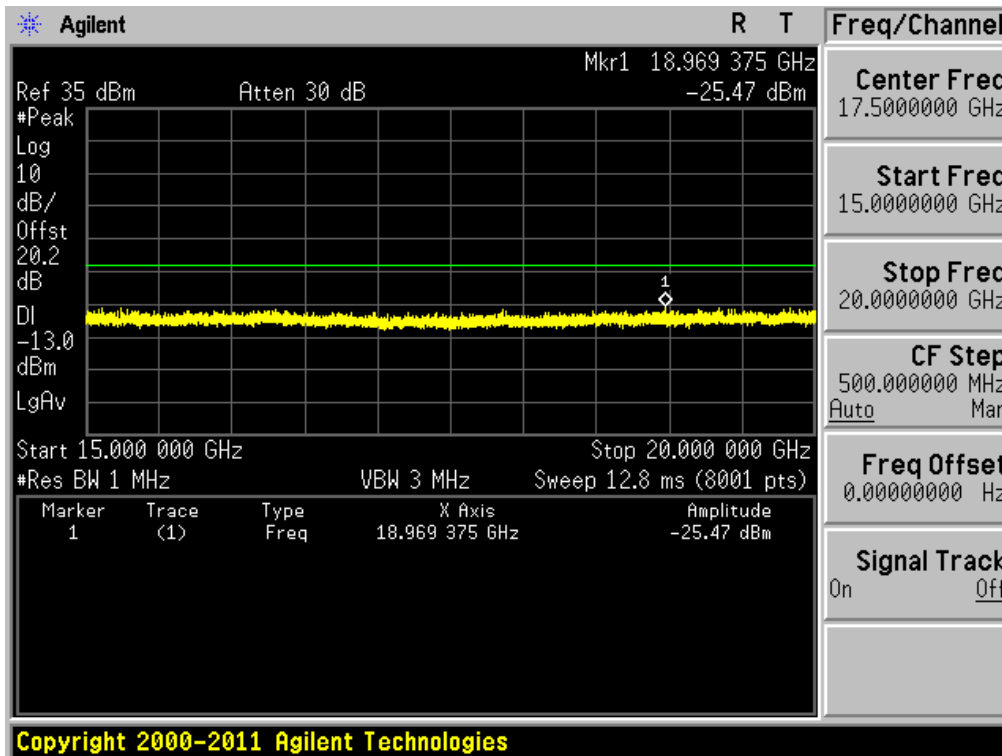

PCS1900 & Channel: 661

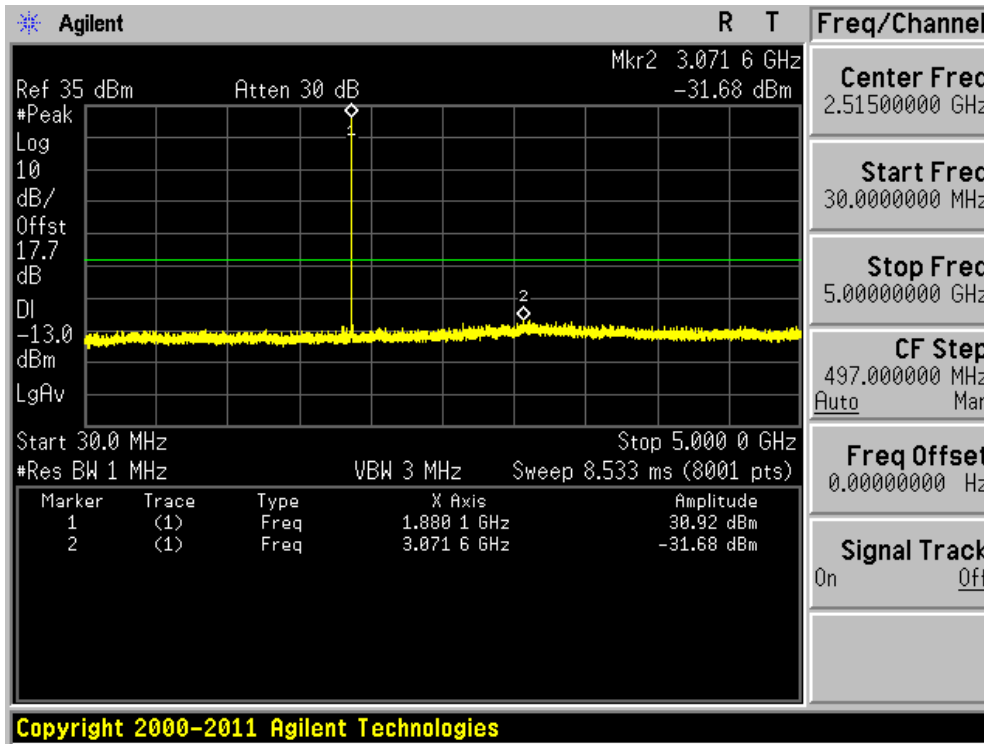

PCS1900 & Channel: 661

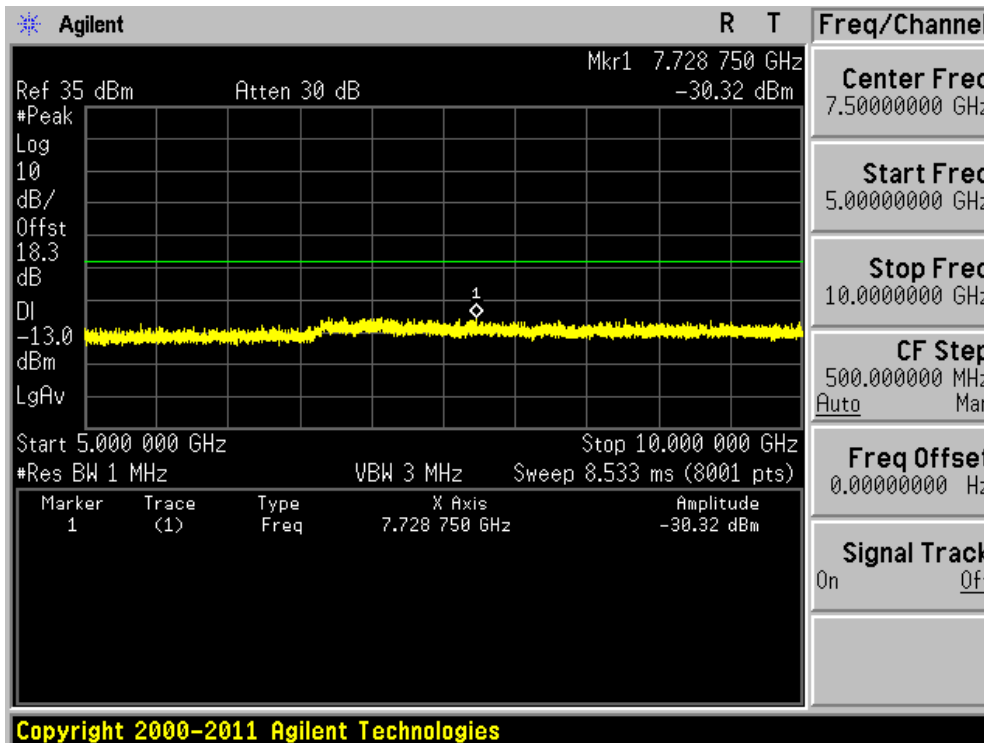

PCS1900 & Channel: 661

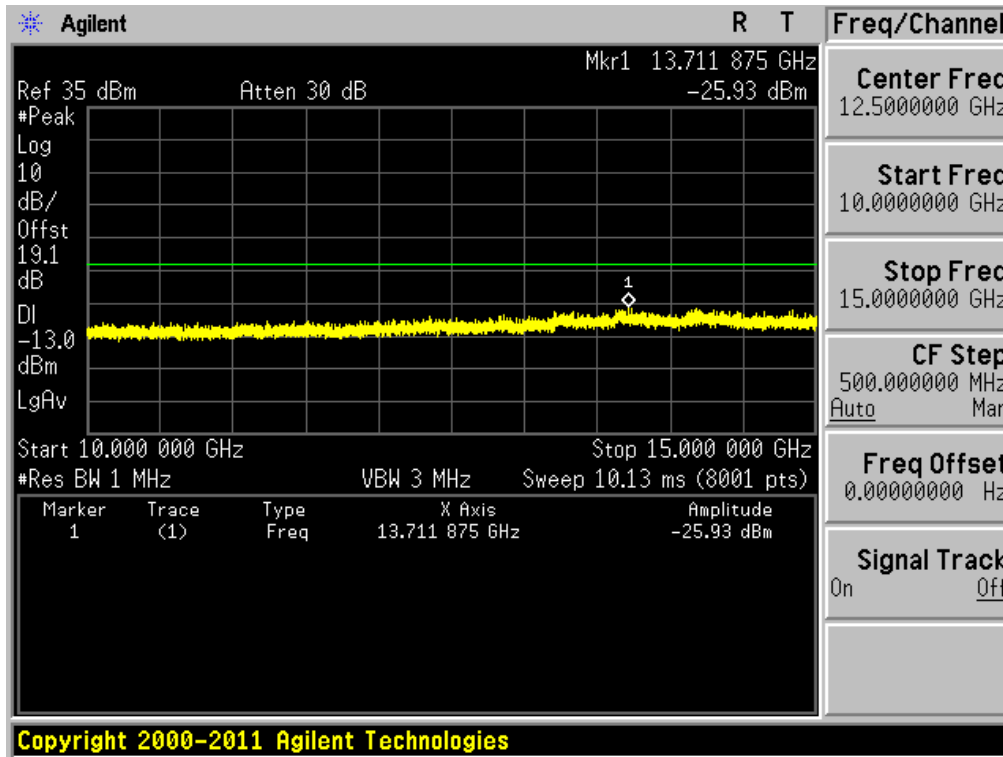

PCS1900 & Channel: 661

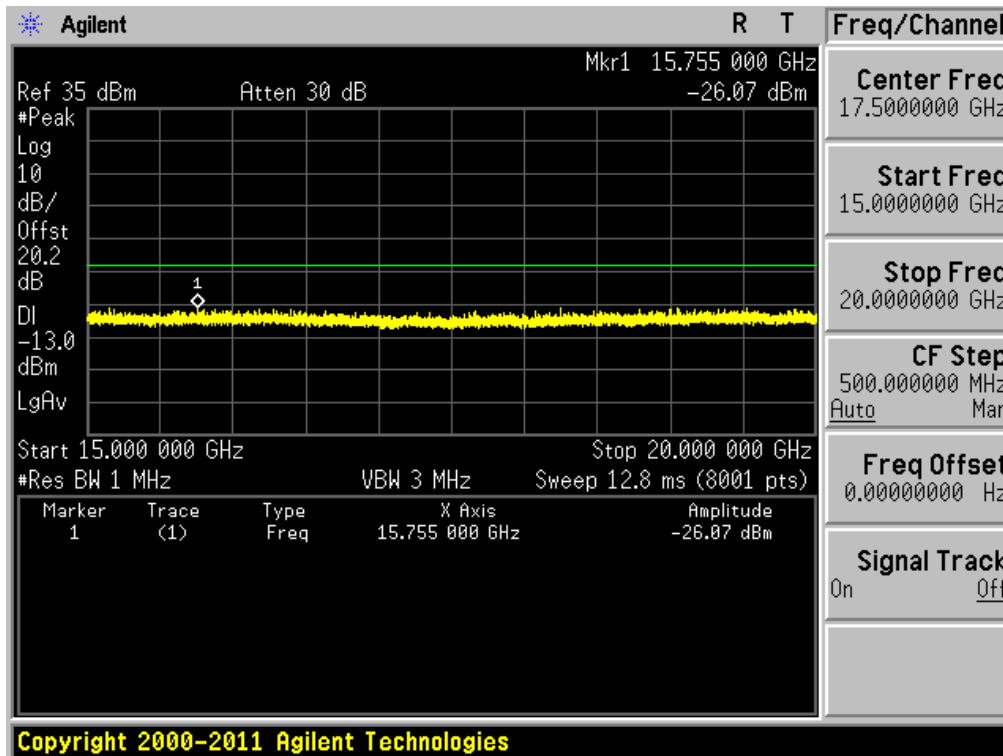

PCS1900 & Channel: 810

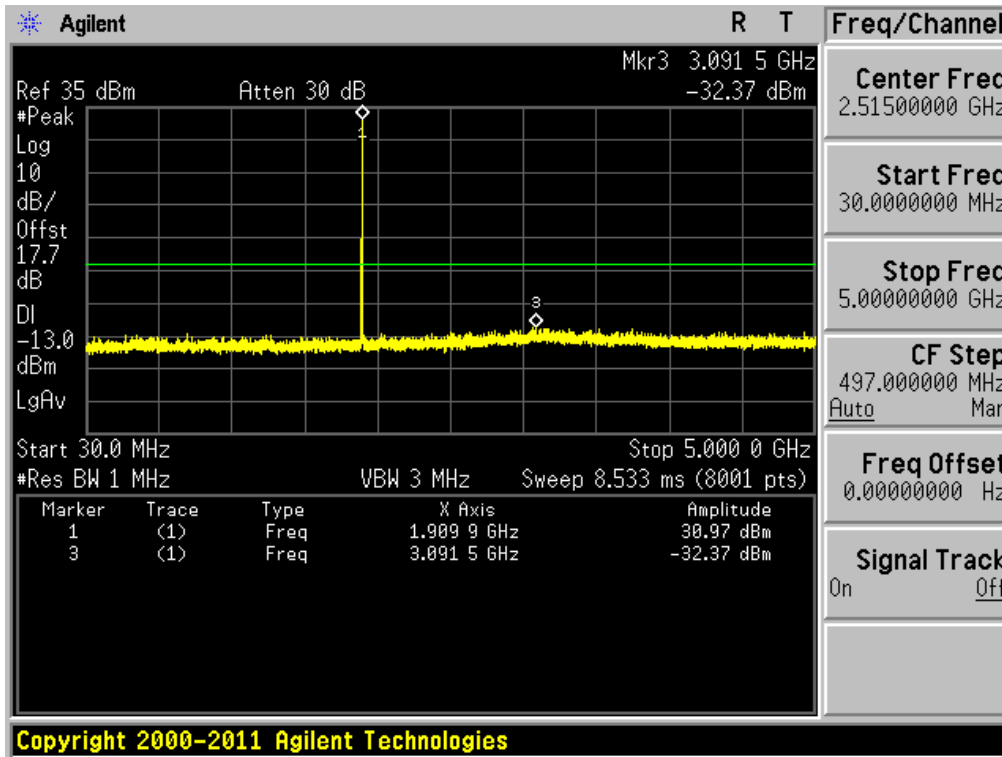

PCS1900 & Channel: 810

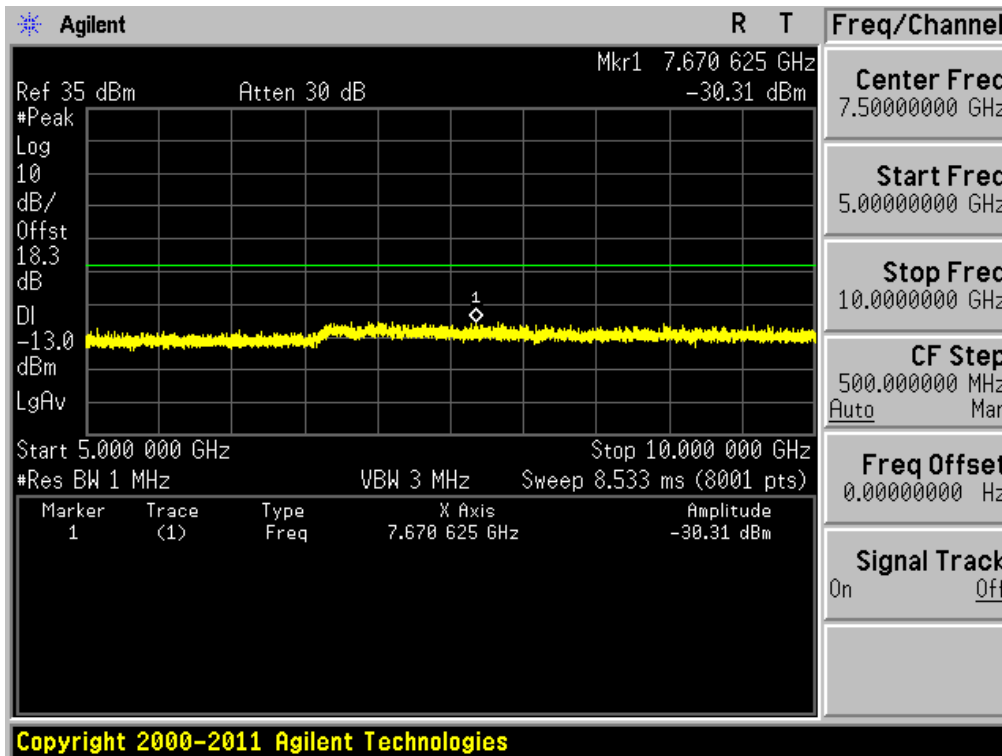

PCS1900 & Channel: 810

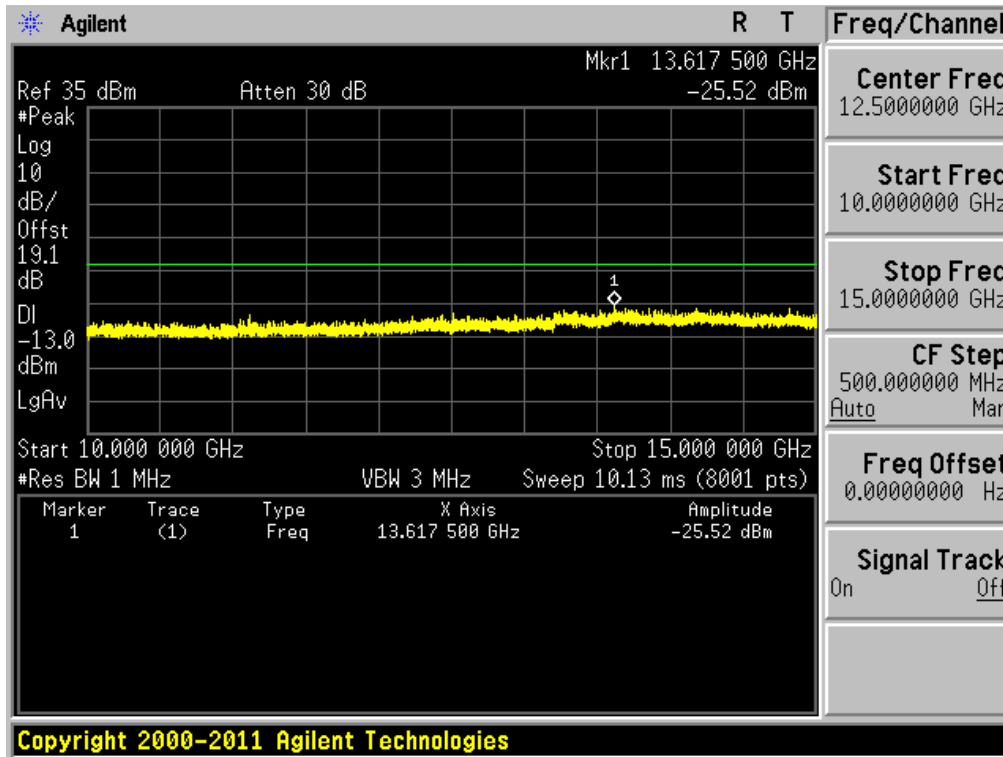

PCS1900 & Channel: 810

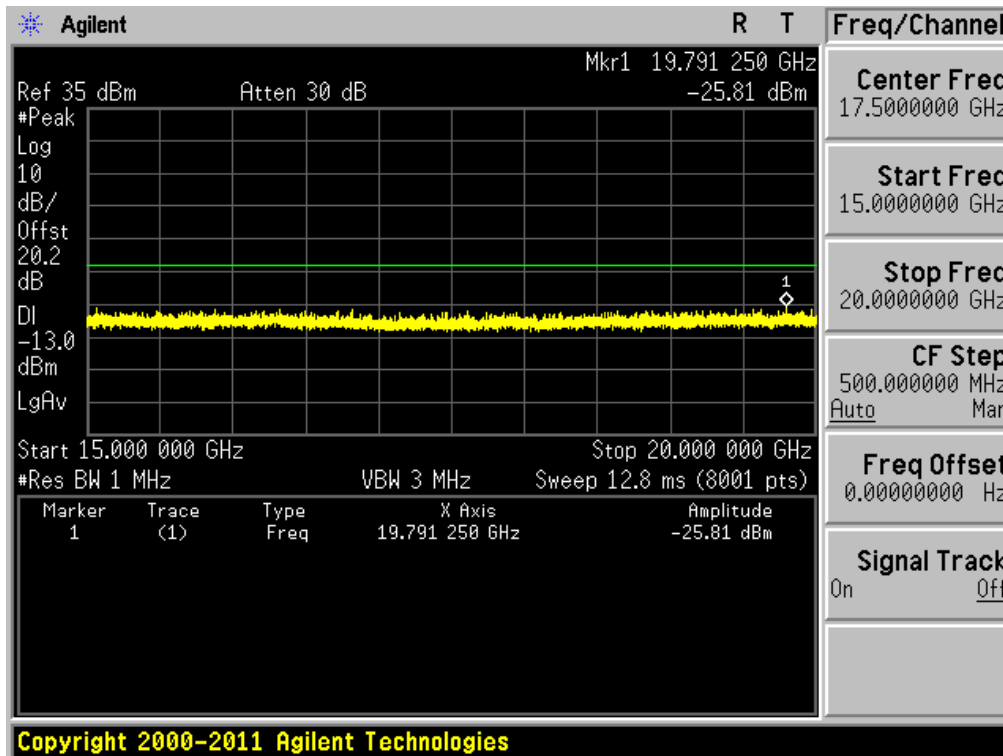

8.4 Band Edge

GSM850 & Channel: 128

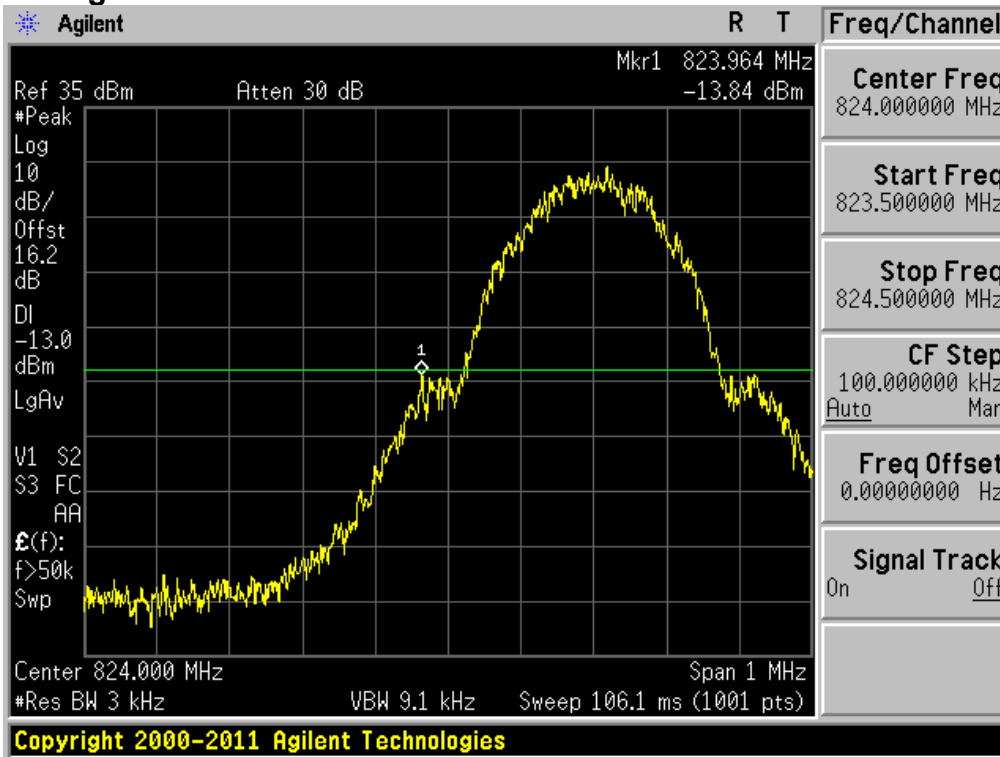

GSM850 & Channel: 251

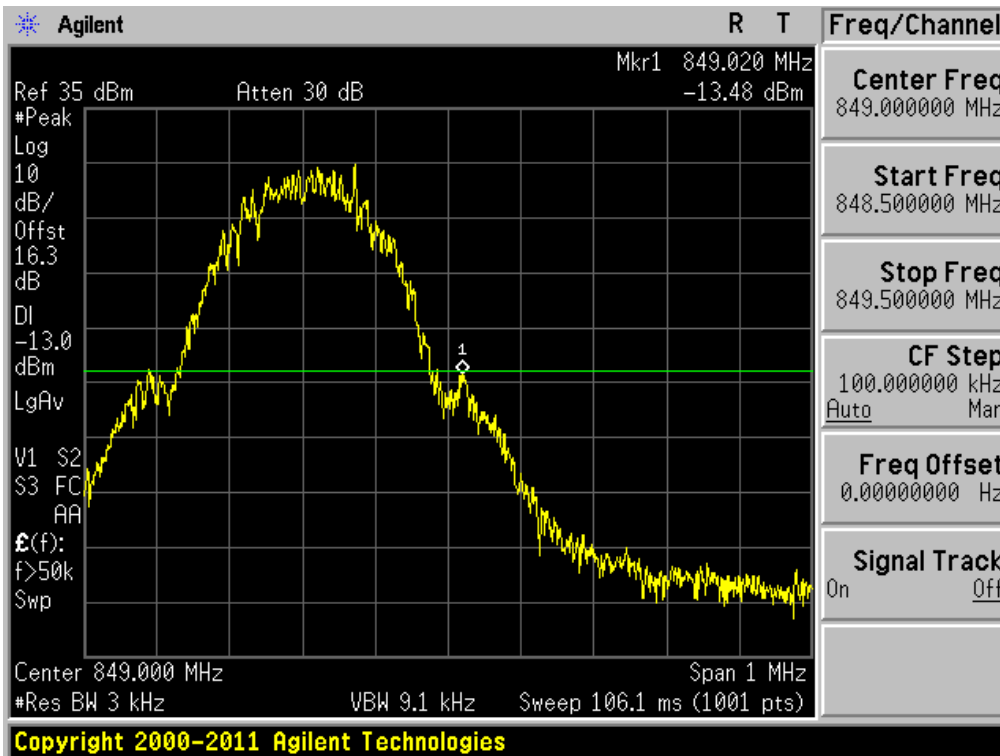

CDMA850 & Channel: 1013

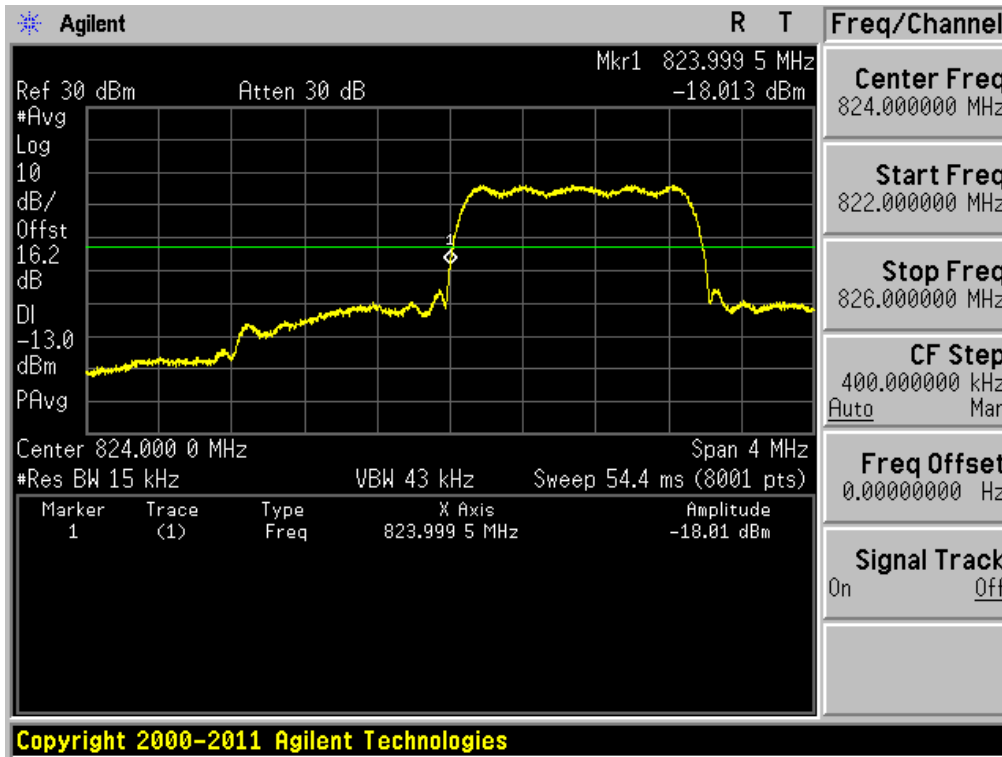

CDMA850 & Channel: 1013

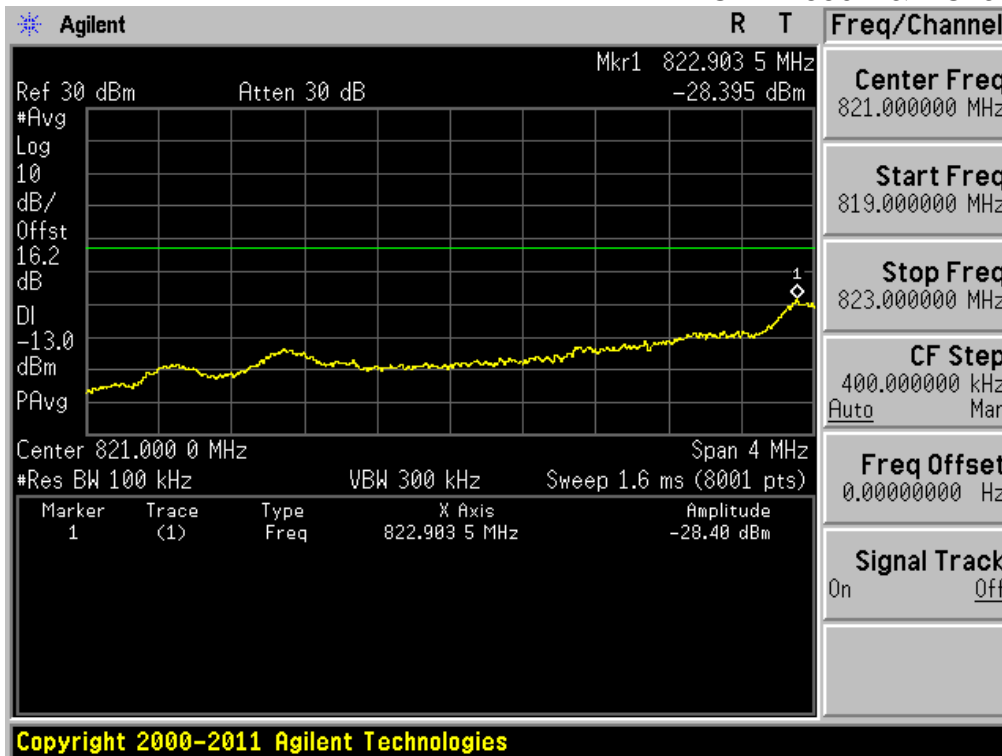

CDMA850 & Channel: 777

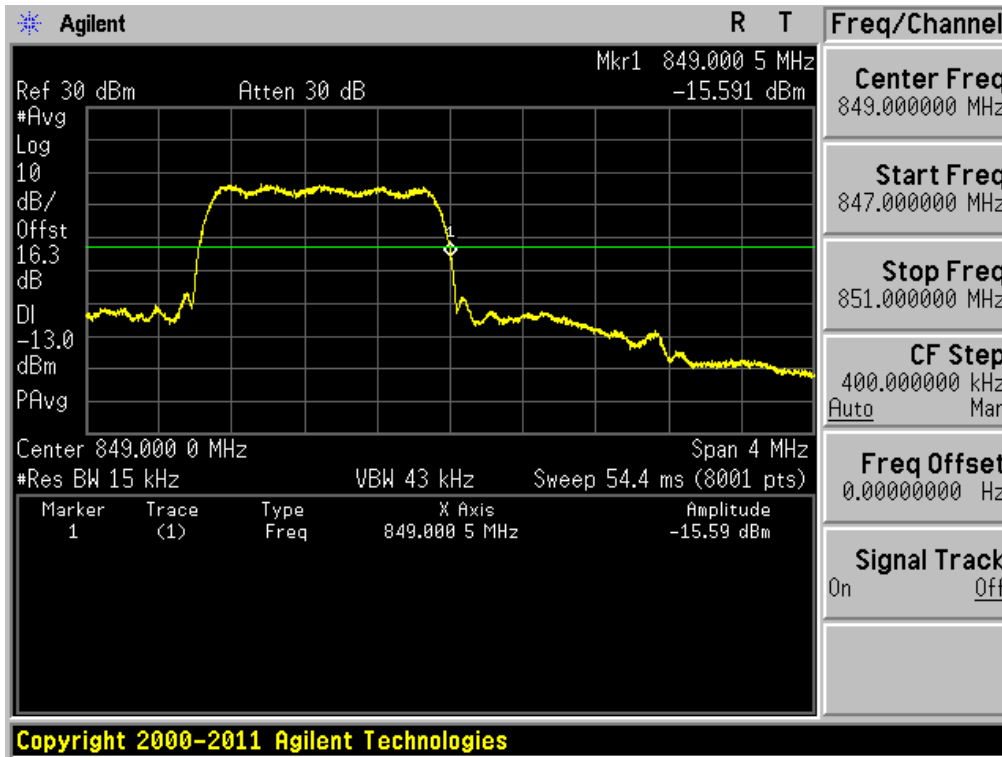

CDMA850 & Channel: 777

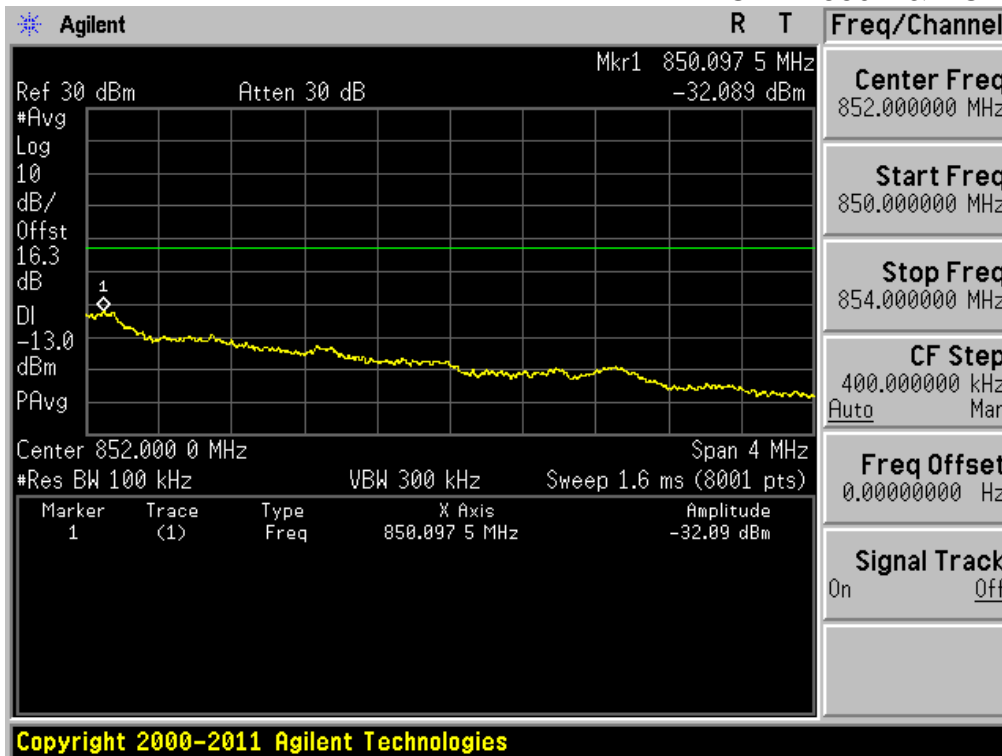

WCDMA850 & Channel: 4132

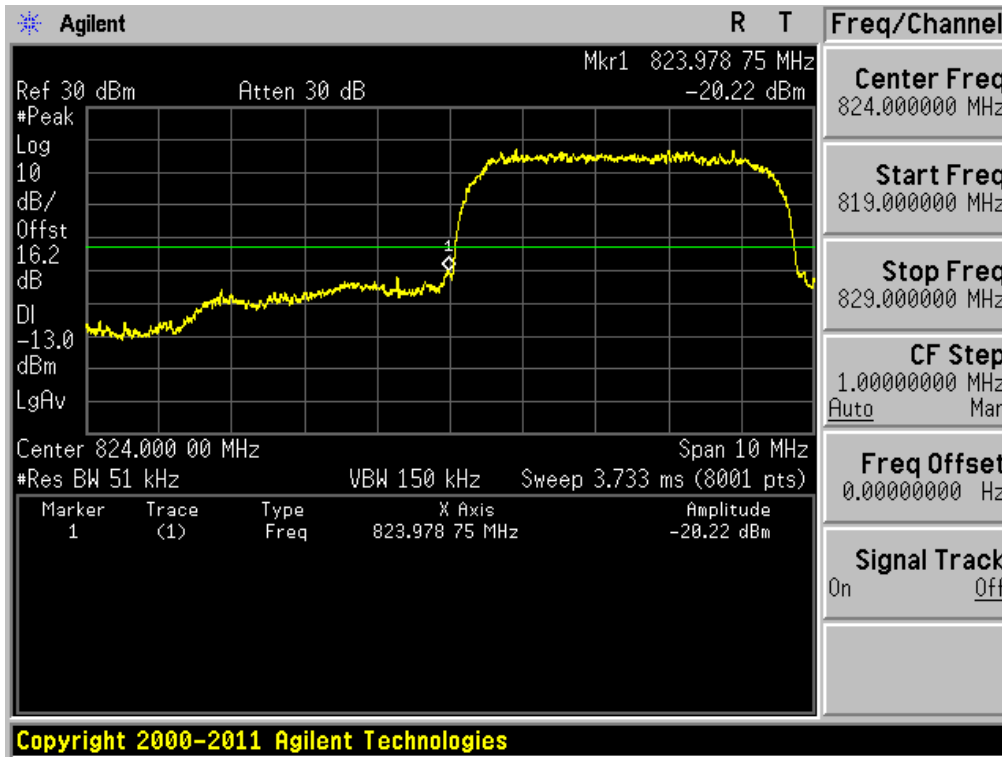

WCDMA850 & Channel: 4132

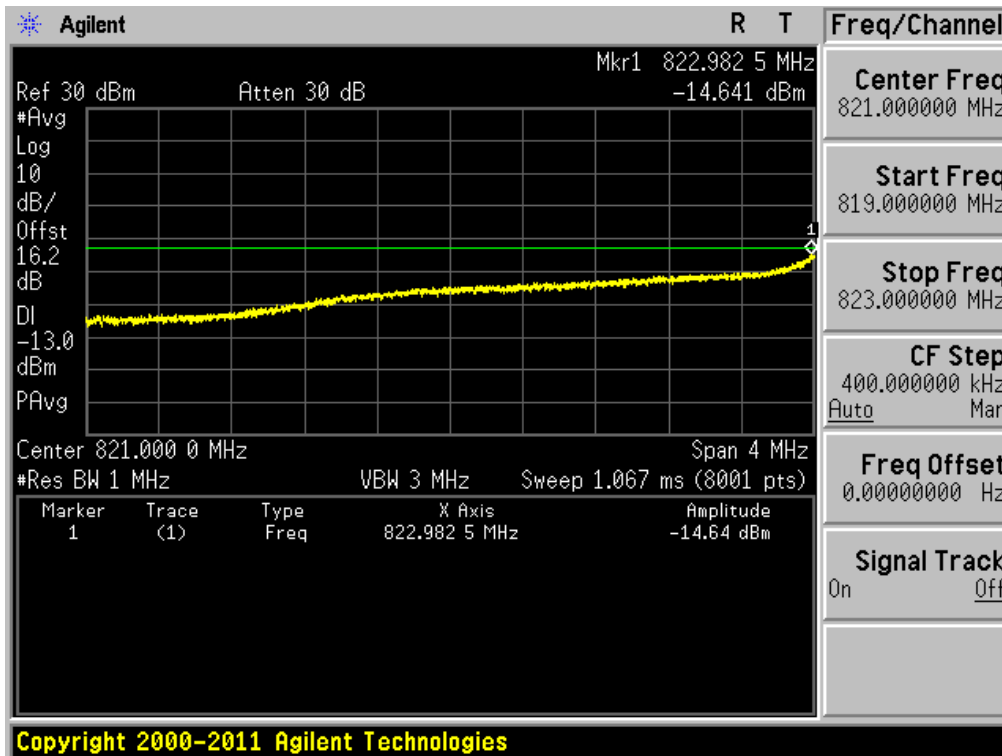

WCDMA850 & Channel: 4233

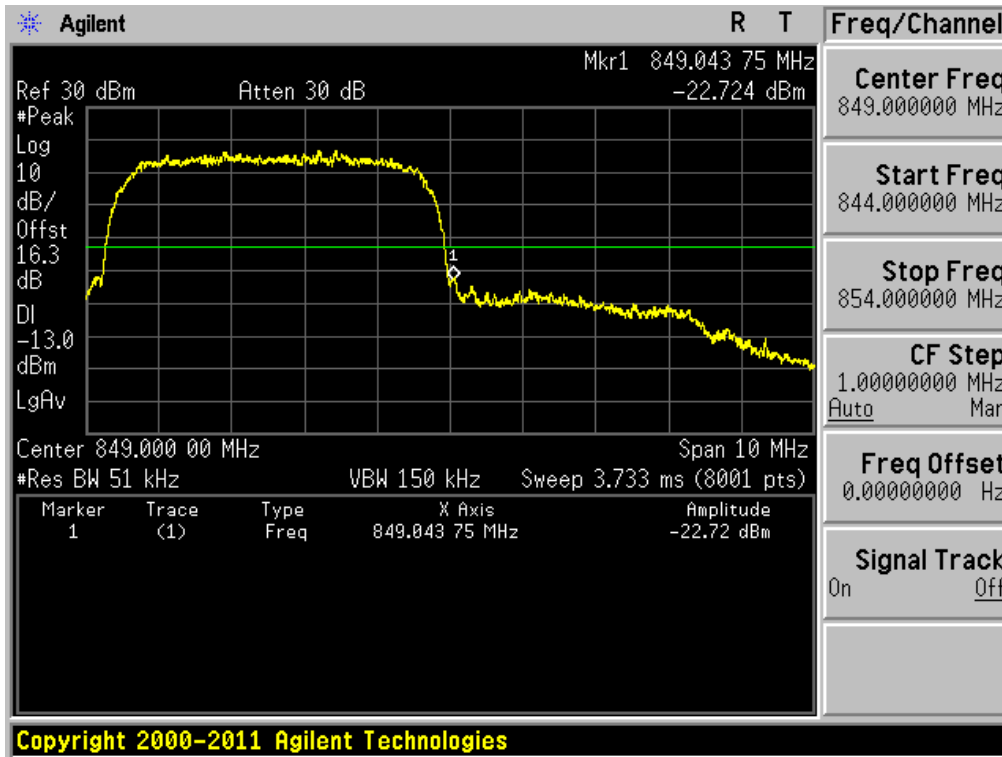

WCDMA850 & Channel: 4233

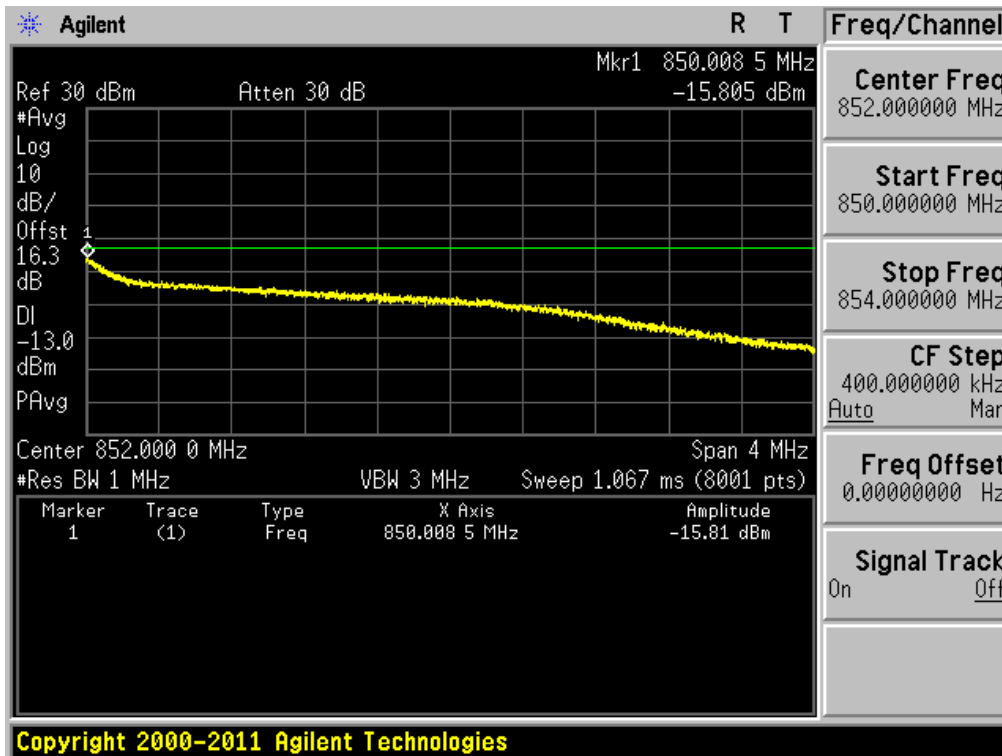

PCS1900 & Channel: 512

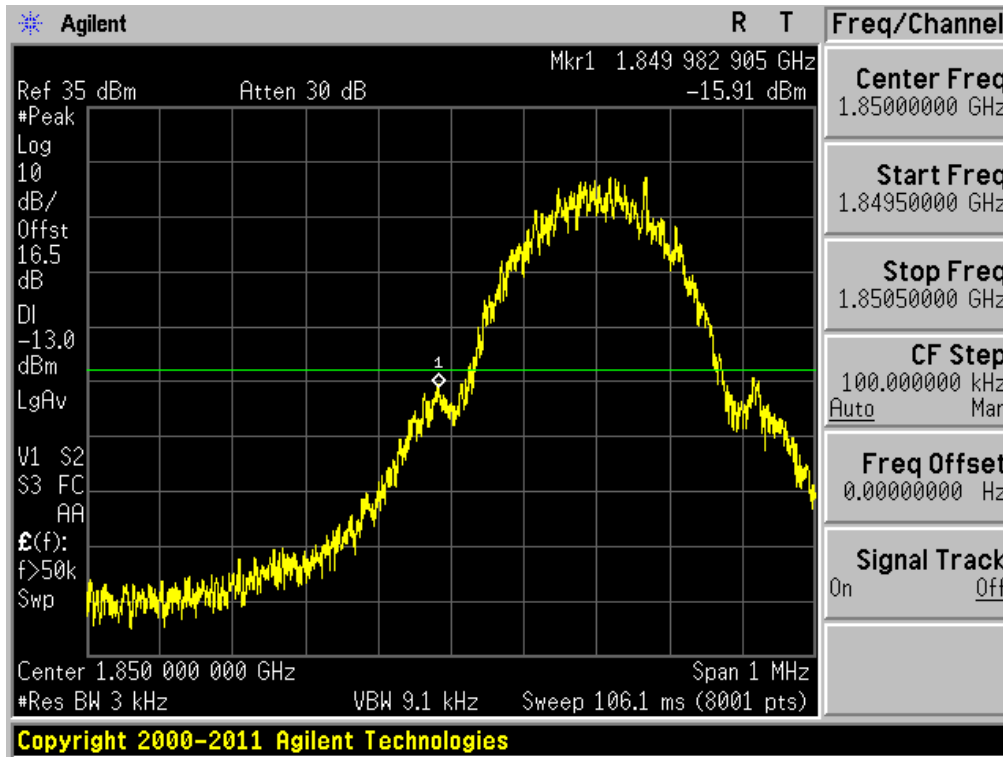

PCS1900 & Channel: 810

