

# TEST REPORT

Report number : Z101C-14136

Issue date : January 27, 2015

The device, as described herewith, was tested pursuant to applicable test procedure and complies with the requirements of;

## FCC 47CFR §2. 1093

The test results are traceable to the international or national standards.

Applicant	: KYOCERA Corporation
Equipment under test (EUT)	: Mobile Phone
Model number	: KYV33
FCC ID	: JOYKYV33

Date of test : December 15-19, 22, 23, 25, 2014 / January 21-23, 2015  
 Test place : TÜV SÜD Zacta Ltd. Yonezawa Testing Center  
 4149-7 Hachimanpara 5-chome  
 Yonezawa-shi Yamagata 992-1128 Japan  
 Phone: +81-238-28-2880 Fax: +81-238-28-2888  
 Test results : Complied

The results in this report are applicable only to the equipment tested.  
 This report shall not be re-produced except in full without the written approval of TÜV SÜD Zacta Ltd.  
 This test report must not be used by client to claim product certification, approval, or endorsement by NVLAP, NIST, or any agency of the federal government.

Tested by : Kazunori Saito Chiaki Kanno  
 Kazunori Saito Chiaki Kanno

Authorized by : Eiji Akiba  
 Eiji Akiba  
 Manager of EMC Technical Department



## ***Table of contents***

---

	<b>Page</b>
<b>1. Summary of Test .....</b>	<b>4</b>
1.1 Purpose of test .....	4
1.2 Standards .....	4
1.3 Modification to the EUT by laboratory .....	4
<b>2. Equipment Under Test .....</b>	<b>5</b>
2.1 General description of equipment .....	5
2.2 EUT information .....	5
2.3 Variation of the family model(s) .....	6
2.4 Description of test modes .....	6
2.5 Test Results .....	7
2.6 Nominal and Maximum Output Power Specifications .....	8
2.7 DUT Antenna Locations & SAR Test Configurations .....	10
2.8 Near Field Communications (NFC) Antenna .....	12
2.9 SAR Test Exclusions Applied .....	13
2.10 Power Reduction for SAR .....	14
2.11 Device Serial Numbers .....	14
<b>3. Introduction .....</b>	<b>15</b>
<b>4. Description of test equipment .....</b>	<b>16</b>
4.1 SAR Measurement Setup .....	16
4.2 Probe measurement system .....	17
4.3 Probe calibration process .....	18
4.4 SAM Twin phantom .....	20
4.5 Device Holder for Transmitters .....	21
4.6 Brain & Muscle Simulating Mixture Characterization .....	21
4.7 SAR Test equipment .....	22
<b>5. Test system specifications .....</b>	<b>24</b>
<b>6. SAR Measurement Procedure .....</b>	<b>25</b>
<b>7. Definition of reference points .....</b>	<b>26</b>
7.1 EAR Reference Point .....	26
7.2 Handset Reference Points .....	26
7.3 Device Holder .....	27
7.4 Positioning for Cheek/Touch .....	27
7.5 Positioning for Ear / 15 ° Tilt .....	27
7.6 Body-Worn Accessory Configurations .....	28
7.7 Extremity Exposure Configurations .....	28
7.8 Wireless Router Configurations .....	28
<b>8. ANSI / IEEE C95.1-2005 RF Exposure Limits .....</b>	<b>29</b>
<b>9. FCC Measurement Procedures .....</b>	<b>30</b>
9.1 Measured and Reported SAR .....	30
9.2 Procedures Used to Establish RF Signal for SAR .....	30
9.3 SAR Measurement Conditions for WCDMA(UMTS) .....	30
9.3.1 Output Power Verification .....	30
9.3.2 Head SAR Measurements for Handsets .....	30



Zacta

9.3.3 Body SAR Measurements .....	30
9.3.4 SAR Measurements for Handsets with Rel 5 HSDPA.....	31
9.3.5 SAR Measurements for Handsets with Rel 6 HSUPA.....	31
9.4 SAR Measurement Conditions for LTE.....	32
9.5 SAR Testing with 802.11 Transmitters .....	33
9.5.1 General Device Setup .....	33
9.5.2 Frequency Channel Configurations .....	33
<b>10. RF Conducted Power .....</b>	<b>34</b>
10.1 GSM Conducted Powers.....	34
10.2 WCDMA Conducted Powers.....	35
10.3 LTE Conducted Powers.....	36
10.4 WLAN Conducted Powers .....	38
10.5 Bluetooth Conducted Powers .....	42
<b>11. System Verification.....</b>	<b>43</b>
11.1 Tissue verification.....	43
11.2 Test system verification .....	47
<b>12. SAR Test Results.....</b>	<b>50</b>
12.1 Head SAR Results .....	50
12.2 Standalone Body-Worn SAR Results .....	56
12.3 Standalone Wireless router SAR Results .....	60
12.4 SAR Test Notes .....	65
<b>13. FCC Multi-TX and Antenna SAR Considerations.....</b>	<b>67</b>
13.1 Introduction .....	67
13.2 Simultaneous Transmission Procedures.....	67
13.3 Simultaneous Transmission Capabilities.....	67
13.4 Simultaneous Transmission SAR Analysis .....	68
13.5 Head SAR Simultaneous Transmission Analysis .....	70
13.6 Body-Worn Simultaneous Transmission Analysis .....	77
13.7 Hotspot SAR Simultaneous Transmission Analysis.....	81
13.8 SAR to Peak Location Separation Ratio (SPLSR).....	82
13.9 Simultaneous Transmission Conclusion .....	98
<b>14. SAR Measurement Variability.....</b>	<b>101</b>
14.1 Measurement Variability.....	101
14.2 Measurement Uncertainty.....	101
<b>15. IEEE P1528 - Measurement uncertainties .....</b>	<b>102</b>
<b>16. Conclusion.....</b>	<b>116</b>
<b>17. References.....</b>	<b>117</b>
<b>Attachment 1. Probe calibration data .....</b>	<b>119</b>
<b>Attachment 2. Dipole calibration data .....</b>	<b>142</b>
<b>Attachment 3. SAR system validation.....</b>	<b>215</b>



Zacta

## 1. Summary of Test

---

### 1.1 Purpose of test

It is the original test in order to verify conformance to standards listed in section 1.2.

### 1.2 Standards

FCC 47CFR §2. 1093

#### 1.2.1 Guidance applied

- FCC OET Bulletin 65 Supplement C [June 2001]
- IEEE 1528-2003
- FCC KDB Publication 941225 D01 v03 (3G SAR Procedures)
- FCC KDB Publication 941225 D05 v02r03 (SAR for LTE Devices)
- FCC KDB Publication 941225 D05A v01r01 (LTE Rel.10 KDB Inquiry Sheet)
- FCC KDB Publication 941225 D06 v02 (Hotspot Mode)
- FCC KDB Publication 248227 D01 v01r02 (SAR Considerations for 802.11 Devices)
- FCC KDB Publication 447498 D01 v05r02 (General SAR Guidance)
- FCC KDB Publication 865664 D01 v01r03, D02 v01r01 (SAR Measurements up to 6 GHz)
- FCC KDB Publication 648474 D04 v01r02 (Handset SAR)
- October 2012 TCB Workshop Notes (IEEE 802.11ac)

#### 1.2.2 Deviation from standards

None

### 1.3 Modification to the EUT by laboratory

None

## 2. Equipment Under Test

---

### 2.1 General description of equipment

EUT is the Mobile Phone.

### 2.2 EUT information

Applicant	: KYOCERA Corporation Yokohama Office 2-1-1 Kagahara, Tsuzuki-ku Yokohama-shi, Kanagawa, Japan Phone: +81-45-943-6253 Fax: +81-45-943-6314
Equipment under test	: Mobile Phone
Trade name	: Kyocera
Model number	: KYV33
Serial number	: N/A
EUT condition	: Pre-Production
Power ratings	: Battery: DC 3.8V
Size	: (W) 68.0 × (D) 8.9 × (H) 131.0 mm
Environment	: Indoor and Outdoor use
Terminal limitation	: -20°C to 60°C
RF Specification	
Equipment type	: Transceiver
Mode(s) of operation	: GSM850, PCS1900, WCDMA850, WCDMA1900, LTE Band 17, 2.4GHz W-LAN(802.11b, 802.11g, 802.11n HT20), 5GHz W-LAN(802.11a, 802.11n HT20, HT40, 802.11ac VHT20, VHT40, VHT80)
Antenna type	: Internal antenna
Antenna gain	: GSM 850: -1.7dBi PCS 1900: -3.8dBi WCDMA 850: -1.7dBi WCDMA 1900: 1.2dBi LTE Band 17: -7.0dBi 2.4GHz W-LAN: -0.2dBi 5.2, 5.3GHz W-LAN: -0.8dBi 5.6GHz W-LAN: -0.3dBi



Zacta

Frequency of operation : Up Link  
 GSM 850: 824.2-848.8MHz(Cellular Band)  
 PCS 1900: 1850.2-1909.8MHz(PCS Band)  
 WCDMA 850: 826.4-846.6MHz(WCDMA FDD V)  
 WCDMA 1900: 1852.4-1907.6MHz(WCDMA FDD II)  
 LTE Band 17: 706.5-713.5MHz  
 802.11b: 2412-2462MHz  
 802.11a: 5180-5240MHz(5.2GHz Band) / 5260-5320MHz(5.3GHz Band)  
 5500-5700MHz(5.5GHz Band)

Down Link  
 GSM 850: 869.2-893.8MHz(Cellular Band)  
 PCS 1900: 1930.2-1989.8MHz(PCS Band)  
 WCDMA 850: 871.4-891.6MHz(WCDMA FDD V)  
 WCDMA 1900: 1932.4-1987.6MHz(WCDMA FDD II)  
 LTE Band 17: 734.0-746.0MHz  
 802.11b: 2412-2462MHz  
 802.11a: 5180-5240MHz(5.2GHz Band) / 5260-5320MHz(5.3GHz Band)  
 5500-5700MHz(5.5GHz Band)

### 2.3 Variation of the family model(s)

Not applicable

### 2.4 Description of test modes

The EUT had been tested under operating condition.  
 There are three channels have been tested as following:

Band	Channel	Test mode
GSM 850	128, 190, 251	Voice/Data
PCS 1900	512, 661, 810	Voice/ Data
WCDMA 850	4132, 4183, 4233	Voice/ Data
WCDMA 1900	9262, 9400, 9538	Voice/ Data
LTE Band 17	23780, 23790, 23800(BW:10MHz) 23755, 23790, 23825(BW:5MHz)	Data
2.4GHz W-LAN	1, 6, 11	Data
5.2GHz W-LAN	36, 40, 48	Data
5.3GHz W-LAN	52, 56, 64	Data
5.5GHz W-LAN	100, 116, 140	Data
Bluetooth	0, 39, 78	Data

5.8 GHz Band is not supported for this device.

For the second mode, and test it against RF exposure of the best at each position of the channel in the worst case.

## 2.5 Test Results

Equipment Class	Band	Measured Conducted Power [dBm]	Reported SAR 1g SAR [W/kg]		
			Head	Body-worn	Hotspot
PCE	GSM 850	32.67	0.401	0.645	-
	GPRS 850	29.21	0.986	1.57	1.57
	PCS 1900	29.22	0.156	0.452	-
	GPRS 1900	28.67	0.242	0.674	0.674
	WCDMA 850	23.53	0.345	0.627	0.627
	WCDMA 1900	22.63	0.182	1.54	1.54
	LTE Band 17	23.95	0.154	0.290	0.290
DTS	2.4GHz W-LAN	16.07	0.0209	0.184	0.184
NII	5.2GHz W-LAN	12.59	0.531	0.132	-
	5.3GHz W-LAN	12.91	0.611	0.118	-
	5.5GHz W-LAN	12.96	1.15	0.204	-
DSS/DTS	Bluetooth	7.47	N/A	N/A	N/A
Simultaneous SAR per KDB 690783 D01v01r03			1.54	1.59	1.49

## 2.6 Nominal and Maximum Output Power Specifications

This device operates using the following maximum and nominal output power specifications.

SAR values were scaled to the maximum allowed power to determine compliance per KDB Publication 447498 D01v05r02.

Band & Mode		Voice [dBm]	Burst Average GMSK [dBm]			
			1TX Slot	2TX Slot	3TX Slot	4TX Slot
GSM/GPRS 850	Maximum	33.0	33.0	32.5	30.0	29.5
	Nominal	32.0	32.0	31.5	29.0	28.5
GSM/GPRS 1900	Maximum	30.0	30.0	29.0	27.0	26.0
	Nominal	29.0	29.0	28.0	26.0	25.0

Band & Mode		Modulated Average [dBm]		
		3GPP RMC	3GPP HSDPA	3GPP HSUPA
WCDMA 850	Maximum	24.0	24.0	24.0
	Nominal	23.0	23.0	23.0
WCDMA 1900	Maximum	23.0	23.0	23.0
	Nominal	22.0	22.0	22.0

Band & Mode		Modulated Average [dBm]
LTE Band17	Maximum	24.5
	Nominal	23.5



Band & Mode		Modulated Average [dBm]
IEEE 802.11b (2.4 GHz)	Maximum	16.9
	Nominal	16.0
IEEE 802.11g (2.4 GHz)	Maximum	12.9
	Nominal	12.0
IEEE 802.11n (2.4 GHz)	Maximum	12.9
	Nominal	12.0
IEEE 802.11a (5.2 GHz)	Maximum	13.0
	Nominal	12.0
IEEE 802.11a (5.3 / 5.6 GHz)	Maximum	13.0
	Nominal	12.0
IEEE 802.11n (5.2 GHz 20MHz BW)	Maximum	13.0
	Nominal	12.0
IEEE 802.11n (5.3 / 5.6 GHz 20MHz BW)	Maximum	13.0
	Nominal	12.0
IEEE 802.11n (5.2 / 5.3 / 5.6 GHz 40MHz BW)	Maximum	13.0
	Nominal	12.0
IEEE 802.11ac (5.2 GHz 20MHz BW)	Maximum	13.0
	Nominal	12.0
IEEE 802.11ac (5.3 / 5.6 GHz 20MHz BW)	Maximum	13.0
	Nominal	12.0
IEEE 802.11ac (5 GHz 40MHz BW)	Maximum	13.0
	Nominal	12.0
IEEE 802.11ac (5 GHz 80MHz BW)	Maximum	13.0
	Nominal	12.0
Bluetooth	Maximum	7.9
	Nominal	7.0
Bluetooth LE	Maximum	0.9
	Nominal	0.0

## 2.7 DUT Antenna Locations & SAR Test Configurations

### DUT Antenna Locations(Case Back side view)

Note: Specific antenna dimensions and separation distances are shown in the antenna distance document.

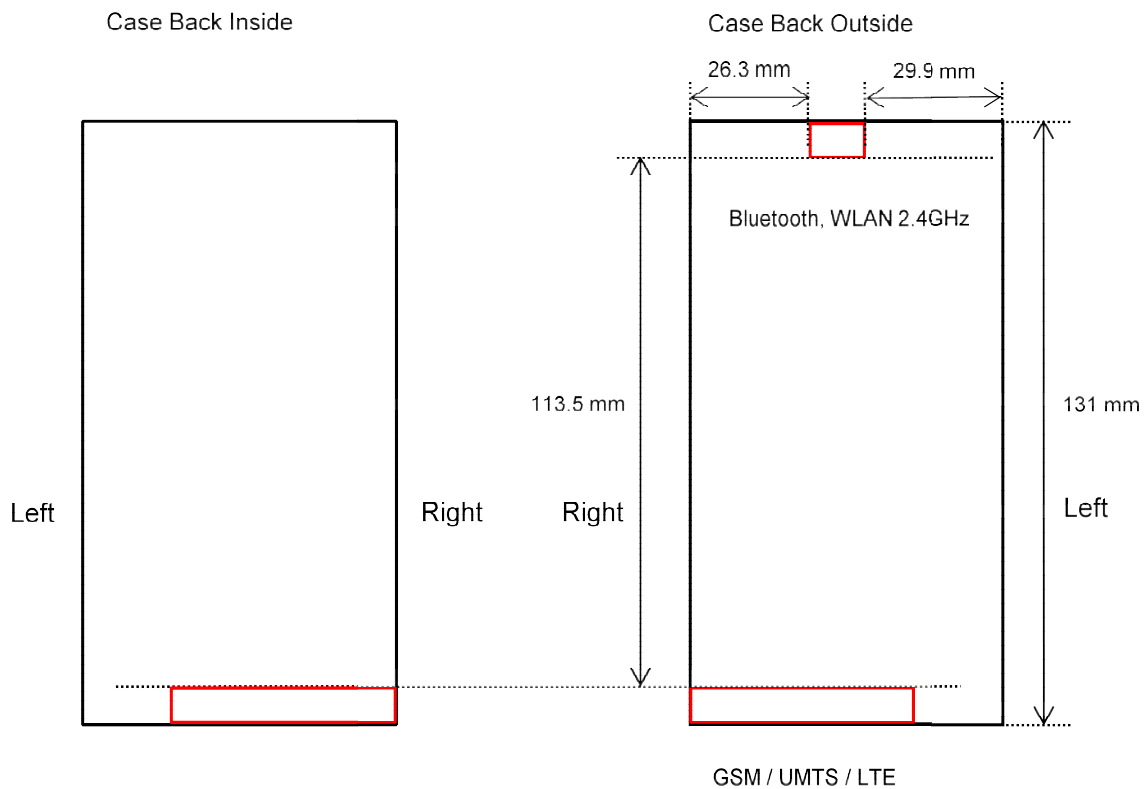
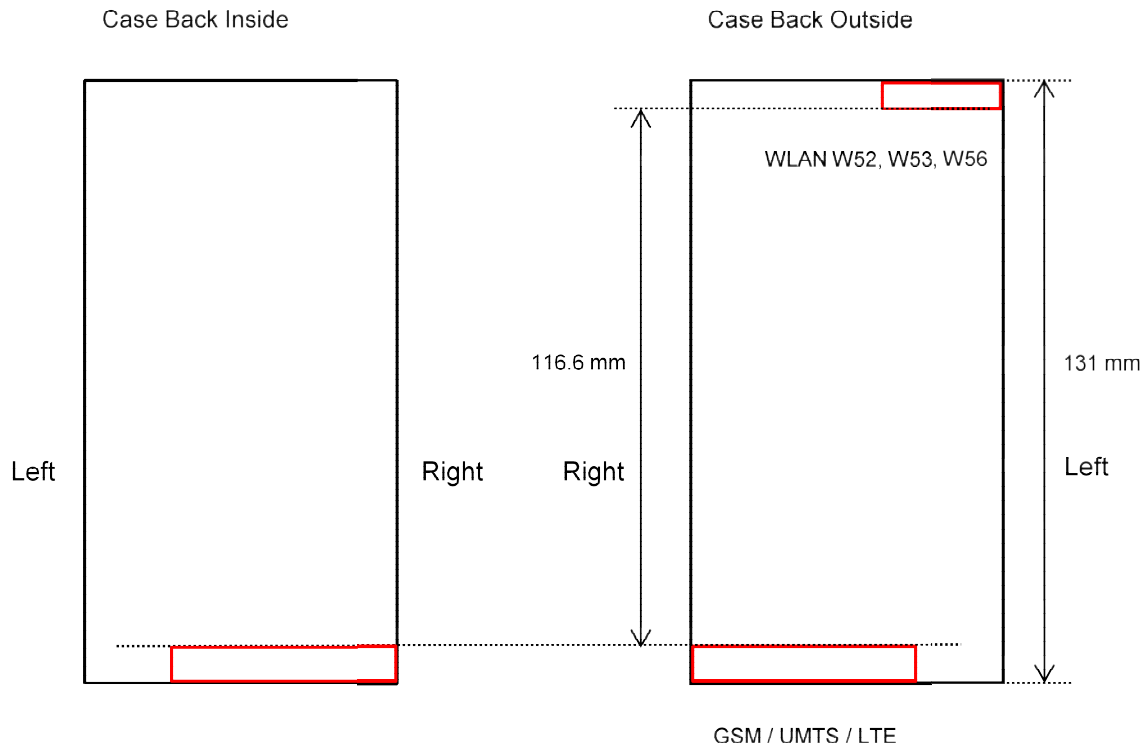

## SAR Test Configurations

Mode	Mobile Hotspot Sides for SAR Testing					
	Top	Bottom	Front	Rear	Right	Left
GSM 850	X	0	0	0	0	0
GSM 1900	X	0	0	0	0	0
WCDMA 850	X	0	0	0	0	0
WCDMA 1900	X	0	0	0	0	0
LTE Band 17	X	0	0	0	0	0
2.4GHz W-LAN(802.11b/g/n)	0	X	0	0	X	X

**Table 2.1 Mobile Hotspot Sides for SAR Testing**

**Note:**

- Particular DUT edges were not required to be evaluated for Wireless Router SAR if the edges were greater than 2.5 cm from the transmitting antenna according to FCC KDB Publication 941225 D06 v02 guidance, page 2. The antenna document shows the distances between the transmit antennas and the edges of the device. When the wireless router mode is enabled, all 5 GHz bands are disabled. Therefore 5 GHz WIFI Wireless Router SAR is not considered in this section.
- 5 GHz WIFI Direct GO is not supported in the 5 GHz band for this device. WIFI Direct GO is supported in the 2.4 GHz band only. The manufacturer expects 2.4 GHz WIFI Direct GO may be used in a similar manner to wireless router usage. Therefore, 2.4 GHz WIFI Direct GO was evaluated for SAR similarly to wireless router SAR procedures in FCC KDB Publication 941225.

## 2.8 Near Field Communications (NFC) Antenna

### NFC Antenna Locations (Rear Side View)

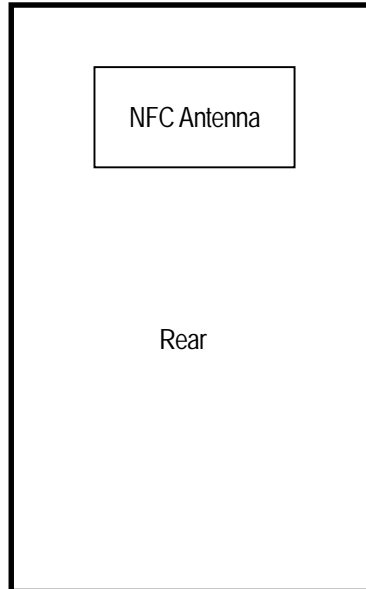

This DUT has NFC operations. The NFC antenna is integrated into the back cover. Therefore, all SAR tests performed with the device already incorporate the NFC antenna.

## 2.9 SAR Test Exclusions Applied

### (A) WIFI & BT

Since Wireless Router operations are not allowed by the chipset firmware using 5 GHz WIFI, only 2.4 GHz WIFI Hotspot SAR tests and combinations are considered for SAR with respect to Wireless Router configurations according to FCC KDB 941225 D06 v02.

Per FCC KDB 447498 D01v05r02, the SAR exclusion threshold for distances < 50 mm is defined by the following equation:

$$\frac{\text{Max Power of Channel (mW)}}{\text{Test Separation Dist (mm)}} * \sqrt{\text{Frequency(GHz)}} \leq 3.0$$

Based on the maximum conducted power of Bluetooth (rounded to the nearest mW) and the antenna to user separation distance, Bluetooth SAR was not required;  $[(6/10) * \sqrt{2.480}] = 1.0 < 3.0$ .

Based on the maximum conducted power of Bluetooth LE (rounded to the nearest mW) and the antenna to user separation distance, Bluetooth LE SAR was not required;  $[(1/10) * \sqrt{2.480}] = 0.2 < 3.0$ .

Based on the maximum conducted power of 2.4 GHz WIFI (rounded to the nearest mW) and the antenna to user separation distance, 2.4 GHz WIFI SAR was required;  $[(50/10) * \sqrt{2.437}] = 7.8 > 3.0$ .

Based on the maximum conducted power of 5 GHz WIFI (rounded to the nearest mW) and the antenna to user separation distance, 5 GHz WIFI SAR was required;  $[(28/10) * \sqrt{5.700}] = 6.7 > 3.0$ .

Per KDB Publication 447498 D01v05r02, the maximum power of the channel was rounded to the nearest mW before calculation.

This device supports 20 MHz and 40 MHz Bandwidths for IEEE 802.11n for 5 GHz WIFI only. IEEE 802.11n was not evaluated for SAR since the average output power of 20 MHz and 40 MHz bandwidths was not more than 0.25 dB higher than the average output power of IEEE 802.11a.

This device supports IEEE 802.11ac with the following features:

- a) Up to 80 MHz Bandwidth only
- b) No aggregate channel configurations
- c) 1 Tx antenna output
- d) 256 QAM is supported
- e) No new 5 GHz channels

Per April 2013 TCB workshop notes, full SAR tests for all IEEE 802.11ac configurations were not required because the average output power was not more than 0.25 dB higher than IEEE 802.11a mode.

IEEE 802.11ac was evaluated for the highest IEEE 802.11a position in each 5 GHz band and exposure condition.

### (B) Licensed Transmitter(s)

GSM/GPRS DTM is not supported for US bands.

Therefore, the GSM Voice modes in this report do not transmit simultaneously with GPRS Data. And this device is only supported for EDGE Rx.

WCDMA 850 and WCDMA 1900 support HSDPA and HSUPA.

## 2.10 Power Reduction for SAR

There is no power reduction used for any band/mode implemented in this device for SAR purposes.

## 2.11 Device Serial Numbers

Band & Mode	Head Serial Number		Body-Worn Serial Number		Hotspot Serial Number	
	SAR Sample No.10	SAR Sample No.11	SAR Sample No.10	SAR Sample No.11	SAR Sample No.10	SAR Sample No.11
GSM 850	FCC #1	FCC #2	FCC #1	FCC #2	FCC #1	FCC #2
GSM 1900						
WCDMA 850						
WCDMA 1900						
LTE Band 17						
2.4GHz W-LAN						
5GHz W-LAN						

### 3. Introduction

The FCC and Industry Canada have adopted the guidelines for evaluating the environmental effects of radio frequency (RF) radiation in ET Docket 93-62 on Aug. 6, 1996 and Health Canada Safety Code 6 to protect the public and workers from the potential hazards of RF emissions due to FCC-regulated portable devices.

The FCC has adopted the guidelines for evaluating the environmental effects of radio frequency radiation in ET Docket 93-62 on Aug. 6, 1996 to protect the public and workers from the potential hazards of RF emissions due to FCC-regulated portable devices. The safety limits used for the environmental evaluation measurements are based on the criteria published by the American National Standards Institute (ANSI) for localized specific absorption rate (SAR) in IEEE/ANSI C95\*.1-2005 Standard for Safety Levels with Respect to Human Exposure to Radio Frequency Electromagnetic Fields, 3 kHz to 300 GHz. 1992 by the Institute of Electrical and Electronics Engineers, Inc., New York, New York 10017.

The measurement procedure described in IEEE/ANSI C95.3-1992 Recommended Practice for the Measurement of Potentially Hazardous Electromagnetic Fields - RF and Microwave is used for guidance in measuring SAR due to the RF radiation exposure from the Equipment Under Test (EUT). These criteria for SAR evaluation are similar to those recommended by the National Council on Radiation Protection and Measurements (NCRP) in Biological Effects and Exposure Criteria for Radio frequency Electromagnetic Fields," NCRP Report No. 86 NCRP, 1986, Bethesda, MD 20814. SAR is a measure of the rate of energy absorption due to exposure to an RF transmitting source. SAR values have been related to threshold levels for potential biological hazards.

#### SAR Definition

Specific Absorption Rate (SAR) is defined as the time derivative (rate) of the incremental energy (dU) absorbed by (dissipated in) an incremental mass (dm) contained in a volume element (dV) of a given density (ρ) It is also defined as the rate of RF energy absorption per unit mass at a point in an absorbing body.

$$\text{SAR} = \frac{d}{dt} \left[ \frac{dU}{dm} \right] = \frac{d}{dt} \left[ \frac{dU}{\rho dV} \right]$$

SAR is expressed in units of Watts per Kilogram (W/kg).

$$\text{SAR} = \frac{\sigma \cdot E^2}{\rho}$$

Where:

σ= conductivity of the tissue - simulating material (S/m)

ρ= mass density of the tissue-simulating material (kg/m<sup>3</sup>)

E = Total RMS electric field strength (V/m)

NOTE: The primary factors that control rate of energy absorption were found to be the wavelength of the incident field in relations to the dimensions and geometry of the irradiated organism, the orientation of the organism in relation to the polarity of field vectors, the presence of reflecting surfaces, and whether conductive contact is made by the organism with a ground plane.

## 4. Description of test equipment

### 4.1 SAR Measurement Setup

Measurements are performed using the DASY5 automated dosimetric assessment system. The DASY5 is made by Schmid & Partner Engineering AG (SPEAG) in Zurich, Switzerland and consists of high precision robotics system (Staubli), robot controller, desktop computer, near-field probe, probe alignment sensor, and the generic twin phantom containing the brain equivalent material. The robot is a six-axis industrial robot performing precise movements to position the probe to the location (points) of maximum electromagnetic field (EMF) (see Fig. 4.1).

A cell controller system contains the power supply, robot controller teach pendant (Joystick), and a remote control used to drive the robot motors. The PC consists of the Intel Core i7-3770 3,40 GHz desktop computer with Windows NT system and SAR Measurement Software DASY5, A/D interface card, monitor, mouse, and keyboard. The Staubli Robot is connected to the cell controller to allow software manipulation of the robot. A data acquisition electronic (DAE) circuit that performs the signal amplification, signal multiplexing, AD-conversion, offset measurements, mechanical surface detection, collision detection, etc. is connected to the Electro-optical coupler (EOC). The EOC performs the conversion from the optical into digital electric signal of the DAE and transfers data to the PC plug-in card.

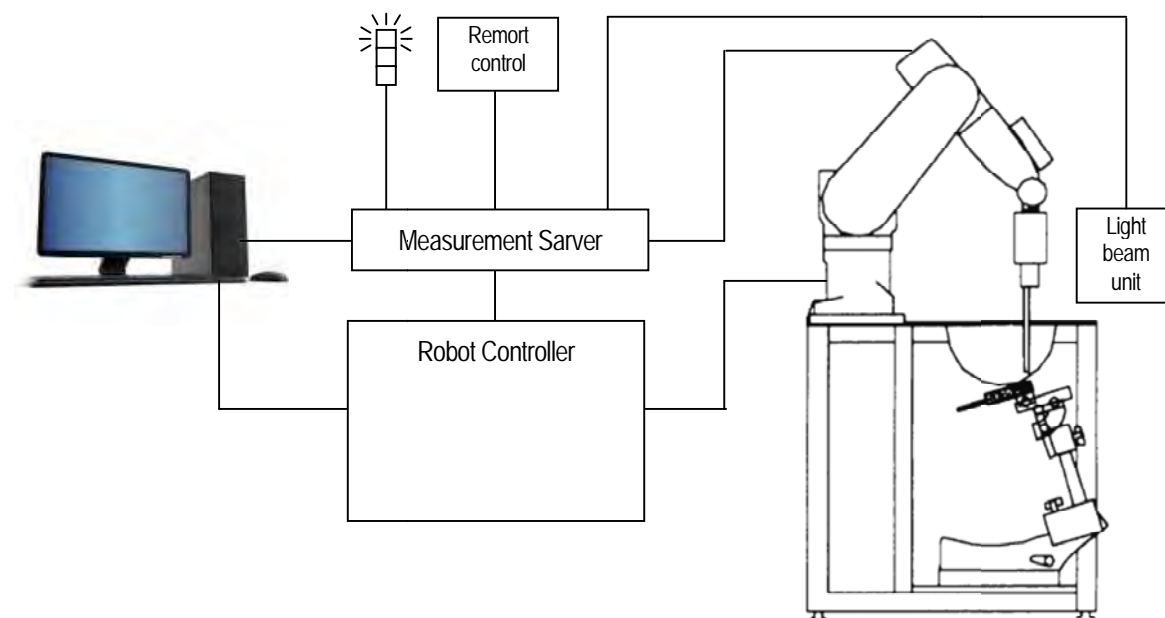

Figure 4.1 SAR Measurement system setup

The DAE consists of a highly sensitive electrometer-grade preamplifier with auto-zeroing, a channel and gain-switching multiplexer, a fast 16 bit AD-converter and a command decoder and control logic unit. Transmission to the PC-card is accomplished through an optical downlink for data and status information and an optical uplink for commands and clock lines. The mechanical probe mounting device includes two different sensor systems for frontal and sidewise probe contacts. They are also used for mechanical surface detection and probe collision detection. The robot uses its own controller with a built in VME-bus computer. The system is described in detail.



## 4.2 Probe measurement system

The SAR measurements were conducted with the dosimetric probe EX3DV4, designed in the classical triangular configuration (see Fig. 4.2) and optimized for dosimetric evaluation. The probe is constructed using the thick film technique; with printed resistive lines on ceramic substrates. The probe is equipped with an optical multi fiber line ending at the front of the probe tip. It is connected to the EOC box on the robot arm and provides an automatic detection of the phantom surface. Half of the fibers are connected to a pulsed infrared transmitter, the other half to a synchronized receiver. As the probe approaches the surface, the reflection from the surface produces a coupling from the transmitting to the receiving fibers. This reflection increases first during the approach, reaches maximum and then decreases. If the probe is flatly touching the surface, the coupling is zero. The distance of the coupling maximum to the surface is independent of the surface reflectivity and largely independent of the surface to probe angle. The DASY5 software reads the reflection during a software approach and looks for the maximum using a 2nd order fitting. The approach is stopped at reaching the maximum.



DAE System

### Probe specifications

Calibration	In air from 10 MHz to 6 GHz In brain and muscle simulating tissue at Frequencies of 750MHz, 835MHz, 900MHz, 1750MHz, 1900MHz, 2000MHz 2300MHz, 2450MHz, 2600MHz, 3500MHz, 5200MHz, 5300MHz, 5500MHz, 5600MHz, 5800MHz
Frequency	10 MHz to 6 GHz
Linearity	$\pm 0.2$ dB(30 MHz to 6 GHz)
Dynamic	10 $\mu$ W/g to > 100 mW/g
Range linearity	$\pm 0.2$ dB
Dimensions Overall length	337 mm(Tip: 20 mm)
Tip diameter	2.5 mm(Body: 12 mm)
Typical distance from probe tip to dipole centers:	1 mm
Application	Dosimetry testing Compliance tests of mobile phones

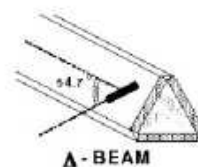

Figure 4.2 Triangular Probe Configurations



Figure 4.3 Probe Thick-Film Technique

### 4.3 Probe calibration process

#### Dosimetric Assessment Procedure

Each probe is calibrated according to a dosimetric assessment procedure described in with accuracy better than +/-10%. The spherical isotropy was evaluated with the procedure described in and found to be better than +/-0.25dB. The sensitivity parameters (Norm X, Norm Y, Norm Z), the diode compression parameter (DCP) and the conversion factor (Conv F) of the probe is tested.

#### Free Space Assessment

The free space E-field from amplified probe outputs is determined in a test chamber. This is performed in a TEM cell for frequencies below 1 GHz, and in a waveguide above 1GHz for free space. For the free space calibration, the probe is placed in the volumetric center of the cavity at the proper orientation with the field. The probe is then rotated 360 degrees.

#### Temperature Assessment \*

E-field temperature correlation calibration is performed in a flat phantom filled with the appropriate simulated brain tissue. The measured free space E-field in the medium, correlates to temperature rise in a dielectric medium. For temperature correlation calibration a RF transparent the remits or based temperature probe is used in conjunction with the E-field probe.

$$SAR = C \frac{\Delta T}{\Delta t}$$

Where:

- $\Delta t$  = exposure time (30 seconds),
- C = heat capacity of tissue (brain or muscle),
- $\Delta T$  = temperature increase due to RF exposure.

$$SAR = \frac{|E|^2 \cdot \sigma}{\rho}$$

Where:

- $\sigma$  = simulated tissue conductivity,
- $\rho$  = Tissue density (1.25 g/cm<sup>3</sup> for brain tissue)

SAR is proportional to  $\Delta T / \Delta t$ , the initial rate of tissue heating, before thermal diffusion takes place.

Now it's possible to quantify the electric field in the simulated tissue by equating the thermally derived SAR to the E- field;

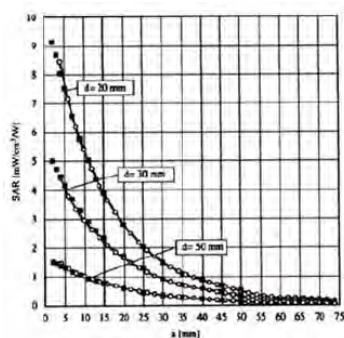

Figure 4.4 E-Field and Temperature Measurements at 900MHz

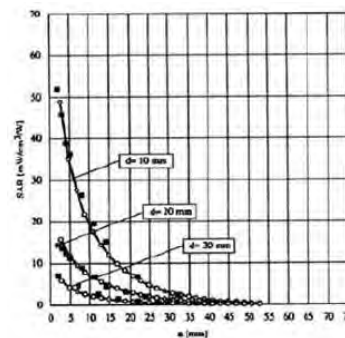

Figure 4.5 E-Field and Temperature Measurements at 1800MHz

### Data Extrapolation

The DASY software automatically executes the following procedures to calculate the field units from the microvolt readings at the probe connector. The first step of the evaluation is a linearization of the filtered input signal to account for the compression characteristics of the detector diode. The compensation depends on the input signal, the diode type and the DC-transmission factor from the diode to the evaluation electronics. If the exciting field is pulsed, the crest factor of the signal must be known to correctly compensate for peak power. The formula for each channel can be given like below;

$$V_i = U_i + U_i^2 \cdot \frac{cf}{dcp_i}$$

with  $V_i$  = linearized voltage of channel i (uV) (i = x,y,z)  
 $U_i$  = measured voltage of channel i (uV) (i = x,y,z)  
 $cf$  = crest factor of exciting field (DASY parameter)  
 $dcp_i$  = diode compression point of channel i (uV) (Probe parameter, i = x,y,z)

From the compensated input signals the primary field data for each channel can be evaluated.

**E – fieldprobes :**

$$E_i = \sqrt{\frac{V_i}{Norm_i \cdot ConvF}}$$

with  $V_i$  = linearized voltage of channel i (i = x,y,z)  
 $Norm_i$  = sensor sensitivity of channel i (i = x,y,z)  
 $\mu V / (V/m)^2$  for E-field Probes  
 $ConvF$  = sensitivity enhancement in solution  
 $E_i$  = electric field strength of channel i in V/m

The RMS value of the field components gives the total field strength (Hermitian magnitude):

$$E_{tot} = \sqrt{E_x^2 + E_y^2 + E_z^2}$$

The primary field data are used to calculate the derived field units.

$$SAR = E_{tot}^2 \cdot \frac{\sigma}{\rho \cdot 1000}$$

with  $SAR$  = local specific absorption rate in mW/g  
 $E_{tot}$  = total field strength in V/m  
 $\sigma$  = conductivity in [mho/m] or [Siemens/m]  
 $\rho$  = equivalent tissue density in g/cm<sup>3</sup>

The power flow density is calculated assuming the excitation field to be a free space field.

$$P_{pwe} = \frac{E_{tot}^2}{3770}$$

with  $P_{pwe}$  = equivalent power density of a plane wave in mW/cm<sup>2</sup>  
 $E_{tot}$  = total electric field strength in V/m

#### 4.4 SAM Twin phantom

The SAM Twin Phantom V5.0 is constructed of a fiberglass shell integrated in a wooden table. The shape of the shell is based on data from an anatomical study designed to determine the maximum exposure in at least 90% of all users. It enables the dosimetric evaluation of left and right hand phone usage as well as body mounted usage at the flat phantom region. A cover prevents the evaporation of the liquid. Reference markings on the Phantom allow the complete setup of all predefined phantom positions and measurement grids by manually teaching three points in the robot. (see Fig. 4.6)



Figure 4.6 SAM Twin phantom

#### **SAM Twin Phantom Specification**

Construction	The shell corresponds to the specifications of the Specific Anthropomorphic Mannequin (SAM) phantom defined in IEEE 1528 and IEC 62209. It enables the dosimetric evaluation of left and right hand phone usage as well as body mounted usage at the flat phantom region. A cover prevents evaporation of the liquid. Reference markings on the phantom allow the complete setup of all predefined phantom positions and measurement grids by teaching three points with the robot. Twin SAM V5.0 has the same shell geometry and is manufactured from the same material as Twin SAM V4.0, but has reinforced top structure.
Shell Thickness	$2 \pm 0.2$ mm
Filling Volume	Approx. 25 liters
Dimensions	Length: 1000 mm Width: 500 mm Height: adjustable feet

#### **Specific Anthropomorphic Mannequin (SAM) Specifications**

The phantom for handset SAR assessment testing is a low-loss dielectric shell, with shape and dimensions derived from the anthropometric data of the 90th percentile adult male head dimensions as tabulated by the US Army. The SAM Twin Phantom shell is bisected along the mid-sagittal plane into right and left halves (see Fig. 4.7). The perimeter side walls of each phantom halves are extended to allow filling with liquid to a depth that is sufficient to minimized reflections from the upper surface.

The liquid depth is maintained at a minimum depth of 15cm to minimize reflections from the upper surface.



Figure 4.7 Sam Twin Phantom shell

#### 4.5 Device Holder for Transmitters

In combination with the Twin SAM Phantom V5.0 or ELI5, the Mounting Device enables the rotation of the mounted transmitter device in spherical coordinates. Rotation point is the ear opening point. Transmitter devices can be easily and accurately positioned according to IEC, IEEE, FCC or other specifications. The device holder can be locked for positioning at different phantom sections (left head, right head, flat).

Note: A simulating human hand is not used due to the complex anatomical and geometrical structure of the hand that may produce infinite number of configurations. To produce the worst-case condition (the hand absorbs antenna output power), the hand is omitted during the tests.



Figure 4.8 Mounting Device

#### 4.6 Brain & Muscle Simulating Mixture Characterization



Simulated Tissue

The brain and muscle mixtures consist of a viscous gel using hydrox-ethyl cellulose (HEC) gelling agent and saline solution. (see Table 4.1)  
Preservation with a bactericide is added and visual inspection is made to make sure air bubbles are not trapped during the mixing process.  
The mixture is calibrated to obtain proper dielectric constant (permittivity) and conductivity of the desired tissue. The mixture characterizations used for the brain and muscle tissue simulating liquids are according to the data by C. Gabriel and G. Harts grove.

Table 4.1 Composition of the Equivalent Matter

Ingredients [% by weight]	Frequency [MHz]									
	750		835		1900		2450		5200 - 5800	
Tissue Type	Head	Body	Head	Body	Head	Body	Head	Body	Head	Body
Water	42.10	50.00	40.19	50.75	55.24	70.23	71.88	73.40	65.52	80.00
Salt(NaCl)	1.500	0.800	1.480	0.940	0.310	0.290	0.160	0.060	-	-
Sugar	56.00	48.80	57.90	48.21	-	-	-	-	-	-
HEC	0.200	0.200	0.250	-	-	-	-	-	-	-
Bactericide	0.200	0.200	0.180	0.100	-	-	-	-	-	-
Triton X-100	-	-	-	-	-	-	19.97	-	17.24	-
DGBE	-	-	-	-	48.45	29.48	7.990	26.54	-	-
Diethylenglycol monohexylether	-	-	-	-	-	-	-	-	17.24	-
Polysorbate (Tween) 80	-	-	-	-	-	-	-	-	-	20.00
Target for Dielectric Constant	<b>41.9</b>	<b>55.5</b>	<b>41.5</b>	<b>55.2</b>	<b>40.0</b>	<b>53.3</b>	<b>39.2</b>	<b>52.7</b>	-	-
Target for Conductivity (S/m)	<b>0.89</b>	<b>0.96</b>	<b>0.90</b>	<b>0.97</b>	<b>1.40</b>	<b>1.52</b>	<b>1.80</b>	<b>1.95</b>	-	-

Salt: 99 % Pure Sodium Chloride Sugar: 98 % Pure Sucrose

Water: De-ionized, 16M resistivity HEC: Hydroxyethyl Cellulose

DGBE: 99 % Di(ethylene glycol) butyl ether,[2-(2-butoxyethoxy) ethanol]

Triton X-100(ultra pure): Polyethylene glycol mono [4-(1, 1, 3, 3-tetramethylbutyl)phenyl]

## 4.7 SAR Test equipment

**Table 4.2 Test Equipment Calibration**

USE	Equipment	Company	Model No.	Serial No.	Cal. Due	Cal. Date
X	SAR Test Room	TOKIN	N/A	N/A	N/A	N/A
X	Robot Arm	s p e a g	TX60L	F13/5SC6C1/A/01	N/A	N/A
X	Robot Controller	s p e a g	CS8c	F13/5SC6C1/A/01	N/A	N/A
X	Probe Alignment Unit LB	s p e a g	N/A	N/A	N/A	N/A
X	Mounting Device	s p e a g	SD000H01KA	N/A	N/A	N/A
X	Laptop Holder	s p e a g	SMLH1001CD	N/A	N/A	N/A
X	SAM Twin Phantom	s p e a g	QD000P40CD	1799	N/A	N/A
X	SAM Flat Phantom	s p e a g	QDOVA001BB	1230	N/A	N/A
X	Data Acquisition Electronics	s p e a g	DAE4	539	Oct. 31, 2015	Oct. 15, 2014
X	Dosimetric E-Field Probe	s p e a g	EX3DV4	3745	Apr. 30, 2015	Apr. 15, 2014
X	750MHz SAR Dipole	s p e a g	D750V3	1115	Jun. 30, 2015	Jun. 12, 2014
X	835MHz SAR Dipole	s p e a g	D835V2	4d104	Jun. 30, 2015	Jun. 12, 2014
	900MHz SAR Dipole	s p e a g	D900V2	174	Oct. 31, 2015	Oct. 14, 2014
	1450MHz SAR Dipole	s p e a g	D1450V2	1015	May. 31, 2015	May. 14, 2014
	1750MHz SAR Dipole	s p e a g	D1750V2	1037	May. 31, 2015	May. 7, 2014
X	1900MHz SAR Dipole	s p e a g	D1900V2	5d129	Jun. 30, 2015	Jun. 18, 2014
	1950MHz SAR Dipole	s p e a g	D1950V3	1133	Oct. 31, 2015	Oct. 14, 2014
X	2450MHz SAR Dipole	s p e a g	D2450V2	894	Jun. 30, 2015	Jun. 13, 2014
	2600MHz SAR Dipole	s p e a g	D2600V2	1084	Jun. 30, 2015	Jun. 6, 2014
X	5000MHz SAR Dipole	s p e a g	D5GHzV2	1092	Nov. 30, 2015	Nov. 12, 2014
X	Dielectric Assessment Kit	s p e a g	DAK-3.5	1191	Jun. 30, 2015	Jun. 11, 2014
X	Network Analyzer	Agilent	8720ES	US39172791	Nov. 30, 2015	Nov. 8, 2013
X	Signal generator	ROHDE	SMB100A	177525	Feb. 28, 2015	Feb. 19, 2014
X	Power Amplifier	R&K	CGA020M602-2633R	B40240	Mar. 31, 2015	Mar. 7, 2014
X	Power meter	ROHDE	NRP2	103269	May. 30, 2015	May. 30, 2014
X	Power sensor	ROHDE	NRP-Z81	102459	May. 30, 2015	May. 30, 2014
X	Power sensor	ROHDE	NRP-Z81	102467	May. 30, 2015	May. 30, 2014
X	Directional Coupler	Narda	4226-20	09886	Feb. 28, 2015	Feb. 14, 2014
X	Attenuator(3dB)	AEROFLEX	26A-03	081217-07	Nov. 30, 2015	Nov. 16, 2014
X	Attenuator(10dB)	SUHNER	6810.19A	10005430	Jan. 31, 2015	Jan. 15, 2014
X	Microwave cable(1m)	SUHNER	SUCOFLEX104	199120/4	Oct. 31, 2015	Oct. 7, 2014
X	Microwave cable(1.5m)	SUHNER	SUCOFLEX104	199121/4	Oct. 31, 2015	Oct. 7, 2014
X	Wideband Radio Frequency Tester	ROHDE	CMW500	126079	Aug. 31, 2015	Aug. 28, 2014
X	PC	HP	HP Compaq Elite 8300	CZC3234D1P	N/A	N/A
X	Software	s p e a g	DAK	Ver 1.10.321.11	N/A	N/A
X	Software	s p e a g	DASY5	Ver 52.8.8.1222	N/A	N/A



Zacta

USE	Equipment	Company	Model No.	Serial No.	Cal. Due	Cal. Date
X	Data Acquisition Electronics	s p e a g	DAE4	1409	Dec. 31, 2015	Dec. 11, 2014
X	Dosimetric E-Field Probe	s p e a g	EX3DV4	3957	Dec. 31, 2015	Dec. 16, 2014
	750MHz SAR Dipole	s p e a g	D750V3	1100	Dec. 31, 2015	Dec. 9, 2014
X	835MHz SAR Dipole	s p e a g	D835V2	4d163	Dec. 31, 2015	Dec. 9, 2014
	900MHz SAR Dipole	s p e a g	D900V2	1d161	Dec. 31, 2015	Dec. 9, 2014
	1450MHz SAR Dipole	s p e a g	D1450V2	1048	Dec. 31, 2015	Dec. 11, 2014
	1750MHz SAR Dipole	s p e a g	D1750V2	1106	Dec. 31, 2015	Dec. 5, 2014
	1900MHz SAR Dipole	s p e a g	D1900V2	5d183	Dec. 31, 2015	Dec. 15, 2014
	1950MHz SAR Dipole	s p e a g	D1950V3	1150	Dec. 31, 2015	Dec. 15, 2014
	2450MHz SAR Dipole	s p e a g	D2450V2	925	Dec. 31, 2015	Dec. 8, 2014
	2600MHz SAR Dipole	s p e a g	D2600V2	1072	Dec. 31, 2015	Dec. 8, 2014
X	5000MHz SAR Dipole	s p e a g	D5GHzV2	1166	Dec. 31, 2015	Dec. 12, 2014
X	Dielectric Assessment Kit	s p e a g	DAK-3.5	1141	Dec. 31, 2015	Dec. 9, 2014

NOTE: The E-field probe was calibrated by SPEAG, by temperature measurement procedure. Dipole Verification measurement is performed by TÜV SÜD Zacta before each test. The brain simulating material is calibrated by TÜV SÜD Zacta using the dielectric probe system and network analyzer to determine the conductivity and permittivity (dielectric constant) of the brain-equivalent material.

## 5. Test system specifications

---

### Automated TEST SYSTEM SPECIFICATIONS:

#### Positioner

Robot	Stäubli Unimation Corp. Robot Model: TX60L
Repeatability	0.02mm
No. of axis	6

#### Data Acquisition Electronic (DAE) System

##### Cell Controller

Processor	Intel Core i7-3770
Clock Speed	3.40 GHz
Operating System	Windows 7 Professional
Data Card	DASY5 PC-Board

##### Data Converter

Features	Signal, multiplexer, A/D converter. & control logic
Software	DASY5
Connecting Lines	Optical downlink for data and status info Optical uplink for commands and clock

##### PC Interface Card

Function	24 bit (64 MHz) DSP for real time processing Link to DAE 4 16 bit A/D converter for surface detection system serial link to robot direct emergency stop output for robot
----------	--

##### E-Field Probes

Model	EX3DV4 S/N: 3745, S/N: 3957
Construction	Triangular core fiber optic detection system
Frequency	10 MHz to 6 GHz
Linearity	$\pm 0.2$ dB (30 MHz to 6 GHz)

##### Phantom

Phantom	SAM Twin Phantom (V5.0)
Shell Material	Composite
Thickness	$2.0 \pm 0.2$ mm



Figure 5.1 DASY5 Test System



## 6. SAR Measurement Procedure

The evaluation was performed using the following procedure:

1. The SAR distribution at the exposed side of the head or body was measured at a distance no greater than 5.0 mm from the inner surface of the shell.

The area covered the entire dimension of the device-head and body interface and the horizontal grid resolution was determined per FCC KDB Publication 865664D01v01r03.

2. The point SAR measurement was taken at the maximum SAR region determined from Step 1 to enable the monitoring of SAR fluctuations/drifts during the 1g/10g cube evaluation. SAR at this fixed point was measured and used as a reference value.

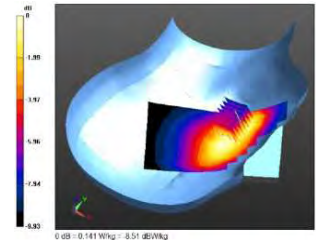

Sample SAR Area Scan

3. Based on the area scan data, the peak of the region with maximum SAR was determined by spline interpolation. Around this point, a volume was assessed according to the measurement resolution and volume size requirements of FCC KDB Publication 865664 D01v01r03 (See Table 6.1).

On the basis of this data set, the spatial peak SAR value was evaluated with the following procedure (see references or the DASY manual online for more details):

- a. The data was extrapolated to the surface of the outer-shell of the phantom. The combined distance extrapolated was the combined distance from the center of the dipoles 2.7mm away from the tip of the probe housing plus the 1.2 mm distance between the surface and the lowest measuring point. The extrapolation was based on a least-squares algorithm. A polynomial of the fourth order was calculated through the points in the z-axis (normal to the phantom shell).
  - b. After the maximum interpolated values were calculated between the points in the cube, the SAR was averaged over the spatial volume (1g or 10g) using a 3D-Spline interpolation algorithm. The 3D-spline is composed of three one-dimensional splines with the "Not a knot" condition (in x, y, and z directions). The volume was then integrated with the trapezoidal algorithm. One thousand points (10 x 10 x 10) were obtained through interpolation, in order to calculate the averaged SAR.
  - c. All neighboring volumes were evaluated until no neighboring volume with a higher average value was found.
4. The SAR reference value, at the same location as step 2, was re-measured after the zoom scan was complete to calculate the SAR drift. If the drift deviated by more than 5%, the SAR test and drift measurements were repeated.

Table 6.1 Area and Zoom Scan Resolutions per FCC KDB Publication 865664 D01v01r03

Frequency	Maximum Area Scan Resolution[mm] ( $\Delta X_{area} \Delta Y_{area}$ )	Maximum Zoom Scan Resolution[mm] ( $\Delta X_{zoom} \Delta Y_{zoom}$ )	Maximum Zoom Scan Spatial Resolution[mm] $\Delta Z_{zoom}(n)$	Minimum Zoom Scan Volume[mm](x,y,z)
$\leq 2$ GHz	$\leq 15$	$\leq 8$	$\leq 5$	$\geq 30$
2-3GHz	$\leq 12$	$\leq 5$	$\leq 5$	$\geq 30$
3-4GHz	$\leq 12$	$\leq 5$	$\leq 4$	$\geq 28$
4-5GHz	$\leq 10$	$\leq 4$	$\leq 3$	$\geq 25$
5-6GHz	$\leq 10$	$\leq 4$	$\leq 2$	$\geq 22$

## 7. Definition of reference points

### 7.1 EAR Reference Point

Figure 7.1 shows the front, back and side views of the SAM Twin Phantom. The point “M” is the reference point for the center of the mouth, “LE” is the left ear reference point(ERP), and “RE” is the right ERP. The ERPs are 15mm posterior to the entrance to the Ear canal (EEC) along the B- M line (Back-Mouth), as shown in Figure 7.1. The plane Passing, through the two ear canals and M is defined as the Reference Plane. The line N-F (Neck- Front) is perpendicular to the reference plane and passing through the RE (or LE) is called the Reference Pivoting Line (see Figure 7.2). Line B-M is perpendicular to the N-F line. Both N-F and B-M lines are marked on the external phantom shell to facilitate handset positioning.

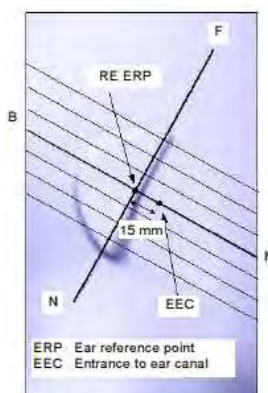

Figure 7.1 Close-up side view of ERPs

### 7.2 Handset Reference Points

Two imaginary lines on the handset were established: the vertical centerline and the horizontal line. The test device was placed in a normal operating position with the “test device reference point” located along the “vertical centerline” on the front of the device aligned to the “ear reference point” (See Fig. 7.3). The “test device reference point” was then located at the same level as the center of the ear reference point. The test device was positioned so that the “vertical centerline” was bisecting the front surface of the handset at its top and bottom edges, positioning the “ear reference point” on the outersurface of the both the left and right head phantoms on the ear reference point.



Figure 7.2 Front, back and side view of SAM Twin Phantom

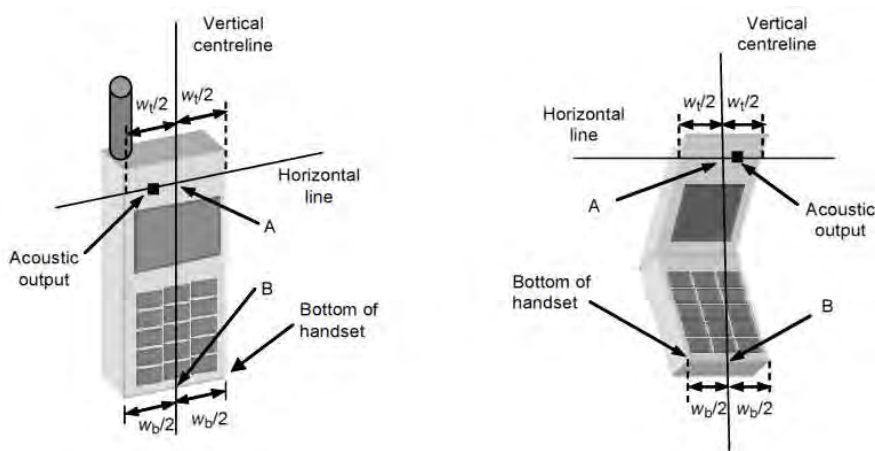

Figure 7.3 Handset Vertical Center & Horizontal Line Reference Points

### 7.3 Device Holder

The device holder is made out of low-loss POM material having the following dielectric parameters: relative permittivity  $\epsilon = 3$  and loss tangent  $\delta = 0.02$ .

### 7.4 Positioning for Cheek/Touch

1. The test device was positioned with the handset close to the surface of the phantom such that point A is on the (virtual) extension of the line passing through points RE and LE on the phantom (see Fig. 7.4), such that the plane defined by the vertical center line and the horizontal line of the phone is approximately parallel to the sagittal plane of the phantom.

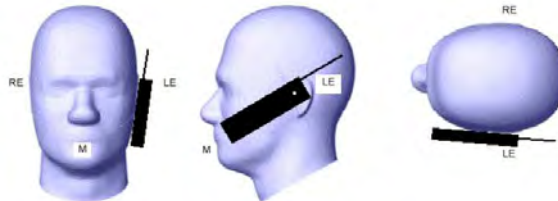

Figure 7.4 Front, Side and Top View of Cheek/Touch Position

2. The handset was translated towards the phantom along the line passing through RE & LE until the handset touches the ear.
3. While maintaining the handset in this plane, the handset was rotated around the LE-RE line until the vertical centerline was in the plane normal to MB-NF including the line MB (reference plane).
4. The phone was then rotated around the vertical centerline until the phone (horizontal line) was symmetrical with respect to the line NF.
5. While maintaining the vertical centerline in the reference plane, keeping point A on the line passing through RE and LE, and maintaining the phone contact with the ear, the handset was rotated about the line NF until any point on the handset made contact with a phantom point below the ear (cheek). (See Fig. 7.5)

### 7.5 Positioning for Ear / 15° Tilt

With the test device aligned in the "Cheek/Touch Position":

1. While maintaining the orientation of the phone, the phone was retracted parallel to the reference plane far enough to enable a rotation of the phone by 15 degree.
2. The phone was then rotated around the horizontal line by 15 degree.
3. While maintaining the orientation of the phone, the phone was moved parallel to the reference plane until any part of the phone touches the head. (In this position, point A was located on the line RE-LE). The tilted position is obtained when the contact is on the pinna. If the contact was at any location other than the pinna, the angle of the phone would then be reduced. The tilted position was obtained when any part of the phone was in contact of the ear as well as a second part of the phone was in contact with the head (see Figure 7.6).

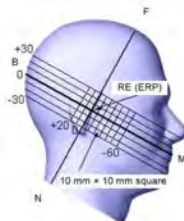

Figure 7.5 Side view/relevant markings

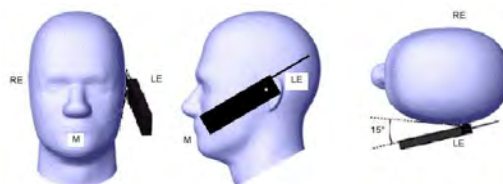

Figure 7.6 Front, Side and Top View of Ear/15° Position

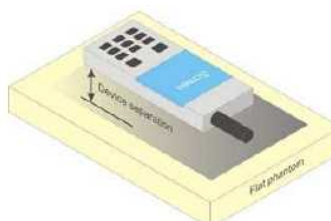

Figure 7.7 Sample Body-Worn Diagram

## 7.6 Body-Worn Accessory Configurations

Body-worn operating configurations are tested with the belt-clips and holsters attached to the device and positioned against a flat phantom in a normal use configuration (see Fig. 7.7). Per FCC KDB Publication 648474 D04\_v01, Body-worn accessory exposure is typically related to voice mode operations when handsets are carried in body-worn accessories. The body-worn accessory procedures in FCC KDB Publication 447498 D01v05r02 should be used to test for body-worn accessory SAR compliance, without a headset connected to it. This enables the test results for such configuration to be compatible with that required for hotspot mode when the body-worn accessory test separation distance is greater than or equal to that required for hotspot mode, when applicable. When the reported SAR for a body-worn accessory, measured without a headset connected to the handset, is  $> 1.2 \text{ W/kg}$ , the highest reported SAR configuration for that wireless mode and frequency band should be repeated for that body-worn accessory with a headset attached to the handset.

Accessories for Body-worn operation configurations are divided into two categories: those that do not contain metallic components and those that do contain metallic components. When multiple accessories that do not contain metallic components are supplied with the device, the device is tested with only the accessory that dictates the closest spacing to the body. Then multiple accessories that contain metallic components are tested with the device with each accessory. If multiple accessories share an identical metallic component (i.e. the same metallic belt-clip used with different holsters with no other metallic components) only the accessory that dictates the closest spacing to the body is tested.

Body-worn accessories may not always be supplied or available as options for some devices intended to be authorized for body-worn use. In this case, a test configuration with a separation distance between the back of the device and the flat phantom is used. Test position spacing was documented.

Transmitters that are designed to operate in front of a person's face, as in push-to-talk configurations, are tested for SAR compliance with the front of the device positioned to face the flat phantom in head fluid. For devices that are carried next to the body such as a shoulder, waist or chest-worn transmitters, SAR compliance is tested with the accessories, including headsets and microphones, attached to the device and positioned against a flat phantom in a normal use configuration.

## 7.7 Extremity Exposure Configurations

Devices that are designed or intended for use on extremities or mainly operated in extremity only exposure conditions; i.e., hands, wrists, feet and ankles, may require extremity SAR evaluation. When the device also operates in close proximity to the user's body, SAR compliance for the body is also required. The 1-g body and 10-g extremity SAR Exclusion Thresholds found in KDB Publication 447498 D01v05r02 should be applied to determine SAR test requirements.

Per KDB Publication 447498 D01v05r02, Cell phones (handsets) are not normally designed to be used on extremities or operated in extremity only exposure conditions. The maximum output power levels of handsets generally do not require extremity SAR testing to show compliance. Therefore, extremity SAR was not evaluated for this device.

## 7.8 Wireless Router Configurations

Some battery-operated handsets have the capability to transmit and receive user data through simultaneous transmission of WIFI simultaneously with a separate licensed transmitter. The FCC has provided guidance in FCC KDB Publication 941225 D06 v02 where SAR test considerations for handsets ( $L \times W \geq 9 \text{ cm} \times 5 \text{ cm}$ ) are based on a composite test separation distance of 10 mm from the front, back and edges of the device containing transmitting antennas within 2.5 cm of their edges, determined from general mixed use conditions for this type of devices. Since the hotspot SAR results may overlap with the body-worn accessory SAR requirements, the more conservative configurations can be considered, thus excluding some body-worn accessory SAR tests.

When the user enables the personal wireless router functions for the handset, actual operations include simultaneous transmission of both the WIFI transmitter and another licensed transmitter. Both transmitters often do not transmit at the same transmitting frequency and thus cannot be evaluated for SAR under actual use conditions due to the limitations of the SAR assessment probes. Therefore, SAR must be evaluated for each frequency transmission and mode separately and spatially summed with the WIFI transmitter according to FCC KDB Publication 447498 D01v05r02 publication procedures.

The "Portable Hotspot" feature on the handset was NOT activated during SAR assessments, to ensure the SAR measurements were evaluated for a single transmission frequency RF signal at a time.

## 8. ANSI / IEEE C95.1-2005 RF Exposure Limits

### Uncontrolled Environment

UNCONTROLLED ENVIRONMENTS are defined as locations where there is the exposure of individuals who have no knowledge or control of their exposure. The general population/uncontrolled exposure limits are applicable to situations in which the general public may be exposed or in which persons who are exposed as a consequence of their employment may not be made fully aware of the potential for exposure or cannot exercise control over their exposure. Members of the general public would come under this category when exposure is not employment-related; for example, in the case of a wireless transmitter that exposes persons in its vicinity.

### Controlled Environment

CONTROLLED ENVIRONMENTS are defined as locations where there is exposure that may be incurred by persons who are aware of the potential for exposure, (i.e. as a result of employment or occupation). In general, occupational/controlled exposure limits are employment, which have been made fully aware of the potential for exposure and can exercise control over their exposure. This exposure category is also applicable when the exposure is of a transient nature due to incidental passage through a location where the exposure levels may be higher than the general population/uncontrolled limits, but the exposed person is fully aware of the potential for exposure and can exercise control over his or her exposure by leaving the area or by some other appropriate means.

**Table 8.1 SAR Human Exposure Specified in ANSI/IEEE C95.1-2005**

	HUMAN EXPOSURE LIMITS	
	General Public Exposure (W/kg) or (mW/g)	Occupational Exposure (W/kg) or (mW/g)
SPATIAL PEAK SAR * (Brain)	1.60	8.00
SPATIAL AVERAGE SAR ** (Whole Body)	0.08	0.40
SPATIAL PEAK SAR *** (Hands / Feet / Ankle / Wrist)	4.00	20.0

#### NOTES:

\* The Spatial Peak value of the SAR averaged over any 1 g of tissue (defined as a tissue volume in the shape of a cube) and over the appropriate averaging time.

\*\* The Spatial Average value of the SAR averaged over the whole-body.

\*\*\* The Spatial Peak value of the SAR averaged over any 10 g of tissue (defined as a tissue volume in the shape of a cube) and over the appropriate averaging time.

Uncontrolled Environments are defined as locations where there is the exposure of individuals who have no knowledge or control of their exposure.

Controlled Environments are defined as locations where there is exposure that may be incurred by persons who are aware of the potential for exposure, (i.e. as a result of employment or occupation).

## 9. FCC Measurement Procedures

---

Power measurements were performed using a base station simulator under digital average power.

### 9.1 Measured and Reported SAR

Per FCC KDB Publication 447498 D01v05r02, When SAR is not measured at the maximum power level allowed for production units, the results must be scaled to the maximum tune-up tolerance limit according to the power applied to the individual channels tested to determine compliance. For simultaneous transmission, the measured aggregate SAR must be scaled according to the sum of the differences between the maximum tune-up tolerance and actual power used to test each transmitter. When SAR is measured at or scaled to the maximum tune-up tolerance limit, the results are referred to as reported SAR. The highest reported SAR results are identified on the grant of equipment authorization according to procedures in KDB 690783 D01v01r03.

### 9.2 Procedures Used to Establish RF Signal for SAR

The following procedures are according to FCC KDB Publication 941225 D01 v03 "SAR Measurement Procedures for 3G Devices" v02, October 2007.

The device was placed into a simulated call using a base station simulator in a RF shielded chamber. Establishing connections in this manner ensure a consistent means for testing SAR and are recommended for evaluating SAR [4].

Devices under test were evaluated prior to testing, with a fully charged battery and were configured to operate at maximum output power. In order to verify that the device was tested throughout the SAR test at maximum output power, the SAR measurement system measures a "point SAR" at an arbitrary reference point at the start and end of the 1 gram SAR evaluation, to assess for any power drifts during the evaluation. If the power drift deviated by more than 5%, the SAR test and drift measurements were repeated.

### 9.3 SAR Measurement Conditions for WCDMA(UMTS)

#### 9.3.1 Output Power Verification

Maximum output power is measured on the High, Middle and Low channels for each applicable transmission band according to the general descriptions in section 5.2 of 3GPP TS 34.121, using the appropriate RMC or AMR with TPC (transmit power control) set to all "1s".

Maximum output power is verified on the High, Middle and Low channels according to the general descriptions in section 5.2 of 3GPP TS 34.121 (release 5), using the appropriate RMC with TPC (transmit power control) set to all "1s" or applying the required inner loop power control procedures to maintain maximum output power while HSUPA is active.

Results for all applicable physical channel configurations (DPCCH, DPDCHn and spreading codes, HS-DPCCH etc) are tabulated in this test report. All configurations that are not supported by the DUT or cannot be measured due to technical or equipment limitations are identified.

#### 9.3.2 Head SAR Measurements for Handsets

SAR for head exposure configurations is measured using the 12.2 kbps RMC with TPC bits configured to all "1s". SAR in AMR configurations is not required when the maximum average output of each RF channel for 12.2 kbps AMR is less than 0.25 dB higher than that measured in 2.2 kbps RMC. Otherwise, SAR is measured on the maximum output channel in 12.2 AMR with a 3.4 kbps SRB (signaling radio bearer) using the exposure configuration that resulted in the highest SAR for that RF channel in the 12.2 kbps RMC mode.

#### 9.3.3 Body SAR Measurements

SAR for body exposure configurations is measured using the 12.2 kbps RMC with the TPC bits all "1s".

### 9.3.4 SAR Measurements for Handsets with Rel 5 HSDPA

Body SAR for HSDPA is not required for handsets with HSDPA capabilities when the maximum average output power of each RF channel with HSDPA active is less than 0.25 dB higher than that measured without HSDPA using 12.2 kbps RMC and the maximum SAR for 12.2 kbps RMC is  $\leq 75\%$  of the SAR limit. Otherwise, SAR is measured for HSDPA, using an FRC with H-Set 1 in Sub-test 1 and a 12.2 kbps RMC configured in Test Loop Mode 1, using the highest body SAR configuration measured in 12.2 kbps RMC without HSDPA, on the maximum output channel with the body exposure configuration that resulted in the highest SAR in 12.2 kbps RMC mode for that RF channel. The H-set used in FRC for HSDPA should be configured according to the UE category of a test device.

The number of HS-DSCH/HSPDSCHs, HARQ processes, minimum inter-TTI interval, transport block sizes and RV coding sequence are defined by the applicable H-set. To maintain a consistent test configuration and stable transmission conditions, QPSK is used in the FRC for SAR testing.

HS-DPCCH should be configured with a CQI feedback cycle of 2 ms to maintain a constant rate of active CQI slots. DPCCH and DPDCH gain factors of  $\beta_c=9$  and  $\beta_d=15$ , and power offset parameters of  $\Delta_{ACK}=\Delta_{NACK}=5$  and  $\Delta_{CQI}=2$  is used. The CQI value is determined by the UE category, transport block size, number of HS-PDSCHs and modulation used in the FRC.

Figure 9.1 Table C.10.1.4 of TS 234.121-1

Subtest	$\beta_c$	$\beta_d$	$\beta_d$ (SF)	$\beta_c / \beta_d$	$\beta_{HS}$ (Note 1, Note 2)	CM, dB (Note 3)	MPR, dB (Note 3)
1	2/15	15/15	64	2/15	4/15	0.0	0.0
2	12/15 (Note 4)	15/15 (Note 4)	64	12/15 (Note 4)	24/15	1.0	0.0
3	15/15	8/15	64	15/8	30/15	1.5	0.5
4	15/15	4/15	64	15/4	30/15	1.5	0.5

Notes:

- $\Delta_{ACK}$ ,  $\Delta_{NACK}$  and  $\Delta_{CQI} = 30/15$  with  $\beta_{HS} = 30/15 * \beta_c$ .
- For clauses 5.2C, 5.7A, 5.13.1A and 5.13.1AA,  $\Delta_{ACK}$  and  $\Delta_{NACK} = 30/15$  with  $\beta_{HS} = 30/15 * \beta_c$ , and  $\Delta_{CQI} = 24/15$  with  $\beta_{HS} = 24/15 * \beta_c$ .
- CM = 1 for  $\beta_c/\beta_d = 12/15$ ,  $\beta_{HS}/\beta_c = 24/15$ . For all other combinations of DPDCH, DPCCH and HS-DPCCH, the MPR is based on the relative CM difference. This is applicable for only UEs that support HSDPA in release 6 and later releases.
- For Subtest 2, the  $\beta_c/\beta_d$  ratio of 12/15 for the TFC during the measurement period (TF1, TF0) is achieved by setting the signaled gain factors for the reference TFC (TF1, TF1) to  $\beta_c = 11/15$  and  $\beta_d = 15/15$ .

### 9.3.5 SAR Measurements for Handsets with Rel 6 HSUPA

Body SAR for HSUPA is not required when the maximum average output of each RF channel with HSUPA/HSDPA active is less than 0.25 dB higher than as measured without HSUPA/HSDPA using 12.2 kbps RMC and maximum SAR for 12.2 kbps RMC is  $\leq 75\%$  of the SAR limit. Otherwise SAR is measured on the maximum output channel for the body exposure configuration produced highest SAR in 12.2 kbps RMC for that RF channel, using the additional procedures under "Release 6 HSPA data devices" Head SAR for VOIP operations under HSPA is not required when maximum average output of each RF channel with HSPA is less than 0.25 dB higher than as measured using 12.2 kbps RMC. Otherwise SAR is measured using same HSPA configuration as used for body SAR.

Figure 9.2 Table C.11.1.3 of TS 234.121-1

Sub-test	$\beta_c$	$\beta_d$	$\beta_d$ (SF)	$\beta_c/\beta_d$	$\beta_{HS}$ (Note 1)	$\beta_{ec}$	$\beta_{ed}$ (Note 5, Note 6)	$\beta_{ed}$ (SF)	$\beta_{ed}$ (Codes)	CM (dB) (Note 2)	MPR (dB) (Note 2)	AG Index (Note 6)	E-TFCI
1	11/15 (Note 3)	15/15 (Note 3)	64	11/15 (Note 3)	22/15	209/ 225	1309/ 225	4	1	1.0	0.0	20	75
2	6/15	15/15	64	6/15	12/15	12/15	94/75	4	1	3.0	2.0	12	67
3	15/15	9/15	64	15/9	30/15	30/15	$\beta_{ec1}$ : 47/15 $\beta_{ec2}$ : 47/15	4 4	2	2.0	1.0	15	92
4	2/15	15/15	64	2/15	4/15	2/15	56/75	4	1	3.0	2.0	17	71
5	15/15 (Note 4)	15/15 (Note 4)	64	15/15 (Note 4)	30/15	24/15	134/ 15	4	1	1.0	0.0	21	81

Notes:

- $\Delta_{ACK}$ ,  $\Delta_{NACK}$  and  $\Delta_{CQI} = 30/15$  with  $\beta_{HS} = 30/15 * \beta_c$ .
- CM = 1 for  $\beta_c/\beta_d = 12/15$ ,  $\beta_{HS}/\beta_c = 24/15$ . For all other combinations of DPDCH, DPCCH, HS-DPCCH, E-DPDCH and E-DPCCH the MPR is based on the relative CM difference.
- For subtest 1 the  $\beta_c/\beta_d$  ratio of 11/15 for the TFC during the measurement period (TF1, TF0) is achieved by setting the signalled gain factors for the reference TFC (TF1, TF1) to  $\beta_c = 10/15$  and  $\beta_d = 15/15$ .
- For subtest 5 the  $\beta_c/\beta_d$  ratio of 15/15 for the TFC during the measurement period (TF1, TF0) is achieved by setting the signalled gain factors for the reference TFC (TF1, TF1) to  $\beta_c = 14/15$  and  $\beta_d = 15/15$ .
- In case of testing by UE using E-DPDCH Physical Layer category 1, Sub-test 3 is omitted according to TS25.306 Table 5.1g.
- $\beta_{ec}$  cannot be set directly, it is set by Absolute Grant Value.

#### 9.4 SAR Measurement Conditions for LTE

UE Power Class: 3 (23 +/- 2dBm). The allowed Maximum Power Reduction (MPR) for the maximum output power due to higher order modulation and transmit bandwidth configuration (resource blocks) is specified in Table 6.2.3-1 of the 3GPP TS36.101.

Figure 9.3 Table 6.2.3-1 of TS 36.101

Modulation	Channel bandwidth / Transmission bandwidth (RB)						MPR (dB)
	1.4 MHz	3.0 MHz	5 MHz	10 MHz	15 MHz	20 MHz	
QPSK	> 5	> 4	> 8	> 12	> 16	> 18	≤ 1
16 QAM	≤ 5	≤ 4	≤ 8	≤ 12	≤ 16	≤ 18	≤ 1
16 QAM	> 5	> 4	> 8	> 12	> 16	> 18	≤ 2

The allowed A-MPR values specified below in Table 6.2.4.-1 of 3GPP TS36.101 are in addition to the allowed MPR requirements. All the measurements below were performed with A-MPR disabled, by using Network Signalling Value of "NS\_01"

Figure 9.4 Table 6.2.4-1 of TS 36.101

Network Signalling value	Requirements (sub-clause)	E-UTRA Band	Channel bandwidth (MHz)	Resources Blocks ( $N_{RB}$ )	A-MPR (dB)
NS_01	6.6.2.1.1	Table 5.5-1	1.4, 3, 5, 10, 15, 20	Table 5.6-1	NA
NS_03	6.6.2.2.1	2, 4, 10, 23, 25, 35, 36	3	>5	≤ 1
			5	>6	≤ 1
			10	>6	≤ 1
			15	>8	≤ 1
			20	>10	≤ 1
NS_04	6.6.2.2.2	41	5	>6	≤ 1
			10, 15, 20	See Table 6.2.4-4	
NS_05	6.6.3.3.1	1	10, 15, 20	≥ 50	≤ 1
NS_06	6.6.2.2.3	12, 13, 14, 17	1.4, 3, 5, 10	Table 5.6-1	n/a
NS_07	6.6.2.2.3	13	10	Table 6.2.4-2	Table 6.2.4-2
	6.6.3.3.2				
NS_08	6.6.3.3.3	19	10, 15	> 44	≤ 3
NS_09	6.6.3.3.4	21	10, 15	> 40	≤ 1
				> 55	≤ 2
NS_10		20	15, 20	Table 6.2.4-3	Table 6.2.4-3
NS_11	6.6.2.2.1	23 <sup>1</sup>	1.4, 3, 5, 10	Table 6.2.4-5	Table 6.2.4-5
..					
NS_32	-	-	-	-	-

Note 1<sup>1</sup> Applies to the lower block of Band 23, i.e. a carrier placed in the 2000-2010 MHz region.



## 9.5 SAR Testing with 802.11 Transmitters

Normal network operating configurations are not suitable for measuring the SAR of 802.11 a/b/g/n /ac transmitters. Unpredictable fluctuations in network traffic and antenna diversity conditions can introduce undesirable variations in SAR results. The SAR for these devices should be measured using chipset based test mode software to ensure the results are consistent and reliable. See KDB Publication 248227 D01v01r02 for more details.

### 9.5.1 General Device Setup

Chipset based test mode software is hardware dependent and generally varies among manufacturers. The device operating parameters established in test mode for SAR measurements must be identical to those programmed in production units, including output power levels, amplifier gain settings and other RF performance tuning parameters. The test frequencies should correspond to actual channel frequencies defined for domestic use. SAR for devices with switched diversity should be measured with only one antenna transmitting at a time during each SAR measurement, according to a fixed modulation and data rate. The same data pattern should be used for all measurements.

### 9.5.2 Frequency Channel Configurations

For 2.4 GHz, the highest average RF output power channel between the low, mid and high channel at the lowest data rate was selected for SAR evaluation in 802.11b mode. 802.11g/n modes and higher data rates for 802.11b were additionally evaluated for SAR if the output power of the respective mode was 0.25 dB or higher than the powers of the SAR configurations tested in the 802.11b mode.

For 5 GHz, the highest average RF output power channel across the default test channels at the lowest data rate was selected for SAR evaluation in 802.11a. When the adjacent channels are higher in power than the default channels, these "required channels" were considered instead of the default channels for SAR testing. 802.11n modes and higher data rates for 802.11a/n were evaluated only if the respective mode was 0.25 dB or higher than the 802.11a mode. 802.11ac SAR was evaluated for highest 802.11a configuration in each 5 GHz band and each exposure condition. 802.11ac modes were additionally evaluated for SAR if the output power for the respective mode was more than 0.25 dB higher than powers of 802.11a modes.

If the maximum extrapolated peak SAR of the zoom scan for the highest output channel was less than 1.6 W/kg and if the 1g averaged SAR was less than 0.8 W/kg, SAR testing was not required for the other test channels in the band.

## 10. RF Conducted Power

### 10.1 GSM Conducted Powers

Band	Channel	Frequency [MHz]	Maximum Burst-Averaged Output Power [dBm]				
			Voice GSM CS 1slot	GPRS/EDGE(GMSK)Data			
				GPRS 1 TX Slot	GPRS 2 TX Slot	GPRS 3 TX Slot	GPRS 4 TX Slot
GSM 850	128	824.2	32.66	32.68	31.98	29.84	29.18
	190	836.6	<b>32.67</b>	32.66	31.95	29.79	29.21
	251	848.8	32.61	32.63	31.88	29.73	28.82
GSM 1900	512	1850.2	29.19	29.18	28.40	26.55	25.48
	661	1880.0	29.22	29.23	28.67	26.74	25.64
	810	1909.8	<b>29.66</b>	29.63	28.98	26.98	25.95
Band	Channel	Frequency [MHz]	Calculated Maximum Frame-Averaged Output Power [dBm]				
			Voice GSM CS 1slot	GPRS/EDGE(GMSK)Data			
				GPRS 1 TX Slot	GPRS 2 TX Slot	GPRS 3 TX Slot	GPRS 4 TX Slot
GSM 850	128	824.2	23.63	23.65	25.96	25.58	<b>26.17</b>
	190	836.6	23.64	23.63	25.93	25.53	<b>26.20</b>
	251	848.8	23.58	23.60	25.86	25.47	<b>25.81</b>
GSM 1900	512	1850.2	20.16	20.15	<b>22.38</b>	22.29	22.47
	661	1880.0	20.19	20.20	<b>22.65</b>	22.48	22.63
	810	1909.8	20.63	20.60	<b>22.96</b>	22.72	22.94

Table 10.1 The power was measured by CMW500

Note:

- Both burst-averaged and calculated frame-averaged powers are included. Frame-averaged power was calculated from the measured burst-averaged power by converting the slot powers into linear units and calculating the energy over 8 timeslots.
- The bolded GPRS modes were selected according to the highest frame-averaged output power table according to KDB 941225 D03v01.
- GPRS/EDGE (GMSK) output powers were measured with coding scheme setting of 1 (CS1) on the base station simulator. CS1 was configured to measure GPRS output power measurements and SAR to ensure GMSK modulation in the signal. Our Investigation has shown that CS1 - CS4 settings do not have any impact on the output levels or modulation in the GPRS modes.
- This device does not support EDGE. (EDGE RX only)

GSM Class: B  
 GPRS Multislot class: 12 (max 4 TX Uplink slots)  
 DTM Multislot Class: N/A

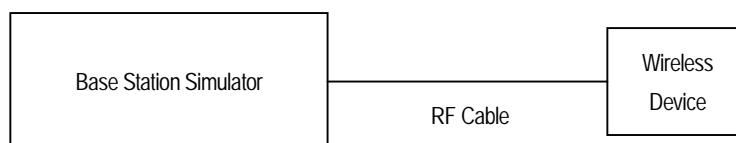

Figure 10.1 Power Measurement Setup

## 10.2 WCDMA Conducted Powers

3GPP Release Version	Mode		Sub-Test	Cellular Band [dBm]			PCS Band [dBm]			MPR	Bc	βd	Bc/βd
	Channel			4132	4183	4233	9262	9400	9538				
	Frequency [MHz]			826.4	836.6	846.6	1852.4	1880	1907.6				
99	W-CDMA	RMC	-	23.58	23.53	23.32	22.66	22.63	<u>22.75</u>	-	-	-	-
		AMR	-	<u>23.60</u>	23.56	23.37	22.62	22.48	22.73	-	-	-	-
5	HSDPA	1	1	22.63	22.55	22.40	21.71	21.82	21.75	0	2/15	15/15	2/15
5		2	2	21.68	21.48	21.36	21.78	21.74	21.74	0	12/15	15/15	12/15
5		3	3	21.35	21.52	21.25	21.26	21.25	21.26	0.5	15/15	8/15	15/8
5		4	4	21.92	21.82	21.83	21.33	21.26	21.31	0.5	15/15	4/15	15/4
6	HSUPA	1	1	22.63	22.45	22.13	21.34	21.23	21.52	0	11/15	15/15	11/15
6		2	2	21.10	21.55	21.44	20.31	20.33	20.81	2	6/15	15/15	6/15
6		3	3	21.47	21.51	22.41	20.58	20.39	20.72	1	15/15	9/15	15/9
6		4	4	21.46	22.04	21.82	20.80	20.66	21.09	2	2/15	15/15	2/15
6		5	5	22.64	22.59	22.41	21.75	21.57	21.78	0	15/15	15/15	15/15

**Table 10.2** The power was measured by CMW500

WCDMA SAR was tested under RMC 12.2 kbps with HSPA Inactive per KDB Publication 941225 D01 v03.

HSPA SAR was not required since the average output power of the HSPA subtests was not more than 0.25 dB higher than the RMC level and SAR was less than 1.2 W/kg.

This device does not support DC-HSDPA.

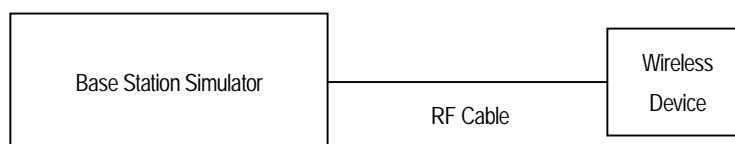

**Figure 10.2** Power Measurement Setup

### 10.3 LTE Conducted Powers

Band	BW [MHz]	Mode	RB Allocation	RB offset	Target MPR	Avg Power[dBm]		
						23780	23790	23800
						709.0 MHz	710.0 MHz	711.0 MHz
LTE Band 17	10	QPSK	1	0	0	23.88	<b>23.95</b>	23.87
			1	25	0	23.82	23.89	23.76
			1	49	0	23.87	23.92	23.93
			25	0	1	22.91	22.86	22.88
			25	12	1	22.88	22.81	22.83
			25	25	1	22.85	22.88	22.85
			50	0	1	22.86	22.83	22.87
		16QAM	1	0	1	22.90	22.88	23.03
			1	25	1	22.87	22.80	22.96
			1	49	1	22.92	22.93	23.10
			25	0	2	21.90	21.96	21.87
			25	12	2	21.87	21.91	21.88
			25	25	2	21.90	21.91	21.91
			50	0	2	21.91	21.91	21.91

Band	BW [MHz]	Mode	RB Allocation	RB offset	Target MPR	Avg Power[dBm]		
						23755	23790	23825
						706.5 MHz	710.0 MHz	713.5 MHz
LTE Band 17	5	QPSK	1	0	0	23.89	23.92	23.85
			1	12	0	23.84	23.87	23.87
			1	24	0	23.86	23.87	23.94
			12	0	1	22.87	22.87	22.84
			12	7	1	22.88	22.86	22.86
			12	13	1	22.85	22.84	22.94
			25	0	1	22.86	22.87	22.86
		16QAM	1	0	1	22.81	22.85	22.76
			1	12	1	22.74	22.79	22.79
			1	24	1	22.74	22.80	22.88
			12	0	2	21.92	21.98	21.93
			12	7	2	21.90	21.96	21.93
			12	13	2	21.86	21.96	21.94
			25	0	2	21.86	21.96	21.93

Table 10.3 The power was measured by CMW500

### Justification of SAR measurements in LTE mode

- According to Chapter 4 'SAR test procedures for LTE devices of FCC KDB Publication 941225 D05 the following test configurations for standalone measurements of the largest channel bandwidth (chapter 4.2) had to be taken into consideration.
- 4.2.1. QPSK with 1 RB allocation  
Start with the largest channel bandwidth and measure SAR for QPSK with 1 RB allocation, using the RB offset and required test channel combination with the highest maximum output power for RB offsets at the upper edge, middle and lower edge of each required test channel. When the reported SAR is  $\leq 0.8$  W/kg, testing of the remaining RB offset configurations and required test channels is not required for 1 RB allocation; otherwise, SAR is required for the remaining required test channels and only for the RB offset configuration with the highest output power for that channel.6 When the reported SAR of a required test channel is  $> 1.45$  W/kg, SAR is required for all three RB offset configurations for that required test channel.
- 4.2.2. QPSK with 50% RB allocation  
The procedures required for 1 RB allocation in 4.2.1 are applied to measure the SAR for QPSK with 50% RB allocation.
- 4.2.3. QPSK with 100% RB allocation  
For QPSK with 100% RB allocation, SAR is not required when the highest maximum output power for 100 % RB allocation is less than the highest maximum output power in 50% and 1 RB allocations and the highest reported SAR for 1 RB and 50% RB allocation in 4.2.1 and 4.2.2 are  $\leq 0.8$  W/kg. Otherwise, SAR is measured for the highest output power channel and if the reported SAR is  $> 1.45$  W/kg, the remaining required test channels must also be tested.
- 4.2.4. Higher order modulations  
For each modulation besides QPSK; e.g., 16-QAM, 64-QAM, apply the QPSK procedures in sections 4.2.1, 4.2.2 and 4.2.3 to determine the QAM configurations that may need SAR measurement. For each configuration identified as required for testing, SAR is required only when the highest maximum output power for the configuration in the higher order modulation is  $> \frac{1}{2}$  dB higher than the same configuration in QPSK or when the reported SAR for the QPSK configuration is  $> 1.45$  W/kg.
- Testing of other channel bandwidths was not necessary because the output power of equivalent channel configurations was less than  $\frac{1}{2}$  dB larger compared to the largest channel bandwidth and reported SAR was  $< 1.45$  W/kg.

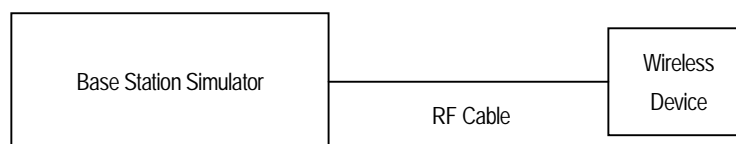

**Figure 10.3 Power Measurement Setup**

#### 10.4 WLAN Conducted Powers

Mode	Frequency [MHz]	802.11b (2.4 GHz) Conducted Power [dBm]			
		Data Rate [Mbps]			
		1	2	5.5	11
802.11b	2412	16.00	15.99	15.99	15.93
	2437	15.97	15.95	15.96	15.90
	2462	<b>16.07</b>	16.05	16.06	16.01

**Table 10.4 IEEE 802.11b Average RF Power**

Mode	Frequency [MHz]	802.11g (2.4 GHz) Conducted Power [dBm]							
		Data Rate [Mbps]							
		6	9	12	18	24	36	48	54
802.11g	2412	11.97	11.96	11.94	11.93	11.86	11.85	10.81	10.79
	2437	11.91	11.90	11.89	11.88	11.85	11.79	10.59	10.52
	2462	11.88	11.87	11.86	11.85	11.77	11.73	10.60	10.63

**Table 10.5 IEEE 802.11g Average RF Power**

Mode	Frequency [MHz]	802.11n HT20 (2.4 GHz) Conducted Power [dBm]							
		Data Rate [Mbps]							
		0	1	2	3	4	5	6	7
802.11n (HT20)	2412	11.94	11.92	11.90	11.86	11.82	10.92	10.83	10.88
	2437	12.08	12.07	12.05	12.02	11.96	10.72	10.79	10.62
	2462	11.86	11.85	11.85	11.77	11.74	10.78	10.78	10.76

**Table 10.6 IEEE 802.11n Average RF Power**

Mode	Frequency [MHz]	802.11a (5 GHz) Conducted Power [dBm]							
		Data Rate [Mbps]							
		6	9	12	18	24	36	48	54
802.11a	5180	<b>12.69</b>	12.68	12.67	12.66	12.65	12.64	12.61	12.53
	5200	12.67	12.66	12.65	12.64	12.63	12.62	12.61	12.56
	5240	12.64	12.63	12.62	12.61	12.60	12.59	12.58	12.55
	5260	12.68	12.67	12.66	12.65	12.65	12.64	12.58	12.59
	5280	12.71	12.70	12.68	12.67	12.62	12.61	12.59	12.61
	5320	<b>12.78</b>	12.77	12.77	12.75	12.74	12.75	12.72	12.71
	5500	12.86	12.82	12.81	12.79	12.76	12.79	12.80	12.74
	5580	12.82	12.81	12.80	12.78	12.77	12.76	12.68	12.66
	5700	<b>12.94</b>	12.93	12.91	12.87	12.78	12.75	12.70	12.69

Table 10.7 IEEE 802.11a Average RF Power

Mode	Frequency [MHz]	802.11n HT20 (5 GHz) Conducted Power [dBm]							
		Data Rate [Mbps]							
		6.5	13	19.5	26	39	52	58.5	65
802.11n (HT20)	5180	<b>12.82</b>	12.78	12.69	12.67	12.63	12.62	12.55	12.63
	5200	12.77	12.76	12.75	12.68	12.64	12.61	12.57	12.56
	5240	12.70	12.68	12.66	12.60	12.57	12.51	12.50	12.49
	5260	12.82	12.81	12.79	12.63	12.56	12.54	12.51	12.48
	5280	12.71	12.70	12.67	12.53	12.51	12.48	12.47	12.45
	5320	<b>12.91</b>	12.86	12.84	12.74	12.71	12.66	12.64	12.63
	5500	12.77	12.76	12.71	12.64	12.59	12.54	12.52	12.50
	5580	12.87	12.85	12.84	12.76	12.70	12.65	12.64	12.62
		5700	<b>12.96</b>	12.95	12.93	12.88	12.81	12.79	12.74

Table 10.8 IEEE 802.11n Average RF Power - 20 MHz Bandwidth

Mode	Frequency [MHz]	802.11n HT40 (5 GHz) Conducted Power [dBm]							
		Data Rate [Mbps]							
		13.5	27	40.5	54	81	108	121.5	135
802.11n (HT40)	5190	12.56	12.53	12.46	12.38	12.30	12.26	12.25	12.24
	5230	12.60	12.59	12.55	12.46	12.37	12.27	12.21	12.19
	5270	12.57	12.56	12.52	12.47	12.35	12.32	12.31	12.30
	5310	12.72	12.71	12.69	12.41	12.33	12.32	12.31	12.30
	5510	12.68	12.66	12.63	12.55	12.44	12.40	12.37	12.36
	5590	12.77	12.76	12.72	12.63	12.53	12.50	12.40	12.35
		5670	12.80	12.79	12.74	12.66	12.57	12.53	12.50

Table 10.9 IEEE 802.11n Average RF Power - 40 MHz Bandwidth

Mode	Frequency [MHz]	802.11ac VHT20 (5 GHz) Conducted Power [dBm]									
		Data Rate [Mbps]									
		6.5	13	19.5	26	39	52	58.5	65	78	86.5
802.11ac (VHT20)	5180	12.80	12.78	12.75	12.66	12.62	12.61	12.58	12.52	11.42	11.30
	5200	12.81	12.80	12.76	12.72	12.61	12.57	12.56	12.55	11.30	11.35
	5240	12.76	12.75	12.74	12.64	12.62	12.60	12.59	12.55	11.28	11.13
	5260	12.77	12.75	12.75	12.74	12.72	12.70	12.68	12.66	11.38	11.28
	5300	12.76	12.73	12.72	12.72	12.73	12.73	12.75	12.74	11.49	11.59
	5320	12.88	12.84	12.82	12.81	12.80	12.87	12.85	12.83	11.63	11.68
	5500	12.89	12.83	12.81	12.83	12.81	12.88	12.86	12.85	11.74	11.84
	5580	12.87	12.80	12.73	12.81	12.80	12.87	12.86	12.85	11.80	11.77
5700	12.93	12.91	12.90	12.80	12.75	12.79	12.74	12.69	11.87	11.84	

Table 10.10 IEEE 802.11ac Average RF Power - 20 MHz Bandwidth

Mode	Frequency [MHz]	802.11ac VHT40 (5 GHz) Conducted Power [dBm]									
		Data Rate [Mbps]									
		13.5	27	40.5	54	81	108	121.5	135	162	180
802.11ac (VHT40)	5190	12.93	12.85	12.82	12.81	12.80	12.79	12.80	12.78	10.93	10.99
	5230	12.80	12.78	12.78	12.73	12.78	12.76	12.73	12.72	10.80	10.75
	5270	12.84	12.83	12.81	12.77	12.74	12.72	12.73	12.66	10.86	10.77
	5310	12.86	12.85	12.79	12.64	12.43	12.39	12.38	12.36	10.46	10.57
	5510	12.72	12.71	12.67	12.52	12.52	12.48	12.47	12.45	10.65	10.70
	5550	12.95	12.94	12.89	12.75	12.50	12.46	12.46	12.41	10.63	10.71
	5670	12.98	12.97	12.96	12.83	12.62	12.58	12.55	12.50	10.74	10.80

Table 10.11 IEEE 802.11n Average RF Power - 40 MHz Bandwidth

Mode	Frequency [MHz]	802.11ac VHT80 (5 GHz) Conducted Power [dBm]									
		Data Rate [Mbps]									
		29.3	58.5	87.8	117	175.5	234	263.3	292.5	351	390
802.11ac (VHT80)	5210	12.59	12.33	12.29	12.25	12.15	12.15	12.09	12.14	10.99	10.97
	5290	12.55	12.37	12.20	12.18	12.07	12.09	12.02	12.03	11.10	11.09
	5530	12.57	12.34	12.27	12.21	12.18	12.14	12.01	12.03	11.17	11.12

Table 10.12 IEEE 802.11n Average RF Power - 80 MHz Bandwidth



Justification for reduced test configurations for WIFI channels per KDB Publication 248227 D01v01r02 and October 2012 / April 2013 FCC/TCB Meeting Notes:

- For 2.4 GHz, highest average RF output power channel for the lowest data rate for IEEE 802.11b were selected for SAR evaluation. Other IEEE 802.11 modes (including 802.11g/n) were not investigated since the average output powers over all channels and data rates were not more than 0.25 dB higher than the tested channel in the lowest data rate of IEEE 802.11b mode.
- For 5 GHz, highest average RF output power channel for the lowest data rate for IEEE 802.11a were selected for SAR evaluation. Other IEEE 802.11 modes (including 802.11n 20 MHz and 40 MHz) were not investigated since the average output powers over all channels and data rates were not more than 0.25 dB higher than the tested channel in the lowest data rate of IEEE 802.11a mode.
- Full SAR tests for all IEEE 802.11ac configurations were not required because the average output power was not more than 0.25 dB higher than IEEE 802.11a mode. IEEE 802.11ac was evaluated for the highest IEEE 802.11a position in each 5 GHz band and exposure condition.
- When the maximum extrapolated peak SAR of the zoom scan for the maximum output channel is  $<1.6$  W/kg and the reported 1g averaged SAR is  $<0.8$  W/kg, SAR testing on other channels is not required. Otherwise, the other default (or corresponding required) test channels were additionally tested using the lowest data rate.
- The average output powers for 802.11ac - 20MHz (VHT20) and 802.11 ac - 40 MHz (VHT40) modes are equivalent to the 802.11n - 20 MHz (HT20) and 802.11n - 40 MHz (HT40). Therefore, no additional measurements were required for the lower bandwidth for 802.11ac.
- The underlined data rate and channel above were tested for SAR.

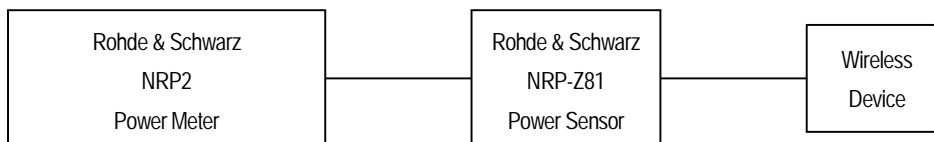

Figure 10.4 Power Measurement Setup for Bandwidths < 50 MHz



Figure 10.5 Power Measurement Setup for Bandwidths > 50 MHz

### 10.5 Bluetooth Conducted Powers

Mode	Frequency [MHz]	Output Power [1Mbps]		Output Power [2Mbps]		Output Power [3Mbps]	
		[dBm]	[mW]	[dBm]	[mW]	[dBm]	[mW]
Low	2402	<b>7.470</b>	<b>5.585</b>	6.020	3.999	6.030	4.009
Mid	2441	6.170	4.140	4.720	2.965	4.720	2.965
High	2480	6.660	4.634	5.200	3.311	5.190	3.304

**Table 10.13 Bluetooth Average RF Power**

Mode	Frequency [MHz]	Output Power [LE]	
		[dBm]	[mW]
Low	2402	<b>-3.640</b>	<b>0.433</b>
Mid	2440	-4.560	0.350
High	2480	-3.990	0.399

**Table 10.14 Bluetooth Average RF Power**

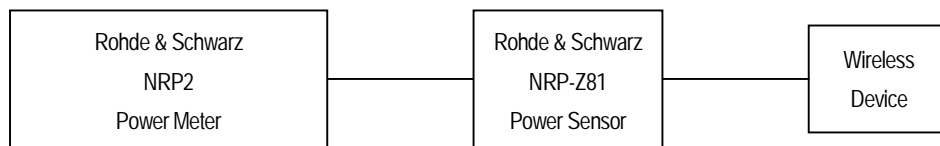

**Figure 10.6 Power Measurement Setup**

## 111. System Verification

### 11.1 Tissue verification

MEASURED TISSUE PARAMETERS										
Date(s)	Tissue Type	Ambient Temp. [°C]	Liquid Temp. [°C]	Measured Frequency [MHz]	Target Dielectric constant, $\epsilon_r$	Target Conductivity, $\sigma$ [S/m]	Measured Dielectric constant, $\epsilon_r$	Measured Conductivity, $\sigma$ [S/m]	$\epsilon_r$ Deviation [%]	$\sigma$ Deviation [%]
December. 22, 2014	750 Head	23.1	20.9	709.0	42.119	0.887	42.31	0.889	0.45	0.23
				710.0	42.113	0.887	42.27	0.886	0.37	-0.20
				711.0	42.108	0.887	42.33	0.887	0.53	-0.07
				750.0	41.900	0.890	41.82	0.926	-0.19	4.00
December. 23, 2014	750 Body	22.9	23.2	709.0	55.700	0.960	56.80	0.944	1.97	-1.67
				710.0	55.700	0.960	56.70	0.946	1.80	-1.42
				711.0	55.700	0.960	56.70	0.943	1.80	-1.74
				750.0	55.500	0.960	56.42	0.978	1.66	1.92
December. 17, 2014	835 Head	21.0	20.1	824.2	41.551	0.899	41.99	0.897	1.06	-0.17
				826.4	41.540	0.899	41.95	0.897	0.99	-0.27
				835.0	41.500	0.900	41.84	0.905	0.82	0.53
				836.6	41.500	0.902	41.86	0.909	0.87	0.78
				846.6	41.500	0.912	41.77	0.917	0.65	0.45
				848.8	41.500	0.915	41.67	0.918	0.41	0.36
December. 18, 2014	835 Body	23.1	22.4	824.2	55.203	0.980	53.85	1.007	-2.45	2.79
				826.4	55.200	0.980	53.91	1.006	-2.34	2.65
				835.0	55.200	0.980	53.75	1.015	-2.63	3.57
				836.6	55.200	0.980	53.77	1.021	-2.59	4.18
				846.6	55.200	0.987	53.69	1.031	-2.74	4.44
				848.8	55.200	0.989	53.68	1.031	-2.75	4.25
January. 23, 2015	835 Head	22.4	21.8	824.2	41.551	0.899	41.64	0.883	0.21	-1.71
				826.4	41.540	0.899	41.66	0.888	0.29	-1.26
				835.0	41.500	0.900	41.59	0.894	0.22	-0.67
				836.6	41.500	0.902	41.52	0.898	0.05	-0.45
				846.6	41.500	0.912	41.49	0.906	-0.02	-0.67
				848.8	41.500	0.915	41.43	0.909	-0.17	-0.70
January. 23, 2015	835 Body	23.5	22.8	824.2	55.203	0.980	54.63	1.000	-1.04	2.07
				826.4	55.200	0.980	54.59	1.003	-1.11	2.35
				835.0	55.200	0.980	54.46	1.010	-1.34	3.06
				836.6	55.200	0.980	54.41	1.014	-1.43	3.47
				846.6	55.200	0.987	54.36	1.023	-1.52	3.63
				848.8	55.200	0.989	54.40	1.024	-1.45	3.54
December. 18, 2014	1900 Head	22.8	20.3	1850.2	40.000	1.400	40.36	1.376	0.90	-1.71
				1852.4	40.000	1.400	40.38	1.378	0.95	-1.57
				1880.0	40.000	1.400	40.22	1.412	0.55	0.86
				1900.0	40.000	1.400	40.14	1.425	0.35	1.79
				1907.6	40.000	1.400	40.11	1.434	0.27	2.43
				1909.8	40.000	1.400	40.16	1.437	0.40	2.64
December. 19, 2014	1900 Body	23.0	22.0	1850.2	53.300	1.520	52.89	1.472	-0.77	-3.16
				1852.4	53.300	1.520	52.88	1.474	-0.79	-3.03
				1880.0	53.300	1.520	52.77	1.501	-0.99	-1.25
				1900.0	53.300	1.520	52.74	1.517	-1.05	-0.20
				1907.6	53.300	1.520	52.70	1.524	-1.13	0.26
				1909.8	53.300	1.520	52.65	1.527	-1.22	0.46
December. 25, 2014	1900 Body	22.3	20.2	1850.2	53.300	1.520	52.26	1.499	-1.95	-1.38
				1852.4	53.300	1.520	52.28	1.500	-1.91	-1.32
				1880.0	53.300	1.520	52.17	1.531	-2.12	0.72
				1900.0	53.300	1.520	51.95	1.553	-2.53	2.17
				1907.6	53.300	1.520	52.06	1.555	-2.33	2.30
				1909.8	53.300	1.520	51.99	1.558	-2.46	2.50

MEASURED TISSUE PARAMETERS										
Date(s)	Tissue Type	Ambient Temp. [°C]	Liquid Temp. [°C]	Measured Frequency [MHz]	Target Dielectric constant, $\epsilon_r$	Target Conductivity, $\sigma$ [S/m]	Measured Dielectric constant, $\epsilon_r$	Measured Conductivity, $\sigma$ [S/m]	$\epsilon_r$ Deviation [%]	$\sigma$ Deviation [%]
December. 17, 2014	2450 Head	22.6	22.3	2412	39.265	1.766	39.10	1.796	-0.42	1.68
				2437	39.222	1.788	39.05	1.825	-0.44	2.04
				2450	39.200	1.800	38.97	1.842	-0.59	2.33
				2462	39.184	1.813	38.92	1.856	-0.67	2.38
December. 17, 2014	2450 Body	22.6	22.3	2412	52.752	1.914	51.10	1.912	-3.13	-0.13
				2437	52.700	1.940	51.05	1.950	-3.13	0.54
				2450	52.700	1.950	50.98	1.966	-3.26	0.82
				2462	52.700	1.969	50.92	1.980	-3.38	0.55
December. 15, 2014	5GHz Head	23.3	20.2	5180	36.000	4.636	36.30	4.552	0.83	-1.81
				5200	36.000	4.660	36.29	4.581	0.81	-1.70
				5210	35.980	4.670	36.26	4.592	0.78	-1.67
				5240	35.920	4.700	36.21	4.626	0.81	-1.57
				5260	35.900	4.720	36.15	4.636	0.70	-1.78
				5280	35.900	4.740	36.15	4.662	0.70	-1.65
				5290	35.900	4.750	36.15	4.660	0.70	-1.89
				5300	35.900	4.760	36.09	4.685	0.53	-1.58
				5320	35.860	4.780	36.11	4.692	0.70	-1.84
				5500	35.600	4.960	35.83	4.904	0.65	-1.13
				5530	35.600	4.990	35.76	4.925	0.45	-1.30
				5580	35.540	5.046	35.70	4.965	0.45	-1.61
				5600	35.500	5.070	35.73	5.001	0.65	-1.36
				5700	35.400	5.170	35.46	5.106	0.17	-1.24
5800	35.300	5.270	35.38	5.195	0.23	-1.42				
December. 16, 2014	5GHz Head	24.3	20.1	5180	36.000	4.636	36.02	4.563	0.06	-1.57
				5200	36.000	4.660	36.03	4.577	0.08	-1.78
				5210	35.980	4.670	36.06	4.584	0.22	-1.84
				5240	35.920	4.700	36.00	4.618	0.22	-1.74
				5260	35.900	4.720	36.01	4.650	0.31	-1.48
				5280	35.900	4.740	35.94	4.665	0.11	-1.58
				5290	35.900	4.750	35.86	4.677	-0.11	-1.54
				5300	35.900	4.760	35.89	4.673	-0.03	-1.83
				5320	35.860	4.780	35.85	4.697	-0.03	-1.74
				5500	35.600	4.960	35.58	4.865	-0.06	-1.92
				5530	35.600	4.990	35.54	4.927	-0.17	-1.26
				5580	35.540	5.046	35.45	4.964	-0.25	-1.63
				5600	35.500	5.070	35.41	4.989	-0.25	-1.60
				5700	35.400	5.170	35.28	5.100	-0.34	-1.35
5800	35.300	5.270	35.08	5.213	-0.62	-1.08				
December. 19, 2014	5GHz Head	21.8	22.0	5180	36.000	4.636	36.13	4.518	0.36	-2.55
				5200	36.000	4.660	36.06	4.537	0.17	-2.64
				5210	35.980	4.670	36.05	4.570	0.19	-2.14
				5240	35.920	4.700	36.10	4.580	0.50	-2.55
				5260	35.900	4.720	36.05	4.598	0.42	-2.58
				5280	35.900	4.740	35.99	4.619	0.25	-2.55
				5290	35.900	4.750	35.93	4.625	0.08	-2.63
				5300	35.900	4.760	35.95	4.625	0.14	-2.84
				5320	35.860	4.780	35.93	4.673	0.20	-2.24
				5500	35.600	4.960	35.68	4.829	0.22	-2.64
				5530	35.600	4.990	35.66	4.853	0.17	-2.75
				5580	35.540	5.046	35.57	4.925	0.08	-2.40
				5600	35.500	5.070	35.49	4.934	-0.03	-2.68
				5700	35.400	5.170	35.41	5.036	0.03	-2.59
5800	35.300	5.270	35.26	5.152	-0.11	-2.24				

MEASURED TISSUE PARAMETERS										
Date(s)	Tissue Type	Ambient Temp. [°C]	Liquid Temp. [°C]	Measured Frequency [MHz]	Target Dielectric constant, $\epsilon_r$	Target Conductivity, $\sigma$ [S/m]	Measured Dielectric constant, $\epsilon_r$	Measured Conductivity, $\sigma$ [S/m]	$\epsilon_r$ Deviation [%]	$\sigma$ Deviation [%]
December. 22, 2014	5GHz Body	21.9	21.0	5180	49.040	5.276	49.03	5.126	-0.02	-2.84
				5200	49.000	5.300	48.95	5.208	-0.10	-1.74
				5210	48.980	5.312	49.08	5.240	0.20	-1.36
				5240	48.920	5.348	48.95	5.217	0.06	-2.45
				5260	48.900	5.372	48.87	5.302	-0.06	-1.30
				5280	48.890	5.396	48.95	5.318	0.12	-1.45
				5290	48.900	5.408	48.80	5.317	-0.20	-1.68
				5300	48.900	5.420	48.83	5.346	-0.14	-1.37
				5320	48.860	5.440	48.79	5.414	-0.14	-0.48
				5500	48.600	5.650	48.63	5.680	0.06	0.53
				5530	48.540	5.686	48.41	5.695	-0.27	0.16
				5580	48.500	5.746	48.49	5.796	-0.02	0.87
				5600	48.500	5.770	48.34	5.844	-0.33	1.28
				5700	48.300	5.880	48.09	5.960	-0.43	1.36
5800	48.200	6.000	48.02	6.137	-0.37	2.28				
January. 21, 2015	5GHz Head	22.8	21.1	5180	36.000	4.636	36.31	4.473	0.86	-3.52
				5200	36.000	4.660	36.39	4.483	1.08	-3.80
				5210	35.980	4.670	36.33	4.484	0.97	-3.98
				5240	35.920	4.700	36.22	4.512	0.84	-4.00
				5260	35.900	4.720	36.26	4.545	1.00	-3.71
				5280	35.900	4.740	36.29	4.577	1.09	-3.44
				5290	35.900	4.750	36.29	4.585	1.09	-3.47
				5300	35.900	4.760	36.26	4.586	1.00	-3.66
				5320	35.860	4.780	36.23	4.581	1.03	-4.16
				5500	35.600	4.960	36.01	4.809	1.15	-3.04
				5530	35.600	4.990	35.97	4.809	1.04	-3.63
				5580	35.540	5.046	35.85	4.890	0.87	-3.09
				5600	35.500	5.070	35.79	4.915	0.82	-3.06
				5700	35.400	5.170	35.71	5.022	0.88	-2.86
5800	35.300	5.270	35.55	5.120	0.71	-2.85				
January. 22, 2015	5GHz Body	22.5	22.0	5180	49.040	5.276	49.17	5.308	0.27	0.61
				5200	49.000	5.300	49.13	5.338	0.27	0.72
				5210	48.980	5.312	49.07	5.341	0.18	0.55
				5240	48.920	5.348	48.92	5.393	0.00	0.84
				5260	48.900	5.372	48.98	5.414	0.16	0.78
				5280	48.890	5.396	48.98	5.438	0.18	0.78
				5290	48.900	5.408	48.93	5.473	0.06	1.20
				5300	48.900	5.420	48.95	5.476	0.10	1.03
				5320	48.860	5.440	48.86	5.483	0.00	0.79
				5500	48.600	5.650	48.65	5.707	0.08	1.01
				5530	48.540	5.686	48.52	5.776	-0.04	1.58
				5580	48.500	5.746	48.53	5.871	0.06	2.18
				5600	48.500	5.770	48.41	5.871	-0.19	1.75
				5700	48.300	5.880	48.35	6.038	0.10	2.69
5800	48.200	6.000	48.19	6.170	-0.02	2.83				

### Tissue Verification Note

Note: The above measured tissue parameters were used in the DASY software. The DASY software was used to perform interpolation to determine the dielectric parameters at the SAR test device frequencies (per IEEE 1528 6.6.1.2). The tissue parameters listed in the SAR test plots may slightly differ from the table above due to significant digit rounding in the software.

### Measurement Procedure for Tissue verification

- 1) The network analyzer and probe system was configured and calibrated.
- 2) The probe was immersed in the sample which was placed in a nonmetallic container. Trapped air bubbles beneath the flange were minimized by placing the probe at a slight angle.
- 3) The complex admittance with respect to the probe aperture was measured.
- 4) The complex relative permittivity, for example from the below equation (Pournaropoulos and Misra):

$$Y = \frac{j2\omega\varepsilon'_r \varepsilon_0}{[\ln(b/a)]^2} \int_a^b \int_a^b \int_0^\pi \cos \phi' \frac{\exp\left[-j\omega(\varepsilon_0\varepsilon'_r \varepsilon_0)^{1/2} r\right]}{r} d\phi' d\rho' d\rho$$

Where Y is the admittance of the probe in contact with the sample, the primed and unprimed coordinates refer to source and observation points, respectively,  $r^2 = \rho^2 + \rho'^2 - 2\rho\rho' \cos \phi'$ ,  $\omega$  is the angular frequency, and  $j = \sqrt{-1}$ .

## 11.2 Test system verification

Prior to assessment, the system is verified to the  $\pm 10\%$  of the specifications at 750MHz, 835 MHz, 1900 MHz, 2450 MHz and 5 GHz by using the SAR Dipole kit(s). (Graphic Plots Attached)

SYSTEM DIPOLE VERIFICATION TARGET & MEASURED											
Freq. [MHz]	SAR Dipole Kits	Date(s)	Liquid	Ambient Temp.[°C]	Liquid Temp.[°C]	Probe S/N	Input Power [mW]	1W Targeted SAR 1g [W/kg]	Measured SAR 1g [W/kg]	1W Normalized SAR 1g [W/kg]	Deviation [%]
750	D750V3, S/N: 1115	December. 22, 2014	Head	23.1	20.9	3745	250	8.13	2.09	8.36	2.83
750	D750V3, S/N: 1115	December. 23, 2014	Body	22.9	23.2	3745	250	8.48	2.14	8.56	0.94
835	D835V2, S/N: 4d104	December. 17, 2014	Head	21.0	20.1	3745	250	9.18	2.19	8.76	-4.58
835	D835V2, S/N: 4d104	December. 18, 2014	Body	23.1	22.4	3745	250	9.43	2.32	9.28	-1.59
835	D835V2, S/N: 4d163	January. 23, 2015	Head	22.4	21.8	3957	250	9.19	2.45	9.80	6.64
835	D835V2, S/N: 4d163	January. 23, 2015	Body	23.5	22.8	3957	250	9.46	2.16	8.64	-8.67
1900	D1900V2, S/N: 5d129	December. 18, 2014	Head	22.8	20.3	3745	250	40.1	9.63	38.52	-3.94
1900	D1900V2, S/N: 5d129	December. 19, 2014	Body	23.0	22.0	3745	250	40.4	9.40	37.60	-6.93
1900	D1900V2, S/N: 5d129	December. 25, 2014	Body	22.3	20.3	3745	250	40.4	9.96	39.84	-1.39
2450	D2450V2, S/N: 894	December. 17, 2014	Head	22.6	22.3	3745	250	53.2	13.20	52.80	-0.75
2450	D2450V2, S/N: 894	December. 17, 2014	Body	22.6	22.3	3745	250	51.4	13.50	54.00	5.06
5200	D5GHzV2, S/N: 1092	December. 15, 2014	Head	23.3	20.2	3745	100	80.6	8.30	83.00	2.98
5500	D5GHzV2, S/N: 1092							87.1	9.43	94.30	8.27
5800	D5GHzV2, S/N: 1092							80.1	8.64	86.40	7.87
5200	D5GHzV2, S/N: 1092	December. 16, 2014	Head	24.3	20.1	3745	100	80.6	8.19	81.90	1.61
5500	D5GHzV2, S/N: 1092							87.1	8.12	81.20	-6.77
5800	D5GHzV2, S/N: 1092							80.1	7.95	79.50	-0.75
5200	D5GHzV2, S/N: 1092	December. 19, 2014	Head	21.8	22.0	3745	100	80.6	7.97	79.70	-1.12
5500	D5GHzV2, S/N: 1092							87.1	8.71	87.10	0.00
5800	D5GHzV2, S/N: 1092							80.1	8.04	80.40	0.37
5200	D5GHzV2, S/N: 1092	December. 22, 2014	Body	21.9	21.0	3745	100	76.4	7.42	74.20	-2.88
5500	D5GHzV2, S/N: 1092							81.2	7.89	78.90	-2.83
5800	D5GHzV2, S/N: 1092							77.2	8.27	82.70	7.12



Zacta

SYSTEM DIPOLE VERIFICATION TARGET & MEASURED											
Freq. [MHz]	SAR Dipole Kits	Date(s)	Liquid	Ambient Temp.[°C]	Liquid Temp.[°C]	Probe S/N	Input Power [mW]	1W Targeted SAR 1g [W/kg]	Measured SAR 1g [W/kg]	1W Normalized SAR 1g [W/kg]	Deviation [%]
5200	D5GHzV2, S/N: 1166	January. 21, 2015	Head	22.8	21.1	3957	100	78.9	7.78	77.80	-1.39
5500	D5GHzV2, S/N: 1166							84.9	8.55	85.50	0.71
5800	D5GHzV2, S/N: 1166							79.0	7.88	78.80	-0.25
5200	D5GHzV2, S/N: 1166	January. 22, 2015	Body	22.5	22.0	3957	100	75.2	7.83	78.30	4.12
5500	D5GHzV2, S/N: 1166							79.6	8.03	80.30	0.88
5800	D5GHzV2, S/N: 1166							74.9	7.43	74.30	-0.80



Note1 : Validation was measured with input 250 mW, 100 mW and normalized to 1W.

Note2 : To confirm the proper SAR liquid depth, the z-axis plots from the system verifications were included since the system verifications were performed using the same liquid, probe and DAE as the SAR tests in the same time period.

Note3: Full system validation status and results can be found in Attachment 3.

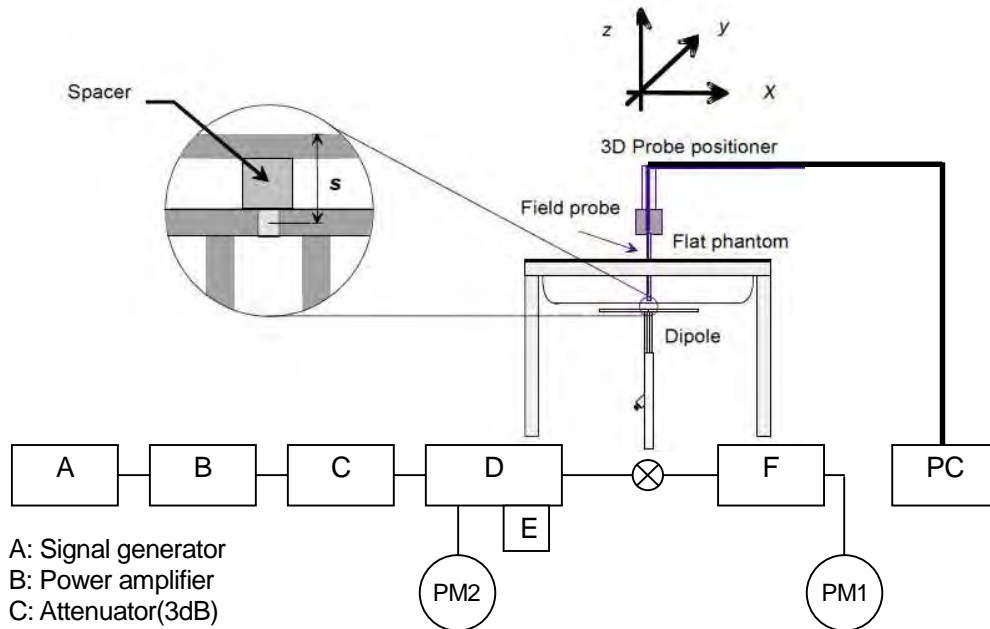

Figure10.1 Dipole Verification Test Setup



## 12. SAR Test Results

### 12.1 Head SAR Results

MEASUREMENT RESULTS														
Plot No.	Frequency		Mode/ Band	Service	Maximum Allowed Power [dBm]	Conducted Power [dBm]	Drift Power [dB]	Phantom Position	Device Serial Number	# of Time slots	Dyty Cycle	1g SAR [W/kg]	Scaling Factor	1g Scaled SAR [W/kg]
	MHz	Ch												
	836.6	190	GSM850	GSM	33.0	32.67	-0.08	Left Touch	FCC#1	1	1: 8.3	0.345	1.079	0.372
1	836.6	190	GSM850	GSM	33.0	32.67	0.07	Right Touch	FCC#1	1	1: 8.3	0.372	1.079	<b>0.401</b>
	836.6	190	GSM850	GSM	33.0	32.67	-0.01	Left Tilt	FCC#1	1	1: 8.3	0.239	1.079	0.258
	836.6	190	GSM850	GSM	33.0	32.67	-0.15	Right Tilt	FCC#1	1	1: 8.3	0.241	1.079	0.260
	836.6	190	GSM850	GPRS	33.0	32.66	0.01	Right Touch	FCC#1	1	1: 8.3	0.380	1.081	0.411
	836.6	190	GSM850	GPRS	32.5	31.95	-0.04	Right Touch	FCC#1	2	1: 4.2	0.700	1.135	0.795
	824.2	128	GSM850	GPRS	30.0	29.84	-0.20	Right Touch	FCC#1	3	1: 2.8	0.715	1.038	0.742
	836.6	190	GSM850	GPRS	30.0	29.79	-0.10	Right Touch	FCC#1	3	1: 2.8	0.787	1.050	0.826
	848.8	251	GSM850	GPRS	30.0	29.73	-0.14	Right Touch	FCC#1	3	1: 2.8	0.734	1.064	0.781
	824.2	128	GSM850	GPRS	29.5	29.18	0.11	Right Touch	FCC#1	4	1: 2.1	0.897	1.076	0.966
2	836.6	190	GSM850	GPRS	29.5	29.21	-0.15	Right Touch	FCC#1	4	1: 2.1	0.922	1.069	<b>0.986</b>
	848.8	251	GSM850	GPRS	29.5	28.82	-0.09	Right Touch	FCC#1	4	1: 2.1	0.805	1.169	0.941
	824.2	128	GSM850	GPRS	29.5	29.18	-0.08	Left Touch	FCC#1	4	1: 2.1	0.862	1.076	0.928
	836.6	190	GSM850	GPRS	29.5	29.21	-0.03	Left Touch	FCC#1	4	1: 2.1	0.882	1.069	0.943
	848.8	251	GSM850	GPRS	29.5	28.82	-0.13	Left Touch	FCC#2	4	1: 2.1	0.664	1.169	0.777
	836.6	190	GSM850	GPRS	29.5	29.21	0.04	Left Tilt	FCC#1	4	1: 2.1	0.561	1.069	0.600
	836.6	190	GSM850	GPRS	29.5	29.21	0.06	Right Tilt	FCC#1	4	1: 2.1	0.582	1.069	0.622
	836.6	190	GSM850	GPRS	29.5	29.21	-0.14	Right Touch	FCC#1	4	1: 2.1	0.911	1.069	0.974
ANSI / IEEE C95.1-2005– SAFETY LIMIT Spatial Peak Uncontrolled Exposure/General Population Exposure								Head 1.6 W/kg(mW/g) averaged over 1 gram						

Table 12.1 GSM/GPRS 850 Head SAR

Note: Blue entries represent repeatability measurements.



Zacta

MEASUREMENT RESULTS														
Plot No.	Frequency		Mode/ Band	Service	Maximum Allowed Power [dBm]	Conducted Power [dBm]	Drift Power [dB]	Phantom Position	Device Serial Number	# of Time slots	Dyty Cycle	1g SAR [W/kg]	Scaling Factor	1g Scaled SAR [W/kg]
	MHz	Ch												
	1880.0	661	PCS1900	PCS	30.0	29.22	0.13	Left Touch	FCC#1	1	1: 8.3	0.0684	1.197	0.0819
3	1880.0	661	PCS1900	PCS	30.0	29.22	-0.04	Right Touch	FCC#1	1	1: 8.3	0.130	1.197	<b>0.156</b>
	1880.0	661	PCS1900	PCS	30.0	29.22	-0.09	Left Tilt	FCC#1	1	1: 8.3	0.0284	1.197	0.0340
	1880.0	661	PCS1900	PCS	30.0	29.22	0.05	Right Tilt	FCC#1	1	1: 8.3	0.0230	1.197	0.0275
	1880.0	661	PCS1900	GPRS	30.0	29.23	0.14	Right Touch	FCC#1	1	1: 8.3	0.119	1.194	0.142
4	1880.0	661	PCS1900	GPRS	29.0	28.67	0.11	Right Touch	FCC#1	2	1: 4.2	0.224	1.079	<b>0.242</b>
	1880.0	661	PCS1900	GPRS	27.0	26.74	0.16	Right Touch	FCC#1	3	1: 2.8	0.203	1.062	0.216
	1880.0	661	PCS1900	GPRS	26.0	25.64	-0.05	Right Touch	FCC#1	4	1: 2.1	0.202	1.086	0.219
	1880.0	661	PCS1900	GPRS	29.0	28.67	0.05	Left Touch	FCC#1	2	1: 4.2	0.114	1.079	0.123
	1880.0	661	PCS1900	GPRS	29.0	28.67	-0.19	Left Tilt	FCC#1	2	1: 4.2	0.0428	1.079	0.0462
	1880.0	661	PCS1900	GPRS	29.0	28.67	0.04	Right Tilt	FCC#1	2	1: 4.2	0.0400	1.079	0.0432
ANSI / IEEE C95.1-2005– SAFETY LIMIT Spatial Peak Uncontrolled Exposure/General Population Exposure								Head 1.6 W/kg(mW/g) averaged over 1 gram						

Table 12.2 PCS/GPRS 1900 Head SAR

MEASUREMENT RESULTS													
Plot No.	Frequency		Mode/ Band	Service	Maximum Allowed Power [dBm]	Conducted Power [dBm]	Drift Power [dB]	Phantom Position	Device Serial Number	1g SAR [W/kg]	Dyuty Cycle	Scaling Factor	1g Scaled SAR [W/kg]
	MHz	Ch											
	836.6	4183	WCDMA850	RMC	24.0	23.53	0.11	Left Touch	FCC#2	0.290	1:1	1.020	0.296
5	836.6	4183	WCDMA850	RMC	24.0	23.53	-0.19	Right Touch	FCC#2	0.338	1:1	1.020	<b>0.345</b>
	836.6	4183	WCDMA850	RMC	24.0	23.53	0.15	Left Tilt	FCC#2	0.0897	1:1	1.020	0.0915
	836.6	4183	WCDMA850	RMC	24.0	23.53	-0.08	Right Tilt	FCC#2	0.0800	1:1	1.020	0.0816
<b>ANSI / IEEE C95.1-2005– SAFETY LIMIT</b> <b>Spatial Peak</b> <b>Uncontrolled Exposure/General Population Exposure</b>								Head 1.6 W/kg(mW/g) averaged over 1 gram					

Table 12.3 WCDMA 850 Head SAR

MEASUREMENT RESULTS													
Plot No.	Frequency		Mode/ Band	Service	Maximum Allowed Power [dBm]	Conducted Power [dBm]	Drift Power [dB]	Phantom Position	Device Serial Number	1g SAR [W/kg]	Dyuty Cycle	Scaling Factor	1g Scaled SAR [W/kg]
	MHz	Ch											
	1880.0	9400	WCDMA1900	RMC	23.0	22.63	0.18	Left Touch	FCC#1	0.0922	1:1	1.016	0.0937
6	1880.0	9400	WCDMA1900	RMC	23.0	22.63	-0.17	Right Touch	FCC#1	0.179	1:1	1.016	<b>0.182</b>
	1880.0	9400	WCDMA1900	RMC	23.0	22.63	0.01	Left Tilt	FCC#1	0.0472	1:1	1.016	0.0480
	1880.0	9400	WCDMA1900	RMC	23.0	22.63	-0.11	Right Tilt	FCC#1	0.0366	1:1	1.016	0.0372
<b>ANSI / IEEE C95.1-2005– SAFETY LIMIT</b> <b>Spatial Peak</b> <b>Uncontrolled Exposure/General Population Exposure</b>								Head 1.6 W/kg(mW/g) averaged over 1 gram					

Table 12.4 WCDMA 1900 Head SAR

MEASUREMENT RESULTS															
Plot No.	Frequency		Band	Modulation / Band width [MHz]	Maximum Allowed Power [dBm]	Conducted Power [dBm]	Drift Power [dB]	Phantom Position	Device Serial Number	RB Size	RB Offset	Dyty Cycle	1g SAR [W/kg]	Scaling Factor	1g Scaled SAR [W/kg]
	MHz	Ch													
	710.0	23790	LTE Band 17	QPSK, 10M	24.5	23.95	0.15	Left Touch	FCC#1	1	0	1:1	0.120	1.135	0.136
7	710.0	23790	LTE Band 17	QPSK, 10M	24.5	23.95	-0.02	Right Touch	FCC#1	1	0	1:1	0.136	1.135	<b>0.154</b>
	710.0	23790	LTE Band 17	QPSK, 10M	24.5	23.95	0.17	Left Tilt	FCC#1	1	0	1:1	0.0569	1.135	0.0646
	710.0	23790	LTE Band 17	QPSK, 10M	24.5	23.95	-0.17	Right Tilt	FCC#1	1	0	1:1	0.0565	1.135	0.0641
	709.0	23780	LTE Band 17	QPSK, 10M	24.5	22.91	0.11	Left Touch	FCC#1	25	0	1:1	0.0942	1.442	0.136
	709.0	23780	LTE Band 17	QPSK, 10M	24.5	22.91	0.09	Right Touch	FCC#1	25	0	1:1	0.102	1.442	0.147
	709.0	23780	LTE Band 17	QPSK, 10M	24.5	22.91	-0.15	Left Tilt	FCC#1	25	0	1:1	0.0442	1.442	0.0637
	709.0	23780	LTE Band 17	QPSK, 10M	24.5	22.91	-0.20	Right Tilt	FCC#1	25	0	1:1	0.0427	1.442	0.0616
ANSI / IEEE C95.1-2005– SAFETY LIMIT Spatial Peak Uncontrolled Exposure/General Population Exposure								Head 1.6 W/kg(mW/g) averaged over 1 gram							

Table 12.5 LTE Band 17 Head SAR

MEASUREMENT RESULTS														
Plot No.	Frequency		Mode/ Band	Service	Maximum Allowed Power [dBm]	Conducted Power [dBm]	Drift Power [dB]	Phantom Position	Device Serial Number	Data Rate [Mbps]	Dyty Cycle	1g SAR [W/kg]	Scaling Factor	1g Scaled SAR [W/kg]
	MHz	Ch												
8	2462	11	802.11b	DSSS	16.9	16.07	0.03	Left Touch	FCC #1	1	1:1	0.0173	1.211	<b>0.0209</b>
	2462	11	802.11b	DSSS	16.9	16.07	-0.16	Right Touch	FCC #1	1	1:1	0.00708	1.211	0.00857
	2462	11	802.11b	DSSS	16.9	16.07	0.17	Left Tilt	FCC #1	1	1:1	0.0102	1.211	0.0123
	2462	11	802.11b	DSSS	16.9	16.07	0.04	Right Tilt	FCC #1	1	1:1	0.00500	1.211	0.00605
ANSI / IEEE C95.1-2005– SAFETY LIMIT Spatial Peak Uncontrolled Exposure/General Population Exposure								Head 1.6 W/kg(mW/g) averaged over 1 gram						

Table 12.6 DTS Head SAR

MEASUREMENT RESULTS														
Plot No.	Frequency		Mode/ Band	Service	Maximum Allowed Power [dBm]	Conducted Power [dBm]	Drift Power [dB]	Phantom Position	Device Serial Number	Data Rate [Mbps]	Dyty Cycle	1g SAR [W/kg]	Scaling Factor	1g Scaled SAR [W/kg]
	MHz	Ch												
	5180	36	802.11a	OFDM	13.0	12.69	0.10	Left Touch	FCC#2	6	1:1	0.290	1.074	0.311
	5180	36	802.11a	OFDM	13.0	12.69	-0.15	Right Touch	FCC#2	6	1:1	0.301	1.074	0.323
	5180	36	802.11a	OFDM	13.0	12.69	-0.06	Left Tilt	FCC#2	6	1:1	0.350	1.074	0.376
9	5210	42	802.11ac	OFDM	13.0	12.59	0.09	Left Tilt	FCC#2	29.3	1:1	0.357	1.099	<b>0.392</b>
	5180	36	802.11a	OFDM	13.0	12.69	0.20	Right Tilt	FCC#2	6	1:1	0.347	1.074	0.373
	5320	64	802.11a	OFDM	13.0	12.78	0.04	Left Touch	FCC#2	6	1:1	0.373	1.052	0.392
	5320	64	802.11a	OFDM	13.0	12.78	0.05	Right Touch	FCC#2	6	1:1	0.381	1.052	0.401
	5320	64	802.11a	OFDM	13.0	12.78	0.12	Left Tilt	FCC#2	6	1:1	0.422	1.052	0.444
	5320	64	802.11a	OFDM	13.0	12.78	0.17	Right Tilt	FCC#2	6	1:1	0.453	1.052	0.477
10	5290	58	802.11ac	OFDM	13.0	12.55	0.00	Right Tilt	FCC#1	29.3	1:1	0.539	1.109	<b>0.598</b>
	5500	100	802.11a	OFDM	13.0	12.86	0.02	Left Touch	FCC#2	6	1:1	0.516	1.033	0.533
	5580	116	802.11a	OFDM	13.0	12.82	0.04	Left Touch	FCC#2	6	1:1	0.701	1.042	0.731
	5700	140	802.11a	OFDM	13.0	12.94	0.05	Left Touch	FCC#2	6	1:1	0.808	1.014	0.819
	5700	140	802.11a	OFDM	13.0	12.94	-0.05	Right Touch	FCC#1	6	1:1	0.647	1.014	0.656
	5500	100	802.11a	OFDM	13.0	12.86	0.14	Left Tilt	FCC#2	6	1:1	0.628	1.033	0.649
	5580	116	802.11a	OFDM	13.0	12.82	0.02	Left Tilt	FCC#2	6	1:1	0.836	1.042	0.871
11	5700	140	802.11a	OFDM	13.0	12.94	0.04	Left Tilt	FCC#2	6	1:1	1.02	1.014	<b>1.03</b>
	5530	106	802.11ac	OFDM	13.0	12.57	0.11	Left Tilt	FCC#2	29.3	1:1	0.703	1.104	0.776
	5500	100	802.11a	OFDM	13.0	12.86	0.14	Right Tilt	FCC#1	6	1:1	0.518	1.033	0.535
	5580	116	802.11a	OFDM	13.0	12.82	0.03	Right Tilt	FCC#1	6	1:1	0.665	1.042	0.693
	5700	140	802.11a	OFDM	13.0	12.94	0.18	Right Tilt	FCC#1	6	1:1	0.814	1.014	0.825
	5700	140	802.11a	OFDM	13.0	12.94	0.02	Left Tilt	FCC#2	6	1:1	0.976	1.014	0.990
ANSI / IEEE C95.1-2005– SAFETY LIMIT Spatial Peak Uncontrolled Exposure/General Population Exposure								Head 1.6 W/kg(mW/g) averaged over 1 gram						

Table 12.7 NII Head SAR

Note: Blue entries represent repeatability measurements.

MEASUREMENT RESULTS														
Plot No.	Frequency		Mode/ Band	Service	Maximum Allowed Power [dBm]	Conducted Power [dBm]	Drift Power [dB]	Phantom Position	Device Serial Number	Data Rate [Mbps]	Dyty Cycle	1g SAR [W/kg]	Scaling Factor	1g Scaled SAR [W/kg]
	MHz	Ch												
	5180	36	802.11n	OFDM	13.0	12.82	-0.19	Left Touch	FCC#2	6.5	1:1	0.352	1.042	0.367
	5180	36	802.11n	OFDM	13.0	12.82	-0.01	Right Touch	FCC#2	6.5	1:1	0.425	1.042	0.443
	5180	36	802.11n	OFDM	13.0	12.82	0.15	Left Tilt	FCC#2	6.5	1:1	0.388	1.042	0.404
	5180	36	802.11n	OFDM	13.0	12.82	0.03	Right Tilt	FCC#2	6.5	1:1	0.480	1.042	0.500
12	5210	42	802.11ac	OFDM	13.0	12.59	-0.16	Right Tilt	FCC#2	29.3	1:1	0.483	1.099	<b>0.531</b>
	5320	64	802.11n	OFDM	13.0	12.91	-0.20	Left Touch	FCC#1	6.5	1:1	0.404	1.021	0.412
	5320	64	802.11n	OFDM	13.0	12.91	0.20	Right Touch	FCC#2	6.5	1:1	0.545	1.021	0.556
	5320	64	802.11n	OFDM	13.0	12.91	0.15	Left Tilt	FCC#1	6.5	1:1	0.458	1.021	0.468
13	5320	64	802.11n	OFDM	13.0	12.91	0.10	Right Tilt	FCC#2	6.5	1:1	0.598	1.021	<b>0.611</b>
	5290	58	802.11ac	OFDM	13.0	12.55	0.00	Right Tilt	FCC#1	29.3	1:1	0.539	1.109	0.598
	5700	140	802.11n	OFDM	13.0	12.96	0.05	Left Touch	FCC#1	6.5	1:1	0.707	1.009	0.714
	5700	140	802.11n	OFDM	13.0	12.96	-0.08	Right Touch	FCC#1	6.5	1:1	0.781	1.009	0.788
	5700	140	802.11n	OFDM	13.0	12.96	-0.06	Left Tilt	FCC#1	6.5	1:1	0.779	1.009	0.786
	5500	100	802.11n	OFDM	13.0	12.77	0.14	Right Tilt	FCC#1	6.5	1:1	0.726	1.054	0.765
	5580	116	802.11n	OFDM	13.0	12.87	0.07	Right Tilt	FCC#1	6.5	1:1	0.869	1.030	0.895
14	5700	140	802.11n	OFDM	13.0	12.96	0.13	Right Tilt	FCC#1	6.5	1:1	1.14	1.009	<b>1.15</b>
	5530	106	802.11ac	OFDM	13.0	12.57	0.02	Right Tilt	FCC#1	29.3	1:1	0.749	1.104	0.827
	5700	140	802.11n	OFDM	13.0	12.96	0.13	Right Tilt	FCC#1	6.5	1:1	1.05	1.009	1.06
<b>ANSI / IEEE C95.1-2005– SAFETY LIMIT</b>								Head						
<b>Spatial Peak</b>								1.6 W/kg(mW/g)						
<b>Uncontrolled Exposure/General Population Exposure</b>								averaged over						
								1 gram						

Table 12.8 NII Head SAR

Note: Blue entries represent repeatability measurements.

## 12.2 Standalone Body-Worn SAR Results

MEASUREMENT RESULTS														
Plot No.	Frequency		Mode/ Band	Service	Maximum Allowed Power [dBm]	Conducted Power [dBm]	Drift Power [dB]	Spacing [Side]	Device Serial Number	# of Time slots	Dytc Cycle	1g SAR [W/kg]	Scaling Factor	1g Scaled SAR [W/kg]
	MHz	Ch												
	836.6	190	GSM850	GSM	33.0	32.67	-0.16	10mm [Front]	FCC#1	1	1: 8.3	0.524	1.079	0.565
15	836.6	190	GSM850	GSM	33.0	32.67	-0.02	10mm [Rear]	FCC#1	1	1: 8.3	0.598	1.079	<b>0.645</b>
	824.2	128	GSM850	GPRS	29.5	29.18	-0.05	10mm [Front]	FCC#1	4	1: 2.1	1.31	1.076	1.41
	836.6	190	GSM850	GPRS	29.5	29.21	-0.15	10mm [Front]	FCC#1	4	1: 2.1	1.14	1.069	1.22
	848.8	251	GSM850	GPRS	29.5	28.82	0.04	10mm [Front]	FCC#1	4	1: 2.1	1.04	1.169	1.22
16	824.2	128	GSM850	GPRS	29.5	29.18	0.20	10mm [Rear]	FCC#1	4	1: 2.1	1.46	1.076	<b>1.57</b>
	836.6	190	GSM850	GPRS	29.5	29.21	0.03	10mm [Rear]	FCC#1	4	1: 2.1	1.33	1.069	1.42
	848.8	251	GSM850	GPRS	29.5	28.82	-0.08	10mm [Rear]	FCC#1	4	1: 2.1	1.05	1.169	1.23
	1880.0	661	PCS1900	PCS	30.0	29.22	-0.11	10mm [Front]	FCC#2	1	1: 8.3	0.127	1.197	0.152
17	1880.0	661	PCS1900	PCS	30.0	29.22	0.16	10mm [Rear]	FCC#2	1	1: 8.3	0.378	1.197	<b>0.452</b>
	1880.0	661	PCS1900	GPRS	29.0	28.67	0.06	10mm [Front]	FCC#2	2	1: 4.2	0.215	1.079	0.232
18	1880.0	661	PCS1900	GPRS	29.0	28.67	-0.20	10mm [Rear]	FCC#2	2	1: 4.2	0.578	1.079	<b>0.624</b>
26	1880.0	661	PCS1900	GPRS	29.0	28.67	0.10	10mm [Rear]	FCC#2	2	1: 4.2	0.625	1.079	<b>0.674</b>
	836.6	4183	WCDMA850	RMC	24.0	23.53	-0.17	10mm [Front]	FCC#2	N/A	1:1	0.461	1.114	0.514
19	836.6	4183	WCDMA850	RMC	24.0	23.53	0.01	10mm [Rear]	FCC#2	N/A	1:1	0.563	1.114	<b>0.627</b>
	1907.6	9538	WCDMA1900	RMC	23.0	22.66	0.16	10mm [Front]	FCC#1	N/A	1:1	0.799	1.081	0.864
	1880.0	9400	WCDMA1900	RMC	23.0	22.63	0.01	10mm [Front]	FCC#1	N/A	1:1	0.875	1.089	0.953
	1907.6	9538	WCDMA1900	RMC	23.0	22.75	0.03	10mm [Front]	FCC#1	N/A	1:1	0.814	1.059	0.862
	1907.6	9538	WCDMA1900	RMC	23.0	22.66	0.09	10mm [Rear]	FCC#2	N/A	1:1	1.33	1.081	1.44
20	1880.0	9400	WCDMA1900	RMC	23.0	22.63	-0.06	10mm [Rear]	FCC#2	N/A	1:1	1.41	1.089	<b>1.54</b>
	1907.6	9538	WCDMA1900	RMC	23.0	22.75	0.09	10mm [Rear]	FCC#2	N/A	1:1	1.28	1.059	1.36
ANSI / IEEE C95.1-2005– SAFETY LIMIT Spatial Peak Uncontrolled Exposure/General Population Exposure								Head 1.6 W/kg(mW/g) averaged over 1 gram						

Table 12.9 GSM/PCS/WCDMA Body-Worn SAR

Note: Yellow entries represent measurements with connected earphone cable.



MEASUREMENT RESULTS															
Plot No.	Frequency		Band	Modulation / Band width [MHz]	Maximum Allowed Power [dBm]	Conducted Power [dBm]	Drift Power [dB]	Phantom Position	Device Serial Number	RB Size	RB Offset	Dyty Cycle	1g SAR [W/kg]	Scaling Factor	1g Scaled SAR [W/kg]
	MHz	Ch													
	710.0	23790	LTE Band 17	QPSK, 10M	24.5	23.95	-0.08	10mm [Front]	FCC#2	1	0	1:1	0.132	1.135	0.150
	710.0	23790	LTE Band 17	QPSK, 10M	24.5	23.95	-0.07	10mm [Rear]	FCC#2	1	0	1:1	0.241	1.135	0.274
	709.0	23780	LTE Band 17	QPSK, 10M	24.5	22.91	-0.07	10mm [Front]	FCC#1	25	0	1:1	0.107	1.442	0.154
21	709.0	23780	LTE Band 17	QPSK, 10M	24.5	22.91	0.12	10mm [Rear]	FCC#1	25	0	1:1	0.201	1.442	<b>0.290</b>
<b>ANSI / IEEE C95.1-2005– SAFETY LIMIT</b> <b>Spatial Peak</b> <b>Uncontrolled Exposure/General Population Exposure</b>								Body 1.6 W/kg(mW/g) averaged over 1 gram							

Table 12.10 LTE Band 17 Body-Worn SAR

MEASUREMENT RESULTS														
Plot No.	Frequency		Mode/ Band	Service	Maximum Allowed Power [dBm]	Conducted Power [dBm]	Drift Power [dB]	Spacing [Side]	Device Serial Number	Data Rate [Mbps]	Dyty Cycle	1g SAR [W/kg]	Scaling Factor	1g Scaled SAR [W/kg]
	MHz	Ch												
22	2462	11	802.11b	DSSS	16.9	16.07	0.10	10mm [Front]	FCC#1	1	1:1	0.152	1.211	<b>0.184</b>
	2462	11	802.11b	DSSS	16.9	16.07	0.20	10mm [Rear]	FCC#1	1	1:1	0.105	1.211	0.127
<b>ANSI / IEEE C95.1-2005– SAFETY LIMIT</b> <b>Spatial Peak</b> <b>Uncontrolled Exposure/General Population Exposure</b>								Body 1.6 W/kg(mW/g) averaged over 1 gram						

Table 12.11 DTS Body-Worn SAR



Zacta

MEASUREMENT RESULTS														
Plot No.	Frequency		Mode/ Band	Service	Maximum Allowed Power [dBm]	Conducted Power [dBm]	Drift Power [dB]	Spacing [Side]	Device Serial Number	Data Rate [Mbps]	Dydy Cycle	1g SAR [W/kg]	Scaling Factor	1g Scaled SAR [W/kg]
	MHz	Ch												
	5180	36	802.11a	OFDM	13.0	12.69	0.00	10mm [Front]	FCC#2	6	1:1	0.0491	1.074	0.0527
	5180	36	802.11a	OFDM	13.0	12.69	0.00	10mm [Rear]	FCC#2	6	1:1	0.0714	1.074	0.0767
23	5210	42	802.11ac	OFDM	13.0	12.59	-0.01	10mm [Rear]	FCC#1	29.3	1:1	0.120	1.099	<b>0.132</b>
	5320	64	802.11a	OFDM	13.0	12.78	0.00	10mm [Front]	FCC#2	6	1:1	0.0459	1.052	0.0483
	5320	64	802.11a	OFDM	13.0	12.78	0.00	10mm [Rear]	FCC#2	6	1:1	0.0862	1.052	0.0907
24	5290	58	802.11ac	OFDM	13.0	12.55	0.17	10mm [Rear]	FCC#1	29.3	1:1	0.106	1.109	<b>0.118</b>
	5700	140	802.11a	OFDM	13.0	12.94	0.00	10mm [Front]	FCC#2	6	1:1	0.102	1.014	0.103
	5700	140	802.11a	OFDM	13.0	12.94	0.00	10mm [Rear]	FCC#2	6	1:1	0.156	1.014	0.158
25	5530	106	802.11ac	OFDM	13.0	12.57	-0.05	10mm [Rear]	FCC#2	29.3	1:1	0.185	1.104	<b>0.204</b>
ANSI / IEEE C95.1-2005– SAFETY LIMIT Spatial Peak Uncontrolled Exposure/General Population Exposure								Body 1.6 W/kg(mW/g) averaged over 1 gram						

Table 12.12 NII Body-Worn SAR

MEASUREMENT RESULTS														
Plot No.	Frequency		Mode/ Band	Service	Maximum Allowed Power [dBm]	Conducted Power [dBm]	Drift Power [dB]	Spacing [Side]	Device Serial Number	Data Rate [Mbps]	Dyuty Cycle	1g SAR [W/kg]	Scaling Factor	1g Scaled SAR [W/kg]
	MHz	Ch												
	5180	36	802.11n	OFDM	13.0	12.82	0.18	10mm [Front]	FCC#1	6.5	1:1	0.0729	1.042	0.0760
	5180	36	802.11n	OFDM	13.0	12.82	0.01	10mm [Rear]	FCC#1	6.5	1:1	0.122	1.042	0.127
23	5210	42	802.11ac	OFDM	13.0	12.59	-0.01	10mm [Rear]	FCC#1	29.3	1:1	0.120	1.099	<b>0.132</b>
	5320	64	802.11n	OFDM	13.0	12.91	0.17	10mm [Front]	FCC#1	6.5	1:1	0.0739	1.021	0.0754
	5320	64	802.11n	OFDM	13.0	12.91	0.17	10mm [Rear]	FCC#1	6.5	1:1	0.115	1.021	0.117
24	5290	58	802.11ac	OFDM	13.0	12.55	0.17	10mm [Rear]	FCC#1	29.3	1:1	0.106	1.109	<b>0.118</b>
	5700	140	802.11n	OFDM	13.0	12.96	-0.13	10mm [Front]	FCC#2	6.5	1:1	0.140	1.009	0.141
	5700	140	802.11n	OFDM	13.0	12.96	-0.10	10mm [Rear]	FCC#2	6.5	1:1	0.197	1.009	0.199
25	5530	106	802.11ac	OFDM	13.0	12.57	-0.05	10mm [Rear]	FCC#2	29.3	1:1	0.185	1.104	<b>0.204</b>
ANSI / IEEE C95.1-2005– SAFETY LIMIT Spatial Peak Uncontrolled Exposure/General Population Exposure								Body 1.6 W/kg(mW/g) averaged over 1 gram						

Table 12.13 NII Body-Worn SAR

### 12.3 Standalone Wireless router SAR Results

MEASUREMENT RESULTS														
Plot No.	Frequency		Mode/ Band	Service	Maximum Allowed Power [dBm]	Conducted Power [dBm]	Drift Power [dB]	Spacing [Side]	Device Serial Number	# of Time slots	Dyty Cycle	1g SAR [W/kg]	Scaling Factor	1g Scaled SAR [W/kg]
	MHz	Ch												
	836.6	190	GSM850	GPRS	29.5	29.21	-0.20	10mm [Bottom]	FCC#1	4	1: 2.1	0.169	1.069	0.181
	824.2	128	GSM850	GPRS	29.5	29.18	-0.05	10mm [Front]	FCC#1	4	1: 2.1	1.31	1.076	1.41
	836.6	190	GSM850	GPRS	29.5	29.21	-0.15	10mm [Front]	FCC#1	4	1: 2.1	1.14	1.069	1.22
	848.8	251	GSM850	GPRS	29.5	28.82	0.04	10mm [Front]	FCC#1	4	1: 2.1	1.04	1.169	1.22
	836.6	190	GSM850	GPRS	33.0	32.66	-0.10	10mm [Rear]	FCC#1	1	1: 8.3	0.537	1.081	0.581
	824.2	128	GSM850	GPRS	32.5	31.98	-0.02	10mm [Rear]	FCC#1	2	1: 4.2	1.08	1.127	1.22
	836.6	190	GSM850	GPRS	32.5	31.95	-0.07	10mm [Rear]	FCC#1	2	1: 4.2	1.00	1.135	1.14
	848.8	251	GSM850	GPRS	32.5	31.88	-0.06	10mm [Rear]	FCC#1	2	1: 4.2	0.898	1.153	1.04
	824.2	128	GSM850	GPRS	30.0	29.84	0.00	10mm [Rear]	FCC#1	3	1: 2.8	1.18	1.038	1.22
	836.6	190	GSM850	GPRS	30.0	29.79	-0.03	10mm [Rear]	FCC#1	3	1: 2.8	1.16	1.050	1.22
	848.8	251	GSM850	GPRS	30.0	29.73	-0.03	10mm [Rear]	FCC#1	3	1: 2.8	0.96	1.064	1.02
16	824.2	128	GSM850	GPRS	29.5	29.18	0.20	10mm [Rear]	FCC#1	4	1: 2.1	1.46	1.076	<b>1.57</b>
	836.6	190	GSM850	GPRS	29.5	29.21	0.03	10mm [Rear]	FCC#1	4	1: 2.1	1.33	1.069	1.42
	848.8	251	GSM850	GPRS	29.5	28.82	-0.08	10mm [Rear]	FCC#1	4	1: 2.1	1.05	1.169	1.23
	824.2	128	GSM850	GPRS	29.5	29.18	0.20	10mm [Right]	FCC#2	4	1: 2.1	1.060	1.076	1.14
	836.6	190	GSM850	GPRS	29.5	29.21	-0.13	10mm [Right]	FCC#1	4	1: 2.1	1.220	1.069	1.30
	848.8	251	GSM850	GPRS	29.5	28.82	-0.04	10mm [Right]	FCC#2	4	1: 2.1	0.838	1.169	0.980
	824.2	128	GSM850	GPRS	29.5	29.18	-0.04	10mm [Left]	FCC#2	4	1: 2.1	1.150	1.076	1.24
	836.6	190	GSM850	GPRS	29.5	29.21	0.02	10mm [Left]	FCC#2	4	1: 2.1	0.901	1.069	0.963
	848.8	251	GSM850	GPRS	29.5	28.82	0.00	10mm [Left]	FCC#2	4	1: 2.1	0.679	1.169	0.794
	824.2	128	GSM850	GPRS	29.5	29.18	-0.08	10mm [Rear]	FCC#1	4	1: 2.1	1.11	1.076	1.19
	824.2	128	GSM850	GPRS	29.5	29.18	-0.13	10mm [Rear]	FCC#1	4	1: 2.1	1.43	1.076	1.54
	824.2	128	GSM850	GPRS	29.5	29.18	-0.13	10mm [Rear]	FCC#1	4	1: 2.1	1.44	1.076	1.55
ANSI / IEEE C95.1-2005– SAFETY LIMIT Spatial Peak Uncontrolled Exposure/General Population Exposure								Body 1.6 W/kg(mW/g) averaged over 1 gram						

Table 12.14 GSM850 GPRS Hotspot SAR

Note: Yellow entries represent measurements with connected earphone cable. / Blue entries represent repeatability measurements.

MEASUREMENT RESULTS														
Plot No.	Frequency		Mode/ Band	Service	Maximum Allowed Power [dBm]	Conducted Power [dBm]	Drift Power [dB]	Spacing [Side]	Device Serial Number	# of Time slots	Dydy Cycle	1g SAR [W/kg]	Scaling Factor	1g Scaled SAR [W/kg]
	MHz	Ch												
	1880.0	661	PCS1900	GPRS	29.0	28.67	0.06	10mm [Bottom]	FCC#2	2	1: 4.2	0.468	1.079	0.505
	1880.0	661	PCS1900	GPRS	29.0	28.67	0.06	10mm [Front]	FCC#2	2	1: 4.2	0.215	1.079	0.232
	1880.0	661	PCS1900	GPRS	30.0	29.23	0.02	10mm [Rear]	FCC#2	1	1: 8.3	0.363	1.194	0.433
18	1880.0	661	PCS1900	GPRS	29.0	28.67	-0.20	10mm [Rear]	FCC#2	2	1: 4.2	0.578	1.079	<b>0.624</b>
	1880.0	661	PCS1900	GPRS	27.0	26.74	0.00	10mm [Rear]	FCC#2	3	1: 2.8	0.559	1.062	0.593
	1880.0	661	PCS1900	GPRS	26.0	25.64	0.11	10mm [Rear]	FCC#2	4	1: 2.1	0.508	1.086	0.552
	1880.0	661	PCS1900	GPRS	29.0	28.67	-0.06	10mm [Right]	FCC#2	2	1: 4.2	0.0482	1.079	0.052
	1880.0	661	PCS1900	GPRS	29.0	28.67	-0.06	10mm [Left]	FCC#2	2	1: 4.2	0.00851	1.079	0.0092
26	1880.0	661	PCS1900	GPRS	29.0	28.67	0.10	10mm [Rear]	FCC#2	2	1: 4.2	0.625	1.079	<b>0.674</b>
ANSI / IEEE C95.1-2005– SAFETY LIMIT Spatial Peak Uncontrolled Exposure/General Population Exposure								Body 1.6 W/kg(mW/g) averaged over 1 gram						

Table 12.15 PCS1900 GPRS Hotspot SAR

Note: Yellow entries represent measurements with connected earphone cable.

MEASUREMENT RESULTS														
Plot No.	Frequency		Mode/ Band	Service	Maximum Allowed Power [dBm]	Conducted Power [dBm]	Drift Power [dB]	Spacing [Side]	Device Serial Number	# of Time slots	Dyty Cycle	1g SAR [W/kg]	Scaling Factor	1g Scaled SAR [W/kg]
	MHz	Ch												
	836.6	4183	WCDMA850	RMC	24.0	23.53	0.07	10mm [Bottom]	FCC#2	N/A	1:1	0.0866	1.114	0.0965
	836.6	4183	WCDMA850	RMC	24.0	23.53	-0.17	10mm [Front]	FCC#2	N/A	1:1	0.461	1.114	0.514
19	836.6	4183	WCDMA850	RMC	24.0	23.53	0.01	10mm [Rear]	FCC#2	N/A	1:1	0.563	1.114	<b>0.627</b>
	836.6	4183	WCDMA850	RMC	24.0	23.53	0.08	10mm [Right]	FCC#2	N/A	1:1	0.284	1.114	0.316
	836.6	4183	WCDMA850	RMC	24.0	23.53	-0.04	10mm [Left]	FCC#2	N/A	1:1	0.252	1.114	0.281
	836.6	4183	WCDMA850	RMC	24.0	23.53	0.01	10mm [Rear]	FCC#2	N/A	1:1	0.447	1.114	0.498
	1852.4	9262	WCDMA1900	RMC	23.0	22.66	0.01	10mm [Bottom]	FCC#2	N/A	1:1	1.2	1.081	1.30
	1880.0	9400	WCDMA1900	RMC	23.0	22.63	0.16	10mm [Bottom]	FCC#2	N/A	1:1	1.24	1.089	1.35
	1907.6	9538	WCDMA1900	RMC	23.0	22.75	0.07	10mm [Bottom]	FCC#	N/A	1:1	1.41	1.059	1.49
	1852.4	9262	WCDMA1900	RMC	23.0	22.66	0.16	10mm [Front]	FCC#1	N/A	1:1	0.799	1.081	0.864
	1880.0	9400	WCDMA1900	RMC	23.0	22.63	0.01	10mm [Front]	FCC#1	N/A	1:1	0.875	1.089	0.953
	1907.6	9538	WCDMA1900	RMC	23.0	22.75	0.03	10mm [Front]	FCC#1	N/A	1:1	0.814	1.059	0.862
	1852.4	9262	WCDMA1900	RMC	23.0	22.66	0.09	10mm [Rear]	FCC#2	N/A	1:1	1.33	1.081	1.44
20	1880.0	9400	WCDMA1900	RMC	23.0	22.63	-0.06	10mm [Rear]	FCC#2	N/A	1:1	1.41	1.089	<b>1.54</b>
	1907.6	9538	WCDMA1900	RMC	23.0	22.75	0.09	10mm [Rear]	FCC#2	N/A	1:1	1.28	1.059	1.36
	1880.0	9400	WCDMA1900	RMC	23.0	22.63	-0.03	10mm [Right]	FCC#2	N/A	1:1	0.124	1.089	0.135
	1880.0	9400	WCDMA1900	RMC	23.0	22.63	-0.02	10mm [Left]	FCC#2	N/A	1:1	0.0631	1.089	0.0687
	1880.0	9400	WCDMA1900	RMC	23.0	22.63	0.17	10mm [Rear]	FCC#1	N/A	1:1	1.31	1.089	1.43
27	1880.0	9400	WCDMA1900	RMC	23.0	22.63	0.14	10mm [Rear]	FCC#1	N/A	1:1	1.41	1.089	1.54
ANSI / IEEE C95.1-2005– SAFETY LIMIT Spatial Peak Uncontrolled Exposure/General Population Exposure								Body 1.6 W/kg(mW/g) averaged over 1 gram						

Table 12.16 WCDMA Hotspot SAR

Note: Yellow entries represent measurements with connected earphone cable. / Blue entries represent repeatability measurements.

MEASUREMENT RESULTS															
Plot No.	Frequency		Band	Modulation / Band width [MHz]	Maximum Allowed Power [dBm]	Conducted Power [dBm]	Drift Power [dB]	Phantom Position	Device Serial Number	RB Size	RB Offset	Dydy Cycle	1g SAR [W/kg]	Scaling Factor	1g Scaled SAR [W/kg]
	MHz	Ch													
	710.0	23790	LTE Band 17	QPSK, 10M	24.5	23.95	0.17	10mm [Bottom]	FCC#2	1	0	1:1	0.0426	1.135	0.0484
	710.0	23790	LTE Band 17	QPSK, 10M	24.5	23.95	-0.08	10mm [Front]	FCC#2	1	0	1:1	0.132	1.135	0.150
	710.0	23790	LTE Band 17	QPSK, 10M	24.5	23.95	-0.07	10mm [Rear]	FCC#2	1	0	1:1	0.241	1.135	0.274
	710.0	23790	LTE Band 17	QPSK, 10M	24.5	23.95	0.06	10mm [Right]	FCC#2	1	0	1:1	0.118	1.135	0.134
	710.0	23790	LTE Band 17	QPSK, 10M	24.5	23.95	0.06	10mm [Left]	FCC#2	1	0	1:1	0.0735	1.135	0.0834
	709.0	23780	LTE Band 17	QPSK, 10M	24.5	22.91	0.13	10mm [Bottom]	FCC#1	25	0	1:1	0.0323	1.442	0.0466
	709.0	23780	LTE Band 17	QPSK, 10M	24.5	22.91	-0.07	10mm [Front]	FCC#1	25	0	1:1	0.107	1.442	0.154
21	709.0	23780	LTE Band 17	QPSK, 10M	24.5	22.91	0.12	10mm [Rear]	FCC#1	25	0	1:1	0.201	1.442	<b>0.290</b>
	709.0	23780	LTE Band 17	QPSK, 10M	24.5	22.91	0.04	10mm [Right]	FCC#1	25	0	1:1	0.0975	1.442	0.141
	709.0	23780	LTE Band 17	QPSK, 10M	24.5	22.91	0.10	10mm [Left]	FCC#1	25	0	1:1	0.0577	1.442	0.0832
ANSI / IEEE C95.1-2005– SAFETY LIMIT Spatial Peak Uncontrolled Exposure/General Population Exposure								Body 1.6 W/kg(mW/g) averaged over 1 gram							

Table 12.17 LTE Band 17 Hotspot SAR



Zacta

MEASUREMENT RESULTS														
Plot No.	Frequency		Mode/ Band	Service	Maximum Allowed Power [dBm]	Conducted Power [dBm]	Drift Power [dB]	Spacing [Side]	Device Serial Number	Data Rate [Mbps]	Duty Cycle	1g SAR [W/kg]	Scaling Factor	1g Scaled SAR [W/kg]
	MHz	Ch												
	2462	11	802.11b	DSSS	16.9	16.07	0.04	10mm [Top]	FCC#1	1	1:1	0.0635	1.211	0.0769
22	2462	11	802.11b	DSSS	16.9	16.07	0.10	10mm [Front]	FCC#1	1	1:1	0.152	1.211	<b>0.184</b>
	2462	11	802.11b	DSSS	16.9	16.07	0.20	10mm [Rear]	FCC#1	1	1:1	0.105	1.211	0.127
ANSI / IEEE C95.1-2005– SAFETY LIMIT Spatial Peak Uncontrolled Exposure/General Population Exposure								Body 1.6 W/kg(mW/g) averaged over 1 gram						

Table 12.18 WLAN Hotspot SAR



## 12.4 SAR Test Notes

### General Notes:

1. The test data reported are the worst-case SAR values according to test procedures specified in IEEE 1528-2003, FCC/OET Bulletin 65, Supplement C [June 2001] and FCC KDB Publication 447498 D01v05r02.
2. Batteries are fully charged at the beginning of the SAR measurements. A standard battery was used for all SAR measurements.
3. Liquid tissue depth was at least 15.0 cm for all frequencies.
4. The manufacturer has confirmed that the device(s) tested have the same physical, mechanical and thermal characteristics and are within operational tolerances expected for production units.
5. SAR results were scaled to the maximum allowed power to demonstrate compliance per FCC KDB Publication 447498 D01v05r02.
6. Device was tested using a fixed spacing for body-worn accessory testing. A separation distance of 10 mm was considered because the manufacturer has determined that there will be body-worn accessories available in the marketplace for users to support this separation distance.
7. Per FCC KDB Publication 648474 D04v01r01, SAR was evaluated without a headset connected to the device. Since the standalone reported SAR was  $\leq 1.2$  W/kg, no additional SAR evaluations using a headset cable were required.
8. During SAR Testing for the Wireless Router conditions per FCC KDB Publication 941225 D06 v02, the actual Portable Hotspot operation (with actual simultaneous transmission of a transmitter with WIFI) was not activated (See Section 6.7 for more details).
9. Per FCC KDB 865664 D01v01r03, variability SAR tests were performed when the measured SAR results for a frequency band were greater than 0.8 W/kg. Repeated SAR measurements are highlighted in the tables above for clarity. Please see Section 14 for variability analysis.

### GSM Notes:

1. This device supports GSM VOIP in the head and body-worn configurations, therefore GPRS was additionally evaluated for head and body-worn compliance.
2. Body-Worn accessory testing is typically associated with voice operations. Therefore, GSM voice was evaluated for body-worn SAR.
3. Per FCC KDB Publication 447498 D01v05r02, if the reported (scaled) SAR measured at the middle channel or highest output power channel for each test configuration is  $\leq 0.8$  W/kg then testing at the other channels is not required for such test configuration(s). When the maximum output power variation across the required test channels is  $> \frac{1}{2}$  dB, instead of the middle channel, the highest output power channel was used.

### WCDMA Notes:

1. WCDMA mode was tested under RMC 12.2 kbps with HSPA Inactive per KDB Publication 941225 D01 v03.
2. Body SAR for HSPA is not required for handsets with HSDPA capabilities when the maximum average output power of each RF channel with HSPA active is less than 0.25 dB higher than that measured without HSPA using 12.2 kbps RMC and the maximum SAR for 12.2 kbps RMC is  $\leq 75\%$  of the SAR limit.
3. Per FCC KDB Publication 447498 D01v05r02, if the reported (scaled) SAR measured at the middle channel or highest output power channel for each test configuration is  $\leq 0.8$  W/kg then testing at the other channels is not required for such test configuration(s). When the maximum output power variation across the required test channels is  $> \frac{1}{2}$  dB, instead of the middle channel, the highest output power channel was used.

**WLAN Notes:**

1. Justification for reduced test configurations for WIFI channels per KDB Publication 248227 D01v01r02 and October 2012 FCC/TCB Meeting Notes for 2.4 GHz WIFI: Highest average RF output power channel for the lowest data rate was selected for SAR evaluation in 802.11b. Other IEEE 802.11 modes (including 802.11g/n) were not investigated since the average output powers over all channels and data rates were not more than 0.25 dB higher than the tested channel in the lowest data rate of IEEE 802.11b mode.
2. Justification for reduced test configurations for WIFI channels per KDB Publication 248227 D01v01r02 and October 2012 FCC/TCB Meeting Notes for 5 GHz WIFI: Highest average RF output power channel for the lowest data rate was selected for SAR evaluation in 802.11a. Other IEEE 802.11 modes (including 802.11n 20 MHz and 40 MHz bandwidths) were not investigated since the average output powers over all channels and data rates were not more than 0.25 dB higher than the tested channel in the lowest data rate of IEEE 802.11a mode.
3. Per April 2013 TCB Workshop notes, full SAR tests for all IEEE 802.11ac configurations were not required because the average output power was not more than 0.25 dB higher than IEEE 802.11a mode. IEEE 802.11ac was evaluated for the highest IEEE 802.11a position in each 5 GHz band and exposure condition.
4. When Hotspot is enabled, all 5 GHz bands are disabled. Therefore no 5 GHz WIFI Wireless Router SAR Data was required.
5. 5 GHz WIFI Direct GO is not supported in the 5 GHz band for this device. WIFI Direct GO is supported in the 2.4 GHz band only. The manufacturer expects 2.4 GHz WIFI Direct GO may be used in a similar manner to wireless router usage. Therefore, 2.4 GHz WIFI Direct GO was evaluated for SAR similarly to wireless router SAR procedures in FCC KDB Publication 941225.
6. WIFI transmission was verified using a spectrum analyzer.
7. Since the maximum extrapolated peak SAR of the zoom scan for the maximum output channel is <math><1.6\text{ W/kg}</math> and the reported 1g averaged SAR is <math><0.8\text{ W/kg}</math>, SAR testing on other default channels was not required.

## 13. FCC Multi-TX and Antenna SAR Considerations

### 13.1 Introduction

The following procedures adopted from FCC KDB Publication 447498 D01v05r02 are applicable to handsets with built-in unlicensed transmitters such as 802.11a/b/g/n/ac and Bluetooth devices which may simultaneously transmit with the licensed transmitter.

### 13.2 Simultaneous Transmission Procedures

This device contains transmitters that may operate simultaneously. Therefore simultaneous transmission analysis is required. Per FCC KDB 447498 D01v05r02 IV.C.1.iii, simultaneous transmission SAR test exclusion may be applied when the sum of the 1-g SAR for all the simultaneous transmitting antennas in a specific a physical test configuration is  $\leq 1.6$  W/kg. When standalone SAR is not required to be measured, per FCC KDB 447498 D01v05r02 4.3.2 2), the following equation must be used to estimate the standalone 1g SAR for simultaneous transmission assessment involving that transmitter.

$$\text{Estimated SAR} = \frac{\text{Max. Tune up Power}_{(mW)}}{\text{Min. Test Separation Distance}_{(mm)}} \times \frac{\sqrt{f_{(GHz)}}}{7.5}$$

Table 13.1 Estimated SAR

Mode	Frequency	Maximum Allowed Power		Separation Distance (Body)	Estimated SAR (Body)
	MHz	[dBm]	[mW]	[mm]	[W/kg]
Bluetooth	2402	7.9	6.17	10	0.128

Note : Held-to ear configurations are not applicable to Bluetooth operations and therefore were not considered for simultaneous transmission. Per KDB Publication 447498 D01v05r02, the maximum power of the channel was rounded to the nearest mW before calculation.

### 13.3 Simultaneous Transmission Capabilities

According to FCC KDB Publication 447498 D01v05r02, transmitters are considered to be transmitting simultaneously when there is overlapping transmission, with the exception of transmissions during network hand-offs with maximum hand-off duration less than 30 seconds. Possible transmission paths for the DUT are shown in Figure 13.1 and are color-coded to indicate communication modes which share the same path. Modes which share the same transmission path cannot transmit simultaneously with one another.



Figure 13.1 Simultaneous Transmission Paths

This device contains multiple transmitters that may operate simultaneously, and therefore requires a simultaneous transmission analysis according to FCC KDB Publication 447498 D01v05r02 3) procedures.

### 13.4 Simultaneous Transmission SAR Analysis

KDB 447498 D01 General RF Exposure Guidance v05, introduces a new formula for calculating the SAR to Peak Location Ratio (SPLSR) between pairs of simultaneously transmitting antennas:

$$SPLSR = (SAR_1 + SAR_2)^{1.5} / Ri$$

Where:

**SAR1** is the highest measured or estimated SAR for the first of a pair of simultaneous transmitting antennas, in a specific test operating mode and exposure condition

**SAR2** is the highest measured or estimated SAR for the second of a pair of simultaneous transmitting antennas, in the same test operating mode and exposure condition as the first

**Ri** is the separation distance between the pair of simultaneous transmitting antennas. When the SAR is measured, for both antennas in the pair, it is determined by the actual x, y and z coordinates in the 1-g SAR for each SAR peak location, based on the extrapolated and interpolated result in the zoom scan measurement, using the formula of

$$[(x_1 - x_2)^2 + (y_1 - y_2)^2 + (z_1 - z_2)^2]$$

A new threshold of 0.04 is also introduced in the draft KDB. Thus, in order for a pair of simultaneous transmitting antennas with the sum of 1-g SAR > 1.6 W/kg to qualify for exemption from Simultaneous Transmission SAR measurements, it has to satisfy the condition of:

$$(SAR_1 + SAR_2)^{1.5} / Ri < 0.04$$

Table 13.2 Simultaneous Transmission Scenarios

Ref.	Simultaneous Transmit Configurations	Head	Body-Worn Accessory	Hot Spot	Note
		IEEE1528 Supp C	Supplement C	FCC KDB 941225 D06 Edges/sides	
1	GSM850 Voice + 2.4GHz WIFI	Yes	Yes	N/A	
2	PCS1900 Voice + 2.4GHz WIFI	Yes	Yes	N/A	
3	WCDMA850 Voice + 2.4GHz WIFI	Yes	Yes	Yes	
4	WCDMA1900 Voice + 2.4GHz WIFI	Yes	Yes	Yes	
5	LTE Band 17 Data + 2.4GHz WIFI	Yes	Yes	Yes	
6	GSM850 Voice + 5GHz WIFI	Yes	Yes	N/A	
7	PCS1900 Voice + 5GHz WIFI	Yes	Yes	N/A	
8	WCDMA850 Voice + 5GHz WIFI	Yes	Yes	N/A	
9	WCDMA1900 Voice + 5GHz WIFI	Yes	Yes	N/A	
10	LTE Band 17 Data + 5GHz WIFI	Yes	Yes	N/A	
11	GSM850 GPRS + 2.4GHz WIFI	Yes	Yes	Yes	
12	GPRS1900 GPRS + 2.4GHz WIFI	Yes	Yes	Yes	
13	GSM850 GPRS + 5GHz WIFI	Yes	Yes	N/A	
14	GPRS1900 GPRS + 5GHz WIFI	Yes	Yes	N/A	
15	GSM850 Voice + Bluetooth	N/A	Yes	N/A	
16	PCS1900 Voice + Bluetooth	N/A	Yes	N/A	
17	WCDMA850 + Bluetooth	N/A	Yes	N/A	
18	WCDMA1900 + Bluetooth	N/A	Yes	N/A	
19	LTE Band 17 Data + Bluetooth	N/A	Yes	N/A	

## Notes:

- 2.4 GHz WIFI is supported Hotspot and WIFI-Direct.
- 5 GHz WIFI is not supported Hotspot and not supported WIFI-Direct.
- WCDMA, GPRS is supported Hotspot.
- Bluetooth and WIFI cannot transmit simultaneously since they share the same chip.
- GSM and WCDMA cannot transmit simultaneously since they share the same chip.
- VoIP is supported in WCDMA, GSM.

Per the manufacturer, WIFI Direct is expected to be used in conjunction with a held-to-ear or body-worn accessory voice call. Simultaneous transmission scenarios involving WIFI Direct are specified above.

### 13.5 Head SAR Simultaneous Transmission Analysis

Simult TX	Configuration	GSM850	2.4G W-LAN	$\Sigma$ SAR	SPLSR	Simult TX	Configuration	PCS1900	2.4G W-LAN	$\Sigma$ SAR	SPLSR
		SAR [W/kg]	(802.11b) SAR [W/kg]					[W/kg]	[Yes/No]		
Head SAR	Left Touch	0.372	0.0209	0.393	No	Head SAR	Left Touch	0.0819	0.0209	0.103	No
	Right Touch	0.401	0.00857	0.410	No		Right Touch	0.156	0.00857	0.164	No
	Left Tilt	0.258	0.0123	0.270	No		Left Tilt	0.0340	0.0123	0.0463	No
	Right Tilt	0.260	0.00605	0.266	No		Right Tilt	0.0275	0.00605	0.0336	No

**Table 13.3 Simultaneous Transmission Scenario with 2.4 GHz W-LAN (Held to Ear)**

Simult TX	Configuration	GPRS	2.4G W-LAN	$\Sigma$ SAR	SPLSR	Simult TX	Configuration	GPRS	2.4G W-LAN	$\Sigma$ SAR	SPLSR
		850 SAR [W/kg]	(802.11b) SAR [W/kg]					[W/kg]	[Yes/No]		
Head SAR	Left Touch	0.943	0.0209	0.964	No	Head SAR	Left Touch	0.123	0.0209	0.144	No
	Right Touch	0.986	0.00857	0.994	No		Right Touch	0.242	0.00857	0.250	No
	Left Tilt	0.600	0.0123	0.612	No		Left Tilt	0.0462	0.0123	0.0585	No
	Right Tilt	0.622	0.00605	0.628	No		Right Tilt	0.0432	0.00605	0.0492	No

**Table 13.4 Simultaneous Transmission Scenario with 2.4 GHz W-LAN (Held to Ear)**

Simult TX	Configuration	WCDMA	2.4G W-LAN	$\Sigma$ SAR	SPLSR	Simult TX	Configuration	WCDMA	2.4G W-LAN	$\Sigma$ SAR	SPLSR
		850 SAR [W/kg]	(802.11b) SAR [W/kg]					[W/kg]	[Yes/No]		
Head SAR	Left Touch	0.296	0.0209	0.317	No	Head SAR	Left Touch	0.0937	0.0209	0.115	No
	Right Touch	0.345	0.00857	0.353	No		Right Touch	0.182	0.00857	0.190	No
	Left Tilt	0.0915	0.0123	0.104	No		Left Tilt	0.0480	0.0123	0.0603	No
	Right Tilt	0.0816	0.00605	0.0877	No		Right Tilt	0.0372	0.00605	0.0433	No

**Table 13.5 Simultaneous Transmission Scenario with 2.4 GHz W-LAN (Held to Ear)**

Simult TX	Configuration	LTE	2.4G W-LAN	$\Sigma$ SAR	SPLSR
		Band17 SAR [W/kg]	(802.11b) SAR [W/kg]		
Head SAR	Left Touch	0.136	0.0209	0.157	No
	Right Touch	0.154	0.00857	0.163	No
	Left Tilt	0.0646	0.0123	0.0769	No
	Right Tilt	0.0641	0.00605	0.0702	No

**Table 13.6 Simultaneous Transmission Scenario with 2.4 GHz W-LAN (Held to Ear)**

Simult TX	Configuration	GSM850 SAR [W/kg]	5.2G W-LAN (802.11a) SAR [W/kg]	$\Sigma$ SAR [W/kg]	SPLSR [Yes/No]	Simult TX	Configuration	PCS1900 SAR [W/kg]	5.2G W-LAN (802.11a) SAR [W/kg]	$\Sigma$ SAR [W/kg]	SPLSR [Yes/No]
Head	Left Touch	0.372	0.311	0.684	No	Head	Left Touch	0.0819	0.311	0.393	No
	Right Touch	0.401	0.323	0.725	No		Right Touch	0.156	0.323	0.479	No
SAR	Left Tilt	0.258	0.392	0.650	No	SAR	Left Tilt	0.0340	0.392	0.426	No
	Right Tilt	0.260	0.373	0.633	No		Right Tilt	0.0275	0.373	0.400	No

Table 13.7 Simultaneous Transmission Scenario with 5 GHz W-LAN (Held to Ear)

Simult TX	Configuration	GPRS 850 SAR [W/kg]	5.2G W-LAN (802.11a) SAR [W/kg]	$\Sigma$ SAR [W/kg]	SPLSR [Yes/No]	Simult TX	Configuration	GPRS 1900 SAR [W/kg]	5.2G W-LAN (802.11a) SAR [W/kg]	$\Sigma$ SAR [W/kg]	SPLSR [Yes/No]
Head	Left Touch	0.943	0.311	1.254	No	Head	Left Touch	0.123	0.311	0.434	No
	Right Touch	0.986	0.323	1.309	No		Right Touch	0.242	0.323	0.565	No
SAR	Left Tilt	0.600	0.392	0.992	No	SAR	Left Tilt	0.0462	0.392	0.439	No
	Right Tilt	0.622	0.373	0.995	No		Right Tilt	0.0432	0.373	0.416	No

Table 13.8 Simultaneous Transmission Scenario with 5 GHz W-LAN (Held to Ear)

Simult TX	Configuration	WCDMA 850 SAR [W/kg]	5.2G W-LAN (802.11a) SAR [W/kg]	$\Sigma$ SAR [W/kg]	SPLSR [Yes/No]	Simult TX	Configuration	WCDMA 1900 SAR [W/kg]	5.2G W-LAN (802.11a) SAR [W/kg]	$\Sigma$ SAR [W/kg]	SPLSR [Yes/No]
Head	Left Touch	0.296	0.311	0.607	No	Head	Left Touch	0.094	0.311	0.405	No
	Right Touch	0.345	0.323	0.668	No		Right Touch	0.182	0.323	0.505	No
SAR	Left Tilt	0.0915	0.392	0.484	No	SAR	Left Tilt	0.0480	0.392	0.440	No
	Right Tilt	0.0816	0.373	0.454	No		Right Tilt	0.0372	0.373	0.410	No

Table 13.9 Simultaneous Transmission Scenario with 5 GHz W-LAN (Held to Ear)

Simult TX	Configuration	LTE Band17 SAR [W/kg]	5.2G W-LAN (802.11a) SAR [W/kg]	$\Sigma$ SAR [W/kg]	SPLSR [Yes/No]
Head	Left Touch	0.136	0.311	0.448	No
	Right Touch	0.154	0.323	0.478	No
SAR	Left Tilt	0.0646	0.392	0.457	No
	Right Tilt	0.0641	0.373	0.437	No

Table 13.10 Simultaneous Transmission Scenario with 5 GHz W-LAN (Held to Ear)

Simult TX	Configuration	GSM850 SAR [W/kg]	5.3G W-LAN (802.11a) SAR [W/kg]	$\Sigma$ SAR [W/kg]	SPLSR [Yes/No]
Head	Left Touch	0.372	0.392	0.765	No
	Right Touch	0.401	0.401	0.802	No
SAR	Left Tilt	0.258	0.444	0.702	No
	Right Tilt	0.260	0.598	0.858	No

Simult TX	Configuration	PCS1900 SAR [W/kg]	5.3G W-LAN (802.11a) SAR [W/kg]	$\Sigma$ SAR [W/kg]	SPLSR [Yes/No]
Head	Left Touch	0.0819	0.392	0.474	No
	Right Touch	0.156	0.401	0.556	No
SAR	Left Tilt	0.0340	0.444	0.478	No
	Right Tilt	0.0275	0.598	0.625	No

**Table 13.11 Simultaneous Transmission Scenario with 5 GHz W-LAN (Held to Ear)**

Simult TX	Configuration	GPRS 850 SAR [W/kg]	5.3G W-LAN (802.11a) SAR [W/kg]	$\Sigma$ SAR [W/kg]	SPLSR [Yes/No]
Head	Left Touch	0.943	0.392	1.335	No
	Right Touch	0.986	0.401	1.386	No
SAR	Left Tilt	0.600	0.444	1.044	No
	Right Tilt	0.622	0.598	1.220	No

Simult TX	Configuration	GPRS 1900 SAR [W/kg]	5.3G W-LAN (802.11a) SAR [W/kg]	$\Sigma$ SAR [W/kg]	SPLSR [Yes/No]
Head	Left Touch	0.123	0.392	0.515	No
	Right Touch	0.242	0.401	0.642	No
SAR	Left Tilt	0.0462	0.444	0.490	No
	Right Tilt	0.0432	0.598	0.641	No

**Table 13.12 Simultaneous Transmission Scenario with 5 GHz W-LAN (Held to Ear)**

Simult TX	Configuration	WCDMA 850 SAR [W/kg]	5.3G W-LAN (802.11a) SAR [W/kg]	$\Sigma$ SAR [W/kg]	SPLSR [Yes/No]
Head	Left Touch	0.296	0.392	0.688	No
	Right Touch	0.345	0.401	0.746	No
SAR	Left Tilt	0.0915	0.444	0.535	No
	Right Tilt	0.0816	0.598	0.679	No

Simult TX	Configuration	WCDMA 1900 SAR [W/kg]	5.3G W-LAN (802.11a) SAR [W/kg]	$\Sigma$ SAR [W/kg]	SPLSR [Yes/No]
Head	Left Touch	0.0937	0.392	0.486	No
	Right Touch	0.182	0.401	0.583	No
SAR	Left Tilt	0.0480	0.444	0.492	No
	Right Tilt	0.0372	0.598	0.635	No

**Table 13.13 Simultaneous Transmission Scenario with 5 GHz W-LAN (Held to Ear)**

Simult TX	Configuration	LTE Band17 SAR [W/kg]	5.3G W-LAN (802.11a) SAR [W/kg]	$\Sigma$ SAR [W/kg]	SPLSR [Yes/No]
Head	Left Touch	0.136	0.392	0.529	No
	Right Touch	0.154	0.401	0.555	No
SAR	Left Tilt	0.0646	0.444	0.509	No
	Right Tilt	0.0641	0.598	0.662	No

**Table 13.14 Simultaneous Transmission Scenario with 5 GHz W-LAN (Held to Ear)**



Simult TX	Configuration	GSM850 SAR [W/kg]	5.5G W-LAN (802.11a) SAR [W/kg]	$\Sigma$ SAR [W/kg]	SPLSR [Yes/No]	Simult TX	Configuration	PCS1900 SAR [W/kg]	5.5G W-LAN (802.11a) SAR [W/kg]	$\Sigma$ SAR [W/kg]	SPLSR [Yes/No]
Head SAR	Left Touch	0.372	0.819	1.191	No	Head SAR	Left Touch	0.0819	0.819	0.901	No
	Right Touch	0.401	0.656	1.057	No		Right Touch	0.156	0.656	0.812	No
	Left Tilt	0.258	1.034	1.292	No		Left Tilt	0.0340	1.034	1.068	No
	Right Tilt	0.260	0.825	1.085	No		Right Tilt	0.0275	0.825	0.853	No

Table 13.15 Simultaneous Transmission Scenario with 5 GHz W-LAN (Held to Ear)

Simult TX	Configuration	GPRS 850 SAR [W/kg]	5.5G W-LAN (802.11a) SAR [W/kg]	$\Sigma$ SAR [W/kg]	SPLSR [Yes/No]	Simult TX	Configuration	GPRS 1900 SAR [W/kg]	5.5G W-LAN (802.11a) SAR [W/kg]	$\Sigma$ SAR [W/kg]	SPLSR [Yes/No]
Head SAR	Left Touch	0.943	0.819	1.762	Yes	Head SAR	Left Touch	0.123	0.819	0.942	No
	Right Touch	0.986	0.656	1.642	Yes		Right Touch	0.242	0.656	0.898	No
	Left Tilt	0.600	1.034	1.634	Yes		Left Tilt	0.0462	1.034	1.080	No
	Right Tilt	0.622	0.825	1.448	No		Right Tilt	0.0432	0.825	0.868	No

Table 13.16 Simultaneous Transmission Scenario with 5 GHz W-LAN (Held to Ear)

Simult TX	Configuration	WCDMA 850 SAR [W/kg]	5.5G W-LAN (802.11a) SAR [W/kg]	$\Sigma$ SAR [W/kg]	SPLSR [Yes/No]	Simult TX	Configuration	WCDMA 1900 SAR [W/kg]	5.5G W-LAN (802.11a) SAR [W/kg]	$\Sigma$ SAR [W/kg]	SPLSR [Yes/No]
Head SAR	Left Touch	0.296	0.819	1.115	No	Head SAR	Left Touch	0.0937	0.819	0.913	No
	Right Touch	0.345	0.656	1.001	No		Right Touch	0.182	0.656	0.838	No
	Left Tilt	0.0915	1.034	1.126	No		Left Tilt	0.0480	1.034	1.082	No
	Right Tilt	0.0816	0.825	0.907	No		Right Tilt	0.0372	0.825	0.863	No

Table 13.17 Simultaneous Transmission Scenario with 5 GHz W-LAN (Held to Ear)

Simult TX	Configuration	LTE Band17 SAR [W/kg]	5.5G W-LAN (802.11a) SAR [W/kg]	$\Sigma$ SAR [W/kg]	SPLSR [Yes/No]
Head SAR	Left Touch	0.136	0.819	0.955	No
	Right Touch	0.154	0.656	0.810	No
	Left Tilt	0.0646	1.034	1.099	No
	Right Tilt	0.0641	0.825	0.889	No

Table 13.18 Simultaneous Transmission Scenario with 5 GHz W-LAN (Held to Ear)

Simult TX	Configuration	GSM850 SAR [W/kg]	5.2G W-LAN (802.11n) SAR [W/kg]	$\Sigma$ SAR [W/kg]	SPLSR [Yes/No]
Head SAR	Left Touch	0.372	0.367	0.739	No
	Right Touch	0.401	0.443	0.844	No
	Left Tilt	0.258	0.404	0.662	No
	Right Tilt	0.260	0.531	0.791	No

Simult TX	Configuration	PCS1900 SAR [W/kg]	5.2G W-LAN (802.11n) SAR [W/kg]	$\Sigma$ SAR [W/kg]	SPLSR [Yes/No]
Head SAR	Left Touch	0.0819	0.367	0.449	No
	Right Touch	0.156	0.443	0.599	No
	Left Tilt	0.0340	0.404	0.438	No
	Right Tilt	0.0275	0.531	0.558	No

Table 13.19 Simultaneous Transmission Scenario with 5 GHz W-LAN (Held to Ear)

Simult TX	Configuration	GPRS 850 SAR [W/kg]	5.2G W-LAN (802.11n) SAR [W/kg]	$\Sigma$ SAR [W/kg]	SPLSR [Yes/No]
Head SAR	Left Touch	0.943	0.367	1.310	No
	Right Touch	0.986	0.443	1.429	No
	Left Tilt	0.600	0.404	1.004	No
	Right Tilt	0.622	0.531	1.153	No

Simult TX	Configuration	GPRS 1900 SAR [W/kg]	5.2G W-LAN (802.11n) SAR [W/kg]	$\Sigma$ SAR [W/kg]	SPLSR [Yes/No]
Head SAR	Left Touch	0.123	0.367	0.490	No
	Right Touch	0.242	0.443	0.685	No
	Left Tilt	0.0462	0.404	0.451	No
	Right Tilt	0.0432	0.531	0.574	No

Table 13.20 Simultaneous Transmission Scenario with 5 GHz W-LAN (Held to Ear)

Simult TX	Configuration	WCDMA 850 SAR [W/kg]	5.2G W-LAN (802.11n) SAR [W/kg]	$\Sigma$ SAR [W/kg]	SPLSR [Yes/No]
Head SAR	Left Touch	0.296	0.367	0.663	No
	Right Touch	0.345	0.443	0.788	No
	Left Tilt	0.0915	0.404	0.496	No
	Right Tilt	0.0816	0.531	0.612	No

Simult TX	Configuration	WCDMA 1900 SAR [W/kg]	5.2G W-LAN (802.11n) SAR [W/kg]	$\Sigma$ SAR [W/kg]	SPLSR [Yes/No]
Head SAR	Left Touch	0.0937	0.367	0.461	No
	Right Touch	0.182	0.443	0.625	No
	Left Tilt	0.0480	0.404	0.452	No
	Right Tilt	0.0372	0.531	0.568	No

Table 13.21 Simultaneous Transmission Scenario with 5 GHz W-LAN (Held to Ear)

Simult TX	Configuration	LTE Band17 SAR [W/kg]	5.2G W-LAN (802.11n) SAR [W/kg]	$\Sigma$ SAR [W/kg]	SPLSR [Yes/No]
Head SAR	Left Touch	0.136	0.367	0.503	No
	Right Touch	0.154	0.443	0.597	No
	Left Tilt	0.0646	0.404	0.469	No
	Right Tilt	0.0641	0.531	0.595	No

Table 13.22 Simultaneous Transmission Scenario with 5 GHz W-LAN (Held to Ear)

Simult TX	Configuration	GSM	5.3G W-LAN	$\Sigma$ SAR	SPLSR
		850 SAR [W/kg]	(802.11n) SAR [W/kg]		
Head SAR	Left Touch	0.372	0.412	0.785	No
	Right Touch	0.401	0.556	0.958	No
	Left Tilt	0.258	0.468	0.725	No
	Right Tilt	0.260	0.611	0.871	No

Simult TX	Configuration	PCS	5.3G W-LAN	$\Sigma$ SAR	SPLSR
		1900 SAR [W/kg]	(802.11n) SAR [W/kg]		
Head SAR	Left Touch	0.0819	0.412	0.494	No
	Right Touch	0.156	0.556	0.712	No
	Left Tilt	0.0340	0.468	0.502	No
	Right Tilt	0.0275	0.611	0.638	No

Table 13.23 Simultaneous Transmission Scenario with 5 GHz W-LAN (Held to Ear)

Simult TX	Configuration	GPRS	5.3G W-LAN	$\Sigma$ SAR	SPLSR
		850 SAR [W/kg]	(802.11n) SAR [W/kg]		
Head SAR	Left Touch	0.943	0.412	1.355	No
	Right Touch	0.986	0.556	<b>1.542</b>	No
	Left Tilt	0.600	0.468	1.067	No
	Right Tilt	0.622	0.611	1.233	No

Simult TX	Configuration	GPRS	5.3G W-LAN	$\Sigma$ SAR	SPLSR
		1900 SAR [W/kg]	(802.11n) SAR [W/kg]		
Head SAR	Left Touch	0.123	0.412	0.535	No
	Right Touch	0.242	0.556	0.798	No
	Left Tilt	0.0462	0.468	0.514	No
	Right Tilt	0.0432	0.611	0.654	No

Table 13.24 Simultaneous Transmission Scenario with 5 GHz W-LAN (Held to Ear)

Simult TX	Configuration	WCDMA	5.3G W-LAN	$\Sigma$ SAR	SPLSR
		850 SAR [W/kg]	(802.11n) SAR [W/kg]		
Head SAR	Left Touch	0.296	0.412	0.708	No
	Right Touch	0.345	0.556	0.901	No
	Left Tilt	0.0915	0.468	0.559	No
	Right Tilt	0.0816	0.611	0.692	No

Simult TX	Configuration	WCDMA	5.3G W-LAN	$\Sigma$ SAR	SPLSR
		1900 SAR [W/kg]	(802.11n) SAR [W/kg]		
Head SAR	Left Touch	0.0937	0.412	0.506	No
	Right Touch	0.182	0.556	0.738	No
	Left Tilt	0.0480	0.468	0.516	No
	Right Tilt	0.0372	0.611	0.648	No

Table 13.25 Simultaneous Transmission Scenario with 5 GHz W-LAN (Held to Ear)

Simult TX	Configuration	LTE	5.3G W-LAN	$\Sigma$ SAR	SPLSR
		Band17 SAR [W/kg]	(802.11n) SAR [W/kg]		
Head SAR	Left Touch	0.136	0.412	0.549	No
	Right Touch	0.154	0.556	0.711	No
	Left Tilt	0.0646	0.468	0.532	No
	Right Tilt	0.0641	0.611	0.675	No

Table 13.26 Simultaneous Transmission Scenario with 5 GHz W-LAN (Held to Ear)

Simult TX	Configuration	GSM850 SAR [W/kg]	5.5G W-LAN (802.11n) SAR [W/kg]	$\Sigma$ SAR [W/kg]	SPLSR [Yes/No]	Simult TX	Configuration	PCS1900 SAR [W/kg]	5.5G W-LAN (802.11n) SAR [W/kg]	$\Sigma$ SAR [W/kg]	SPLSR [Yes/No]
Head SAR	Left Touch	0.372	0.714	1.086	No	Head SAR	Left Touch	0.0819	0.714	0.795	No
	Right Touch	0.401	0.788	1.190	No		Right Touch	0.156	0.788	0.944	No
	Left Tilt	0.258	0.786	1.044	No		Left Tilt	0.0340	0.786	0.820	No
	Right Tilt	0.260	1.151	1.411	No		Right Tilt	0.0275	1.151	1.178	No

Table 13.27 Simultaneous Transmission Scenario with 5 GHz W-LAN (Held to Ear)

Simult TX	Configuration	GPRS 850 SAR [W/kg]	5.5G W-LAN (802.11n) SAR [W/kg]	$\Sigma$ SAR [W/kg]	SPLSR [Yes/No]	Simult TX	Configuration	GPRS 1900 SAR [W/kg]	5.5G W-LAN (802.11n) SAR [W/kg]	$\Sigma$ SAR [W/kg]	SPLSR [Yes/No]
Head SAR	Left Touch	0.943	0.714	1.656	Yes	Head SAR	Left Touch	0.123	0.714	0.837	No
	Right Touch	0.986	0.788	1.774	Yes		Right Touch	0.242	0.788	1.030	No
	Left Tilt	0.600	0.786	1.386	No		Left Tilt	0.0462	0.786	0.832	No
	Right Tilt	0.622	1.151	1.773	Yes		Right Tilt	0.0432	1.151	1.194	No

Table 13.28 Simultaneous Transmission Scenario with 5 GHz W-LAN (Held to Ear)

Simult TX	Configuration	WCDMA 850 SAR [W/kg]	5.5G W-LAN (802.11n) SAR [W/kg]	$\Sigma$ SAR [W/kg]	SPLSR [Yes/No]	Simult TX	Configuration	WCDMA 1900 SAR [W/kg]	5.5G W-LAN (802.11n) SAR [W/kg]	$\Sigma$ SAR [W/kg]	SPLSR [Yes/No]
Head SAR	Left Touch	0.296	0.714	1.009	No	Head SAR	Left Touch	0.0937	0.714	0.807	No
	Right Touch	0.345	0.788	1.133	No		Right Touch	0.182	0.788	0.970	No
	Left Tilt	0.0915	0.786	0.878	No		Left Tilt	0.0480	0.786	0.834	No
	Right Tilt	0.0816	1.151	1.232	No		Right Tilt	0.0372	1.151	1.188	No

Table 13.29 Simultaneous Transmission Scenario with 5 GHz W-LAN (Held to Ear)

Simult TX	Configuration	LTE Band17 SAR [W/kg]	5.5G W-LAN (802.11n) SAR [W/kg]	$\Sigma$ SAR [W/kg]	SPLSR [Yes/No]
Head SAR	Left Touch	0.136	0.714	0.850	No
	Right Touch	0.154	0.788	0.943	No
	Left Tilt	0.0646	0.786	0.851	No
	Right Tilt	0.0641	1.151	1.215	No

Table 13.30 Simultaneous Transmission Scenario with 5 GHz W-LAN (Held to Ear)

### 13.6 Body-Worn Simultaneous Transmission Analysis

Configuration	Mode	2G/3G SAR [W/kg]	2.4G W-LAN (802.11b) SAR [W/kg]	$\Sigma$ SAR [W/kg]	SPLSR [Yes/No]
Front Side	GSM 850	0.565	0.184	0.749	No
Rear Side	GSM 850	0.645	0.127	0.772	No
Front Side	GPRS 850	1.410	0.184	<b>1.594</b>	No
Rear Side	GPRS 850	1.572	0.127	1.699	Yes
Front Side	PCS 1900	0.152	0.184	0.336	No
Rear Side	PCS 1900	0.452	0.127	0.579	No
Front Side	GPRS 1900	0.232	0.184	0.416	No
Rear Side	GPRS 1900	0.674	0.127	0.801	No
Front Side	WCDMA 850	0.482	0.184	0.666	No
Rear Side	WCDMA 850	0.627	0.127	0.754	No
Front Side	WCDMA 1900	0.953	0.184	1.137	No
Rear Side	WCDMA 1900	1.535	0.127	1.663	Yes
Front Side	LTE Band 17	0.154	0.184	0.338	No
Rear Side	LTE Band 17	0.290	0.127	0.417	No

**Table 13.31 Simultaneous Transmission Scenario with 2.4 GHz W-LAN (Body-Worn at 10 mm)**

Configuration	Mode	2G/3G SAR [W/kg]	5.2G W-LAN (802.11a) SAR [W/kg]	$\Sigma$ SAR [W/kg]	SPLSR [Yes/No]
Front Side	GSM 850	0.565	0.0527	0.618	No
Rear Side	GSM 850	0.645	0.132	0.777	No
Front Side	GPRS 850	1.410	0.0527	1.463	No
Rear Side	GPRS 850	1.572	0.132	1.704	Yes
Front Side	PCS 1900	0.152	0.0527	0.205	No
Rear Side	PCS 1900	0.452	0.132	0.584	No
Front Side	GPRS 1900	0.232	0.0527	0.285	No
Rear Side	GPRS 1900	0.674	0.132	0.806	No
Front Side	WCDMA 850	0.482	0.0527	0.535	No
Rear Side	WCDMA 850	0.627	0.132	0.759	No
Front Side	WCDMA 1900	0.953	0.0527	1.006	No
Rear Side	WCDMA 1900	1.535	0.132	1.667	Yes
Front Side	LTE Band 17	0.154	0.0527	0.207	No
Rear Side	LTE Band 17	0.290	0.132	0.422	No

**Table 13.32 Simultaneous Transmission Scenario with 5 GHz W-LAN (Body-Worn at 10 mm)**

Configuration	Mode	2G/3G SAR [W/kg]	5.3G W-LAN (802.11a) SAR [W/kg]	$\Sigma$ SAR [W/kg]	SPLSR [Yes/No]
Front Side	GSM 850	0.565	0.0483	0.614	No
Rear Side	GSM 850	0.645	0.118	0.763	No
Front Side	GPRS 850	1.410	0.0483	1.458	No
Rear Side	GPRS 850	1.572	0.118	1.689	Yes
Front Side	PCS 1900	0.152	0.0483	0.200	No
Rear Side	PCS 1900	0.452	0.118	0.570	No
Front Side	GPRS 1900	0.232	0.0483	0.280	No
Rear Side	GPRS 1900	0.674	0.118	0.792	No
Front Side	WCDMA 850	0.482	0.0483	0.530	No
Rear Side	WCDMA 850	0.627	0.118	0.745	No
Front Side	WCDMA 1900	0.953	0.0483	1.001	No
Rear Side	WCDMA 1900	1.535	0.118	1.653	Yes
Front Side	LTE Band 17	0.154	0.0483	0.203	No
Rear Side	LTE Band 17	0.290	0.118	0.407	No

**Table 13.33 Simultaneous Transmission Scenario with 5 GHz W-LAN (Body-Worn at 10 mm)**

Configuration	Mode	2G/3G SAR [W/kg]	5.5G W-LAN (802.11a) SAR [W/kg]	$\Sigma$ SAR [W/kg]	SPLSR [Yes/No]
Front Side	GSM 850	0.565	0.103	0.669	No
Rear Side	GSM 850	0.645	0.204	0.849	No
Front Side	GPRS 850	1.410	0.103	1.514	No
Rear Side	GPRS 850	1.572	0.204	1.776	Yes
Front Side	PCS 1900	0.152	0.103	0.255	No
Rear Side	PCS 1900	0.452	0.204	0.656	No
Front Side	GPRS 1900	0.232	0.103	0.335	No
Rear Side	GPRS 1900	0.674	0.204	0.879	No
Front Side	WCDMA 850	0.482	0.103	0.585	No
Rear Side	WCDMA 850	0.627	0.204	0.832	No
Front Side	WCDMA 1900	0.953	0.103	1.056	No
Rear Side	WCDMA 1900	1.535	0.204	1.740	Yes
Front Side	LTE Band 17	0.154	0.103	0.258	No
Rear Side	LTE Band 17	0.290	0.204	0.494	No

**Table 13.34 Simultaneous Transmission Scenario with 5 GHz W-LAN (Body-Worn at 10 mm)**

Configuration	Mode	2G/3G SAR [W/kg]	5.2G W-LAN (802.11n) SAR [W/kg]	$\Sigma$ SAR [W/kg]	SPLSR [Yes/No]
Front Side	GSM 850	0.565	0.0760	0.641	No
Rear Side	GSM 850	0.645	0.132	0.777	No
Front Side	GPRS 850	1.410	0.0760	1.486	No
Rear Side	GPRS 850	1.572	0.132	1.704	Yes
Front Side	PCS 1900	0.152	0.0760	0.228	No
Rear Side	PCS 1900	0.452	0.132	0.584	No
Front Side	GPRS 1900	0.232	0.0760	0.308	No
Rear Side	GPRS 1900	0.674	0.132	0.806	No
Front Side	WCDMA 850	0.482	0.0760	0.558	No
Rear Side	WCDMA 850	0.627	0.132	0.759	No
Front Side	WCDMA 1900	0.953	0.0760	1.029	No
Rear Side	WCDMA 1900	1.535	0.132	1.667	Yes
Front Side	LTE Band 17	0.154	0.0760	0.230	No
Rear Side	LTE Band 17	0.290	0.132	0.422	No

**Table 13.35 Simultaneous Transmission Scenario with 5 GHz W-LAN (Body-Worn at 10 mm)**

Configuration	Mode	2G/3G SAR [W/kg]	5.3G W-LAN (802.11n) SAR [W/kg]	$\Sigma$ SAR [W/kg]	SPLSR [Yes/No]
Front Side	GSM 850	0.565	0.0754	0.641	No
Rear Side	GSM 850	0.645	0.118	0.763	No
Front Side	GPRS 850	1.410	0.0754	1.486	No
Rear Side	GPRS 850	1.572	0.118	1.689	Yes
Front Side	PCS 1900	0.152	0.0754	0.227	No
Rear Side	PCS 1900	0.452	0.118	0.570	No
Front Side	GPRS 1900	0.232	0.0754	0.307	No
Rear Side	GPRS 1900	0.674	0.118	0.792	No
Front Side	WCDMA 850	0.482	0.0754	0.557	No
Rear Side	WCDMA 850	0.627	0.118	0.745	No
Front Side	WCDMA 1900	0.953	0.0754	1.028	No
Rear Side	WCDMA 1900	1.535	0.118	1.653	Yes
Front Side	LTE Band 17	0.154	0.0754	0.230	No
Rear Side	LTE Band 17	0.290	0.118	0.407	No

**Table 13.36 Simultaneous Transmission Scenario with 5 GHz W-LAN (Body-Worn at 10 mm)**

Configuration	Mode	2G/3G SAR [W/kg]	5.5G W-LAN (802.11n) SAR [W/kg]	$\Sigma$ SAR [W/kg]	SPLSR [Yes/No]
Front Side	GSM 850	0.565	0.141	0.707	No
Rear Side	GSM 850	0.645	0.204	0.849	No
Front Side	GPRS 850	1.410	0.141	1.551	No
Rear Side	GPRS 850	1.572	0.204	1.776	Yes
Front Side	PCS 1900	0.152	0.141	0.293	No
Rear Side	PCS 1900	0.452	0.204	0.656	No
Front Side	GPRS 1900	0.232	0.141	0.373	No
Rear Side	GPRS 1900	0.674	0.204	0.879	No
Front Side	WCDMA 850	0.482	0.141	0.623	No
Rear Side	WCDMA 850	0.627	0.204	0.832	No
Front Side	WCDMA 1900	0.953	0.141	1.094	No
Rear Side	WCDMA 1900	1.535	0.204	1.740	Yes
Front Side	LTE Band 17	0.154	0.141	0.296	No
Rear Side	LTE Band 17	0.290	0.204	0.494	No

**Table 13.37 Simultaneous Transmission Scenario with 5 GHz W-LAN (Body-Worn at 10 mm)**

Configuration	Mode	2G/3G SAR [W/kg]	Bluetooth SAR [W/kg]	$\Sigma$ SAR [W/kg]	SPLSR [Yes/No]
Front Side	GSM 850	0.565	0.128	0.693	No
Rear Side	GSM 850	0.645	0.128	0.773	No
Front Side	GPRS 850	1.410	0.128	1.538	No
Rear Side	GPRS 850	1.572	0.128	1.700	No
Front Side	PCS 1900	0.152	0.128	0.280	No
Rear Side	PCS 1900	0.452	0.128	0.580	No
Front Side	GPRS 1900	0.232	0.128	0.360	No
Rear Side	GPRS 1900	0.674	0.128	0.802	No
Front Side	WCDMA 850	0.482	0.128	0.610	No
Rear Side	WCDMA 850	0.627	0.128	0.755	No
Front Side	WCDMA 1900	0.953	0.128	1.081	No
Rear Side	WCDMA 1900	1.535	0.128	1.663	No
Front Side	LTE Band 17	0.154	0.128	0.282	No
Rear Side	LTE Band 17	0.290	0.128	0.418	No

**Table 13.38 Simultaneous Transmission Scenario with Bluetooth (Body-Worn at 10 mm)**

Note: Bluetooth SAR was not required to be measured per FCC KDB 447498. Estimated SAR results were used in the above table to determine simultaneous transmission SAR test exclusion.



### 13.7 Hotspot SAR Simultaneous Transmission Analysis

Per FCC KDB Publication 941225 D06 v02, the device edges with antennas more than 2.5 cm from edge are not required to be evaluated for SAR ("-").

Simult TX	Configuration	GPRS	2.4G W-LAN	$\Sigma$ SAR [W/kg]	SPLSR [Yes/No]	Simult TX	Configuration	GPRS	2.4G W-LAN	$\Sigma$ SAR [W/kg]	SPLSR [Yes/No]
		850 SAR [W/kg]	(802.11b) SAR [W/kg]					1900 SAR [W/kg]	(802.11b) SAR [W/kg]		
Body SAR	Top	-	0.0769	0.0769	No	Body SAR	Top	-	0.0769	0.0769	No
	Bottom	0.181	-	0.181	No		Bottom	0.505	-	0.505	No
	Front	1.410	0.184	1.594	No		Front	0.232	0.184	0.416	No
	Rear	1.572	0.127	1.699	Yes		Rear	0.674	0.127	0.801	No
	Right	1.304	-	1.304	No		Right	0.0520	-	0.0520	No
	Left	1.238	-	1.238	No		Left	0.00918	-	0.00918	No

**Table 13.39 Simultaneous Transmission Scenario (Hotspot at 10 mm)**

Simult TX	Configuration	WCDMA	2.4G W-LAN	$\Sigma$ SAR [W/kg]	SPLSR [Yes/No]	Simult TX	Configuration	WCDMA	2.4G W-LAN	$\Sigma$ SAR [W/kg]	SPLSR [Yes/No]
		850 SAR [W/kg]	(802.11b) SAR [W/kg]					1900 SAR [W/kg]	(802.11b) SAR [W/kg]		
Body SAR	Top	-	0.0769	0.0769	No	Body SAR	Top	-	0.0769	0.0769	No
	Bottom	0.0965	-	0.0965	No		Bottom	1.494	-	<b>1.494</b>	No
	Front	0.514	0.184	0.698	No		Front	0.953	0.184	1.137	No
	Rear	0.627	0.127	0.754	No		Rear	1.535	0.127	1.663	Yes
	Right	0.316	-	0.316	No		Right	0.135	-	0.135	No
	Left	0.281	-	0.281	No		Left	0.0687	-	0.0687	No

**Table 13.40 Simultaneous Transmission Scenario (Hotspot at 10 mm)**

Simult TX	Configuration	LTE	2.4G W-LAN	$\Sigma$ SAR [W/kg]	SPLSR [Yes/No]
		Band 17 SAR [W/kg]	(802.11b) SAR [W/kg]		
Body SAR	Top	-	0.0769	0.0769	No
	Bottom	0.0484	-	0.0484	No
	Front	0.154	0.184	0.338	No
	Rear	0.290	0.127	0.417	No
	Right	0.141	-	0.141	No
	Left	0.0834	-	0.0834	No

**Table 13.41 Simultaneous Transmission Scenario (Hotspot at 10 mm)**

### 13.8 SAR to Peak Location Separation Ratio (SPLSR)

Test Position	Worst-case combination			$\Sigma$ SAR [W/kg]	Calculated distance [mm]	SPLSR [ $\leq 0.04$ ]	Volume Scan [Yes/No]	Figure
	GPRS 850	W-LAN W56 11a	W-LAN W56 11n					
Left Touch	0.943	0.819	-	1.762	66.6	0.035	No	13-2
Right Touch	0.986	0.656	-	1.642	71.2	0.030	No	13-3
Left Tilt	0.600	1.034	-	1.634	65.8	0.032	No	13-4
Right Touch	0.986	-	0.788	1.774	69.5	0.034	No	13-5
Right Tilt	0.622	-	1.151	1.773	75.6	0.031	No	13-6
Left Touch	0.943	-	0.714	1.656	65.2	0.033	No	13-7

**Table 13.42 SAR to Peak Location Separation Ratio (SPLSR)**

Figure 13-2

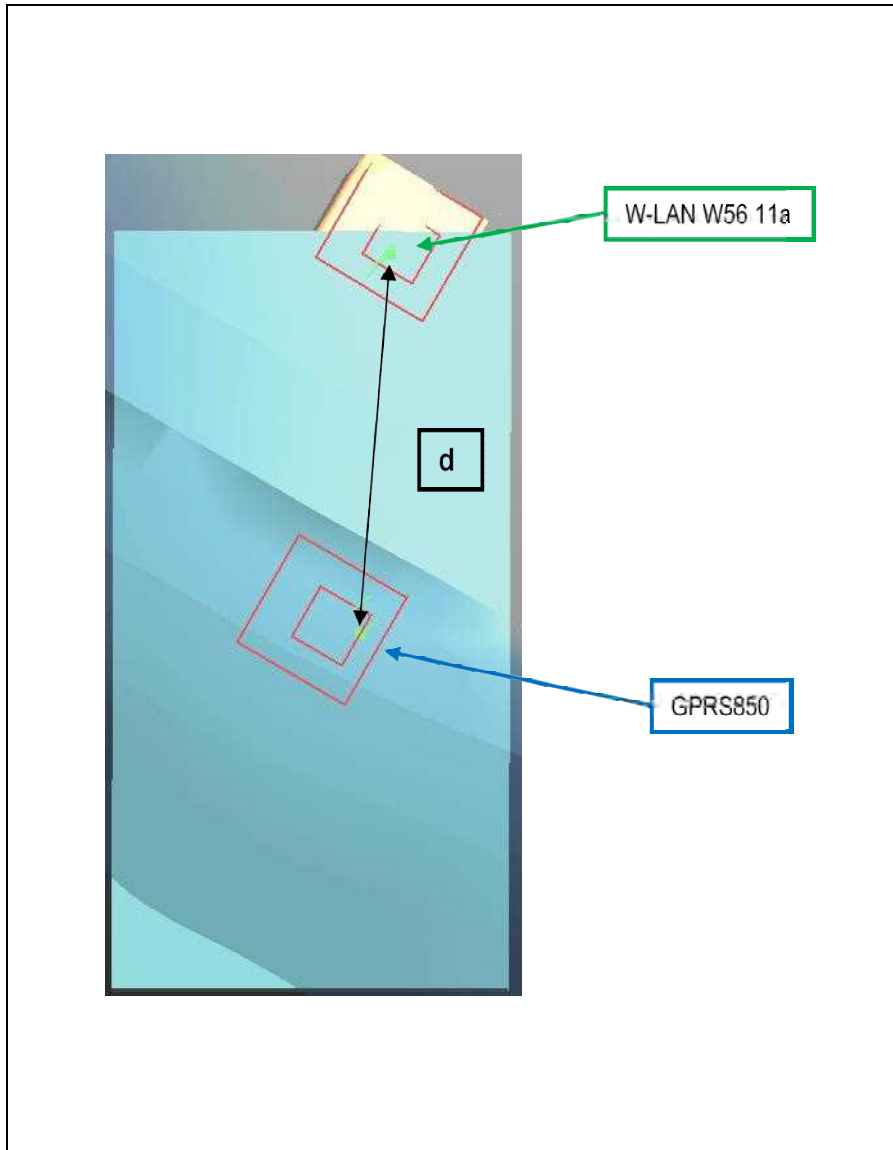

Mode	Peak SAR	X	Y	Z
	[mW/g]	m	m	m
GPRS 850	1.01	0.0615	0.274	-0.174
W-LAN W56 11a	1.63	0.00338	0.3	-0.168

d: Calculated distance(mm)	66.6
----------------------------	------

The Peak Location Separation Distance is computed by using the formula below:

$$\text{SQRT}((X1-X2)^2+(Y1-Y2)^2+(Z1-Z2)^2)$$

Figure 13-3

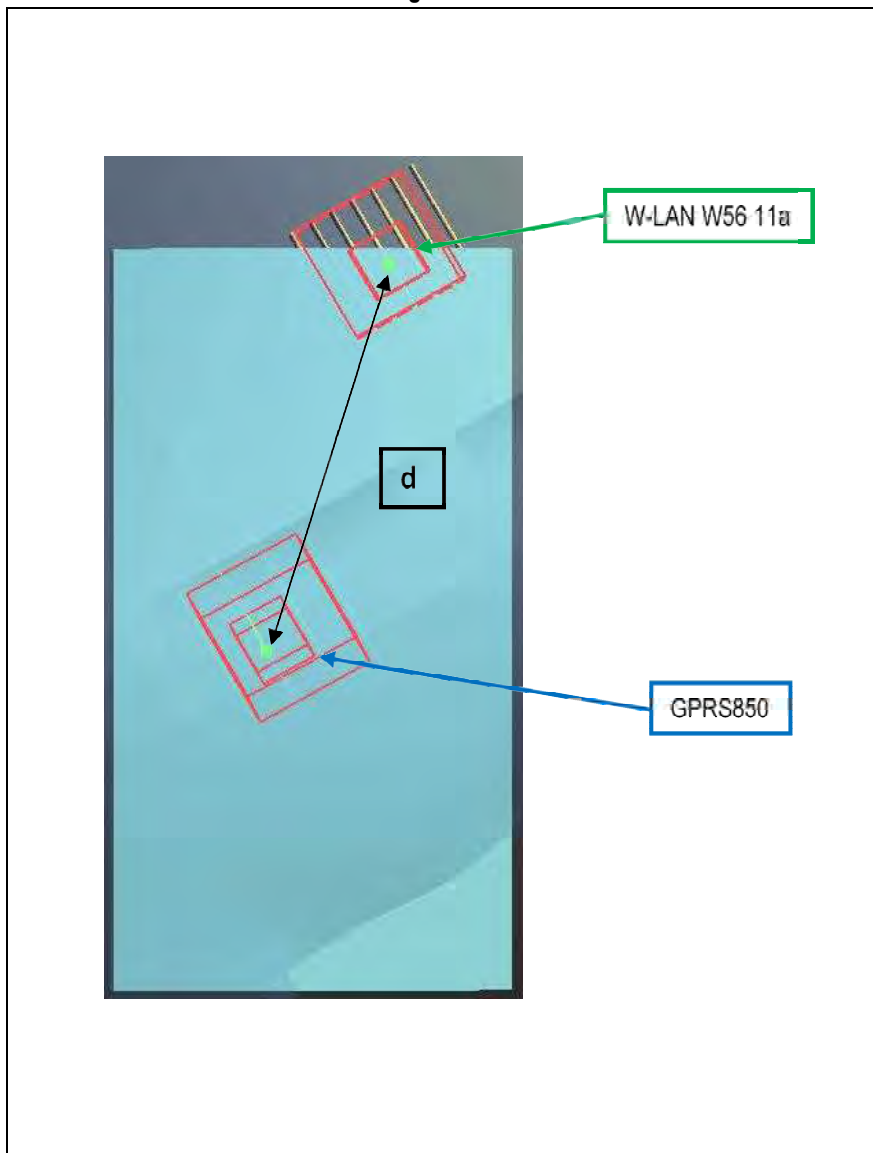

Mode	Peak SAR	X	Y	Z
	[mW/g]	m	m	m
GPRS 850	1.07	0.0674	-0.27	-0.172
W-LAN W56 11a	1.36	0.0181	-0.323	-0.17

d: Calculated distance(mm)	71.2
----------------------------	------

The Peak Location Separation Distance is computed by using the formula below:  

$$\text{SQRT}((X1-X2)^2+(Y1-Y2)^2+(Z1-Z2)^2)$$

Figure 13-4

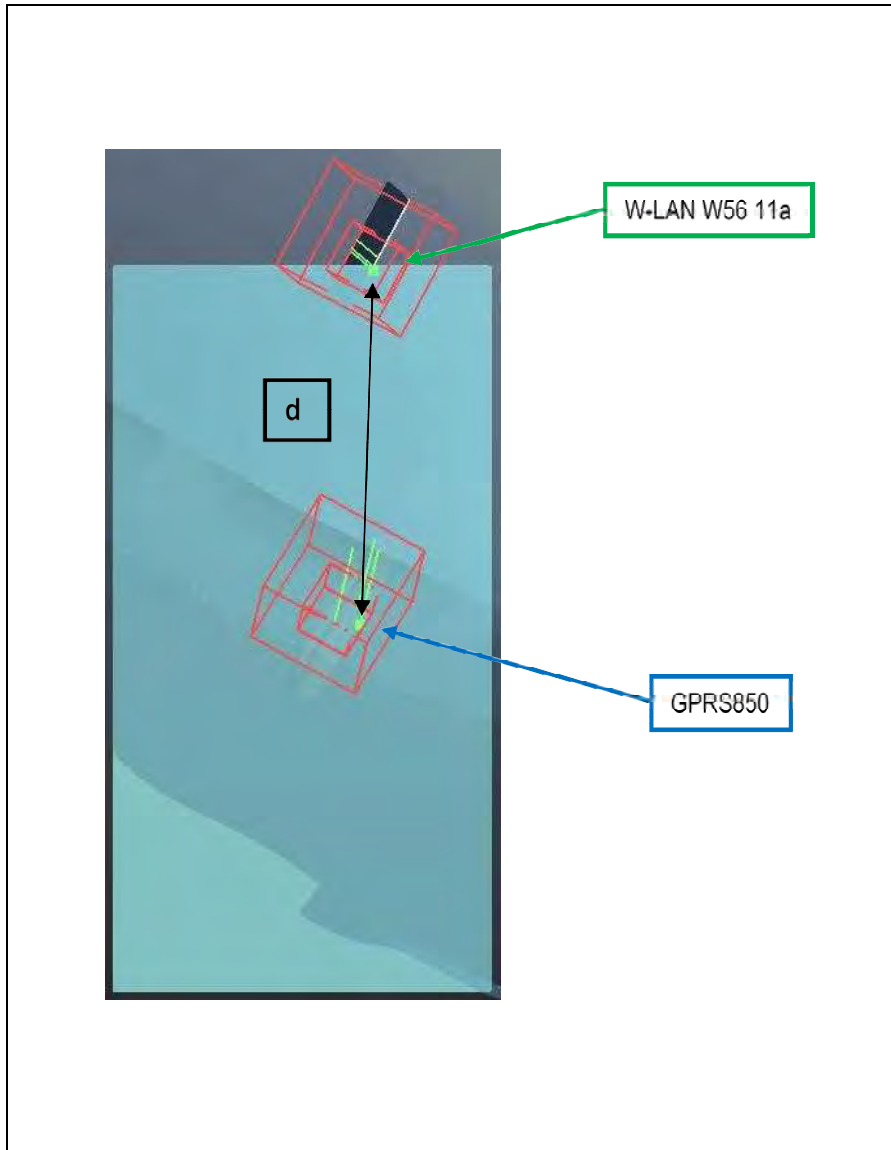

Mode	Peak SAR	X	Y	Z
	[mW/g]	m	m	m
GPRS 850	0.637	0.0486	0.294	-0.173
W-LAN W56 11a	2.13	0.00814	0.299	-0.169

d: Calculated distance(mm)	65.8
----------------------------	------

The Peak Location Separation Distance is computed by using the formula below:  
 $SQRT((X1-X2)^2+(Y1-Y2)^2+(Z1-Z2)^2)$

Figure 13-5

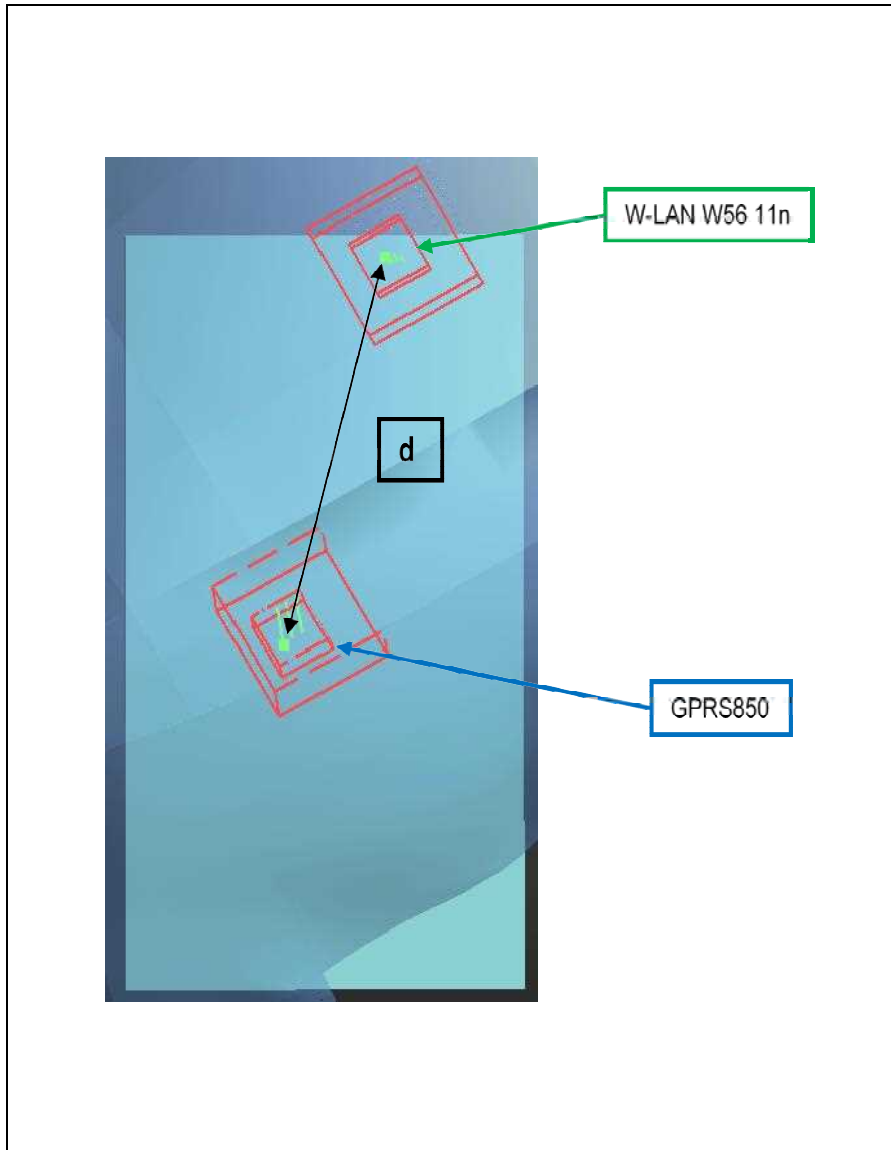

Mode	Peak SAR	X	Y	Z
	[mW/g]	m	m	m
GPRS 850	1.07	0.0674	-0.27	-0.172
W-LAN W56 11n	1.65	0.0194	-0.322	-0.17

d: Calculated distance(mm)	69.5
----------------------------	------

The Peak Location Separation Distance is computed by using the formula below:  

$$\text{SQRT}((X1-X2)^2+(Y1-Y2)^2+(Z1-Z2)^2)$$

Figure 13-6

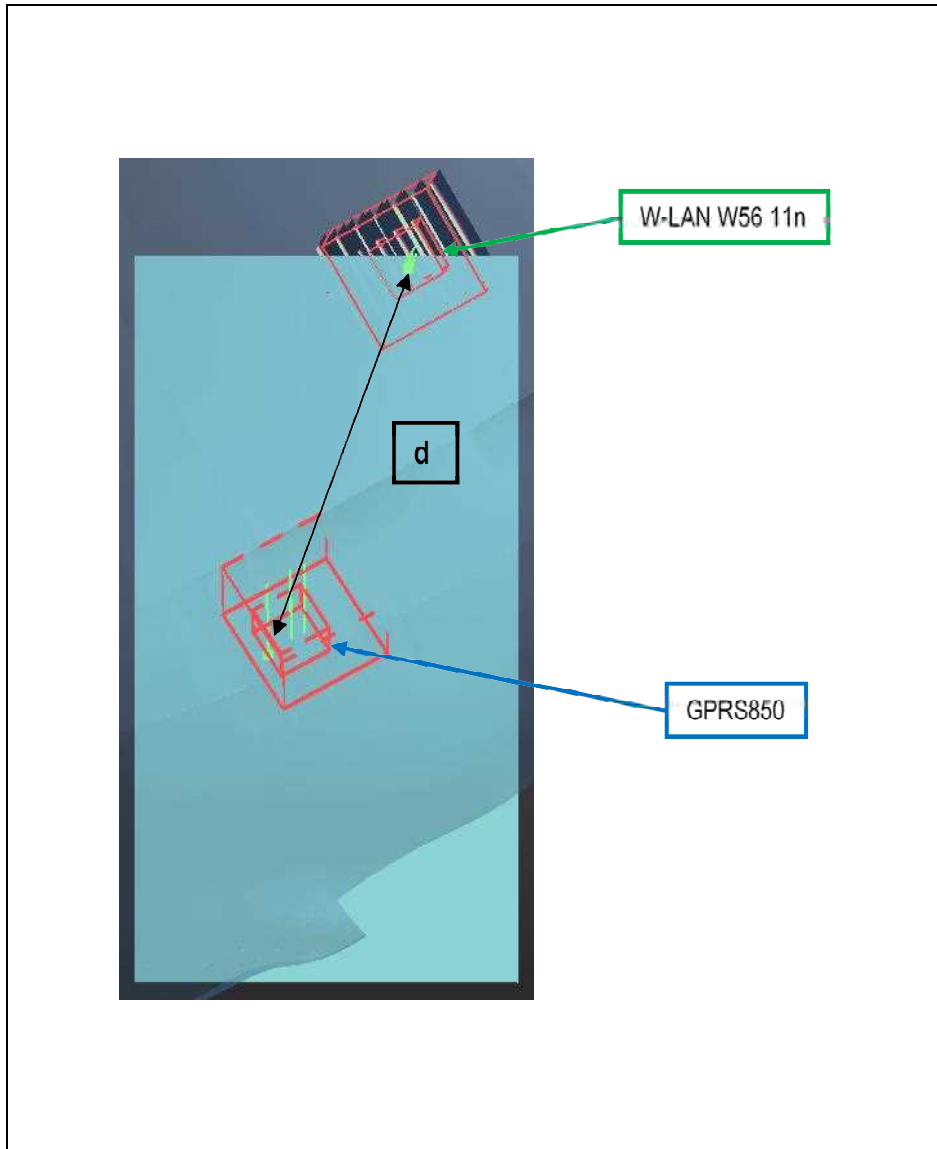

Mode	Peak SAR	X	Y	Z
	[mW/g]	m	m	m
GPRS 850	0.666	0.0477	-0.293	-0.172
W-LAN W56 11n	2.47	0.0207	-0.322	-0.17

d: Calculated distance(mm)	75.6
----------------------------	------

The Peak Location Separation Distance is computed by using the formula below:  
 $SQRT((X1-X2)^2+(Y1-Y2)^2+(Z1-Z2)^2)$

Figure 13-7

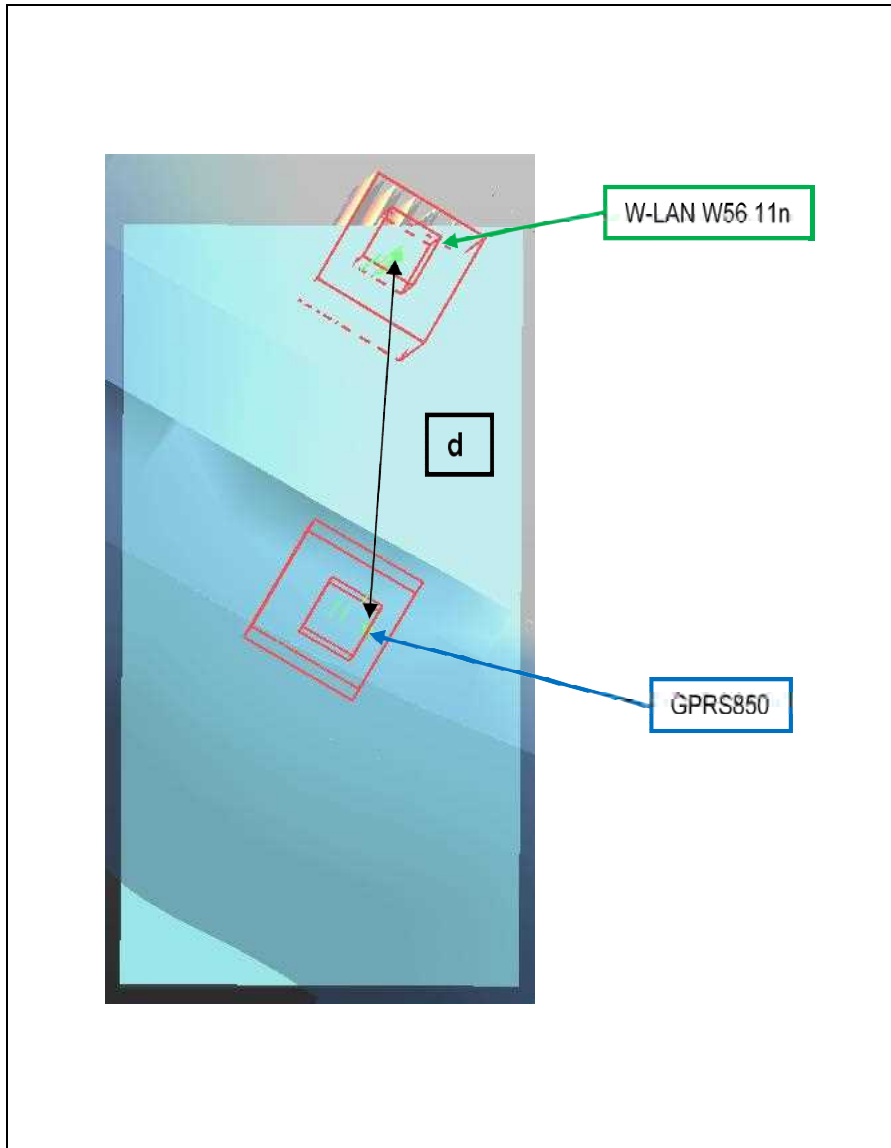

Mode	Peak SAR	X	Y	Z
	[mW/g]	m	m	m
GPRS 850	1.01	0.0615	0.274	-0.174
W-LAN W56 11n	1.4	0.00754	0.301	-0.169

d: Calculated distance(mm)	65.2
----------------------------	------

The Peak Location Separation Distance is computed by using the formula below:  

$$\text{SQRT}((X1-X2)^2+(Y1-Y2)^2+(Z1-Z2)^2)$$



Test Position	Worst-case combination					$\Sigma$ SAR [W/kg]	Calculated distance [mm]	SPLSR [ $\leq 0.04$ ]	Volume Scan [Yes/No]	Figure
	GPRS 850	W-LAN 2.4GHz	W-LAN W52 11ac	W-LAN W53 11ac	W-LAN W56 11ac					
Rear	1.572	0.127	-	-	-	1.699	66.3	0.033	No	13-8
Rear	1.572	-	0.132	-	-	1.704	79.7	0.028	No	13-9
Rear	1.572	-	-	0.118	-	1.689	78.3	0.028	No	13-10
Rear	1.572	-	-	-	0.204	1.776	77.4	0.031	No	13-11

**Table 13.43 SAR to Peak Location Separation Ratio (SPLSR)**

Figure 13-8

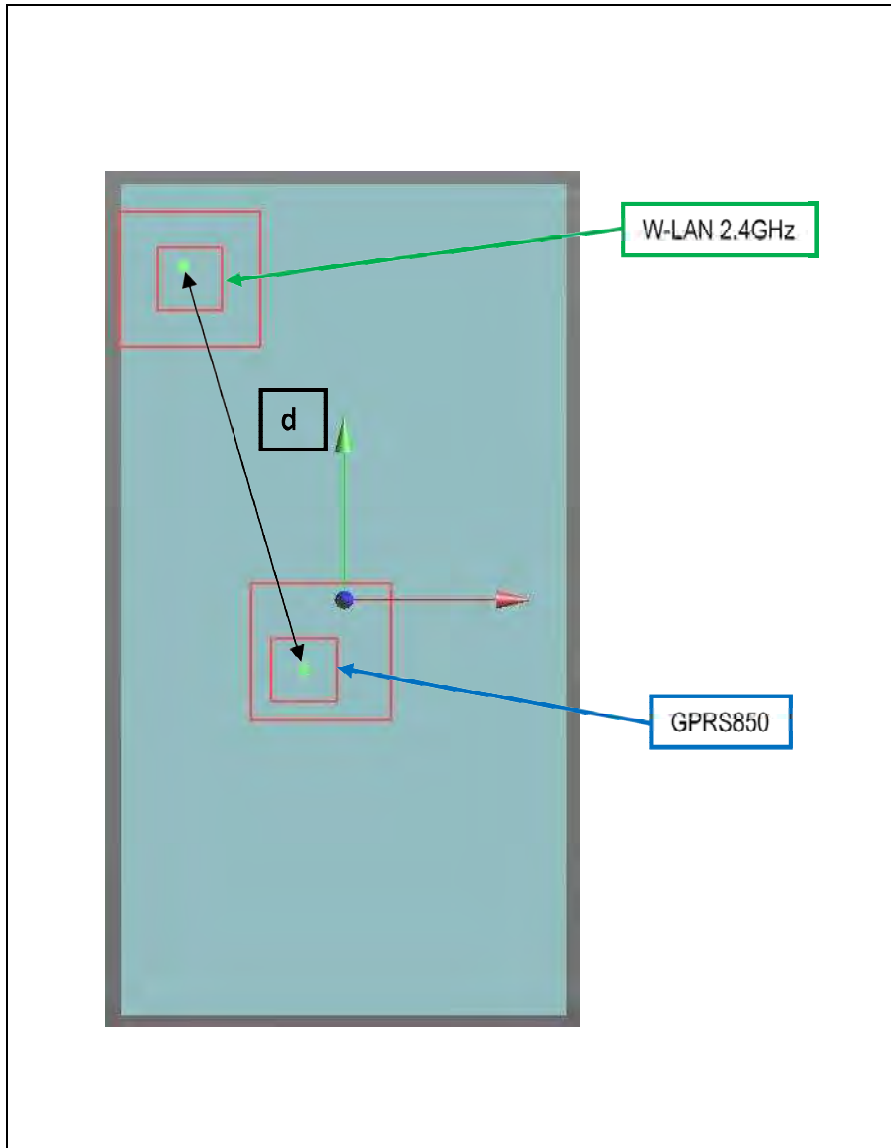

Mode	Peak SAR	X	Y	Z
	[mW/g]	m	m	m
GPRS 850	1.78	-0.006	-0.011	-0.183
W-LAN 2.4GHz	0.149	-0.0228	0.0516	-0.182

d: Calculated distance(mm)	66.3
----------------------------	------

The Peak Location Separation Distance is computed by using the formula below:  

$$\text{SQRT}((X1-X2)^2+(Y1-Y2)^2+(Z1-Z2)^2)$$

Figure 13-9

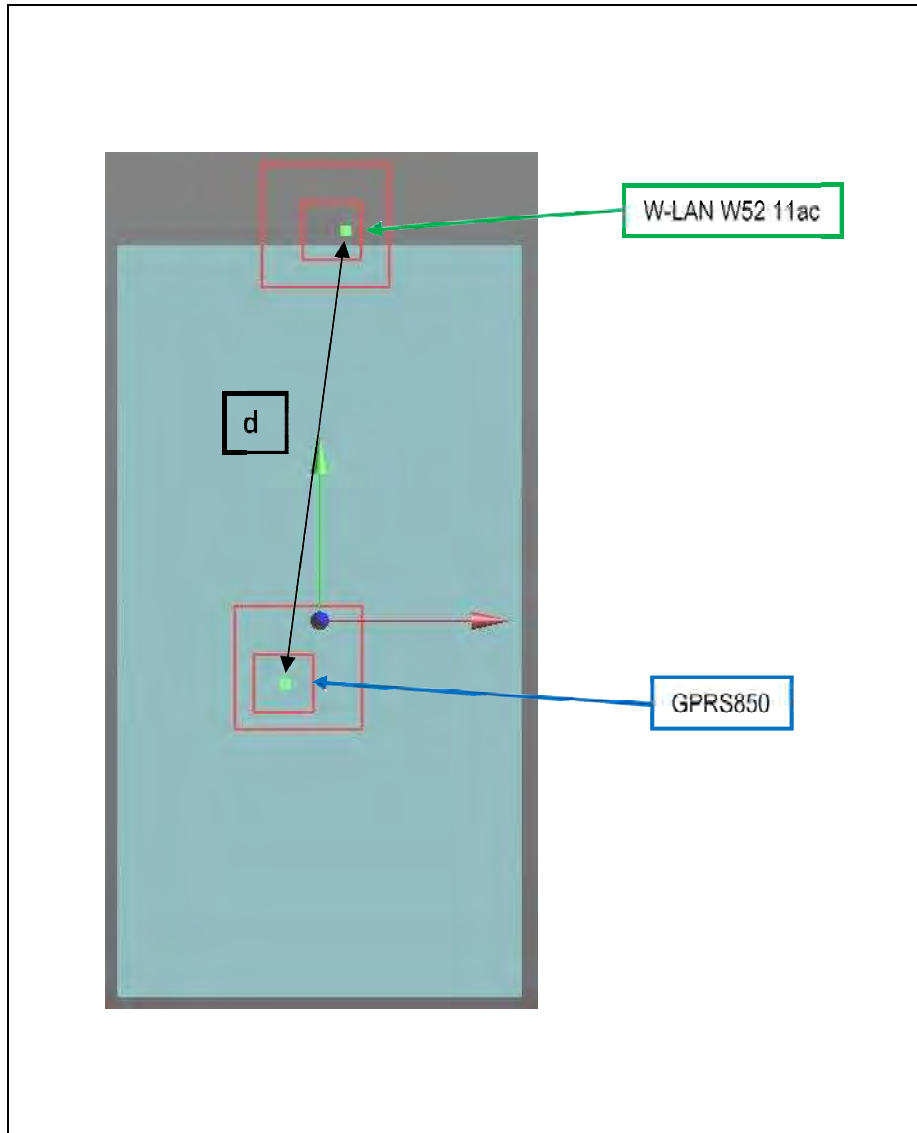

Mode	Peak SAR	X	Y	Z
	[mW/g]	m	m	m
GPRS 850	1.78	-0.006	-0.011	-0.183
W-LAN W52 11ac	0.23	0.002	0.068	-0.182

d: Calculated distance(mm)	79.7
----------------------------	------

The Peak Location Separation Distance is computed by using the formula below:

$$\text{SQRT}((X1-X2)^2+(Y1-Y2)^2+(Z1-Z2)^2)$$

Figure 13-10

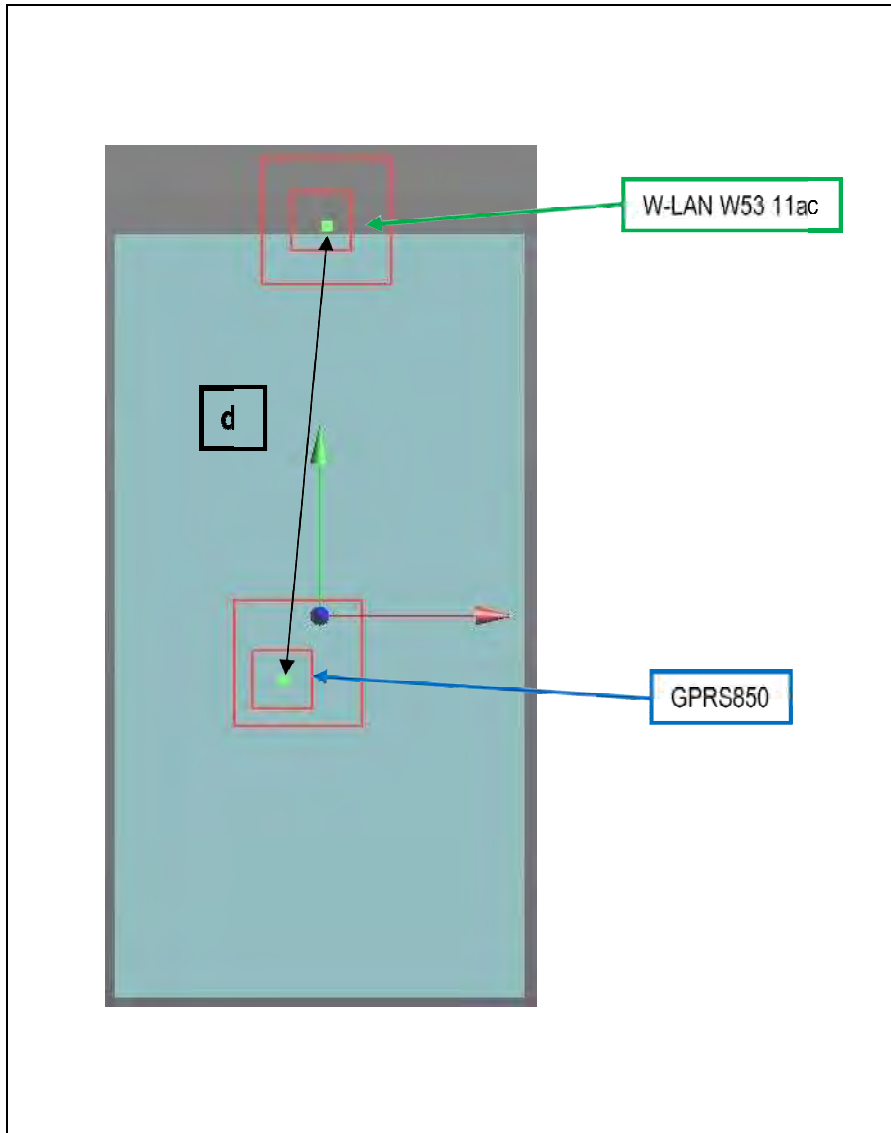

Mode	Peak SAR	X	Y	Z
	[mW/g]	m	m	m
GPRS 850	1.78	-0.006	-0.011	-0.183
W-LAN W53 11ac	0.215	0.002	0.067	-0.182

d: Calculated distance(mm)	78.3
----------------------------	------

The Peak Location Separation Distance is computed by using the formula below:

$$\text{SQRT}((X1-X2)^2+(Y1-Y2)^2+(Z1-Z2)^2)$$

Figure 13-11

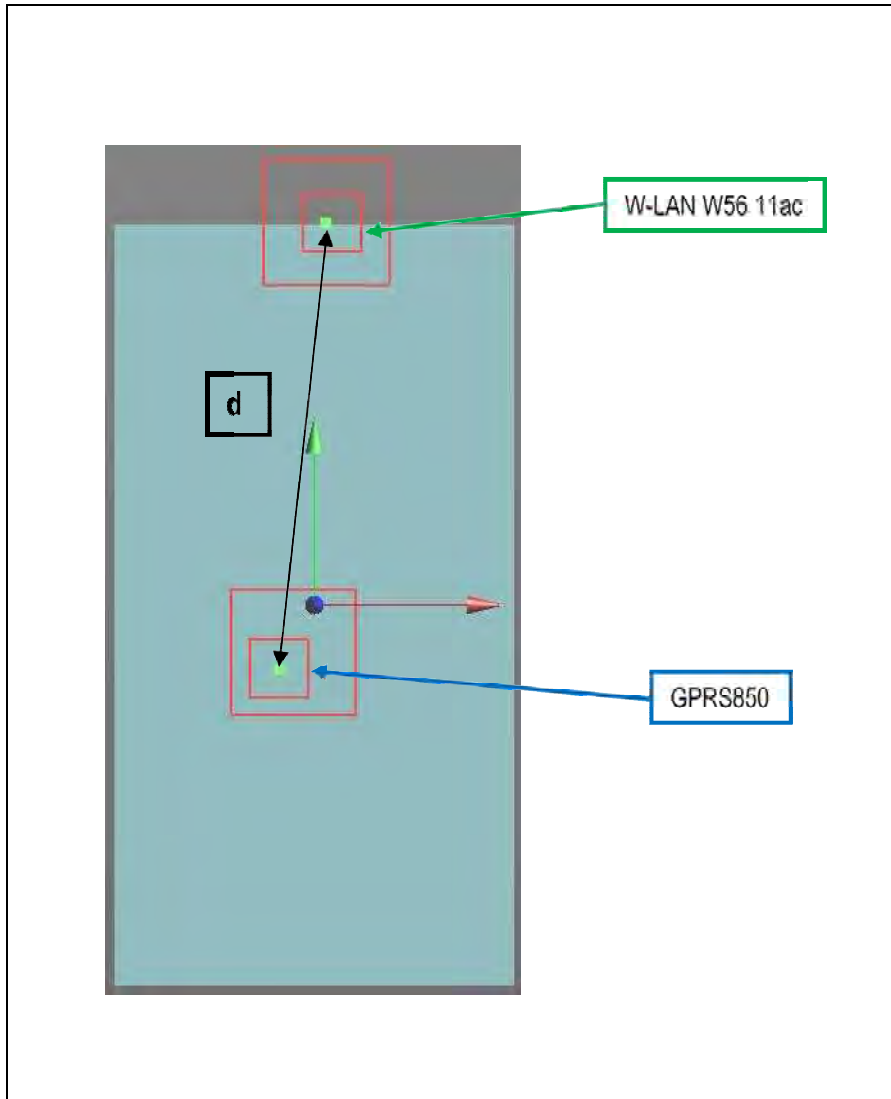

Mode	Peak SAR	X	Y	Z
	[mW/g]	m	m	m
GPRS 850	1.78	-0.006	-0.011	-0.183
W-LAN W56 11ac	0.356	0.002	0.066	-0.182

d: Calculated distance(mm)	77.4
----------------------------	------

The Peak Location Separation Distance is computed by using the formula below:

$$\text{SQRT}((X1-X2)^2+(Y1-Y2)^2+(Z1-Z2)^2)$$



Zacta

Test Position	Worst-case combination					$\Sigma$ SAR [W/kg]	Calculated distance [mm]	SPLSR [ $\leq 0.04$ ]	Volume Scan [Yes/No]	Figure
	WCDMA 1900	W-LAN 2.4GHz	W-LAN W52 11ac	W-LAN W53 11ac	W-LAN W56 11ac					
Rear	1.535	0.127	-	-	-	1.663	117.2	0.018	No	13-12
Rear	1.535	-	0.132	-	-	1.667	131.1	0.016	No	13-13
Rear	1.535	-	-	0.118	-	1.653	130.2	0.016	No	13-14
Rear	1.535	-	-	-	0.204	1.740	129.2	0.018	No	13-15

**Table 13.44 SAR to Peak Location Separation Ratio (SPLSR)**

Figure 13-12

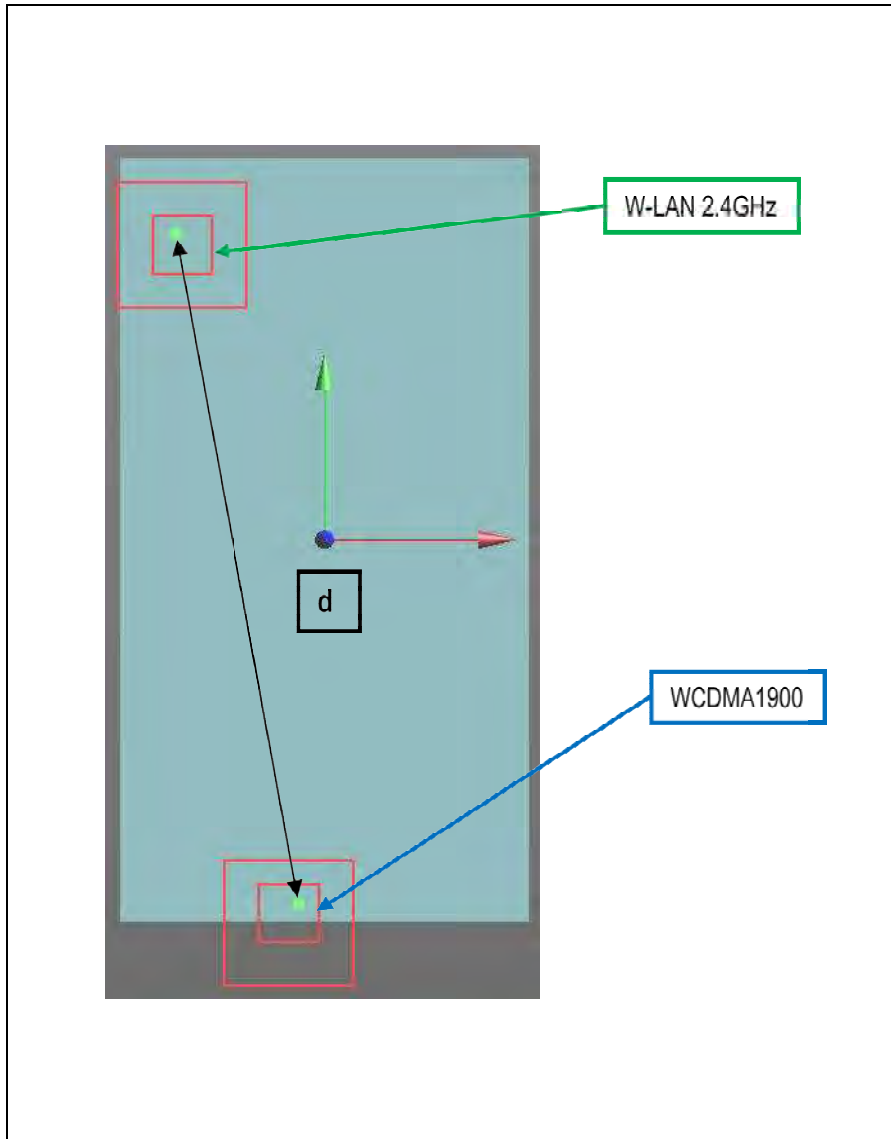

Mode	Peak SAR	X	Y	Z
	[mW/g]	m	m	m
WCDMA 1900	1.88	-0.006	-0.066	-0.182
W-LAN 2.4GHz	0.149	-0.0228	0.0516	-0.182

d: Calculated distance(mm)	117.2
----------------------------	-------

The Peak Location Separation Distance is computed by using the formula below:

$$\text{SQRT}((X1-X2)^2+(Y1-Y2)^2+(Z1-Z2)^2)$$

Figure 13-13

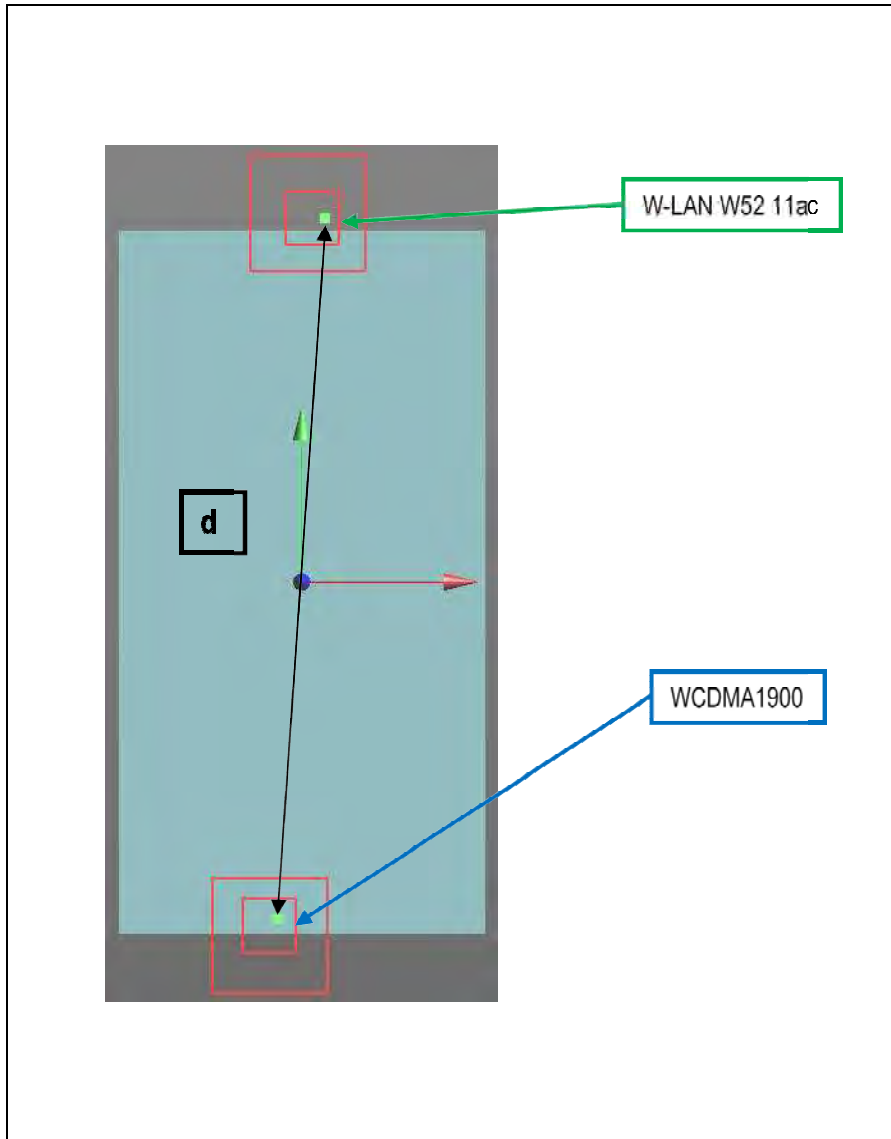

Mode	Peak SAR	X	Y	Z
	[mW/g]	m	m	m
WCDMA 1900	1.88	-0.006	-0.066	-0.182
W-LAN W52 11ac	0.23	0.002	0.068	-0.182

d: Calculated distance(mm)	131.1
----------------------------	-------

The Peak Location Separation Distance is computed by using the formula below:

$$\text{SQRT}((X1-X2)^2+(Y1-Y2)^2+(Z1-Z2)^2)$$



Figure 13-14

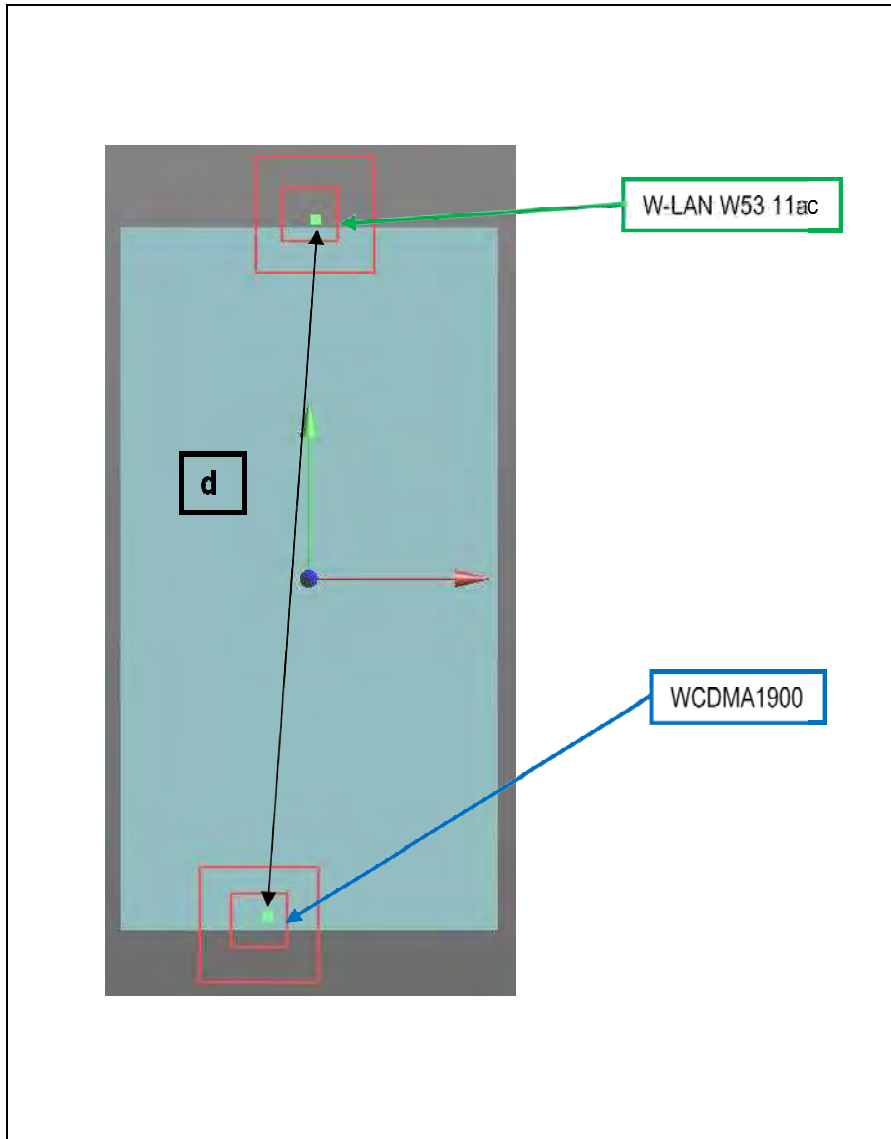

Mode	Peak SAR	X	Y	Z
	[mW/g]	m	m	m
WCDMA 1900	1.88	-0.006	-0.066	-0.182
W-LAN W53 11ac	0.215	0.002	0.067	-0.182

d: Calculated distance(mm)	130.2
----------------------------	-------

The Peak Location Separation Distance is computed by using the formula below:

$$\text{SQRT}((X1-X2)^2+(Y1-Y2)^2+(Z1-Z2)^2)$$

Figure 13-15

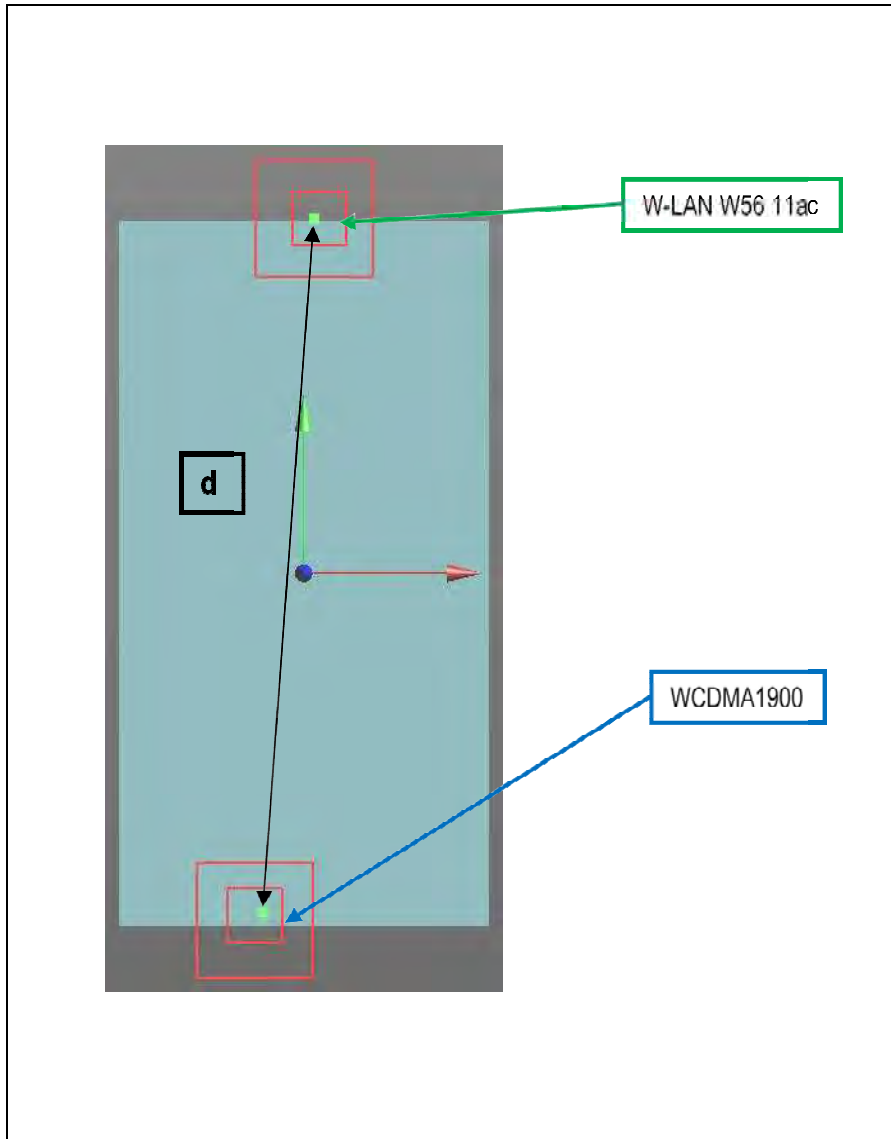

Mode	Peak SAR	X	Y	Z
	[mW/g]	m	m	m
WCDMA 1900	1.88	-0.006	-0.066	-0.182
W-LAN W56 11ac	0.356	0.002	0.066	-0.182

d: Calculated distance(mm)	129.2
----------------------------	-------

The Peak Location Separation Distance is computed by using the formula below:

$$\text{SQRT}((X1-X2)^2+(Y1-Y2)^2+(Z1-Z2)^2)$$

### 13.9 Simultaneous Transmission Conclusion

Simultaneous transmission SAR measurement (Volume Scan) is not required because the either sum of the 1-g SAR is < 1.6 W/kg or the SPLSR is < 0.04 for all circumstances that require SPLSR calculation.

### **Description of Volume Scan:**

In order to determine the EM field distribution in a three-dimensional spatial extension, volume scans are required. In free space, these assessments can help to gain more information on the performance of the DUT (e.g., to determine the degree of symmetry of the field radiated from a horn antenna).

For dosimetric application, it is necessary to assess the peak spatial SAR value averaged over a volume. For this purpose, fine resolution volume scans need to be performed at the peak SAR location(s) determined during the Area Scan. In DASY5 software these scans are called Zoom Scan jobs. The default Zoom Scan measures 7 x 7 x 7 points with a step size of 5 mm. Faster evaluations can be achieved with a reduced number of measurement points. For example, a Zoom Scan with a grid step size in x- and y-directions of 7.5 mm (5 x 5 x 7 cube configuration) reduces the measurement time to almost half with only 1-2% difference in SAR reading compared to the fine-resolution 7 x 7 x 7 scan.

For SAR evaluations with larger spatial extensions (e.g., within a complete phantom head section) a Volume Scan job should be used.

The Volume Scan job is compatible with DASY5 SAR, PRO and NEO system levels. Volume Scans are used to assess peak SAR and averaged SAR measurement in largely extended 3-dimensional volumes within any phantom. This measurement does not need any previous area scan. The grid can be anchored to a user specific point or to the current probe location. With an Administrator access mode, the grid can be optionally graded in Z-direction, whereby the smallest grid step and the grading ratio can be defined. Chosen grading ratio is automatically adjusted so that the desired extent in Z-direction is fully covered.

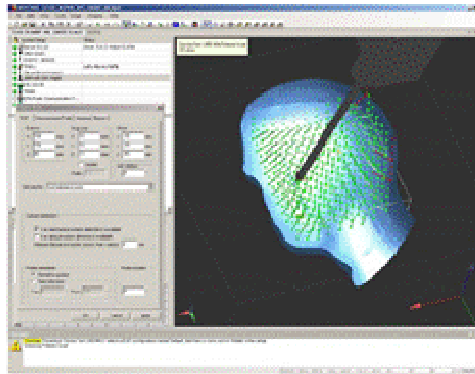

Under the Report page, the quantity to be evaluated for an instant report may be selected.

## SAR Assessment:

### Alternative 1

- Evaluation Method
  - Maximum summed SAR Value
- Description
  - Easiest and most conservative method to determine the upper limit of multi-band SAR
- Example
  - F1's SAR Value is 0.9
  - F2's SAR Value is 1.3
  - Multi-band SAR Value is  $0.9 + 1.3 = 2.2$

### Alternative 2

- Evaluation Method
  - Selection of highest assessed maximum SAR Value
- Description
  - Accurate estimate of the multi-band SAR
- Example
  - F1's SAR Value is 0.9
  - F2's SAR Value is 1.3
  - Multi-band SAR Value is 1.3

### Alternative 3

- Evaluation Method
  - Combining existing Area and Zoom Scan results by Post-Processor
- Description
  - Rapid way of obtaining the multi-band SAR. It is always applicable.
- Example
  - F1's SAR Value is 0.9
  - F2's SAR Value is 1.3
  - Combining results by Post-Processor

### Alternative 4

- Evaluation Method
  - Combining existing Area and Zoom Scan results by Post-Processor
- Description
  - The most accurate way of assessing the multi-band SAR and always
- Example
  - F1's SAR Value is 0.9
  - F2's SAR Value is 1.3
  - Combining results by Post-Processor



## 14. SAR Measurement Variability

### 14.1 Measurement Variability

Per FCC KDB Publication 865664 D01v01r03, SAR measurement variability was assessed for each frequency band, which was determined by the SAR probe calibration point and tissue-equivalent medium used for the device measurements. When both head and body tissue-equivalent media were required for SAR measurements in a frequency band, the variability measurement procedures were applied to the tissue medium with the highest measured SAR, using the highest measured SAR configuration for that tissue-equivalent medium.

These additional measurements were repeated after the completion of all measurements requiring the same head or body tissue-equivalent medium in a frequency band. The test device was returned to ambient conditions (normal room temperature) with the battery fully charged before it was re-mounted on the device holder for the repeated measurement(s) to minimize any unexpected variations in the repeated results.

SAR Measurement Variability was assessed using the following procedures for each frequency band:

1. When the original highest measured SAR is  $\geq 0.80$  W/kg, the measurement was repeated once.
2. A second repeated measurement was performed only if the ratio of largest to smallest SAR for the original and first repeated measurements was  $> 1.20$  or when the original or repeated measurement was  $\geq 1.45$  W/kg ( $\sim 10\%$  from the 1-g SAR limit).
3. A third repeated measurement was performed only if the original, first or second repeated measurement was  $\geq 1.5$  W/kg and the ratio of largest to smallest SAR for the original, first and second repeated measurements is  $> 1.20$ .
4. Repeated measurements are not required when the original highest measured SAR is  $< 0.80$  W/kg.

Table 14.1 SAR Measurement Variability Results

Frequency		Mode	Service	# of Time Slots	Spacing [Side]	Measured SAR(1g)	1st Repeated SAR(1g)	Ratio	2nd Repeated SAR(1g)	Ratio	3rd Repeated SAR(1g)	Ratio
MHz	Ch					[W/kg]	[W/kg]		[W/kg]		[W/kg]	
836.6	190	GSM850	GPRS	4	Right Touch	0.922	0.911	1.01	N/A	N/A	N/A	N/A
5700.0	140	802.11a	OFDM	N/A	Left Tilt	1.02	0.976	1.05	N/A	N/A	N/A	N/A
5700.0	140	802.11n	OFDM	N/A	Right Tilt	1.14	1.05	1.09	N/A	N/A	N/A	N/A
824.2	128	GSM850	GPRS	4	10 mm [Rear]	1.46	1.43	1.02	1.44	1.01	N/A	N/A
1880.0	9400	WCDMA1900	RMC	N/A	10 mm [Rear]	1.41	1.41	1.00	N/A	N/A	N/A	N/A
ANSI / IEEE C95.1-2005 - SAFETY LIMIT							Head, Body					
Spatial Peak							1.6 W/kg(mW/g)					
Uncontrolled Exposure/General population Exposure							averaged over 1 gram					

### 14.2 Measurement Uncertainty

The measured SAR was  $< 1.5$  W/kg for all frequency bands. Therefore, per KDB Publication 865664D01v01r03, the standard measurement uncertainty analysis per IEEE 1528-2003 was not required.

## 15. IEEE P1528 - Measurement uncertainties

Expanded uncertainties stated are calculated with a coverage Factor  $k=2$ .

Please note that these results are not taken into account when determining compliance or non-compliance with test result.

### 750MHz Head

Error Description	Uncertainty Value ± %	Probability distribution	Divisor	ci (1g)	Standard uncertainty ±%,(1g)	vi or veff
<b>Measurement System</b>						
Probe Calibration	± 6.0	N	1	1	± 6.0	∞
Axial Isotropy	± 4.7	R	$\sqrt{3}$	0.7	± 1.9	∞
Hemispherical Isotropy	± 9.6	R	$\sqrt{3}$	0.7	± 3.9	∞
Boundary Effect	± 1.0	R	$\sqrt{3}$	1	± 0.6	∞
Linearity	± 4.7	R	$\sqrt{3}$	1	± 2.7	∞
System Detection Limits	± 1.0	R	$\sqrt{3}$	1	± 0.6	∞
Readout Electronics	± 0.3	N	1	1	± 0.3	∞
Response Time	± 0.8	R	$\sqrt{3}$	1	± 0.5	∞
Integration Time	± 2.6	R	$\sqrt{3}$	1	± 1.5	∞
RF Ambient Noise	± 3.0	R	$\sqrt{3}$	1	± 1.7	∞
RF Ambient Reflections	± 3.0	R	$\sqrt{3}$	1	± 1.7	∞
Probe Positioner	± 0.4	R	$\sqrt{3}$	1	± 0.2	∞
Probe Positioning	± 2.9	R	$\sqrt{3}$	1	± 1.7	∞
Max. SAR Eval.	± 1.0	R	$\sqrt{3}$	1	± 0.6	∞
<b>Test sample related</b>						
Device Positioning	± 2.9	N	1	1	± 2.9	145
Device Holder	± 3.6	N	1	1	± 3.6	5
Power Drift	± 5.0	R	$\sqrt{3}$	1	± 2.9	∞
<b>Phantom and set-up</b>						
Phantom Uncertainty	± 4.0	R	$\sqrt{3}$	1	± 2.3	∞
Liquid conductivity (target)	± 5.0	R	$\sqrt{3}$	0.64	± 1.8	∞
Liquid conductivity (meas.)	± 0.2	R	1	0.64	± 0.1	∞
Liquid permittivity (target)	± 5.0	R	$\sqrt{3}$	0.6	± 1.7	∞
Liquid permittivity (meas.)	± 4.0	R	1	0.6	± 2.4	∞
Combined Std. Uncertainty					± 11.6	387
<b>Expanded uncertainty (95% confidence interval)</b>					<b>± 23.2</b>	

**750MHz Body**

Error Description	Uncertainty Value ± %	Probability distribution	Divisor	ci (1g)	Standard uncertainty ±%,(1g)	vi or v <sub>eff</sub>
<b>Measurement System</b>						
Probe Calibration	± 6.0	N	1	1	± 6.0	∞
Axial Isotropy	± 4.7	R	$\sqrt{3}$	0.7	± 1.9	∞
Hemispherical Isotropy	± 9.6	R	$\sqrt{3}$	0.7	± 3.9	∞
Boundary Effect	± 1.0	R	$\sqrt{3}$	1	± 0.6	∞
Linearity	± 4.7	R	$\sqrt{3}$	1	± 2.7	∞
System Detection Limits	± 1.0	R	$\sqrt{3}$	1	± 0.6	∞
Readout Electronics	± 0.3	N	1	1	± 0.3	∞
Response Time	± 0.8	R	$\sqrt{3}$	1	± 0.5	∞
Integration Time	± 2.6	R	$\sqrt{3}$	1	± 1.5	∞
RF Ambient Noise	± 3.0	R	$\sqrt{3}$	1	± 1.7	∞
RF Ambient Reflections	± 3.0	R	$\sqrt{3}$	1	± 1.7	∞
Probe Positioner	± 0.4	R	$\sqrt{3}$	1	± 0.2	∞
Probe Positioning	± 2.9	R	$\sqrt{3}$	1	± 1.7	∞
Max. SAR Eval.	± 1.0	R	$\sqrt{3}$	1	± 0.6	∞
<b>Test sample related</b>						
Device Positioning	± 2.9	N	1	1	± 2.9	145
Device Holder	± 3.6	N	1	1	± 3.6	5
Power Drift	± 5.0	R	$\sqrt{3}$	1	± 2.9	∞
<b>Phantom and set-up</b>						
Phantom Uncertainty	± 4.0	R	$\sqrt{3}$	1	± 2.3	∞
Liquid conductivity (target)	± 5.0	R	$\sqrt{3}$	0.64	± 1.8	∞
Liquid conductivity (meas.)	± 1.7	R	1	0.64	± 1.1	∞
Liquid permittivity (target)	± 5.0	R	$\sqrt{3}$	0.6	± 1.7	∞
Liquid permittivity (meas.)	± 1.9	R	1	0.6	± 1.1	∞
Combined Std. Uncertainty					± 11.3	387
<b>Expanded uncertainty (95% confidence interval)</b>					<b>± 22.6</b>	

**835MHz Head**

Error Description	Uncertainty Value ± %	Probability distribution	Divisor	ci (1g)	Standard uncertainty ±%,(1g)	vi or veff
<b>Measurement System</b>						
Probe Calibration	± 6.0	N	1	1	± 6.0	∞
Axial Isotropy	± 4.7	R	$\sqrt{3}$	0.7	± 1.9	∞
Hemispherical Isotropy	± 9.6	R	$\sqrt{3}$	0.7	± 3.9	∞
Boundary Effect	± 1.0	R	$\sqrt{3}$	1	± 0.6	∞
Linearity	± 4.7	R	$\sqrt{3}$	1	± 2.7	∞
System Detection Limits	± 1.0	R	$\sqrt{3}$	1	± 0.6	∞
Readout Electronics	± 0.3	N	1	1	± 0.3	∞
Response Time	± 0.8	R	$\sqrt{3}$	1	± 0.5	∞
Integration Time	± 2.6	R	$\sqrt{3}$	1	± 1.5	∞
RF Ambient Noise	± 3.0	R	$\sqrt{3}$	1	± 1.7	∞
RF Ambient Reflections	± 3.0	R	$\sqrt{3}$	1	± 1.7	∞
Probe Positioner	± 0.4	R	$\sqrt{3}$	1	± 0.2	∞
Probe Positioning	± 2.9	R	$\sqrt{3}$	1	± 1.7	∞
Max. SAR Eval.	± 1.0	R	$\sqrt{3}$	1	± 0.6	∞
<b>Test sample related</b>						
Device Positioning	± 2.9	N	1	1	± 2.9	145
Device Holder	± 3.6	N	1	1	± 3.6	5
Power Drift	± 5.0	R	$\sqrt{3}$	1	± 2.9	∞
<b>Phantom and set-up</b>						
Phantom Uncertainty	± 4.0	R	$\sqrt{3}$	1	± 2.3	∞
Liquid conductivity (target)	± 5.0	R	$\sqrt{3}$	0.64	± 1.8	∞
Liquid conductivity (meas.)	± 0.7	R	1	0.64	± 0.4	∞
Liquid permittivity (target)	± 5.0	R	$\sqrt{3}$	0.6	± 1.7	∞
Liquid permittivity (meas.)	± 0.2	R	1	0.6	± 0.1	∞
Combined Std. Uncertainty					± 10.8	387
<b>Expanded uncertainty (95% confidence interval)</b>					<b>± 21.6</b>	



**835MHz Body**

Error Description	Uncertainty Value ± %	Probability distribution	Divisor	ci (1g)	Standard uncertainty ±%,(1g)	vi or v <sub>eff</sub>
<b>Measurement System</b>						
Probe Calibration	± 6.0	N	1	1	± 6.0	∞
Axial Isotropy	± 4.7	R	$\sqrt{3}$	0.7	± 1.9	∞
Hemispherical Isotropy	± 9.6	R	$\sqrt{3}$	0.7	± 3.9	∞
Boundary Effect	± 1.0	R	$\sqrt{3}$	1	± 0.6	∞
Linearity	± 4.7	R	$\sqrt{3}$	1	± 2.7	∞
System Detection Limits	± 1.0	R	$\sqrt{3}$	1	± 0.6	∞
Readout Electronics	± 0.3	N	1	1	± 0.3	∞
Response Time	± 0.8	R	$\sqrt{3}$	1	± 0.5	∞
Integration Time	± 2.6	R	$\sqrt{3}$	1	± 1.5	∞
RF Ambient Noise	± 3.0	R	$\sqrt{3}$	1	± 1.7	∞
RF Ambient Reflections	± 3.0	R	$\sqrt{3}$	1	± 1.7	∞
Probe Positioner	± 0.4	R	$\sqrt{3}$	1	± 0.2	∞
Probe Positioning	± 2.9	R	$\sqrt{3}$	1	± 1.7	∞
Max. SAR Eval.	± 1.0	R	$\sqrt{3}$	1	± 0.6	∞
<b>Test sample related</b>						
Device Positioning	± 2.9	N	1	1	± 2.9	145
Device Holder	± 3.6	N	1	1	± 3.6	5
Power Drift	± 5.0	R	$\sqrt{3}$	1	± 2.9	∞
<b>Phantom and set-up</b>						
Phantom Uncertainty	± 4.0	R	$\sqrt{3}$	1	± 2.3	∞
Liquid conductivity (target)	± 5.0	R	$\sqrt{3}$	0.64	± 1.8	∞
Liquid conductivity (meas.)	± 3.1	R	1	0.64	± 2.0	∞
Liquid permittivity (target)	± 5.0	R	$\sqrt{3}$	0.6	± 1.7	∞
Liquid permittivity (meas.)	± 1.3	R	1	0.6	± 0.8	∞
Combined Std. Uncertainty					± 11.9	387
<b>Expanded uncertainty (95% confidence interval)</b>					<b>± 23.8</b>	

**1900MHz Head**

Error Description	Uncertainty Value ± %	Probability distribution	Divisor	ci (1g)	Standard uncertainty ±%,(1g)	vi or veff
<b>Measurement System</b>						
Probe Calibration	± 6.0	N	1	1	± 6.0	∞
Axial Isotropy	± 4.7	R	$\sqrt{3}$	0.7	± 1.9	∞
Hemispherical Isotropy	± 9.6	R	$\sqrt{3}$	0.7	± 3.9	∞
Boundary Effect	± 1.0	R	$\sqrt{3}$	1	± 0.6	∞
Linearity	± 4.7	R	$\sqrt{3}$	1	± 2.7	∞
System Detection Limits	± 1.0	R	$\sqrt{3}$	1	± 0.6	∞
Readout Electronics	± 0.3	N	1	1	± 0.3	∞
Response Time	± 0.8	R	$\sqrt{3}$	1	± 0.5	∞
Integration Time	± 2.6	R	$\sqrt{3}$	1	± 1.5	∞
RF Ambient Noise	± 3.0	R	$\sqrt{3}$	1	± 1.7	∞
RF Ambient Reflections	± 3.0	R	$\sqrt{3}$	1	± 1.7	∞
Probe Positioner	± 0.4	R	$\sqrt{3}$	1	± 0.2	∞
Probe Positioning	± 2.9	R	$\sqrt{3}$	1	± 1.7	∞
Max. SAR Eval.	± 1.0	R	$\sqrt{3}$	1	± 0.6	∞
<b>Test sample related</b>						
Device Positioning	± 2.9	N	1	1	± 2.9	145
Device Holder	± 3.6	N	1	1	± 3.6	5
Power Drift	± 5.0	R	$\sqrt{3}$	1	± 2.9	∞
<b>Phantom and set-up</b>						
Phantom Uncertainty	± 4.0	R	$\sqrt{3}$	1	± 2.3	∞
Liquid conductivity (target)	± 5.0	R	$\sqrt{3}$	0.64	± 1.8	∞
Liquid conductivity (meas.)	± 0.4	R	1	0.64	± 0.3	∞
Liquid permittivity (target)	± 5.0	R	$\sqrt{3}$	0.6	± 1.7	∞
Liquid permittivity (meas.)	± 1.8	R	1	0.6	± 1.1	∞
Combined Std. Uncertainty					± 10.5	387
<b>Expanded uncertainty (95% confidence interval)</b>					<b>± 21.0</b>	